

THE LIFEBOAT

THE YEAR OF THE LIFEBOAT



Brooke Marine Limited

SHIPBUILDERS · ENGINEERS AND CONSULTING NAVAL ARCHITECTS

ESTABLISHED 1874



THAMES CLASS 50-001

Type 50 ft Self-Righting
Length overall 50' 0"
Beam 14' 6"
Displacement 23.5 tons
Fuel Capacity 400 imp. gallons
Twin General Motors 8V-71
Total Power 780 SHP
Maximum Speed about 17 knots
Range at 17 knots - over 200 miles

Electronic Equipment Comprises:
Kelvin Hughes Type 17W Radar
Kelvin Hughes Falkland M.F. R.T.
Decca Navigator Mk 21
Pye Westminster VHF
Radio transmitter and receiver
Ferrograph Echo Sounder
Easco Intercom 5-station Unit



A DOWSETT COMPANY

Shipyards : Lowestoft · Suffolk · England

TELEPHONE : LOWESTOFT 5221 TELEGRAMS : 'BROOKCRAFT' LOWESTOFT TELEX 97145

THE LIFEBOAT

Autumn 1974

Contents

Volume XLIII
Number 449

Chairman:

COMMANDER F. R. H. SWANN, CBE, RNVR

Director and Secretary:

CAPTAIN NIGEL DIXON, RN

Editor:

PATRICK HOWARTH

Assistant Editor:

JOAN DAVIES

Notes of the Quarter by the Editor	199
<i>Burtonia</i> ; Largest Lifeboat Flotilla; Bristol and Ship Owners; Onedin Line; Support from Sport	
Annual General Meeting	201
Naming Ceremonies	206
Guernsey; Sennen Cove; Eyemouth; Sheerness; Hoylake; Stornoway	
International Lifeboat Exhibition	208
Lifeboat Services	213
Some Ways of Raising Money	219
150th Anniversary Commemorative Items	221
Book Reviews	222
Ship Halfpennies	222
Shoreline	223
Letters	224
Central Appeals Committee	227
Lifeboat Launches on Service	229
Inshore Lifeboat Launches on Service	330
Index to Advertisers	232

COVER PICTURE

Dunbar inshore lifeboat returns to harbour after giving display on lifeboat day, July 20. She is a 16' D class inflatable lifeboat built by RFD. Inner tubes fitted within the buoyancy tubes markedly improve air-holding over long periods and reduce maintenance work. The photograph was taken by Allan S. Campbell.

All editorial material submitted for consideration with a view to publication in the journal should be addressed to the Editor, THE LIFEBOAT, Royal National Life-Boat Institution, West Quay Road, Poole, Dorset, BH15 1HZ (Telephone Poole 71133). Photographs intended for return should be accompanied by a stamped and addressed envelope.

All advertising enquiries should be addressed to Dyson Advertising Services, PO Box 9, Godalming, Surrey (Telephone Godalming (04868) 23675).

Shoreline Organising Secretary: G. R. (Bob) Walton, 29a Castle Street, Salisbury, Wiltshire (Telephone Salisbury 6966).

A year's subscription of four issues costs 88p, including postage, but those who are entitled to receive THE LIFEBOAT free of charge will continue to do so.

The next issue of THE LIFEBOAT will appear in January and news items should be sent by the end of October.

Backbone of the Fishing Trade.

This was one that didn't get away. One of a thousand million.

A thousand million of the reasons why every day and night men put out to sea in all weathers to earn their living.

A thousand million reasons why lifeboatmen are needed as much as they are.

We at Birds Eye would like to voice our appreciation of the lifeboatmen. We are proud of our long association with them.

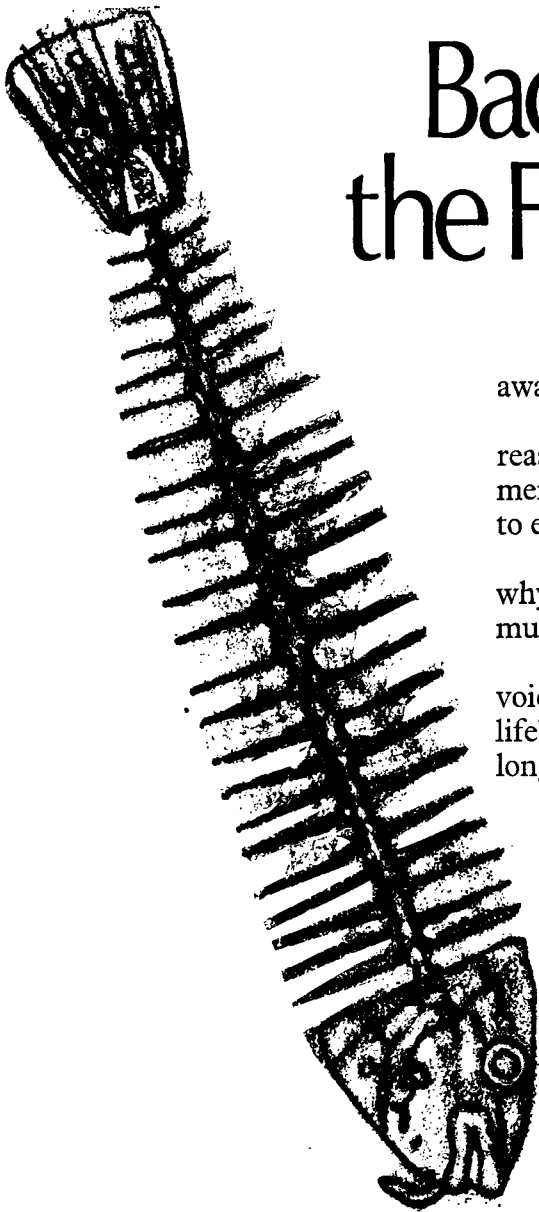



NOTES OF THE QUARTER

by the Editor

IN THE EARLY HOURS of November 30, 1973, the motor vessel *Burtonia* sank off the east coast of England with the loss of four lives. Three men were picked up by another motor vessel and one by Aldeburgh lifeboat. The Aldeburgh and Lowestoft lifeboats were both launched and they recovered three bodies. The Department of Trade and Industry decided that a formal investigation was called for, and the findings of this were published on July 31. The court found that the loss of life was caused by the shifting of the *Burtonia's* cargo of lead concentrate and that this was contributed to by the wrongful act or default of the owners. It was stated specifically in the report 'that there was never any criticism of the Royal National Life-boat Institution'.

The report did, however, deal at some length with problems of search and rescue, and immediately after the findings were made public the DTI announced that action had already been taken to bring home the lessons of the *Burtonia* incident to people responsible for SAR operations around the coasts. In particular they had been reminded of the need to up-date information about the position and crews of casualties, especially when they are moving, and to use three-figure bearings instead of cardinal points.

It was stated in the report that 'the significance of the co-ordinating role in search and rescue is not universally appreciated'. The question of whether the role of co-ordination was purely advisory or whether it ought to be supervisory in some respects was considered, the conclusion reached being: 'We consider that the true role of the Coastguard is that of giving the best informed advice available . . . It is not

necessary for the Coastguard to instruct a particular lifeboat to launch. It would seem far more desirable to continue the practice that the Coastguard should request a particular lifeboat authority to launch.'

Largest lifeboat flotilla

In the month of July the largest flotilla of modern lifeboats ever assembled was seen in Plymouth, and perhaps the largest number of lifeboat supporters ever to be found in one place at one time enjoyed the hospitality of Her Majesty the Queen in the gardens of Buckingham Palace.

The International Lifeboat Exhibition at Plymouth was opened by the Duke of Kent, the RNLI's President, on July 19, and of the various ceremonies associated with it none was more moving than that which took place on Sunday July 21, when the various lifeboats put out

together and a wreath was laid on the water to commemorate lifeboatmen of all nations who had given their lives in an attempt to save others. The exhibition itself has aroused intense interest, and a man of long experience in the exhibition field described it as the best marquee exhibition he could remember having seen.

The number of active supporters of the RNLI is fortunately so large that sadly but inevitably many had to be excluded from the garden party at Buckingham Palace on July 16. From those who had the good fortune to be present the Institution has received numerous letters stating how memorable the occasion was. Among those who were deeply moved, and to whom the event had a very special significance, were Mrs Matthew Barber, Mrs William Barber and Mrs Richard Stevens, all of whom had come up from St Ives in Cornwall. All three were widows of men

The Queen and the Duke of Edinburgh meet members of the Committee of Management during the garden party for the RNLI at Buckingham Palace, July 16. Vice-Admiral Sir Arthur Hezlet and Lady Hezlet are introduced to Her Majesty by Commander F. R. H. Swann; in background (centre), Mr and Mrs P. V. Mackinnon.



Later the Queen and the Duke moved among their guests on the palace lawns: never before have so many lifeboat supporters been found at one place at one time.





A stained glass window dedicated to the lifeboat service was unveiled at the Church of Scotland, Crown Court, London, on April 21: it shows a pulling lifeboat going to the rescue of a steam tug and records the Institution's 150th anniversary.

photograph by courtesy of Thomson Newspapers

who lost their lives when the St Ives lifeboat capsized in 1939.

Bristol and Ship Owners

Another major appeal has been launched to enable the people of a district to provide their own lifeboat. A new lifeboat of the 70' class known as *City of Bristol* has already been formally named, and the people of Bristol and

district are being called upon to raise £150,000 to cover her cost. A number of leading figures in the business world in Bristol are combining together under the chairmanship of Sir Tom Hood, and the chairman of the working committee, John Hill, is himself a director of one of the oldest established shipbuilding firms.

From time to time people ask about the support given to the RNLI by

shipping companies and shipping interests generally. It is gratifying to be able to report that recently the Peninsular and Oriental Steam Navigation Company presented a cheque for £10,000 to the RNLI to mark 'The Year of the Lifeboat'. Thirty-eight Greek shipping companies also responded to a special appeal with contributions ranging from £50 to £1,000 per company.

Onedin Line

The ship seen by television viewers in the 'Onedin Line' has served to raise a substantial sum for the RNLI. Philips Electrológica had the happy idea of sending the ship, *Charlotte Rhodes*, a three-mast topsail schooner built in Denmark in 1904, round leading ports in Britain and charging a boarding fee of 20p, the proceeds being donated to the RNLI.

Support from Sport

During the summer months many sporting events have been staged by RNLI branches to mark 'The Year of the Lifeboat'. Of these one of the most ambitious was the pro-am golf tournament sponsored by Associated Tyre Specialists, which was held at the Notts Golf Club, Hollinwell, on May 29. From this the RNLI received about £3,000. Nearly all the leading British golf professionals took part; generous supporters of the Institution paid as much as £100 to compete; and a list of the other competitors read like a *Who's Who* in sport and show business. They included Bobby Charlton, Henry Cooper and Gary Sobers. The individual winner of the professional event, Christy O'Connor, on receiving his award from Raymond Baxter, spoke most warmly from his own personal knowledge of lifeboat crews in County Galway.



About £3,000 was raised for the RNLI by the pro-am golf tournament at Notts Golf Club, May 29. Last team to tee off was Hugh Baiocchi and Duncan Lee (left) and Dr David Marsh and Henry Cooper (right).

A happy interlude when Princess Alexandra visited Stockport in March: arriving at the Town Hall for lunch, the Princess met the local branch crew of lifeboat auxiliaries, some wearing their red stocking hats. She told them that when visiting Scotland, she had been given two of these hats for her children, but one had been lost; immediately, a crewman took off his hat, offered it to Her Royal Highness, and it was gladly accepted.

photograph by courtesy of the 'Daily Express'



ANNUAL GENERAL MEETING

and presentation of awards

FESTIVAL HALL, LONDON, MAY 21

A BRIGHT, sunny morning; friends from all parts of Britain and Ireland gathering on the South Bank of the Thames ready for the annual general meeting and presentation of awards in this 150th anniversary year of the RNLI; and to give a wonderful start to the day, the presentation in front of the Festival Hall, of a cheque for £100,000. It was the biggest cheque Commander F. R. H. Swann, CBE, RNVR, chairman of the Committee of Management, had ever received for the Institution; handed to him by Mr Roy Bailhache, chairman of the Jersey branch, to pay for Jersey's new 44' Waveney lifeboat, it represented a memorable effort on the part of Mr Bailhache himself, the branch and guild and, indeed, of all the people of Jersey.

Following this happy prologue, the morning continued with the presentation of the annual report and accounts to the governors of the Institution. Speaking on behalf of the Committee of Management, Commander Swann reported that operationally 1973 had been a very busy year, with over 2,600 services and a record number of lives saved (1,757); there had been many acts of great gallantry and, happily, for the third year running no lifeboatman had lost his life on service. During the summer 255 lifeboats of varying sizes were operated at 196 locations.

Turning to the lifeboat fleet, Commander Swann continued:

'We are now beginning to benefit from the many developments of recent years and the accelerated boat-building programme we started after the Fraserburgh disaster. The second Arun boat went into service in 1973 and is a great success. The third boat is due to be launched shortly. Further boats of this class will be built of grp. The Atlantic 21 1LB was also further developed in 1973 and given a one-off self-righting capability. We have recently launched our third 70' boat. At the end of last year we had 24 boats building, or on order, of which we expect to commission 10 this year and 10 in 1975. We need to order over 40 boats in the next few years to achieve our target of virtually a self-righting-fleet by 1980. This is a formidable task which will cost a lot of money and explains our current appeal for funds.'

Commander Swann reported extensive shore works in hand, including new housing for the full-time crew at Spurn Point, a dock for a 44' Waveney at Fleetwood and a berth for a similar

boat at Whitby. The Headquarters had been moved to rented accommodation in Poole, pending the building of the new Head Office, the site for which, and for the Depot, had been cleared. The sheet piling along the waterside boundary had made good progress and work would soon start on the office building. 42 and 44 Grosvenor Gardens had been advertised for sale by tender.

The national membership scheme with (at that time) 16,000 members of whom about 12,600 were yachtsmen, was progressing well and making a considerable financial contribution.

On the subject of finance, Commander Swann reported a surplus at the end of 1973 of £124,320. Revenue had increased by about £700,000 (about £400,000 due to legacies and special gifts and about £300,000 to branches and guilds) to £3.8m. Like everyone else, the RNLI was being affected by inflation; recurrent expenditure was up £0.4m at £2.57m and capital expenditure up £0.35m at £1.15m. Unfortunately the assets shown in the Institution's balance sheet had fallen to £3.1m compared with £3.9m for the previous year. This was mainly due to a fall in the value of the investments of nearly £1m, partly because of the transfer of £323,000 to the pension fund and partly because of the fall in the market. It now cost nearly £4m a year to run the RNLI so it was obvious that the free reserves, at just under £1m at that time, were completely inadequate and a major cause for anxiety.

In conclusion, before inviting questions, Commander Swann said:

'It is impossible to forecast the future with any confidence because, like other charities, we are affected by economic circumstances over which we have no control. All I can say is that the RNLI has a clear idea of the kind of boats it wants and how they should be deployed and operated. The morale of its crews and supporters is very high. The only anxiety is financial. We need a lot of money to run the Institution and carry out our plans. We are doing our best to make the public aware of our needs and we hope that there will be a good response to our appeal.'

After some discussion of the dilemma of the continuing inflation with regard to the assets of the Institution, Mr Gabriel Harrison (Committee of Management) congratulated Mr D. A. Acland, chairman of the finance committee, on doing what appeared to be a

very sensible medium term operation, and the report and accounts were adopted *nem. con.*

The president, HRH the Duke of Kent, was re-elected unanimously, as were the vice-presidents.

'Mrs B. Birch (Camberley): Why do we only have the Archbishop of Canterbury?'

The Chairman: Because the Archbishop of Canterbury in 1824 was one of the prime movers in founding the RNLI, so he has been *ex officio* ever since.'

The Duke of Northumberland was elected as treasurer and Mr David Acland as deputy treasurer, both unanimously. The Committee of Management was elected and the auditors, Price Waterhouse and Co., were thanked by the chairman for all their help and were re-appointed.

'Mr Needham: I should just like to say at this time thank you to the staff of Head Office who carried on during the move to Poole, keeping things going, in my opinion, so well. . . .'

The Chairman: Thank you very much, Mr Needham. The staff had a very busy time with this move on top of the 150th

A cheque for £100,000, the biggest he had ever had received for the RNLI, was handed to Commander Swann by Mr Roy Bailhache, chairman of the Jersey branch: it will pay for Jersey's new 44' Waveney lifeboat.



Anniversary and I think that we are very much in their debt.'

Mr N. Crumbie (Orpington) then proposed a resolution from the floor, placing on record in this anniversary year of the RNLI, the thanks of the governors assembled to all officers, committee members, staff, voluntary workers and, most particularly, the lifeboat crews, for their devotion and combined efforts which made possible the lifeboat service; the resolution was seconded and carried unanimously.

* * *

Opening the afternoon session, Commander Swann said:

'This morning at a meeting of the governors of the Institution I presented the Institution's annual report and accounts for last year. I did so with satisfaction and pride, for I felt that in the 150th year of its existence the RNLI continued with marked success to carry out the intentions of its founder . . .

'Sir William Hillary was a man of vision and foresight, and one of the most remarkable things about the pamphlet which he published in 1823 was that it provided in many respects a blueprint for the RNLI as it is organised today . . . Hillary emphasized the importance of local committees established to conduct their own affairs. In a world of increasing centralisation, it is one of the great strengths of the RNLI that so much control is exercised locally . . .

'Our founder also stressed the importance of volunteers. The voluntary system has served the Institution well. It has been maintained through two world wars and through numerous financial crises. It remains the essence of the lifeboat service today.

'In the technical field Hillary was also a far-seeing man and as early as 1824 he published a plan for the building of steam lifeboats. The continuing advances we have made and are continuing to make would, I am sure, have gladdened his heart, and he would have found such new developments as the Arun lifeboat or the

fast Atlantic inshore lifeboat a thrilling outcome of his own inspired efforts.

'It was therefore with a feeling that the RNLI as a whole had just cause to celebrate 150 years of voluntary service to people of all nations that we embarked on the celebrations connected with "The Year of the Lifeboat" . . .'

The following medals for gallantry, awarded for services in 1973, were then presented by Commander Swann:

SILVER MEDAL

Coxswain John King, Bridlington

On April 2, Bridlington lifeboat *William Henry and Mary King* rescued the crew of five of the MFV *White Knight*, which was dragging her anchor off Hornsea in storm force north-north-easterly winds. Despite the dangers in going alongside in the seas prevailing, by careful manoeuvring the men were safely transferred to the lifeboat.

Coxswain Michael Berry, St Helier

On September 18, St Helier lifeboat *Elizabeth Rippon* rescued the crew of six of the yacht *Bacchus* in an area of notoriously dangerous rocky outcrops. There was a west-south-westerly gale and a rough sea with heavy swell. The lifeboat grounded four times before clearing the submerged rocks and reaching the casualty.

BRONZE MEDAL

Coxswain Michael Mackay, Islay (bar to bronze medal)

On March 27, lifeboat *Mabel Marion Thompson* on temporary duty at Islay, rescued the captain and crew of the Norwegian tanker *Olga* aground at Bhride Island in a southerly gale and rough sea. *Olga's* crew climbed on to a lifecraft and were hauled across 90' of rough water.

Helmsman John Grove, Horton and Port Eynon

On July 2, Horton and Port Eynon ILB rescued three people attempting to swim to the mainland at Rhossili Point against a very strong flood tide. One of the casualties, a woman, had to be given artificial respiration and Helmsman Grove negotiated a hazardous rocky gully to land her quickly.

Helmsman Benjamin Pearson, Crew Member Alexander Russell, North Berwick

On July 26, North Berwick ILB rescued a man who was in difficulties some 20' from the rocks at East Bay, in spite of a heavy 15' swell and a dangerous backwash.

Helmsman Keith Willacy, Morecambe

On August 4, Morecambe ILB rescued two people from a sandbank near the *Western Valleys* wreck. With a gale force south-westerly wind blowing against the ebb tide in an area of dangerous surf, conditions were extremely hazardous.

Coxswain William Holmes, Angle

On August 5, Angle lifeboat stood by the oil tanker *Dona Marika* which had gone aground at Wooltack Point. Although the tanker's crew eventually got ashore over the rocks, the lifeboat had persistently tried to rescue them, going alongside, despite a rise and fall of about 20', seven times.

Helmsman Dennis Faro, Eastney

On August 5, Eastney ILB rescued the crew of two of the yacht *Jo of Ryde* three miles south south west of Eastney Point in gale force winds. The bow of the ILB was put alongside the yacht in very dangerous conditions.

Coxswain John Fox, Shoreham Harbour (bar to bronze medal)

On August 5, Shoreham Harbour lifeboat *Dorothy and Philip Constant* saved the yacht *Albin Ballad* and her crew of three. A tow line was successfully passed, it being considered too dangerous to take off the exhausted crew. There was a south-south-westerly gale with 25' waves breaking over the yacht.

Helmsman Donald Jones, Rhyl

On August 7, Rhyl ILB rescued two boys clinging to a perch between Rhyl and Prestatyn. Helmsman Jones had to put the bow of the ILB against the perch in a westerly gale and through waves 6-8' from trough to crest.

Assistant Mechanic Keith Richardson, Crew Member Jack Barrett, Walton and Frinton

On August 15, Walton and Frinton lifeboat *Edian Courtauld* rescued five people from a speedboat awash on Pye Sands in a moderate to fresh easterly wind and a choppy sea. As the lifeboat

Medallists all, in order of presentation. In the foreground are Coxswain John King, of Bridlington, and Coxswain Michael Berry, of St Helier, Jersey, both of whom were awarded the silver medal for gallantry.





'From the time that lady sold her flag or arranged her coffee morning to raise funds—that was when this rescue started . . .': Coxswain Derek Scott of The Mumbles moved the resolution of appreciation to lifeboat crews and voluntary workers.

had grounded a little over one cable from the casualty, Assistant Mechanic Richardson and Crew Member Barrett volunteered to wade and swim in very dangerous waters to re-assure and assist the people on board the speedboat, who were up to their waists in water, until the lifeboat refloated.

Acting Coxswain Thomas Rowley, Scarborough

On September 29, Scarborough lifeboat *J. G. Graves of Sheffield* saved the ex-HDML *Eun Mara an Tar* and rescued her crew of four in a storm force north-north-westerly wind and a very rough sea. A tow line was passed successfully, it being thought too dangerous to take the crew off. The tow line parted three times before reaching harbour.

Coxswain Arthur Farrington, Seaham

On November 11, Seaham lifeboat *The Will and Fanny Kirby* rescued 18 anglers cut off on the drum head of North Pier, which was being swept by heavy seas. Although frequently thrown clear by the surge of confused seas and swell, the lifeboat was taken into the 'corner' formed where the drum head joins the main pier while the anglers, two or three at a time, jumped into the lifeboat. Coxswain Farrington required six stitches to a head injury sustained during this service. He also broke a wrist.

Doctor Paul Barclay, MC, TD, Cromer

On November 15, medical help was needed for an injured crew member aboard the trawler *Boston Jaguar*. As there was no other local doctor he could ask to go, Dr Barclay, the station honorary secretary, went himself in the lifeboat *The Good Hope*, on temporary duty at Cromer. There was a strong gale force north-westerly wind and a very rough sea. Although suffering from severe seasickness, he boarded the

tanker in very dangerous conditions to attend the injured seaman.

Coxswain Albert Brown, Workington

On January 27, the lifeboat *City of Edinburgh* on temporary duty at Workington rescued the crew of seven of the fishing vessel *Kia-Ora* in a storm force south-south-easterly wind and a very rough sea. *Kia-Ora* was dragging her anchor and out of control and the lifeboat was held alongside while all the crew were taken off.

After the presentation of awards for gallantry, the following resolution was moved by Coxswain Derek Scott, BEM (The Mumbles):

'That this meeting fully recognising the important services of the Royal National Life-boat Institution in its national work of lifesaving, desires to record its hearty appreciation of the gallantry of the coxswain and crews of the Institution's lifeboats, and its deep obligation to the local committees, honorary secretaries and honorary treasurers of all station branches; to all other voluntary committees and supporters and to the honorary officers and thousands of voluntary members of the financial branches and the ladies' lifeboat guilds in the work of raising funds to maintain the service.'

In moving this resolution, Mr Scott said:

'One hundred and fifty years ago when our founder member, Sir William Hillary, laid down the basis of what was to become the oldest national sea-rescue service in the world, its principal aim was quite clear, namely, the preservation of life from shipwreck at sea. Over the last century and a half men have died in upholding that tradition, but, ladies and gentlemen, the one thing that has never changed in all that time has been the hand in need of help in the water.'

Mr Scott looked at the lifeboat service through a lifetime's experience in his own village of Mumbles. In particular he remembered the majestic record of Coxswain William Gammon, and the loss of the Mumbles lifeboat, with Coxswain Gammon and all his crew, when, in 1947, they were trying to rescue the crew of a ship called *Santamba* in hurricane force winds:

'The blow to our little community was absolutely shattering, but like other lifeboat stations that had suffered such a tragedy, I do not believe the thought ever crossed our minds that there would never be another Mumbles lifeboat. It seemed so natural for us to form a new crew as quickly as possible, because it seemed to us that for a village to lose its lifeboat was like losing its identity.'

Coming up to the present day Mr Scott said:

'Over the years this Institution of ours has had to change, not in its purpose, but as regards its ideas to keep abreast of modern times. We have more modern

boats at present which are faster than previously. Some of them are slightly bigger and they are far better equipped and we also have, as most of you have seen outside, a fleet of inshore rescue boats. . . .

'The crews have also changed. No longer do we have an abundance of inshore fishermen to call on, but in many boats such as my own you will find a great cross-section of crews. They come from all walks of life. I have, for instance, a bricklayer, a draughtsman, a painter and decorator, and a headmaster of a school, to name just a few. I find this is a great advantage because they apply their individual talents to the handling of different types of equipment that we carry in these boats today. It is not all heroism in lifeboats. It is hard work, training and a state of readiness that makes a good lifeboat crew. However, all this can become a little tedious and it is sometimes broken by the lighter-hearted moments that you come across from time to time.

'I remember one beautiful occasion when I was asked by the Coastguard repeatedly, "What is your position?" We were being thrown around really badly at the time. He said it again and before I had a chance to answer him the mechanic looked up and he said: "I don't know what his position is, but ours is bloody desperate!" . . .

' . . . I have always believed that a coxswain is only as good as his crew. When you are setting off in the blackness of night into gales force 9, into God only knows what, the feeling of unity between a lifeboat crew is inexplicable and no matter how frightened you feel you know that the crew of the ship who are waiting for you are a great deal more frightened than that. Then, maybe after hours of battling through heavy seas and being beaten to death you arrive and you are wet and cold and thinking, "What on earth am I doing here?" and then you see the casualty which can be a a terrifying situation where life is hanging by a thread, but this is the moment that we have all been prepared for. From the time that lady sold her flag or arranged her coffee morning to raise funds—that was when this rescue started, not when the maroons were fired. Anybody who works for or supports this Institution in some way is responsible for the preservation of life at sea. If you could share with me and see the look on a survivor's face at the moment of rescue, and share that marvellous feeling with the lifeboatmen when they are coming home in the boat and the job has been done, then you would all know that this last 150 years has been more than worthwhile.'

Since the last AGM the Committee of Management has awarded three honorary life governorships and 12 gold badges to honorary workers for long and distinguished service. Presentations were made at the Festival Hall by Commander Swann to all but Mr Knox, Mrs Martin and Mrs Wright, who were unfortunately unable to be there:

HONORARY LIFE GOVERNOR

Mr R. N. Crumbie

Chairman of Orpington and District



Mr R. N. Crumbie,
Orpington and CAC.



Lady Olwen Carey Evans, DBE,
South Caernarvonshire.



Mr H. Biggs,
Broadstairs.



Miss L. Dally, Barry.



Mrs A. Dutton,
Fareham.



Mrs A. Hamerton,
Attleborough.



Mr D. C. Hill, TD,
Nottingham and District.



Mrs C. W. Keeble,
Sidcup.



Mrs J. Macpherson,
Oban.



Mrs P. H. Megson,
Romiley.



Lady Norton, MBE,
Central London.



Mrs J.C.F. Prideaux-Brune,
Padstow.

branch since 1948; chairman Central Appeals Committee since 1970.

A most enthusiastic worker for the Institution, Mr Crumbie is prepared to give his time and energy to help the service in any possible way. In addition to being the chairman of a very successful branch, he has been chairman of the Central Appeals Committee, responsible for fund-raising activities on a national scale, since its formation.

Lady Olwen Carey Evans, DBE
President and chairman of South Caernarvonshire guild since 1941.

Lady Olwen has been an official of a most active and productive guild for the past 33 years. Her leadership has been an inspiration to everyone.

Mr W. R. Knox, CBE MM JP
Honorary secretary of Portrush station branch from 1938 to 1973 (except for war years).

Mr Knox's record of service, spanning a period of over 40 years, is known throughout Northern Ireland. In his capacity as a vice-president of the Royal British Legion, he had some influence on their decision to provide a new lifeboat for the Institution in 1972.

GOLD BADGE

Mr H. Biggs
Honorary secretary of Broadstairs branch since 1952; honorary collector 1950 to 1952.

A tireless worker throughout his 23 years with the Broadstairs branch, Mr Biggs has been largely responsible for its financial success. He was instrumental in organising a new ladies' lifeboat guild in Broadstairs, and has also undertaken many speaking engagements on behalf of the institution.

Miss L. Dally
Honorary secretary of Barry guild from

1942 to 1959; chairman since 1959.

Miss Dally has been the mainstay of the Barry ladies' guild for the past 32 years. She is a most enthusiastic and loyal worker.

Mrs A. Dutton
Joint honorary secretary of Fareham branch from 1947 to 1960; honorary secretary since 1960.

Mrs Dutton has worked enthusiastically for the lifeboat service for over 26 years. She organises the annual collection throughout the whole of the very large Fareham Urban District where, through her efforts, the financial return has risen steadily each year.

Mrs A. Hamerton
Honorary secretary of Attleborough branch from 1950 to 1954 and since 1957.

Mrs Hamerton has given many years of outstanding service to the RNLI. She is constantly on the lookout for fund-raising ideas and the revenue of her branch has maintained a steady rise due to her untiring energy.

Mr D. C. Hill, TD
Honorary secretary of Nottingham and District branch since 1950.

Since 1950 Mr Hill has worked steadfastly towards the maintenance of a successful financial branch. His energy has been instrumental in establishing a continuing high income which in latter years has surpassed £3,000, and his influence has spread throughout the county of Nottinghamshire.

Mrs C. W. Keeble
Assistant LBD organiser (Epsom) 1948; LBD organiser (Bromley) 1950; assistant honorary secretary of Sidcup branch from 1960 to 1966; honorary secretary since 1966.

Devoting considerable time and energy to the lifeboat service, Mrs Keeble has supported the RNLI in various capacities for 25 years and has

helped the Sidcup revenue to rise appreciably.

Mrs J. Macpherson
Honorary secretary of Oban guild since 1949.

Mrs Macpherson has been honorary secretary of Oban for almost 25 years. Although often handicapped by illness, she has given her time most unselfishly.

Mrs D. R. Martin
Honorary secretary of Renfrew guild from 1950 to 1967; president since 1967.

An official for the past 23 years, Mrs Martin's enthusiasm and leadership are very well reflected in the guild's financial return. She is also a most generous supporter of the Institution in a great many ways.

Mrs P. H. Megson
Honorary secretary of Romiley guild from 1953 to 1972; assistant honorary secretary since 1972.

Mrs Megson has been a member of the guild since it was formed by her mother, Mrs W. J. Kinsey, in 1927. She has been an outstanding worker for over 46 years and the Institution owes a great debt to her family for their invaluable support.

Lady Norton, MBE
Member of Central London women's committee from 1957 to 1961; chairman since 1962.

Lady Norton's very hard work for the service through the Central London women's committee, and enthusiastic charring of their innumerable successful fund-raising events, is amply reflected in the annual revenue figures: they have almost doubled since 1968.

Mrs J. C. F. Prideaux-Brune
President of Padstow guild for more than a quarter of a century.

President of the Padstow guild for

over 25 years, Mrs J. C. F. Prideaux-Brune has devoted considerable time and energy in support of the lifeboat service.

Mrs E. Wright

Honorary secretary of Kelty guild since 1947.

Mrs Wright has been a most energetic and industrious honorary secretary for the past 26 years. She has put great

personal effort into the office which is reflected in the steadily increasing revenue from her area.

The meeting ended with a vote of thanks to Derek Scott moved by Commander D. H. F. Armstrong, DSC RD RNR, the immediate Past Master of the Honourable Company of Master Mariners.

1973 ACCOUNTS SUMMARY

Income		£000's
Legacies	1,700
Subscriptions/Donations	1,515
Miscellaneous	166
Restricted Funds	479
		<hr/>
		3,860
		<hr/>

Expenditure		£000's
Operational	1,075
Technical	542
Administration/Fund Raising	962
Capital	1,157
		<hr/>
		3,736
		<hr/>
Net Surplus	124
		<hr/>

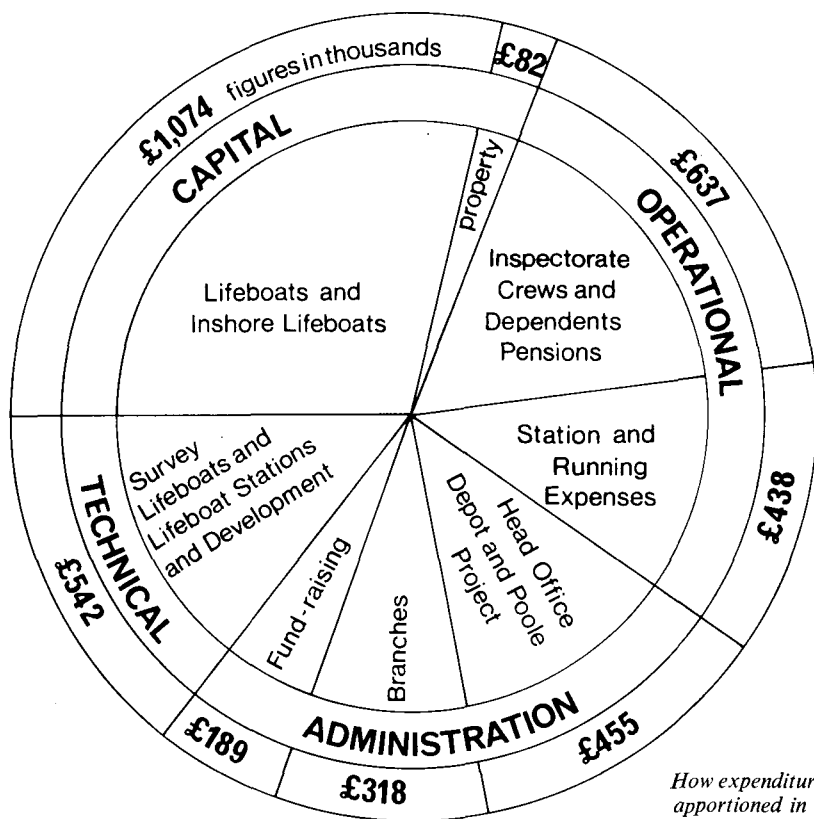

The pie chart on the left depicts the Institution's expenditure for the year 1973. The diagram has been apportioned into four main divisions, to enable a comparison of the volume of expenditure between capital, operational, technical and administration items. Each main division, where applicable, has been further sub-divided to give a fuller interpretation of expenditure.

The histogram below reveals the increasing cost of the lifeboat service over the past ten years. Each column shows the four main areas of expenditure and a surplus or deficit for the year, whichever applies.

Ten years at a glance.

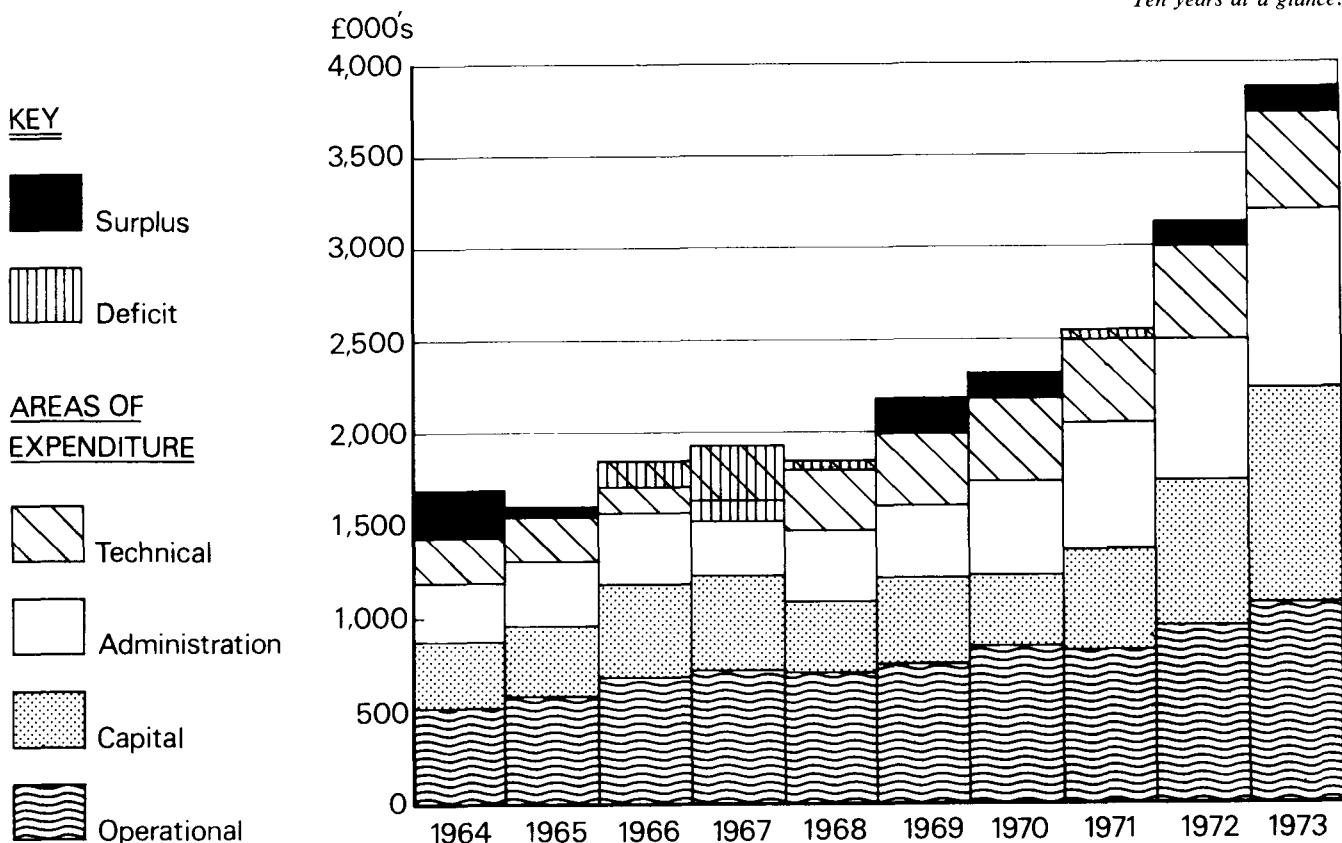

Naming Ceremonies

'May God bless them and all who sail in them . . .'



Sir William Arnold, Guernsey's new 52' Arun lifeboat, was named by HRH the Duchess of Kent at St Peter Port on May 23; it was the first visit made by the Duchess to Guernsey—on a day of sun and showers she was warmly welcomed by the islanders. Arriving for the naming ceremony, the Duchess was met by the crew and local branch officials and was presented with a bouquet and souvenir programme by daughters of crew members. Following the handing over of the boat to the Guernsey branch by Commander F. R. H. Swann, CBE, RNVR, chairman of the RNLI, and a short service of dedication, the Duchess brought greetings to the station from her husband, President of the RNLI; in paying tribute to the lifeboat people of the island, special mention was made to the work of the Arun appeal committee which has raised over £55,000 towards the cost of the new boat. After the naming ceremony, as crew members let off maroons from the shore, Coxswain John Petit turned the Arun on her axis, a most impressive demonstration of her manoeuvrability, bringing her bow on to the quay for the National Anthem.

Next morning the Duchess of Kent was taken out in Sir William Arnold (left) and clearly enjoyed every minute of her trip.



After opening the Lifeboat Exhibition at Plymouth on July 19, HRH the Duke of Kent flew by helicopter to Sennen Cove, Cornwall, to name Diana White, Sennen's new 37' 6" Rother lifeboat. Nigel Warington Smyth, OBE, a vice-president of the RNLI, delivered the boat to the care of the Sennen Cove branch, and she was accepted by the honorary secretary, Captain W. B. Harvey. The naming ceremony over, and before taking tea and meeting the lifeboat people of Sennen, the Duke accepted an impromptu offer of a trip in the lifeboat; he went to Lands End, steering some of the course himself. About an hour after the Duke finally left by helicopter, the treacherous Cornish sea mist crept in, trapping in Sennen Cove the memory of a splendid royal occasion.

photograph by courtesy of
H. G. Welby



Members of the crew of the new Eyemouth, Berwickshire, 44' Waveney lifeboat, named Eric Seal in memory of the late Sir Eric Seal, KBE, CB, a former vice-president of the RNLI and chairman of the Civil Service and Post Office Lifeboat Fund; she is the 36th lifeboat provided by this fund. The ceremony was performed on August 3 by Lady Seal, whose son, the Reverend Philip Seal, took part in the service of dedication. (Below) Jeanette Dougal, daughter of the coxswain, presented a bouquet to Lady Seal.



The new Sheerness, Isle of Sheppey, 44' Waveney lifeboat Helen Turnbull was named on May 18 by Mrs R. D. Leigh-Pemberton, wife of the vice Lord Lieutenant of Kent. A legacy from the estate of James Bissell Turnbull, together with donations from Medway Lions Club and Medway lifeboat appeal, defrayed the cost of this lifeboat. Admiral Sir Edmund Irving, KBE, CB, a vice-president of the RNLI, delivered the boat to the care of Sheerness branch, on whose behalf she was accepted by honorary secretary Captain David Gibbons.



(Above) After her naming ceremony at Shoreham on Thursday, May 2, by Lady Egremont, president of the ladies' lifeboat guilds, Mary Gabriel, 37' 6" Rother Class, was taken to her station, Hoylake, in Cheshire. A service of dedication was held there on June 20, when the lifeboat crew made their own presentation, of a silver salver, to Major Osman Gabriel.



On May 29 Stornoway's new 48' 6" Solent lifeboat (left) was named Hugh William Viscount Gough in memory of the late Lord Gough, a regular fishing visitor to the island, by his widow, the Viscountess Gough. The lifeboat was provided by a gift from the Viscountess and her son, the present Viscount Gough. W. F. G. Lord, BL, a member of the Committee of Management and vice-chairman of the Executive Committee of the Scottish Lifeboat Council, delivered the boat to the care of the Stornoway branch, on behalf of whom she was accepted by honorary secretary Captain A. Mackay.



Plymouth bound: Fleet of ten international lifeboats in company with HMS Ajax off Portland.

photograph by courtesy of HMS Osprey, Portland.

INTERNATIONAL LIFEBOAT EXHIBITION

Plymouth, July 19-August 17: For a month the R.N.L.I. was at home to the world

PLYMOUTH, JULY 19. A brilliant day with the sun beating down on a cluster of white marquees in West Hoe Park, close by the sea; an atmosphere of cheerful expectancy; flags flying; the Royal Marine Band breaking into the gaiety of 'Celebration'. Then 'The Year of the Lifeboat' reached its climax as, at noon, HRH the Duke of Kent, President of the RNLI, accompanied by the Lord Mayor of Plymouth, Councillor F. Johnson, disembarked from Plymouth's new 44' Waveney lifeboat at the Royal Western Yacht Club of England and walked up through cheering crowds to join the guests assembled for the opening ceremony of the first-ever International Lifeboat Exhibition. The Duke had already met British and overseas lifeboat officials and crews in Millbay Docks; there he had embarked in Plymouth's new boat, *Thomas Forehead and Mary Rowse II*, and he had been escorted into Plymouth Sound by the whole fleet of 11 visiting lifeboats, dressed overall, with Plymouth's 18' McLachlan and an Atlantic 21 as well.

Very fittingly, the opening ceremony included the presentation of a bronze

medal for gallantry to Coxswain John Dare of Plymouth for a service in appalling weather last January, described on page 213. The Duke welcomed the representatives and crews of overseas lifeboat services and thanked the citizens of Plymouth for all the support they had given and, declaring the exhibition open, he said:

'I hope the exhibition, which lasts for

four weeks, and is accompanied by a great variety of other events mostly of a marine flavour, will be visited by many thousands of our own citizens, by people from overseas, by the young and by the old. Apart from the valuable revenue this will bring to the Institution, I think it is important that the achievements and capability of the lifeboat service should be known as widely as possible—particularly of course to anybody who uses the sea in any way, whether for

Going aboard Thomas Forehead and Mary Rowse II in Millbay Docks, the Duke of Kent met Captain T. G. Hornsby (left), chairman Plymouth branch, Ray Sainsbury, honorary secretary, and Coxswain John Dare.

photograph by courtesy of 'Western Morning News'



business, sport or recreation. To all of them the exhibition will, I believe, convey a message of hope for humanity and belief in the highest ideals of selfless service to others.'

The tour of the exhibition which followed took rather longer than had been expected, such great interest did the Duke take in the stands. Then, after attending a reception in the entrance hall, he left to lunch with the Lord Mayor in his Parlour before flying by helicopter to perform the naming ceremony of Sennen Cove's new boat, *Diana White*.

By now the doors had been thrown wide and the public was flowing in to enjoy all that had been prepared for them. There were stands depicting every aspect of the RNLI's history and organisation; stands showing something of the lifeboat services of other lands, in particular the USA, the Netherlands, France, the Federal Republic of West Germany and Canada; stands displaying the work of other bodies concerned with coastal waters and the saving of life at sea, the Royal Navy, Royal Air Force, HM Coastguard and Trinity House; and finally exhibits from a number of boatbuilders and manufacturers who supply equipment to the RNLI.

Two over-riding impressions remain: the closeness of the exhibition to the sea, and its vitality. There was too much to be contained within the canvas walls of the main site marquees; it overflowed on to The Hoe, into the Sound, into the docks. It touched reality at so many points; an ILB had picked up a canoeist who was in trouble at the mouth of Millbay Docks, just as the Duke of Kent was embarking in *Thomas Forehead and Mary Rowse II*; the first rescue demonstration off The Hoe, planned for Saturday afternoon, had to be cancelled because, just as it should have started, the maroons went off and lifeboat, helicopter and Atlantic 21 (in Plymouth for these demonstrations) were away in earnest to search for two boys overdue from a fishing expedition. *Ragni Berg*, the smaller Norwegian lifeboat, had even stood by a Dutch yacht in trouble off Esbjerg on her passage from Norway.

Before the curtain had risen at Plymouth, there had been a prologue at Poole when, for the first time, the RNLI welcomed visitors from overseas to its new Headquarters. The six foreign lifeboats on passage to take part in the Plymouth exhibition were met at Poole Bar on Sunday afternoon, July 14, by five British lifeboats (including the present and future Poole boats) and escorted up harbour to moor, three abreast at the quay. It was a majestic procession. Poole Harbour was in one of her most dramatic moods: the sun shinging from among dark clouds: blue stretches of sky, lively green water, and the Purbeck hills in the background. Through yachts and pleasure boats they glided, in stately line astern, the visiting



A welcome for the Duke from the crowds as he walked up to the exhibition site with the Lord Mayor of Plymouth, Councillor F. Johnson (right) and Captain Nigel Dixon, Director RNLI. . . .
photograph by courtesy of 'Western Morning News'

. . . and (right) a welcome from Commander Peter Sturdee, OBE RN, exhibition co-ordinator.



(Below) A royal contribution to the lifeboat service.



lifeboats predominantly white, the British dark blue and orange, to come to rest quietly alongside a quay crowded with spectators. The Mayor and Sheriff of Poole, with the Chairman, Director and other RNLI officials, were aboard the leading British lifeboat, the new 70' Clyde *City of Bristol*.

The visitors were welcomed by the Mayor to a *vin d'honneur* aboard *MV Bournemouth Queen* that evening and the next afternoon were taken for a coach run round Dorset.

A gale blew up that Sunday night, but wind and rain did not deter a steady stream of people from taking this unique opportunity of seeing round ten of the most modern, most splendid lifeboats of the world. From Germany there was the 26.6 m rescue cruiser with daughter

boat, *Arwed Emminghaus* and *Alte Liebe*; from France, the 15.5 m 'all seasons' lifeboat *Patron Emil Guyot*; from Norway, the 80' cruiser type lifeboat *R.S. Platou* and the 45' patrol boat *Ragni Berg*; from Poland was a 21.09 m rescue cruiser *Monsun*, and from Sweden the 78' patrolling steel lifeboat, *Sigurd Golje*. Great Britain was represented by four of her newest boats, all on trials before going to station: *City of Bristol*, the 70' Clyde trawler-type lifeboat to be stationed off Clovelly; *Civil Service* and *Post Office Fund No. 37*, the third Arun, 54' with rounded transom; *Rotary Service*, the prototype of the 50' steel Thames class; and *Augustine Courtauld*, the 44' Waveney class lifeboat which will be stationed at Poole. The fifth RNLI lifeboat on show at Plymouth, *J. Reginald Corah*, 37' 6" Rother, did not join the main fleet for the passage to Plymouth.

On Tuesday morning, July 16, the fleet, under the orders of Commander Peter Gladwin, set sail for Plymouth. The wind had moderated to force 5-6, but the gales of the previous day had left behind seas turbulent enough for these boats, many of them only recently launched, to enjoy impromptu trials, and it was an unparalleled opportunity for their crews to see the performance of 'the other man's boat'.

Round St Albans Head—and pretty



tunity to welcome aboard members of Brixham Rotary Club. After a short trip round the outer harbour to have a closer look at the foreign lifeboats, the Rotarians entertained the crew to dinner at the Northcliffe Hotel.

With the wind off the land, the sea was quiet for the last leg of the passage. Once again the boats sailed at their own speeds—anything from 10 to 24 knots—to a position off Gara Point. They were all there in good time to take up their formation again, ready to rendezvous with HMS *Walkerton* for the final run in to Plymouth. It would be a hard man who did not appreciate the grandeur of that gentle, dignified fleet sailing through waters steeped in history to make its own quiet mark on the passage of time. *Thomas Forehead and Mary Rowse II* and the two ILBs all came out to greet them and, soon after they reached their berth in Millbay Docks, they were followed in by three US Coast Guard cutters, *Duane, Chase and Ingham*, which were to stay in Plymouth for a few days, representing the United States at the opening of the exhibition.

The overseas lifeboats stayed in Plymouth until the beginning of the following week; the British boats throughout the four weeks of the

rough it was—then on towards a position two miles east of the Shambles Light-vessel where the fleet took up a formation in two columns behind the flagship *City of Bristol*, ready for a rendezvous with HMS *Ajax* at 1300.

Breaking formation again, the lifeboats surged over and through the sparkling, white-topped waves round Portland Bill with a wild, joyous gaiety and set course for the long haul across Lyme Bay. With *Arun 54-03* and *Arwed Emminghaus* at their head, the high-speed boats had soon romped over the horizon, while the rear was brought up by the more stately *Monsun* in company with *City of Bristol*.

All the boats reached Brixham by 1900, where Torbay lifeboat crew had a welcome waiting. Not only did they arrange a party at Brixham Yacht Club in the evening, but they were there soon after 0600 next morning to fetch the crews from their hotels and ferry them out to the boats. For the crew of *Rotary Service*, to which the Rotary Clubs of Britain and Ireland have contributed, there had been the oppor-

Moored alongside Poole Quay, on passage to Plymouth: (left to right) City of Bristol (70-003), Monsun (Poland) and Rotary Service (50-001).

photograph by courtesy of J. P. Morris

(Below) Berthed in Millbay Docks: (left to right) Arwed Emminghaus (Federal Republic of Germany), Sigurd Golje (Sweden), City of Bristol and R. S. Platou (Norway).



The fleet approaching Plymouth, HMS Walkerton at its head: (left to right) Patron Emil Guyot (France), Arwed Emminghaus, Sigurd Golje, Monsun, City of Bristol and R. S. Platou.



exhibition. They were a constant source of interest, their crews showing visitors round and answering innumerable questions as the most was made of the chance to discover something about all the technical detail that goes into a modern offshore lifeboat. The six boats from France, Germany, the Netherlands, Norway and Sweden will be more fully illustrated and described in our winter issue.

So, by Wednesday evening, the lifeboats had arrived. By Thursday evening the delegates and their wives from overseas were there, too. They came from Australia, Belgium, Canada, Chile, Denmark, Finland, France, Germany, India, the Netherlands, Norway, Poland, Sweden and the USA to join the lifeboat service of Britain and Ireland in the celebration of its 150th anniversary.

On Friday evening, the RNLI enter-



Coxswain John Dare read the lesson at the service of thanksgiving and dedication.

At informal gathering of delegates, Mr Mikko Mannio, Finland, presents cut-glass bowl and flag to Commander Swann. On table, scroll prepared by French delegation on behalf of many of the world's lifeboat services, and 100-year-old copper, candle-lit lamp from Denmark. Germany, Norway and Poland presented medals; Sweden a picture; and presentations to be made later this year were announced by other countries.

photograph by courtesy of 'Western Morning News'

tained the foreign delegates, their wives and the lifeboat crews to dinner. Proposing the toast of the Royal National Life-boat Institution, Commander Ch. van de Zweep, RNN, representing the Netherlands lifeboat societies, said that, although the world was indebted to many countries in the development of lifeboat design, none had contributed more than Britain, because she had had to find answers to the many problems posed by her very varied coastline.

Saturday was another full day. The yachtsmen who had assembled for the RNLI rally set off from the Royal Western Yacht Club for a race round Eddystone Lighthouse and East Rutts Buoy. Thirty-five boats started in three classes, and the winners were:

Division 1

Class A: 1, *Double O Too* (R. L. Hay).

Class B: 1, *Duchess* (J. Burton).

Division 2

1, *Squirrel* (Cdr E. McKee).

The prizes were later presented at a Seafarers' Evening in the Guildhall. Meanwhile, after an informal meeting in the morning, the delegates, their wives and the crews were invited by the Lord Mayor and Lady Mayoress to a reception at noon at the Council House.

The last formal event was an open-air interdenominational service of thanks-

giving and dedicatioe for the work of the RNLI and of the lifeboat services of all nations at Princess Royal Pier, Millbay Docks, on Sunday morning, at which the lesson was read by Coxswain Dare. As it ended, those present embarked in the lifeboats and set out to sea for a short wreath-laying ceremony in memory of lifeboatmen of all nations. Commander F. R. H. Swann, CBE, RNVr, chairman of the Committee of Management, was on board *City of Bristol*, from which the wreath was laid. The other lifeboats and some of the yachts followed her out to sea and took station astern of her. From the more distant boats it was not possible to hear all the service, but some parts rang across the water: the last post and reveille, and, startlingly clear, the words:

'Neither death, nor life, nor angels, nor principalities, nor powers, nor things present, nor things to come, nor height, nor depth, nor any other creature, shall be able to separate us from the love of God, which is in Christ Jesus our Lord.'

All this time, and until August 17, visitors continued to enjoy the exhibition, which was full of things to see and things to do. The central feature of the show, on the grass between the two tents, were more boats: the Whitby lifeboat, *Robert and Ellen Robson*, built in 1918 and one of the only two pulling

RNLI lifeboats still in existence; *The Elliott Gill*, one of the Liverpool lifeboats, displayed on her own carriage; an Atlantic 21 and a 16' inflatable ILB. The old boats evoked both interest and affection, but it has to be admitted that, for children, the great joy was a tractor close by the boats; two or three of them could be found 'driving' it at any time of the day.

Coming down in size, there was a wealth of models to be seen, both on the British and overseas stands; even a model tractor and wheel carriage, helicopters (RN), air-sea rescue craft (Fairey Marine) and a model of a breeches buoy rescue (Holland). Thirteen models illustrated British lifeboat development, from the 'Original' and early pulling and sailing boats like the Norfolk and Suffolk, right up to the Thames and the first Clyde.

There was a beautifully-made model of an Atlantic 21 on the stand showing ILB development. This was another favourite spot for children as the stand included two Atlantic 21 consoles on which they could sit, investigate the controls—and let imagination have full play ('You can go out first.' 'No need for you to come, there's only one wreck.' 'Yes, I'm coming, too—there're two ships out there. . . .') And off they went to sea, two would-be coxswains in command of their boats).

Continuing round the show the visitor could study a mock-up of an Arun wheelhouse, complete with instruments, chart and log. Then on to the design section, where there was a working model test tank with a lifeboat being subjected to simulated seas, and another model lifeboat undergoing perpetual self-righting trials. For those interested in design detail there were plenty of boat plans to study; further on in the exhibition they would be able to study plans showing the evolution of the lifeboat station, displayed by Lewis and Duvivier.

The Depot, among other exhibits, had on show a fine display from the rigging loft. Here was all the poetry of



Older lifeboats had an honoured place: The Elliott Gill (left), one of the Liverpool lifeboats, and Robert and Ellen Robson, the ex-Whitby pulling boat. A launching tractor nearby was a constant joy to children.



There was a wealth of models at the show—and a wealth of knowledge for all who liked to ask
 photograph by courtesy of 'Western Morning News'

Aboard Arwed Emminghaus a few technical details are explained by her captain, Rolf Hoffman.
 photograph by courtesy of the Central Office of Information



Chay Blyth signed copies of THE LIFEBOAT souvenir programme while visiting the exhibition.



the language of the sea: veering line, scrambling net, drogue, heaving line, bow pudding.

Shoreline, busy enrolling new members, were showing one of the three short films that could be watched. The others were on the USA stand (showing the training of student coastguards, and some spectacular shots of 44' lifeboats in the heavy surf of the eastern seaboard) and on the Canadian stand (showing the range of its rescue craft, from patrolling cutters to shore-based hovercraft).

On the German stand, as well as some fine colour photographs and models, was a chart of her coastline with different coloured lights, controlled by push-buttons, showing the positions of her lifeboat stations and the different types of boat at each. A chart of stations and lifeboats was included in the French display, too.

There were telephones on the Coastguard stand. Pick one up and you could hear the messages that pass between the Coastguard and rescue services from the time a member of the public dials 999 and asks for 'Coastguard' to report a boat in trouble until the rescue is complete. The telephone call sequence was

illustrated by a series of lighted cartoons.

So much to see and so much to learn, with photographs and information of all sorts. There were marine engines (Leyland Thornycroft, Mermaid Marine, General Motors and Enfield Industrial Engines); photographs of Brooke Marine's range of high-speed craft; inflatable dinghies (University Marine and Avon Rubber Co.); a station winch engine (Hendy-Lennox); hovercraft self-righting equipment (British Hovercraft Corporation); resuscitation equipment (British Oxygen Co.); a selection of grp moulding samples (Halmatic); electronic navigation equipment (Kelvin Hughes and Decca Radar); and a beverage dispenser (Drinkmaster).

As the visitor entered the exhibition he could see a display of paintings from West Country children's competitions; on Duckham Oils stand were the prize-winning entries of a South London schools' art competition; and on the way out there was the Illustrated London News exhibition of lifeboat pictures taken from that journal's archives. Finally, the visitor came to a stall packed with RNLI souvenirs.

Throughout the duration of the exhibition, as well as regular rescue demonstrations off The Hoe involving the RNLI, Royal Navy, Royal Air Force, HM Coastguard and British Sub-Aqua Clubs, there were a number of special events: a fireworks display (it rained—but no matter, people still came): Beat Retreat by HM Royal Marines on The Hoe; performances of the 'window ladder' by the Royal Naval

display team, and a field gun competition. There was also an exhibition by the Royal Society of Marine Artists in the City Museum.

A number of well-known personalities came along to the exhibition to give the RNLI their support. Chay Blyth was there on the first Saturday; and on subsequent days Keith Fordyce, Peter Purves of 'Blue Peter', and Ed 'Stewpot' Stewart.

One way and another, it was a very full month. A great many people had worked very hard in many different ways to make it possible. The City of Plymouth was wholehearted in its support, a number of its leading citizens serving on the various organising committees. The show was manned throughout by voluntary helpers, mostly from Plymouth, Devon and Cornwall, but people also came from all over the British Isles, giving up their holidays to take part. The team of RNLI helpers in the staging of the show had grown as the exhibition approached; but it was Commander Peter Sturdee, OBE, RN, with his original crew of Lieut-Commander Richard Little, RN, Angela Willis, Valerie Wood and Andrew Gould, who bore the full burden of the day and to whom much of the praise must go for the great success of this principal event in 'The Year of the Lifeboat'. But an exhibition succeeds or fails primarily because of the quality of its design. The RNLI was indeed fortunate in having the services as designer of Frank McNichol. His was the creative talent and his, therefore, the triumph.—J.D.

LIFEBOAT SERVICES

South Western Division

Danish coaster capsized

RAME HEAD Coastguard reported to Plymouth deputy launching authority at 1403 on January 16 that the Danish coaster *Merc Enterprise* was in serious difficulties 23 miles south of Plymouth breakwater, and that her crew were abandoning ship. Salcombe lifeboat had been advised to launch but weather conditions prevented her crossing the bar. Helicopters were taking off from RNAS Culdrose.

Plymouth DLA agreed to launch provided the coxswain did not consider weather conditions too severe. A most intense storm was blowing from the south west, with winds of hurricane force 11 to 12. It had been building up for hours and was now blowing against the full run of the ebb tide. There was a very rough sea inside the Plymouth breakwater and visibility was half a mile. The sky was overcast with driving, squally rain. Seas of phenomenal character could therefore be expected as soon as the lifeboat left the comparative shelter of the breakwater.

Immediately he was informed of the situation, however, Coxswain John Dare requested the maroons to be fired and, 10 minutes later, at 1417, with a full crew on board, Plymouth lifeboat *Thomas Forehead and Mary Rowse*, a 52' Barnett boat, left Millbay Docks.

As the lifeboat cleared the eastern end of the breakwater at 1435 she met the full force of the hurricane. *Thomas Forehead and Mary Rowse* was continually swept by heavy breaking seas as she crossed Tinker Shoal, and Coxswain Dare found himself and the crew up to their waists in water in the wheelhouse. He ordered all the crew into the shelter of the after cabin.

The crew confirm that they have never imagined such seas and Coxswain Dare and Motor Mechanic Cyril Alcock both admitted that they themselves were frightened.

At this time Coxswain Dare received an anxious enquiry from the DLA as to whether he thought the weather conditions were too bad for him to continue. His unhesitating and blunt

reply was 'Negative, we are continuing'.

Two minutes later Rame Head Coastguard told the lifeboat that the casualty had capsized and the helicopters were recovering survivors. Another message came at 1520 to say that the helicopters had picked up seven survivors and a Russian trawler, *Leningrad*, was in the area.

At 1627 the lifeboat received news that *Leningrad* had recovered four more survivors but that seven were still missing. On being informed three minutes later by the Coastguard that the helicopter crews were reporting conditions in the area were so bad that they advised the lifeboat to return, Coxswain Dare replied, 'As there are still seven missing we are continuing'.

The Coastguard passed definite recall orders to the lifeboat at 1643, saying that these had come from DLA and the inspector. Coxswain Dare had now arrived in the area of search, 26 miles due south of Rame Head, and, seeing no signs of any survivors, and assuming that the inspector referred to in the Coastguard's message was the inspector of lifeboats, he decided to comply with the recall and return to base. The search was officially called off at 1720.

Thomas Forehead and Mary Rowse escorted *Leningrad* with her survivors to the safety of Plymouth Sound and then stood by while the pilot was put aboard, at 1940. The lifeboat then entered Millbay Docks and, after refuelling, returned to her moorings at 2020.

Coxswain Dare states that this was the worst sea he has ever experienced, and the same statement was made by the skipper of the Russian trawler. The lifeboat crew included three reserve members and Coxswain Dare reports that all the crew bore themselves with distinction throughout, as, indeed, did the lifeboat herself.

For this service the bronze medal for gallantry was awarded to Coxswain John Dare. Medal service certificates were presented to Motor Mechanic Cyril Alcock, Assistant Mechanic Patrick Marshall, Crew Member Michael Keane and Reserve Crew Members David Dinham, Frank Parker and Douglas Jago.

South Eastern Division

Hurricane launch

NEWS THAT MV *Merc Texco* had a badly injured man to be landed led to the launching of the Dungeness lifeboat, *Mabel E. Holland*, a 42' Watson beach class, at 1658 on February 11.

The wind was south south west hurricane force. The sky was overcast and visibility poor. It was 2½ hours after high water. The seas breaking on the beach were very large and the launchers had to be roped together when placing the skids to prevent their being washed away.



Coxswain John Dare, Plymouth, received his bronze medal from the Duke of Kent during the opening ceremony of the International Lifeboat Exhibition.

On reaching the water's edge the lifeboat was between waves and stuck in the shingle. The next enormous wave broached her; however, as the sea ran back it swept the stern seawards. Coxswain Tom Tart put the engines full astern and started to move off. The next wave again broached the lifeboat, throwing her heavily on to the beach; again the receding wave turned the boat allowing the coxswain to put the engines ahead and drive off. Course was then set for the casualty which was bearing north east.

At 1726 the lifeboat signalled *Merc Texco* to follow her closer inshore as the seas were enormous. It seemed that she was not able to comply, and so Peter Thomas, the first aider, volunteered to try to board. The wind was now in excess of 70 knots and the seas 50 to 60' high. The tide was setting north east at 1.5 knots.

Coxswain Tart ran the lifeboat alongside the lee of *Merc Texco* and Peter Thomas managed to scramble aboard. The ship's head was paying off the whole time, making it even more dangerous for the lifeboat which had already suffered some damage to stanchions and bulwarks.

The stretcher was passed and Coxswain Tart decided to lie off until the patient was ready to be lowered. After instructing the captain to ensure that his ship's head remained south east, Coxswain Tart again managed to place the lifeboat alongside. All members of the crew then helped to receive the injured man on board. The patient was strapped down in the cabin and held by three members of the crew as the lifeboat was taking a severe buffeting in the appalling weather conditions.

At 1928 the lifeboat was beached at Dungeness and the patient handed over to the doctor and ambulance staff.

For this service, the silver medal for gallantry was awarded to Coxswain Tom Tart, the bronze medal to Assistant Mechanic Peter Thomas and the thanks of the Institution inscribed on vellum accorded to Second Coxswain Albert

Haines, Motor Mechanic Alec Clements and Crew Members William Richardson, Colin Haines and Arthur Oiller. The thanks of the Institution inscribed on vellum were also accorded to 'The Launchers and Shore Helpers', some of whom were women, for their efficiency and dedication to duty under appalling conditions; a certificate was presented to each launcher and helper.

South Western Division

Storm tow

HARTLAND POINT Coastguard informed lifeboat 70-001, Charles H. Barrett (Civil Service No. 35), at 0210 on February 6 that a trawler was sinking 281°T 26 miles from the Point. The lifeboat was under way by 0220 and 12 minutes later copied a mayday relay from Ilfracombe Radio to all ships which had been received by VHF at Hartland; it reported flooding, with the trawler's pump unable to cope, and giving a Decca position of the trawler, *St. Pierre*, which was on a course north.

Staff Coxswain Michael Houchen, in command of 70-001, plotted this position and, allowing for *St. Pierre's* course of north, he set a course 290°M from Hartland Point at 0305 to intercept.

The wind on slipping from the moorings at Clovelly had been westerly force 6, but within an hour it had increased to force 8 and had veered slightly to west by north. The tide was in the third hour of flood and was setting the lifeboat back by about 1 knot, while the wind and sea

accounted for another reduction of about $1\frac{1}{2}$ knots. Thus, at full speed, the lifeboat was making good over the ground about $8\frac{1}{2}$ knots.

Various messages were exchanged with the trawler, through Hartland Coastguard, until at 0435, when six miles west south west of South Lundy, 70-001 sighted a red flare from *St. Pierre* just forward of her starboard beam. She altered course towards it. Quarter of an hour later another red flare from the trawler was sighted and answered with a white parachute flare. Then 70-001 switched on her searchlight to show *St. Pierre* her position, at the same time making VHF contact with her.

At 0515 the lifeboat sighted the trawler. She was slightly smaller than 70-001, being 54' overall and of about 20 tons, registered. She was heading about north by east with the wind slightly forward of her port beam, and appeared still to have plenty of freeboard and not to be in any immediate danger of sinking.

By now the wind had reached force 10 to 11 and had veered slightly further to west north west accompanied by violent hail storms, and Staff Coxswain Houchen decided it would be a most hazardous operation for *St. Pierre's* crew if he attempted by any means to embark them in the lifeboat. With the object of trying to get the stricken trawler into the lee of Lundy Island, therefore, he prepared a tow, heaving-to while the lifeboat's mizzen was struck to get it out of the way.

At 0540, with the tow prepared, 70-001 approached *St. Pierre* from her weather side and Boat Mechanic Ivor Young

fired a rocket line. It was a perfect shot, falling right across the trawler, but her crew were not able to reach it quickly enough to lay hold of it and the line slid clear of the rigging to be lost over the side.

Staff Coxswain Houchen now appreciated that it was going to be difficult for the crew of the casualty to help, so he decided to make an approach on her lee side, as close as he dare go, and endeavour to throw a heaving line into the hands of the crew. He therefore passed across *St. Pierre's* bow, turned starboard and approached directly upwind on to her starboard quarter. Although this would make the throwing of the heaving line a Herculean task, it was the only prudent and seamanlike approach with the lifeboat, having a higher profile, making more leeway than the trawler.

At the last moment it was realised that the crew of *St. Pierre* were not ready to receive the tow line, and so the approach had to be cut off and made all over again. As the lifeboat turned away and lay off while awaiting preparations on board the casualty, the crew noticed that when both boats were in troughs of the very heavy seas *St. Pierre* was completely disappearing.

At 0600, 70-001 approached again. With first-class ship handling Staff Coxswain Houchen brought her bows to within a few feet of *St. Pierre's* quarter and, with both boats ranging a good twenty or more feet, Fleet Mechanic Peter Crofts threw the heaving line hard into the wind; the waiting crew of *St. Pierre* had no difficulty in catching it. A warp (70 fathoms of $4\frac{1}{2}$ "

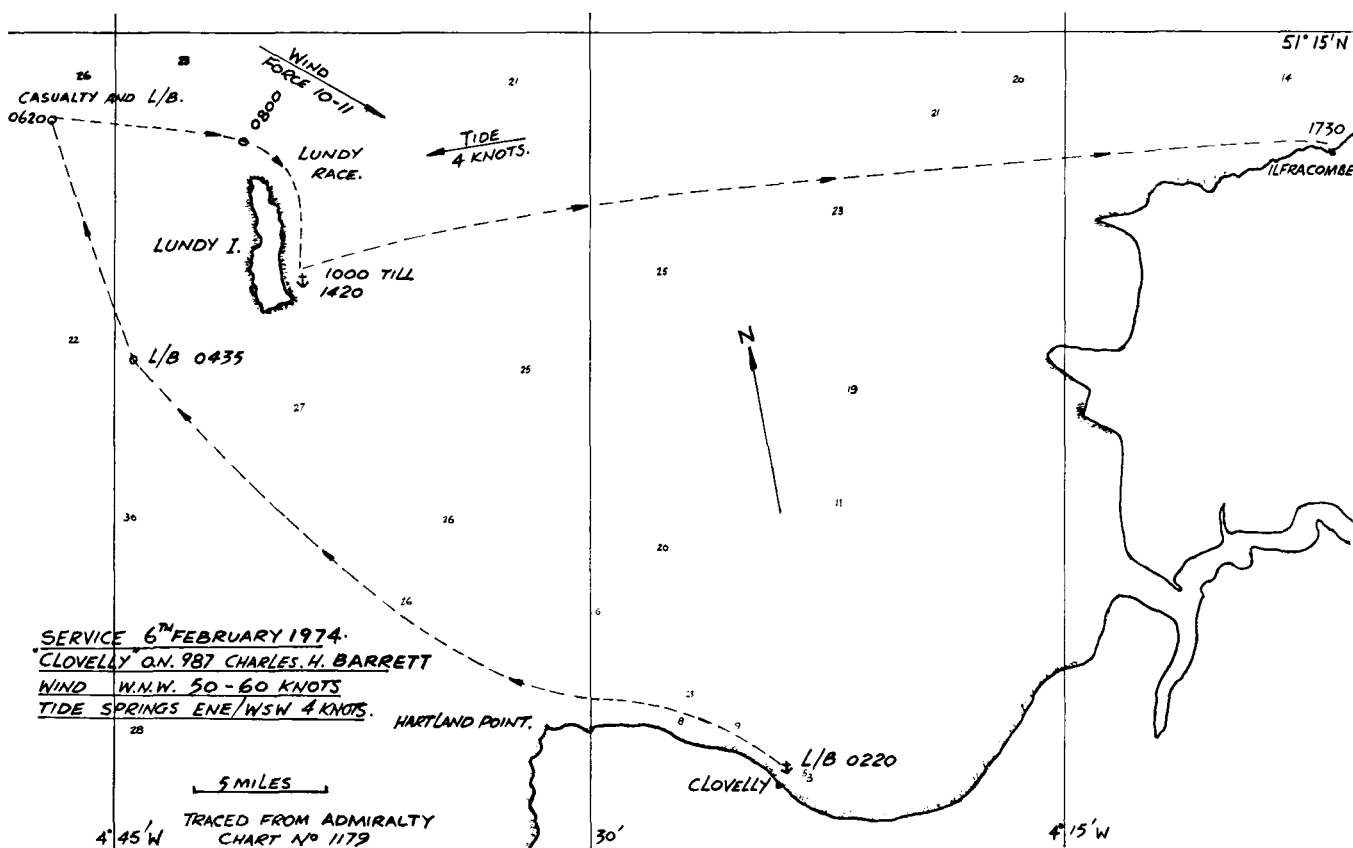

nylon) was now passed and the long tow began at 0620, making good about 4 knots.

Lundy lay about eight miles to the east south east and so course was set to pass round the north end of the island. The tide had turned by this time and was starting to run against the wind. *St. Pierre* had lost the use of her engines, but did not appear to be making a large amount of water although her crew reported that she was leaking.

All went without incident until about 0800 when the tow entered the northern fringe of the Lundy Race. Here the tide was now setting about 4 knots against the wind, which was still blowing force 10 to 11; the combined result was a phenomenal sea. The waves were high and precipitous, about 40' with very steep sides, so that at times Staff Coxswain Houchen was actually standing with his feet on the forward bulkhead of the wheelhouse as he tried to steer 70-001 down the face of a wave. Huge, vicious seas stove in the transom of the trawler and one wave broke completely across the lifeboat from port quarter to starboard bow so that jets of water spurted through the top of the wheelhouse door and soaked all within. The lifeboat crew believe that it was only their tow which saved them from broaching-to and, likewise, the lifeboat's pull on the bows of the trawler that held *St. Pierre* from a similar fate. The staff coxswain said that had the tow parted at this point, it would have been the end for the trawler and her crew because he would have been powerless to save them.

However, the tow held and the lee side of Lundy was reached by about 1000. Anchor was let go in Lundy Roads and at 1030 *St. Pierre* was brought alongside for pumping. By 1330 she was about 75 per cent pumped out and it was then discovered that the hose connections for the salvage pump suction hose were in fact leaking air, so that suction was impaired.

The wind had now moderated to about force 8 west north west and, the BBC TV weather forecast and synoptic chart having been seen on the lifeboat's new TV set, Staff Coxswain Houchen decided that it would be possible to continue to Ilfracombe with the tow.

Anchor was weighed and the tow got under way at 1420, arriving at Ilfracombe without further incident at about 1700. *St. Pierre* was towed to within heaving line distance of the jetty and the tow was slipped at 1715, both boats being secured alongside by 1730.

At 1825, however, 70-001 having parted two mooring lines, lost one fender and damaged the rubber D fender belting, Staff Coxswain Houchen decided to leave and return to anchor off Lundy once again to shelter from the now north west gale which was still force 8 gusting 9.

For this service a bronze medal for gallantry was awarded to Staff Coxswain Michael Houchen. Medal service certificates were presented to Boat

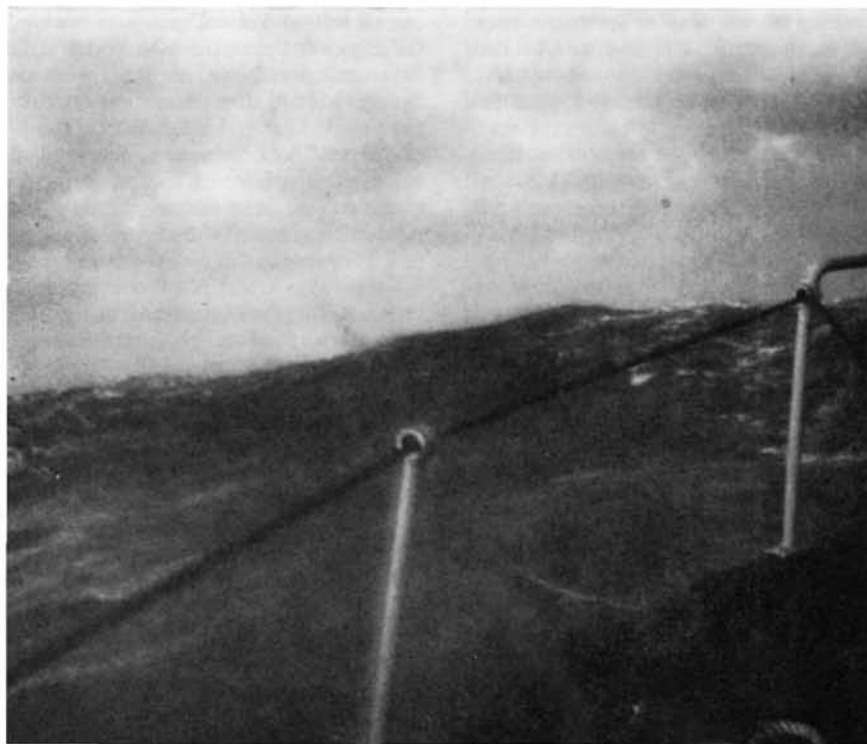

From deck of 70-001 as, shortly after dawn on February 6, she and St. Pierre approached race off north of Lundy: wind, force 10 to 11, tide setting about 4 knots against wind. As 70-001 begins descent down front of wave, tow line, almost bar taut and horizontal, is seen disappearing into crest. St. Pierre's rigging is just discernible above wave.

photograph and note by courtesy of John Leech

Mechanics Ivor Young and John Leech, Fleet Mechanic Peter Crofts and Assistant Mechanic Peter Braund.

North Eastern Division

Tug on rocks

AN ENGINE breakdown just as she had cast off her tugs on her final trials resulted in the oil exploration vessel *Oregis* going aground at the entrance to the Tyne. It was 1530 on Sunday, March 10. Tynemouth honorary secretary was told of the incident by HM Coastguard, but advised that lifeboat help was not required.

One of the ILB crew saw the grounding and went to the boathouse in anticipation of a possible call-out. There he found another member of the crew and they cleared the boathouse doors in readiness.

Three tugs returned to help *Oregis*. One, *Northsider*, was seen by the two ILB crew, Trevor Fryer and Frederick Arkley, to run towards the casualty to pass a line; but, pooped by a large sea, she was driven past *Oregis* on to the rocks. Although it was clear to the two ILB crew that there was little they could do for *Oregis*, they considered that the tug was now in a dangerous position. So, while Fred Arkley telephoned the honorary secretary, Trevor Fryer prepared the ILB, and at 1543, with Trevor Fryer at the helm, she launched. With breaking seas and a 4' rise and fall, it was a most difficult operation. The wind was easterly force 6 with a rough sea

and heavy swell; it was one hour before high water.

The ILB motored outside the Black Midden Rocks to assess the situation. The tug, well ashore on the rock end, rolling heavily and continually swept by the seas, was being driven further ashore and her position was potentially dangerous. Her crew indicated that they would like the ILB to close them; they had a young boy aboard and wanted him taken off. The ILB circled *Northsider* three times, observing the action of the sea and the rolling of the tug, before going alongside. It was a daunting prospect, with heavy swell breaking over the stern of the tug and heavy seas breaking on the rocks.

Running in on these seas and turning alongside required great boat-handling skill and judgement; both were shown by Helmsman Fryer. Not only did he have to contend with the sea; there was also the risk of the ILB being driven under by the heavy fendering of the tug.

The boy was passed down to the ILB successfully and taken back to the slipway where Fleet Mechanic Davies helped him ashore; the boy was almost swept off the end of the slip but Alan Davies managed to hold him.

It was now 1557 and maroons had been fired, and by the time the ILB returned to the scene of the incident the lifeboat, launched at 1610, was already helping.

At 1625 the tug *Alnmouth* told the ILB that the crew of the stranded *Northsider* had asked to be taken off immediately. She was now well in under the cliffs, rolling heavily with seas

breaking all the way in from the rock end to the cliffs, and she was in real danger of breaking up.

Timing their approach, two attempts were made at running in before the seas, but at the third attempt the right combination was achieved; the ILB went alongside and took the three crew off the tug.

The ILB weathered some very heavy buffeting on the run out and, on the advice of the coxswain of the station lifeboat, put the survivors aboard a police launch; it was 1635. She remained in the area ready to give further help until the engine showed signs of faltering, probably due to the severe drenching it had undergone, when she returned to station, arriving at 1725.

For this service the bronze medal for gallantry was awarded to Helmsman Trevor Fryer and Crew Member Frederick Arkley.

over 9 knots. *Netta Croan* was burning fiercely over the whole after end and 12 crew members were on the forecandle head unable to stop the engines or steer the vessel. The rig tender *Smit Lloyd 47* and the BEA S61 rescue helicopter had been with the burning trawler for some time but had been unable to effect any rescue because of the flames and the erratic course.

Coxswain Albert Bird continued to chase *Netta Croan* without being able to catch her, but as she started to circle to starboard the opportunity was taken to cut across her turning circle and close her starboard side. On the near approach to the casualty Coxswain Bird handed over the wheel to Mechanic Ian Jack, a man experienced in closing moving vessels after several years on the pilot boat, and stationed himself at the port wheelhouse door where he could see both the casualty and the helmsman.

Hilton Briggs was taken alongside the forward end of the main deck still at full speed and all survivors were taken off and the lifeboat cleared, all within one minute. It was about 2300. This operation was helped by the helicopter flying overhead and illuminating *Netta Croan* throughout.

During this whole manoeuvre, carried out at speed, *Hilton Briggs* was in very real danger from the flames, the possibility of exploding fuel tanks and the possibility of the trawler sheering and putting the lifeboat under her bows.

It was now established that a further crew member had some time previously attempted to jump into a liferaft towed astern of *Netta Croan* and had slipped into the water. A search was mounted but it was broken off to land the survivors at Aberdeen at 2330. The lifeboat returned and searched until 0200, and returned to station at 0300.

For this service a bronze medal for gallantry was awarded to Coxswain Albert Bird and Motor Mechanic Ian Jack. The thanks of the Institution inscribed on vellum were accorded to Assistant Mechanic George Walker and Crew Members F. Cruickshank and A. Walker.



A thank you for Aberdeen crew from men taken from burning *Netta Croan*.

Photograph by courtesy of the 'Daily Express'.

Aberdeen lifeboat Service 13th April 1974.

ON 889 'Hilton Briggs'. (rescued 12)

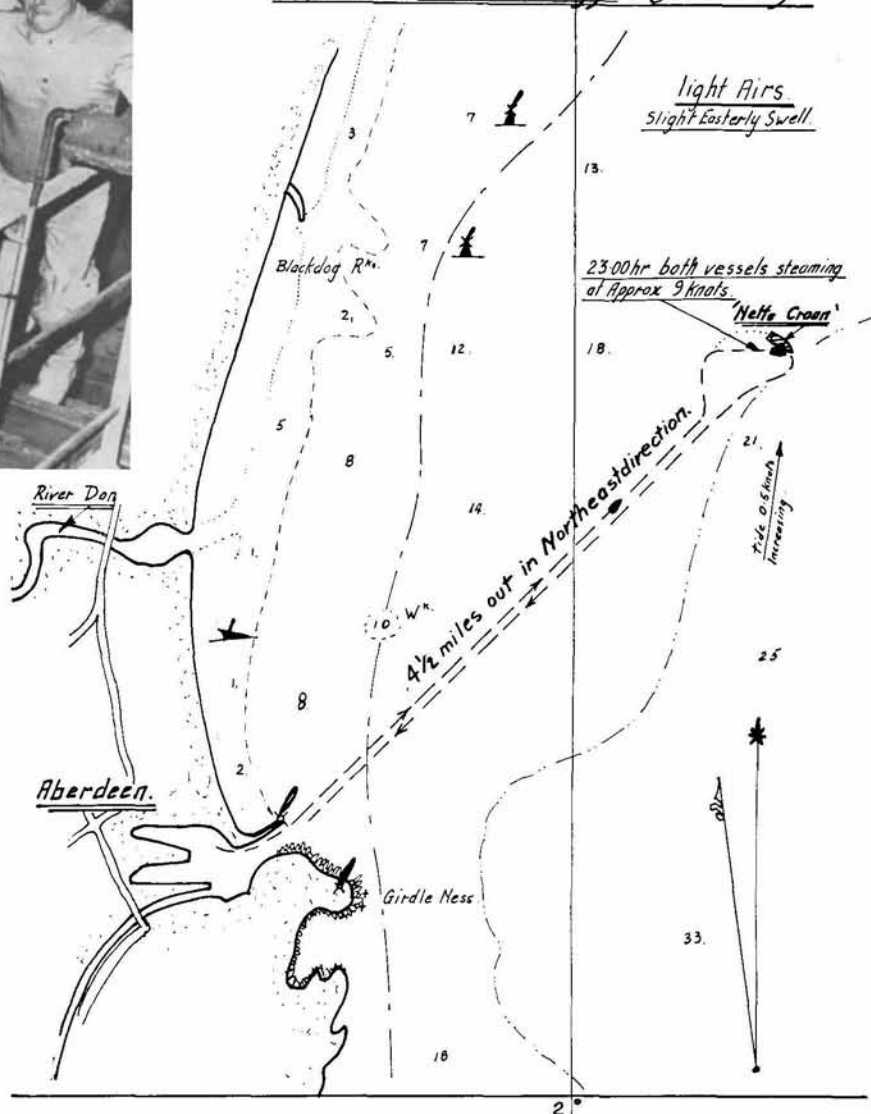

Scotland Northern Division

Fire at sea

A TRAWLER on fire, not under control, but under way about four miles north east of Aberdeen: that was the message received from HM Coastguard at 2055 on Saturday, April 13, by the honorary secretary, Aberdeen. The crew were called by telephone and at 2130 the reserve lifeboat *Hilton Briggs*, a 52' Barnett built in 1951, slipped her mooring. The weather was fine with a slight haze, there was little or no wind and a low easterly swell. It was 2½ hours after high water.

The lifeboat arrived in the vicinity of the trawler, *Netta Croan*, within half an hour, but was unable to catch her as she was sailing an erratic course at

South Western Division

Leap overboard

TORQUAY POLICE informed Brixham Coastguard at 1537 on October 5, 1973, that a girl was in the water off Meadfoot Beach and asked for the help of the ILB. The message was passed to Torbay deputy launching authority, the maroons were fired at 1540 and the ILB slipped her moorings ten minutes later manned by Coxswain Kenneth Gibbs and Station Mechanic Barry Pike.

The wind was south south east force 7 and the tide was in the third hour of ebb. Visibility was good and the weather fine, but the wind was steadily freshening and the ILB encountered rough seas by the time she was half way across the bay.

A radio conversation with Brixham Coastguard on the way over had given the ILB crew the distinct impression that there was every hope of saving the girl. It was extremely frustrating for them, therefore, when they reached the Meadfoot Beach area (within eight minutes) to find that sea conditions prevented the ILB from being taken close inshore where the casualty was thought to be. Very large waves were now breaking among masses of loose seaweed, and the bottom at that point is treacherously rocky; the 8' breaking waves would have smashed the boat on to the rocks immediately. As it was, Coxswain Gibbs needed all his skill to hold the boat into the breakers just on the edge of the minimum depth to avoid the rocks as the ILB began her search.

A number of people had gathered along the top of the sea wall, at the foot of which was a policeman directing the boat to the approximate position of the casualty.

Suddenly, as the coxswain used his engines to negotiate an exceptionally large sea, Motor Mechanic Pike, standing in the stern and looking aft towards the beach, saw the body of a woman appear in the trough. She was just out of reach and, without a moment's hesitation or thought for his own safety, he leaped overboard. The coxswain saw this with horror as he glanced quickly over his shoulder; he feared he might not be able to prevent the next wave from hurling the boat back on top of Barry Pike and the casualty.

Barry Pike almost succeeded in getting hold of the woman, but, though he swam as hard as he could with the encumbrance of his full clothing and life-jacket, he was slowly overcome by the waves breaking over him and the entangling seaweed. As he was at last thrown on to the shore and then dragged out again by the undertow, the policeman managed to grab him and pull him clear of the pounding surf. The constable reported that, even at this stage, Barry Pike was already in an overcome condition, having taken in much sea water.

He would not rest longer than was essential to regain his breath, however,

insisting on going back into the water to try to bring the woman ashore. She was now floating face down about 10 yards off the beach, with the ILB being held head-to-sea just beyond her.

The beach is steep, and so Barry Pike was soon out of his depth and again struggling against the huge breakers and the dense seaweed. Once more he lost the battle and was driven back to the beach.

Three or four times Barry Pike threw himself back into the sea, in a steadily weakening condition, before he finally managed to grasp and hold on to the woman. Fortunately, before he went into the water the last time, the policeman had secured a line to him, otherwise it is probable that he himself would have succumbed before he could have got back to shore.

As it was, rescuer and victim were hauled ashore together and the exhausted Barry Pike collapsed beside the body of the woman on the ramp by the sea wall. He was barely conscious and recalls opening his eyes to see the silver braid of a superintendent of police leaning over him and anxiously enquiring whether he was all right. Then he learned that the woman had been found to have a severe head injury and had, in fact, been dead from the beginning.

For this service a silver medal for gallantry was awarded to Motor Mechanic Barry Pike and the thanks of the institution inscribed on vellum to Coxswain Kenneth Gibbs.

Eastern Division

Yacht in shoal water

RED FLARES were sighted to seaward south of the harbour by Lowestoft Coastguard on the morning of April 13. The honorary secretary, informed at 0448, gave instructions for maroons to be fired and the reserve lifeboat *Canadian Pacific*, a 46' Watson built in 1938, slipped her mooring at 0511 and set off at full speed on a southerly course. The wind was north east force 5 to 7 and the weather cloudy with showers. High water at Lowestoft was predicted at 0213.

At 0514 more red flares were sighted on a bearing of 195°M, about five miles away. Some 20 minutes later the 41' Bermudan-rigged yacht *Sarina* was sighted five cables east of Benacre Ness. The lifeboat closed the yacht at 0548 and attempted to go alongside. *Sarina* was lying head to tide, at anchor, and touching bottom in the breaking seas. Sails had been roughly furled but the main was causing considerable windage where it had blown away from the ties. The crew of two men and two women were all exhausted.

The wind was now north east, force 6 to 7 with 13' breaking waves caused

by wind against tide. It was still cloudy with frequent showers.

At this point it was noticed that the lifeboat port engine was only operating at 500 rpm and Coxswain Thomas Knott assumed that the propeller had fouled in the shallow water. In order to go alongside, *Canadian Pacific* was taken to westward of the yacht and, turning to port, a downwind approach was made during which the lifeboat took the ground twice.

Coxswain Knott stationed Second Coxswain Peter Gibbons at the bow and instructed him to board *Sarina* as soon as possible. As the boats closed, a large sea lifted the lifeboat and rolled the yacht to port and Coxswain Knott thought he might have struck the yacht's bow. He put both engines full astern and as the lifeboat moved clear Peter Gibbons jumped across the 6' separating the two boats.

Second Coxswain Gibbons was told by *Sarina's* crew that while on passage from Dover to Great Yarmouth in freshening winds the yacht had been anchored one mile off the shore; as the wind increased the anchor dragged, since it was only on 40 fathoms of rope. The main anchor chain was then secured to the rope and all 100 fathoms of chain paid out. Second Coxswain Gibbons tried to cut the chain with a hacksaw, but when the blade broke he asked the lifeboat to close the yacht again and he parted the chain with the axe. He then secured a towline from the lifeboat's bow to the yacht's rudder head. The yacht was fitted with an auxiliary engine but this was broken down.

The towline was secured at 0615 and *Canadian Pacific* went astern towing *Sarina* stern first south south east to deeper water. The lifeboat cockpit was continually filled with water and, as the yacht's cabin hatch could not be closed, the speed of tow had to be kept very low.

At 0635 the lifeboat moved ahead of the yacht, Second Coxswain Gibbons transferred the towline and re-secured around the mast and forward cleats, and Coxswain Knott set course for Lowestoft Harbour, arriving at 0723. The lifeboat took *Sarina* to a secure mooring in Hamilton Dock before returning to her berth at 0800.

For this service the bronze medal for gallantry was awarded to Coxswain/Mechanic Thomas Knott and Second Coxswain Peter Gibbons. Medal service certificates were presented to Assistant Mechanic J. Stoddard and Crew Members W. Leith, R. O'Halleron and F. White.

South Western Division

Disabled fishing boat

TORBAY LIFEBOAT *Princess Alexandra of Kent*, a 52' Barnett class built in 1958, slipped her moorings at 1950 on

December 16, 1973, in response to a mayday call received by Berry Head Coastguard from the Norwegian vessel *Buenavista*. She was standing by the overdue Guernsey fishing vessel *Petit Michel* 200° 32 miles from Portland Bill, 38 miles from Torbay. She had launched her own lifeboat in an attempt to take off the sole occupant but was unable to do so because of the state of the weather.

The wind was west south west force 3 to 4 at the time of the lifeboat's departure, but it was freshening and within an hour the sea was becoming rough as the tidal set was directly against the wind.

At 2245 the lifeboat established communication with *Buenavista* and Wyke Coastguard on 2182. The wind was still freshening and had now reached force 6 to 7. At about 2340, when some 10 miles from the casualty, Coxswain Kenneth Gibbs saw the loom of lights from *Buenavista* and was able to home-in on these, arriving at 0045. The wind, now force 8 to 9, had veered to west north west.

The disabled boat was lying starboard beam to the wind, bows south, with *Buenavista* lying off to leeward and playing a searchlight on her. The lifeboat further illuminated the scene with parachute flares as she crossed under *Petit Michel's* stern and surveyed her leeward side.

Coxswain Gibbs decided that he would have better control of the situation with less chance of collision of the superstructures of the two vessels if he approached *Petit Michel's* windward side. So he passed around her stern and came up on her starboard bow with two heaving lines ready.

One heaving line was used to pass a lifejacket to the man aboard the casualty. The lifeboat crew shouted instructions for him to put it on and to secure the heaving line to himself, and then to secure the other heaving line to the end of a wire cable which he had laid out on deck for towing.

Coxswain Gibbs ordered storm oil to be sprayed as he made his circuit and went alongside and reports that it was very effective in reducing the wave crests. He kept his starboard engine running ahead and his port engine going astern as he came up to the fishing boat's bow, and says that this gave him positive and steady control of his boat throughout the final approach.

Such were Coxswain Gibbs' skill and seamanship that, in spite of the very heavy seas running and the violent rolling of the two boats as they lay beam to sea, the survivor was able to jump and be pulled safely aboard the lifeboat on the first attempt. The coxswain then went full astern taking the fishing boat's wire with him. It was secured to the lifeboat's nylon rope for towing, but as soon as the lifeboat tried to begin the tow and the strain came on the wire it pulled away from on board *Petit Michel*.

The weather was too bad to try to

A sick keeper is winched off Fastnet Rock into waiting hands (below) of Coxswain C. Collins and the young crew of Baltimore lifeboat, Sarah Tilson. March 20: wind and sea moderate. photographs by courtesy of 'The Cork Examiner'

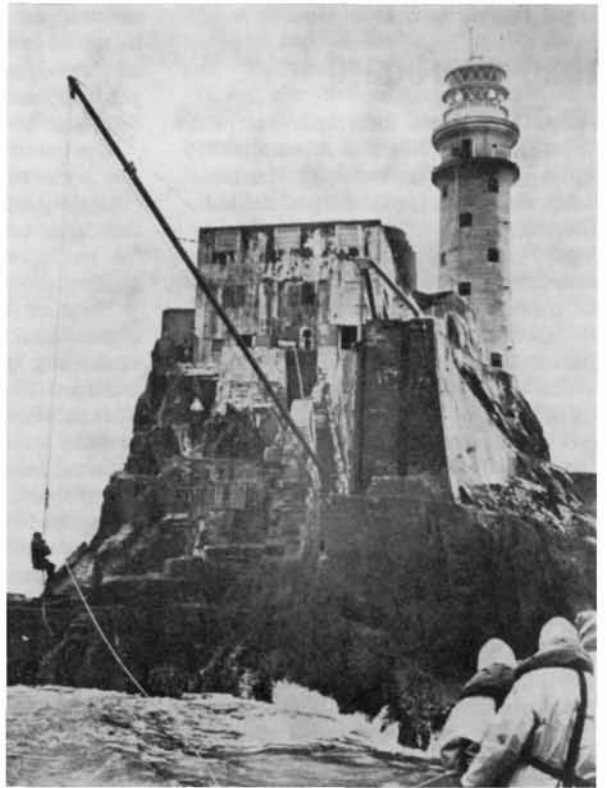

put a crew member aboard to re-secure the tow, and so *Petit Michel* was abandoned and the lifeboat set course for station. The voyage home was uneventful and the lifeboat returned to her moorings at 0700.

For this service the bronze medal for gallantry was awarded to Coxswain Kenneth Gibbs. Medal service certificates were presented to Motor Mechanic Barry Pike, Assistant Mechanic Stephan Bower and Crew Members M. Kingston, M. Davies, P. Burrige and J. Huskin.

North Western Division MFV helps MFV

WHILE MFVS *Welsh Lady II*, *Barragutt* and *Rossina* were fishing about a mile off Towyn at about 1630 on January 16,

the light south westerly wind turned to strong north westerly gusting to force 9 as the storm passed over. *Welsh Lady* and *Rossina* pulled in their nets but *Barragutt*, unable to follow suit, abandoned hers and all three boats, setting a south-easterly course, made all possible speed towards Foryd Harbour in strong following winds and a rapidly increasing sea. Visibility was poor in driving rain and spray.

The entrance to Foryd Harbour is marked by seven perches, numbered 1 to 7 from landwards, with the channel close to their west. Perches 1 to 5 are on top of a training wall; perches 6 and 7, at the outer end, show where the training wall, now breached and derelict, used to be. A sand bar runs east-west to seaward of perch 7, and there is a second sand bar between perches 4 and 5 and almost up to the training wall; the navigation channel at this point is only 10 to 15 yards wide, close up to the training wall. With strong north-west to north-east winds the seas over these bars are soon whipped up and become short, steep, very confused and boiling. The sea area between perches 5 and 7, although rough and confused, is not so bad as that covering the bars, and the sea area from the harbour entrance to perch 4 is fairly sheltered and calm.

On approaching perch 7 *Welsh Lady's* engine began to overheat. Her skipper, John Povah, asked *Barragutt*, which was following astern, by radio to keep an eye on her as her engine might fail. In the seas at the bar there was constant fear of pooping and the possibility of broaching-to; the drogue was not being used.

Welsh Lady successfully navigated the channel and was within a few yards of
continued on page 229

Some Ways of Raising Money

Flag days have been beating all records in this 'Year of the Lifeboat'. Here are just a few results: On London lifeboat day, March 19, £69,355 was collected, nearly £9,000 more than in 1973. For the flag day of the little inland town of Ruthin in North Wales, one man, Reg Jones, collected no less than £104.87, and his daughter Susan yet another £18. Despite the fact that their flag day was on the same Saturday as the F.A. cup final, Shoreham beat their target figure of £700 by some £38. Emsworth, on July 13, achieved the fine result of £200.38. Tynemouth, with a flag week in March, passed last year's total by £300, collecting £977.

Flowers have played their part, too, in this anniversary year. The flower club

A replica of Greathead's 'Original' lifeboat made of flowers was used by Lowestoft ladies' guild at the RNLI anniversary ball and Church service in March. The guild raises over £3,000 annually for branch funds.

photograph by courtesy of R. W. Moore



and ladies' guild in Scarborough combined to present a three-day festival of flowers in St Mary's Church; the 53 arrangements were all linked to historical aspects of the lifeboat service, and a total profit of £700 was achieved. Well over 1,000 people visited the three-day festival of flowers held during July at Hyde Chapel, Gee Cross, Hyde, which ended with a service of thanksgiving on the Sunday evening; with this special effort Hyde branch raised £450.

Top marks for a new idea from the senior class of Harris County Primary School, Fulwood, Lancashire; they organised a sponsored spell, raising £20.20 for the Fulwood and Broughton branch—and no doubt doing their spelling a power of good!

From the Goodwins Sands and Downs branch comes news of a considerable feat achieved by the ladies' sewing guild, known as the Wednesday Club of Deal; £500 towards the cost of a bulldozer for Walmer lifeboat station was raised by a knitting contest.

J. S. Andrews and his family, of Tarbert, Argyll, wanted to do something special for 'The Year of the Lifeboat'. So, while cruising off the west of Scotland in their 9-metre catamaran *Aku-Aku* in July, rather than just



Prizewinners in Skelton and District schools art competition, held during a fund-raising campaign, went to sea with Redcar lifeboat on June 15. (Left to right) Andrew Bodinner, 11, Amanda Green, 10, Joy Parkin, 8, and Anthony Treen, 11.

making a round donation, they put small amounts in the lifeboat box on board whenever they sighted things of interest or had out-of-the-ordinary experiences. Multihulls sighted, odd birds and sea creatures rated 5p; foreign or unusual yachts twice that; gales at

Aerial view of a 52' Barnett? No, a close-up detail of a working model made by R. Sellwood of Reading and District branch. It took 3,000 hours to build and is used to raise funds, both at shows and in the Reading garage where Mr Sellwood works. So far it has brought in over £50.

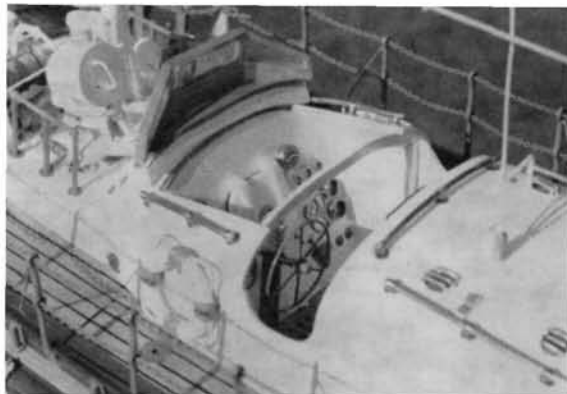

From St Albans and District comes news of the opening in July of Salisbury Hall by its owner, Walter Goldsmith, in aid of the RNLI. In foreground (below) two of display of five lifeboat models made by John Gilbert, and a doll raffle prize dressed by Mrs Sheila Crouch. Over £70 was made by the event.

photograph by courtesy of 'Herts Advertiser'





A lifeboat queen . . . : 16-year-old Jane Wilson was crowned by Ronnie Hilton at Flamborough ladies' guild gala in July. With her are three of her attendants, Pat Wilkinson and Bridget and Andrea Waud; the fourth attendant, Stephanie Robertson, was further to the left. Pageboy Jeremy Waud bore the crown.

photograph by courtesy of Bridlington Free Press



A happy 'lifeboat' crew! Maylands Infants' class 6 (4½ to five years) adopted the RNLI as their project for a term. They organised a raffle, a fair, a sponsored walk round the playground and even composed a song. £160 was donated to Boxmoor and Hemel Hempstead branch.

photograph by courtesy of 'Watford Evening Echo'



. . . and a lifeboat princess: seven-year-old Alison West sold 38,500 penny tickets to win the title in a competition organised by Seaton and Beer branch. Eight girls took part and achieved an amazing £568. The honorary secretary's husband, Captain Roy Harding, trials officer RNLI, crowned Alison on Beer seafront in June; she will take part in lifeboat events throughout the year.

Window display shown during RNLI-Observer exhibition at Rooms Store, Upminster, June 7 to 22. Upminster branch, manning a souvenir stall, collected £187.



anchor and square-rigged ships were more again; a gale under way or a lifeboat rated very high, and a small coin was put in for every lighthouse passed. Finally, £2 for a safe and happy return home—and £1 fine for failing to be back in Tarbet for lifeboat day! It all added up to £12.20.

East Grinstead branch held their first ball, to commemorate the 150th anniversary of the RNLI, at Worth Abbey in May. It was an evening much enjoyed and, with the help of local traders who gave 400 valuable prizes for the tombola, a grand profit was made of £1,216.82.

The RNLI is greatly indebted to a large number of people who make great individual efforts: people like Mrs M. Merry, of Wolverhampton, who has made 1,500 knitted rabbits, which sell for about £1 each; and Ellis Jones who, selling RNLI souvenirs in his small, but busy, fish and chip shop in Criccieth, made over £550 in 1973 and had passed £400 by July this year; or 76-year-old Mrs Catherine Edwardson, a member

of Tynemouth ladies' guild, whose coffee mornings have raised more than £1,000—this year, with the regular sale of home-made toffee and shortbread and a coffee morning in July, she has raised £200; and Mrs D. Davison, of Worthing ladies' guild, who set herself an 150th anniversary target of £300, and reached it within six months.

Pewsey Zixex Club, Wiltshire, are great supporters of the local RNLI branch, and in four recent sponsored rows have raised nearly £500 for lifeboat funds. In April they set out to break the existing record of 47 hours for the 112 miles from Pewsey to Westminster. This marathon, which not only meant rowing, but also 26 portages and the navigation of 40 locks, was completed in 34½ hours non-stop (except for meal breaks) and a grand total of £200 was raised.

Another marathon row, round the London waterways, was undertaken in a whaler by four crews from Red Watch, Paddington Fire Station. Setting off at midnight on Friday, May 24, the whaler arrived alongside the RNLI stand at the Boat Afloat Show in Little Venice at 1630 on Saturday, May 25, bang on time after some 48 miles, 23 locks and two tunnels. When the outboard engine of the escort boat, obligatory for the navigation of the two tunnels on the final stage, broke down, the ILB on show at Little Venice was despatched for escort duty. The row was in aid of both the RNLI and the Multiple Sclerosis Society, and the RNLI received a cheque for £1,500; the money came solely from the sale of 10p programmes and donations received.

Two more sponsored rows, about which more details will be given in our next issue, have been undertaken by lifeboatmen: one by the crew and launchers at Walton and Frinton, and the other, round the Isle of Wight, by members of Lymington ILB station.

Undeterred by 'typical lifeboat weather', 100 people completed a 10-mile sponsored walk arranged by Sutton Coldfield ladies' guild and raised £688; two dogs were among those sponsored and they certainly helped to keep the pace up. Another sponsored walk was planned by Anne Sutherland, daughter of the honorary secretary of Herne Bay branch; she and 11 of her young friends walked 10 miles as their own special effort for the year, and thereby added no less than £70 to the branch account.

Hair-growing can be sponsored, too. Eion MacGregor, landlord of the Green Man, Great Braxted, Essex, grew his hair for six months for the RNLI; there was a grand ceremony in the saloon bar when his locks were lopped off, and £260 was credited to Witham and District branch. After a sponsored beard-grow by six 'regulars' of the Inn Place, Bickington, North Devon, the landlord, Barry Grover, presented a tankard containing £311 to Captain Lowry, chairman of the Appledore branch, for Appledore lifeboat.

Mike Pilkington, a committee member of Frodsham branch, Cheshire, took part in the novelty section of the Blackpool-Isle of Man race. He entered a three-piece suite, complete with television set, mounted on two pontoon floats. Winning first prize, he donated £100 to his branch funds.

Pupils of Southlands Comprehensive School, New Romney, Kent, supported by members of staff, hold a fete each year in aid of different charities. The RNLI was chosen for this 'Year of the Lifeboat' and £237.27 was donated to the local branch.

Good Friends

Barclays Bank International and the RNLI, both relative newcomers to Poole, are now near neighbours. In June Barclays International made a most generous donation of £1,000 to the Mayor of Poole's lifeboat fund, launched to provide money towards Poole's new 44' Waveney lifeboat.

From an old friend, Schermuly and Pains-Wessex, has come a welcome cheque for £1,200, raised over two seasons by a royalty scheme whereby a percentage of the profit on every set of yacht distress flare packs sold by the company was donated to the RNLI.

Bacofoil Promotion

Aluminium Foils Ltd are staging a new promotion with the aim of providing an ILB. Over a period in early autumn, for every Bacofoil pack end sent in by the public a donation of 5p will be made to the RNLI. All those who send the pack ends in will receive an attractive wall chart with pictures of famous British ships.



Silver . . .

● A solid silver, partly gilt, lifeboat bowl is being made by Aurum Designs in conjunction with the RNLI to commemorate the 150th anniversary. A



frame of deeply embossed, stylised storm waves encircles a scene in high relief, chosen as a tribute to Sir William Hillary, showing the *St George* rescue at Douglas, Isle of Man, in 1830. Ian Ribbons (left), who sculptured the scene, himself visited Douglas and also did thorough historical research to ensure the accuracy of his work.

The bowl weighs 11 oz (10 oz Troy), is 1¼" high and 7½" diameter. Only 750 are being made and the RNLI will receive a donation for each one sold. Some are still available. Order forms can be obtained from RNLI, 21 Ebury Street, London SW1W 0LD. Price £116 each or £230 a pair.

. . . and Porcelain

● Worcester Royal Porcelain are producing two pieces to commemorate the 150th anniversary of the RNLI. The 8" vase (right), in a limited edition of 150, is bone china decorated in cobalt blue and gold. The obverse depicts in sepia monochrome a lifeboat rescue off the mouth of the Tyne in 1864. The handles, foot and knob of the cover are illuminated in pure 22 carat gold.

The 10" plate (below) is limited to 500. It is bone china with a cobalt blue rim illuminated in 22 carat gold, and the centre design features the same Tyne-mouth rescue.

The vase costs £69.56, the plate £34.14. Both are supplied in silk-lined presentation boxes. The RNLI will receive a donation for each one sold. Descriptive leaflet and order form from: RNLI, 21 Ebury Street, London, SW1 0LD.



BOOK REVIEWS

● A. F. Humble's **The Rowing Life-Boats of Whitby** (Horne and Son, Whitby, £1.63—including postage), has been produced with much scholarship and care. Mr Humble, who is acting librarian of the Whitby Literary and Philosophical Society, is himself a descendant of a boat builder who showed a model of a lifeboat in the Great Exhibition of 1851.

In relating the early history of the Whitby station, A. F. Humble emphasizes the importance of the fact that so many people on the north east coast of England had actually seen ships being wrecked with no means of saving the survivors. He also calls attention to the spirit of independence which has characterised Whitby committees and crews. This caused them to resist firmly attempts made by the Board of Trade to exercise some control over their station and also delayed the ultimate union of the Whitby station with the RNLI.

Much of the book is understandably devoted to the disasters of 1861 and 1877, to their consequences and to the problems of providing relief for widows and orphans.

The administration of the disaster funds, which were wholly outside the control of the RNLI, was the subject of a recent play by Peter Terson which caused something of a stir. The central character in Mr Terson's play was Francis Haydn Williams, an eccentric open-air preacher who readily indulged in litigation and abuse. Williams' charges that the relief funds were maladministered provided the substance of the play. Mr Humble rather

surprisingly does not mention Mr Terson's play, but he has little doubt about the veracity of Williams:

'In the face of so long a series of errors and blunders', he writes, 'it is impossible to accept any statement by Williams, unless it is supported by reliable independent evidence.'

'As far as the Life-boat Relief Funds are concerned, no such evidence has been found.'

'The published abstracts of accounts indicate that all the funds were honestly administered; in a ten-year campaign of calumny and invective Williams completely failed to prove anything to the contrary.'

—P.H.

● Many different disciplines contribute their skills and wisdom to the common cause of saving life at sea, not least among them medicine, and the RNLI has been fortunate that for many years it has been able to count as its medical adviser Dr Geoffrey Hale, MBE. A near neighbour, practising as a GP in Pimlico, he has given unstinted help both with committee work and in the practical testing of ideas and equipment. He has served on the medical and survival committee, of which he is chairman, since 1952, and on the Committee of Management, of which he is a vice-president, since 1964. Now retired from general practice, Dr Hale together with co-author Nesta Roberts recalls a lifetime of medical advance in **A Doctor in Practice** (Routledge and Kegan Paul, £2.50). The reader will learn much of the development, and problems, of the profession during 40 years, revolutionary both in scientific knowledge and social administration; and members of the RNLI will also come to know more closely an old and trusted friend.—J.D.

● **Blue Peter Eleventh Book** (BBC, 70p) is sure to be a very popular children's present this Christmas—the sort of present the whole family enjoys on the quiet, too. It is packed with things to do, intriguing information, stories and such delightful illustrations as Hargreaves' portrayal of Michael Bond's Paddington bear. An article on the RNLI recalls not only the history of the lifeboat service, but also two incidents this year of particular interest to 'Blue Peter' viewers: Peter Purves'

360° ride in a Waveney lifeboat on self-righting trials, and the awards for gallantry made to the North Berwick crew of ILB *Blue Peter III*.—J.D.

● Another first-rate Christmas present, this time for offshore yachtsmen, is the fourth edition of **Channel Harbours and Anchorages** by K. Adlard Coles (Nautical Publishing Co., £5.75). It has been exhaustively revised and re-written to bring it up to date with navigational changes since previous editions, metric soundings are now used throughout, and a change has been made to the new Admiralty chart datum.

As a boat is in greatest potential danger when she leaves or approaches land, Adlard Coles' authoritative pilotage books should be on the bookshelf of every yacht on passage.

—J.D.

● Celebrating the 150th anniversary, three more booklet histories of stations have recently been published:

The Story of St David's Lifeboats by Desmond G. Hampson, assistant honorary secretary, and Dr George W. Middleton, chairman of St David's branch, includes photographs ranging from the station's first lifeboat and coxswain, 1869, to present-day helicopter and lifeboat exercises. From D. G. Hampson, The Pharmacy, Cross Square, St David's, Haverfordwest, Pembrokeshire, price 25p.

Isles of Scilly Lifeboats, a historical sketch book with a brief but factual text compiled by the local ladies' guild. From Mrs M. Soar, honorary secretary, Isles of Scilly ladies guild, 6 Harbour View, St Mary's, Isles of Scilly, price 25p (postage and packing 8p extra).

Fifty Years of Yarmouth I.W. Lifeboats by Geoffrey E. Cotton, a detailed history available at bookshops locally, through the ladies' guild of the Island or direct from the author, Rose Villa, Ommanney Road, Yarmouth, Isle of Wight, 50p (postage and packing 8p).

● Other than in Wales it is probable that few people are aware that Anglesey was the cradle of a hardy race of mariners or that ship building was a thriving industry in the little port of Amlwch. The fascinating maritime history of the island is told by Aled Eames in his book **Ships and Seamen of Anglesey**, published by the Anglesey Antiquarian Society (£3.50). It is sad to note that owing to the change in the boundaries there is no longer an Anglesey County Council to sponsor the remainder of the planned series, of which this is the fourth volume.

This is a splendid, scholarly book with meticulous documentation and a fine, seamanlike air which does justice to the courageous mariners whose activities are recorded, but does not hide the fact that there were some tendencies to indulge in profitable ventures which were not strictly legal.

The tiny vessels which sailed from

Ship Halfpennies

The RNLI has a plan for raising money through export, for a particular purpose, of ship halfpennies. Its success must depend on the number of halfpennies collected. Anyone who is interested is asked to write to:

Captain C. C. Lowry, RN,
Buckleigh House,
Westward Ho!
Bideford, North Devon,

not later than October 31, stating approximately how many halfpennies he or she may be able to provide.

little ports like Amlwch and Cemaes carried all sorts of cargo to all sorts of places, including copper ore from the local mines to Swansea and St Helens, and later found ready employment in the slate trade. The appalling conditions in which emigrants to America were carried, stowed amongst the slates, must have been almost unbearable and many of the hopeful passengers had already travelled from Ireland to

Liverpool in cattle boats at a fare of 1s or 1s 6p a head.

Of considerable interest to lifeboat supporters and enthusiasts is the chapter on Anglesey wrecks and rescues, particularly the boundless energy and sterling work of James Williams and his wife Frances, who were the mainstay of the Anglesey Association for the Preservation of Life from Shipwreck. James Williams was an active participant

in rescues and was awarded the Institution's gold medal, continuing his support after the RNLI assumed responsibility for the Anglesey lifeboats.

Here is a moving saga of a little known aspect of sea life and times and, strictly on the basis of value for money, a very good buy. Both as compelling reading and as a very fully indexed book of reference it is an important volume for the shelves of a sea library.—E.W.M.

Shoreline Section

WITH LITTLE publicity, Shoreline is now making a major contribution to the Institution's funds and it is hoped that this year enough will be raised to pay

the cost of an offshore lifeboat.

Membership is now well over 18,000 and about 100 new members are enrolled every week. With everybody's help, where would we set the limit?

We are now recruiting help from many of the branches and guilds. So far, however, information about Shoreline has not spread as rapidly as it might. There must be many people who would like to help the RNLI, who do not have enough time to take part in local activities, but who would be happy to join Shoreline.

Everyone who joins is credited to the branch or guild that recruits the member, not just for the first year but for each year that membership continues. With an annual loss of only just over 2 per

cent of membership, who could think of a better way to boost the funds of a branch or guild? After initial enrolling, all paperwork and correspondence is taken over by the Shoreline office.

Could we earnestly request all our branches and guilds to help us in recruiting Shoreline members, thus ensuring a steady income to the RNLI, and also increasing their own totals?

The Shoreline office, 29a Castle Street, Salisbury, Wiltshire (*telephone: Salisbury 6966*) will readily supply forms, dispensers, display boards and assistance, should you require it.

What is Shoreline?

Shoreline membership of the Royal National Life-boat Institution (RNLI) is the way to become closely associated with and help the gallant work of the lifeboat crews in their constant fight to save life at sea.

Why Shoreline?

As a Shoreline member you enter into the spirit of the lifeboat service and contribute directly towards the saving of lives at sea.

Be recognised as a member by wearing or flying the attractive insignia available, and, by doing so, advertise the membership scheme to others.

Don't forget that if you are a registered member of a branch or guild, you are automatically an associate member.



*Enrol a new member, and help Shoreline to back up the men who put to sea.
photograph by courtesy of 'The Observer'*

To: SHORELINE, RNLI, WEST QUAY ROAD, POOLE, DORSET, BH15 1HZ.

I should like to be a part of such a worthwhile voluntary cause by becoming a SHORELINE member of the lifeboat service and joining the Institution as:

A Life Member and Life Governor: minimum donation £60, including journal		Below are the various items you are entitled to wear or fly as a member of SHORELINE:	
A Member and Governor: minimum annual subscription £10, including journal		Members' tie (Terylene) £1.50	
An Offshore Member: minimum annual subscription £3, including journal		Lady's brooch £0.50	
An Associate Member: minimum annual subscription £1.50		Metal car badge £1.55	
		Pair of cuff-links £1.75	
		8" hoist flag £1.25	
		12" hoist flag £2.00	
		Dinghy burgee £1.25	
Total subscription		Insignia payment	

NAME I enclose P.O./cheque/cash for £

ADDRESS Date

..... Signature



Speedboat on Pye Sands

● It was with very great interest that I read of the gallantry awards to members of the crew of *Edian Courtauld* for their successful rescue of a speedboat's complement on August 15, 1973 ('Lifeboat Services', spring 1974 issue). This particular event will be remembered by my family as being one that added drama and tension to the end of our holiday and underlined something of the inherent dangers of our chosen pastime. We were, in a sense, involved, and it happened in this way.

Three yachts, all members of Colne Yacht Club, were returning to Brightlingsea from Ostend. They were the Westerly Longbow *Sagitta of Colne*, abeam of her on starboard was Ian McGregor's sloop *Blue Contessa* while our own Westerly Renown *Tei Tetua* kept station to port. The total complement was six adults, numbering among them the secretary of the Hemel Hempstead branch of the RNLI, plus seven children. Having been at sea since 0645 we were greatly looking forward to picking up our moorings and catching up on sleep.

My log recalls the fact that Trinity Buoy was left close abeam on starboard at 2016 and course was altered to bring us heading down King's Channel. Sundown brought us one of those quiet but clear evenings when the sky lacks some of the grandeur that may sometimes accompany banks of illuminated cloud, but I recall the chill that set in once the sun had dipped below the horizon. On went thick sweaters and one by one navigation lights appeared on the vessels within visual range. We had a relatively calm sea and modest breeze which enabled us to maintain a steady 4½ knots on course. All in all, the evening was well suited to our return.

In the gathering darkness, the tide carried us towards home, and the children were pleased to see the shore lights of familiar places welcoming us back. A merchantman, reading our lights, made a course alteration to pass to port of us as he made for the Barrow Deep and for a while our attention was on him. We sent him a briefly expressed message of thanks by signal lamp, and received his reply and watched him on his way.

It was 'about 2200', my log tells me, when a light on our starboard beam drew our attention. It was not the first,

but as it burned out brightly my son said, 'Dad, that's a parachute flare!' As it faded we realised the truth of his observation. Earlier sightings had not been noted in the log, as we each of us agreed that we had thought them to be a shore light 'or something'.

Tension mounted rapidly. *Sagitta of Colne* had hauled so far ahead that she was only a white light in the distance, but *Blue Contessa* said she would make radio distress calls and hurry on to Brightlingsea to raise assistance. *Tei Tetua* hove to and kept a listening watch on 2182 kHz, maintaining a watch for further flares, but heard nothing except *Blue Contessa's* mayday call, repeated several times.

Tei Tetua, now under engine, put about from a position about 1 mile east of West Gunfleet Buoy and headed north in the general direction from which the last flare was seen. Several times we thought we saw lights and on two occasions believed we saw a 'flare up' at sea level which we supposed might have been burning rags from the way in which the light intensity rose and fell. We rapidly ran out of water and found ourselves at one time with less than 6" beneath our keel.

Unable to cross the Gunfleet, we shut down the engine and strained our ears to catch any sounds of distress. Twice we heard the sound of voices, or so we thought. We signalled by lamp, but there was no reply. How far we were from the speedboat I cannot tell, perhaps eight miles, and so it is pure speculation as to whether we had heard them or not. However, at the time we had believed the flares to have come from a point near Wallet No. 4 Buoy. Having made several attempts to find a way across Gunfleet Sand into the Wallet without success, we had to admit defeat and made for Brightlingsea to report our sightings.

We arrived at 0200, soon after the other two yachts and HM Customs invited us to use their office to make the necessary telephone calls.

It was in a very relieved frame of mind that we returned to our boats about half an hour later. The children were still awake, waiting anxiously for news, and we were very glad to be able to tell them that, thanks to other people's watchfulness, the lifeboat had successfully rescued five people from off Pye Sands. Seven children went to sleep, happier in the knowledge that, even if we had

not been of any help, thanks to the RNLI another crew was safe.

It is our sincere hope that we shall never have need of the lifeboat service, either through press of circumstances or from our own shortcomings, but we draw comfort from having lifeboatmen at hand and from this example of their vigilance. From the combined crews of *Sagitta of Colne*, *Blue Contessa* and *Tei Tetua* may we send our warmest congratulations to those whose gallantry was on this occasion noted and rewarded and an equally warm greeting to all who serve in the boats of the RNLI.—D. J. MORL, 109 Lodge Road, Writtle, Chelmsford, Essex.

Thanks from father and son

● I am writing to thank you on behalf of my wife, family and myself, for the rescue your crew made of my son Martin Wilmot and his friend, when their canoe capsized off Aberdovey beach. But for your prompt attendance the incident could have had serious consequences of which we are very aware.

I am enclosing a cheque for your fund. I would ask you to accept it as a token of our gratitude.—KENNETH J. WILMOT, 130 Mount Road, Penn, Wolverhampton, Staffordshire.

● Thank you for helping to save my life last Saturday. I am sorry to have troubled you but we have been canoeing on the bar for many years and have never known it to be so rough. I have enclosed a postal order for your funds.—MARTIN WILMOT.

When a visitor reported several canoeists in trouble just off Aberdovey Bar on July 20, both Aberdovey and Borth ILBs were launched to search. Borth ILB found two young boys in the water, took them aboard, gave exposure treatment and landed them at Aberdovey where a doctor and ambulance were waiting to take them to Towyn Hospital. One of the boys was 12-year-old Martin Wilmot, and T. A. Morris, honorary secretary, Borth ILB station, was very pleased when, subsequently, he received these letters of thanks from both Martin and his father.—THE EDITOR.

The Mumbles ?

● I read Commodore C. A. S. Colburn's letter published in the summer issue of THE LIFEBOAT regarding the fact that you refer to Mumbles as The Mumbles. You are quite correct in writing it as The Mumbles because that is the way it is known to all local people.

I am 78 years of age and was born in Swansea Valley and have lived there all my life. I have never known it to be called anything but The Mumbles.

The Mumbles was very popular with us and on most holidays Valley people used to go down there as well as to Swansea sands. If anybody was heard referring to it as Mumbles we knew them as strangers to the locality.—D. H. WILLIAMS, *Maesyfelin, 128 Gellygron, Pontardawe, Swansea SA8 4SJ*.

Sir Winston and the RNLI

● From my earliest days I was always a tremendous admirer of Sir Winston Churchill and, whenever possible, I would attend a meeting where he was speaking. This year, as well as being the 150th anniversary of the RNLI, also happens to be centenary of his birth: November 30, 1874. The name of this great man will always be linked with the lifeboat service in a number of ways.

Soon after I joined the staff of the Institution, I spent a few months at Head Office in Grosvenor Gardens. One day I was browsing through the Institution's journals, going back over a number of years, when my eye alighted on one for the year 1924; it contained a full report of the centenary banquet at the Hotel Cecil, London, and seeing Mr Churchill's name I read on with zest.

Mr Winston Churchill, as he was then, was one of the principal speakers and proposed the toast of the Royal National Life-boat Institution and the lifeboatmen of Great Britain.

Shortly after reading his speech, on March 12, 1954, I attended a dinner at Penzance to mark the 150th anniversary of the formation of the Penlee lifeboat station and I was given the task of proposing the toast of the ladies' guild. I was fairly new to this sort of thing and so I thought I could not do better than to bring into my fairly short address a section of the speech Mr Churchill had given in London. The passage was perhaps the most moving part of what is, surely, inspired Churchillian rhetoric:

'It (a lifeboat) drives on with a mercy which does not quail in the presence of death, it drives on as a proof, a symbol, a testimony, that man is created in the image of God, and that valour and virtue have not perished in the British Race.'

I was very glad I did so because Patrick Howarth was present at this function—at which the late Marshal of the Royal Air Force Lord Tedder was the guest of honour—and I think it was the first time the Churchill speech had been brought to his attention. As my very happy time with the Institution draws to its close. I would like to say that it is particularly gratifying to me that Mr Howarth has since made use of this most telling portion of the speech in various ways.

Toward the end of the war I happened to have the opportunity of having a short talk with Jan Masaryk, then Czechoslovak Foreign Minister. It was

shortly after listening to one of the rousing Churchill speeches over the wireless, and I was saying to Mr Masaryk how wonderfully inspiring it was. He wholeheartedly agreed and remarked, 'The world will never realise what it owes to the vocal cords of that man'.

In conclusion, might I allude to a particularly happy episode of Sir Winston's life, namely his engagement to Miss Clementine Hozier, because it so happens that this has an association with the RNLI. Miss Hozier was staying with Sir Godfrey Baring—for 33 years Chairman of the Institution—and Lady Baring at Nubia House, Cowes, when she received an invitation from the Duke of Marlborough to stay at Blenheim. She went, and it was there that Winston Churchill proposed to her and was accepted—A. R. (BOB) DICKINSON, *District Organising Secretary, South West*.

Present, 1924 and 1974

● The picture of lifeboats on the Thames at the centenary of the RNLI in 1924, published in the summer issue of THE LIFEBOAT, interested me very much. The leading boat is *William and Kate Johnston*. My wife and I are the present owners of this vessel, which is now in commission as a yacht, *Jymphany*, home port Dartmouth. We were present with the boat at the opening of the Lifeboat Exhibition at Plymouth.—L. W. LAW, *Falaise, Castle Road, Kingswear, Dartmouth, Devon, TQ6 0BT*

A Skill to be learnt

● From my observation of the boating behaviour of a large number of people, I am sure that at least some of the increase in calls on the ILB service during the summer months is due to sheer ignorance on the part of many who put to sea in motorboats and motor cruisers, mistakenly thinking that these craft require less skilful handling than sailing boats. I recently had occasion to go to the aid of a man whose engine had broken down, and whose boat was drifting on to a bank in a strong tide. When I shouted to him to anchor, he made the alarming discovery that, although he had an anchor, there was no cable attached to it.

This is the kind of stupid situation which simply should not arise, but since it so often does—at, I am sure, great trouble to the lifeboat service—I thought you might be interested to know of the efforts the Lomer Motor Cruiser School is making to counteract the lack of basic knowledge of seamanship.

Since August 1968, I have been running five- and seven-day courses in boat handling, safety at sea, general seamanship and coastal navigation, and mine was the first motor cruiser school to be recognised by the Royal

Yachting Association. The courses are divided between instruction given in our classrooms at Beech House, and on board our single screw *Christina* and twin screw *Weymouth* in the coastal areas between Chichester and Portsmouth. We also run advanced courses, covering the syllabus for the RYA yachtmaster's certificate, and have started a small craft training centre for waterskiers and other users of small fast boats.

The aim of the school is to promote safety at sea. I hope that readers of THE LIFEBOAT, who, after all, share the same concern, will help us to achieve our aim by spreading the message that boat handling is a skill to be properly learnt; that one cannot just jump into a motor-cruiser and speed off round the British coastline, or over to France; and that ignorance of the basic rules of seamanship costs lives.—ROGER E. J. LOMER, *Lomer Motor Cruisers Schools Ltd, Beech House, Rowlands Castle, Hampshire, PO9 6DP*.

Stolen Yacht

● Reading the report on the stolen yacht *Susie Wong* ('Lifeboat Services', spring 1974 issue), I wonder if you are aware of the ownership of this yacht? She is owned by Baden Davies, who served a total of 42 years as a crew member of Aberystwyth lifeboat, 11 of those years as coxswain.

Baden, now aged 74, is a familiar figure in Aberystwyth and still acts as harbour pilot for larger boats wishing to enter this difficult harbour. Living alone in a small house overlooking the harbour, he is often consulted about sailing matters by beginners and more experienced sailors, and his tales of his life at sea fascinate all who are so fortunate as to know him well enough to persuade him to relate them.

The holder of two vellums, one for bravery, awarded for his successful rescue in gale force winds of the MFV *Pen-cwm* on July 29, 1954, and one for long service, Baden has served in four lifeboats: *John and Naomi Beattie*, pulling and sailing, *Frederick Angus*, *Lady Harrison* and *Aquila Wren*.

At 13 years old, in 1913, Baden ran away to sea, joining a three-masted schooner, sailing out of Runcorn, as ordinary seaman and cook, pay 30s a month. Later he signed with Cunard, shipping as quartermaster on a Mediterranean trader.

Although no longer actively engaged in lifeboat work, Baden still helps with fund raising and is fascinated by the modern ILB. He regards her as 'a handy craft, faster than any previous boat and very good for inshore work', adding 'She is going to prove a marvellous boat—I wish we had had one when I was coxswain. You need to be a seaman and a technician to sail one of them.'—MATTHEW GILMORE, *60 Lawn Close, Oldham OL8 2HB, Lancashire*.

How even a non-swimmer can save someone from drowning

Join Shoreline now. Why Shoreline? Last year the RNLI saved over 1,750 lives. This year we expect to save even more. In order to maintain the service we need £4m every year.

But as we're a voluntary organisation we have to raise funds for all our work through the generosity of our friends old and new. Flag days, gifts and fund-raising events all help, but they're not enough, nowadays we need a regular source of income.

That's why we started Shoreline. Increasingly, Shoreline is going to become more important.

This, our 150th anniversary year, saw the start of the programme to build 49 self-righting lifeboats of the latest design. And that's going to cost a lot of extra money, £6m in fact, which is over and above the £4m.

Please help us.

I wish to join Shoreline, enclosed is my cheque for:

(Please tick appropriate box)

- An "Off Shore" Member (annual subscription £3 including journal).**
- A Member and Governor (minimum annual subscription £10 including journal).**
- A Life Member and Life Governor (minimum donation £60 including journal).**

I enclose P.O./Cheque/Cash for £.....
Total Annual Subscription L.3

Name.....

Address.....

Please send me details of Shoreline insignia.
Post coupon to The Director, RNLI,
West Quay Road, Poole, Dorset, BH15 1HZ.

RNLI SHORELINE



Central Appeals Committee

EXCELLENT SUPPORT has continued this quarter for the various projects of the Central Appeals Committee. Captain Phelps, master of *John Biscoe* of the British Antarctic Survey, on arrival at Southampton handed over more than £31 collected at a social dance in the Falkland Islands—the prime movers being, I understand, the brothers Crockford who are also members of Tenby lifeboat crew.

Your attention is drawn to a note on page 222 outlining a scheme to raise a substantial sum from Golden Hind halfpennies. Coins, old or foreign, can often make money for the Institution, so if you have any, please pass them on to your local branch or district office.

More about the knit-ins. Our two vice chairmen report that very great interest is being shown all over the country, and, with darker evenings now coming upon us, what about getting knitting? The total raised by this means has now shot up. How about arranging an evening's knitting now to ensure that the target is reached by January 1975?

It cannot be too strongly stressed that as much help and support as possible should be given to the Scouts in their venture 'Operation Lifeboat'. Tremendous



Two sponsored lunch-hour knit-ins by RNLI Headquarters staff at Poole raised £44. One was held near the caravan on the quay; the other, due to rain, in the office. Knitters were sponsored by other members of staff and their families; passers-by added their bit, too.

photograph by courtesy of Times-Herald Newspapers

dous preparations are being made by the Scouts themselves, and anything to make life easier for them to reach their target is to be encouraged.

The Guides, Brownies and Rangers, under the good auspices of the Guide Friendship Fund, have already raised more than £4,000 of their target, £5,000 for an Atlantic 21 ILB. With many results still to come, the organisers think it may be possible to purchase the trailer as well as the boat.

The 'Link with a Lifeboat' scheme is at present under careful consideration. It should be very popular as it will give the opportunity of feeling, and, in fact, being linked with a particular lifeboat. We hope to give details soon.

The CAC are always ready and willing to receive any of your suggestions for ways of raising money. Please send them to the office at 126a High Street,



National sponsored swim 1971/72 made £20,286 for RNLI funds. On May 10 Norman Crumby, chairman CAC, presented a plaque to Ernest Warrington, MBE, president ASA, in gratitude for the generous support of the Amateur Swimming Association and affiliated associations and clubs.

Orpington, Kent (telephone: from outside London, 0689 38209; from inside the London area 66 38209).—D.M.R.

Lifeboat Jubilee Rose

John Sanday (Roses) Ltd, who developed the Lifeboat Jubilee Rose, have been awarded the Queen Mary Commemoration Medal by the Royal National Rose Society, 'for their outstanding contribution in the raising of new roses by British hybridists'.

Lifeboat Jubilee Rose bushes are still available, price 80p each (carriage and packing 35p). Order forms can be obtained from RNLI, West Quay Road, Poole, Dorset, BH15 1HZ.

Lifeboat People

It is with deep regret that we announce the death on June 3 of C. G. Freke, CBE. Mr Freke joined the Committee of Management in 1953 and was elected a vice-president in 1962. He served on various sub-committees and was chairman of the general purposes and publicity committee from 1957 to 1967. He was elected a life vice-president in 1972.

On November 19, 1933, Longhope lifeboat went to help Icelandic trawler *Geysir* of Reykjavik, grounded on Torness Point, Pentland Firth. Among 15 people rescued was 19-year-old Sigríður Jóhannesdóttir, daughter of one of the boat's owners. Forty years later, in gratitude for the saving of the crew and the warm welcome given to them, Mrs Jóhannesdóttir has given 20 Icelandic woollen blankets to the lifeboat stations of Orkney: Longhope, Stromness and Kirkwall. Mrs Jóhannesdóttir (below) hands over the blankets to Gunnar Frídríksson, president, National Life-Saving Association of Iceland, and Hannes Th. Hafstein, managing director.



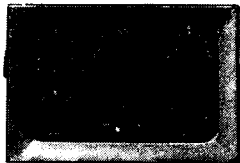

Automatic Pilot

To hold a set course
in most conditions

Repeater Compass

For easy reading
and optimum siting

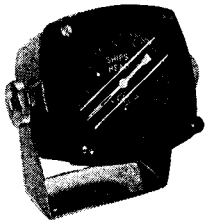

Electric Capstan

Push-button control
of 650 lbs pull

Anchor Windlass

1,600 lbs pull from
12-220 volt D.C. supply

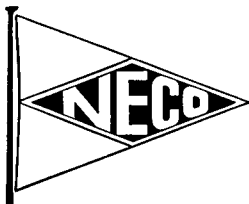

Dinghy Hoists

For dinghies, etc.,
up to 1,500 lbs lift

Indicators

For Rudder Angle,
Battery State

NECO MARINE LTD.

Walton Rd., Eastern Rd., Cosham, Portsmouth,
Hants. PO6 1SZ Tel: Cosham (07018) 70988



By Appointment to
Her Majesty The Queen
Pest Control & Timber Preservation
Services & Products

An admittedly modest quid pro quo

You save lives. We save buildings.
Including, we're pleased to say, many
R.N.L.I. stations.

We are proud to serve you in our
small way—just as you, in your big
way, serve others.

RENTOKIL

guards your property



Felcourt, East Grinstead, Sussex RH19 2JY.

THE WORLD'S MOST POWERFUL FLASHLIGHT

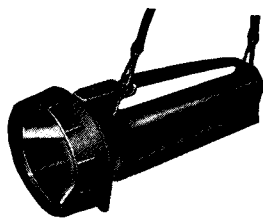

DYNALITE FLASHES

The world's most powerful flashlight, specially
imported from the U.S.A. This six-cell flashlight
is 80,000 candle power made of strong plastic, and
unconditionally guaranteed for one year. This is
an ideal outdoor light for every purpose including
signalling. As sold to, and tested by the
Royal National Life-boat Institution Also approved
by the Game Conservancy. Will go to a
depth of 30ft and remain 100% waterproof.

£5.00 (Batteries extra)

Similar in design but for heavier duty, 'The
Sharkseye' will go to a depth of 100ft.

£6.00 (Batteries extra)

Prices include VAT. Post and Packing
30p (UK only)

Write to Dept. J



COGSWELL & HARRISON LTD
168 PICCADILLY, LONDON W1 Tel: 01-493-4746/01-629-5923

L. J. BUSHNELL

C.Eng., F.R.I.N.A., F.Inst.B.E.

CONDITIONS AND INSURANCE SURVEYS



WATERMAN TO HER MAJESTY QUEEN ELIZABETH II

WOOD, STEEL OR G.R.P. HOME AND ABROAD

LEONARD J. BUSHNELL & PARTNERS
THAMESIDE, WARGRAVE, READING,
BERKS

Telephone: Wargrave 2161

Member of the Bushnell Group

Lifeboat Services

(From page 218)

the harbour entrance when she received a message from *Barragutt* saying that her steering gear had broken down and she was wallowing in the navigation channel between perches 6 and 7. When crossing the first bar the wire connecting the rudder to the wheel had parted, the rudder jamming hard over to port. The engine was put into neutral and *Barragutt* came to an uneasy rest beam on to wind and seas. The emergency tiller was not on board and the sweep oar could not be used to steer with the tiller jammed hard over. Just after sending her message, *Barragutt's* radio was dashed to the deck in the violent rolling and smashed.

Welsh Lady turned about in the channel, fired off a distress flare on behalf of *Barragutt* and returned up channel to give help. She had to cross the inner bar against the full force of the wind, now estimated at north west force 9 to 10, sea state 4, while *Barragutt* was maintaining her position and holding herself off the training wall by using her engine. *Welsh Lady* crossed *Barragutt's* stern and tried, unsuccessfully, to pass a tow rope. She then turned to starboard, crossed ahead of *Barragutt* and between her and the derelict training wall and managed to pass the tow rope. The tow rope was made fast, *Barragutt's* bow pulled starboard and the two boats slowly crossed the second bar. *Barragutt* helped *Welsh Lady* by going ahead on her engine, and she also streamed her drogue. The two boats secured to their moorings at about 1715.

For this service a framed letter of appreciation signed by the Chairman of the Institution, Commander F. R. H. Swann, CBE, RNVR, was sent to John Povah.

Lifeboat launches on service during the months March, April and May, 1974

Aberdeen, Aberdeenshire
April 13.
Aldeburgh, Suffolk
March 11.
Angle, Dyfed
March 15, 28, April 13 (2) and 14.
Anstruther, Fife
March 16.
Appledore, Devonshire
May 1 and 14.
Arklow, Co. Wicklow
March 10 (2) and 26.
Baltimore, Co. Cork
March 16, 19, 21, April 12, 13 (2), May 20.
Barmouth, Gwynedd
April 1 and 26.
Barra Island, Outer Hebrides
April 9 and 17.

Barrow, Cumbria
May 27.
Barry Dock, South Glamorgan
March 21, April 6, 7, 18, 26, 27, 30, May 1.
Beaumaris, Gwynedd
March 17.
Bembridge, Isle of Wight
April 24, May 22 and 30.
Berwick-upon-Tweed, Northumberland
May 28.
Bridlington, Humberside
April 13.
Broughton Ferry, Angus
March 16 and 30.
Buckie, Banffshire
March 30, April 9.
Calshot, Hampshire
March 30, April 23, May 3, 30 (2).
Clacton-on-sea, Essex
March 24, May 18 and 28.
Cloughy-Portavogie, Co. Down
March 11.
Clovelly, Devonshire
March 5, 23, May 22.
Courtmacsherry Harbour, Co. Cork
March 18.
Cromer, Norfolk
March 2.
Donaghadee, Co. Down
May 12 and 16.
Dover, Kent
April 28, May 15 and 19.
Dunbar, East Lothian
March 23.
Dungeness, Kent
April 23.
Dun Laoghaire, Co. Dublin
March 18, 24, 29, May 23.
Eastbourne, East Sussex
April 17, May 15.
Exmouth, Devonshire
May 7.
Falmouth, Cornwall
March 2.
Flamborough, Humberside
March 3, 15, 23, May 12.
Galway Bay, Co. Galway
March 21, April 14, 21, May 22.
Girvan, Ayrshire
May 12.
Great Yarmouth and Gorleston, Norfolk
March 8, April 21, 27, May 28
Harwich, Essex
May 11.
Hastings, East Sussex
March 8, April 23, May 5.
Holyhead, Gwynedd
March 10.
Howth, Co. Dublin
March 6.
Hoylake, Merseyside
May 18.
Humber, Humberside
March 4, April 21, May 5 and 11.
Kilmore, Co. Wexford
May 8 (2).
Kirkcudbright, Kirkcudbrightshire
May 18.
Kirkwall, Orkney
March 8, April 8 (2), May 5.
Llandudno, Gwynedd
May 26.
Longhope, Orkney
March 3.
Lowestoft, Suffolk
April 13, May 25.
Lytham-St Anne's, Lancashire
May 22.
Macduff, Banffshire
March 30, April 28.
Margate, Kent
April 13, May 4, 30 and 31.
Moelfre, Gwynedd
March 5, May 2.
Mumbles, West Glamorgan
May 28.
New Quay, Dyfed
April 27, 28 and 30.
North Sunderland, Northumberland
April 4.
Penlee, Cornwall
March 22, April 11 and 13.
Peterhead, Aberdeenshire
May 9.
Plymouth, Devonshire
March 23.
Poole, Dorset
April 10, 14, May 3 and 4.
Porthdinllaen, Gwynedd
March 15 and 24, April 16.
Portrush, Antrim
April 18.
Port St Mary, Isle of Man
March 3, May 5.
Pwllheli, Gwynedd
April 13 and 26, May 27.
Ramsey, Isle of Man
May 9.
Ramsgate, Kent
March 3.
Rosslare Harbour, Co. Wexford
May 8 and 31.
Runswick, Cleveland
April 14, May 11.
St Helier, Jersey
April 6, May 5.
St Ives, Cornwall
March 5, April 1, May 5 and 29.
St Mary's, Isles of Scilly
April 2 and 7, May 21.
St Peter Port, Guernsey
March 23 and 27, April 26, May 5 (2), 7, 16 and 27.
Salcombe, Devonshire
April 14.
Seaham, Durham
March 19, May 26.
Selsey, West Sussex
March 16, April 5, May 11 and 25.
Sennen Cove, Cornwall
April 15.
Sheerness, Kent
March 10, 11, 15 and 22 (2), April 6 and 13, May 1, 8, 20 and 23 (2).
Sheringham, Norfolk
April 27.
Shoreham Harbour, West Sussex
March 12 and 22, April 30, May 1 and 16.
Skegness, Lincolnshire
April 2 and 30.
Stromness, Orkney
May 9.
Swanage, Dorset
March 8, 18 and 26, April 27, May 1 and 25 (4).
Teesmouth, Cleveland
April 8, 28 and 30.
Tenby, Dyfed
April 11, 15 and 16, May 1, 2, 19, 26, 28 (2) and 30.
Thurso, Caithness
March 3.
Troon, Ayrshire
May 2 and 10.
Tynemouth, Tyne and Wear
March 10 (2), 11 (3), and 31.
Valentia, Co. Kerry
April 12.
Walmer, Kent
May 22.
Weymouth, Dorset
March 2, 9 and 30, April 14 and 15, May 1 (2), 15 and 30.
Whitby, North Yorkshire
March 3, April 23, May 6.
Wick, Caithness
March 8.

Wicklow, Co. Wicklow
April 27 and 28, May 16.
Workington, Cumbria
March 13.
Yarmouth, Isle of Wight
March 16.
Youghal, Co. Cork
May 28.
On Passage
May 1 and 25.

ILB launches on service during the months March, April and May, 1974

Aberdovey, Gwynedd
April 12 and 28, May 12.
Abersoch, Gwynedd
April 7, 13 and 26, May 7 and 17.
Aberystwyth, Dyfed
April 1, May 12 (2) and 19.
Arran (Lamlash), Buteshire
April 13.
Atlantic College (St Donats), South Glamorgan
March 7, April 12, 14 and 26, May 5, 18 and 25.
Barmouth, Gwynedd
May 28.
Barrow, Cumbria
April 5 and 7.
Beumaris, Gwynedd
April 22, May 1, 13 and 16.
Bembridge, Isle of Wight
May 17 and 22.
Blackpool, Lancashire
April 5, 7 and 8, May 27.
Borth, Dyfed
April 26, May 31.
Brighton, East Sussex
April 14 (2), May 22 and 29.
Broughty Ferry, Angus
March 3, May 5, 7, 20 and 21.
Burnham-on-Crouch, Essex
April 13 and 26, May 9.
Burry Port, Dyfed
April 23, May 7, 12 and 30.
Cardigan, Dyfed
May 8.
Clacton-on-Sea, Essex
April 28, May 5, 11, 21 and 28.
Conway, Gwynedd
March 23 and 24, April 14.
Criccieth, Gwynedd
April 13.
Crimdon Dene, Durham
April 21.
Cromer, Norfolk
May 29.

Cullercoats, Tyne and Wear
April 25.
Dunbar, East Lothian
March 23.
Eastbourne, East Sussex
May 15, 21 (2) and 25.
Eastney, Hampshire
March 6 and 14, April 13, 20 (2), 21 and 24, May 11.
Exmouth, Devonshire
May 7 and 30.
Filey, North Yorkshire
May 19, 20 and 26.
Fleetwood, Lancashire
May 4, 8, 10, 12 and 31.
Great Yarmouth and Gorleston, Norfolk
March 9 and 24, May 6 and 11.
Hartlepool, Cleveland
April 8.
Harwich, Essex
April 6, 9 and 24.
Hastings, East Sussex
April 21 and 23, May 26 and 31.
Helensburgh, Dunbartonshire
March 9, April 4, 20 and 29, May 17, 22, 27 and 28.
Horton and Port Eynon, West Glamorgan
April 18 and 24.
Humber Mouth (Cleethorpes), Humberside
May 27.
Kippford, Kirkcudbrightshire
May 24 and 26.
Largs, Ayrshire
March 24, April 26 and 28, May 3 and 19.
Littlehampton, West Sussex
March 10, 21 and 23, April 5, May 1, 2, 6, 14, 19 and 26.
Littlestone-on-Sea, Kent
March 16 and 31, April 23.
Llandudno, Gwynedd
April 27, May 12, 18 and 26.
Lyme Regis, Dorset
April 7, 13, 14 and 27, May 11 and 25.
Lymington, Hampshire
April 13 (2), 14 and 18, May 28.
Lytham-St-Anne's, Lancashire
May 5.
Margate, Kent
May 15, 19, 20, 25 (2) and 31.
Minehead, Somerset
April 4, 16 and 23, May 19 and 30.
Moelfre, Gwynedd
April 28 (2), May 15, 26 and 30.
Morecambe, Lancashire
March 24, May 4 and 12.
Mudford, Dorset
March 31.
The Mumbles, West Glamorgan
May 3.
New Brighton, Merseyside
April 17, May 9, 17, 26 and 27.
Newquay, Cornwall
April 7 and 18.
North Berwick, East Lothian
May 26.

North Sunderland, Northumberland
April 15 and 29.
Pill, Avon
April 14 and 28, May 8.
Plymouth, Devonshire
April 13 and 15, May 15 and 28.
Poole, Dorset
May 1.
Porthcawl, Mid Glamorgan
April 12, May 20.
Port Isaac, Cornwall
March 31, April 9 and 19.
Port St Mary, Isle of Man
May 5 and 27.
Port Talbot (Aberavon Beach), West Glamorgan
April 14, May 19.
Pwllheli, Gwynedd
May 24.
Queensferry, West Lothian
April 8, 14 and 15.
Redcar, Cleveland
April 14.
Rhyl, Clwyd
April 14, 26 and 27, May 15, 16 and 27.
Rye Harbour, East Sussex
April 13, May 26.
St Agnes, Cornwall
April 8, 13 and 15.
Selsey, West Sussex
April 5, 11, 13 and 20, May 5 and 21.
Sheerness, Kent
April 6 and 13, May 1, 3, 10, 20, 29 and 30.
Shoreham Harbour, West Sussex.
March 31, April 14, 28 and 30, May 1 (2), 4, 5, 12, 16 and 28.
Southend-on-Sea, Essex
March 15, April 28.
Southwold, Suffolk
April 12 (2), May 30.
Stonehaven, Kincardine
April 25, May 31.
Sunderland, Tyne and Wear
May 29.
Tenby, Dyfed
May 2 and 26.
Torbay, Devonshire
April 5, 16, 21 and 28, May 1, 11, 19, 21, 26 and 30 (2).
Tre-Arddur Bay, Gwynedd
April 4 and 24, May 25.
Tynemouth, Tyne and Wear
March 10, 26, 27 (2), 28 (2), April 6, 7, 8, 23 and 28, May 26.
Walmer, Kent
April 29, May 19 and 25.
West Mersea, Essex
April 13 and 27, May 1, 8 and 28.
Weston-Super-Mare, Avon
March 10, April 28, May 26, 27 and 30 (3).
Whitstable, Kent
March 3 and 24, April 6 and 11, May 4 and 14.
Yarmouth, Isle of Wight
April 21.

LAUNCHES AND LIVES SAVED BY LIFEBOATS AND INSHORE LIFEBOATS

January 1, 1974 to June 30, 1974: Launches 923, lives saved 456

THE STATION FLEET (as at 30/6/74)

134 station lifeboats

119 inshore lifeboats operating in the summer

LIVES RESCUED 98,872

from the Institution's foundation in 1824 to June 30, 1974

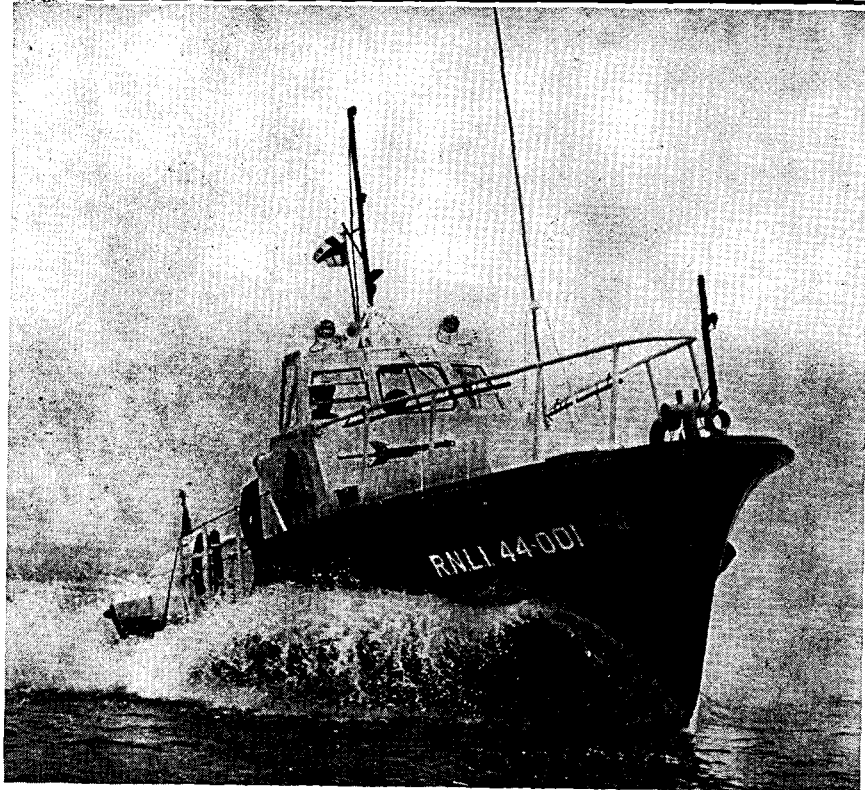

**Twin Mermaid
Type 595 TP
TURBO-PLUS**

**Marine Diesels
now installed
in this craft.
To be followed
by similar
installations in
new 44 foot
Steel Lifeboats**

Mermaid Marine Engines Ltd

THAMES MARINA THAMES DITTON SURREY

Telephone: 01-398 6802 and 6159

Mermaid



**"Who keeps
JABSCO
bronze pumps
circulating?"**

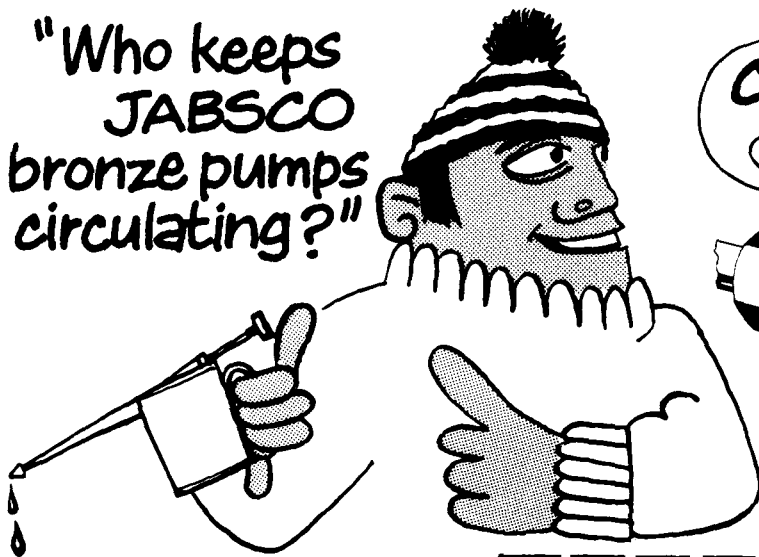

CLEGHORN WARING

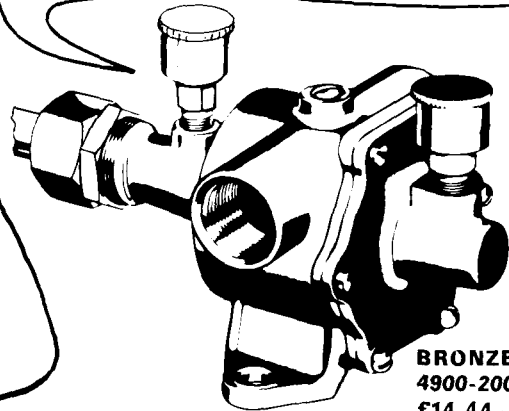

**BRONZE PUMP
4900-200
£14.44 VAT**

If you have a circulating pump problem, get in touch with Cleghorn Waring. Their technical advice service is second to none, with 20 years experience of Jabsco to draw on. And they have the stock and the staff to give help fast.

Shown above is the Jabsco bronze pump 4900-200, with neoprene impeller and $\frac{1}{2}$ in BSP outlets. Stainless steel shaft. Just the job for a circulating pump.

Please send further details of the JABSCO bronze pump 4900-200

I am also interested in pumps for

Name

Address



CLEGHORN WARING & CO (PUMPS) LTD

REALLY KNOW THEIR JABSCO!

31 HITCHIN STREET, BALDOCK, HERTS.

TEL: BALDOCK 2071

Index to Advertisers

Birds Eye Foods	198	Gardner Engines (Sales) Ltd ..	Inside Back Cover
Brooke Marine Ltd	Inside Front Cover	David Jolly	232
L. J. Bushnell & Partners	228	Mermaid Marine Engines Ltd	231
Cleghorn Waring & Co. (Pumps) Ltd	231	Neco Marine Ltd	228
Coastal Radio Ltd	232	Rentokil	228
Cogswell & Harrison Ltd	228	RNLI Shoreline	226
Fairy Marine Group	Outside Back Cover	C. P. Witter Ltd	232

CLASSIFIED ADVERTISEMENTS

FOR SALE

Advertising pencils, superb ball pens, combs, brushes, each gold stamped Lifeboat name, etc., raise funds, quickly, easily. Bran Tub Toys: samples from, Northern Novelties, Bradford 2 (BD2 3AF).

INSURANCE

FOR ALL INSURANCE, Phone, call or write J. A. Harrison (Brokers) Ltd, "Security House", 160-161 Bromsgrove Street, Birmingham B5 6NY. Telephone:

021-692 1245 (10 lines). For keenest rates, service and security.

TROPHIES

For all types of Trophy Cups, Medals, Medallions, Shields & Statuettes. Sports Prizes, Fancy Goods, Carnival Hats, Balloons, Novelties, Fund-raisers. All requirements for CHILDREN'S CHRISTMAS PARTIES supplies. ALSO NOW AVAILABLE TO CLUB MEMBERS, Lounge, Dining & Bedroom Suites, Carpets. All types of Light Fittings and Shades, etc. ALL AT WHOLESALE TRADE PRICES. Send for our 64 page catalogue: SWINNERTONS LTD., Dept 'L', UNION STREET, WALSALL WS1 2HJ.

RACE SETS—MAINSAILS—DINGHYS—CUPS. W. & E. Astin, 7 Westerley Lane, Shelly, Huddersfield. Kirkburton 2368.

FUND RAISING

Fund raising with 200% PROFIT ON OUTLAY! Send stamp for catalogue of imprinted ball-pens and 20 other quick-sellers. Provincial Supplies, 1 Gardenfield Lane, Berkhamstead, Herts.

WANTED

Interesting film, any gauge, black and white or colour, of Lifeboats or rescue at sea. BBC TV, Box 774, c/o RNLI, West Quay Road, Poole, Dorset, BH15 1HZ.

**THE ORIGINAL
TILLER MASTER**

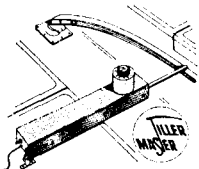



AUTOMATIC STEERING on a COMPASS COURSE
For craft 20-45ft. over 100lbs. thrust. Self-contained unit with simple 2-hole installation. Quickly disengaged. ½ amp. average drain. Ocean proved. **£196 ex VAT**

Sole importer:
DAVID JOLLY
3 Little Russel, Lytchett Minster, Poole,
Dorset BH16 6JD. Tel.: 020 122 2142

COASTAL RADIO

- the instant communication and precise navigation equipment that takes the rough with the smooth

Coastal Radio Limited, Westway,
Chelmsford, Essex CM1 3BH.
Telephone: (0245) 65533. 
A Marconi Marine Company



TOWING BRACKETS

Approved by car manufacturers and issued with fitting instructions. Also shock absorbers stabiliser and couplings.

Please save a little for the people who save a lot—give generously to the R.N.L.I.

C. P. WITTER LTD. CHESTER Tel: 0244-41166

CLASSIFIED ADVERTISEMENTS

Readers are reminded that THE LIFEBOAT, with a print run of 40,000 copies, is an attractive medium for classified sales and wants advertisements. Classified rates are 15p a word; panels £15.00.

All enquiries to:
Dyson Advertising Services,
PO Box 9, Godalming, Surrey.

GARDNER

durability



Dependable Marine diesel engines 110 - 230 b.h.p.

GARDNER ENGINES (SALES) LTD

PATRICROFT, ECCLES, MANCHESTER M30 7WA. Tel: 061-789 2201
LONDON: 130 Brixton Hill, London SW2 1RS. Tel: 01-671 0978/9
GLASGOW: 124 St. Vincent Street, Glasgow G2 5ER. Tel: 041-221 0887

from

FAIREY MARINE



Spear 9m
Police Launch



Waveney 13.4m
Self-righting
Lifeboat

craft for the total coastguard concept



Tracker 19.6m
Air-Sea Rescue Launch



further details:

Manager Military Sales,
Fairey Marine Group, Hamble, Southampton.
Telephone: Hamble 2661 Telex: 47546