

THE LIFE=BOAT.

JOURNAL

OF THE

Royal National Life=boat Institution.

(ISSUED QUARTERLY.)

VOL. XVI.—No. 184.]

1ST MAY, 1897.

[PRICE 1s.

At the ANNUAL GENERAL MEETING of the ROYAL NATIONAL LIFE=BOAT INSTITUTION, held at St. Martin's Town Hall, Charing Cross Road, on Saturday, the 27th day of March, 1897, The Right Hon. G. J. GÖSCHEN, M.P., First Lord of the Admiralty, in the Chair, the following Report of the Committee was submitted and adopted:—

ANNUAL REPORT.

1897.

THE important life-saving work of the ROYAL NATIONAL LIFE=BOAT INSTITUTION has been earnestly and actively carried on during the past year, and every effort has been made to maintain, increase and secure the efficiency of the service. The Committee, while thankfully acknowledging the valuable help they have received from the Public in the past, hope that they may be encouraged by similar co-operation in the coming year, and that in view of the improvement which has of late been manifested in the general trade of the country, better times are in store not only for all classes of the community, but also for the great Institution for which they plead.

Life-boats.—The Institution has established new stations during the past year at Carrickfergus, Formby, Port St. Mary, and Rosslare Harbour, a Life-boat fully equipped and of the type most suitable having been supplied to each. A new station is also in the course of formation at Rhos (Colwyn Bay).

In addition to these four new stations which were established and equipped, ten other stations were supplied with new Life-boats, the coxswains and crews having in each instance been fully consulted as to the type and dimensions of the boat they would be called upon to use. The stations to which these new boats were sent to take the place of obsolete, unsuitable, or worn-out boats were:—

ENGLAND AND WALES.

Blackpool	Lancashire.
Brixham	South Devon.
Penmon	Anglesey.
Teignmouth	Devonshire.
Winterton No. 1	Norfolk.

SCOTLAND.

Ayr	Ayrshire.
---------------	-----------

IRELAND.

Ballycotton	Co. Cork.
---------------------	-----------

ISLE OF MAN.

Castletown	Douglas No. 2.
Ramsey.	

The boats at three other stations were also during the year improved and brought as far as possible up to date, and a

similar course will be adopted with others as circumstances permit.

A steam Life-boat being built for the Institution by Messrs. Thornycroft, of Chiswick, will shortly be placed at New Brighton. The larger proportion of the cost of the boat has been raised by the Port of Liverpool Branch of the Institution. She is to be named *The Queen* in commemoration of the completion of the sixtieth year of the reign of Her Gracious Majesty, the Patron of the Institution.

In 1896 the Committee withdrew one of the Life-boats from Douglas, Isle of Man, the large sailing Life-boat recently stationed there being, in their opinion, well able to do all the work now required in the vicinity of the station. The large sailing Life-boat which had been placed at Beaumaris as an experiment has also been withdrawn, the new boat which has been sent to Penmon meeting fully the requirements of the Menai Strait and the immediate neighbourhood. One of two Life-boats at Selsey has likewise been withdrawn for a similar reason, and the stations at Dartmouth, Kimeridge and Sillioth have been closed; local circumstances rendering it unnecessary to incur the expense of maintaining them.

There were 298 Life-boats belonging to the Institution on the coast at the close of 1896.

Transporting Carriages.—New transporting carriages have been supplied during the year to eighteen stations, and others are being built and will be despatched to the coast as soon as possible.

Tipping's Plates.—The launching arrangements at five stations have been rendered more efficient by being furnished with these very useful plates, which have fully justified their introduction into the service.

Inspection of Life-boats, &c.—All the Life-boats of the Institution on the coast have been thoroughly inspected by the

Officers appointed for the purpose during the past year, and the majority of them on two or more occasions. A full report of each visit has been submitted to the Committee for their consideration and information. The system of surprise visits, introduced two years ago, has been continued with satisfactory results.

Shipwrecks.—The last three years have been somewhat remarkable for the absence of any long continuance of stormy weather, and the year 1896 proved to be one of the calmest years experienced during the last decade. Whole weeks passed without a single Life-boat being launched on service, and it was only, speaking generally, in the early and closing months of the year that the services of the Life-boats and their crews were specially called for. It is gratifying however to know that when the storm raged, making havoc on land and spreading desolation at sea, there was no hanging back on the part of the Life-boat crews, who, braving the tempest, gallantly rescued many a shipwrecked mariner from a watery grave.

The heaviest gales of the year occurred on the 25th of September and the 8th of October. During the first of these gales twenty-five Life-boats were launched on service, resulting in the saving of twenty-four lives and the landing of eight other persons from vessels in distress as a precautionary measure; whilst during the second, seventeen Life-boats were launched on service, resulting also in the saving of twenty-four lives and the landing of thirty-nine other persons from vessels in dangerous positions. An enormous amount of damage was done, particularly on the west coast, to the Life-boat houses, stages, slipways, &c., during these two gales, entailing a very heavy pecuniary loss on the Institution. The tide which accompanied the gale of the 8th of October was alleged to have been the highest, in many places, on record.

The Committee have to report with thankfulness that, notwithstanding the

thousands of their Life-boat men who were afloat in the Life-boats during the year, only one lost his life on service, and that from an accident not due in any way to the Life-boat, but unfortunately, it is to be feared, to an error of judgment on the part of the poor fellow who had divested himself of his life-belt and fell from the side of a vessel he was endeavouring to board.

The number of lives for the saving of which the Institution granted rewards in 1896 was 461; of which number 312 were rescued by Life-boats, and 149 by shore-boats and other means. On other occasions the crews were assembled for service 50 times, their services not being ultimately required. The details of the services during each month of the year are as follows:—

1896.	Number of Life-boat Launches.	Lives Saved by Life-boats.	Vessels Saved by Life-boats.	Lives Saved by Shore-boats.
January . . .	24	15	—	28
February . . .	26	10	—	25
March . . .	29	13	1	5
April . . .	18	9	3	2
May . . .	11	11	2	19
June . . .	5	—	1	2
July . . .	11	2	1	—
August . . .	11	—	1	4
September . . .	49	29	4	4
October . . .	74	95	3	11
November . . .	37	58	2	26
December . . .	50	70	2	23
Total . . .	345	312	20	149

The total number of lives for the saving of which the Institution has granted rewards since its establishment in 1824 by Life-boats, shore-boats, or by other means, has been 39,815, the number for each year being as follows:—

Year.	No. of Lives.	Year.	No. of Lives.
1824	124	1835	364
1825	218	1836	225
1826	175	1837	272
1827	163	1838	456
1828	301	1839	279
1829	463	1840	353
1830	372	1841	128
1831	287	1842	276
1832	310	1843	236
1833	449	1844	193
1834	214	1845	235

Year.	No. of Lives.	Year.	No. of Lives.
1846	134	1873	668
1847	157	1874	713
1848	123	1875	921
1849	209	1876	600
1850	470	1877	1,048
1851	230	1878	616
1852	773	1879	855
1853	678	1880	697
1854	355	1881	1,121
1855	406	1882	884
1856	473	1883	955
1857	374	1884	792
1858	427	1885	555
1859	499	1886	761
1860	455	1887	572
1861	424	1888	800
1862	574	1889	627
1863	714	1890	765
1864	698	1891	736
1865	714	1892	1,056
1866	951	1893	598
1867	1,086	1894	790
1868	862	1895	709
1869	1,231	1896	461
1870	784		
1871	882	Total	39,815
1872	739		

Rewards.—The rewards granted by the Institution last year for the saving of life from shipwreck on the coast, or for efforts to do so, and in recognition of other good services rendered to the Society, comprised 1 Gold Medal, 5 Silver Medals, 9 Binocular Glasses, 4 Aneroid Barometers, 39 Votes of Thanks inscribed on vellum and framed, 6 Certificates of Service framed, and 10,616*l.* 18*s.*, including grants to relatives of men lost on service and compensation for injuries received in the Service.

At the close of the year the Institution had bestowed altogether in rewards since 1824, 99 Gold Medals and Gold Clasps, 1,154 Silver Medals and Clasps, 266 Binocular Glasses, 15 Telescopes, 13 Aneroid Barometers, 1,558 Votes of Thanks inscribed on vellum and framed, 63 Certificates of Service framed, and 169,546*l.* 5*s.* 6*d.* in money.

Aneroids.—Many of these very useful and reliable instruments were in 1896 supplied by the Institution, at about a third the retail price, to Masters and Owners of Fishing-boats and small Coasters. Of the 144 instruments so supplied, 114 went to Fishermen and

30 to Coasters. The total number provided by the Institution since June 1882 has been 3,753.

Removal of Wrecks.—Several wrecks in non-navigable waters which were dangerous to the Life-boat crews when discharging their life-saving duties, were removed by the Elder Brethren of the Trinity House, and other authorities during the past year, this being done under the useful provisions of the Removal of Wrecks Act 1877, Amendment Act 1889, passed through Parliament as the result of the exertions of the Institution.

Electrical Communication on the Coast.—Further progress was made last year in the very important system of Electrical Communication on the Coast for Life-saving purposes, taken in hand by the Government in 1892, at the instance of the Institution. The Royal Commission is still continuing its labours, and thanks to their efforts and to the energy displayed by the Officials of Her Majesty's Post Office, it is earnestly hoped that, provided the Treasury can be persuaded to grant the necessary funds, the system will ere long be complete. Such a system as that contemplated cannot fail to prevent loss of life, and will possibly at no distant date be also found to conduce in no small degree to the commercial interests of the country.

Local Committees, &c.—The best thanks of the Committee are due to all the Local Committees, their Honorary Secretaries and Treasurers, for their much needed and valued services in raising funds for the cause, and their aid in maintaining the Life-boat stations in efficiency. The Committee fully appreciate the fact that, were it not for the important voluntary help received by the Institution in all parts of the country, it would be practically impossible to carry on the work.

The thanks of the Committee are also due to the many patentees and inventors

who have been good enough to submit their proposals and suggestions to the Institution, trusting that they might be utilised for the purposes of the Institution. The Committee are at all times very grateful for any suggestions from any source which may be the means of increasing efficiency.

Life-boat Saturday.—The Life-boat Saturday Fund has developed in a remarkable manner during the past year. Not only has the Ladies Auxiliary of the Fund been favoured and helped by H.R.H. THE DUCHESS OF YORK graciously accepting the post of President of the Auxiliary, but the Fund generally, notwithstanding obstacles and difficulties, has gained ground and prospered. The greatest enthusiasm in the work continues to be shown by the Local and District Committees, and the Central Committee of the Fund, composed of Life-boat Saturday representatives from all parts of the country and which has its office in London, is to be congratulated on the success which has attended the first year of its existence. The number of cities and towns in the United Kingdom which held Life-boat Saturday demonstrations or made Life-boat Saturday collections in 1895 was seventy-four, whereas in the past year the number was increased to one hundred and three, and of this total fifty-three had never moved in the matter before. While some of the cities and towns propose to renew their efforts annually others will do so biennially. The excellent work done by the Central Committee of the Fund during its first season of office argues well for the future, and there is no doubt that under its fostering care the movement has been carried on and extended on more economical lines than formerly was the case. London for the first time participated in the Life-boat Saturday movement last spring, but owing to the short time allowed for making the necessary preparations only twelve out of the eighty districts into which the metropolis has been divided were worked. The results, however, were

very encouraging, and it is expected that this year London will take its proper place among the Life-boat Saturday collections. The Committee are most grateful to all the kind friends throughout the country who have worked so well and with such self-denying enthusiasm, their special thanks being perhaps due to the ladies.

Finances.—The receipts for the past year in subscriptions, donations, dividends, &c., including the amount received from the Life-boat Saturday Fund, were 74,587*l.* 19*s.* 4*d.*, the largest amount received under the head of ordinary income in any year since the Institution was founded in 1824. Large however as this total was, it was insufficient to meet the expenditure for the year, and a considerable draw was made on the "Trust Funds Capital Account."

Numerous legacies, the details of which will be found in another part of the Report, were also received by the Committee during the year, and have been and will be of great service in helping to maintain the Institution's work.

The total expenditure for the year 1896 amounted to 78,664*l.* 5*s.* 7*d.* and comprised 27,511*l.* 10*s.* 10*d.* for building, equipping, improving and repairing Life-boats and Life-boat Carriages, Life-boat Houses and Slipways; 17,099*l.* 8*s.* 5*d.* for Life-belts and other Stores, the Storeyard, Subsidies to non-self-supporting Stations, Branch Payments, and Aneroids for Fishermen and Coasters; 27,087*l.* 6*s.* 11*d.* for payments to Inspectors, Coxswains, Bowmen,

Signalmen; to Crews, &c., for Services and for Exercising the Life-boats, Special Rewards and Recognitions for Services, Grants to the Relatives of Men lost on Service, and for Injuries, also for Medals and Vellums. The remainder was expended in Printing, Advertising, Postage, Telegrams and Stationery; on Salaries, Rent, Rates, Taxes, Housekeeper, &c. Every item of receipt and expenditure has, as usual, been examined, verified and passed by Mr. LOVELOCK, of the firm of Messrs. LOVELOCK, WHIFFEN, and DICKINSON, 19, Coleman Street, E.C., Chartered Accountants.

The Committee, in issuing this their 73rd Annual Report and in submitting to their Supporters and the Public an outline of what has been accomplished during the past year, once again earnestly appeal for renewed effort and increased financial aid for the great cause of life-saving which they have the honour to direct. They feel that the thankfulness of this great maritime nation for the preservation on the throne during the last sixty years of their beloved Queen—the Patron of the Institution—could not be better or more appropriately shown than by contributing to the Life-boat Institution, the object of which is to afford assistance to every shipwrecked person around the coasts of the United Kingdom. They therefore invite special gifts for the Reserve Fund of the Institution to mark the completion of the Sixtieth Year of Her Majesty's Reign in addition to special contributions for the general maintenance of the Service.

RESOLUTIONS PASSED AT THE ANNUAL GENERAL MEETING
FOR 1897.

THE RIGHT HON. G. J. GOSCHEN, M.P., FIRST LORD OF THE ADMIRALTY, IN THE CHAIR.

Moved by The Right Hon. G. J. GOSCHEN, M.P., First Lord of the Admiralty.

“Life-boat Saturday” and “Ladies Auxiliary” Committees up and down the country.

Seconded by Sir COURTENAY BOYLE, K.C.B., Secretary to the Board of Trade.

Moved by Admiral of the Fleet Sir E. COMMEREILL, V.C.

1. That the Annual Report be adopted, printed and circulated.

Seconded by The Right Hon. the Earl of GALLOWAY.

Moved by Capt. the Right Hon. Lord CHARLES BERESFORD, R.N., C.B.

3. That the following Noblemen and Gentlemen be the Officers of the Institution for the current year:—
(*Vide* p. 691 for this list.)

Seconded by Admiral SEYMOUR, C.B., Admiral Superintendent of Naval Reserves.

Moved by Sir EDWARD BIRKBECK, Bart., V.P., Chairman of the Institution.

2. That this Meeting, recognizing the national importance of the great life-saving work of the ROYAL NATIONAL LIFE-BOAT INSTITUTION, and having entire confidence in its management, desires to express its high appreciation of the gallantry of the Life-boat Coxswains and Crews, and of the valuable and self-denying aid given to the cause by the Local Honorary Secretaries, Treasurers, Committees and the Press, as well as by the numerous

Seconded by Colonel FITZROY CLAYTON, V.P., Deputy Chairman of the Institution.

4. That the best thanks of this Meeting be given to the Right Hon. G. J. GOSCHEN, M.P., First Lord of the Admiralty, for so kindly presiding over this the Seventy-third Annual Meeting of the ROYAL NATIONAL LIFE-BOAT INSTITUTION.

ROYAL NATIONAL LIFE-BOAT INSTITUTION,

For the Preservation of Life from Shipwreck

(Incorporated by Royal Charter.)

FOUNDED IN 1824.—SUPPORTED SOLELY BY VOLUNTARY CONTRIBUTIONS.

PATRON.

Her Most Gracious Majesty the Queen.

VICE-PATRONS.

HIS ROYAL HIGHNESS THE PRINCE OF WALES, K.G.
HER ROYAL HIGHNESS THE PRINCESS OF WALES.
HIS ROYAL HIGHNESS THE DUKE OF SAXE-COBURG AND GOTHA, DUKE OF EDINBURGH, K.G.
Captain HIS ROYAL HIGHNESS THE DUKE OF YORK, R.N., K.G.

PRESIDENT.

HIS GRACE THE DUKE OF NORTHUMBERLAND, K.G.

VICE-PRESIDENTS.

His Grace the ARCHBISHOP OF CANTERBURY.
His Grace the DUKE OF PORTLAND, G.C.V.O., P.C.
His Grace the DUKE OF ABERCORN, K.G., C.B.
His Grace the DUKE OF ARGYLL, K.G., K.T., F.R.S.
The Right Hon. the EARL OF LEICESTER, K.G.
The Right Hon. the EARL PERCY, P.C.
The Right Hon. LORD BRASSKY, K.C.B.

Sir EDWARD BIRKBECK, Bart.
L. T. CAVE, Esq.
Colonel FITZROY CLAYTON.
GEORGE PALMER, Esq.
T. B. POTTER, Esq.
HUGH TAYLOR, Esq.
ROBERT WHITWORTH, Esq.

TRUSTEES.

Sir EDWARD BIRKBECK, Bart., V.P. The Right Hon. the EARL PERCY, P.C., V.P. Colonel FITZROY CLAYTON, V.P.

COMMITTEE OF MANAGEMENT.

Sir EDWARD BIRKBECK, Bart., V.P., *Chairman*.
Colonel FITZROY CLAYTON, V.P., *Deputy-Chairman*.

The Most Hon. the MARQUIS OF AILSA.
Captain the Right Hon. LORD CHARLES W. DE LA POER
BRESFORD, R.N., C.B.
ROBERT BIRKBECK, Esq.
E. TOOTAL BROADHURST, Esq.
Admiral JOHN HALLIDAY CAVE, C.B.
L. T. CAVE, Esq., V.P.
Sir WILLIAM CORRY, Bart.
ROBERT COX, Esq., M.P.
ALFRED DREDES, Esq.
General the Right Hon. LORD DE ROS.
GEORGE DOUGHTY, Esq., M.P.
Admiral Sir WILLIAM MONTAGU DOWELL, G.C.B.
Sir ROBERT UNACKER PENROSE FITZGERALD, Bart., M.P.
JOHN BEVILL FORTESCUE, Esq.
Lieut. H. T. GARTSIDE-TIPPING, R.N.
The Rt. Hon. G. J. GOSCHEN, M.P., First Lord of the Admiralty.
Admiral Sir RICHARD VESRY HAMILTON, G.C.B.
WILLIAM HEARLE LYALL, Esq., M.A.
Admiral Sir F. LEOPOLD MCCLINTOCK, K.C.B., F.R.S.
EUGENE F. NORL, Esq.
Sir CHARLES MARK PALMER, Bart., M.P.

H. J. PALMER, Esq.
The Right Hon. the EARL PERCY, P.C., V.P.
Admiral Sir AUGUSTUS PHILLIMORE, K.C.B.
ROBERT A. B. PRESTON, Esq.
The Right Hon. LORD ROBATERS.
Sir THOMAS SUTHERLAND, K.C.M.G., M.P., *Chairman* of the Peninsular and Oriental Steam Navigation Company.
The ADMIRAL SUPERINTENDENT OF NAVAL RESERVES.
The Right Hon. LORD TWEDMOUTH.
The Right Hon. the EARL WALDEGRAVE, Captain of the Yeomen of the Guard.
JOHNSTONE WALLACE, Esq.
Admiral THOMAS LE HUNTE WARD, C.B.
Captain Sir J. SYDNEY WEBB, K.C.M.G., *Deputy-Master* of the Trinity House.
Rear-Admiral W. J. L. WHARTON, C.B., F.R.S., *Hydrographer* of the Admiralty.
Sir RICHARD HENRY WILLIAMS-BULKLEY, Bart.
Captain His Royal Highness the DUKE OF YORK, R.N., K.G.
Captain the Hon. J. MANNERS YORKER, R.N.
Sir ALLEN YOUNG, C.B.

SECRETARY—CHARLES DIBDIN, Esq., F.R.G.S.

ASSISTANT SECRETARY—W. R. SMITH, Esq.

CHIEF INSPECTOR OF LIFE-BOATS—Commander ST. VINCENT NEPEAN, R.N.

DEPUTY CHIEF INSPECTOR OF LIFE-BOATS—CHARLES E. F. CUNNINGHAME GRAHAM, Esq., late Lt. R.N.

DISTRICT INSPECTORS OF LIFE-BOATS.

Northern District—EUSTACE W. C. STRACKET, Esq., late Lieut. R.N., Edinburgh.
Eastern District—Commander THOMAS HOLMES, R.N., London.

Southern District—KEPPEL H. FOOTE, Esq., late Lieut. R.N., London.
Western District—Commander T. H. WILLOUGHBY BEDDOES, R.N., Bristol.

Irish District—BASIL HALL, Esq., late Lieut. R.N., Dublin.

ENGINEER AND ARCHITECT—W. T. DOUGLASS, Esq., M.Inst.C.E.

CONSULTING NAVAL ARCHITECT—G. L. WATSON, Esq.

SURVEYOR OF LIFE-BOATS—MR. J. LUTHER EVANS.

BANKERS—Messrs. COURTIS AND CO., 59 Strand.

TREASURER—HUGH LINDSAY ANTROBUS, Esq.

SOLICITORS—Messrs. CLAYTON, SONS & FARGUS. AUDITOR—SAMUEL LOVELOCK, Esq., Public Accountant, F.C.A.

The object of this Institution, as declared in its title and in its Charter of Incorporation, is to afford assistance to every shipwrecked person around the Coasts of the United Kingdom.

The chief means by which the Society endeavours to carry this object into effect are—

By building, stationing, and maintaining in repair, Life-boats of the most perfect description; furnishing them with all necessary Appurtenances, including Houses to preserve them in, and Carriages for their conveyance to the spots where their Services are called for; and further, providing, through the instrumentality of Local Committees, for their proper Management and the occasional Exercise of their Crews.

By conferring Honorary Rewards in the form of Medals and Votes of Thanks, and also making liberal grants of money to all persons who, at the risk of their own lives, save, or attempt to save those of others on board vessels wrecked, or in distress, upon any part of the Coast of the United Kingdom.

The number of lives saved either by the Life-boats of the Institution, or by special exertions for which it has granted rewards, since its formation, is 39,815.

Annual Subscriptions and Donations are thankfully received by the Secretary, CHARLES DIBDIN, Esq., at the Institution, 14 JOHN STREET, ADLPHI, LONDON, W.C.; by the Bankers of the Institution, Messrs. COURTIS AND CO., 59 Strand; by all the other Bankers in the United Kingdom; and by all the Life-boat Branches.

Dr.	£. s. d.	£. s. d.	Cr.
To NEW LIFE-BOATS, (exclusive of carriages and equipment) for the following Stations:—			By General Subscriptions
Ayr, Ballycotton, Blackpool, Brixham, Broadstairs, Carrickfergus, Castletown, Port St. Mary, Ramsey, Rhyl, Teignmouth, Walmer and Winterton No. 1	6,421 14 7		(see p. 767) 4,536 6 -
Repairs and maintenance of Steam Life-boats Nos. 1 & 2	1,365 15 7		" General Donations (see p. 767) 5,997 17 8
Payments on account of Steam Life-boat No. 3	1,628 1 3		" Contributions from Branches (see p. 769) 16,822 7 5
Alterations and repairs of other Life-boats	3,620 12 6		" "Life-boat Saturday" Collections 16,205 18 5
Consulting Naval Architect, Surveyor, Assistant Surveyors and Draughtsmen	2,480 12 3		" "Life-boat Sunday" Collections and Offer-tories (excluding those sent direct to Branches) (see p. 770) 161 11 5
	15,516 16 2		" Contribution Boxes (see p. 771) 520 4 2
To NEW LIFE-BOAT CARRIAGES, viz.:			" Special Gifts, amounting to £9,774 1s. 4d., for Life-boat Establishments as follows:—
Blackpool, Castletown, Formby, Hayling, Hoylake, Jersey, Lytham, Mablethorpe, Margate, Penzance, Port St. Mary, Ramsey, Rhyl, Scarborough, Teignmouth and Tynemouth No. 1	2,351 12 -		Abersoch — Oldham Fund (additional) 70 - -
Alterations and Repairs of Life-boat Carriages and Tipping's Sand-plates for Life-boat Carriage-wheels	677 16 11		Caister—Covent Garden Fund (additional) 66 11 2
	3,029 8 11		Cullercoats—Co-operative Union, Limited (additional) 723 11 4
To LIFE-BOAT HOUSES AND SLIPWAYS, viz.:			Douglas, Kingstown, Maryport, Port Patrick, Tynemouth No. 1, Walmer and Wexford—Civil Service Life-boat Fund, per Charles Dibdin, Esq. (additional). 2,076 7 7
Barmouth	202 - -		Hunstanton—Licensed Victuallers' Fund (additional), per A. L. Annett, Esq. 50 - -
Brixham	500 - -		Liverpool (Steam Life-boat No. 3)—Port of Liverpool Branch 3,497 11 3
Broadstairs	188 - -		Palling (No. 2) — "Hearts of Oak" Fund (additional) 50 - -
Bull Bay	128 - -		
Burry Port	360 - 10		
Castletown	245 - -		
Cullercoats	1,048 11 4		
Giles' Quay	120 - -		
Gorleston No. 3	162 4 2		
Jersey	366 19 -		
Littlehaven	103 - -		
Mevagissey	548 16 8		
Port St. Mary	375 - -		
Rhosneigir	109 - -		
Sennen Cove	885 - -		
Tenby	122 3 -		
Uppang	141 1 3		
Whitby	208 5 6		
Alterations, Repairs and Painting of Life-boat Houses	1,801 7 2		
Engineer and Architect's charges	1,350 16 10		
	8,965 5 9		
" Life-boat Stores and Life-belts	7,738 13 3		
" Life-boat Store-Yard at Poplar, including Rent, Taxes, Insurance, Repairs, Salary of Storekeeper and Wages	1,478 10 8		
Carried forward	£36,728 14 9		Carried forward £50,778 6 5

Dr.	£.	s.	d.		Cr.	£.	s.	d.
	36,728	14	9	Brought forward . . .		50,778	6	5
To Subsidies to Stations not Self-supporting, Branch Payments, Formation of New Branches, and Conveyance of Boats, Carriages and Stores	7,800	6	8		By Special Gifts— <i>continued.</i>			
„ Life-boat Inspectors, Coxswains, Bowmen, Signalmen and Crews, &c., viz. :—					Isaac Hoyle, Esq.	1,000	-	-
Payments to Coxswains, Bowmen and Signalmen, and to Life-boat Crews and Launchers for exercising the Life-boats quarterly £11,721 6 2	11,721	6	2		Miss Leicester	840	-	-
Life-boat Crews for Services, Special Rewards and Recognitions, Grants to Relatives of men lost on Service, and to men injured on Service, Medals and Vellums	10,616	18	-		T. E. W.	700	-	-
	22,338	4	2		Samuel Turner, Esq.	700	-	-
Salaries of Inspectors of Life-boats	3,051	10	10		„ Dividends and Interest 17,547 14 5			
Travelling expenses of In- spectors	1,697	11	11		„ Ditto, Special Trust Funds (see p. 694)	578	3	1
	27,087	6	11		„ Income tax returned by Inland Revenue Com- missioners	322	2	3
„ Grants to Fishermen and Coasters for the purchase of Aneroid Barometers.	81	17	10		„ Amount received for <i>Life-boat Journals,</i> Advertisements on cover of same, Barometer Pads, &c.	407	5	7
„ Salaries of Secretary, Assistant Secretary and Clerical Staff	3,253	19	-		„ Amount received for sale of old Life-boats, Life-boat Carriages, Life-boat House Site, Condemned Stores, Waste Paper, &c.	456	15	9
„ Printing <i>Life-boat Journal</i> , Annual Report, Circulars and Binding.	1,145	14	5		„ Life-boats' Shares of Property Salvage earned by Crews	185	15	2
„ Stationery and Office Expenses	666	1	4		„ Rent from Sub-Tenants in House of Institution	71	16	8
„ Advertisements, Appeals, Telephone, Postages and Parcels	944	10	5					
„ Auditor's Fee	73	10	-					
„ Law Expenses in connection with Leases, Bequests, &c.	198	17	5					
„ Rent, Taxes, Insurance, Housekeeper and Messenger	293	5	11					
„ Repairs to House of Institution	328	16	10					
„ Annual Meeting	61	4	1					
Total Expenditure	£78,664	5	7		„ Total ordinary Income 73,587 19 4			
Less transferred from Trust Funds Capital Account (see p. 694) for Life-boats, Boat Houses, &c., included in above expenditure, defrayed by Special Legacies and Donations	3,207	10	3		„ Extraordinary Income— Donation (see p. 767)— E. H. E. 1,000 - -			
	£75,456	15	4		Legacies (see p. 768)— In trust 12,713 11 5 For General purposes 29,734 19 10			43,448 11 3
Transfer to Trust Funds Capital Account— Trust Legacies received during the year as per contra	12,713	11	5					
Endowment— Palling, as per contra	50	-	-					
Special gifts unappropriated— Isaac Hoyle, Esq., Miss Leicester, T. E. W., and S. Turner, Esq., as per contra	3,240	-	-					
	16,003	11	5					
Balance carried to General Capital Account	25,576	3	10					
	£117,036	10	7					£117,036 10 7

* All the money received by the Institution from the Life-Boat Saturday Fund in 1896 was utilised for this expenditure.

SPECIAL TRUST FUNDS

To TRANSFERS TO INCOME AND EXPENDITURE ACCOUNT (see p. 693)	£. s. d.	£. s. d.
Blake Life-boat Maintenance Fund	37 15 1	
Dunnett Widows and Orphans Fund	132 8 8	
General Widows and Orphans Fund	14 9 8	
Reardon Samaritan Fund	146 17 8	
Paterson Widows and Orphans Fund	232 17 -	
Hosken Maintenance Fund	13 15 -	
	<hr/>	578 3 1
„ TRANSFER TO TRUST FUNDS CAPITAL ACCOUNT (see p. 695)		4 8 -
„ BALANCE AS PER BALANCE SHEET (see p. 696) :-		
Blake Life-boat Maintenance Fund	47 9 10	
Blake Life-boat Reward Fund	961 17 6	
	<hr/>	1,009 7 4
		<hr/>
		£1,591 18 5
		<hr/> <hr/>

TRUST FUNDS CAPITAL ACCOUNT,

To EXPENDITURE DURING THE YEAR 1896, as per Income and Expenditure Account (see p. 693)	3,207 10 3
„ BALANCE, as per BALANCE SHEET (see p. 696).	159,039 11 4
	<hr/>
	£162,247 1 7
	<hr/> <hr/>

GENERAL CAPITAL ACCOUNT,

To BALANCE, as per BALANCE SHEET (see p. 696)	444,405 19 5
	<hr/>
	£444,405 19 5
	<hr/> <hr/>

INCOME ACCOUNT, 1896.

By BALANCE at 1st JANUARY, 1896:—	£. s. d.	£. s. d.
Blake Life-boat Maintenance Fund	35 14 11	
Blake Life-boat Reward Fund	887 12 6	
Dunnett Widows and Orphans Fund	16 18 8	
General Widows and Orphans Fund	9 12 10	
Paterson Widows and Orphans Fund	77 12 4	
	<hr/>	1,027 11 3

,, DIVIDENDS RECEIVED DURING THE YEAR 1896:—

Blake Life-boat Maintenance Fund	49 10 -	
Blake Life-boat Reward Fund	74 5 -	
Dunnett Widows and Orphans Fund	115 10 -	
General Widows and Orphans Fund	4 16 10	
Reardon Samaritan Fund	146 17 8	
Paterson Widows and Orphans Fund	155 4 8	
Hosken Maintenance Fund	13 15 -	
T. E. W. Special Life-boat Fund	4 8 -	
	<hr/>	564 7 2
		<hr/>
		£1,591 18 5

31st December, 1896.

By BALANCE at 1st JANUARY, 1896	146,239 2 2
,, TRUST LEGACIES received during the Year	12,713 11 5
,, ENDOWMENT	50 - -
,, SPECIAL GIFTS unappropriated during the Year	3,240 - -
,, INTEREST added to T. E. W.'s Special Fund (see p. 694)	4 8 -
	<hr/>
	£162,247 1 7

31st December, 1896.

By BALANCE at 1st JANUARY, 1896	565,068 1 9
LESS TRANSFERRED TO TRUST FUNDS CAPITAL ACCOUNT	146,239 2 2
	<hr/>
	418,828 19 7
,, CASH ON CONVERSION OF NORTH EASTERN RAILWAY STOCK	- 16 -
,, BALANCE from INCOME AND EXPENDITURE ACCOUNT	25,576 3 10
	<hr/>
	£444,405 19 5

LIABILITIES.

	£.	s.	d.
To SPECIAL TRUST FUNDS INCOME ACCOUNT (see p. 694).	1,009	7	4
„ TRUST FUNDS CAPITAL ACCOUNT (see p. 694)	159,039	11	4
„ GENERAL CAPITAL ACCOUNT (see p. 694).	444,405	19	5

£604,454 18 1

(Signed) CHARLES DIBDIN,
Secretary.

ASSETS.

	£.	s.	d.
By Consolidated 2½ per cent. Stock (repayable in 1923) cost	181,085	0	4
„ 2½ per cent. Annuities (repayable in 1905) † „	5,835	6	-
„ Metropolitan 3½ per cent. Stock „	28,156	5	-
„ India 3 per cent. Stock „	54,141	7	5
„ India 3½ per cent. Stock „	29,156	1	5
„ East India Railway 4½ per cent. Debenture Stock „	30,124	7	6
„ East India Railway Company's Annuity Class B £56 † „	1,428	-	-
„ Bank of Victoria Deposit Notes † „	7,290	-	-
„ London Bank of Australia Deposit Note † „	8,000	-	-
„ Caledonian Railway 4 per cent. Debenture Stock „	19,597	10	-
„ Great Northern Railway Company's 4 per cent. Consolidated } Preference Stock }	17,800	-	-
„ Great Northern Railway 6 per cent. Stock B † „	300	-	-
„ Great North of Scotland Railway 4 per cent. Debenture Stock „	26,161	7	6
„ Great Western Railway Consolidated Guaranteed 5 per cent. Stock „	17,518	15	-
„ London, Tilbury and Southend Railway 4 per cent. Preference Stock „	9,997	4	9
„ London and Blackwall Railway Company's Consolidated Stock † „	274	-	-
„ London and South Western Railway 3 per cent. Debenture Stock „	10,005	5	6
„ Midland Railway 3 per cent. Debenture Stock „	25,007	18	6
„ North British Railway 3 per cent. Debenture Stock „	27,072	4	-
„ North Eastern Railway 3 per cent. „ „ „	29,387	15	-
„ Russian Nicolas Railway 4 per cent. Bonds † „	400	-	-
„ Isle of Man 3½ per cent. Debenture Bonds „	21,497	10	-
„ Manchester Corporation 4 per cent. Perpetual Annuities Bond † „	300	-	-
„ Stockport Corporation 3 per cent. Stock „	12,097	-	-
„ Liverpool Corporation 3½ per cent. Stock „	6,000	-	-
„ East London Waterworks Company (Ordinary Stock) † „	3,516	8	4
„ 35 £50 Grand Junction Waterworks Company Shares † „	3,920	-	-
„ Royal Victoria Yacht Club 5 per cent. Debenture Bonds † „	125	-	-
„ Messrs. Coutts & Company (Deposit) „	28,000	-	-
„ Balance at Bankers „	260	2	10
	£604,454 18 1		

† Presented to the Institution.

I have examined these Accounts, together with the relative Invoices and Vouchers, and found the same correct. I have also satisfied myself that the Securities representing the Investments of the Institution are in order.

(Signed) SAMUEL LOVELOCK,
Chartered Accountant,
Auditor.

2nd February, 1897.

STATION.		Length.	Breadth.	No. of Oars.	When Stationed or Named.	No.
ENGLAND.						
		Ft. in.	Ft. in.			
NORTHUMBERLAND	BERWICK-ON-TWEED - - -	37 -	8 -	12	1888	1
	HOLY ISLAND—No. 1 - - -	34 -	8 3	10	1884	2
	" " No. 2 - - -	31 -	7 3	10	1891	3
	BAMBURGH CASTLE - - -	34 -	7 6	10	1889	4
	NORTH SUNDERLAND - - -	34 -	8 -	10	1884	5
	BOULMER - - -	34 -	8 -	10	1892	6
	ALNMOUTH - - -	34 -	7 6	10	1888	7
	HAUXLEY - - -	37 -	8 -	12	1888	8
	CRESSWELL - - -	34 -	7 6	10	1889	9
	NEWBIGGIN - - -	37 -	8 6	12	1885	10
	BLYTH—No. 1 - - -	34 -	8 -	10	1886	11
	" No. 2 - - -	31 -	7 3	10	1889	12
	CULLERCOATS - - -	37 -	8 -	12	1884	13
	DURHAM	TYNEMOUTH—No. 1 - - -	37 -	8 -	12	1888
" No. 2 - - -		33 -	8 -	10	1872	15
WHITBURN - - -		34 -	8 -	10	1881	16
ROKER - - -		31 -	7 3	10	1889	17
SUNDERLAND, SOUTH PIER - - -		34 -	7 6	10	1892	18
" SOUTH OUTLET - - -		38 -	8 -	12	1894	19
SEAHAM - - -		34 -	8 -	10	1887	20
HARTLEPOOL—No. 1 - - -		34 -	8 -	10	1889	21
" No. 2 - - -		34 -	8 -	10	1887	22
" No. 3 - - -		34 -	8 -	10	1887	23
WEST HARTLEPOOL - - -	34 -	8 -	10	1887	24	
YORKSHIRE	SEATON CAREW - - -	34 -	8 -	10	1888	25
	REDCAR - - -	34 -	8 3	10	1884	26
	SALTBURN - - -	34 -	8 3	10	1880	27
	STAITHES - - -	34 -	7 6	10	1894	28
	RUNSWICK - - -	34 -	7 6	10	1893	29
	UPGANG - - -	34 -	7 6	10	1890	30
	WHITBY—No. 1 - - -	34 -	8 -	10	1881	31
	" No. 2 - - -	34 -	7 9	10	1895	32
	ROBIN HOOD'S BAY - - -	32 -	8 -	10	1881	33
	SCARBOROUGH - - -	34 -	8 3	10	1895	34
	FILEY - - -	34 -	8 -	10	1884	35
	FLAMBOROUGH—No. 1 - - -	34 -	8 -	10	1887	36
	" No. 2 - - -	33 -	8 -	10	1882	37
	BRIDLINGTON QUAY - - -	34 -	7 6	10	1885	38
BARMSTON - - -	34 -	7 6	10	1884	39	
LINCOLNSHIRE	HORNSEA - - -	34 -	7 6	10	1887	40
	WITHERNSEA - - -	34 -	8 3	10	1883	41
	GRIMSBY - - -	38 -	9 -	12	1894	42
	DONNA NOOK - - -	34 -	7 6	10	1889	43
	MABLETHORPE - - -	34 -	8 3	10	1883	44
	SUTTON - - -	31 -	7 3	10	1888	45
	CHAPEL - - -	31 -	7 3	10	1888	46
	SKEGNESS - - -	37 -	8 -	12	1888	47
	HUNSTANTON - - -	34 -	7 6	10	1887	48
	NORFOLK	BRANCASTER - - -	34 -	8 -	10	1892
WELLS - - -		35 3	10 3	14	1895	50
BLAKENEY - - -		35 3	10 3	14	1891	51
SHERINGHAM - - -		41 -	9 3	14	1886	52
CROMER - - -		35 -	10 -	14	1884	53
HASBOROUGH - - -		34 -	7 6	10	1887	54

No.	NAME OF BOAT AND DONOR	NAME AND ADDRESS OF HONORARY SECRETARY.
1	<i>John and Janet</i> —Mrs. Barr's Bequest . . .	B. G. Sinclair, Esq., Berwick-on-Tweed.
2	<i>Grace Darling</i> —Miss Egdell's Bequest . . .	Rev. D. Bryson, Holy Island, Beal, R.S.O. [umberland.
3	<i>Beaford</i> —Miss A. M. Bedford's Trustees . . .	J. F. Hutchinson, Esq., Bamburgh Hall, Belford, North-
4	* <i>John and Betty Cuttell</i> —The late Mr. Cuttell	Rev. A. M. MacPhee, N. Sunderland, Chathill, R.S.O.
5	<i>Thomas Bewick</i> —Miss Bewick's Legacy . . .	Robert Brown, Esq., Little Houghton, Lesbury, R.S.O.
6	<i>Meliscant</i> —Miss M. Fielder's Legacy . . .	Rev. D. Moore, The Vicarage, Alnmouth, R.S.O.,
7	<i>Allen Scott</i> —Mrs. Scott's Bequest . . .	Northumberland.
8	<i>Algernon & Eleanor</i> —Her Grace the Dowager Duchess of Northumberland.	Rev. James Fairbrother, Amble, Acklington.
9	<i>Ellen and Eliza</i> —Anonymous	F. Wetherell, Esq., Ellington, Morpeth.
10	<i>Robert and Susan</i> —The late Miss E. H. Jacomb-Hood.	John Tate, Esq., Newbiggin-by-the-Sea, Morpeth.
11	<i>Dalmer</i> —Mrs. Dalmer's Legacy	John R. Easton, Esq., 7, Bath Terrace, Blyth, North-
12	<i>Oswald, Sarah and Jane</i> —Mrs. Stoker . . .	umberland.
13	<i>Co-operator No. 1</i> —The Co-operative Union, Limited	R. J. Leeson, Esq., Cullercoats, T.S.O., Whitley, [R.S.O., Northumberland.
14	* <i>Charles Dibdin</i> —Civil Service No. 2 Fund.	Tynemouth, North Shields.
15	<i>Forester</i> —A. O. of Foresters	W. H. Williamson, Esq., Whitburn, Sunderland.
16	* <i>William and Charles</i> —A Lady	
17	<i>William Hedley</i> —Mr. Hedley's Legacy . . .	F. O. Pinkney, Esq., 55 John Street, Sunderland.
18	<i>Junius</i> —The late Mr. Coppin . . . [Legacy.	[Sunderland.
19	<i>Richard and Nellie Hodges</i> —Mrs. Hodges'	William Warham, Esq., Londonderry Offices, Seaham,
20	<i>Skynner</i> —Mr. Skynner's Legacy	
21	<i>Imminster</i> —Mr. Lovibond's Legacy	S. Herbert Belk, Esq., Hartlepool.
22	* <i>Charles Ingleby</i> —Trust Fund, per G. P. Wragge, Esq.	Alfred Belk, Esq., Hartlepool.
23	<i>Cyclist</i> —That Jubilee Fund	John N. Taylor, Esq., Dock Office, North Eastern Railway, West Hartlepool. [Durham.
24	<i>Foresters' Pride</i> —A. O. of Foresters . . .	Rev. C. B. R. Hunter, B.A., Seaton Carew, R.S.O., co. J. M. Meek, Esq., Coatham, T.S.O., Redcar.
25	<i>John Lawson</i> —R. N. L. B. Institution . . .	Mr. T. G. Pearson, Saltburn-by-the-Sea.
26	<i>Brothers</i> —E. B., M. P., and A. and E. I., Cheddar.	
27	<i>Charles and Ann</i> —Mrs. Townend, per Man- chester Branch.	Dr. J. B. Laverick, Hinderwell, R.S.O., Yorkshire.
28	<i>Jonathan Stott</i> —Mrs. Stott's Legacy . . .	
29	<i>Cape of Good Hope</i> —Mr. C. Hawkins' Le- gacy	Mr. Robert Gibson, Harbour Master, Whitby.
30	<i>Uppang</i> —Anonymous [gacy.	
31	* <i>Robert and Mary Ellis</i> —Late Mrs. Ellis . .	Rev. R. Jermyn Cooper, M.A., Fylingdales Vicarage, Robin Hood's Bay Station (R.S.O.), Yorkshire.
32	* <i>John Fielden</i> —J. A. Fielden, Esq.	John Stephenson, Esq., King's Cliff, Scarborough.
33	<i>Ephraim and Hannah Fox</i> —Mr. and Mrs. Fox's Children	James H. Mackwood, Esq., Scarborough. [Yorkshire.
34	* <i>Queensbury</i> —Herbert A. Foster, Esq. (En- dowed by his brothers, uncles, and himself)	Mr. J. Lewis, Chief Officer H. M. Ct. Gd., Filey, R.S.O., Mr. James Woodhouse, Croft's Farm, Flamborough, Hull.
35	* <i>Hollon the Second</i> —Late R. W. Hollon, Esq.	Captain Atkin, Bay View, Esplanade, Bridlington Quay.
36	<i>Mary Frederick</i> —Mrs. Preston's Legacy . .	W. F. Collinson, Esq., Hornsea, Hull.
37	<i>Matthew Middlewood</i> —G. Middlewood, Esq.	Horatio H. Ayre, Esq., Withernsea, Hull.
38	<i>William John and Frances</i> —Mr. Payne's Legacy	Capt. Thomas Jewitt, Grimsby.
39	* <i>George and Jane Walker</i> —Mr. Walker's Legacy	Mr. Gilbert Houlden, North Somercotes, Grimsby.
40	* <i>Ellen and Margaret of Settle</i> —Settle Fund.	Dr. Iredale, Mablethorpe, R.S.O., Lincolnshire.
41	<i>Admiral Rous</i> —That Life-boat Fund	Mr. B. Simons, Sutton, R.S.O., Lincolnshire.
42	<i>Manchester Unity</i> —I. O. of Odd Fels. (M.U.)	Mr. W. G. West, Chapel St. Leonards, Alford, Lincolnshire.
43	* <i>Richard</i> —Miss Anne Dixon [dale, Esq.	C. F. Grantham, Esq., Skegness, R.S.O., Lincolnshire.
44	<i>Heywood</i> —The late A. P. Heywood—Lons- dale	Rev. H. D. Barrett, B.A., St. Edmund's Vicarage, Hunstanton, R.S.O., Norfolk.
45	<i>Elizabeth Berrey</i> . . . } Miss Berrey's	Rev. E. K. Kerlake, M.A., Deepdale Rectory, King's Herbert E. Loynes, Esq., Wells, Norfolk. [Lynn.
46	<i>John Alexander Berrey</i> . . . } Legacy	Rev. R. H. Tillard, M.A., Blakeney, Holt, R.S.O., Norfolk.
47	<i>Ann, John, and Mary</i> —Miss Ball's Legacy.	Wyndham Cremer, Esq., J.P., Beeston Regis, Cromer.
48	<i>Licensed Victualler</i> —Licensed Victuallars . .	W. G. Sandford, Esq., Cromer.
49	<i>Alfred S. Genth</i> —Mrs. Silkenstädt	Rev. G. Spackman, M.A., Happisburgh, Norwich.
50	<i>Baltic</i> —That Life-boat Fund	[Continued.
51	<i>Zaccheus Burroughes</i> —Mrs. Burroughes' Legacy	
52	<i>William Bennett</i> —Mr. Bennett's Legacy . .	
53	<i>Benjamin Bond Cabbell</i> —Miss Egdell's Legacy	
54	<i>Huddersfield</i> —Huddersfield	

* This Life-boat is endowed.

STATION.		Length.		Breadth.	No. of Oars.	When Stationed or Named.	No.		
		Ft.	in.	Ft.	in.				
NORFOLK	PALLING—No. 1	37		8	9	12	1884	55	
	" No. 2	40		12		14	1893	56	
	WINTERTON—No. 1	34		10		12	1896	57	
	" No. 2	44		12	2	12	1890	58	
	CAISTER—No. 1	42		11	6	14	1883	59	
	" No. 2	36		10	6	12	1892	60	
	YARMOUTH	32		9	7	12	1892	61	
	GORLESTON—No. 1	46		12	9	14	1892	62	
	" No. 2	31		9		12	1894	63	
	" No. 3	31		9		12	1892	64	
SUFFOLK	LOWESTOFT—No. 1	44		12	1	14	1876	65	
	" No. 2	46		12	9	14	1893	66	
	PAKEFIELD	46		12		14	1886	67	
	KESSEINGLAND—No. 1	43		12	9	14	1893	68	
	" No. 2	32		10		12	1879	69	
	" No. 3	38		12		12	1884	70	
	SOUTHWOLD—No. 1	44		13		12	1893	71	
	" No. 2	30		9		12	1882	72	
	DUNWICH	34		8		10	1894	73	
	THORPENESS	39		9		12	1890	74	
ESSEX	ALDEBURGH	46		12	7	14	1890	75	
	HARWICH—No. 1	45		11		12	1881	76	
	" No. 2 (STEAM)	52		15	2	—	1894	77	
	WALTON-ON-THE-NAZE	37		9		12	1884	78	
	CLACTON-ON-SEA	39		9		12	1885	79	
SOUTHEND	34		7	6	10	1885	80		
KENT	MARGATE	37		9		12	1883	81	
	KINGSGATE	31		7	3	10	1889	82	
	BROADSTAIRS	39		9		12	1888	83	
	RAMSGATE	42		11		12	1893	84	
	NORTH DEAL	42		11		12	1888	85	
	WALMER	40		10		12	1884	86	
	KINGSDOWNE	40		10		12	1890	87	
	DOVER	37		8		12	1888	88	
	FOLKESTONE	38		8		12	1893	89	
	HYTHE	37		8		12	1884	90	
	NEW ROMNEY	34		7	6	10	1884	91	
	DUNGENESS—No. 1 (LYDD)	34		8		10	1894	92	
	SUSSEX	" No. 2	44		11		12	1892	93
RYE		34		8		10	1893	94	
WINCHELSEA		34		7	9	10	1883	95	
HASTINGS		34		8		10	1880	96	
EASTBOURNE		34		8	3	10	1880	97	
NEWHAVEN		37		9		12	1881	98	
BRIGHTON		34		7	6	10	1888	99	
SHOREHAM		34		7	6	10	1890	100	
WORTHING		34		7	6	10	1887	101	
LITTLEHAMPTON		34		7	6	10	1888	102	
HAMPSHIRE	SELSEY	40		10		12	1894	103	
	HAYLING ISLAND	34		7	6	10	1888	104	
	SOUTHSEA	37		9		10	1886	105	
	ISLE OF WIGHT	RYDE	28	6	6	3	8	1894	106
		BEMBRIDGE	34		7	6	10	1887	107
ATHERFIELD		34		7	6	10	1892	108	
BRIGHTSTONE GRANGE		34		8		10	1892	109	
BROOKE		34		7	6	10	1888	110	
TOTLAND BAY	37		8		12	1885	111		
JERSEY	ST. HELIER'S	34		8		10	1888	112	
	GUERNSEY	34		8		10	1888	113	
	ST. PETER'S PORT	34		8		10	1888	113	

No.	NAME OF BOAT AND DONOR.	NAME AND ADDRESS OF HONORARY SECRETARY.
55	<i>Good Hope</i> —Rev. W. J. Guerrier	} Mr. E. French, Palling, Norwich.
56	* <i>Hearts of Oak</i> —That Benefit Society	
57	<i>Edward Birkbeck</i> —R. N. L. B. Institution	} Rev. W. A. Green, M.A., Winterton, Great Yarmouth.
58	<i>Margaret</i> —Miss Eason's Legacy	
59	<i>Covent Garden</i> —That Life-boat Fund	} A. F. Clowes, Esq., 21 Howard Street South, Great Yarmouth.
60	<i>Beauchamp</i> —Sir R. Proctor-Beauchamp, Bt.	
61	<i>John Burch</i> —Mrs. Burch	} Douglas Hewett, Esq., Gorleston, T.S.O., Gt. Yarmouth.
62	<i>Mark Lane</i> —London Corn Exchange	
63	<i>Leicester</i> —Town of Leicester	} H. W. Case, Esq., Upper Cliff Road, Gorleston, T.S.O., Great Yarmouth.
64	<i>Thora Zelma</i> —James McLaren Smith, Esq.	
65	<i>Samuel Plimsoll</i> —Plimsoll Life-boat Funds	} B. Preston, Esq., M.A., J.P., Lowestoft.
66	<i>Stock Exchange</i> —That Life-boat Fund	
67	<i>The Two Sisters, Mary and Hannah</i> —The late Mr. Thomas Parkin	} T. F. Davies, Esq., The Bungalow, Pakefield, T.S.O., [Lowestoft.
68	<i>Bolton</i> —Town of Bolton [Fund.	
69	<i>St. Michael's, Paddington</i> —That Life-boat	} Mr. John Styles, Chief Boatman H.M. C. G ^d ., Kessingland, Lowestoft.
70	<i>Charles Bury</i> —Mr. Bury's Legacy	
71	<i>Alfred Corry</i> —Mr. Corry's Legacy	} Mr. J. Sinclair, Southwold, R.S.O., Suffolk.
72	<i>Quiver No. 2</i> —Quiver Magazine	
73	<i>Lily Bird</i> —Samuel Bird, Esq. . . .	} Edward T. Lingwood, Esq., Dunwich, Saxmundham.
74	<i>Christopher North Graham</i> —Mrs. C. North Graham and her sons and daughters.	
75	<i>Aldeburgh</i> —Anonymous	} H. P. Todd, Esq., Crown Lodge, Sizewell, Saxmundham. [Suffolk.
76	<i>Springwell</i> —Miss Burmester	
77	<i>City of Glasgow</i> —That Life-boat Fund	} J. O. Williams, Esq., H.M. C. G ^d ., Aldeburgh, R.S.O., [Essex.
78	<i>Honourable Artillery Company</i> —Their Dramatic Club.	
79	* <i>Albert Edward</i> —Freemasons of England	} Fred. W. Lewellen, Esq., Clacton-on-Sea, R.S.O., Essex.
80	<i>Theodore and Herbert</i> —Mrs. F. S. Smith's Legacy	
81	<i>Quiver No. 1</i> —Quiver Magazine	} G. S. Manuelle, Esq., Park Road, Southend-on-Sea. [Essex.
82	<i>Thomas Chapman</i> —R. N. L. B. Institution.	
83	<i>Christopher Waud, Bradford</i> —Late Mr. G. M. Waud.	} Mr. T. Jephcott, Ship Hotel, Margate. [gate.
84	<i>Bradford</i> —Town of Bradford	
85	<i>Mary Somerville</i> —Miss Somerville's legacy	} Col. Isacke, North Foreland Lodge, Broadstairs. [gate.
86	* <i>Civil Service No. 4</i> —Civil Service Fund	
87	<i>Charles Hargrave</i> —His Legacy	} Mr. W. Jenkins, Ch. Off. H.M. C. G ^d ., Kingsgate, Margate.
88	<i>Lewis Morrice</i> —Mrs. Morrice's Legacy	
89	<i>J. McConnel Hussey</i> —Miss Curling	} Mr. Thomas Jackson, Alexandra Road, Broadstairs.
90	* <i>Mayer de Rothschild</i> —Late Lady Rosebery.	
91	<i>Sandal Magna</i> —Joseph Spawforth, Esq. . . .	} Capt. E. Jones, Harbour Master, Ramsgate.
92	<i>R.A.O.B.</i> —Royal Antediluvian Order of Buffaloes Life-boat Fund.	
93	<i>Thomas Simcox</i> —The late Mrs. Simcox	} Rev. T. S. Treanor, M.A., Upper Deal, T.S.O., Deal.
94	<i>Edward and Lucille</i> —Mrs. Collinson's Legacy.	
95	<i>Frances Harris</i> —Her Legacy	} Lieut.-General Bruce, C.B., 1 East Cliff, Dover.
96	* <i>Charles Arkcoll</i> —Charles Arkcoll, Esq. . . .	
97	<i>William and Mary</i> —Friends at Manchester	} Mr. Walter D. Fagg, Bathing Establishment, Folkestone.
98	<i>Michael Henry</i> —Jewish Scholars' Life-boat Fund. [petition.	
99	<i>Sunlight No. 2.</i> —Messrs. Lever Bros.' Com.	} George Wilks, Esq., Hythe, Kent.
100	* <i>William Restell</i> —Mr. Restell's Legacy	
101	<i>Henry Harris</i> —Mr. Harris's Legacy	} F. W. Stilwell, Esq., New Romney, S.O., Kent.
102	<i>James, Mercer and Elizabeth</i> —Mrs. Stoker.	
103	* <i>Lacy Newbon</i> —Mr. Newbon's Legacy	} Mr. S. Hayles, H.M. C. G ^d ., Littlestone, New Romney, [S.O., Kent.
104	<i>Charlie and Adrian</i> —X. . . .	
105	<i>Heyland</i> —That Memorial Fund	} Capt. Harold Finn, Elm Grove, Lydd, S.O., Kent.
106	<i>Captain Hans Busk</i> —That Life-boat Fund	
107	* <i>Queen Victoria</i> —R. N. L. B. Institution	} Capt. Vidler, Strand, Rye, R.S.O., Sussex. [Sussex.
108	<i>Catherine Swift</i> —Mrs. Swift's Legacy	
109	<i>Joe Jarman</i> —Miss A. E. Jarman's Legacy	} Mr. T. Martyn, Ch. Off. H.M. C. G ^d ., Camber, nr. Rye, R.S.O.
110	<i>William Stanley Lewis</i> —Mr. Lewis's Legacy.	
111	<i>Charles Luckcombe</i> —Mr. Luckcombe's Legacy	} Mr. T. Johnstone, H.M. C. G ^d ., Winchelsea, nr. Rye, R.S.O., Sussex.
112	<i>Sarah Brooshoft, Kirk Ella</i> } Colonel Brooshoft's Legacy	
113	<i>Vincent Wilkinson, Kirk Ella</i> } shoff's Legacy	} Councillor Hutchings, Fern Bank, 48 The Croft, Hastings.
		} Mr. H. M. Emary, 64 Pevensey Road, Eastbourne.
		} J. W. Noel, Esq., Meeching Road, Newhaven, S.O., Sussex.
		} A. H. Fry, Esq., 68, East Street, Brighton.
		} Harold Brown, Esq., Church St., New Shoreham, Sussex.
		} George Piggott, Esq., Kai Terri, Rowlands Rd., Worthing.
		} Mr. W. Auld, 42 New Road, Littlehampton.
		} Frank R. Leith, Esq., Selsey, Chichester.
		} Mr. H. R. Trigg, Hayling Island, Havant. [sea.
		} Wm. Payne, Esq., J.P., Woodleigh, The Thicket, South-
		} R. L. Hodges, Esq., N.P. Bank, Landport, Portsmouth.
		} Mr. Alderman Marvin, J.P., Ryde, I.W.
		} Rev. J. Palmer, M.A., Bembridge, Ryde, I.W.
		} C. Dabell, Esq., Hillside, Blackgang, Ventnor, I.W.
		} Rev. Canon Heygate, M.A., Brightstone, Newport, I.W.
		} Rev. G. E. Jeans, M.A., Shorwell, Newport, I.W.
		} Rev. Leslie Knights-Smith, Brightstone, Newport, I.W.
		} Rev. R. Leslie Morris, M.A., Brooke, Isle of Wight.
		} Lieut. J. Frost, R.E., Totland Bay, Freshwater Stat., R.S.O., I. W.
		} P. Baudains, Esq., St. Helier's, Jersey.
		} Capt. Carré, R.N., Valnord, Guernsey.

[Continued.

* This Life-boat is endowed.

STATION.		Length.	Breadth.	No. of Oars.	When Stationed or Named.	No.
		Ft. in.	Ft. in.			
DORSET	POOLE AND BOURNEMOUTH	34	8 3	10	1880	114
	SWANAGE	37	9	12	1898	115
	WEYMOUTH	34	8	10	1887	116
SOUTH DEVON	LYME REGIS	34	8	10	1891	117
	SIDMOUTH	34	8	10	1885	118
	EXMOUTH	34	7 6	10	1884	119
	TEIGNMOUTH	35	8 6	10	1896	120
	TORQUAY	37	8	12	1889	121
CORNWALL	BRIXHAM	37	9 4	10	1896	122
	SALCOMBE	34	8	10	1887	123
	HOPE COVE	34	8	10	1887	124
	YEALM RIVER	34	8	10	1887	125
	PLYMOUTH	34	7 6	10	1885	126
	LOOE	34	8	10	1882	127
	POLKERRIS AND FOWEY	34	7 6	10	1887	128
	MEVAGISSEY	37	8	12	1888	129
	FALMOUTH	37	9	12	1894	130
	PORHOUSTOCK	37	8	12	1886	131
	CADGWITH	37	8	12	1887	132
	CHURCH COVE	34	7 6	10	1887	133
	POLPEAR	34	8	10	1885	134
	MULLION	38	8	12	1894	135
	PORHLEVEN	34	7 9	10	1882	136
PENZANCE	36	8 3	12	1895	137	
SENNEN COVE	35	8 3	10	1893	138	
SCILLY ISLANDS	St. MARY'S	38	8	12	1891	139
CORNWALL	St. AGNES	34	7 6	10	1890	140
	St. IVES	34	7 6	10	1886	141
	HAYLE	34	8	10	1887	142
	NEW QUAY	34	8	10	1892	143
	PADSTOW	34	8	10	1893	144
	PORT ISAAC	34	7 6	10	1887	145
	BUDE	34	8	10	1886	146
NORTH DEVON	CLOVELLY	34	7 6	12	1891	147
	APPLEDORE—No. 1	34	7 6	10	1885	148
	” No. 2	34	8	10	1881	149
	MORTHOE	36 6	7 6	12	1892	150
	ILFRACOMBE	37	9	12	1893	151
SOMERSET	LYNMOUTH	34	7 6	10	1887	152
	WATCHET	34	8	10	1887	153
	BURNHAM	34	7 6	10	1887	154
	WESTON-SUPER-MARE	34	7 6	10	1889	155
SOUTH WALES.						
GLAMORGANSHIRE	PENARTH	37	8	12	1881	156
	PORTHCAWL	34	8	10	1887	157
	SWANSEA	34	8 3	10	1883	158
CARMARTHENSHIRE	PORT EYNON	34	8	10	1884	159
	BURRY PORT	37	8	12	1887	160
PEMBROKESHIRE	FERRYSIDE, CARMARTHEN BAY	37	8	12	1885	161
	TENBY	34	8	10	1885	162
	ANGLE, MILFORD HAVEN	37	8	12	1888	163
	LITTLEHAVEN	39	9	12	1893	164
	St. DAVID'S	37	8	12	1885	165
CARDIGANSHIRE	FISHGUARD—No. 1	31	7 3	10	1889	166
	” No. 2	37	8	12	1885	167
	CARDIGAN	34	8	10	1888	168
	NEWQUAY	37	8	12	1886	169
	ABERYSTWITH	34	8	10	1887	170

No.	NAME OF BOAT AND DONOR.	NAME AND ADDRESS OF HONORARY SECRETARY.
114	<i>Boy's Own No. 2</i> —That Life-boat Fund . . .	H. Burden, Jun., Esq., West Shore Wharf, Poole.
115	<i>William Erle</i> —The late Lady Erle . . .	Mr. E. Brunsden, Pier Master, Swanage, S.O., Dorset.
116	* <i>Friern Watch</i> —E. Homan, Esq.	Henry Warren, Esq., Custom House Quay, Weymouth.
117	<i>Susan Ashley</i> —C. Carr Ashley, Esq.	M. C. Preston, Esq., Lyme Regis.
118	<i>William and Frances</i> —Miss Bass	W. J. D. Whitaker, Esq., L. & S. W. Bank, Sidmouth.
119	* <i>Joseph Somes</i> —Mrs. Joseph Somes	M. F. Moresby, Esq., R.N., 2 Adelaide Terrace, Exmouth.
120	<i>Alfred Staniforth</i> —Late Mrs. F. J. Staniforth's Trustees.	W. J. Burden, Esq., Teignmouth.
121	<i>James and Eliza Woodall</i> —A Lady, per Manchester Branch.	Mr. J. G. Nevin, 11 Trafalgar Terrace, Torquay. [S. Devon.]
122	* <i>Betsey Newbon</i> —Mr. Newbon's Legacy . . .	Alfred Kendrick, Esq., Lloyd's Agent, Brixham, R.S.O.,
123	<i>Lesty</i> —The late Mr. Lesty's Legacy . . .	Captain Herbert, R.N., J.P., Salcombe, Kingsbridge.
124	* <i>Alexandra</i> —Freemasons of England. . . .	John Yonge, Esq., Puslinch, near Yealmpton, Plymouth.
125	<i>Darling</i> —Mrs. Thomas's Legacy.	James Rooney, Esq., Great Western Docks, Plymouth.
126	<i>Escape</i> —Miss Lucy Harris	Mr. S. Brock, C. O. H.M. Ct. Gd., Looe, R.S.O., Cornwall.
127	<i>Boys' Own No. 1</i> —That Life-boat Fund . . .	W. E. Geach, Esq., Penellick, Par Station, R.S.O., Cornwall.
128	<i>Arthur Hill</i> —Arthur Hill, Esq.	Capt. J. Ball Farran, Mevagissey, St. Austell. [wall.]
129	<i>John Arthur</i> —Anonymous	George Carter, Esq., Commercial Buildings, Falmouth.
130	* <i>Bob Newbon</i> —Mr. Newbon's Legacy	Mr. E. P. Roskrug, St. Keverne, R.S.O., Cornwall.
131	<i>Charlotte</i> —A. F. H.	Rev. J. J. Mallock, M.A., Ruan Minor, R.S.O., Cornwall.
132	<i>Joseph Armstrong</i> —That Life-boat Fund . . .	H. Appleton, Esq., M.R.C.S., The Lizard, R.S.O., Cornwall.
133	<i>John and Sarah</i> —Mrs. Redfern's Legacy . . .	Rev. J. H. Scholefield, M.A., Mullion, Cury Cross Lanes, [R.S.O., Cornwall.]
134	<i>Edmund and Fanny</i> —Late Mrs. Holland . . .	Rev. H. W. Corry, Porthleven, Helston. [R.S.O., Cornwall.]
135	* <i>Nancy Newbon</i> —Mr. Newbon's Legacy	T. H. Cornish, Esq., Parade Street, Penzance.
136	<i>Charles Henry Wright</i> —Mrs. Wright's Legacy	
137	<i>Elizabeth and Blanche</i> —The Misses Smitheman	
138	* <i>Ann Newbon</i> —Mr. Newbon's Legacy	Mr. E. J. Bluett, Scilly, Penzance.
139	* <i>Henry Dundas</i> —Mrs. Dundas Drummond's Legacy.	
140	<i>James and Caroline</i> —Mr. Goss' Legacy . . .	W. T. Tresidder, Esq., St. Ives, R.S.O., Cornwall.
141	<i>Exeter</i> —Mr. W. Kendall's Legacy	Henry Thomas, Esq., Penpol Road, Hayle.
142	<i>E. F. Harrison</i> —New Oriental Bank	Mr. W. H. Thomas, H.M. Ct. Gd., New Quay, Cornwall.
143	<i>Willie Rogers</i> —Dr. J. Rogers' Legacy	Capt. Pope, Padstow, R.S.O., Cornwall.
144	<i>Arab</i> —R. A. B. Preston, Esq.	R. Julian George, Esq., M.D., Port Isaac, Wade-bridge, R.S.O., Cornwall.
145	* <i>Richard and Sarah</i> —The late Richard Thornton West, Esq., and Mrs. West.	Wm. Rowe, Esq., Stratton, R.S.O., "North Devon Mail."
146	* <i>Elizabeth Moore Garden</i> —Family of the late R. T. Garden, Esq.	Mr. Daniel Pearce, Chief Officer H.M. Ct. Gd., Clovelly, Bideford.
147	* <i>Elinor Roget</i> —Mrs. Roget.	F. A. Searle, Esq., Bank, Bideford.
148	* <i>Jane Hannah MacDonald</i> —Mrs. MacDonald	
149	* <i>Robert and Catherine</i> —Miss Leicester . . .	Mr. William Cole, Corner House, Ilfracombe.
150	<i>Theophilus Sidney Echalaz</i> —Rev. T. S. Echalaz's Legacy.	Rev. A. R. Hockley, Lynnmouth, Barnstaple.
151	<i>Co-operator No. 2</i> —The Co-operative Union, Limited	Will. Horne, Esq., Watchet, R.S.O., Somerset.
152	<i>Louisa</i> —Rev. T. L. Wheeler	W. Stoate, Esq., Belmont, Burnham, R.S.O., Somerset.
153	<i>W. H. G. Kingston</i> —"Union Jack" Life-boat Fund.	Conway G. Warne, Esq., St. Duthus, Ashcombe, Weston-super-Mare.
154	<i>John Godfrey Morris</i> —Mr. Morris's Legacy	
155	<i>William James Holt</i> —Late Col. Holt and Mrs. Symes.	
156	<i>Joseph Denman</i> —Hon. Mrs. Joseph Denman	H. J. Vellacott, Esq., Penarth.
157	<i>Speedwell</i> —A Lady	John Grace, Esq., Victoria Rd., Porthcawl, R.S.O., Glam.
158	<i>Wolverhampton</i> —Town of Wolverhampton.	T. W. Islay Young, Esq., Cae Hir, West Cross, near Swansea.
159	<i>A Daughter's Offering</i> —Miss Jones's Legacy	Mr. Charles Bevan, Overton, Port Eynon, Swansea.
160	* <i>David Barclay of Tottenham</i> —Mrs. Barclay's Legacy.	Gerard Elkington, Esq., J.P., Pembrey, Burry Port, R.S.O., Carmarthenshire.
161	<i>City of Manchester</i> —Manchester Branch . . .	Col. Pelly Fry, Ferryside, R.S.O., Carmarthenshire.
162	<i>Anne Collin</i> —Miss Collin's Legacy	J. G. Lock, Esq., M.R.C.S., J.P., Tenby. [broke.]
163	<i>Henry Martin Harvey</i> —Mr. Harvey's Legacy	R. W. B. Mirehouse, Esq., J.P., The Hall, Angle, Pembrokeshire.
164	<i>David Pickard</i> —Mr. A. Pickard's Legacy . . .	Mr. R. Rogers, Broadhaven, Littlehaven, R.S.O., Pembrokeshire. [Pembrokeshire.]
165	<i>Gem</i> —Late Mr. Metcalfe	W. Peregrine Propert, Esq., LL.D., St. David's, R.S.O., Pembrokeshire.
166	<i>Elizabeth Mary</i> —Mrs. Tudor's Legacy	W. J. Vaughan, Esq., Fishguard, R.S.O., Pembrokeshire.
167	<i>Appin</i> —Miss Downie's Legacy	Mr. William Joseph, Rock Terrace, Cardigan.
168	<i>Lizzie and Charles Leigh Clare</i> —The late Mrs. Leigh Clare, per Manchester Branch.	
169	<i>Frank and Maion</i> —Mrs. Francis G. Smart.	Capt. David Rees, Quay Stores, New Quay, Llandyssil.
170	<i>Elizabeth Lloyd</i> —Mr. T. E. Jones's Legacy, per Manchester Branch.	Captain Thomas Doughton, Aberystwith. [Continued.]

* This Life-boat is endowed.

STATION.		Length.	Breadth.	No. of Oars.	When Stationed or Named.	No.
		Ft. in.	Ft. in.			
NORTH WALES.						
MERIONETHSHIRE	- ABERDOVEY - - - - -	34 -	8 -	10	1886	171
	BARMOUTH - - - - -	37 -	8 -	12	1885	172
CARNARVONSHIRE	- CRICCIETH - - - - -	34 -	7 6	10	1886	173
	PWLLHELI - - - - -	38 -	8 -	12	1892	174
	ABERSOCH - - - - -	34 -	8 -	10	1892	175
	PORTHDINLLAERN - - - - -	39 -	9 -	12	1888	176
	LLANAELHAIARN - - - - -	37 -	8 -	12	1883	177
ANGLESEY - - -	- LLANDDWYN - - - - -	34 -	7 6	10	1885	178
	RHOSNEIGIR - - - - -	34 -	7 6	10	1890	179
	RHOSCOLYN - - - - -	33 -	8 -	10	1873	180
	PORT RHUFFYDD - - - - -	34 -	7 6	10	1891	181
	HOLYHEAD—No. 1 - - - - -	39 -	9 -	12	1891	182
	„ No. 2 - - - - -	37 -	9 -	12	1890	183
	CEMLYN - - - - -	34 -	8 -	10	1888	184
	CEMAES - - - - -	34 -	8 -	10	1887	185
	BULL BAY - - - - -	34 -	8 -	10	1889	186
	MOELFRE - - - - -	39 -	9 -	12	1892	187
	PENMON - - - - -	37 -	9 3	12	1896	188
CARNARVONSHIRE	- LLANDUDNO (ORME'S HEAD) - - - - -	37 -	8 -	12	1887	189
DENBIGHSHIRE	- LLANDDULAS - - - - -	34 -	8 3	10	1885	190
FLINTSHIRE - - -	- RHYL (TUBULAR) - - - - -	35 7	10 -	14	1893	191
	„ No. 2 - - - - -	34 -	8 -	10	1888	192
	POINT OF AYR - - - - -	35 -	9 -	12	1895	193
ENGLAND—Continued.						
CHESHIRE - - -	- HILBRE ISLAND - - - - -	35 -	10 -	12	1895	194
	HOYLAKE - - - - -	34 3	9 9	12	1894	195
	NEW BRIGHTON, No. 1 (TUBULAR) - - - - -	43 -	12 6	14	1888	196
	„ No. 2 (STEAM) - - - - -	50 -	12 -	—	1893	197
LANCASHIRE - - -	- FORMBY - - - - -	35 -	9 -	12	1896	198
	SOUTHPORT No. 1 - - - - -	34 -	8 -	10	1886	199
	„ No. 2 - - - - -	42 -	13 3	12	1888	200
	LYTHAM - - - - -	37 -	8 -	12	1886	201
	ST. ANNE'S No. 1 - - - - -	34 -	7 6	10	1887	202
	„ No. 2 - - - - -	43 -	11 9	8	1892	203
	BLACKPOOL - - - - -	36 2	8 10	12	1896	204
	FLEETWOOD - - - - -	43 -	12 6	12	1894	205
	BARROW - - - - -	38	9 -	12	1887	206
CUMBERLAND - - -	- WHITEHAVEN - - - - -	34 -	8 -	10	1884	207
	WORKINGTON - - - - -	34 -	7 6	10	1886	208
	MARYPORT - - - - -	34 -	7 6	10	1886	209
ISLE OF MAN - - -	- RAMSEY - - - - -	37 -	9 3	10	1896	210
	DOUGLAS - - - - -	42 -	11 4	12	1896	211
	CASTLETOWN - - - - -	35 -	8 3	10	1896	212
	PORT ST. MARY - - - - -	35 -	8 6	10	1896	213
	PORT ERIN - - - - -	37 -	8 -	12	1892	214
	PEEL - - - - -	37 -	9 -	12	1885	215

No.	NAME OF BOAT AND DONOR.	NAME AND ADDRESS OF HONORARY SECRETARY.
171	<i>Thomas Nicolls Stratford</i> —His Legacy . . .	Capt. Enoch Lewis, Aberdovey, R.S.O., Merionethshire
172	<i>Jones-Gibb</i> —Mrs. Jones-Gibb	Mr. John Lloyd, 1 Glanywerydd Terrace, Barmouth.
173	<i>Caroline</i> —Late Miss Lamb's Bequest and Capt. Rodney Blane's Life-boat Fund.	Randal Casson, Esq., Bron y Garth, Portmadoc.
174	<i>Margaret Platt of Stalybridge</i> —Mrs. Platt's Legacy	} Capt. Evan Jones, Post-Office, Pwllheli.
175	<i>Oldham</i> —Oldham Life-boat Fund	
176	<i>George Moore</i> —That Life-boat Fund	Capt. Hugh Roberts, Glanrafon, Morfa-Nevin, Pwllheli.
177	<i>Cyprian</i> —Mrs. Noble	Capt. Evan Jones, Post-Office, Pwllheli.
178	<i>Richard Henry Gould</i> —Mr. John Gould's Legacy, per Manchester Branch.	Hugh Richards, Esq., The Quay, Carnarvon.
179	<i>Thomas Lingham</i> —Mrs. Lingham	} Mr. W. Jones, Ty Croes Farm, Ty Croes, R.S.O., Angle- Colonel Hampton Lewis, Bodior, Holyhead. [sey.
180	* <i>Ramon Cabrera</i> —The Countess de Morella .	
181	<i>Norbury</i> —Norbury Life-boat Fund	} Capt. Kendall, Holyhead.
182	* <i>Thomas Fielden</i> —Samuel, John and Joshua Fielden, Esqrs.	
183	* <i>Joseph Whitworth</i> —The late Sir Joseph Whitworth, Lady Whitworth and friends	} John F. Hughes, Esq., R.N., Tanralt, Cemlyn, Amlwch, R.S.O., Anglesey. [Anglesey.
184	<i>B. J. Nicholson</i> —Mrs. B. J. Nicholson . .	
185	<i>George Evans</i> —Mrs. Evans's Legacy	Rev. T. Prichard, B.A., Llanbadrig, Amlwch, R.S.O.,
186	<i>Curling</i> —Miss Curling	John Hughes, Esq., Frondeg, Amlwch, R.S.O., Anglesey.
187	<i>Star of Hope</i> —Late Mrs. Atherton Howard	Rice Roberts, Esq., Rhivlas, Pentraeth, Menai Bridge, R.S.O., Anglesey.
188	* <i>Christopher Brown</i> —Settle fund	{William M. Preston, Esq., }Lleiniog Castle, Beaumaris.
189	<i>Sunlight No. 1.</i> —Messrs. Lever Brothers' Competition.	{Leonard Hepworth, Esq., }
190	<i>Mary Jane Gould</i> —Mr. Gould's Legacy, per Manchester Branch. [son's Legacy.	Rev. John Raymond, 17 Gloddaeth Crescent, Llandudno.
191	* <i>Caroline Richardson</i> —Mr. H. T. Richard- Jane Martin—Mrs. Martin.	John Davies, Esq., Craig y don, Llanddulas, Abergele, R.S.O., Denbighshire.
192	<i>Jane Martin</i> —Mrs. Martin.	} J. Pierce-Lewis, Esq., Rhyl.
193	<i>H. G. Powell</i> —H. G. Powell, Esq.	
194	<i>Admiral Briggs</i> —The late Major-General W. L. Briggs, C.B.	} W. C. Glover, Esq., Corbys, Hoylake, S.O., Cheshire.
195	<i>Coard William Squarey</i> —Mr. Squarey's Legacy.	
196	* <i>Henry Richardson</i> —Mr. H. T. Richardson's Legacy. [Life-boat]	} Hugh B. Kent, Esq., "Rocklands," New Brighton, T.S.O., Liverpool. [Street, Liverpool.
197	<i>Duke of Northumberland</i> (Hydraulic Steam John and Henrietta—Anonymous	
198	<i>Mary Anna</i> —Anonymous	Capt. Phillips, R.N., Hargrave Buildings, 5 Chapel
199	<i>Mary Anna</i> —Anonymous	W. Thomas, Esq., M.D., J.P., 39 Park Crescent, Southport.
200	<i>Edith and Annie</i> —The Misses Macrae	} W. H. Shaw, Esq., Scarisbrick Street, Southport.
201	<i>Charles Biggs</i> —Miss Biggs's Legacy	
202	<i>Nora Roysds</i> —C. M. Roysds, Esq.	C. Myers, Esq., Lytham, R.S.O., Lancashire.
203	<i>Brothers</i> —Anonymous	} Thomas Bradley, Esq., St. Anne's-on-the-Sea, Preston.
204	* <i>Samuel Fletcher of Manchester</i> —From his Estate by command of H.M. THE QUEEN	
205	<i>Maude Pickup</i> —Mr. Pickup's Legacy	{J. Walter Smith, Esq., Dalemoor, Station Road, South Shore, Blackpool.
206	<i>William Birkett</i> —Mr. Birkett's Legacy . . .	Ernest Crosby, Esq., North Albert Street, Fleetwood, R.S.O., Lancashire.
207	* <i>Elizabeth Leicester</i> —Miss Leicester	Walter Carter, Esq., Queen's Terrace, Barrow-in- Furness.
208	<i>Dodo</i> —A Lady	J. G. Oldfield, Esq., Lloyd's Agent, Whitehaven.
209	* <i>Civil Service No. 5</i> —Civil Service Fund . .	J. Clifton Thompson, Esq., 53 Edkin Street, Workington.
210	<i>Mary Isabella</i> —Anonymous, per Mr. and Mrs. Norbury, through Manchester Branch	} Q. Moore, Esq., Shipping Brow } Maryport. Capt. Nelson, Harbour Master }
211	* <i>Civil Service No. 6</i> —Civil Service Fund . .	
212	<i>Thomas Black</i> —Mrs. Black's Legacy	E. C. Kerr, Esq., Bank, Ramsey, S.O., Isle of Man.
213	<i>James Stevens No. 1</i> —Mr. Stevens' Legacy .	} Thos. Bawden, Esq., Douglas, Isle of Man. G. H. Quayle, Esq., Castletown, S.O., Isle of Man.
214	<i>William Sugden</i> —Miss L. C. Sargenson's Legacy.	
215	<i>John Monk</i> —Legacy of Captain Monk, R.N.	Capt. J. A. Kissack, Rocklands, Port St. Mary, I. of Man. Mr. T. Clague, Belle Vue Hotel, Port Erin, S.O., I. of M.
		John Corris, Esq., Manx Bank, Peel, S.O., Isle of Man.

[Continued.]

* This Life-boat is endowed.

STATION.	Length.		Breadth.	No. of Oars.	When Stationed or Named.	No.		
	Ft.	in.					Ft.	in.
SCOTLAND.								
KIRKCUDBRIGHT	BALCARY	- - - - -	34	8	3	10	1884	216
	KIRKCUDBRIGHT	- - - - -	34	7	6	10	1887	217
WIGTOWNSHIRE	WHITHORN	- - - - -	34	7	6	10	1886	218
	PORT LOGAN	- - - - -	34	8	-	10	1894	219
	PORT PATRICK	- - - - -	37	8	6	12	1877	220
AYRSHIRE	BALLANTRAE	- - - - -	33	8	-	10	1871	221
	GIRVAN	- - - - -	34	7	6	10	1887	222
	AYR	- - - - -	34	8	3	10	1896	223
	TROON	- - - - -	34	7	6	10	1886	224
	IRVINE	- - - - -	34	7	6	10	1887	225
	ARDROSSAN	- - - - -	37	8	-	12	1892	226
ISLE OF ARRAN	KILDONAN	- - - - -	34	7	6	10	1890	227
ARGYLLSHIRE	CAMPBELTOWN	- - - - -	34	7	6	10	1888	228
	SOUTHEND	- - - - -	34	7	6	10	1888	229
ISLAND OF LEWIS	STORNOWAY	- - - - -	34	7	6	10	1887	230
ORKNEYS	STROMNESS	- - - - -	42	11	-	12	1891	231
	LONGHOPE	- - - - -	39	9	-	12	1891	232
CAITHNESS-SHIRE	THURSO	- - - - -	37	8	-	12	1890	233
	HUNA	- - - - -	37	8	-	12	1889	234
	ACKERGILL	- - - - -	34	7	6	10	1888	235
	WICK	- - - - -	34	8	3	10	1895	236
SUTHERLANDSHIRE	DORNOCH FIRTH AND EMBO	- - - - -	34	7	6	10	1886	237
NAIRNSHIRE	NAIRN	- - - - -	34	8	-	10	1892	238
ELGINSHIRE	LOSSIEMOUTH	- - - - -	34	7	6	10	1887	239
BANFFSHIRE	BUCKIE	- - - - -	34	7	6	10	1889	240
	BANFF	- - - - -	34	7	6	10	1888	241
ABERDEENSHIRE	FRASERBURGH	- - - - -	38	8	-	12	1894	242
	WHITELINK BAY	- - - - -	34	8	-	10	1889	243
	PETERHEAD	- - - - -	38	8	-	12	1893	244
	PORT ERROLL	- - - - -	34	8	-	10	1888	245
	NEWBURGH	- - - - -	31	7	3	10	1889	246
KINCARDINESHIRE	STONEHAVEN	- - - - -	34	8	-	10	1888	247
	GOURDON	- - - - -	24	8	-	10	1892	248
	JOHNSHAVEN	- - - - -	31	7	3	10	1891	249
FORFARSHIRE	MONTROSE—No. 1	- - - - -	38	8	-	12	1894	250
	„ No. 2	- - - - -	31	7	3	10	1889	251
	ARBROATH	- - - - -	37	8	-	12	1888	252
	BROUGHTY FERRY, DUNDEE	- - - - -	37	8	-	12	1888	253
FIFESHIRE	ST. ANDREW'S	- - - - -	34	8	-	10	1893	254
	CRAIL	- - - - -	34	8	-	10	1884	255
	ANSTRUTHER	- - - - -	34	8	-	10	1888	256
HADDINGTONSHIRE	NORTH BERWICK	- - - - -	34	7	6	10	1887	257
BERWICKSHIRE	DUNBAR	- - - - -	34	7	6	10	1893	258
	EYEMOUTH	- - - - -	34	7	6	10	1888	259
IRELAND.								
Co. ANTRIM	PORTRUSH	- - - - -	34	7	6	10	1889	260
	CARRICKFERGUS	- - - - -	37	9	3	10	1896	261
DOWN	GROOMSPORT	- - - - -	34	7	6	10	1885	262
	BALLYWALTER	- - - - -	34	7	6	10	1885	263
	CLOUGHY	- - - - -	34	8	3	10	1885	264
	TYRELLA	- - - - -	34	7	6	10	1888	265

No.	NAME OF BOAT AND DONOR.	NAME AND ADDRESS OF HONORARY SECRETARY.
216	<i>David Hay</i> —His Legacy	J. G. Boyes, Esq., Auchencairn, Castle Douglas.
217	<i>Hugh and Ann</i> —Miss Fergusson's Legacy .	James Cavan, Esq., Kirkcudbright.
218	<i>Henry and John Leighton</i> —Late Capt. Henry Leighton, per Miss Agnes Leighton.	Mr. William Burns, Isle of Whithorn, Whithorn, R.S.O., Wigtownshire.
219	<i>Frederick Allen</i> —Miss E. C. Allen's Legacy	William Cochran, Esq., Port Logan, R.S.O., Wigtownshire.
220	* <i>Civil Service, No. 3</i> —Civil Service Fund .	Rev. James R. Kennedy, The Manse, Port Patrick, R.S.O., Wigtownshire.
221	* <i>William and Harriot</i> —Mrs. Richardson's Legacy.	H. Inglis, Esq., Commercial Bank, Ballantrae, R.S.O., [Ayrshire.
222	<i>Sir Home Popham</i> —Mrs. Popham's Legacy.	James Smith, Esq., Town Clerk's Chambers, Girvan.
223	* <i>Janet Hoyle</i> —T. K. Hardie, Esq.	{William Pollock, Esq., }24 Sandgate, Ayr.
224	<i>Alexander Munnoch</i> —His Legacy	Mr. James Currie, Troon.
225	<i>Busbie</i> —Mr. Wallace's Legacy	James Dickie, Esq., Council Chambers, Irvine.
226	<i>Charles Skirrow</i> —Mrs. Skirrow	John Emslie, Esq., Ardrossan.
227	<i>David and Elizabeth Kidd, Brother and Sister</i> —Miss Pringle Kidd.	Patrick Murray, Esq., Brodick, S.O., Isle of Arran.
228	<i>Mary Adelaide Harrison</i> —Heath Harrison,	Mr. James Donaldson, 44 Kirk Street, }Campbeltown.
229	* <i>John E. Ker</i> —Robert Ker, Esq. [Esq.	{Rev. C. T. Wakeham, Rectory,
230	<i>Isabella</i> —Mrs. Duguid	{Eneas M. Mackenzie, Esq., Stornoway.
231	<i>Good Shepherd</i> —L. O. Ancient Shepherds .	Capt. G. Baillie, Stromness, R.S.O., Orkney.
232	<i>Samyntas Stannah</i> —Mrs. Stannah's Legacy	Edward E. Corrigan, Esq., Longhope, Stromness, R.S.O., Orkney.
233	<i>Co-operator No. 3</i> —The Co-operative Union, Limited.	J. Sinclair Macdonald, Esq., Thurso.
234	<i>Caroline and Thomas</i> —Mr. Hackwood's Legacy.	Mr. John Sutherland, Jun., Huna-by-Wick.
235	<i>Jonathan Marshall, Sheffield</i> —Col. Broshoff's Legacy.	James Campbell, Esq., Sheriff Clerk, Wick.
236	<i>John Avins</i> —Mr. Avin's Legacy	David Peters, Esq., Dornoch, R.S.O., Sutherlandshire.
237	<i>Daisie</i> —"D."	Mr. James McIntosh, Nairn.
238	<i>Theophilus Sidney Echalaz</i> —Rev. T. S. Echalaz's Legacy.	Capt. A. Coull, Harbour Master, Lossiemouth, Elgin.
239	<i>Frances Sprot</i> —Miss Sprot's Legacy. . . .	John L. McNaughton, Esq., Cluny Square, Buckie.
240	<i>James Sharpe</i> —Mr. Sharpe's Legacy . . .	Robert Hardie, Esq., National Bank, Banff.
241	<i>Help for the Helpless</i> —Mrs. Bain's Legacy .	Andrew Tarras, Esq., Town House, Fraserburgh.
242	<i>Anna Maria Lee</i> —Mrs. Lee's Legacy . . .	Rev. Duncan MacGregor, The Manse, Inverallochy, Rathen Station, Aberdeenshire.
243	<i>Three Brothers</i> —Anonymous	Robert Gray, Esq., Peterhead.
244	<i>George Pickard</i> —Mr. A. Pickard's Legacy .	Mr. John Collins, Port Erroll, Ellon.
245	<i>Frances Camilla Howard</i> —Miss Dixon . . .	Mr. P. Murray, Newburgh-by-Aberdeen.
246	<i>Ellen Newman and John Bentley</i> —John Bentley, Esq.	David Carr, Esq., Stonehaven.
247	<i>Alexander Black</i> —Mrs. A. Black.	Rev. John Brown, Bervie, Fordoun.
248	<i>Theophilus Sidney Echalaz</i> —Rev. T. S. Echalaz's Legacy.	Mr. Robert Stewart, Johnshaven, Montrose.
249	<i>Meanwell of Glenbervie</i> —Mr. Alexander Davidson's Legacy.	J. Balfour Alexander, Esq., Montrose.
250	<i>Robert Henderson</i> —Mr. P. Henderson's Legacy.	Norman McBain, Esq., 10 Commerce Street, Arbroath.
251	<i>Bessie Webster</i> —George Webster, Esq. . . .	James Hunter, jun., Esq., 69 Reform Street, Dundee.
252	<i>William Souter</i> —Mrs. Souter's Legacy . . .	Mr. Andrew Balsillie, 14 North Bell Street, St. Andrew's.
253	<i>Samuel Shawcross</i> —A. O. of Foresters . . .	D. Morton, Esq., Craig Head, Craik, R.S.O., Fifeshire.
254	<i>Louisa</i> —Mrs. Wigney's Legacy	H. B. Mackintosh, Esq., Anstruther.
255	<i>George Paterson</i> —Miss Paterson's Legacy .	D. McCulloch, Esq., British Linen Co., North Berwick.
256	<i>Royal Stuart</i> —Late Mrs. Atherton Howard	W. Bertram, Esq., Kilmald, Dunbar.
257	<i>Fergus Ferguson</i> —Mrs. Ferguson's Legacy	W. McDougall, Esq., Commercial Bank, Eyemouth, [R.S.O., Berwickshire.
258	<i>Sarah Pickard</i> —Mr. Pickard's Legacy . . .	
259	<i>James and Rachel Grindlay</i> —Mr. T. Grindlay's Legacy.	
260	<i>Robert and Agnes Blair</i> —Mrs. Blair's Legacy.	W. J. Morrow, Esq., Portrush.
261	<i>Zaida</i> —T. B. Dryburgh, Esq.	James C. Holden, Esq., }Carrickfergus.
262	<i>George Pooley</i> —Mr. Pooley's Legacy . . .	{Mr. R. Camaghan,
263	<i>William Wallace</i> —Mr. Wallace's Legacy . .	R. Graham Lindsay, Esq., Mulhouse Works, Belfast.
264	<i>Faith</i> —Mrs. Bradshaw's Legacy	Rev. J. A. Greer, LL.D., Ballywalter, S.O., Co. Down.
265	<i>Louisa Burnaby</i> —Mrs. Cameron	John McMullan, Esq., Cloughy, Portaferry.
		Rev. David Kennedy, Tyrella Rectory, Clough, S.O., Co. Down. [Continued.

* This Life-boat is endowed.

STATION.		Length.	Breadth.	No. of Oars.	When Stationed or Named.	No.
		Ft. in.	Ft. in.			
Co. DOWN	NEWCASTLE	34	8	10	1881	266
	LOUTH	37	9	12	1894	267
	GREENORE	34	8	10	1891	268
	GILES' QUAY	34	7 6	10	1885	269
	DUNDALK AND BLACKROCK	34	7 6	10	1892	270
DROGHEDA	No. 1	34	7 6	10	1892	270
	No. 2	34	7 6	10	1885	271
DUBLIN	BALBRIGGAN	34	7 6	10	1889	272
	SKERRIES	34	8	10	1888	273
	HOWTH	34	8	10	1886	274
DUBLIN AND POOLBEG		34	8	10	1881	275
	KINGSTOWN	37	8	12	1891	276
	WICKLOW	40	10	10	1889	277
WICKLOW	WICKLOW	40	10	10	1889	277
	ARKLOW	39	9	12	1890	278
WEXFORD	COURTOWN	37	8	12	1888	279
	CAHORE	35	8	10	1892	280
	WEXFORD—No. 1	42	11	12	1890	281
	„ No. 2	34	8 3	10	1878	282
	ROSSLARE HARBOUR	42	11	12	1896	283
	CARNSORE	37	8	12	1890	284
WATERFORD	KILMORE	34	8 3	10	1884	285
	FETHARD	34	8 3	10	1886	286
	DUNMORE EAST	37	9	12	1884	287
	TRAMORE	32	8	10	1893	288
CORK	DUNGARVAN	34	7 6	10	1887	289
	YOUGHAL	34	8	10	1885	290
	BALLYCOTTON	37	9 3	12	1896	291
QUEENSTOWN	No. 1	34	8	10	1866	292
	No. 2	42	11	12	1890	293
KERRY	COURTMACSHERRY	34	7 6	10	1885	294
	FENIT (TRALEE BAY)	42	11 4	12	1895	295
DONEGAL	ARANMORE	37	8	12	1883	296
	CULDAFF	34	8	10	1892	297
	GREENCASTLE	33	8	10	1880	298

The Royal National Life-boat Institution

Is prepared to establish and maintain a Life-boat Station on any part of the coast of the United Kingdom where it can be shown, from previous disasters, that a Life-boat is required. It is requisite that there should be a sufficient number of men (fishermen, or others accustomed to the management of boats at sea) to man the Life-boat, and a Committee formed from the residents in the neighbourhood to superintend the Station and obtain such small Annual Subscriptions as may contribute towards a portion of the expense of the Life-boat Station.

Communications should be addressed to the Secretary of the Institution,
14 John Street, Adelphi, London, W.C.

No.	NAME OF BOAT AND DONOR.	NAME AND ADDRESS OF HONORARY SECRETARY.
266	<i>Farnley</i> —E. Armitage, Esq., R.A. . . .	George Gray, Esq., M.D., Newcastle, R.S.O., Co.
267	<i>Sir Arthur Blackwood</i> —That Lifeboat Fund	Mr. Robert Baker, Greenore, R.S.O., Co. Louth. [Down.
268	<i>Providence</i> —Mr. Pooley's Legacy [Bequest	Mr. W. Hammett, H.M. C. G ^d , Giles' Quay, Dundalk.
269	* <i>General R. Dudley Blake</i> —Mrs. Blake's	Thos. Murphy, Esq., Bayview, Blackrock, Dundalk.
270	* <i>Charles Whitton</i> —Mr. C. R. Whitton's Legacy	Mr. N. Halligan, Banktown, Drogheda. [nr. Drogheda.
271	<i>Charity</i> —Mrs. Bradshaw's Legacy	Joseph Connolly, Esq., R.N., Beachmount, Mornington,
272	<i>Maid of Annan</i> —The late Mrs. Langworthy	{ H. A. Hamilton, Esq., } Balbriggan, R.S.O., Co. Dublin.
273	<i>Sir Edward Blakeney</i> —Dr. Mahony's	{ W. J. Cumisky, Esq., } A. Murphy, Esq., Skerries, S.O., Co. Dublin.
274	<i>Tom and Ida Smithies</i> —Trustees of the late	Edward Greer, Esq., Evora, Howth, S.O., Co. Dublin.
275	<i>Aaron Stark Symes</i> —Mrs. Elizabeth S. Symes	{ Thos. Edmondson, Esq., Shanagarry, Milltown, Co. Dublin. } { Dublin. } Mr. J. S. Morgan, 2, Sea View Ter., Clontarf, T.S.O., { Capt. the Hon. F. G. Crofton, R.N., Harbour Master, Kingstown. }
276	<i>Hannah Pickard</i> —Mr. Pickard's Legacy . .	W. H. H. Kennedy, Esq., Wentworth Place, Wicklow.
277	* <i>Robert Theophilus Garden</i> —Late R. T. Gar-	
278	<i>Frances and Charlotte</i> —The Misses English's	
279	<i>Three Sisters</i> —Anonymous	Mr. James Tyrrell, Main St., Arklow.
280	<i>Willie and Arthur</i> —Joseph Leather, Esq. . .	Hon. George Stopford, Levuka, Gorey.
281	<i>Andrew Pickard</i> —Mr. Pickard's Bequest . .	Wm. Astle Ryan, Esq., Cahore, Gorey.
282	* <i>Civil Service No. 1</i> —Civil Service Fund . .	John F. Walsh, Esq., West Mount House, West Gate, Wexford.
283	<i>Tom and Jenny</i> —"D"	
284	<i>Robert Fitz Stephens</i> —A Lady, per Pembroke	
285	<i>John Robert</i> —E. M. S.	{ E. A. Gibbon, Esq., Rosslare, Wexford. }
286	* <i>Helen Blake</i> —Mrs. Blake's Bequest	C. S. Walker, Esq., Kilmore Quay, Wexford.
287	<i>Henry Dodd</i> —Mr. Dodd's Legacy	Allan Leigh, Esq., Fethard, Waterford.
288	<i>Henley</i> —Mr. Henley's Legacy	Mr. P. Harney, Dunmore East, Waterford.
289	<i>William Dunville</i> —Mrs. Dunville's Legacy .	{ M. J. Murphy, Esq., West Cliff, Tramore, Waterford. Mr. E. O'S. Wardell, Main Street, Tramore, Waterford. }
290	<i>Mary Luckombe</i> —Mrs. Luckombe's Legacy . .	Mr. Francis Craig, Abbeyside, Dungarvan.
291	<i>T. P. Hearne</i> —T. P. Hearne, Esq.	J. H. Long, Esq., Main Street, Youghal.
292	<i>Quiver</i> —No. 3—"Quiver" Magazine	{ T. W. Strangman, Esq., } { Rev. A. C. Martin, B.A., } Shahagarry, Midleton, Co. Cork.
293	<i>Endeavour</i> —Miss Ball's Legacy	Capt. Osborne, R.N., Harbour Master, Queenstown.
294	<i>Farrant</i> —Mr. Farrant's Legacy	Capt. Townshend, Courtmacsherry, R.S.O., Co. Cork.
295	<i>John Willmot</i> —Miss King's Legacy	Robert McCowen, Esq., J.P., Lloyd's Agent, Tralee.
296	<i>Vandeleur</i> —Mr. Vandeleur's Legacy	Wm. Smyth, Esq., M.D., J.P., Burton Port, R.S.O., Co. Donegal.
297	<i>William Montgomery</i> —Mrs. Montgomery . .	R. M. Fleming, Esq., J.P., Culdaff, Londonderry.
298	<i>Mary Beckwith</i> —Mrs. Beckwith's Legacy . .	Pierce Crosbie, Esq., Greencastle, Londonderry.

The Royal National Life-Boat Institution,

FOR THE PRESERVATION OF LIFE FROM SHIPWRECK.

TO BOATMEN AND OTHERS.

R E W A R D S

OF MONEY OR MEDALS

Are granted by the Royal National Life-Boat Institution to all persons who,

AT THE RISK OF THEIR OWN LIVES,

SAVE OR ENDEAVOUR TO SAVE, BY MEANS OF SHORE-BOATS OR OTHERWISE,

the lives of those on board Vessels or Boats Wrecked or in Distress on any part of the coasts of the United Kingdom.

In all cases the Rewards are given without further delay than is necessary to obtain proof of the merits of each case, and to ensure payment being made to the right parties.

ROYAL NATIONAL LIFE-BOAT INSTITUTION,
14 JOHN STREET, ADELPHI, LONDON, W.C.

By Order, CHARLES DIBDIN,
Secretary.

* This Life-boat is endowed.

INDEX TO THE GIFT LIFE-BOATS OF THE ROYAL NATIONAL LIFE-BOAT INSTITUTION

(The figures refer to the numbers of the Life-boats detailed on the twelve preceding Pages.)

- A. F. H., 131.
A Lady, 16.
A Lady, per Manchester Branch, 121.
A Lady, 157.
A Lady, 208.
A Lady, per Pembroke Stephens, Esq., Q.C., 284.
Allen, Miss E.C., the late, 219.
Anonymous, 9, 243, 279.
Anonymous, 30, 75.
Anonymous, 129.
Anonymous, 199.
Anonymous, 199.
Anonymous, 203.
Anonymous, 203.
Anonymous, per Manchester Branch, 210.
Arkcoll, Chas., Esq., 96.
Armitage, E., Esq., R.A., 266.
Armstrong Fund, 132.
Ashley, C. Carr, Esq., 117.
Avin, Mr., the late, 236.
Bain, Mrs., the late, 241.
Ball, Miss, the late, 47, 293.
Baltic Life-boat Fund, 50.
Barclay, Mrs., the late, 160.
Barr, Mrs., the late, 1.
Bass, Miss, 118.
Beckwith, the late Mrs., 298.
Bedford, Miss A.M., Trustees of, 3.
Bennett, Mr. W., the late, 52.
Bentley, John, Esq., 246.
Berrey, Miss, the late, 45, 46.
Bewick, Miss, the late, 5.
Biggs, Miss, the late, 201.
Bird, Samuel, Esq., 73.
Birkett, Wm., the late, 206.
Black, Mrs., the late, 212.
Black, Mrs. Alexander, 247.
Blackwood, Sir Arthur, Life-boat Fund, 267.
Blair, Mrs., the late, 260.
Blake, Mrs., the late, 269, 286.
Blane, Capt. Rodney, R.N., Bolton, coll. in, 68. [173.
Boy's Own Life-boat Fund, 114, 127.
Bradford, collected in, 84.
Bradshaw, Mrs., the late, 264, 271.
Briggs, Major-Gen. W. L., C.B., the late, 194.
Brooshoft, Col., the late, 112, 113, 235.
Buffaloes, Royal Antediluvian Order of, 92.
Burch, Mrs., 61.
Burmester, Miss, 76.
Burronghes, Mrs., the late, 51.
Bury, C., Esq., the late, 70.
Busk, Hans, Fund, 106.
Cameron, Mrs., 265.
Civil Service Life-boat Fund, 14, 86, 209, 211, 220, 282.
Clare, Mrs. Leigh, the late, 168.
Collin, Miss, the late, 162.
Collinson, Mrs., the late, 94.
Co-operative Union, Limited, 13, 151, 233.
Coppin, Mr. John, the late, 18.
Corn Exchange, Mark Lane, Members of, the, 62.
Corry, A. J., Esq., the late, 71.
Covent Garden Life-boat Fund, 59.
Curling, Miss, 89, 186.
Cuttell, J., Esq., the late, 4.
Cyclist Life-boat Fund, 23, D., 237, 283.
Dalmer, Mrs. the late, 11.
Davidson, Mr. A., the late, 249.
Denman, Hon. Mrs. Joe., 156.
Dixon, Miss Anne, 43.
Dixon, Miss, 245.
Dodd, H., Esq., the late, 287.
Downie, Miss, the late, 167.
Drummond, Mrs. Dundas, the late, 139.
Duguid, Mrs., 230.
Dunville, Mrs., the late, 289.
Dryburgh, T. B. Esq., 261.
E. B., M. P., and A. and E. I., Cheddar, 28.
E. M. S., 285.
Eason, Miss, the late, 58.
Echalaz, the Rev. T. S., the late, 150, 238, 248.
Eggell, Miss, the late, 2, 53.
Ellis, Mrs., the late, 31.
English, the late Misses, 278.
Erle, Lady, the late, 115.
Evans, Mrs., the late, 185.
Farrant, H. A. M., Esq., the late, 294.
Ferguson, Mrs., the late, 257.
Ferguson, Miss, the late, 217.
Felden, J. A., Esq., 32.
Felden, Samuel, John, and Joshua, Esqs., 182.
Felder, Miss M., the late, 6.
Fletcher, Mr. Samuel, the late, 204. [15, 24, 253.
Foster's Ancient Order of Foeter, Herbert A., Esq., and Relatives, 34.
Fox, Children of Mr. and Mrs., 33. [124.
Freemasons of England, 79.
Friends at Manchester, 97.
Garden, the late R. T., Esq., 146, 277.
Gibb, Mrs. T. Jones, 172.
Glasgow, City of, 77.
Goes, Jas., Esq., the late, 140.
Gould, John, Esq., the late, 178, 190.
Grabam, Mrs. C. North, and Sons and Daughters, 74.
Grindlay, Thomas, Esq., the late, 269.
Guerrier, Rev. W. J., 55.
Hackwood, Thos., Esq., the late, 234.
Hardie, T. K. Esq., 223.
Hargrave, Chas., Esq., the late, 87.
Harris, H., Esq., the late, 101.
Harris, Mrs. H., the late, 95.
Harris, Miss Lucy, 126.
Harrison, Heath, Esq., 228.
Harvey, H. M. Esq., the late, 163.
Hawkins, Mr. C., the late, 29.
Hay, D., Esq., the late, 216.
Hearne, T. P., Esq., 291.
Hearts of Oak Benefit Society, 56.
Hedley, William, Esq., the late, 17.
Henderson, P., Esq., the late, 250.
Henley, George, Esq., the late, 288.
Heyland Memorial, 105.
Heywood-Lonsdale, A. P., Esq., the late, 44.
Hill, Arthur, Esq., 128.
Hodges, Mrs., the late, 19.
Kollon, R. W., Esq., the late, 35.
Hollond, Mrs., the late, 134.
Holt, Col., the late, and Mrs. Symes, 155.
Homan, E. Esq., 116.
Honourable Artillery Company Dramatic Club, 78.
Howard, Mrs. Atherton, the late, 187, 256.
Huddersfield, collected in, 54.
Ingleby, Rev. Chas., the late, per G. P. Wragge, Esq., 22.
Jacomb-Hood, Miss E. H., the late, 10. [109.
Jarman, Miss A. E., the late, Jewish Scholars' Life-boat Fund, 98.
Jones, Miss M., the late, 169.
Jones, T. E., Esq., the late, 170. [141.
Kendall, W., Esq., the late, Ker, Robert, Esq., 229.
Kidd, Miss Pringle, 227.
King, Miss, the late, 295.
Lamb, Miss, the late, 173.
Langworthy, Mrs., 272.
Leather, Jos., Esq., 280.
Lee, Mrs., the late, 242.
Leicester, collected in, 63.
Leicester, Miss, 149, 207.
Leighton, Capt. H., the late, per Miss A. Leighton, 218.
Lesty, Wm., Esq., the late, 123. [110.
Lewis, W. S., Esq., the late, Licensed Victuallers, collected from, 48.
Lingham, Mrs., 179.
Lovibond, George, Esq., the late, 21.
Loyal Order of Ancient Shepherds, 231. [390.
Luckombe, Mrs., the late, 111.
MacDonald, Mrs., 148.
Macrae, Misses, 200.
Mahony, Dr., the late, 273.
Manchester Branch, 27, 97, 121, 161, 168, 170, 178, 181, 190, 210.
Martin, Mrs., 192.
Metcalfe, J. Esq., the late, 165.
Middlewood, Geo., Esq., 37.
Monk, Capt. R.N., the late, 215.
Montgomery, Mrs., 297.
Moore, the late Geo., Esq., Life-boat Fund, 176.
Morella, the Countess de, 180.
Morice, Mrs., the late, 88.
Morris, J. G. Esq., the late, 154. [224.
Munnock, A., Esq., the late, New Oriental Bank, 142.
Newborn, R.A., Esq., the late, 103, 122, 130, 135, 138.
Nicholson, Mrs. B. J., 184.
Noble, Mrs., 177.
Norbury Life-boat Fund, 181.
Northumberland, The Dowager Duchess of, 8.
Odd Fellows (Manchester Unity), 42.
Oldham Life-boat Fund, 175.
Parkin, Thos., Esq., the late, 67.
Paterson, Miss, the late, 255.
Payne, W. J. Esq., the late, 38.
Pickard, A., Esq., the late, 164, 244, 258, 276, 281. [205.
Pickup, Jas., Esq., the late, Platt, Mrs., the late, 174.
Plimsoil Life-boat Funds, 65.
Pooley, G. Esq., the late, 262, 268.
Popham, Mrs., the late, 222.
Powell, H. G., Esq., 193.
Preston, Mrs., the late, 36.
Preston, R. A. B., Esq., 144.
Proctor-Beauchamp, Sir R., Bart., 60. [204.
QUEEN, HER MAJESTY THE, "Quiver" Magazine, collected, 72, 81, 297.
Redfern, Mrs., the late, 133.
Restell, W. T., Esq., the late, 100. [late, 191, 196.
Richardson, H. T. Esq., the Richardson, the late Mrs. Harriot, 221.
Rogers, Dr. J. J. the late, 143.
Roget, Mrs., 147.
Rosebery, Lady, the late, 90.
Rous, Admiral, Life-boat Fund, 41.
Royds, C. M., Esq., 202.
St. Michael's, Paddington, Life-boat Fund, 69.
Sargenson, Miss, the late, 214.
Scott, Mrs., the late, 7.
Settle, collected in, 40, 188.
Sharpe, James, Esq., the late, 240.
SilkenstEdt, Mrs., 49.
Simcox, Mrs., the late, 93.
Skirrow, Mrs., 226.
Skynner, Jno., Esq., the late, 20.
Smart, Mrs. Francis G., 169.
Smith, Mrs. F. S., the late, 80.
Smith, James McLaren, Esq., 64.
Smithson, The Misses, 137.
Smiths, Miss. Eliza, the late, 274.
Somerville, Miss, the late, 85.
Somes, Mrs., 119.
Souter, Mrs., the late, 252.
Spawforth, J., Esq., 91.
Sprot, Miss, the late, 239.
Squarey, Mrs., the late, 195.
Staniforth, Mrs. F. J., the late, 120.
Stannah, Mrs., the late, 232.
Stevens, Esq., the late, 213.
Stock Exchange Life-boat Fund, 66.
Stoker, Mrs., 12, 102.
Stott, Mrs., the late, 28.
Stratford, T. N. Esq., the late, 171. [189.
Sunlight Competition, 99.
Swift, Mrs., the late, 108.
Symes, Mrs. Elizabeth S., 275.
Thomas, Mrs., the late, 125.
Townden, Mrs., 27.
Tudor, Mrs., the late, 166.
"Union Jack" Life-boat Fund, 163.
Vandeleur, Richard, Esq., the late, 296.
Walker, G., Esq., the late, 39.
Wallace, H. B. C., Esq., the late, 225. [263.
Wallace, W., Esq., the late, Waud, G. M. Esq., the late, 83.
Webster, George, Esq., 251.
West, R. Thornton, Esq., the late, and Mrs. West, 145.
Wheeler, Rev. T. L., 152.
Whitton, Mr. C. R., the late, 270.
Whitworth, Sir Joseph, the late, and friends, 183.
Wigney, Mrs., 254.
Wolverhampton, coll. in, 158.
Wright, Mrs., the late, 136.
"X," 104.

THE APPROXIMATE COST OF A LIFE-BOAT STATION IS £1,050 AND IS MADE UP AS FOLLOWS:—
Life-boat and her equipment, including Life-belts for the Crew
and Transporting-carriage for the Life-boat £700
Boat-house, minimum cost (slipway extra) 350
Total £1,050

The annual expense of maintaining a Life-boat Station is about £100, and the benefactions and contributions of Donors of Life-boats are earnestly solicited in aid of that fund.

GOD HELP OUR MEN AT SEA.



List of the Rewards

FOR SAVING LIFE FROM WRECKS

VOTED BY THE ROYAL NATIONAL LIFE-BOAT INSTITUTION

TO THE CREWS OF ITS LIFE-BOATS, TO SHORE AND FISHING-BOATS' CREWS, AND TO OTHER PERSONS
FROM THE 1ST JANUARY TO THE 31ST DECEMBER, 1896.

Jan. 9. — PAKEFIELD. — *Two Sisters, Mary and Hannah, Life-boat.*—The Life-boat was launched at 1.30 A.M., and proceeded to the assistance of the brigantine *Kelpie*, of South Shields, bound from Hartlepool for Lowestoft, with a cargo of coal, which, having parted her two anchors, drifted on the outer flat about a mile south of Pakefield, and showed signals of distress. At about 2 o'clock the vessel was reached, her crew of seven men were then taken into the Life-boat and safely landed at Lowestoft at 3.30,

the boat being towed into the harbour by the steam-tug *Rainbow*. A strong wind was blowing from N.E. at the time the service was rendered, the sea was rough and the weather cold, with squalls of hail. —Expense of service, 39*l.* 17*s.*

COMMITTEE MEETING, 9th Jan., 1896.

Reported that Her Majesty the QUEEN had expressed through the Lord-Lieutenant of Ireland deep sympathy with

the widows and other dependents of the crew of the Kingstown No. 2 Life-boat, who unhappily lost their lives through the capsizing of the Life-boat while endeavouring to rescue those on board the barque *Palme*, of Finland, on the 24th December, 1895. Full particulars of this distressing occurrence were given in the Feb., 1896, issue of this Journal. Her Majesty contributed 30*l.* to the fund raised locally for the relief of the widows and others who were dependent on the Life-boatmen for support.

The Institution granted 2,200*l.* in aid of the relief fund; the funeral expenses were also defrayed by the Institution, and the widows or other legal representative received from it the service payment of 1*l.* 10*s.* awarded to each of the men.

The gold medal of the Institution, accompanied by a copy of the vote inscribed on vellum and framed, was awarded to Captain THOMAS McCOMBIE; a binocular glass, suitably inscribed, to his son (aged fifteen years); and 2*l.* each to eight of the crew of s.s. *Tearaght*, for gallantly putting off in the steamer's boat and in two trips saving, at very great risk, the master, his wife and child, and the crew of fifteen men from the ill-fated vessel.

Thanks were accorded to the captain of H.M.S. *Melampus* for kindly permitting six of the crew of the vessel to volunteer for service in the Kingstown No. 1 Life-boat, which also attempted to assist the stranded vessel, and the men were thanked and remunerated for the services they rendered.

Mr. BASIL HALL, District Inspector of Life-boats, was thanked for his services in trying to effect the rescue of the crew of the *Palme*. He went out in a steam-tug, which had the Poolbeg Life-boat in tow, but was unable to reach the ship, the heavy seas half filling the stoke-hole of the tug and compelling her to put back.

Rewards were granted to the crews of the steam-tugs *Flying Sprite* and *Flying Swallow*, and thanks were tendered to the Clyde Shipping Company, the owners of the two tugs, and to Mr. WATT, the Company's agent in Dublin, for allowing the gratuitous use of the vessels. Extra pay was granted to the crews of the Kingstown No. 1 and Poolbeg Life-boats, and the thanks of the Institution, inscribed on vellum and framed, were voted to Mr. MICHAEL DALTON, coxswain of the

Poolbeg Life-boat, who was indefatigable in his attempts to render assistance to the shipwrecked people.

Voted the thanks of the Institution, inscribed on vellum and framed, to Captain JOHN VEALE, in acknowledgment of his valuable services in acting as coxswain of the Dungarvan Life-boat on the 24th December last, and assisting to save seven of the crew of the ship *Moresby*, of Liverpool, which was wrecked off Dungarvan in a strong S.E. gale and a very heavy sea.

Also 783*l.* 4*s.* 5*d.* to pay the expenses of assemblies of crews, watching at night, or launches to distressed vessels by the Life-boats at Appledore, Arklow, Blackrock, Brighthstone Grange, Brooke, Cahore, Caister, Clacton, Drogheda, Dungarvan, Dungeness, Falmouth, Filey, Formby, Fraserburgh, Giles Quay, Girvan, Harwich, (Steam Life-boat), Holyhead, Hoylake, Hythe, Johnshaven, Kilmore, Kingstown, Moelfre, Montrose, New Brighton (Steam Life-boat), New Romney, Padstow, Palling, Peel, Polkerris, Poolbeg, Port Patrick, Porthdinllaen, Porth Rhuffydd, Queens-town, Shoreham, Staithes, Swansea, Tynewmouth, Tyrella, Walmer, Wexford, Whitburn, Whitelink Bay, Whithorn and Winterton.

Also 2*l.* to a man who was injured while about to summon the crew of the Hasborough Life-boat for service on the 24th November.

Jan. 14.—HAYLING ISLAND.—*Charlie and Adrian* Life-boat.—At 5.50 A.M. the Life-boat was launched in response to signals of distress from the brigantine *Marie Louise*, which, while on a voyage from Falmouth to Hamburg, stranded on the Houndgate Rock. The Life-boat stood by until she floated, when she was taken to a place of safety in charge of one of the Selsey Trinity pilots.—Property salvage case.—Balance of expense of service, 18*l.*

Jan. 15.—WHITBY.—*John Fielden* Life-boat.—Soon after 10 A.M., while a fresh gale was blowing from W.N.W., with a moderately rough sea, it was reported that the coble *Secret*, which had gone out fishing about two hours previous, had anchored about a mile N.N.E. of Whitby, having lost her sail while endeavouring to return to the harbour. The No. 2 Life-boat was promptly launched and brought ashore the coble's crew, consisting

of four men, leaving the boat riding at her anchor, apparently safe, as the weather was moderating. The weather, however, changed for the worse, and she ultimately sunk.—Expense of service, 15*l*.

Jan. 15.—FLAMBOROUGH.—*Mary Frederick* Life-boat.—While a strong gale was blowing from W.N.W., with a heavy sea, six of the fishing-boats were trying to reach the North Landing, but were unable to do so in consequence of the state of the wind and sea. The No. 1 Life-boat was launched at noon and stood by the boats while they rounded the Head and made for the South Landing.

Mr. WILLIAM ROBERTS, Chief Officer H.M. Coastguard, who watched the Life-boat from the top of the cliff, spoke in the highest terms of this service, and of the manner in which the Boat was managed by her coxswain and crew. He stated that the Boat herself behaved splendidly under sail, working like a smack, with the sea lashed into white foam, the wind at times blowing nearly a whole gale, and that in the absence of the Life-boat, whose presence gave courage and support to the fishermen, a serious casualty would probably have occurred.—Expense of service, 13*l*. 7*s*.

Jan. 23.—CULLERCOATS.—*Co-operator* No. 1 Life-boat.—At 11.30 A.M. the Life-boat was launched, and convoyed into harbour about twenty-five fishing cobs, it being dangerous for the boats to attempt to cross the bar unattended, as a heavy sea was breaking on it and a dense fog prevailed at the time.—Expense of service, 13*l*. 12*s*. 3*d*.

Jan. 26.—FLAMBOROUGH.—*Mary Frederick* Life-boat.—Signals having been seen, in very foggy weather, the boat was launched at 6.30 A.M., and proceeded through a strong sea to the steamer *Dundee*, of Glasgow, bound from Grangemouth for Rotterdam with a general cargo. The master of the vessel sent the whole of his crew ashore in the ship's large boat, but he and his officers remained on board the steamer, requesting that the Life-boat should stand by them until communication had been effected with Lloyd's Agent. On his arrival with the officer of Coastguard it was decided to abandon the ship, as the seas were sweeping her decks and it was evident that she was doomed. The captain and the three other officers therefore got into the Life-boat, and were

landed at the North Landing at 11 A.M. The steamer became a total wreck.—Expense of service, 19*l*. 15*s*. 6*d*.

Jan. 27.—PORTHOUSTOCK.—*Charlotte* Life-boat.—Intimation having been received that a large steamer had struck on the Levellers Rocks, at about two o'clock in the morning, the crew of the Life-boat were summoned, the boat was launched, and on reaching the steamer found she was the *Liffey*, of London, in ballast from King's Lynn to Barrow. A dense fog prevailed at the time, the wind was blowing a moderate breeze from S.W., and the sea was smooth. The Life-boat remained alongside the vessel about three hours and then returned to her station, no immediate assistance being required, the crew awaiting the arrival of a steam-tug from Falmouth to tow her off at high water.—Expense of service, 31*l*. 17*s*.

Feb. 13.—CULLERCOATS AND OTHER LIFE-BOATS.—On this day stormy weather prevailed on our north-east coast, and many of the boats which had proceeded to their fishing-grounds were placed in great jeopardy in returning to their various ports. Several Life-boats of the Institution put off to the assistance of the boats, and rendered help to the fishermen, either by convoying the boats into harbour, or remaining at hand while they crossed the bars, a proceeding which would have been in some instances perhaps impossible, certainly dangerous, had not the Life-boats been near, ready to render help in the event of any casualty occurring.

The Life-boats thus engaged were the *Co-operator* No. 1, stationed at Cullercoats; the *John Fielden*, stationed at Whitby; the *Thomas Bewick*, of North Sunderland; the *John and Janet*, of Berwick-on-Tweed; the *Cape of Good Hope*, of Runswick; and the *Queensbury* of Scarborough.—Expenses of services, 76*l*. 10*s*. 9*d*.

Feb. 13.—HOLY ISLAND.—*Grace Darling* Life-boat.—All the Holy Island fishing-boats, with one exception, were out fishing, when the sea rose rapidly, and at 9 A.M. the Rev. D. BAYSON, Vicar of Holy Island and Honorary Secretary of the Holy Island Branch of the Royal National Life-boat Institution, saw one boat outside the bar unable to come in. Soon the Island was all excitement, women and children running and screaming. The Vicar, seeing that no boat could possibly enter, determined to do his best to effect a rescue.

He at once got together as many men as he could to form, with himself, a crew for the Life-boat, nearly all the fishermen being away in the boats, the volunteers including the sexton of the church, the fish-merchant, and some sailors, one or two of whom had come away from beds of sickness. The women promptly offered their help in launching the Life-boat, one of them, in fact, volunteering to put on a life-belt and go in the boat as one of the crew; her services, however, were not accepted in that respect, but she was asked to give her assistance in pulling at the launching ropes. A most successful launch was accomplished, the women, amongst whom was Mrs. BRYSON, the Vicar's wife, going right into the water. The Life-boat proceeded across the bar, took the crew out of one of the cibles, and towed their boat into the harbour. The Life-boat went out again twice, and on each occasion returned with a boat and her crew. The other boats were later in coming in, and when they arrived the sea had moderated, but even then one of the cibles was nearly sunk by a sea breaking at her stern. The Life-boat remained close at hand carefully watching the boats, and at 1.30, no further help being needed, returned to the harbour and was replaced in the boat-house.

The thanks of the Institution were accorded to the Rev. D. BRYSON, and a binocular glass was presented to Mrs. BRYSON in recognition of the services they so kindly rendered on this occasion.—Expense of service, 11*l.* 5*s.*

COMMITTEE MEETING, 13th Feb., 1896.

Voted 334*l.* 7*s.* 9*d.* in payment of the expenses of assemblies of the crews or launches to distressed vessels by the following Life-boats:—Barmouth, Broadstairs, Cadgwith, Cemaes, Donna Nook, Dungeness, Flamborough No. 2, Fraserburgh, Gorleston No. 1, Holyhead, North Deal, Palling No. 2, Penarth, Peterhead, Polpear, Sennen Cove, Walmer, and Withernsea.

The Ramsgate Life-boat was called out, but was not needed.—Expenses paid by the Board of Trade.

The Committee recognised the services rendered for many years by Mr. WILLIAM BROWN as coxswain of the Arbroath Life-boat; also the services of the 2nd cox-

swains of the Gorleston and Salcombe Life-boats.

Bead letter from the Trinity House forwarding 40*l.* 12*s.*, in repayment of the expenses of the Point of Ayr Life-boat in proceeding to the assistance of the Dee Light-vessel, which parted from her moorings on the 7th December.

Voted 100*l.* to the widow of one of the crew of the Dungarvan Life-boat, who died from the effects of exposure while on service with the Life-boat.

Also 18*l.* to three men injured while on service with the Mablethorpe, Drogheda No. 2, and Whithy No. 2 Life-boats.

Feb. 21.—ROBIN HOOD'S BAY and other Life-boats.—A heavy sea sprung up while fishing-boats were out, and timely assistance was rendered to them by the Life-boats *Ephraim and Hannah Fox*, stationed at Robin Hood's Bay; the *Co-operator No. 1*, of Cullercoats; and the *Robert and Susan*, of Newbiggin.—Expenses of services, 39*l.* 17*s.* 3*d.*

Feb. 21.—MONTROSE.—*Robert Henderson* Life-boat.—A very heavy sea was breaking on the bar, and, as several steam and sailing vessels were awaiting the tide to enable them to enter the harbour, the Life-boatmen were on the look-out the whole of the day. At about 3.30 p.m. a steamer in crossing the bar was struck by several heavy seas, which carried her out of her course, and she had a narrow escape of being stranded on the Annat Bank. A fore-and-aft schooner was next seen approaching the harbour at about 4 o'clock, and a little later it was evident that she was in broken water and in danger of stranding. A rocket was afterwards fired from Scurdyness, indicating that the services of the Life-boat were needed, and at about 4.30 she was launched and pulled down the river towards the ship, which had grounded about a quarter of a mile N. of the harbour entrance. In crossing the Annat Bank the Life-boat was struck several times by very heavy seas, and was driven on a shallow bank that lay between the boat and the vessel, but with considerable exertion the crew managed to get her off, and effected the rescue of the crew of four men from the schooner, which proved to be the *Regina*, of Jersey.

As it appeared doubtful whether the *Robert Henderson* Life-boat would succeed

in reaching the vessel, it was decided to take out the No. 2 Life-boat, the *Bessie Webster*. Horses were at once procured, with the view of taking her on her transporting carriage along the sands, but just as she was got down to the beach it was seen that the No. 1 Life-boat would be successful, and that the launch of the other was unnecessary. She was therefore taken back to her house.—Expenses of services, 22*l.* 7*s.* 9*d.*

Feb 23.—POOLE.—*Boy's Own No. 2* Life-boat.—Two vessels, the barquentine *Albert T. Young* and the *Hildred*, both belonging to Faversham, and laden with coal, stranded on the back of the Hook Sands, in a fresh S.E. wind and a rough sea. The Honorary Secretary proceeded to the spot and found that there was no immediate danger to their crews, who, in each instance, consisted of eight men. A number of labourers who had been employed to lighten the vessels left in the evening in a tug, and the Honorary Secretary arranged with each of the masters that, in the event of their position becoming dangerous, signals should be made. The signalman at Sandbanks was instructed to summon the Life-boat men if their services were required, and the coxswain and crew of the Life-boat held themselves in readiness to respond to the signal. At 9.15 p.m. a signal was shown at Sandbanks, and the Life-boat was promptly launched and proceeded to the vessels. The *Hildred* declined assistance, but six men from the *Albert T. Young* wished to be taken ashore. The master and mate refused to leave, but were anxious that the Boat should stand by them during the night. The six men having been landed the Life-boat went back to the vessel and remained by her until daylight, experiencing a bitterly cold night.—Expense of service, 27*l.* 17*s.* 3*d.*

Feb. 23.—CAISTER.—*Covent Garden* Life-boat.—The Cackle Light-vessel having fired guns and rockets, the Life-boat was taken out of her house, and while she was being launched a coast-guardman arrived and informed the coxswain that a barque was on the S.E. part of Hasborough Sand. The boat was afloat at 4.15 a.m. and sailed to the sand, shipping some heavy seas on her way, but found no vessel there. She then sailed down the sand and eventually came upon a barque, the *Glenberrie*, of

Glasgow, bound from Hamburg for Adelaide with a general cargo and a crew of eighteen men. She was riding on the N.W. edge of the sand. The Life-boat went alongside and, finding the master was anxious to have his vessel taken into safety, the Life-boat men agreed to do so, and, with the assistance of two steam-tugs which subsequently arrived, she was taken to Harwich. A strong gale from E.S.E. and a very heavy sea were encountered all the way. The Life-boat arrived at Yarmouth harbour at 8 p.m. on the following day.—Property salvage case.

Feb. 26.—WICK.—*John Avins* Life-boat.—The fishing-lugger *Isabella*, of Wick, while attempting to put to sea, the water being still rough after a S.W. gale, was struck by a heavy sea and was driven up the river. Both her anchors were dropped, but they were of no avail and she was soon thrown on the rocks, where the sea made a clean breach over her. The Life-boat was launched at 5 p.m., and at 6.30 returned, bringing the crew of the fishing-boat, six men in number.—Expense of service, 20*l.* 7*s.* 6*d.*

March 2.—GREENORE.—*Sir Arthur Blackwood* Life-boat.—The steamer *Rosstrevor*, of Dublin, belonging to the London and North Western Railway Company, left Greenore at about 6 p.m., bound for Holyhead, with passengers and a general cargo. She had proceeded a little distance outside Haulbowline Lighthouse, near the middle of Carlingford bar, when she struck a sunken rock and remained fast. She fired signals of distress, which were immediately answered from the Greenore Coastguard station. The crew of the Life-boat were summoned and at 7 o'clock the Boat was on her way to the vessel. On reaching the scene of the disaster, the captain requested that the Life-boat should take ashore the female passengers, children and as many male passengers as she could carry. Seventeen persons were taken on board and landed, and the Boat returned to the vessel, but found that the remaining passengers had been transferred to another of the Company's steamers, the *Severn*. The *Rosstrevor* was then afloat but was leaking badly and, with the aid of the *Severn* and the tug *Violet*, was beached a short distance from Greenore pier in order to prevent her from sinking.

In recognition of the service rendered to their vessel, the London and North Western Railway Company contributed a donation of 10*l.* 10*s.* in aid of the funds of the Greenore Branch of the Institution.—Expense of service, 25*l.* 4*s.*

March 3.—WEXFORD.—*Andrew Pickard* Life-boat.—While a moderate gale was blowing from W.S.W., with a rough sea, the fishing-yawl *Annie*, of Wexford, was observed stranded on the S. side of Wexford Bar, with the seas breaking over her. The No. 1 Life-boat was immediately manned, and at 3.45 p.m. proceeded to the vessel, dropped her anchor, and with some difficulty veered alongside. As it seemed probable that the fishing-boat could be got afloat if an anchor were laid out, the Life-boat men took out one to which a long cable was attached and, with its aid, the boat was hauled off into deep water when she floated with the rising tide.—Expense of service, 17*l.* 2*s.* 6*d.*

March 5.—BALLYWALTER.—*William Wallace* Life-boat.—Information was received that a smack had been observed about ten miles distant, eastward, from the shore, in distress and apparently signalling for help. The Life-boat was launched at 12.15 p.m., and on reaching the vessel found that she was the *Governor Ready*, of Douglas, bound from Dromore for Belfast with a cargo of paving-stones. She was entirely disabled, having been struck by a heavy squall which carried away her topmast and two jibs and tore her mainsail in ribbons, and subsequently she lost her boat. It having been seen from the shore that she had no mainsail, the Life-boat men had taken one out in the Boat. This sail, which had been kindly lent for the purpose by Mr. William Gibson, J.P., was rigged up by some of the Life-boat crew, who also patched up a jib-sail, and the vessel, with her crew of three men, was brought into Ballywalter Harbour. The Rev. Dr. Greer, Honorary Secretary, went out in the Life-boat on this occasion, and was thanked by the Committee for his kind assistance.—Expense of service, 19*l.* 0*s.* 6*d.*

March 6.—FILEY.—Temporary Life-boat.—The fishing-coble *Lionel* being observed in danger, while a strong gale was blowing from the W., accompanied by a rough sea, the reserve Life-boat, temporarily placed here while the station's Boat was being altered, was launched

and stood by the coble until she safely reached the shore.—Expense of service, 14*l.* 10*s.*

March 6.—HOLY ISLAND AND BOULMER.—*Grace Darling* and *Melissent* Life-boats.—The Holy Island No. 1 Life-boat was launched at 2.20 p.m., in a rough sea, the wind blowing a strong gale from N.W., in response to signals of distress shown by the schooner *Scotia*, of Inverness, which had stranded S.S.E. of Holy Island Castle. The vessel, however, floated off, leaking, and proceeded southward, the Life-boat following to North Sunderland, when the vessel's signals were lowered. The Boat put into North Sunderland, and on her way rendered some assistance to a coble which was in difficulties.

At 4 p.m. the vessel was sighted off Boulmer, a telephone message having been despatched there from Craster to look out for her. The Life-boat put off to her assistance and, finding her in a sinking condition, remained by her, some of the Life-boat men assisting at the pumps. A tug took her in tow and endeavoured to get her into the harbour, but before this could be accomplished she sank, her crew landing in their own boat.—Expenses of services, 42*l.* 9*s.*

March 12.—WINTERTON.—*Edward Birkbeck* Life-boat.—Shortly after 5 p.m. the cutter-rigged shrimping-boat *Adeline*, of Great Yarmouth, was observed to ship a sea, when about half a mile S.E. of Winterton, and to founder instantly. An alarm being given, the No. 1 Life-boat was launched, proceeded to the scene of the casualty and found one man clinging to the vessel's bowsprit. He was at once taken into the Life-boat and stated that another man was with him in the boat at the time the accident occurred. A diligent search was made by the Life-boat's crew, but unhappily no trace of the man could be seen; all that was found was the floating wreckage of the boat.—Expense of service, 15*l.*

COMMITTEE MEETING, 12th March, 1896.

Voted 282*l.* 18*s.* 3*d.* to pay the expenses of the assemblies of crews or launches to distressed vessels by the following Life-boats:—Aberystwyth, Dornoch Firth, Gorleston No. 1, Helbre Island, New Brighton (Steam Life-boat), North Sunderland, Palling No. 2, Penmon, Robin Hood's

Bay, Tenby, Whitelink Bay, Winterton No. 2, and Great Yarmouth.

Also 25*l.* medical expenses of men injured on service at Drogheda and Polpear.

Also the Silver Medal of the Institution, with a copy of the vote on vellum, to Mr. THOMAS WICKHAM, for long and gallant services as coxswain of the Wexford No. 1 Life-boat.

March 14.—STAITHES.—*Jonathan Stott* Life-boat. — A sudden gale of wind from E.S.E. arose in the morning and a heavy sea sprung up, endangering the safety of the fishing-cobles, which had proceeded to sea at daybreak. The Life-boat stood by them until the danger was over. —Expense of service, 13*l.* 10*s.*

March 14.—REDCAR.—*Brothers* Life-boat.—The Life-boat was launched at 10.15 A.M., and helped two fishing-boats which had been overtaken by stormy weather and a heavy sea. — Expense of service, 1*l.* 10*s.*

March 16.—BALLYWALTER.—*William Wallace* Life-boat. — The four-masted schooner *Reform*, of Stavanger, bound from Bankok for Greenock with teak wood, being sighted off Burr Point flying signals denoting that she was sinking, the crew of the Life-boat were summoned, and at 9.30 A.M., ten minutes after the alarm was given, the Boat was launched. The weather then was very bad, the wind sometimes blowing with hurricane force, with squalls of sleet and heavy seas which completely drenched the crew shortly after the Boat was launched. The vessel was reached at 10.30, when it was ascertained that she was leaking, in consequence of having struck a rock at the south of Burial Isle, off Burr Point. Endeavours were made to get rid of the water by means of the pumps, but it was found impossible to do so, and it became evident that the foundering of the ship was only a matter of time. Ultimately the crew took to the Life-boat and were safely landed, the master and mate being taken ashore by a coastguard boat which had also proceeded to the vessel. About five minutes after leaving her, the *Reform* sank in about twelve fathoms of water.—Expense of service, 20*l.* 1*s.* 6*d.*

March 27.—ST. IVES.—*Exeter* Life-boat.—Signals of distress having been

shown by a vessel lying at anchor in the bay, while a strong gale was blowing from N.N.E. with a heavy sea, the Life-boat was launched at 1.45 A.M. The vessel which signalled was the schooner *Lizzie*, of Chester, coal laden, from Swansea bound for Cherbourg. She had two anchors down, but was riding so heavily that it was feared her cables would part, and her crew of five men were anxious to be taken ashore. They were taken into the Life-boat, which then made for her station, and in passing another schooner, the *Laddie*, of St. John's, N.F., laden with codfish, from St. John's for Exeter, which was in a more dangerous position, her crew also requested to be landed. They were anxious to give the vessel more cable before leaving her, and, as this would take some little time, it was arranged that the Boat should land those she had on board and then return. This was done, and the *Laddie's* crew of seven men were also brought safely ashore, being landed in the harbour at 3.30 A.M. In the afternoon the weather moderated considerably, and, the vessels having safely ridden out the gale, their crews were put on board and in the evening resumed their respective voyages. Mr. C. J. A. French went out as one of the crew of the Life-boat on this occasion and was thanked by the Committee for the service he thus kindly and gratuitously rendered. —Expense of services, 21*l.* 1*s.*

March 27.—NORTH DEAL.—*Mary Somerville* Life-boat.—Rockets and guns being fired by the Gull Lightship and large flares being burnt by a vessel in the direction of the Brake sand, the Life-boat was launched at about 5 A.M., a whole gale blowing from N.N.W. at the time, with a heavy sea, and proceeded to the schooner *Janet*, of Carnarvon, laden with cement from Rochester for Londonderry, which had been in collision with the ketch *Tempter*, of Hull. The latter vessel had sunk, and her crew of three men, who had jumped on board the schooner, were taken into the Life-boat and were safely landed. Two of the Life-boatmen remained on board the vessel and assisted to take her to Ramsgate, with the help of a steam-tug which had been summoned from Ramsgate by a telegram despatched by the Life-boat on her return to Deal.—Expense of service, 20*l.* 5*s.*

April 11.—HELBRE ISLAND.—*Admiral Briggs* Life-boat. — The lightkeeper at Hoylake having observed a vessel ashore on the West Hoyle at once communicated with Helbre Island, with the result that the Life-boat was launched at 5.45 A.M., and proceeded towards the vessel, which was showing signals of distress. On her way, the Life-boat met a ship's boat containing the crew of four men who had left their vessel, which was ascertained to be the steam-tug *Albert*, of Chester. These men were taken into the Life-boat, which then continued her journey to the steamer and found her half full of water. Ultimately a tug arrived from Mostyn and the *Albert* was towed off the bank and taken to Mostyn, her crew accompanying her. A very strong N.W. wind was blowing during the performance of this service, the sea was very rough and the weather was very cold.—Expense of service, 21l. 12s.

April 12.—LLANDUDNO.—*Sunlight No. 1* Life-boat.—A message was received by telephone from Colwyn Bay, at about 4 o'clock in the afternoon, stating that a brigantine was showing signals of distress. She was lying at anchor about two and a half miles distant from the shore, and her crew were working hard at the pumps. The wind was then blowing a gale from N., and a very heavy sea was running. The crew and launchers of the Life-boat were summoned, and the boat was got out of her house and was about to be launched, but owing to one of the horses jibbing, the wheel-plate caught the chain trace and pulled the horse down, the wheel coming on to, but fortunately not injuring, the animal. The accident however delayed the launch, but, once afloat, the boat, after being rowed some little distance from the shore to allow of sail being hoisted, sped towards the wreck, being three times completely buried by the heavy seas which broke over her, reached the vessel, rescued her crew of four men, and safely landed them at Colwyn Bay. She was the *Waree*, of and for Dundalk from Liverpool, coal laden, and was in a sinking state in consequence of having sprung a leak and of the stress of weather, and a report was afterwards received that she had gone down.—Expense of service, 45l. 17s.

April 12.—ALDEBURGH.—*Aldeburgh* Life-boat.—A message by telephone was

received from the Shipwash Light-vessel reporting that a vessel was stranded on the Shipwash Sands. A strong N.W. breeze was blowing, accompanied by squalls of snow, and the sea was rough. The Life-boat was launched at 4.58 P.M., eight minutes after the message arrived, and found the ship *MacMillan*, of Glasgow, in ballast from London for Frederickstadt, stranded near the middle of the sands, with her ensign flying, union down, in the mizen rigging. The master gave up charge to the Life-boat men, with the view of their getting the ship off the sands, and at high water this having been accomplished she returned to Gravesend.—Property salvage case.

April 13.—BLACKPOOL.—*Samuel Fletcher* Life-boat.—At about 6 o'clock in the morning, while the wind was blowing strongly from the N.N.W. and a heavy sea was running, the fishing-smack *Harriet*, of Marshside, was observed in difficulties off Blackpool. After watching her course for a while, it was evident that she had become unmanageable, and therefore the Life-boat was launched and went to her assistance. Proceeding in a southerly direction, the fishing-boat struck the Crusader Bank, two miles south of Blackpool, before the Life-boat could bear down on her, and rolled over on her starboard side. Her crew of four men, who were in a very exhausted condition, were taken into the Life-boat, and the vessel was afterwards taken to Lytham in charge of three of the Life-boat men.—Expense of service, 8l. 10s.

April 16.—WEXFORD.—*Andrew Pickard* Life-boat.—While a moderate gale from W.S.W. to N.W. was blowing, accompanied by a rough sea, signals of distress were seen flying on a fishing-smack. The Life-boat was launched at 9.45 A.M., sailed over the bar, and on reaching the fishing-boat—the *Prairie Flower*—found that all her sails had been blown away, and she had on board only one man, who stated that his father had fallen overboard and had been drowned before the signals of distress were hoisted. The man was almost distracted, and, being entirely unable to help himself in any way, his boat was simply drifting out to sea. Two of the Life-boat crew got on board the vessel and, having made ropes fast to her, towed her into Wexford Harbour.—Expense of service, 7l. 13s. 6d.

COMMITTEE MEETING, 16th April, 1896.

Voted 3*1*l. 1*6*s. 6*d.* to pay the expenses of the assemblies of crews or launches to distressed vessels by the Life-boats at Appledore, Blakeney, Broadstairs, Caister, Clacton, Cloughy, Dartmouth, Dungarvan, Hartlepool, Kessingland, Kildonan, Llandudno, Lowestoft, New Romney, Palling, Penmon, Point of Ayr, Port Eynon and Winterton. The Ramsgate Life-boat was taken out twice, but was not needed.

Also 2*l.* 10*s.* to a man injured on service at St. Helier's.

The Committee recognised the good services rendered by Mr. DAVID SULLIVAN, coxswain of the Ballycotton Life-boat. Also the services of the second coxswains of the Dungarvan and Lizard Life-boats.

May 7. — BROADSTAIRS. — *Christopher Waud, Bradford*, Life-boat.—The brig *Flamingo*, of Farsund, from Christiansand for Cardiff, having been observed running in the direction of the north end of the Goodwin Sands, the crew of the Broadstairs Life-boat were summoned. Soon afterwards signal-guns were fired by the light-vessel, and the Life-boat was at once launched and proceeded to the brig, which had stranded on the sands. Some of the Life-boat men boarded the vessel and stowed the sails. The Ramsgate tug then arrived and, after towing about three hours, the vessel floated and was taken to Ramsgate Harbour.—Property salvage case.

May 13.—GORLESTON.—*Mark Lane* Life-boat.—The Life-boat was launched at about 4 A.M. and proceeded to the steam trawler *Chanticleer*, of Lowestoft, which had stranded on the South Scroby Sand, on which a rough sea was breaking. It was found that the water had risen in the hold and had extinguished the fires. The crew at once transferred their effects to the Life-boat. An anchor had already been laid out by the vessel's crew; the Life-boat men got a spring on it, and with the flood tide the vessel swung off into deep water, being then taken in tow by the steam-tug *United Service*, which took her into the harbour.—Property salvage case.

COMMITTEE MEETING, 14th May, 1896.

Voted 122*l.* 9*s.* 8*d.* to pay the expenses of the assemblies of crews or launches to distressed vessels by the Life-boats at Caister, Formby, Palling, Walmer, and Winterton.

The Ramsgate Life-boat was also taken out, but her services were not required.—Expenses paid by the Board of Trade.

Voted 5*l.* 18*s.* 6*d.* to two men slightly injured on service at Walton-on-the-Naze, Hasborough and Pakefield.

May 28.—PALLING.—*Good Hope* Life-boat.—Soon after midnight, while a strong N.N.E. wind was blowing and a heavy sea running, a vessel was reported to have stranded on the beach at Waxham, two and a half miles southward of the Palling Life-boat station. The No. 1 Life-boat was promptly got ready, horses were procured, and the boat was taken along the beach towards the scene of the wreck, the coxswain sending two men forward to find out the best place for launching. Meanwhile a boat, containing the master's wife and two of the crew, put off from the vessel, but was unable to reach the shore, as a rope by which the boat was attached to the vessel was not of sufficient length. The boat was seen by the two men who were going along the beach, and having ascertained that those on board were unable to cut the rope, they, with a third man, waded out at some risk, severed the rope, and the boat then drifted ashore safely. But for the prompt aid thus afforded there is little doubt that the boat would have been capsized in the breakers. On the arrival of the Life-boat she was successfully launched and duly rescued the two seamen left on board the vessel, which proved to be the ketch *Rival* of and for Rye from Goole, laden with coal.—Expense of service, 25*l.* 7*s.*

May 29.—CASTLETOWN, ISLE OF MAN.—*Hope* Life-boat.—A small yacht, the *Luffra*, of Douglas, was reported to be in distress and quite unmanageable off Santon Head while a whole gale was blowing from N.E. with a very heavy sea. The Life-boat was launched at 2.12 P.M. and rescued the sole occupant of the vessel. She was engaged over seven hours in rendering this service, and did not regain her station

until 10 o'clock at night.—Expense of service, 22*l.* 3*s.*

June 6.—FRASERBURGH.—*Anna Maria Lec* Life-boat.—The coxswain of the Life-boat observed a vessel—the schooner *Noble*, of Banff, laden with coal from Sunderland—driving towards the rocks. A heavy sea was running at the time, and it was deemed advisable to have the Life-boat launched. When the Life-boat reached the vessel she was just entering the broken water. Some of the Life-boat men boarded her, a kedge was run out, after which she was warped out seawards and then taken into the harbour.—Expense of service, 13*l.* 5*s.*

June 11.—NEW BRIGHTON.—*Duke of Northumberland* Steam Life-boat.—A telephone message having been received from the lightkeeper at Bidston light-house, reporting that a ship was on fire in Formby Channel and was showing signals of distress, the steam Life-boat proceeded to her assistance at 3.20 P.M., and found she was the ship *Maréchal Suchet*, of London, bound from Liverpool for Calcutta with a cargo of salt. She was taken possession of by the Dock Board tenders, which were provided with pumps, the Life-boat remaining at hand until the crew were out of danger.—Expense of service, 5*l.* 1*s.*

COMMITTEE MEETING, 11th June, 1896.

Voted 78*l.* 9*s.* 8*d.* to pay the expenses of the assemblies of crews, watching, or launches to distressed vessels by the following Life-boats:—Dunwich, Kingsdowne, Margate, Tynemouth, Uppang, Whitby No. 2, Whitehaven and Winterton No. 1.

COMMITTEE MEETING, 9th July, 1896.

Voted 41*l.* 10*s.* in payment of the expenses of the Formby, Holy Island No. 1 and Winterton No. 2 Life-boats in launching with the intention of rendering help to vessels which were apparently in need of assistance.

July 15.—NEWQUAY, CORNWALL.—*Willie Rogers* Life-boat.—A telephone message was received by the coastguard that a vessel was drifting to the westward with a signal of distress flying, and required the assistance of the Newquay Life-boat.

It was then blowing a moderate gale of wind from the N.N.E., accompanied by rather a heavy sea. No horses being available the boat was taken by hand to the slipway at Towan Head and quickly launched. She reached the vessel in about two and a half hours' time and found she was the pilot-boat *Polly* of Barry; she was in a dismantled condition and had brought up about half a mile from the shore. When the Life-boat arrived alongside the men wished to be taken into her, as they were quite exhausted; at the same time they were naturally desirous that the vessel should be extricated from her perilous position. Four Life-boat men boarded her and, with the aid of the main gaff, rigged a jury mast, and, with the assistance of the Life-boat, she was taken to St. Ives, the whole of the men being drenched to the skin. It was found impracticable for the Life-boat to return to her station that night, but she did so safely the next day against a stiff breeze after a passage of twelve hours' duration.—Expense of service, 36*l.* 7*s.* 8*d.*

July 27.—WHITBY.—*John Fielden* Life-boat.—Two fishing-cobles belonging to this port, the *Star of Peace* and the *Mary Ann*, were observed to be making for the harbour in the evening. On account of the heavy sea and the tide running out it was seen that they would incur considerable risk in crossing the bar. Accordingly the Life-boat was launched, and proceeding out she escorted the boats safely over the bar, their crews being greatly encouraged by the presence of the Life-boat.—Expense of service, 10*l.*

July 29.—HOYLAKE AND NEW BRIGHTON.—*Coard William Squarey* Life-boat and *Duke of Northumberland* Steam Life-boat.—The s.s. *Flying Falcon*, of Liverpool, bound there from Mostyn with a large number of passengers, stranded on the East Hoyle Sandbank near Spencer's Spit. The weather was moderate, but as the steamer was crowded with passengers it was thought advisable to launch the Hoylake Life-boat and also to take the Steam Life-boat to the spot from New Brighton. The former boat was the first to arrive, and after communicating with the captain it was arranged to transfer seventy-six of the passengers to the Steam Life-boat, which was done by the Hoylake boat, after which they were

taken to Liverpool. The remainder of those on board decided to remain until the flood tide made, when she floated and resumed her voyage.—Expenses of service, 43*l.* 10*s.*

Aug. 1.—WHITBY.—*Robert and Mary Ellis* and *John Fielden* Life-boats.—These Life-boats put off to the help of the s.s. *Lady Grey* of West Hartlepool, which had stranded on Whitby Rocks about half a mile from the West Pier head. Her captain had come ashore in the ship's life-boat in order to communicate with the owners, but with the rising tide a very strong sea came in from the N.E., which prevented the return of the ship's boat and made it too dangerous for cobsles to approach the stranded vessel. Accordingly the aid of the Whitby Life-boats was solicited, and they took out the master with about 150 shoremen to throw the cargo of coal overboard. After many hours' work the steamer was got off, with the aid of five powerful steam-tugs, and taken to Hartlepool in a damaged condition.—Property salvage case.

COMMITTEE MEETING, 13th August, 1896.

Voted 141*l.* 5*s.* 6*d.* to pay the expenses of the Blackpool, Cahore, Clovelly, Fethard, Hayle, Skegness, St. Ives, Sutton and Swansea Life-boats in assembling their crews or putting off to assist vessels in distress.

The Ramsgate Life-boat was also taken out, but was not eventually needed.—Expenses paid by the Board of Trade.

Voted 8*l.* 6*s.* to a man injured at Winterton Life-boat station.

Sept. 2.—SUNDERLAND.—*Richard and Nellie Hodges* Life-boat.—The brig *Prince Consort*, of Faversham, was being towed to Sunderland when the steam-tug ran ashore in a thick fog and was followed by the brig. Signals of distress were exhibited and the Life-boat was at once launched in a heavy sea; the steam-tug *Earl of Glamorgan* also proceeded to the spot. At the request of the master the Life-boat remained in attendance, passed the tow rope to the steamer and eventually the vessels were extricated from their perilous position.—Expense of service, 25*l.* 3*s.*

Sept. 3.—WHITBY.—*John Fielden* Life-boat.—The Life-boat proceeded to the bar and remained there until the fishing-

cobsles entered the harbour in stormy weather.—Expense of service, 9*l.* 10*s.*

COMMITTEE MEETING, 10th Sept., 1896.

Voted 71*l.* 16*s.* to the crews of the Life-boats at Aldeburgh, Alnmouth, Formby, New Brighton, Penmon, Poolbeg and Wexford, for either assembling or going out in the Life-boats.

Also 2*l.* 1*s.* to a man injured at Lizard Life-boat station.

Sept. 14.—PORT ERIN, ISLE OF MAN.—*William Sugden* Life-boat.—The Life-boat was despatched to the assistance of two fishing-boats which had been overtaken when on the lee side of Calf Island by a gale from the north-west and a heavy sea, causing great anxiety to be felt for the safety of the fishermen. Having come up with the boats the Life-boat escorted them safely into harbour, to the great relief of all on shore.—Expense of service, 9*l.* 12*s.*

Sept. 17.—RAMSEY, ISLE OF MAN.—*Mary Isabella* Life-boat.—What was reported locally as "a most admirable service, quickly and gallantly rendered," was performed by the new Life-boat on this station. In the afternoon the smack *Grace Darling*, of Ramsey, was seen to be flying a signal of distress about two-and-a-half miles north-east of the harbour. It was blowing a whole gale from the S.W., and a very heavy sea was running at the time. The smack had lost her sails, and one anchor had parted, while the remaining anchor was dragging. The Life-boat was soon launched, but before she could reach the distressed vessel she had drifted some distance; great difficulty was experienced in getting near enough to save those on board, but after a prolonged struggle the three men were taken off and safely landed.—Expense of service, 13*l.* 13*s.* 6*d.*

Sept. 17.—WHITEHAVEN.—*Elizabeth Leicester* Life-boat.—At about 5 P.M., there was a strong south-westerly wind and a heavy sea, and the schooner *Kate*, of Peel, 122 tons register, was coming into Whitehaven Harbour light, for coal. She failed to get close enough round the West Pier, and shot beyond the North Wall, threatening to run ashore on the rocks at Redness Point. Her anchor was dropped, and she was brought up in just sufficient water to

keep her off the bottom and there she tossed helplessly, slowly dragging her anchor, in no immediate danger, but gradually going ashore. After some time the steam-tug *Florence* tried to obtain communication by line, but without success, as in such a sea she was in danger of being dashed against the schooner. Then a couple of rockets were discharged from the neighbourhood of the Life-boat house, and soon there was a crowd cheering lustily as the Life-boat was launched through the surf. It was hard work getting clear of the heavy breakers, but the Life-boat succeeded in passing a line from the vessel to the tug; a cable was then hauled on board and the Life-boat made fast astern. The anchor was slipped, and vessel and Life-boat were towed into the harbour just as darkness was setting in.—Expense of service, 18*l.* 18*s.*

Sept. 17.—PWLLEH.—*Margaret Platt* Life-boat.—The yacht *Atalanta* was making for the harbour for shelter from a strong southerly gale, a heavy sea running at the time, when she ran foul of a hawser by which the schooner *Mouse* of Cardigan was secured to a buoy, causing her to drift down on the vessel; fortunately she was able to make fast to her or she would have been wrecked on the Abererch shore. Seeing her peril the Life-boat was launched and brought the owner and two of the crew safely ashore. The yacht was also brought into safety, and the Life-boat landed the schooner's crew of three men as that vessel was bumping heavily; and she was brought into harbour on the following morning, on the weather moderating.—Expense of service, 16*l.* 13*s.*

Sept. 22.—CARDIGAN.—*Lizzie and Charles Leigh Clare* Life-boat.—While a strong gale was blowing from the W.N.W., and a very high sea was running, the smack *Christiana* of Cardigan was observed to be flying a signal of distress in the bay. A rocket was fired to muster the crew of the Life-boat, and the boat was launched and saved the crew of two men from the smack, which afterwards became a total wreck.—Expense of service, 10*l.* 3*s.*

Sept. 25.—LOWESTOFT.—*Samuel Plimsoll* Life-boat.—While a heavy gale was blowing from S.S.E. accompanied by a very high sea, the Lowestoft Life-boat was launched in reply to signals of distress, and found the lugger *Mystery*, of that

port, in a very dangerous position, and driving from her anchors on the north flats about one mile to the northward of the Low light-house. The crew of five men having been taken on the Life-boat, the lugger was made fast under the lee quarter of the boat, and towed into harbour.—Expense of service, 16*l.* 16*s.* 6*d.*

Without returning to her moorings the Life-boat again proceeded to sea to the assistance of the ketch *Sussex Belle*, of London. She had just got outside the pier-head in tow of the steam-tug *Rainbow*, when the cable slipped off the steamer's towing-hook, and the boat and crew were placed in a position of great jeopardy; however, by promptly setting the foresail the boat just managed to clear the north pier extension, otherwise in such very stormy weather both she and the crew must have been lost. They proceeded under sail as far as the Corton Sand, when the steam-tug came up with them and took them in tow again. On arriving alongside the vessel in distress, the master requested the assistance of the Life-boat; accordingly several of her crew went on board, and a rope having been passed from the steamer, the ketch (which had on board the master, his wife, and crew of three men) and the Life-boat were taken into harbour.—Property salvage case.

Sept. 25.—FOLKESTONE.—*J. McConnel Hussey* Life-boat.—A gale of great violence was experienced here, and continued unabated for some hours. About four o'clock in the morning the barque *Agder*, of Frederikstadt, which was at anchor off Folkestone, slipped her cable and afterwards struck on the rocks opposite the Life-boat house an hour before low water. The Life-boat was successfully launched through a very heavy sea, but owing to the want of water it was an hour before she could get alongside the ship. When she arrived there four of the crew were taken into the boat, but the others could not be persuaded to leave. For about three-quarters of an hour the boat lay broadside on to the sea, and then, having her rudder damaged, five oars broken, and received other damage, she returned to land. While preparations were being made to repair the damages, the coxswain and others of the crew expressed their readiness to go off again without waiting

for that to be done, and accordingly the boat was again run down to the water's edge preparatory to launching; but seeing that the ship would drive on to the beach before they could get afloat the crew ran towards her to assist in getting the remainder of the crew ashore, which was safely done with life-lines. The Hythe Life-boat had been telegraphed for when the other boat was first seen to be disabled, and the crew gallantly responded to the call, but long before they could possibly get near the wreck the crew had all been saved. The coxswain and crew were loud in their praises of the manner in which the Life-boat behaved under very trying circumstances.—Expense of service, 18*l.* 3*s.*

Sept. 25.—WEXFORD.—*Andrew Pickard* Life-boat.—In the evening, while the wind was blowing a gale from the N.W., intelligence was received that a steamer was firing signals of distress. With all possible despatch the Life-boat proceeded through a very heavy sea in the direction indicated. On arriving alongside the steamer, it appeared that she wanted to get into Wexford, having run short of fuel. By arrangement with the master the Life-boat remained by her all night and piloted her into harbour next morning.—Property salvage case.

Sept. 25.—HOYLAKE.—*Card William Squarey* Life-boat.—The Life-boat was taken out for service on the occasion of the flat *Catharine*, of Liverpool, going ashore about a mile from the Life-boat station during a whole gale from the north and a very heavy sea. When she arrived at the scene of the wreck she found that the crew of two men had been compelled to take to the rigging as the seas were making a complete breach over the vessel; with difficulty they were extricated from their perilous position and brought safely ashore in the Life-boat.—Expense of service, 16*l.* 10*s.*

Sept. 25.—WALMER.—Reserve Life-boat.—The Life-boat temporarily placed here during the absence of the station's boat was launched at about 8.30 A.M. in a heavy sea, the wind blowing a whole gale from W.S.W., to the help of two vessels which had been in collision. One of them, the barquentine *Liana*, lost her jibboom and head gear and hoisted a signal of distress. The Life-boat men assisted in clearing the vessel, and with

the aid of a steam-tug took her to Rams-gate.—Property salvage case.

Sept. 25.—GORLESTON.—*Mark Lane* Life-boat.—In response to signals from the St. Nicholas Light-vessel the Life-boat went out while a whole gale was blowing from S., with thick weather and an exceptionally heavy sea, and found the dandy *Endeavour*, of Lowestoft, considerably damaged by collision with a brigantine. The crew of four men had jumped on board the other vessel when the collision occurred, and the master only remained on board. He declined any assistance, and by manœuvring his vessel under small sail succeeded in taking her into the roadstead. The Life-boat went to the brigantine and landed the smack's crew.—Expense of service, 13*l.* 16*s.* 6*d.*

Sept. 25.—ALDEBURGH.—*Aldeburgh* Life-boat.—The Life-boat was launched at 10 A.M. in a strong gale and went to the assistance of the schooner *Aire*, of and from Goole, bound for London with coal, which was dragging her anchor and was in imminent danger of striking on the outer shoal, on which a very heavy sea was breaking. The vessel's crew of three men and a boy were taken into the Life-boat and were safely landed. The boat encountered heavy seas, which struck her with great force and broke clean over her, but she gallantly sailed through them, her behaviour being greatly admired by hundreds of spectators.—Expense of service, 21*l.* 1*s.* 6*d.*

Sept. 25.—SOUTHWOLD.—*Alfred Corry* Life-boat.—The ketch *Eliza and Alice*, of Goole, was observed riding with two anchors down in a dangerous position in a whole gale from S., a very heavy sea and thick weather. The Life-boat was launched at 11.30 A.M., and at the request of the master remained by the vessel until she was able, the wind having moderated, to weigh her anchors and get away from her perilous situation.—Expense of service, 16*l.* 14*s.*

Sept. 25.—TENBY.—*Anne Collin* Life-boat.—While a strong gale was blowing from N.N.W., with a very heavy ground sea, two coasting vessels, the *Anne and Betsy* and the *Albatross*, both belonging to, and bound for Aberporth from Burry Port, coal laden, showed signals of distress. Their crews, four men in all, got into the Life-boat and were landed as a pre-

cautionary measure, it being feared that the vessels would drag their anchors.—Expense of service, 17l. 6s.

Sept. 25.—HOLYHEAD.—*Joseph Whitworth* Life-boat.—The ketch *Clara*, of and from Milford, for Connah's Quay, in ballast, signalled for assistance as she was dragging her anchors while a strong gale was blowing from the N., with a heavy sea. The Life-boat proceeded to her assistance, her anchors were slipped and, with the help of a steam-tug, she was taken into harbour.—Property salvage case.

Oct. 6.—PALLING.—*Hearts of Oak* Life-boat.—While a strong gale was blowing from S.W., with a rough sea, the s.s. *Ellington*, of Newcastle, bound from Goole for Portsmouth, with a cargo of coal, stranded on Palling Beach. The Life-boat put off to her assistance at 7.45 P.M., remained by her until she was got afloat and accompanied her to Yarmouth, leaving her safely anchored in the roadstead there.—Property salvage case.

Oct. 6.—SOUTHEND, ESSEX.—*Theodore and Herbert* Life-boat.—While a gale of wind was blowing from S.S.W., the manager to the contractors for the pier extension works informed the coxswain of the Life-boat that seven men who had been engaged on the works were in danger, their own boat having failed in three attempts to take them off. As the tide was rising and the wind was increasing, it was decided to proceed to their rescue in the Life-boat, and they were brought safely to land.—Expense of service, 17l. 15s.

Oct. 7.—MONTROSE.—*Robert Henderson* Life-boat.—A large barque in tow of a steam-tug anchored to the east of Scurdyness at about 5.30 P.M. The weather was then comparatively fine, but later on the wind suddenly changed to E.S.E., increasing to a strong gale and causing a very heavy sea. At midnight, it having been reported that the barque was burning signals, the Life-boat was launched, proceeded to her and found she was the *Banklands*, of Liverpool. At the master's request his wife, her mother and child, were taken into the Life-boat and safely landed. Considerable difficulty was experienced in taking them into the Life-boat, the heavy seas several times dashing the boat against the ship's side, breaking several oars and injuring the boat.—Expense of service, 30l. 2s. 6d.

Oct. 7-8.—ABERSOCH.—*Oldham* Life-boat.—On the 7th October while a gale was blowing from S. with a heavy sea, the schooner *Mouse*, of Cardigan, was observed riding in a very dangerous position and showing signals of distress. The Life-boat was launched at 6.30 P.M. and landed the crew of three men from the vessel, which dragged her anchor and stranded, but was eventually got into safety.

At 8.30 on the following morning signals of distress being shown by the schooner *John Gibson*, of Fleetwood, the Life-boat proceeded to her and landed her crew of four men. The boat was then called to the schooner *Ker Plant*, of Padstow, and landed eight persons, including the master's wife and children. Afterwards the smack *Topaz*, of Milford, signalled, and her crew of three men were landed at Abersoch. Finally the Life-boat went to the ketch *W. S. Scott*, of Newport, and landed the crew of four men at Llanbedrog. By the time the men had been landed, the wind had increased to a whole gale accompanied by tremendous seas. The vessels safely rode out the gale.—Expense of service, 40l. 2s.

Oct. 8.—WICKLOW.—*Robert Theophilus Garden* Life-boat.—While a whole gale was blowing from W.S.W. the Life-boat was launched at about 3.5 A.M., and proceeded to the schooner *William and Henry*, of Wicklow, which was lying at anchor in the bay, and was showing signals of distress, as she had lost some of her sails and was leaking. Some of the Life-boat men went on board and assisted at the pumps, and on the weather somewhat moderating the vessel was taken into the harbour.—Property salvage case.

Oct. 8.—CEMAES.—*George Evans* Life-boat.—Information having been received that a vessel was showing signals of distress in Cemaes Bay, the Life-boat was launched at 8 A.M. in a very heavy sea, the wind blowing a whole gale from S.W., and found the schooner *Mersey*, of Dublin, dragging her anchors. Her crew of three men were in an exhausted condition, and were taken in the Life-boat to Cemaes, where they received every attention.—Expense of service, 12l. 11s.

Oct. 8.—MONTROSE.—*Robert Henderson* Life-boat.—At 10 A.M. the Life-boat,

having been signalled for from Scurdyness, was launched in a very heavy sea, the wind blowing a moderate gale from S.S.W., and found the ketch *Kate Mudd* and two fishing boats in the offing. The Life-boat remained inside the bar until the ketch and one of the fishing boats had safely crossed, the other boat proceeding northwards.—Expense of service, 1*l.* 1*s.* 9*d.*

Oct. 8.—KINGSTOWN.—*Hannah Pickard* Life-boat.—A telegram was received from Blackrock stating that five men who had gone to work on the wreck of the *Palme* on the previous morning had not returned. As the wind was blowing a moderate gale from S.W. with heavy squalls and a heavy sea, the Life-boat proceeded at 11.30 A.M. to the men's assistance, but nothing could be seen of them. It being impossible to get alongside and search the wreck, the Life-boat men shouted, but received no response whatever. The Life-boat therefore returned to the shore. Shortly afterwards signals were observed from the wreck, and once again the Life-boat put off, and succeeded in saving the five men. It appeared that they had heard the Life-boat crew hail them on the first occasion, but were unable to leave the cabin to answer, owing to the heavy seas which were breaking completely over them, but when the sea fell they were enabled to get out of their place of refuge, and made the signal which happily resulted in their being rescued. A good deal of difficulty was experienced in getting them off the wreck, as on account of the heavy surf and seas breaking over it the Life-boat could not be taken alongside. She approached as close as possible, and having attached her grapnel to the wreck, each of the men were hauled by ropes through the intervening water to the Life-boat.

Captain A. A. WALKER, of the Local Marine Board, Dublin, went out in the Life-boat on the second occasion, and was thanked by the Institution for his service.—Expense of service, 1*2l.* 3*s.*

Oct. 8.—TENBY.—*Anne Collin* Life-boat.—The Life-boat put off three times in a very heavy gale from S. to S.W., and a very heavy sea. The storm is reported to have been the worst experienced on this part of the coast since the year 1844. The first launch took place at 2.30 A.M., in response to signals shown by a steamer,

which, however, succeeded in making Caldy Roads without assistance. The Life-boat landed at Sandersfoot and was taken back to the station by road, on her transporting carriage. At 2 P.M., a message by telephone was received from Caldy Light-house, reporting that two vessels in the roadstead had signals of distress flying. Owing to the state of the tide and as the wind was blowing from S.W. it was decided to take the Life-boat across the sands nearly as far as Giltar, and she was successfully launched, although it was nearly low water. The crews of four vessels were anxious to be taken ashore, and were safely landed by the Life-boat. They numbered fifteen men in all and belonged to the schooner *Lake Patas*, of Barrow; ketch *Sage*, of Carnarvon; and schooners *Samuel Dixon* and *Margaret*, of Wexford. Immediately after landing these men the boat was again called out by signals from the brigantine *Rival*, of Belfast, which was lying in the roadstead and was in danger of dragging her anchors. Her crew of six men were taken into the Life-boat and landed at 7.15 P.M. Valuable help was rendered on these occasions by J. G. Lock, Esq., M.R.C.S., J.P., the Honorary Secretary, whose services were specially recognized by the Institution.—Expense of services, 10*1l.* 10*s.* 6*d.*

Oct. 8.—ABERDOVEY.—*Thomas Niccolls* Stratford Life-boat.—At 3.30 P.M. the Life-boat was launched and saved the trawler *Hadassah*, of Aberystwyth, which had parted from her moorings in the estuary and drifted on to the bar. No one was on board the vessel. A ship's boat had tried to reach her, but was compelled to give up the attempt, a strong S.W. gale blowing at the time, and the sea being very heavy.—Property salvage case.

Oct. 8.—RAMSEY, ISLE OF MAN.—*Mary Isabella* Life-boat.—The Life-boat was called out in very bad weather, a dismantled vessel having been observed about three miles east of the harbour. The boat reached her in about an hour's time and found she was the barque *Giovanni*, of Lillesand, bound in ballast from Fleetwood to Savannah. The crew of thirteen men having been taken into the Life-boat she had to anchor close by for some three or four hours owing to the fury of the gale and the strong ebb spring tide.

When the force of the tide had somewhat abated the boat cast off and made for the harbour, and after two hours' further battling against the storm she landed the rescued men at the Queen's Pier. They were very much exhausted by their long exposure, and the Life-boat men had a hard time of it; the latter were cheered again and again by the great crowds which had assembled to welcome their return.—Expense of service, 24*l.* 16*s.* 6*d.*

COMMITTEE MEETING, 8th Oct., 1896.

Voted 51*6l.* 9*s.* 4*d.* to pay the expenses of the following Life-boats in either assembling crews or putting off with the view of succouring the crews of vessels in distress:—Aldeburgh, Bembridge, Caister, Clacton, Dover, Dungeness, Filey, Gorleston, Great Yarmouth, Harwich, Hastings, Hayle, Holyhead, Hoylake, Ilfracombe, Kingsdowne, New Romney, North Deal, Padstow, Palling, Penarth, Port Patrick, St. Ives, Southsea, Walmer, Walton-on-the-Naze, Wells, Weymouth and Winterton.

Also 14*l.* to two men injured on service at Great Yarmouth.

The Ramsgate Life-boat was also called out.—Expense paid by the Board of Trade.

Oct. 9. — WHITEHAVEN. — *Elizabeth Leicester* Life-boat.—The schooner *Tom Henry*, of Kirkwall, bound from Fowey for Runcorn, failed to enter the harbour while a heavy gale was blowing from S.W., with a rough sea, and anchored behind the north pier. She drove towards the beach, and as she was in a very dangerous position, the Life-boat put off and rescued her crew of five men. The vessel shortly afterwards became a total wreck.—Expense of service, 20*l.* 2*s.*

Oct. 9.—NEWBIGGIN.—*Robert and Susan* Life-boat.—Two fishing-cobles returning from Seaham were unable to land at Newbiggin owing to the rough state of the sea, the wind blowing a moderate gale from S.W. The Life-boat was launched at noon, so as to be at hand should any casualty occur, and remained until they safely landed.—Expense of service, 16*l.* 17*s.* 6*d.*

Oct. 11.—PENMON.—*Christopher Brown* Life-boat.—The Penmon pilots having observed a dismasted vessel aground on the Dutchman's Bank, the crew of the

Life-boat were at once summoned by telephone, and at 7.30 A.M. the Boat proceeded under sail towards the vessel. Owing to the state of the tide the Life-boat could not approach within about a mile of her. The Boat was therefore taken on the bank and three of her crew volunteered to wade ashore and walk to the vessel. One of them returned and reported that there were eleven men on board and that they wanted the Life-boat, as their own boats were disabled. At 9 A.M. the Life-boat was enabled to reach the wreck, and rescued the crew and landed them safely at Beaumaris. The stranded vessel was the barque *Minde*, of Farsund, laden with timber from Canada for Manchester. Sir RICHARD WILLIAMS BULKLEY, Bart., Vice-President of the Anglesey Branch of the Institution, and Wm. M. PRESTON, Esq., Treasurer and Hon. Secretary of the Branch, went in the Life-boat on this occasion.—Expense of service, 15*l.* 5*s.*

Oct. 11.—CLOUGHHEY.—*Faith* Life-boat. — At 11.25 P.M. the Life-boat was launched, a report having been received that a vessel was aground on the North Rock. On reaching the vessel she was found to be the brigantine *Brothers*, of and for Drogheda, coal laden from Ayr. As she was leaking badly and a heavy sea was running, her crew of five men were taken ashore by the Life-boat.—Expense of service, 26*l.* 2*s.*

Oct. 13. — HUNSTANTON. — *Licensed Victualler* Life-boat.—At 5.30 A.M. the Life-boat was launched to the assistance of the barge *Ruby*, of London, which had stranded on the inner edge of the Woolpack Sand. Some of the Life-boatmen boarded the vessel, sail was made and, steered by means of her mainsail, her rudder being disabled, she was taken to New Hunstanton, where she was beached, her crew of four men being taken ashore in the Life-boat.—Property salvage case.

Oct. 13.—LYNMOUTH.—*Louisa* Life-boat. — At 11 P.M. signals of distress were observed, and seven minutes afterwards the Life-boat was in the water and on her way to the vessel in distress. She proved to be the smack *Mary*, of and for Lynmouth from Bristol, unmanageable, having been struck by a squall which carried away her mainsail. Her anchor, which she had at once let go, was dragging; she was close to the rocks, and was continu-

ally swept by the heavy seas. The Life-boat took her in tow, and a favourable change in the wind occurring, she was taken safely into port.—Expense of service, 27*l.* 6*s.*

Oct. 15.—PENMON.—*Christopher Brown* Life-boat.—The pilots having observed a vessel strand on the Dutchman's Bank, at once summoned the crew of the Life-boat by telephone, and at 9 A.M. the boat was launched, Sir RICHARD WILLIAMS BULKELEY, Bart., Vice-President of the Anglesey Branch of the Institution, and WILLIAM M. PRESTON, Esq., Hon. Secretary of the Branch, going off with the crew. When nearing the vessel, very shallow water was entered, and the Life-boat took the ground several times, and considerable difficulty was experienced in getting alongside the stranded craft. Eventually this was accomplished, and the crew of three men and the master's wife were rescued. Fresh difficulty was then encountered in getting the boat off the sand, on which she had stuck, and as the tide was ebbing, it required great exertion on the part of the Life-boatmen to get her off. They eventually succeeded in doing so, and at 10.30 the rescued persons were landed at Penmon. The vessel was the flat *Sefton*, of Liverpool, coal laden from Conway for port Dinorwic.—Expense of service, 13*l.* 7*s.* 6*d.*

Oct. 15.—ARBROATH.—*William Souter* Life-boat.—Fears being entertained for the safety of twelve fishing boats which were seen to be making for the harbour, the Life-boat was launched at about 11 A.M., so as to be in readiness should any casualty befall the fishermen, the wind blowing strongly from E.N.E. and there being a heavy sea on the bar. The Life-boat stood by the boats until they safely entered the harbour.—No charge made, the service being rendered to fishermen.

Oct. 15.—ST. ANDREW'S.—*Louisa* Life-boat.—Three boats returning from the fishing-grounds were overtaken by a gale from the N.E., and as a heavy sea was breaking at the harbour's mouth, they showed signals of distress. The Life-boat was launched to their assistance at 6.15 P.M., and remained in attendance until the fishermen had safely entered the harbour.—Expense of service, 11*l.* 17*s.*

Oct. 15.—PAKEFIELD.—*The Two Sisters, Mary and Hannah*, Life-boat.—

At 11.20 P.M. the Life-boat was launched, signals of distress having been seen, and on arriving at the Newcome Sands found the dandy *Jolly Tar*, of Lowestoft, stranded there. The Life-boat men assisted at the pumps with the view of saving the vessel, but their efforts were of no avail, and eventually the crew of five men were taken into the Life-boat, the smack becoming a total wreck. At the time of launching the Life-boat a moderate breeze was blowing from N.E., but the wind afterwards increased to almost hurricane force accompanied by a heavy sea.—Expense of service, 39*l.* 12*s.* 6*d.*

Oct. 16.—BRANCASTER.—*Alfred S. Genth* Life-boat.—A flare being observed in the direction of the Middle Sand the Life-boat was launched at 10.20 P.M., and proceeded towards the spot where the light had been seen, but it suddenly disappeared. The Life-boat cruised about for a long time, but without finding any vessel, and at last anchored until daylight, when a vessel was seen about a mile to leeward, stranded and water-logged, with her crew in a boat hanging on to her. Just at that moment the boat was observed to leave the wreck and drift towards the sands. The Life-boat hastened towards her, and arrived just in time to rescue the six men on board. They had only one oar in the boat, and were in such a thoroughly exhausted condition that it was considered advisable to get them ashore as quickly as possible, and the Life-boat therefore ran for Hunstanton, where they were safely landed.—Expense of service, 44*l.* 2*s.* 9*d.*

Oct. 16.—FILEY.—*Hollon the Second* Life-boat.—At noon the Norwegian barquentine *Maria Berner*, bound from Gefle for Hartlepool with pit props, ran into Filey Bay for shelter, a strong gale blowing from N.N.E. at the time, with a very heavy sea. She had a flag flying three-quarter mast high, and appeared to be in want of assistance. The Life-boat, therefore, put off to her and found that the master and crew wished to land, intending to return to their ship when the weather moderated. Four men got into the Life-boat and three others into another boat and were taken ashore, leaving the vessel riding with three anchors down. The crew afterwards were taken back by a shore-boat, and at 11.15 burnt a flare for assistance. The crew of the Life-boat

were summoned; the boat again proceeded to her and found that one of her cables had parted, and that she was leaking. Her crew, being desirous of leaving the vessel, were taken into the Life-boat and were once more landed at 1 A.M.—Expenses of services, 43*l.* 17*s.*

Oct. 19.—PADSTOW.—*Arab* Life-boat.—A lugger was seen to anchor on the back of the Doom bar. A moderate gale from N.E. was blowing at the time, and there was a rough sea. While the vessel was being watched her chain parted and she drifted across the channel and grounded on the rocks inside Stepper Point. The Life-boat crew were at once summoned, and at 7.30 P.M. the Life-boat was on her way to the vessel. She proceeded alongside and found her firmly fixed by the bow on the rocks, and her crew declined to leave her. As she was evidently in a perilous position, the Life-boat remained by her, and about half an hour after midnight, when the tide flowed, she filled; her crew of seven men then took to the Life-boat and were brought safely ashore. The vessel was the *Jules Noemi*, of and from Redon for Cardiff, laden with pit wood.—Expense of service, 23*l.* 11*s.*

Oct. 19–20.—EYEMOUTH.—*James and Rachel Grindlay* Life-boat.—While several fishing-boats were at sea a heavy ground swell was breaking in the bay and it was feared that some casualty might befall the boats when they came in. The Life-boat therefore was launched, and remained in readiness for any emergency.—Expense of services, 7*l.*

Oct. 20.—WEXFORD.—*Andrew Pickard* Life-boat.—Signals of distress having been shown by the fishing-lugger *Ocean Pearl*, the Life-boat was launched at 6.15 P.M., and on nearing the vessel met her punt, containing the crew of seven men and a passenger. They were taken into the Life-boat, which then, at the request of the master, proceeded to the vessel, which was stranded on the Dogger Bank. She was full of water, heavy seas were breaking over her, and it was impossible to save her.—Expense of service, 22*l.* 17*s.*

Oct. 23.—RAMSGATE.—*Bradford* Life-boat.—At 3.45 A.M. the Life-boat, in tow of the steam-tug *Aid*, left the harbour in response to signals from the Gull and Goodwin Light-vessels, and found the

schooner *Dorothy Watson*, of Shields, coal laden from Hull for Portsmouth, stranded on the N.E. Goodwin sands. The Life-boat men boarded her, and when the tide flowed the tug backed in, her steel hawser was passed on board, and, after towing for about an hour, the vessel was got afloat and was taken into Ramsgate harbour, the pumps being kept continually at work during the journey, as she was leaking badly.—Property salvage case.

Oct. 26.—BUDĒ.—*Elizabeth Moore Garden* Life-boat.—The brigantine *Thyra*, of Rönne, showing signals of distress, while a moderate gale was blowing from N.N.W., with a heavy sea, the Life-boat was launched at about 7.45 A.M., succeeded in taking off her crew of nine men, and landed them at Boscastle. Five of the men, when the weather moderated a little, went back to the vessel, fearing a passing steamer might take possession of the derelict. She, however, drifted on the rocks, and ultimately became a total wreck, the five men being once more brought ashore by the Life-boat.—Expense of service, 32*l.* 2*s.* 6*d.*

Oct. 30.—ST. ANDREWS.—*Louisa* Life-boat.—A number of fishing-boats were returning to the harbour in the evening while a N. wind was blowing and a heavy sea was breaking. Several of the boats entered safely, but one of them was struck by a sea and narrowly escaped foundering. Four boats remained outside, two of which ran for the Firth of Forth, the other two signalling for assistance. At 7.15 the Life-boat was launched, taking out a rope about two hundred fathoms in length, one end being held by men on the quay, and by this means the boats were hauled safely into the harbour.—Expense of service, 11*l.* 3*s.*

Nov. 7.—MORLFRE.—*Star of Hope* Life-boat.—The schooner *Waterbird*, of Liverpool, signalled for assistance whilst lying in the roadstead, a gale from N.E. having suddenly sprung up, accompanied by a very heavy sea. At 10 P.M. the Life-boat was launched, proceeded to the vessel, and landed her crew, consisting of five men, as there was imminent risk of the vessel dragging her anchors and going on the rocks.—Expense of service, 26*l.* 19*s.*

Nov. 7.—CAISTER, NORFOLK, and GORLESTON, SUFFOLK.—*Beauchamp* and *Mark Lane* Life-boats.—In the afternoon,

during hazy weather, signal guns were heard from the St. Nicholas Lightship off the coast of Norfolk, in response to which the Gorleston Life-boat was launched and proceeded to the Lightship, when it was ascertained that guns had been heard to the eastward. At once the Life-boat was taken in that direction, and proceeding over the Scroby Sands she found on the outside of the Sand a full-rigged ship, named the *Soudan*, of Liverpool, 1659 tons, bound from Leith to Rio de Janeiro with a cargo of coal, and having a crew of twenty-seven men and a pilot on board. By request of the master the Life-boat returned for the assistance of steam-tugs, and every effort without effect was made to save the ship. The weather then got much worse, the wind ultimately increasing to a whole gale, accompanied by a very heavy sea, and at 6.45 on the morning of the 8th November nineteen of the ship's crew were taken into the Life-boat along with eight of her own crew who had gone on board to help in throwing cargo overboard so as to lighten the vessel; the captain had previously gone ashore to consult with Lloyd's agent as to the steps to be taken to try to save the ship. The Life-boat then remained at anchor close by for a time, after which she again bore down on the wreck and endeavoured to take off the remaining eight men, but could not manage it, as every rope broke, owing to the severity of the gale. Fortunately the Caister No. 2 Life-boat, the *Beauchamp*, had been launched in reply to signals a few hours previously after very hard work, some of the heaviest seas ever remembered being shipped, which thoroughly drenched the men, who experienced similar treatment in crossing the Barber Sands. They found that the only way to fetch the wreck was through half-a-mile of heavy broken water on the Scroby Sands, through which they proceeded, all hands lashing themselves in the boat. They arrived there about 7 o'clock, and the *Mark Lane* Life-boat, which was there waiting at anchor a little way from the wreck, sailed for harbour, her coxswain and crew having by that time been afloat in the boat for about nineteen hours.

With the help of a steam-tug and the use of her own sails the Caister Life-boat after some time was enabled to approach

the wreck, but could not get alongside, the heavy seas knocking her away time after time, until lines had been passed to her by the aid of Life-buoys thrown from the ship. The crew were then enabled to haul her up to the stern, when she was swept under the lee quarter amongst the wreckage and the eight men jumped into her amidships. Having accomplished her mission the Life-boat made for harbour under sail and safely landed the rescued men at Gorleston. The latter part of this service taking place in daylight, thousands of persons watched it from the beach at Great Yarmouth, and as the boat made the harbour both piers were thronged with spectators, who cheered lustily. Thanks to the determined and brave efforts of the Life-boat men, the loss of this vessel was happily unattended by any loss of life. A relative of one of those saved by the *Mark Lane* Life-boat voluntarily forwarded the crew of that boat 5*l.* "as a small recognition of gallant services, with heartfelt thanks."—Expenses of service, 10*l.* 13*s.*

Nov. 8.—SEATON CAREW.—*John Lawson* Life-boat.—The galliot *Dina*, of and from Gröningen, bound for Stockton-on-Tees, laden with oats, stranded on the Slag Bank at the mouth of the Tees in a N.E. gale and a strong sea. The Life-boat was launched at about 10.30 A.M., and with considerable difficulty and risk, owing to the high seas and the shallowness of the water, the boat grounding twice, reached the vessel and rescued the master, his wife and child, and the crew of three men. The vessel became a total wreck.—Expense of service, 20*l.*

Nov. 8.—CLACTON.—*Albert Edward* Life-boat.—The barquentine *Golgotha*, of Riga, laden with bricks and coal from Grangemouth for Barbadoes, was seen to strand on the West Gunfleet Sands, and she showed signals of distress. The Life-boat was launched at 5 P.M. in a heavy sea, the wind blowing a strong gale from N.E., and on reaching the vessel found her bumping heavily. The Life-boat men boarded the vessel, part of the cargo was jettisoned, and at high-water the vessel was got afloat, and was taken into Queenborough Swale. She had a crew of ten men.—Property salvage case.

Nov. 9.—NEW BRIGHTON.—*Duke of Northumberland* Steam Life-boat.—The Life-boat was called out at night by a

telephone message from the Chief Officer of H.M. Coastguard at Waterloo, stating that a vessel was making signals of distress on Crosby Beach. On arriving there it was found that the brigantine *Emma Ives*, of Dublin, had stranded, and that the captain wanted the assistance of a pilot and a steam-tug. The Life-boat remained in attendance until the vessel was taken in tow by a steamer, after which she returned to her station.—Expense of service, 14l. 1s.

COMMITTEE MEETING, 12th Nov., 1896.

Voted 987l. 8s. to defray the expenses of assembling the crews or launching the following Life-boats with a view of helping the crews of vessels in distress:—Aranmore, Berwick-on-Tweed, Brancaster, Broadstairs, Brighton, Bude, Caister, Carnsore, Castletown, Chapel, Clacton, Clovelly, Eyemouth, Filey, Formby, Girvan, Gorleston, Great Yarmouth, Holyhead, Hope Cove, Hoylake, Hunstanton, Hythe, Kessingland, Kingsdowne, Llandudno, Lowestoft, Margate, Maryport, New Brighton, North Deal, Plymouth, Point of Ayr, Port Isaac, Pwllheli, Rosslrae, Sheringham, Skegness, Thorpe, Walmer, Wells, Whithorn, Winterton and Youghal.

The Ramsgate Life-boat was also called out.—Expenses paid by the Board of Trade.

Voted 200l. towards the local subscription for the benefit of the widow and two young children of E. YOUNG, one of the crew of the Walmer Life-boat, who when the boat was alongside the s.s. *Trapani*, of Hamburg, which stranded on the Goodwin Sands on the 23rd October, took off his life-belt and climbed up a rope with the view of boarding the vessel, but his strength failing him he fell into the sea, and notwithstanding all the efforts made to save him, was drowned, although a good swimmer.

Also 21l. 1s. to men injured at Tramore, Port Isaac, Workington, Margate, Lynmouth and Llandudno.

The Committee recognised the past good services of Mr. O. H. PARRY, Mr. T. EVANS, and Mr. W. COLLISTER as Coxswains of the Cemaes, Rhyl and Port Erin Life-boats, and the services of Mr. EDWARD HAMSON, Second Coxswain of the Exmouth Life-boat.

Nov. 14.—HOLYHEAD.—*Thomas Fielden* Life-boat.—The Life-boat was launched while a strong S.S.W. gale was blowing, with a very heavy sea, and on reaching the schooner *Thomas*, of and from Liverpool, for Nevin, she was in tow of a steam-tug, but the crew of three men were in a thoroughly exhausted condition. Some of the Life-boat men boarded the vessel, which had lost her main-mast, and by working hard at the pumps, the water being then up to the cabin seats, managed to keep her afloat until she was towed into harbour.—Expense of service, 13l. 17s. 6d.

Nov. 14.—ABERSOCH.—*Oldham* Life-boat.—The Life-boat was launched to a barque in the offing of St. Tudwell's Roads, flying signals for assistance. A moderate gale was blowing from S., and there was a choppy sea. The vessel was the *Amalia*, of Gothenburg, timber laden from Halifax for Pwllheli, and the master requested the Life-boat men to remain by. At 3 p.m. both her cables parted, sails were then set, and she was beached at the entrance of Pwllheli Harbour.—Property salvage case.

Nov. 16.—WHITBY.—*John Fielden* Life-boat.—The Life-boat proceeded out to the bar and remained there until the fishing-cobles, which had been overtaken by stormy weather, were all got safely into harbour.—Expense of service, 15l. 3s.

Nov. 26.—BRIXHAM.—*Betsy Newbon* Life-boat.—The Life-boat was launched at 10 a.m., and remained in attendance on fishermen who were engaged in getting their boats into safety, a gale of wind having sprung up from E.S.E. with a rough sea.—Expense of service, 12l. 5s.

Nov. 28.—SWANSEA.—*Wolverhampton* Life-boat.—The Life-boat was launched at 10 a.m. and proceeded to the assistance of the fishing-skiff *Jane*, of Swansea, which had parted from her anchors near the Mumbles Head, and was drifting towards a lee shore in a strong E. gale and a heavy sea. Only one man was on board, and he was taken into the Life-boat before his boat stranded and brought safely ashore.—Expense of service, 12l. 3s.

Nov. 29.—ST. AGNES.—*James and Caroline* Life-boat.—The schooner *Ocean Belle* having been observed dimasted and driving helplessly before a strong S.E. gale, accompanied by a very heavy sea, the Life-boat was launched at 10.20 a.m.,

and rescued her crew, consisting of three men.—Expense of service, 12*l.* 15*s.*

Nov. 29.—GREAT YARMOUTH.—*John Burch* Life-boat.—The s.s. *Ardle*, of and for Dundee, from London, in ballast, stranded about 600 yards N. of the Britannia pier in a moderate E. gale and a heavy sea. The Life-boat was launched at 10.30 A.M. and went alongside the vessel. The rocket apparatus simultaneously obtained communication and landed the mate, but owing to the presence of the Life-boat the remainder of the crew stayed on board, and the steamer being light drove a considerable way up the beach. The Life-boat succeeded in getting a wire hawser fast to H.M.S. *Onyx*, but owing to the heavy sea it was impossible to get the vessel off, and the Life-boat therefore stayed by her during the night, and afterwards remained in attendance on those engaged in salving the vessel.—Property salvage case.

Dec. 1.—HOPE COVE.—*Alexandra* Life-boat.—The three-masted steamer *Blesk*, of and from Odessa, bound for Hamburg, laden with petroleum, stranded on the Greystone Rock, about a mile S.E. of Bolt Tail, in extremely dark and thick weather. Guns and rockets having been fired, the Life-boat *Alexandra* was launched at 6.45 P.M. and found the steamer aground under the cliffs, which are between two hundred and three hundred feet high. She had gone ashore with a tremendous crash and, it being impossible to get her off, her crew of forty-three persons were taken into the Life-boat and safely brought ashore in two trips. The *Alexandra* is one of two Life-boats presented to the Institution by the United Grand Lodge of Freemasons of England in commemoration of the safe return from India of the Most Worshipful Grand Master, H.R.H. the Prince of Wales.—Expense of service, 33*l.* 14*s.* 6*d.*

Dec. 4.—ROKER.—*William Hedley* Life-boat.—The Life-boat was launched at 10 A.M. and carried lines from steam-tugs to the stranded s.s. *Hawk*, of Hull, and remained in attendance until the vessel had been towed afloat.—Property salvage case.—Balance of expenses, 6*l.* 14*s.*

Dec. 4.—WALTON-ON-THE-NAZE.—*Honourable Artillery Company* Life-boat.—A message by telephone having been received from the Gunfleet Lighthouse, reporting a vessel ashore on the sand, the

Life-boat was launched at 0.40 A.M., and on her way to the vessel fell in with the s.s. *Westwood*, of Hull, which kindly gave her a tow, casting her off about three miles W. of the Gunfleet Light. The stranded vessel was ascertained to be the brigantine *Lord Strangford*, of Guernsey, laden with scrap iron. The Life-boat men boarded the vessel, assisted at the pumps, and, with the help of the steam-tug *Merrimac*, she was got afloat and was taken into Harwich harbour.—Property salvage case.

Dec. 4.—ST. IVES.—*Exeter* Life-boat.—While a heavy S.E. gale was blowing, with a rough sea, signals of distress were shown by the ketch *Askelon*, of Jersey, which had entered the bay for shelter on the previous day. She was dragging her anchors, and as she had drifted to within two hundred yards of a reef of rocks, her crew got into the Life-boat and were landed in the harbour. The gale afterwards moderating, the men went back to their vessel and, with the help of some of the Life-boat's crew, got her into a safe anchorage.—Expense of service, 13*l.* 3*s.*

Dec. 4.—ABERSOCH.—*Oldham* Life-boat.—The ketch *Progress*, of Aberystwyth, bound from Portmadoc for Dublin, showed signals of distress while at anchor in St. Tudwell's Roads. On reaching the vessel the Life-boat found that she was dragging her anchor, and her crew were anxious to leave her as there were indications of the weather becoming bad. They were landed, therefore, as a precautionary measure, and on the following day again went off to their vessel, the weather having improved.—Expense of service, 17*l.* 7*s.*

Dec. 4-6.—GORLESTON.—*Mark Lane* Life-boat.—At 6.45 P.M., Dec. 4, the Life-boat was launched in response to signals and was towed by a steam-tug to the steamer *Propitious*, of Sunderland, which had been damaged by collision in Yarmouth Roads, in a strong gale from E.S.E. and a heavy sea. The Life-boat was engaged until the morning of the 6th Dec. in remaining by the vessel and landing several men who had been employed on board to assist in lightening her of some of her cargo of coal and to work at the pumps. Assistance was also rendered to the steamer by the Gorleston volunteer Life-boat, *Elizabeth Simpson*, which took ashore others of the men

engaged on the ship.—Property salvage case.

Dec. 5.—WINCHELSEA.—*Frances Harris* Life-boat.—The Life-boat was launched at 5.30 A.M. in response to signals of distress, in a strong gale from S.W., a heavy sea and very thick weather, and rendered assistance to the s.s. *Menzaleh*, of London. With the help of a tug the vessel was taken to Dover.—Property salvage case.

Dec. 6.—WORTHING.—*Henry Harris* Life-boat.—A barque was reported ashore east of Lancing in the morning, when a strong gale was blowing from S.S.E., with a very heavy sea. The roadway to Lancing was impassable, part of it having been washed away, and it was therefore decided to launch the Life-boat at Worthing. This was accomplished at 8.30; sail was made, and on nearing the barque, the boat dropped her anchor and veered down to windward of her. It was impossible to go under her stern on account of the wreckage of the main and mizen masts, which had gone by the board. Communication, however, was established by lines, and the steward and mate were hauled through the surf into the Life-boat. The vessel was by that time within a hundred yards of the beach, and had driven away from the Life-boat, which three times got to windward of her and attempted to re-establish a communication in the broken water. The rocket apparatus having got to work, the remainder of the crew, eight in number, were rescued by that means, the Life-boat remaining as near as possible until the last man was landed. The Life-boat regained her station at 2.20 P.M. The stranded vessel was the *Ophir*, of Arendal, laden with salt from Sicily for Norway.—Expense of service, 28l. 5s. 6d.

Dec. 6-7.—APPLEDORE.—*Bessie Pearce* Life-boat.—The brigantine *Carrick*, of St. John, N.B., stranded at the back of Northam Burrows in a heavy gale from the N. The Life-boat was taken to the spot, but it was found unnecessary to launch her, as the vessel was so situated that her crew could be landed by ropes, and the Life-boat men and others rendered good service in assisting to get them ashore.—Expense of service, 26l. 12s. 6d.

Dec. 8.—PENZANCE.—*Elizabeth and Blanche* Life-boat.—During terrible weather the Life-boat was launched at about 7.45 P.M. and remained in the har-

bour in readiness to proceed if necessary to the aid of a vessel which had been reported in distress. While the boat was afloat she was the means of rescuing a man who fell from the quay into the water.—Expense of service, 31l. 14s.

Dec. 8.—PLYMOUTH.—*Escape* Life-boat.—The Life-boat rendered assistance to the brigantine *Elizabeth Jane*, of Fowey, which was found lying dangerously near a reef of rocks known as the Bridge while a strong gale was blowing from S. with a very heavy sea. The vessel slipped her anchor and was towed by a steam-tug into a safe position, the Life-boat assisting to pass lines from her to the tug, and helping to moor her in the Hamoaze.—Expense of service, 13l. 7s.

Dec. 9.—MABLETHORPE.—*Heywood* Life-boat.—A message by telephone was received stating that a vessel was stranded on the N. side of Saltfleet Haven; the Life-boat was launched at 8.50 A.M. and found the brigantine *Neptune*, of Helsingborg, aground inside the Rose Sand. At the request of the master, the Life-boat remained by the vessel until high water.—Expenses of service, 60l. 14s.

COMMITTEE MEETING, 10th Dec., 1896.

Voted 887l. 4s. 2d. to pay the expenses of assembling the crews or launching to the assistance of vessels in distress the following Life-boats:—Aldeburgh, Clacton, Donna Nook, Dover, Drogheda Nos. 1 and 2, Dunbar, Dungeness No. 1, Exmouth, Falmouth, Formby, Gorleston No. 1, Great Yarmouth, Harwich, Hasborough, Hoylake, Margate, New Romney, North Berwick, Palling Nos. 1 and 2, Peterhead, Roker, Runswick, St. Mary's, Scilly, Salcombe, Shoreham, Southend, Whitelink Bay and Winterton No. 2.

Also 52l. 4s. to men injured on service at Appledore, Caister, Peterhead, Flamborough and Shoreham.

The Committee recognised the long and good services of Mr. WILLIAM HOOKE and Mr. ALEXANDER DUTHIE, Coxswains of the Blakeney and Port Erroll Life-boats.

Dec. 11.—JOHNSHAVEN.—*Meanwell of Glenbervie* Life-boat.—While a moderate S.E. wind was blowing, with a heavy sea, the weather being thick with snow and the night intensely dark, the steam trawler *Pansy*, of North Shields, ran

aground on a reef of rocks two miles W. of Johnshaven. The Life-boat was launched at 3.30 A.M. and made for the vessel, but owing to the darkness and the dangerous position in which she was lying it was impossible to attempt to approach her until daylight. Even then the boat could not venture alongside, but threw her grappling iron on board, and by means of a line pulled the men through the water into the Life-boat. Eight men were thus rescued.—Expense of service, 23*l.* 6*s.*

Dec. 12.—LYNMOUTH.—*Louisa* Life-boat.—A heavy gale sprung up suddenly in the morning when three vessels were trying to get into the bay and harbour. One succeeded in entering. Another, the ketch *Elizabeth*, of Newport, had her sails blown away and was in danger of drifting on the sandbank, and it was feared she would founder. The Life-boat was launched at 10.10 and took off the vessel's crew of two men. Just as they had been rescued the mast of the third vessel, the ketch *Little Jane*, of Plymouth, went by the board, and the Life-boat at once proceeded to her assistance, and remained by her until a tug arrived to take her to Ilfracombe, the Life-boat accompanying her and regaining her station at 9.30 P.M. On the following morning it was ascertained that the *Elizabeth* was still afloat and had drifted about four miles to the eastward. The weather had moderated, but there was still a heavy ground sea, and therefore the Life-boat again went out to her and found she had three feet of water in her. Some sail was put on her and the Life-boat towed her to Minehead.—Expenses of services, 39*l.* 17*s.* 6*d.*

Dec. 14.—MARGATE.—*Quiver* No. 1 Life-boat.—Signals of distress having been reported, the Life-boat was launched at 5.15 A.M. and proceeded through a heavy E.S.E. gale to the Prince's Channel Light-vessel, and, from directions received, proceeded to search the sands in a W.S.W. direction. The search was continued until daylight, and then the mast-head of a sunken vessel was sighted in the Prince's Channel. The Life-boat men made for it, found two men lashed in the topmast trees, and with considerable difficulty the men, both of whom were in a greatly exhausted condition, were taken into the Life-boat. One of them was a

Deal pilot, and the other a member of the crew of the vessel, the schooner *Eva*, of Runcorn. It was ascertained from them that the vessel had stranded on the Tongue Sand at about 11 o'clock on the previous night, but no signal for assistance had been made until 4 o'clock in the morning, when the vessel got off but was found to be sinking. Three other members of the crew were washed off while endeavouring to take to the rigging.—Expense of service, 38*l.* 15*s.*

Dec. 14.—WORTHING.—*Henry Harris* Life-boat.—The schooner *Flora Emily*, bound from Montrose for Shoreham with potatoes, stranded about a mile W. of Worthing pier. The Life-boat was launched at 6.15 P.M. and found the vessel, which was burning tar barrels, bumping heavily. Her crew of five men were taken into the Life-boat and safely landed at 7.15 P.M.—Expense of service, 27*l.*

Dec. 15.—ST. MARY'S, SCILLY.—*Henry Dundas* Life-boat.—The Life-boat was launched at 10.5 A.M. and proceeded to the barque *Sophie*, of Frederikstadt, which was found to be dismasted and abandoned by her crew. Some boatmen had boarded her, and she was ultimately towed by a steam-tug to Tresco, the Life-boat remaining by her until she was in the harbour.—Expense of service, 12*l.*

Dec. 18.—STAITHES.—*Jonathan Stott* Life-boat.—Several of the cobbles which had gone out fishing at about 10 A.M. were overtaken by a gale which sprung up towards mid-day with a rough sea, thick weather and snow showers, and their return was rendered dangerous. The Life-boat was launched at 12 o'clock, and stayed by the bar until the boats had safely crossed.—Expense of service, 13*l.* 1*s.*

Dec. 31.—Voted 518*l.* 19*s.* to pay the expenses of the following Life-boats in assembling their crews, watching or putting off, their services however not being required:—Appledore No. 2, Burnham, Clovelly, Donna Nook, Dungeness No. 2, Filey, Fraserburgh, Hayle, Holyhead No. 1, Hoylake, Montrose No. 1, New Brighton (steam Life-boat), Newburgh, North Deal, Plymouth, Porthdinllasn, Robin Hood's Bay, Rye, St. Agnes, St. Ives and Walmer.

The Ramsgate Life-boat was also taken out.—Expenses paid by Board of Trade.

LIFE-BOAT SERVICES IN 1896.

Lives saved.		Lives saved.		Lives saved.
	<i>Adeline</i> , cutter, of Great Yarmouth	1	<i>Hilda</i> , cutter—remained in attendance.	
	<i>Agder</i> , barque, of Frederickstadt	4	Holy Island fishing-boats—rendered assistance.	
	<i>Aire</i> , schooner, of Goole	4	<i>Isabella</i> , lugger, of Wick	6
	<i>Albatross</i> , of Aberporth—landed 2.		<i>Jane</i> , skiff, of Swansea	1
	<i>Albert</i> , steam-tug, of Chester—rendered assistance to crew.		<i>Janet</i> , schooner, of Carnarvon—rendered assistance.	
	<i>Albert T. Young</i> , barquentine, of Faversham—landed 6 men and remained by vessel.		<i>John Gibson</i> , schooner, of Fleetwood—landed 4.	
	<i>Amalia</i> , barque, of Gothenburg—rendered assistance.		<i>Jolly Tar</i> , dandy, of Lowestoft ...	5
	<i>Anne and Betsy</i> , of Aberporth—landed 2.		<i>Jules Noimi</i> , lugger, of Redon ...	7
	<i>Annie</i> , yawl, of Wexford—rendered assistance.		<i>Kate</i> , schooner, of Peel—rendered assistance.	
	Arbroath fishing-boats—stood by boats.		<i>Kate Mudd</i> , ketch—stood by vessel.	
	<i>Ardie</i> , s.s., of Dundee—remained by vessel.		<i>Kelpie</i> , brigantine, of South Shields	7
	<i>Askelon</i> , ketch, of Jersey—landed 3.		<i>Ker Plant</i> , schooner, of Padstow—landed 8.	
	<i>Atalanta</i> , cutter—landed crew (3) and took vessel into harbour.		<i>Laddie</i> , schooner, of St. John's, N.F.—landed 7.	
	<i>Banklands</i> , barque, of Liverpool—landed 3 passengers.		<i>Lady Gray</i> , s.s., of West Hartlepool—assisted to save vessel.	
	Berwick-on-Tweed fishing-boats—rendered assistance.		<i>Lake Patas</i> , schooner, of Barrow—landed 5.	
	<i>Blesk</i> , steamer, of Odessa	43	<i>Laurel</i> , cutter—remained in attendance.	
	<i>Brothers</i> , brigantine, of Drogheda ..	5	<i>Liana</i> , barquentine—rendered assistance.	
	<i>Catharine</i> , flat, of Liverpool.....	2	<i>Liffey</i> , steamer, of London—stood by vessel.	
	<i>Chanticleer</i> , dandy, of Lowestoft—assisted to save vessel.		<i>Lionel</i> , fishing-coble—stood by boat.	
	<i>Christiana</i> , smack, of Cardigan... ..	2	<i>Little Jane</i> , ketch, of Plymouth—rendered assistance.	
	<i>Clara</i> , ketch, of Milford—assisted to save vessel and.....	3	<i>Lizzie</i> , schooner, of Chester—landed 5.	
	Cullercoats fishing-cobles—rendered assistance.		<i>Lord Strangford</i> , brigantine, of Guernsey—assisted to save vessel and	7
	<i>Dina</i> , galliot, of Groningen	6	<i>Lucifra</i> , cutter, of Douglas	1
	<i>Dorothy Watson</i> , schooner, of Shields—rendered assistance.		<i>Macmillan</i> , ship, of Glasgow—assisted to save vessel.	
	<i>Dundee</i> , steamer, of Glasgow.....	4	<i>Marchal Suchet</i> , ship, of London—stood by vessel.	
	<i>Eglinton</i> , steamer, of Glasgow—rendered assistance.		<i>Margaret</i> , schooner, of Wexford—landed 3.	
	<i>Eliza and Alice</i> , ketch, of Goole—stood by vessel.		<i>Maria Berner</i> , barquentine—landed 10.	
	<i>Elizabeth</i> , ketch, of Newport—assisted to save vessel and	2	<i>Maria Louise</i> , brigantine—stood by vessel.	
	<i>Elizabeth Jane</i> , brigantine, of Fowey—rendered assistance.		<i>Mary</i> , smack, of Lynmouth—rendered assistance.	
	<i>Ellington</i> , s.s., of Newcastle—rendered assistance.		<i>Mary Ann</i> , coble, of Whitby—stood by boat.	
	<i>Emma Ines</i> , brigantine, of Dublin—stood by vessel.		<i>Menzah</i> , s.s., of London—rendered assistance.	
	<i>Endeavour</i> , dandy, of Lowestoft—landed 4.		<i>Jersey</i> , schooner, of Dublin	3
	<i>Fva</i> , schooner, of Runcorn	2	<i>Minda</i> , barque, of Farund	11
	Eyemouth fishing-boats—stood by boats.		Montrose fishing-boat—stood by vessel.	
	Flamborough fishing-cobles—rendered assistance.		<i>Muse</i> , schooner, of Cardigan—landed 6.	
	<i>Flamingo</i> , brig, of Far-und—assisted to save vessel and	8	<i>Mystery</i> , lugger, of Lowestoft—saved vessel and	5
	<i>Flora Emily</i> , schooner, of Burshead	5	<i>Neptune</i> , brigantine, of Helsingborg—remained by vessel.	
	<i>Flying Falcon</i> , steamer, of Liverpool—landed 76 passengers.		Newbiggin fishing-cobles—stood by boats.	
	<i>Friends</i> , coble, of Robin Hood's Bay—stood by boat.		<i>Noble</i> , schooner, of Banff—assisted to save vessel.	
	<i>Giovanni</i> , barque, of Lillesand ...	13	North Sunderland fishing-boats—remained in attendance.	
	<i>Glenberrie</i> , barque, of Glasgow—rendered assistance.		<i>Ocean Belle</i> , sch., of Beaumaris... ..	3
	<i>Golgotha</i> , barquentine, of Riga—saved vessel and	10	<i>Ocean Pearl</i> , fishing-lugger	8
	<i>Governor Ready</i> , smack, of Douglas—saved vessel and	3	<i>Ophir</i> , barque, of Arendal	2
	<i>Grace Darling</i> , cutter, of Ramsey ..	3	<i>Palme</i> , barque	5
	<i>Hadassah</i> , trawler, of Aberystwyth—saved vessel.		<i>Pansu</i> , steam-trawler, of North Shields	8
	<i>Harriet</i> , fishing-smack, of Marsh Side—saved vessel and	4	Penzance—a man who fell from the quay	1
	<i>Havok</i> , s.s., of Hull—rendered assistance.		<i>Polly</i> , pilot cutter, of Barry—saved vessel and.....	2
			Port Erin fishing-boats—rendered assistance.	
			<i>Prairie Flower</i> , fishing-smack—saved vessel and	1
			<i>Prince Consort</i> , brig, of Faversham—rendered assistance.	
			<i>Progress</i> , ketch, of Aberystwyth—landed 3.	
			<i>Propitious</i> , steamer, of Sunderland—remained by vessel and landed 47 men.	
			Redcar fishing-cobles—rendered assistance.	
			<i>Reform</i> , schooner, of Stavanger... ..	9
			<i>Regina</i> , schooner, of Jersey	4
			<i>Rival</i> , brigantine, of Belfast—landed 6.	
			<i>Rival</i> , ketch, of Rye	2
			<i>Rosstrevor</i> , steamer, of Dublin—landed 17 passengers.	
			<i>Ruby</i> , barge, of London—saved vessel and	4
			Runswick fishing-boats—stood by boats.	
			<i>Sage</i> , ketch, of Carnarvon—landed 3.	
			<i>Samuel Dixon</i> , schooner, of Wexford—landed 4.	
			Scarborough fishing-cobles—rendered assistance.	
			<i>Scotia</i> , schooner, of Inverness—stood by vessel.	
			<i>Secret</i> , fishing-coble, of Whitby... ..	4
			<i>Sefton</i> , flat, of Liverpool.....	4
			<i>Silver King</i> , dandy, of Hull	6
			<i>Sophie</i> , barque, of Frederickstadt—remained by vessel.	
			<i>Soudan</i> , ship, of Liverpool.....	35
			Southend pier extension works ...	7
			St. Andrew's fishing-boat—stood by boats.	
			Staitbes fishing-cobles—stood by boats.	
			<i>Star of Peace</i> , coble, of Whitby—stood by boat.	
			<i>Sussex Belle</i> , ketch, of London—saved vessel and	6
			<i>Templer</i> , ketch, of Hull—landed 3.	
			<i>Thomas</i> , schooner, of Liverpool—assisted to save vessel and	3
			<i>Thyra</i> , brigantine, of Rönne	9
			<i>Tom Henry</i> , schooner, of Kirkwall ..	5
			<i>Topaz</i> , smack, of Milford—landed 3.	
			<i>Waree</i> , brigantine, of Dundalk ...	4
			<i>Waterbird</i> , schooner, of Liverpool—landed 5.	
			Whitby fishing-boats—rendered assistance.	
			<i>William and Henry</i> , schooner, of Wicklow—saved vessel and ...	3
			<i>W. S. Scott</i> , ketch, of Newport—landed 4.	
			<i>Young Jane</i> , coble, of Cullercoats—stood by vessel.	
			Total lives saved by Life-boats in 1896, in addition to saving 20 vessels and rendering aid, and standing by many other distressed Ships and Boats.....	312
			During the same period the Institution granted rewards for saving lives by fishing and other boats	149
			Total Number saved in 1896 by Life-boats and other means	461

SHORE-BOAT SERVICES REWARDED BY THE ROYAL NATIONAL
LIFE-BOAT INSTITUTION IN 1896.

Jan. 9.—Voted 4*l.* to four fishermen for putting off in a boat and saving four men whose boat had been capsized while returning to their vessel, the *Baron Hill*, of Liverpool, which was lying off Exmouth, in a strong W. gale on the 4th December.

Also thanks to the master of the steam trawler *Flying Sylph*, and 1*l.* each to two of his crew for saving two of the crew of the fishing coble *Mary and Alice*, of Scarborough, which was swamped in a sudden heavy gale when about two miles distant from Scarborough on the 15th November. The master of the steamer skilfully manœuvred the vessel, and a boat manned by the second hand and the cook put off and rescued the men.

Also 1*l.* 10*s.* to three men for putting off in a boat and saving four men whose boat had been capsized by a squall off the island of Graemsay, Orkney, on the 3rd September.

Jan. 23.—Ten men saved the crew of seven men of the fishing-boat *Morning Light*, which was capsized in Broad Bay, Island of Lewis, in a moderate gale from S.W. by S. and a rough sea.—Reward, 3*l.* 15*s.*

Feb. 4.—Four men saved four men from a fishing-boat which had been capsized about a mile from the shore at Youghal, co. Cork.—Reward, 3*l.*

Feb. 9.—Three men put off in a boat and rescued one of two men whose boat had been upset off Gribbon Head, Cornwall, in a sudden squall.—Reward, 2*l.* 10*s.*

1*l.* was awarded to a fisherman who witnessed the casualty and injured a blood-vessel in hurrying to Polkerris to report the occurrence.

Feb. 13.—Voted the silver medal of the Institution and 2*l.* to Mr. JAMES JAMIESON, and 2*l.* each to three other men, for saving, at great risk, two of the crew of the fishing-boat *Jessie*, of Lerwick, which, while returning from fishing in a strong S. gale, was overwhelmed by a heavy sea and sunk about half a mile from Oxna Island, Shetland, on the 14th December last. A third occupant of the boat unhappily perished before help could reach him.

Also a binocular glass to Capt. W. R. Goff, and 1*l.* each to the crew of ten men, of the steam-tug *Knight of the Cross*, of Liverpool, for rescuing the crew of the barque *Lady Penrhyn*, of Liverpool, which parted her hawser while in tow off Stornaway, in a whole gale from S.S.W. and a very heavy sea, on the 12th December last. The crew of twelve men left in the ship's boat, and the master of the tug seeing that, with the terrific sea then running, they had very little chance of safely reaching the land, placed his vessel in a position to shelter the boat and, at considerable risk, took them on board the steamer.

Also 1*l.* 10*s.* to two men for saving four of the crew of the *Citizen*, of Youghal, which was wrecked on Saltee Island, off Wexford, on the 23rd December last.

Also 1*l.* 10*s.* to six men for putting off in a boat and rendering assistance to a fishing-boat which was in distress off Aldeburgh, Suffolk, in a moderate W.N.W. gale and a rough sea, on the 7th December last.

March 6.—Four men saved a man from a boat which had been capsized off Wareham, Dorset, in a moderate gale and a rough sea. Two other occupants of the boat unhappily were drowned before the salvors could reach them.—Reward, 2*l.*

March 6.—Nine men saved a fishing-boat, with a crew of seven men, which had been rendered unmanageable, having shipped heavy seas in Broad Bay, Ross-shire, in a strong W. gale.—Reward, 9*l.* and a letter of commendation.

March 10.—Two men saved one of the crew of the brigantine *N. C. Bull*, of Newhaven, who had fallen from the rigging of the vessel while leaving her port in a moderate S.E. wind and a smooth sea.—Reward, 15*s.*

April 16.—Ten men put off in a boat, and saved the crew of four men from a coble which had been suddenly filled with water off Sunderland Point.—Reward, 2*l.* 5*s.*

A reward of 10*s.* was also given to a woman who first observed the accident and gave an alarm.

May 14.—Voted 5*l.* to five men for conveying safely ashore the crew of the schooner *Jolle*, of Christiania, which stranded at Scockness Holm, Orkney, in a heavy sea on the 6th December last.

June 11.—Voted the thanks of the Institution, inscribed on vellum and framed, and the sum of 2*l.* each, to EDWARD T. HODGKINSON, JOHN HODGKINSON, JOHN COLE, WILLIAM ROBINSON and WILLIAM LAZENBY, for putting off in a boat and, with considerable difficulty and risk, saving two of six persons from a boat which had been filled by heavy seas off Skinningrove, Yorkshire, on the 20th February.

10*s.* was also granted to the owner of the boat used on the occasion.

June 23.—Three men landed two persons from a small boat which had been blown away from the shore at Southend, Essex, in squally weather.—Reward, 1*l.* 10*s.*

July 26.—The Institution's stage-boat at New Brighton was manned and saved four men from the cutter *Gladdies*, of Liverpool, in a moderate S. gale, squally weather and a rough sea.—Reward, 9*l.* 4*s.*

July 27.—Two men proceeded in a small sailing-boat to the assistance of the trawler *Willie*, of Tenby, which stranded on the Mixen Sands. Fifteen persons who were viewing the Swansea Regatta were taken off the vessel and safely landed.—Reward, 2*l.*

The sum of 1*l.* 5*s.* was also granted to defray the cost of repairing the boat, belonging to one of the salvors, which was damaged while rendering the service.

Aug. 15.—Four men, on the occasion of the Howth Regatta, saved two men belonging to the yacht *Coressa*.—Reward, 1*l.*

Aug. 17.—Three men put off from Deal in two boats and saved a lady and gentleman from a skiff which had been capsized in a rough sea.—Reward, 1l. 10s.

Sept. 10.—Voted the thanks of the Institution inscribed on vellum (framed) and 2l. each to JOHN LITIGO, Bowman of the Seaton Carew Life-boat, and his sons WILLIAM and JAMES, who are also members of the Life-boat crew, in acknowledgment of their services in putting off in a boat and, at considerable risk, saving two men whose boat had been capsized off the Tees, in a very heavy sea, on the 17th August.

Sept. 15.—Two men rescued two other men whose boat had been upset between Rathmullan and Inch Fort, on the Irish coast, in a strong S.W. wind and rough sea.—Reward, 1l.

Sept. 18.—The Volunteer Life-boat *True to the Core*, at Walton-on-the-Naze, saved the crew of six men from the barquentine *Sunderland Packet*, of Gravesend, which had stranded on the Gunfleet Sands in a strong W.S.W. wind and rough sea.—Reward, 10l.

Sept. 25.—Mr. JOHN JONES, coxswain of the Porthdinllaen Life-boat, and five other men saved by means of lines the crew of one man and a boy from the smack *Venture*, of Carnarvon, which parted her cable and drove ashore at Porthdinllaen in a N.N.W. gale and a very heavy sea.—Reward, 3l.

Oct. 7.—Nine men put off in two boats and rescued two men from another boat which had been capsized off Warrenpoint, on the coast of Ireland, in a strong S.E. gale and a rough sea.—Reward, 4l. 10s.

Oct. 7.—Six Tenby men put off twice in a boat and rescued the crew of three men from the fishing-boat *Grace Darling*, and another man who had been at work on the new pier and was in danger in his boat, a fresh gale from the S.W. having sprung up accompanied by a very heavy sea.—Reward, 6l.

Oct. 8.—Voted the thanks of the Institution inscribed on vellum to Captain JOSHUA ARMITAGE, and 1l. 10s. each to five other men for their good services in launching a punt, and with much difficulty rescuing the crew of three men from the flat *Catharine*, of Liverpool, which had been swamped in a strong north-westerly gale and a rough sea on the 23rd September.

Oct. 8.—Mr. JOHN JONES, coxswain of the Porthdinllaen Life-boat, and four other men rescued the crew of three men from the flat *Caldwell*, of Liverpool, which had sunk on the rocks at Porthdinllaen in a W.S.W. gale and a very heavy sea. They also brought a man ashore from the smack *Messenger*.—Reward, 3l. 15s.

Oct. 9.—Five Filey fishermen went out in a shore-boat and saved three men from the coble *Anne*, of that place, which was in a perilous position off Filey Brigg in a strong wind and a rough sea.—Reward, 2l. 10s.

Oct. 9.—Three men, on observing that a boat had been capsized off Donaghadee, Ireland, during a strong gale and a rough sea,

at once proceeded out in a boat and were successful in saving a man who had been thrown out of the boat.—Reward, 1l. 15s.

Mr. THOMAS QUICK, coxswain of the St. Ives Life-boat, and six other men, put off in a shore-boat and searched for a boat which had been reported by telephone as drifting off Portreath.

The coxswain of the Hayle Life-boat and the crew of a steam-tug also conducted a search for the same boat.—Rewards, 6l. 10s.

Oct. 29.—The two coxswains of the Crail Life-boat and five other men put off in a boat and saved the crew of two men of the sunken pilot yawl *Mary Thompson*, of Newhaven, in a strong N.E. wind and a moderate sea.—Reward, 4l.

Nov. 7.—The crew of the private Life-boat at Sheringham, Norfolk, rescued fourteen men from the stranded s.s. *Commodore*, of Newcastle, in a moderate gale from the N.N.E. and a rough sea.—Reward, 10l.

Nov. 12.—Voted the Silver Medal of the Institution and a copy of the vote inscribed on vellum and framed to Capt. JOHN MORGAN, master of the Cardiff pilot boat *Cardiffian*, and 2l. each to his two assistants and an apprentice for launching the punt belonging to their cutter during a gale of wind on the 6th October, and at much risk saving the crews, numbering six men, from two barges which they had previously attempted to tow into port, they having been separated from the steamer which had been engaged to take them to Spain.

Also the Silver Medal and vote on vellum and 1l. to JAMES MCBAY, the thanks of the Institution inscribed on vellum, and 1l. to his father, EDWARD MCBAY, Master of the fishing lugger *Friendship* of Johnshaven, and coxswain of the Johnshaven Life-boat, and 1l. each to the remainder of the crew of the lugger for their services in connection with the rescue of the crew of three men from another fishing-boat, named the *Speedwell*, which had been swamped at the mouth of Loch Nevis in a southerly gale and a rough sea on the 26th September. While one man was being got on board the other two men in the water drifted away, whereupon JAMES MCBAY, with his father's permission, tied a line round his waist, swam a distance of fifty yards to one of the men, who was quite exhausted and on the point of sinking, and took him to the lugger, after which he swam to the third man, and was fortunately enabled to save him in the same way.

Nov. 14.—The crew of the yawl *Paragon*, of Winterton, saved the crew of six men from the schooner *Florence*, of Plymouth, which was totally wrecked on the Cross Sand off the coast of Norfolk during a gale from the S.E. and a heavy sea.—Reward, 9l.

Nov. 16.—Three men put off in a small boat from a barque and rescued the coxswain of the St. Anne's Life-boat, who, while fishing with his son, had been pulled overboard as he was shooting his net off Lytham, Lancashire.—Reward, 15s.

THE
MEDAL OF THE ROYAL NATIONAL LIFE-BOAT INSTITUTION,
 FOR THE PRESERVATION OF LIFE FROM SHIPWRECK.

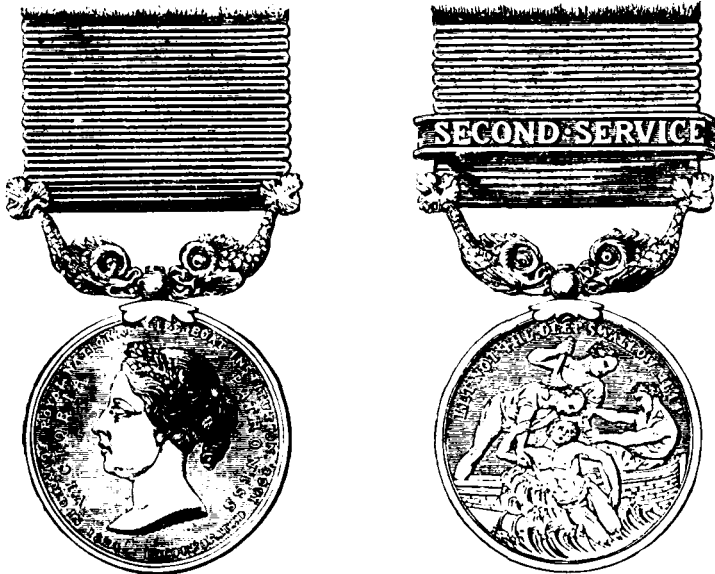

Obverse.—Bust of Her Majesty Queen Victoria; beneath, in minute letters, "L. C. Wyon." Double legend, "Royal National Life-boat Institution. Founded in 1824. Incorporated 1860. Victoria, Patroness."
Reverse.—Three sailors in a Life-boat,—one of whom is in the act of rescuing an exhausted mariner from the waves on a fragment of the wreck. "W. Wyon, Mint." Inscription, "Let not the deep swallow me up."

THE beautiful obverse of this medal, executed by the late L. C. WYON, Esq., represents the bust of QUEEN VICTORIA, Her Majesty's locks gracefully waving and gathered in a knot behind, from which issues a wreath of oak clustering over the forehead. This life-like portrait of the QUEEN, in high relief, conveys a truly pleasing and faithful likeness of HER MAJESTY at that period (1862), combining the dignity of aspect and benevolence which have always characterised the Queen throughout her long and prosperous reign.

The reverse, representing the Life-boat, in which there are three Seamen, rescuing a fourth from the sea, is a work of great merit. Two of the men are steadying the boat, while the other, stooping, draws in the Shipwrecked Sailor, whose figure is given so as to show the form in the most natural manner; and the expression thrown into his countenance looking up to his preserver is supplicating in the extreme, while the easy flowing lines of this sailor are finely contrasted by those of his companions: the whole displaying a perfect knowledge of the human frame, and a command of the graver to embody what he had shadowed out to himself.

But there is another pleasing motive for admiration of this beautiful Medal, as the figure who is so humanely extending his relief to the drowning Mariner is a portrait of the Artist, the late WILLIAM WYON, Esq., R.A., himself.

The colour of the ribbon (which is corded silk) attached to the medal is blue.

The following is a LIST of the GOLD and SILVER MEDALS which have been voted by the Committee of the Institution from its establishment in 1824 to the 31st Dec., 1896, to persons whose humane and intrepid exertions in saving Life from Shipwreck on our Coasts have been deemed sufficiently conspicuous to merit that honourable distinction. The Cases will be found recorded in detail in the several Annual Reports of the Institution.

The total number of Medals and Claps granted by the Institution is 1,253, 99 of which were in Gold, and 1,154 in Silver.

Notes.—The asterisk (*) after the name denotes the reception of a Gold Medal. The figure after the name signifies the number of honorary distinctions received from the Institution. Abbreviations.—C. G.^d.—Coast Guard. R. C.—Revenue Cruiser. M. M.—Master Mariner.

Abbot, Sidney, Clovelly.	Agar, J., C. G. ^d , Morris Castle.	Amis, Edward, late Coxswain of the Palling Life-boat.	Armstrong, Mr. W., Blyth.
Abbott, Mr. John, Ch. Boatman, C. G. ^d .	Agnes, Samuel, Wivenhoe.	Anderson, Mr. John G., R.N.	Armstrong, W., Newbiggin.
Acraman, Mr. J., Fishguard.	Ahern, John, C. G. ^d , Kilmore.	Annis, Mr. M., C. G. ^d (2)	Arnold, Mr. W. H., C. G. ^d , Sandown.
Adair, Mr. R., Coxswain Ballywalter Life-boat.	Aikin, J., C. G. ^d , Cusheadall.	Anthony, Mr. Owen, M.M., Holyhead.	Askin, J., C. G. ^d , Ballywalter.
Adair, Mr. W., C. G. ^d .	Alexander, W., Coxswain of the Thorpeness Life-boat.	Armstrong, Mr. J., Coxswain of Hauxley Life-boat.	Atkins, T., C. G. ^d , Wainfleet.
Adam, Mr. J., C. G. ^d (2)	Allan, Jas., Holy Island.	Armstrong, R., Newbiggin.	Austen, Wm., Seaman, Rams-gate Steamer <i>Vulcan</i> . [beg.
Adams, Mr. Thomas, M. M.	Allen, Mr. Luke Jas., M. M., Wivenhoe.		Antridge, Lieut., R.N., Doon-

- Avisse, Mr. J. N., M. M.,
Boulogne.
- Bacon, Henry, Harwich.
Bacon, Mr. James, M. M.
Bailey, Jas., Boatman, Deal.
Baillie, Lieut. Henry, R.N.
Baillie, Lieut. H., R.N.
Bain, Alex., Seaman, Skerries.
Bake, Lieut., R.N., C. G.^d.
Baker, Lt. G. S., R.N., C. G.^d.
Baker, Lt. W. H., R.N., C. G.^d.
Baker, Mr. T., C. G.^d, Brooke.
Ball, Mr. D. Graham, M.M.
Ball, E., Angle.
Banyard, Mr. John, C. G.^d.
Bariach, Mr. Henry, M. M.
Barnard, A., C. G.^d (2)
Barnes, George, Christchurch.
Barrett, Mr. J., C. G.^d.
Carnore. (2)
Barrett, W., C. G.^d.
Barrett, W., Jun., ditto.
Barron, R. N., Esq.
Barry, Lt. G., R.N., Kinsale.
Bartholomew, R. J., Esq.
Bate, Samuel, Second Coxswain Padstow Life-boat.
Bate, Thomas, Coxswain of the Bude Life-boat.
Bates, Mr. Thos., C. G.^d.
Batist, J., C. G.^d Dymchurch.
Beatson, G. B. M., Esq., C. G.^d.
(2)
Beaucklerk, The late Lord Charles.
Beck, Robert, Point of Ayr.
Beddoe, D., Fishguard.
Bedwell, Mr. Wm., M. M.
Begg, Mr., M. M.
Belsey, Hy., Ramsgate.
Benett, Capt. C. C., R.N.*
Berriman, Mr. James, M.M.
Berry, David, Ramsgate.
Bevan, Mr. John, M. M.
Bickerstaffe, Mr. R., Coxswain Blackpool Life-boat. (2)
Billett, Mr. R., C. G.^d, Coxswain of Lydd Life-boat.
Bingham, Mr. Wm.
Bishop, Geo., Polkerris.
Bishop, Mr. S., C. G.^d, Caister.
Bishop, Thos., Ast. Coxswain of Palling Life-boat.
Black, A., C. G.^d, Strangford.
Blackmore, Mr. Wm., Chief Officer C. G.^d, Penzance. (2)
Blackwood, Rev. J. O'Reilly, Ballywalter. (2)
Blair, Lt. Horatio, R.N., C. G.^d.
Blamplond, Mr. C., Jersey.
Blance, John, Shetland.
Blissenand, William M.
Blois, Capt. J. R., R.N.*
Blythe, Miss Ellen.
Boltho, Simon, C. G.^d, Bude.
Bongour, H., Pilot, Guernsey.
Bonner, G., C. G.^d, Collieston.
Bouchard, John, St. Martin's.
Bowen, Lieut. C. H., R.N.*
Boyd, Henry, C. G.^d.
Boyd, John, Portrush.
Boyd, Mrs. Captain, R.N.
Boyle, Marcus, Coxswain of Wexford Life-boat. (2)
Boyle, Lieut. Hon. R. F., R.N.
Bradford, John, Exmouth.
Bradford, Uriah, Exmouth.
Bradley, Mr. Wm., Southend.
Brice, W., C. G.^d, Greencastle.
Bridle, Mr. W., M. M., Lyme.
Brims, Mr. John, Coxswain of the Thurso Life-boat. (2)
Brine, Thos., Esq., Douglas.
Brinksmead, Mr. W., M. M.
Brittain, Lieut. G. S., R.N., C. G.^d. (2)*
Britton, Mr. J., Master of the American Ship *Rochester*.
Britton, Mr. Wm., Coxswain of the Harwich Life-boat.
Broad, W., Esq., Falmouth.*
Brooks, A., C. G.^d, Dungeness.
Brown, Mr. Christopher, Bridlington.
Brown, Mr. Fredk., Bridlington.
Brown, Henry, Newbiggin.
Brown, James, Dunbar.
Brown, Mr. John, Coxswain of Newbiggin Life-boat. (2)
Brown, Thos. Cresswell (2).
Browne, Mr. P. R. M. (2)*
Brune, Miss B. M. Prideaux.
Brune, Miss E. F. Prideaux.
Brune, Miss G. R. Prideaux.
Brune, Miss M. K. Prideaux.
Brunton, Lt. J., R.N. (2)*
Buck, W. C., Esq., R.N., C. G.^d.
Buckett, J., Coxswain Brighthelm Grange Life-boat.
Budd, James, Esq., Tramore.
Bulkeley, J. B., Coxswain of Teignmouth Life-boat.
Bulley, Lieut. J., R.N. (4)**
Bumby, Mr. J., C. G.^d, Clovelly.
Bunt, Mr. John, C. G.^d.
Bunt, John, Portishead.
Burnard, Mr. T., Bideford. (2)
Burne, J., C. G.^d, Penzance.
Burne, John, Sen., Shields.
Burney, Mr. R., C. G.^d, Banff.
Burton, William, Ramsgate.
Bury, Lt. Viscount, P.C., M.P.
Butcher, James, Lowestoft.
Butcher, Rich., Lowestoft.
Byrne, Mr. Lawrence, C. G.^d.
Byrne, Private, Royal Irish Regt.
- Cable, Mr. James, Coxswain Aldeburgh Life-boat. (2)
Cahill, D. F. S., Esq., M.D.
Cain, Wm., Isle of Man.
Callaway, W., Seaman, Lyme.
Callow, Mr. Wm., Coxswain of Castletown Life-boat. (2)
Campbell, James, Leestona.
Campbell, Miss J., Drogheda.
Campbell, Mr. Angus, Cutter *Princess Royal*.
Cameron, Capt. Orford S., R.N., C. G.^d.
Candlish, J., Coxswain of the Lytham Life-boat.
Cannell, T., Isle of Man.
Cannon, Mr. John, Coxswain of Hasborough Life-boat.
Carberry, Patrick, Wexford.
Carbis, Thos., Coxswain of the Penzance Life-boat. (2)
Carey, H., Esq., Shrove Head.
Carr, C. S., Gunner R.C. *Sylvia*.
Carr, Mr. Henry, H.M. Customs, Wexford.
- Carr, John, C. G.^d, Dunmanus.
Carr, Mr. Samuel, C.O. C. G.^d.
Carrington, Mr. J., Steam-tug *Liverpool*, Harwich.
Carrington, Lieut. R.N.
Carrington, W. H., Esq.
Carroll, Private, Royal Irish Regt.
Carter, Fredk., Weymouth.
Carter, Mr. J., C. G.^d.
Casey, M., Newcastle, Ireland.
Castel, G., Broadstairs.
Cay, Capt. R. B., R.N. C. G.^d.
Chaddock, J., C. G.^d.
Chaplin, Mr., M. M.
Chapman, Thomas, Esq., F.R.S., V.P.*
Chappell, Mr. T., Bideford.
Chappell, Capt. W., Bideford.
Chard, J., Boatman, Thorpe.
Chesnut, George, Skegness.
Chittenden, E., Broadstairs.
Christian, Mr. Thomas A.
Clark, George, Seaman.
Clark, Lieut. Joseph, R.N.*
Clark, Mr. T., Bridlington.
Clarkson, Mr. T., Coxswain of the Lytham Life-boat.
Clayburn, T., Scarboro'. (2)
Clayton, Lt., R.N., C. G.^d.
Cleave, Mr. R., M.M., Wivenhoe.
Cloe, W., Pilot, Mevagissey.
Cobb, Rev. C., M.A., Dymchurch.*
Cockrom, W., H.M.S. *Eagle*.
Coffey, P., Tramore, Waterford.
Colby, Nathaniel, Coxswain of the Pakefield Life-boat.
Cole, J., Seaman, Wivenhoe.
Collard, Mr. S., Pilot.
Collins, Mr. James, C. G.^d.
Collins, Mr. J., Master of the American ship *Roscus*.
Collison, Mr., M. M.
Collopy, J., C. G.^d, Porthcawl.
Combe, Lt. M., R.N.
Coneys, Mr. Anthony, Clifden.
Connick, Mr. J., Dundalk.
Cooper, Mr. Hugh, C. G.^d.
Cooper, T., Sen., Ramsgate.
Cooper, T., Jun., Ramsgate.
Coppin, Lt. F., R.N., C. G.^d.
Corbert, W., Coxswain of the Ardmore Life-boat.
Corbet, P., Pilot, Guernsey.
Corbett, W., Esq., Isle of Man.
Cork, W., C. G.^d, Fort George.
Corkhill, W., Coxswain of the Padstow Life-boat. (2)
Cornish, Lt. J., R.N., Bovis.
Costello, M., Esq., Rosslare.
Cotton, D., Brixton, I.W.
Cotton, James, ditto.
Cotton, W., ditto. (2)
Coul, Alexander, Montrose.
Coul, Charles, Montrose.
Cowin, J., Isle of Man.
Cox, Dr. H. L., Army Medical Department.
Cox, Lt. H., R.N., C. G.^d. (2)*
Cox, Joseph, Coxswain of the Appledore Life-boat. (3)
Cox, J. Jun., Second Coxswain, Appledore Life-boat. (2)
Cox, W., Kilmore.
Craggs, J., C. G.^d, Devonport.
- Cragie, J., Coxswain of the Southold Life-boat. (2)
Crawford, Wm., Esq.
Cronne, Dennis, Ballycotton.
Cropper, Peter, Liverpool.
Crosby, Nicholas, Dundalk.
Croswell, Mr. T., Fowey.
Crouch, J., Broadstairs.
Crouch, R., Broadstairs.
Crowden, Mr. J., Chief-Officer of C. G.^d at Muchals, N.B.
Cubitt, Mr. W., Bacton. (2)
Cubitt, Mr. W. Jun., Bacton.*
Culmer, Mr., C. G.^d, Leigh.
Cumisky, W. J., Esq., Balbriggan.
Cummins, Mr. J., Coxswain of the Arklow Life-boat.
Cunningham, Mr. J., Newcastle.
Curnow, Mr. Paul, Coxswain of the St. Ives Life-boat. (2)
Curtels, Mr. W., C. G.^d.
Curtis, Steph., Christchurch.
- Dabine, Lieut., R.N., C. G.^d.
Dand, M. H., Esq. (2)
Dark, Mr. William, M. M.
Darling, Wm., Light-house keeper, Fern Islands.
Darling, Grace, his daughter.
Darragh, H., C. G.^d.
Davies, the late Vice-Admiral George. (4)*
Davies, Capt. Thomas, R.N.
Davies, George, Hoylake.
Davison, W., Sunderland.
Dawson, Mr. T., Hartlepool.
Day, Chr., Middlebrough.
Day, Mr. Thomas, Bideford.
Deane, Mr. Henry, C. G.^d.
Delpierre, Jean A., Boulogne.
Dent, J., Newbiggin.
Desmond, John, Limerick.
De St. Croix, Mr. F., Jersey.*
De St. Croix, Mr. J., Jersey.*
De St. Croix, Mr. P., Jersey.*
Devereux, M., Master Pilot, Rosslare. (3)
Dillon, Jas., C. G.^d, Arklow.
Dinneen, Mr. J., C.O. s.s. *Albatross* of London.
Dobson, T., Coxswain of the Donna Nook Life-boat.
Donkin, A., Cullercoats. (2)
Donovan, Dennis, C. G.^d. (2)
Donovan J., C. G.^d, Boatman.
Dooley, Lt. D., R.N., C. G.^d.
Douglas, Alexander, C. G.^d.
Douglas, Jas. Jr., Harrington, Cumberland.
Dower, Capt. A., Dungarvan.
Downing, Nicholas B., Esq.
Drayson, D., C. G.^d.
Duffy, M., Mullaghmore.
Duncan, Mr. David, Coxswain of Montrose Life-boat.
Dunmore, The Right Hon. The Earl of.
Dunn, Mr. William, M. M.
Durban, John, Walmer.
Dyer, B. Seaman, Wivenhoe.
Dyer, B., Seaman, Wivenhoe.
Dyer, Lt. H. McNeill, R.N.
Dyer, Mr. John, Stratton.
- Earle, Lt. E. C., R.N., Rve.*
Eastaway, R., Boatman, C. G.^d.

- Eastaway, Mr. T.
Eddy, R. Pilot, Plymouth. (3)
Edlington, Mr. Chas., C. G.^d.
Edwards, Mr. D., Montrose.
Ellis, Henry, C. G.^d, Bude.
Elphinstone, Geo., Dundalk.
Else, Lieut., R.N., Fowey.*
Elton, Lt. W. H., R.N., C. G.^d.
Elwin, Lt., R.N., Lymlington.
Elyard, Lt. Col. J. (2)*
Erridge, E., Boatman, Deal.
Essell, Lieut. Wm. F., R.N.*
Evans, Mr. D., C. G.^d, Coxswain, Poolbeg Life-boat.
Evans, Police Constable Henry, Carnarvon.
Evans, Capt. Thomas.
Evans, Mr. J., Fishguard.
Evans, Lieut. Thomas, R.N.
Evans, T., sen., New Brighton. (2) [ton.
Evans, T., Jun., New Brighton.
Evans, Wm., New Brighton.
Evans, Wm., Pilot, Neath.
Evison, Lt. J. C., R.N., C. G.^d.
- Farmer, David, Hayling.
Farrin, Mr. G., H.M.S. *Ajax*.
Fell, Mr. Robert, Coxswain of Ramsey Life-boat.
Fellowes, Capt. T. H. B., R.N.
Fernie, Peter, Buckle.
Festing, Lieut., R.N.
Festing, Colonel Sir F. W., C.B., K.C.M.G., R.M.A.
Field, Lieut. Wm. Geo., R.N.
Field, Mr. W., Milford Haven.
Finlay, G., C. G.^d, Lambay.
Finlay, William, Montrose.
Fish, Chas. E., Coxswain Ramsgate Life-boat. (3)*
Fish, John, Southwold.
Fisher, A. E., Ramsgate.
Fisher, M. S., Horseferry-rd.
Fisher, Mrs., North Feroc.
Fitzjames, Mr., R.N.
Fitzpatrick, J., C. G.^d.
Flann, Wm., Portland.
Fleming, George, Gorleston.
Fletcher, T., C. G.^d, Rosslare.
Flory, Mr. J., Portishead.
Flynn, P., C. G.^d, Kilrush.
Fogg, Mr. James, Fleetwood.
Foley, Mr. J., Port Talbot.
Foley, Mr. M., M. M.
Foley, Winspeare, Esq., Ballycastle.
Forbes, Mr. A., Peterhead.
Foreman, Mr. W., Coxswain Broadstairs Life-boat.
Formby, Joseph, Formby.
Forward, Mr. T. R., Commander R. C. *Sylvia*.
Foster, J., C. G.^d, Aldboro'.
Found, Mr. W., M. M.
Fowell, John, Seaman.
Fowler, Mr. James, M. M.
Fox, Mr. John, Fleetwood.
Foy, Thomas, Rosslare.
Frankish, T. H., Bridlington.
Franklin, Lt. E., R.N., Hove.
Franklin, Mr. J. H., Seaton Carew. [Carew.
Franklin, Mr. M., Seaton
Franklyn, Lieut. G., R.N.
Freeman, Mr. H., Coxswain Whitty Life-boat. (2)
Freeman, James, Helston.
- Freeman, John, Seaman.
Freemantle, Capt. C. W., R.N.*
Freeney, John, Killiney.
French, Mr. Charles, C. G.^d.
Friend, Thos., Ramsgate.
Fulton, Mr. Robert, R.N.
Furlong, A., Fishguard.
- Galbraith, Mrs. E., Whitney.
Gale, Mr. W., M.M., Barking.
Gallagher, P., Co. Down.
Garrett, Mr. R., Coxswain Ramsey life-boat.
Gartside-Tipping, Lieut. H. T., R.N.
George, Philip, Coxswain of Caister Life-boat. (2)
Gerrard, Mr. R., Pilot, Fleetwood.
Gilbert, Mr. James, Coxswain of the Tynemouth Life-boat. [stow.
Giles, Mr. W. M. M., Padgillespie, Andrew, Gunner.
Gilmer, Mr. Wm., Dundalk.
Gilson, Lt. T. A., R.N., C. G.^d.
Gimar, Mr. E., Master of the French brig *Le Norman*.
Gin, N. François, Boulogne.
Gleeson, R. F., Wexford.
Glover, Mr. J., M. M., Harwich.
Goldring, Mr. W., M. M., Hayling.
Goldsmith, E. W., Southwold.
Goldsmith, John, Ramsgate.
Goldsmith, Rd., Ramsgate.
Goldsmith, Stn., Ramsgate.
Gordon, Mr. John, Second Cox. Tyrella Life-boat.
Goss, Capt. T., R.N., C. G.^d. (2)* [ford.
Gough, J., Fisherman, Watergould, Lt. Wm., R.N., C. G.^d.
Gourlay, James G., St. Andrews.
Graham, G., Lt. R.N., C. G.^d.
Graham, Capt. Philip, R.N.*
Graby, Mr. Charles, M. M.
Grandy, Mr. R. C. *Happy*.
Grandy, Lieut. S., R.N. (2)*
Grant, Mr. W., Coxswain of the Margate Life-boat. (2)
Graves, Mr. J., M. M., Carlisle.
Gray, A., C. G.^d, Fort George.
Gray, D., C. G.^d, Kilmore.
Gray, Mr. Geo. Bridlington.
Gray, Mr. J. M. M., Peterhead.
Gray, E. W. D., Esq., Dublin.
Gregory, J., C. G.^d, St. Andrews.
Grey, George, Hartlepool.
Grier, John, Clacton.
Griffith, David, Beaumaris.
Griffith, Robert, Anglesey.
Griffiths, Mr. B., M. M., Portmadoc.
Griffiths, G., Pilot, Anglesey.
Griffiths, T., C. G.^d, Mulbay.
Gruer, Wm., C. G.^d.
Guy, Mr. Philip, Bideford.
- Hall, Mr. G. E., Lowestoft.
Halse, Mr. R., C. G.^d.
Hamilton, Mr. B., Coxswain of the Black Rock Life-boat.
- Hamilton, Mr. Geo., C. G.^d.
Hamilton, H. A., Esq. (3)*
Hamone, Mr. A., M. M.
Hanning, N., C. G.^d, Dingle.
Hansell, P. S., Broadstairs.
Hansford, John, Weymouth.
Harrington, Mr. Dennis, Bere Island, Cork.
Harrington, Mr. Jas., Bridlington Quay.
Harrington, T., C. G.^d.
Harris, F., Esq., Inspecting Officer, C. G.^d, Seafield.
Harrison, Jacob, Shields.
Hatch, Mr. N. G., 1st Mate Ship *Berkshire*.
Hayden, Mr. F., Sandown.
Haylett, Mr. J., jun., Cox. of the Caister Life-boats.
Haynes, Mr. J., Coxswain of the Port Isaac Life-boat.
Hayter, Mr. John, Coxswain of Brooke Life-boat. (4)
Headon, Mr. Richard, Coxswain Clovelly Life-boat.
Heal, J., Atherfield.
Heard, Rich., Esq., C. G.^d.
Heath, Mr. Joshua, Coxswain of the Fowey Life-boat.
Heavy, P., Constable, Knock.
Hein, Mr. F. J., M. M.
Henin, P., Boulogne-sur-Mer.
Hennessey, Mr. Lawrence, C. G.^d. (2)
Hennessey, J., C. G.^d.
Henry, Lieut., R.N., C. G.^d.
Henslow, Lt., R.N., C. G.^d.
Hewwood, T., C. G.^d, Fowey.
Herbert, The Hon. Auberon.
Herrington, B., Southwold (2)
Hick, Mr. M., Scarborough.
Hicks, Barnard, Scilly.
Hicks, Mr. D., Coxswain St. David's Life-boat.
Hicks, Geo., C. G.^d, Tyrella.
Hicks, Samuel, Seaman. [(2)
Higgs, S., Jun., Esq., the late.
Higgins, W., Second Coxswain Penzance Life-boat.
Highland, Owen, Anglesey.
Hildebrand, H., Esq. (2)
Hill, Mr. J., Coxswain, Newcastle, Dundrum, Life-boat.
Hill, Mr. W., Mate.
Hillary, Sir A. Wm., Bart.
Hillary, Sir Wm., Bt. (4)*
Hills, W., late Coxswain of the Padstow Life-boat. (2)
Hipplewhite, Mr. T., M. M.
Hodds, Mr. Wm., Coxswain of Winterton Life-boat.
Hodge, Mr. Robert, Clovelly.
Hodgson, J., Sunderland.
Hoed, Mr. F. P., M. M., ship *Phenomené*.
Hogben, J., late Coxswain of Ramsgate Life-boat.
Hogg, Mr. William, C. G.^d.
Holborn, S., Broadstairs.
Holland, Lieut. John, R.N.
Holman, Lieut. T., R.N.
Holmes, Lance-Corpl., Rifle Brigade.
Hood, Hy., late Coxswain of the Seaton Carew Lifeboat.
Hood, Mr. W., Seaton Carew.
Hook, R., Coxswain of Lowestoft Life-boat. (2)
- Hook*, Mr. Wm., Coxswain Blakeney Life-boat.
Hopkins, Mr. John, Coxswain Portrush Life-boat.
Horsford, Miss Josephine.
Horsford, Miss Maria.
Houghton, H., Hartlepool.
Howard, Francis, Private, 57th Regiment.
Howe, R., C. G.^d, Ballygerig.
Howell, Mr. J., Port Talbot.
Howorth, Capt. Wm., R.N.
Hughes, E., Sen., Cwmerran.
Hughes, G., Pilot, Guernsey.
Hughes, Mr. John, Coxswain of Bull Bay Life-boat.
Hughes, Mr. John, Liverpool.
Hughes, Mr. R., Coxswain, Moelfre Life-boat.
Hughes, T., Pilot, Holyhead.
Hughes, Mr. W., Fisherman, Pittenween, N. B.
Humphreys, Mr. D., Liverpool.
Hurle, Edwin, Ramsgate.
Hurry, Mr. Stephen, M. M.
Huss, Mr. T., H.M.S. *Kover*.
Hutchinson, Mr. H., C. G.^d.
Hutchinson, Henry, Bridlington.
Hutchinson, Lt., Kingstown.
Hutchinson, Lieut. W., R.N.*
Hyde, James, Scilly.
Hynds, Mr. John, Dundalk.
Hynes, B., C. G.^d, Galway.
- Iles, The late Mr. John, Scarborough.
Inkster, Mr. Peter, M. M., Shetland.
- James, Lieut. Horatio, R.N.*
James, Lieut. Wm., R.N.*
Jamieson, Mr. James, Lerwick.
Japp, Robert, Montrose.
Jarman, Isaac, late Coxswain of Ramsgate Life-boat. (2)
Jeffers, Rich., C. G.^d, Dingle.
Jefferson, P., Newbiggin.
Jellard, Mr. John, M. M.*
Jenkins, Mr. J., Coxswain of the Swansea Life-boat.
Jenkins, L., Pilot, Port Talbot.
Jenkins, Mr. W., Fishguard.
Jennings, Mr. Wm., M. M., Harwich.
Jennings, W., C. G.^d, Looe.
Jesse, Commander R., R.N.
Jinks, Mr. R., Chief Officer of Coast Guard, Cardigan.
Joachim, Capt., R.N. (4)
Jobson, Lt. C., R.N. (2)**
John, Mr. W., Breakesea.
Johns, Mr. Rich., Mevagisey.
Johns, Rich., Seaman, Fowey.
Johns, R. O., Coxswain of the Tramore Life-boat. (3)
Johns, Mr. W., M. M.
Johnson, Admiral W. W. P., the late.*
Johnson, Wm., Yarmouth.
Johnston, Mr. B., M. M.
Jones, Capt. C. Gray, R.N., the late. (2)
Jones, Mr., C. G.^d, Wicklow.
Jones, Mr., C. G.^d, Swicks.
Jones, Mr. E., M. M.

- Jones, Mr. E., Coxswain of the Holyhead Life-boat. (2)
 Jones, George, Boatman.
 Jones, John, Merilyn.
 Jones, Henry, Penzance.
 Jones, J., Pilot, Porthcawl.
 Jones, Owen, Anglesey.
 Jones, Lt. R., R.N., C. G^d. (3)**
 Jones, Mr. R., Assist. Cox. of the Holyhead Life-boat.
 Jones, Mr. Thos., Holyhead.
 Jones, Mr. T., M. M., Port Talbot.
 Jones, Mr. T., M. M., Cardiff.
 Joy, Mr. George, M. M.*
 Juniper, Wm., Mundesley.
- Kavanagh, Mr. P., Coxswain of the Arklow Life-boat.
 Kavanagh, Mr. P., Coxswain Carnsore Life-boat. (2)
 Keane, Mr. Richd. S. O. C. G^d, Helen's Bay.
 Kearon, Capt. Edw., Arklow.
 Kelland, Mr. Wm. R., Trinity Pilot, Dartmouth.
 Kelly, Lient. E., R.N.
 Kelly, Mr. Geo. Edwd.
 Kelly, J. M., Appledore.
 Kendall, W., C. G^d.
 Kennedy, Inspecting-Lt. A., R.N., C. G^d. Ballyheige. (2)
 Kennedy, E., C. G^d.
 Kennedy, Mr. H., Belfast.
 Kennedy, Malcolm, Bowmore.
 Kennedy, Master J., Belfast.
 Kent, Mr. Frank, C.O. C. G^d, Sandwich.
 Kerley, T., C. G^d, Penzance.
 Kerr, E. C. Esq., Ramsey.
 Kernish, Mr. John, C. G^d.
 Kidd, D., Fisherman, Dundee.
 Kinch, H., Newcastle.
 King, Lt. S., R.N., Southend.
 King, Mr. T., M.M., Harwich.
 Kisbee, Com. Thos., R.N.
 Knight, Mr. Charles, Mate, Ramsgate Steamer *Vulcan*.
 Knight, J. T., C. G^d.
 Kyle, Geo., Assist. Coxswain Holy Island Life-boat.
 Kyle, Matthew, Coxswain Holy Island Life-boat.
- Lake, Mr. A., Chief Officer of C. G^d, Wick, N.B.
 Lambert, John, Harwich.
 Lambeth, Benj., Harwich.
 Landells, Mr. Thos., Milford.
 Lane, Lt., R.N., Dartmouth.
 Langan, Mr. Michael, First Officer of Steamer *Princess Alexandra*.
 Langton, Lieut. T. W., R.N., C. G^d.
 La Primaudaie, Clement, Commander R.N.
 Large, Mr. J., Master Gunner, R.A.
 Larkin, Thomas, Seaman.
 Lavington, Lt. Thos., R.N.
 Lawrence, Mr. James, Coxswain of Selsey Life-boat.
 Lasoix, Lient. of the French Marine at Dieppe.
 Leask, Mr. Robert, jun., Ireland, near Stromness.
- Lee, Mr. Charles, Coxswain Worthing Life-boat.
 Leese, Charles, Gunner, R.A.
 Legerton, Mr. Robert, Cox. Clacton Life-boat. (3)
 Le Geyt, Miss A. B., Bath.
 Leggett, Edw., Gunner.
 Leigh, Lt. T., R.N., C. G^d. (3)**
 Leslie, Mr. J., M. M., Stonehaven, N.B.
 Lett, Lt. S. J., R.N., C. G^d.
 Levett, Mr. N., late Coxswain of the St. Ives Life-boat.
 Lewis, E., Seaman, Barmouth.
 Lewis, Mr. G., C. G^d, Newport, Pembroke.
 Lewis, J., Seaman, Harwich.
 Lewis, Mr. Thos., Dundalk.
 Lewis, W., Seaman. (2)
 Lewis, W., Aberystwith.
 Ley, J., Pilot, Mevagissey.
 Liffen, Thomas, Lowestoft.
 Likely, Henry, Limerick.
 Linaker, Mr. Hiram, New Brighton.
 Lindsay, Lient. A. J., R.A.
 Lindsay, Lient. Jas., R.N.*
 Lingard, Lieut. J., R.N., Whitley.*
 Lithaby, P., C. G^d, Boatman.
 Llewellyn, Mr. David, C. G^d.
 Llewellyn, M., Fishguard.
 Llewellyn, Martha, ditto.
 Lloyd, O., C. G^d, Lulworth.
 Lloyd, Lt. S., R.N., C. G^d.
 Long, J. H. Esq., Youghal.
 Lose, Mr. John, C.O., C. G^d. Swanage.
 Louchet, L. P. A. B., Anthie.
 Loughor, Rees, Monknaish.
 Love, Private Robert, 63rd Regiment.
 Lovell, Patrick, Belmullett.
 Lucas, Mr. James, Coxswain Lydd Life-boat.
 Ludlow, Mr. I., Master of the American ship *Monmouth*.
 Lusk, Mr. A., Raeberry.
 Lyons, Lient. Wm., R.N. (2)
- Macalister, Mr. Robt., Wick.
 Macdonald, George, C. G^d.
 Mackay, Mr. James.
 Mackell, Mr. Patrick, C. G^d.
 Mackintosh, Mr. Alex., M.M.
 MacMahon, Capt. H., M. M., East Clare Militia.
 Macnamara, Lt. T., R.N., C. G^d.
 Mann, W., Ast. Coxswain Aldeburgh Life-boat.
 McAllister, Wm., Portrush.
 McArdie, Thomas, Dundalk.
 McBay, Mr. Jas., Johnshaven.
 McCarthy, J., C. G^d.
 McCarthy, Jas., C. G^d.
 McCombie, Mr. T., Steamer *Tearaght*. (2)*
 McCulloch, K., C. G^d. (2)
 McDonald, Mr. Wm., Irvine.
 McGenis, G., barque *Albany*.
 McGladery, Lt. J., R.N.
 McKenzie, J., C. G^d, Galway.
 McKinnon, Mr. J., M. M., Greenock.
- McKinstry, John, Ferryman, Masee.
 McMillan, J., Kanytre.
 McNamee, P., C. G^d, Dunmanus.
 McNaughten, Neil, C. G^d.
 McPhillips, Patrick, Sergeant, R.I.C.
 McQueen, Alex., Seaman.
 Maddick, Mr. H., M. M.
 Manby, Capt. G. W.*
 Manifold, Mr. W., Assistant Coxsw. Arklow Life-boat.
 Mann, Lieut., R.N., C. G^d.
 Mariole, J. B., French Pilot.
 Mark, Wm., C. G^d, Dingle.
 Markwell, George, Holy Island.
 Marsh, Capt. D., R.N., C. G^d.
 Marshall, Capt. J., Bideford.
 Marshall, Mr. John, Jun., Second Coxswain of the Seaham Life-boat.
 Martin, Mr. Chas., C. G^d, St. Ives, Cornwall.
 Martin, Mr. Wm., Coxswain of New Brighton Life-boat.
 Mason, J., C. G^d, Elle.
 Matthews, Mr. Edwin, Coxswain of Lizard Life-boats.
 Matthews, Lt. R. B., R.N.*
 May, Mr. A. C., H.M.S. *Rover*.
 May, W. R., C. G^d, Boscastle.
 Meader, Henry, Life-boatman, Ramsgate.
 Mearns, Mr. R., Jun., M. M., Montrose.
 Mearns, Wm., Coxswain of Montrose No. 1 Life-boat.
 Mearns, Wm. Jun., Coxswain Montrose No. 2 Life-boat.
 Metcalfe, Jas., Hartlepool.
 Metherell, Lt. R. B., R.N., C. G^d.
 Mewse, A., Boatman, Lowestoft.
 Middleton, John, Deal.
 Milburn, John, Shields.
 Milburn, Wm., Isle of Man.
 Miller, J., C. G^d, Devonport.
 Miller, W., Ramsgate.
 Milligan, Mr. G., Yarmouth.
 Mills, C., C. G^d, Clifden.
 Minter, O., Boatman, Deal.
 Mirehouse, Major R. W., Angle.
 Mitchel, J., Pilot, Guernsey.
 Mitchell, C., Port Isaac. (2)
 Mittin, Phillip, Wexford.
 Moar, Mrs., Burra Ness.
 Monger, Mr. Thomas, Coxswain of Tenby Life-boat.
 Moody, Samuel, Skegness.
 Mpoody, Samuel, Coxswain of Skegness Life-boat. (2)
 Moore, Alex., C. G^d, Ballycastle.
 Moore, Gunner Jas., Coast Brigade, Royal Artillery.
 Moreno, Mr., Master of the Austrian Barque *Eva*.
 Morgan, John, Thurso, N.B.
 Morgan, Mr. John, Pilot, Cardiff.
 Morgan, Lt. R., R.N., C. G^d.
 Morgan, Mr. T., R.C., *Stork*.
 Morris, Mr. John, Anglesey.
 Morris, Capt. J. Row, R.N.*
- Morriss, R., Seaman, Holyhead.
 Morris, Mr. W. E., Port Madoc.
 Morrison, Lt., R.N., C. G^d.
 Morrison, Mr. Silvester, C. G^d, Sennen Cove.
 Morrison, W., Ballywalter.
 Mortley, Mr., C. G^d, Padstow.
 Moss, J., Boatman, Walmer.
 Mudd, Wm., Harwich.
 Mulligan, James, Sligo.
 Murdoch, Mr. Peter, Glendrishaig, Ayrshire.
 Murphy, Mr. Adam, Coxswain of Tyrella Life-boat.
 Murphy, James, C. G^d, St. Ives, Cornwall (2).
 Murphy, Mr. Michael, C. G^d, Coxswain of New Romney Life-boat.
 Murray, A., C. G^d, Elle.
 Nelson, Mr. W., R.N., C. G^d.
 Nepean, Capt. St. Vincent, R.N.
 Newnam, Lt. N., R.N., C. G^d.
 Newson, Mr. W., M. M., Harwich.
 Nichol, Mr. J., M. M., Montrose.
 Nicholas, Matt., Coxswain of the Sennen Cove Life-boat.
 Nicholls, Maurice, Clacton.
 Nicholson, M., Knock.
 Nicolle, Mr. Philip, Jersey.
 Niles, Mr. Wm., Coxswain of Cardigan Life-boat.
 Norcock, Capt. G. L., R.N.
 Norris, Benj., Boatman, Deal.
 Norris, Mr. James, M. M.
 Norris, Martin, R.N.R.
 Norsworthy, Mr. William, C.O. C. G^d, Carnarvon. (2)
 Nott, Capt. E. B., R.N. (2)
- O'Neill, Patrick, Scilly.
 O'Shaughnessy, Miss Nora.
 O'Sullivan, Mr. M., Bere.
 O'Sullivan, D., C. G^d.
 Orr, Mr. Robt., Irvine, N.B.
 Osborne, Robert, Clacton.
 Owen, Richard, Anglesey.
 Owen, Capt. Wm., Holyhead.
 Owen, Mr. William, M. M.*
 Owen, Mr. William, Pilot.
 Owston, Mr. John, Coxswain of the Scarborough Life-boat.
 Page, Mr. A., Master, Ramsgate Steamer *Vulcan*. (2)
 Palmer, G., Esq., M.P. (2)**
 Palmer, Thos. H., Southwold.
 Parker, Mr. Edwin, C. G^d, Mothecombe.
 Parker, Mr. J., Flamboro'.
 Parker, Mr. Wm., M. M.
 Parrott, Mr. R., C. G^d, Tenby. (2)
 Parry, Lieut., R.N.*
 Parry, Mr. Henry, Anglesey.
 Parry, Mr. R., M. M., Portmadoc.
 Parsons, Lient. Rich., H.M. 35th Regiment.
 Parsons, Lient. Thos., R.N.
 Parsons, Lt. W., R.N., C. G^d.
 Partridge, Capt. W. L., R.N.

- Pascoe, Peter, Porthleven.
 Patton, David, Portrush.
 Paul, Thos., C. G^d, Bude.
 Payne, Mr. John, C. O.,
 C. G^d, Skerries.
 Paynter, Capt. Richard.
 Peake, James, Esq., H.M.
 Dockyard, Devonport.*
 Peake, Admiral T. L. *
 Pearce, Rich., Esq., Penzance.
 Pearce, Jas., Pilot, Porthcawl.
 Pearse, T., Pilot, Porthcawl.
 Peart, John, Montrose.
 Pedder, Lt. W., R.N., C. G^d.
 Peebles, Mr. John, Irvine.
 Peebles, Mr. T., M.M., Irvine.
 Peirson, S. H., C. G^d.
 Penney, Robert, Ramsgate.
 Pepper, J., C. G^d, Lynton.
 Perkins, Jas., C. G^d, Bude.
 Perring, Fredk., Polkerris.
 Perrott, Sir Edward G. L.,
 Bart. *
 Perry, Frank, Weymouth.
 Pestell, Mr. W., Coxswain
 of the Palling Life-boats.
 Petrie, Ellen, Shetland.
 Phillips, J., Newcastle, Ireland.
 Picard, Mr. P., French M. M.
 Pilcher, Mr. Stephen, Cox-
 swain Tramore Life-boat.
 Pillar, W., Gunner, H.M.S.
 Eagle.
 Pincomb, T., Pilot, Exmouth.
 Pitt, E., C. G^d, Atherfield.
 Pockley, Mr. B., Cox. Flam-
 borough Life-boat.
 Pomeroy, H., C. G^d.
 Porter, William, Seaman.
 Potter, Mr. W., Coxswain
 Cahore Life-boat. [pool.
 Pounder, Mr. Thos., Hartle-
 Powell, Mr. John, M. M.
 Pratt, Lt. Jas., R.N., C. G^d.
 Prattent, Lieut. John, R.N.*
 Preston, Mr., C. G^d, Newton.
 Preston, W. M. Esq., Beau-
 maris. (2)
 Prewel, R., C. G^d, Kilrush.
 Price, Thos., Beaumaris.
 Pride, C., C. G^d, Christchurch.
 Pringle, Mr. T., Cox. North
 Sunderland Life-boat.
 Prior, Mr. George, C. O.,
 C. G^d, Ballywalter.
 Prior, Lt. T. H., R.N., C. G^d.
 Prosser, Mr. H., C. G^d.
 Prowse, George, Exmouth.
 Purdy, H., C. G^d, Tyrella.
 Purvis, Mr. Richard, Brid-
 lington.
 Puxley, H., Esq., Dunboy.
 Pym, Lt. R. E., R.N., Whitby.*

 Quadling, Mr. B. E., C. G^d. (2)*
 Quayle, Capt. E. (2)
 Quigley, Mr. W. T., C. G^d.
 Quirke, G., Esq., Douglas.

 Rae, Wm., Whitburn. [(2)*
 Randall, Lt. H., R.N., C. G^d.
 Randle, Mr. J., Bristol.
 Rawstone, Lt., R.N., C. G^d.
 Ray, J., Boatman, Tenby.
 Raye, Lieut. H. R., R. M.
 Read, Lieut. J., R.N., C. G^d.
 Reade, W. M., Esq., Tramore.

 Reading, Mr. Daniel, Master
 of Ramsgate Har. stm. tugs.
 Redford, J., Cullercoats.
 Rees, Mr. A., Port Talbot.
 Rees, T., Angle.
 Rees, Mr. T. M., St. David's.
 Rees, Mr. W., Fishguard.
 Reeve, Mr. J., Swansea.
 Regan, D., C. G^d, Kilmore.
 Reilly, Patrick, Private,
 A.S.C.
 Renowden, J., C. G^d, Dingle.
 Revell, Edw., Seaman, Rama-
 gate Steamer *Vulcan*.
 Riach, Wm., Buckle.
 Richards, Mr. E., M. M.
 Richards, Henry, Penzance.
 Richards, James, Penzance.
 Richards, Mr. T., M. M.
 Richardson, Mr. A., M. M.
 Richardson, W., Esq., Cole-
 raine.
 Ridge, Capt. G. A. E., R.N.
 Ridge, Mr. J., Mate of R.C.
Kite. [with.
 Ridge, Mr. J., C. G^d, Cadg-
 Rimmer, Mr. Thos., Cox-
 swain St. Anne's Life-boat.
 Rlooh, B., C. G^d, Colleston.
 Ritchie, Mr., Sanda.
 Rivers, T., C. G^d, Lydd.
 Roberts, David, Colwyn Bay.
 Roberts, Mr. John, Clogwyn.
 Roberts, Mr. John, Cefn Coch.
 Roberts, John, Caellun.
 Roberts, O., Pilot, Anglesey.
 Roberts, Mr. R., Carnarvon.
 Roberts, Mr. R., Assistant
 Cox. Llanddulas Life-boat.
 Roberts, Mr. R., Ast. Cox.
 North Deal Life-boat. (2).
 Roberts, Mr. Robert, Cox.
 Penmon Life-boat. (2)
 Roberts, Mr. T., Coxswain
 Holyhead Life-boat (2).
 Robertson, Lt. J. H. M., R.N.
 Robertson, Lieut. R., R.N.*
 Robertson-Macdonald, Vice-
 Admiral D.
 Robins, Mr. J. Gunn, C. G^d.
 Robins, Edw., Polkerris.
 Robins, William, Polkerris.
 Robinson, Lieut., R.N.
 Robinson, Mr. J., Aberdeen.
 Robinson, T., Whitby.
 Rockcliffe, W., Southport.
 Roderick, E., C. G^d, Dun-
 manna.
 Roderick, J. S., Esq., Ardmore.
 Rodgers, J., *Royal Charter*.
 Roe, R., Esq., J. P., Lynmouth.
 Rose, W., Boatman, Lowestoft.
 Ross, R., C. G^d, Curracloe.
 Ross, R., C. G^d, Dunmore.
 Ross, Capt. Sir Thos., R.N.*
 Rossiter, T., Wexford.
 Rothery, Lieut. J., R.N.
 Rowe, W., C. G^d, Dingle.
 Rowe, W., Selly.
 Rowe, W., Seaman, Helston.
 Rowlands, Mr. T., M. M.,
 Newport, Pembroke.
 Rowlands, Mr. W., Coxswain,
 Holyhead Life-boat. (2)
 Ruddock, J., Boatman, Fley.
 Russell, R., Esq., J. P.
 Rutter, Mr. J., Scarborough.
 Rymer, Lt. D., R.N., C. G^d*

 Sadler, A., C. G^d.
 Salmon, C., Gorleston.
 Salter, F., Brixton, I. W.
 Sanderson, Lieut. J. P., R.N.,
 C. G^d, Bridge of Don.
 Sands, Mr. R., M. M., Bahamas.
 Sarony, Mr. O., Scarborough.
 Sauvage, Mr., French Fish-
 ing-boat *Isabelle*.
 Sawtell, Mr. Edw., C. G^d.
 Scaulan, Maurice, C. G^d,
 Belderig.
 Scarlett, R., Harwich.
 Schofield, Mr. Wm., Cox-
 swain of Clacton Life-boat.
 Scott, Major Henry, Dover.
 Scott, Mr. G. R., *Beethoven*.
 Scott, Mr. J., M. M.
 Selly, W. H., C. G^d, Pen-
 zance. (2)
 Sergeant, Lt. J., R.N., C. G^d.
 Sewell, Lt. H. F., R.N., C. G^d.
 Sewell, Master John, Belfast.
 Shanahan, Mr. Michael, Bere.
 Shankey, R., C. G^d. (2)
 Shannon, P., C. G^d, Kilrush.
 Sharrock, J. P., C. G^d, Bos-
 castle.
 Shaw, Lt. C., R.N., C. G^d.
 Shea, D., Coxswain of the
 Padstow Life-boat. (3)
 Shea, D., C. G^d, Porthcawl.
 Sheldon, Robt., Redcar.
 Simmons, Mr. A., Chief En-
 gineer *Duke of Northum-
 berland* Steam Life-boat.
 Simpson, Mr. Jas., late Mate
 of Ramsgate H. Steamtugs.
 Sims, J., C. G^d, Dungeness.
 Sims, Lt. And., R.N. (2).
 Sinclair, Mr. B., Thurso, N.B.
 Sinclair, Mr. D., Irvine
 Life-boat.
 Sinnott, R., C. G^d, Mullagh-
 more.
 Smallridge, Mr. J. H., Cox.
 Braunton Life-boat. (2)
 Smith, F., Boatman, Lowestoft.
 Smith, Hy., Pilot, Gloucester.
 Smith, J., Shields.
 Smith, Mr. J., Thurso.
 Smith, Mr. Owen, Bideford.
 Smith, Peter, C. G^d, Lydd.
 Smith, T., C. G^d, Ballina.
 Smith, Wm., Bombardier,
 R. A.
 Smith, Mr. W., Aldborough.
 Smyth, H., C. G^d, Kilmore.
 Snell, Lt. G., R.N., C. G^d.
 Somerville, Lt. J., R.N., C. G^d.
 (2)*
 Southey, Lt., R.N., C. G^d.
 Spark, Mr. A., M. M.
 Spindler, Mr. H., Coxswain
 Thorpe Life-boat.
 Spraggs, J., Seaman, Hayling.
 Stables, R., Holyhead.
 Standing, Edward, New
 Romney. [wold.
 Stannard, Mr. F., M. M., South-
 Stap, Mr. R., C. G^d, Dunbar.
 Stark, Lt. P., R.N., C. G^d. (2)*
 Starke, Mr. J., C. G^d.
 Starr, Capt. L. G.
 Steane, Lt. J., R.N., Rye.*
 Steel, Mr. C., C. G^d.
 Steele, John, Esq., Ayr.
 Stephens, A., Tramore.

 Stephenson, Mr. B., Coxswain
 of the Boulmer Life-boat.
 Stevens, Henry, Gunner R. A.
 Stewart, W., C. G^d, Ardmore.
 Stokes, Mr. R., late Cox-
 swain of Poole Life-boat.
 Storr, J., Whitby.
 Stone, J., C. G^d, Boscastle.
 Stout, Mr. B., Coxswain
 Longhope Life-boat.
 Stragnell, Lt., R.N.
 Strahan, Mr. H., Pilot.
 Strains, Mr. J., C. G^d.
 Streater, Mr. W. T., H.M.
 Customs, Shoreham.
 Strong, Mr. Fran. F. M.
 Stronger, Mr. G., Coxswain,
 Kessingland Life-boat. (2)
 Stuart, Lt. J., R.N., C. G^d.
 Stuart, Lt. T., R.N., C. G^d. (2)
 Stubbs, C., Seaman.
 Stubbs, H., Atherfield.
 Stiggins, Mr. W., Sec. Cox.
 Teignmouth Life-boat.
 Sullivan, J., Newhaven.
 Sullivan, Wm. C. L., Esq.
 Summer, Mr. R., Formby.*
 Superville, Mr., M. M., Bor-
 deaux.
 Surry, W., Penzance.
 Sutcliffe, Thos., Sergeant,
 R.L.C. [sars.
 Sutcliffe, Private, 21st Hus-
 Sutherland, D., C. G^d.
 Sutton, Mr. J., M. M.
 Sutton, Mr. C., Port Talbot.
 Swarbrick, Mr. W., M. M.
 Symmes, Lt. H. A. S., R.N.
 C. G^d.
 Sygne, The Rev. A., Balbriggan

 Taft, Grace, Shetland.
 Talbot, C. R. M., Esq., M.P.
 Taylor, J., C. G^d, Dundrum.
 Taylor, Mr. W. C. O., C. G^d,
 Dunny Cove. (3) [ney.
 Taylor, W. H., New Rom-
 Teel, Mr. W., late Coxswain
 Plymouth Life-boat.
 Tegg, Mr. T., M. M., Cornwall.
 Terrett, T., Constable, Knock.
 Thomas, J., C. G^d, Atherfield.
 Thomas, J., C. G^d, Rocken,
 Isle of Wight.
 Thomas, R. J., Coxswain of
 New Brighton Life-boat.
 Thompson, D., Thurso, N.B.
 Thompson, Mr. G., Annalong.
 Thompson, Mr. R., Kirkpat-
 rick, C. O., C. G^d. (3)*
 Thompson, Mr. R., Sunder-
 land.
 Thompson, W., Apprentice,
 Smack *Ruby* of Hull.
 Thorp, Mr. T., Newcastle.
 Tindall, Mr. Smith, M. M.,
 Scarborough.
 Tindall, The late W., Esq.
 Took, Alfred, Southwold.
 Toole, Capt. W., Curracloe.
 Toomey, J., Kingstown.
 Torrens, Capt. John A. W.
 O'N., Royal Scots Greys.*
 Tose, Mr. Geo., Coxswain of
 Bunswick Life-boat. ((2)
 Town, J., C. G^d, Folkestone.
 Town, J., C. G^d, Castle-
 gregory.

Tredwen, Mr. R., Padstow.	Wales, J., Broadstairs.	Welsh, Mr. M., M. M.	Williams, William, Grocer, Llanddulas.
Tregidgo, Mr. W. H., C. G ^d , Newquay. (3)	Walker, Lieut., R.N.	West, Mr. Wm., C. G ^d .	Williams, William, Quarryman, Llanddulas.
Trent, J., Atherfield.	Walker, Mr. J., Brigg.	Westbrook, Lieut., R.N.	Williamson, Mr. R., M. M. (2)
Treilian, Mr. R.	Walker, Mr. W. Lewis, Beaumaris. (2)	Wharrier, Mr. William, Engineer of Ramegate Harbour Steam-tug. (3)	Williamson, Robert, Thurso.
Trevaskis, Mr. E., Coxswain of the Hayle Life-boat. (2)	Wallace, Mr. J., M. M.	Wheeler, C., Atherfield.	Williamson, W., Pilot, Wick.
Triphook, Mr. R., R. C. Hamilton, Dumworldly.	Wallace, Mr. William.	Wheeler, J., ditto. (2)	Wilson, J., Pilot, St. Andrew's.
Trott, T., Boatman, Deal.	Walsh, J., Esq., Lloyd's Agent, Dublin.	Wheeler, R., ditto.	Wilson, Mr. J., M. M.
Tuckfield, Mr. T., Bideford.	Walsh, Mr. Martin, M. M.*	White, Jas., Coxswain of the Fishguard Life-boat. (3)	Wilson, Ralph, Holy Island.
Tudor, Capt. J., R.N., Wick. (2)	Ward, Mr. Charles, Bowman of Aldeburgh Life-boat.	White, John, Coxswain of Howth Life-boat.	Wilson, T., Esq., M. P.*
Tully, W., Newcastle.	Ward, J., R. C. Sylvia.	White, Joseph, Portland.	Wilson, T., Pilot, Holy Island.
Turnbull, R., Dunbar.	Ward, Vice-Admiral J. R.*	White, J. Kearney, Esq., C. G ^d . (2)	Wilson, W., Pilot, Holy Island.
Turner, Lt. C., R.N.	Warder, D. T., C. G ^d . ((2)	Whiteley, Mr. Elias, Jersey.	Wishart, J., Wick, N.B.
Turner, Mr. Jas., C.O. C. G ^d . Leysdown, Kent. [combe.	Warford, Mr. G., Coxswain Pakefield No. 1 Life-boat.	Whyte, Mrs., Aberdour.	Wood, Mr. T. L., C. G ^d . (2)
Turpin, Mr. J., C. G ^d , Salt.	Warn, W., sen., Atherfield.	Wickham, Mr. T., Coxswain Wexford Life-boat.	Woodgate, Mr. James, Coxswain Dover Life-boat. (2)
Tutt, E., C. G ^d , Dunmanus.	Warn, W., jun., ditto.	Wilds, Mr. Robert, Coxswain of the Deal Life-boat. (2)	Woods, Mr. E. W., Coxswain Gorleston No. 1 Life-boat.
Tuvache, Mr. M. M. French.	Warren, Lt. C. D., R.N.	Wilkie, Mr. C., M. M.	Woodham, Lt., R.N., Banff.
Tyrrill, Mr. Wm., Coxswain of Harwich Life-boat.	Wasey, Capt. E. F. N. K., R.N. (3)	Wilkinson, Geo., Fleetwood.	Woodward, Geo., Stoker, Ramegate Steamer Vulcan.
Urell, Mr. J., C. O., C. G ^d .	Waters, Wm., Southwold.	Willcox, J., C. G ^d , Lydd.	Wordley, S., Harwich.
Usher, Mr. J., Bridlington.	Watson, T. J., Ramegate.	Williams, Mr. D., Aberdovey.	Wright, John, Seaman.
Usher, Mr. John, Bridlington.	Watt, A., Montrose.	Williams, Mr. H., Coxswain of Kingstown Life-boat.	Wright, Mr. J., M. M.
Van Houten, Mr. W., Rotterdam. (2)	Watt, Capt. F., Portrush.	Williams, Hugh, Penmaen.	Wright, Mr. Robert, Coxswain of Fleetwood Life-boat. (2)
Varley, Thos., Marsden.	Watts, Mr. Charles, M. M.	Williams, Rev. J., Anglesey.*	Wyatt, G., Seaman, Harwich.
Verion, Chas., Ramegate.	Watts, Mr. William, M. M.	Williams, Mr. J., Bideford. (2)	Wyde, Lt. S., R.N., C. G ^d .
Vicary, Lt. W., R.N., Atherfield.*	Watte, Lieut. W. S., R.N.*	Williams, Mr. J. O., C. O. C. G ^d , Holyhead. (2)	Wyrill, H., Boatman, Scarborough.*
Vondy, I., Isle of Man. (3)	Wangh, E., C. G ^d .	Williams, Mr. J., Swansea.	Yare, Richd., Stoker, Ramegate Steamer Vulcan.
Waddy, Dr., Churchtown.	Webb, Edwin, C. G ^d .	Williams, Owen, Cemlyn.	Young, A., C. G ^d , Shoreham.
Wade, Mr., M. M., Padstow.	Webb, Mr. Wm., Coxswain of Padstow Life-boat.	Williams, Rev. O. Lloyd. (2)	Young, A. H., C. G ^d , Blatchington.
Wake, Mr. Baldwin Arden, Mid. H.M.S. Forester.	Webbin, J., C. G ^d , Tramore.	Williams, Mr. J. M., Padstow.	Young, Lt. T., R.N., C. G ^d .
Wales, G., Broadstairs.	Webster, Mr. J., Coxswain Maryport Life-boat.	Williams, Mr. J. O., C. O. C. G ^d .	
	Wedge, W., C. G ^d , Salcombe.		
	Weekes, Wm. Wall, Seaman.		
	Weidrake, E., Spurn Point.		

THE LIFE-BELT USED BY THE CREWS OF THE LIFE-BOATS OF THE ROYAL NATIONAL LIFE-BOAT INSTITUTION.



The requisite qualities of a life-boatman's life-belt are—

1. Sufficient extra buoyancy (maximum 28 lbs., minimum 25 lbs.) to support a man heavily clothed, with his head and shoulders above the water, or to enable him to support another person besides himself.

2. Perfect flexibility, so as to readily conform to the shape of the wearer.

3. A division into two zones, an upper and lower, so that between the two it may be secured tightly round the waist; for in no other manner can it be confined sufficiently close and secure round the body without such pressure over the chest and ribs as to materially affect the free action of the lungs, impede the muscular movement of the chest and arms, and thereby diminish the power of endurance of fatigue, which, in rowing-boats, is a matter of vital importance.

4. Strength, durability and non-liability to injury.

THE LIFE-BOAT STATION.

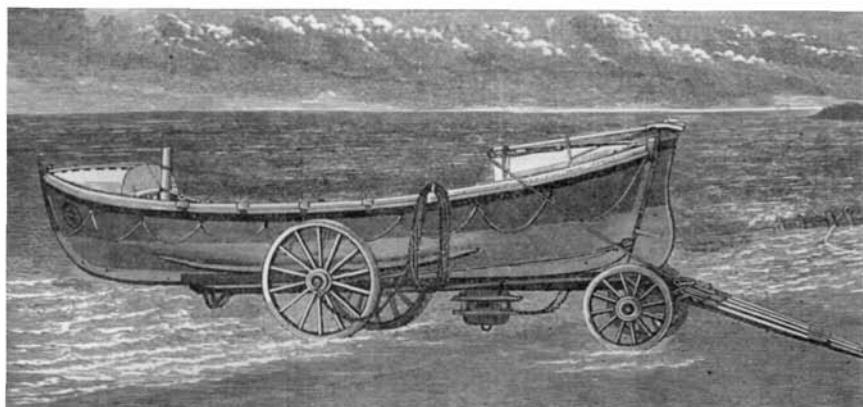

THE following brief description and diagrams illustrative of a complete Life-boat Establishment, including the House for the protection of the boat, will serve to convey an idea of the general character of one of the 298 Life-boat Stations of the ROYAL NATIONAL LIFE-BOAT INSTITUTION.

It will be seen that it is a work of a costly nature, and that not only in the first instance, but that a large permanent expense is entailed in keeping the whole machinery in an efficient state, in the re-supply of any part of it which may be destroyed or worn out, in the exercise of the boats' crews, in launching and working the boats, and in remunerating them for their services in saving their fellow-creatures. Yet, looking to the vast importance of the result effected, and the responsibility of calling on men to risk their lives in effecting the same, it is felt that few if any persons will be found who will consider that expense to be incurred in vain.

THE LIFE-BOAT.

(See Diagrams on next page.)

The following drawings show the general outline and principal fittings of a 34 feet by 7½ feet self-righting boat. Figure 1 gives the profile or broadside view, the shaded part showing that devoted to the air-cases, which give extra buoyancy. The letter A shows the deck, and the unshaded parts the relieving-tubes, by which any water that breaks on board escapes. The shaded part of the keel, B, represents the ballast composed of iron. The festooned dotted lines are the life-lines outside the boat, for men to catch hold of when overboard.

In Figure 2, the unshaded space, A, represents the uncovered part of the deck,

B, the relieving-tubes, C, the side air-cases above the deck, D, the end air-cases, E, the ventilating scuttles, F, the water-ballast tanks, G, the plugs, and H, the pumps of the ballast tanks.

Figure 3 represents the body plan or cross sections at various distances from stem to stern.

Figure 4 gives the midship section.

THE SELF-RIGHTING WATER-BALLAST LIFE-BOAT.

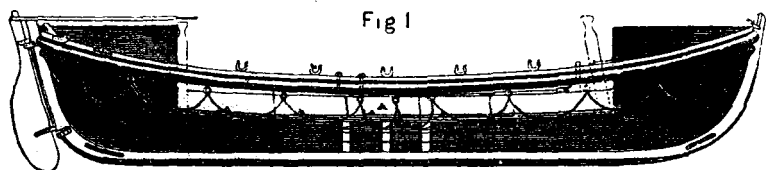

PROFILE

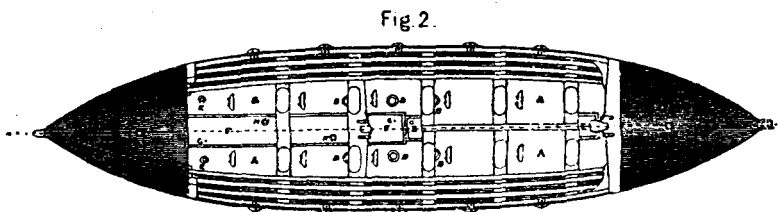

DECK PLAN.

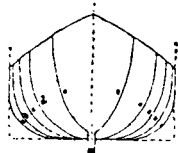

BODY PLAN

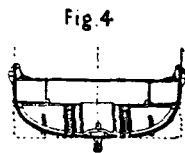

MIDSHIP SECTION.

This Life-boat possesses in the highest degree all the qualities which it is desirable that a Life-boat should possess:—

1. Great lateral stability, or resistance to upsetting.
2. Speed against a heavy sea.
3. Facility for launching and taking the shore.
4. Immediate self-discharge of any water breaking into her.
5. The important advantage of self-righting if upset.
6. Strength.
7. Stowage room for a large number of passengers.

THE LIFE-BOAT TRANSPORTING-CARRIAGE.

The Life-boat transporting-carriage is a very important auxiliary to the boat. Nearly every Life-boat, except a few of the larger size, is provided with a carriage, on which she is kept in the boat-house ready for immediate transportation to the most favourable position for launching to a wreck. A Life-boat is thus made available for a greater extent of coast than she otherwise would be; and even when launched from abreast of the boat-house, she can generally be much quicker conveyed to the water's edge than without a carriage. In addition to this ordinary use, a carriage is is of immense service in launching a boat from a beach; indeed, to such an extent is

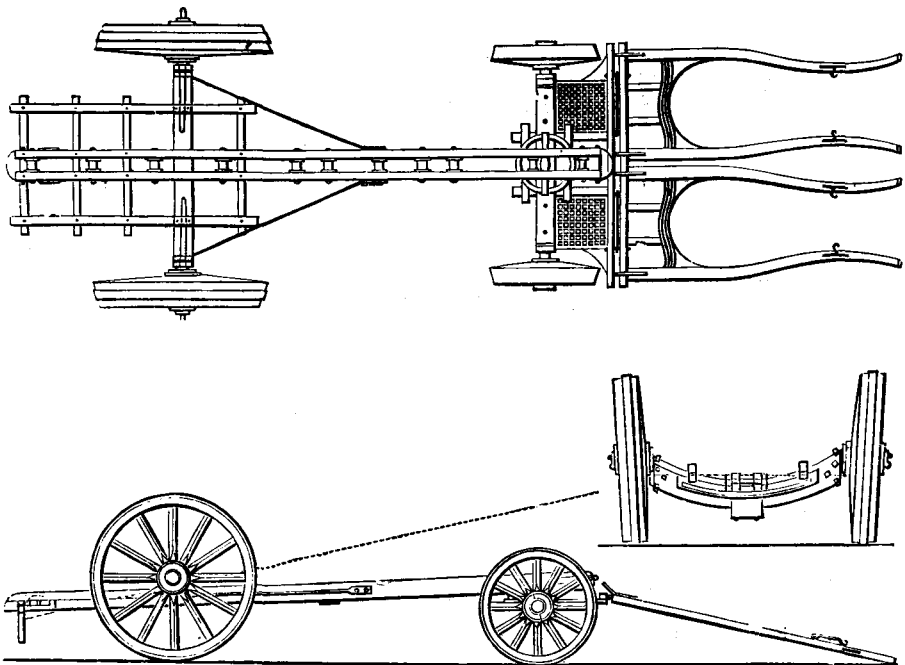

this the case, that a boat can be readily launched from a carriage in a high surf, when without one it would often be very difficult to do so.

The carriage consists of a fore and main body. The latter is formed of a keelway, and of bilgeways attached to it, and resting on the main axle, the boat's weight being entirely on the rollers of the keelway. Its leading characteristics are that while for launching it forms an inclined plane, down which the boat can be launched off the rear end with considerable impetus, it can also be used for replacing the boat, the inclined plane being reversed by removing the fore-carriage.

A very full equipment of stores is supplied to the Life-boats of the Institution—such as cork life-belts, anchors and cables, grapnels and lines, life-buoys, lanterns, rockets, and many other articles, together with portable or launching-skids.

THE LIFE-BOAT HOUSE.



The boats of the NATIONAL LIFE-BOAT INSTITUTION, and all belonging to them, are kept in roomy and substantial boat-houses, under lock and key, in charge of paid coxswains, under the general superintendence of local honorary committees of residents in the several localities. Each boat has its appointed coxswain at a salary of 8*l.*, and an assistant at 2*l.* a year, with further allowances under special circumstances. The crew consists, in addition, of a bowman, who is paid 30*s.* a year, and as many boatmen as the boat pulls oars. A signalman is also appointed who receives a retaining fee of 1*l.* per annum, and payment as a helper each time he is on duty. The members of the volunteer crews are registered and, wherever practicable, at least double the number of men required are entered on the register. Such men are mostly resident boatmen, fishermen or Coastguardmen. On every occasion of going afloat to save life, the coxswains and each of the crew receive alike from the funds of the Institution (whether successful or not) 10*s.*, if by day, and 1*l.*, if by night; and usually 4*s.* each for every time of going afloat for exercise. These payments are increased by *one half* during the six months of each year beginning the 1st October, and ending the 31st March.

A reward of 7*s.* is given to the man who first brings intelligence of a wreck in such a position as not to be in sight of a Coastguard man on duty or other responsible look-out man.

A flag hoisted by day, and the firing of a carronade (or other alarm signal) by night, are the well-known signals for calling the crew together.

On boarding wrecks, the preservation of life is the sole consideration. Should any goods or merchandise be brought into the Life-boat, contrary to the coxswain's remonstrance, he is authorised to throw them overboard.

The approximate cost of a Life-boat Station is 1,050*l.*, and is made up as follows:—

Life-boat and her equipment, including Life-belts for the Crew,	
Skids, and Transporting-carriage for the Life-boat	£700
Boat-house, minimum cost (Slipway extra)	350
Total	£1,050

It is often necessary to provide a Slipway for launching purposes, which costs from 200*l.* to 1,000*l.*, or even more. The Annual Expense of maintaining a Life-boat Station is about 100*l.*

Such is a brief summary of the chief of the Regulations under which the Life-boats are worked. How faithfully and with what result they are carried out let the journals of each Life-boat Station and the annals of the Institution tell.

The NATIONAL LIFE-BOAT INSTITUTION has now 298 Life-boats under its charge. Nearly all of these have been specially presented to it, and they save every year hundreds of shipwrecked sailors. Altogether, the Institution has granted rewards for the saving of 39,815 lives, either by its Life-boats or by other means.

Despite, however, this fleet of 298 Life-boats, and of 16 others locally provided or otherwise supported, and despite the numerous rocket apparatus stations on our coast, there remains the melancholy fact that on an average 600 lives are lost annually on or near the coasts of the United Kingdom alone, as shown by the Board of Trade Returns, proclaiming solemnly, though silently, that, for humanity's sake, and for the national credit, no exertions should be spared in providing every possible means for the conveyance of succour to the shipwrecked.

The Institution needs an income of at least 70,000*l.* to maintain its great Life-saving Fleet; and the Committee feel assured that it will never lack it so long as it maintains its boats in the state of thorough efficiency that they are in at the present time, and manned as they are on every emergency by as fearless and noble a class of men as ever Nelson or Collingwood led to battle to uphold our country's honour and glory.

ANNUAL SUBSCRIPTIONS AND DONATIONS

FROM 1st JANUARY TO 31st DECEMBER, 1896.

HER MOST GRACIOUS MAJESTY THE QUEEN, Annual Subscription, £50.

	Ann. Subs.		Donations.			Ann. Subs.		Donations.	
	£.	s. d.	£.	s. d.		£.	s. d.	£.	s. d.
A. B. C. (1889-96, £38 10s.)			5	-	Brought forward	112	15	6	2053 16 -
A. G. H.	1	1 -			Amphlett, Miss E. F.	1	1 -		
A. H. D.			5	5 -	"An Admiral's Sister"	3	-	-	
A Friend			5	-	Anderdon, Miss Maria	2	-	-	
A Friend (1888-96, £75)			10	-	Anderson & Co., Messrs. J. W.	1	1 -	-	
A Friend at Boston			1	-	Anderson, F. H., Esq., M.D.	1	1 -	-	
A Friend at Hyères			5	-	Anderson, J. W., Esq.	2	-	-	
A Friend at Quebec (1893-6, £20)			10	-	Anderson, R. H., Esq.	1	-	-	
A Friend at North Berwick (1894-6, £3 2s.)			1	1 -	Anderson, Mrs. (1887-96, £15 7s.)			2	- -
A Friend at North Berwick	1	1 -			Anderson, The Misses, "In memory of their brother, R.A."	1	1 -		
A Friend to the Cause			1	-	Andrews, Mrs.	1	1 -		
A Lady	2	- -			Annfield Plain Co-operative Society, Limited	3	-	-	
A Shipowner, Greenock	2	- -			Anonymous			1	- -
Abell, H. Frank, Esq.	2	2 -			Anonymous	1	1 -		
Abercorn, His Grace the Duke of, K.G.			5	5 -	Anonymous			-	7 -
Ackers, Mrs.	5	- -			Anonymous (Birmingham)			-	10 6
Ackland, J. F. Esq.	-	10 6			Ansell, Mankiewiez and Tallerman, Messrs.	5	5 -		
Acland, Capt. W. A. D., R.N.	2	2 -			Argles, Thos. A., Esq.	2	2 -		
"A contribution from Manchester" (anonymous)			2000	- -	Arkwright, Miss S. M.	1	1 -		
Adam, Messrs. John and James, and Co.	1	1 -			Arkwright, F. C., Esq., J.P.	1	1 -		
Adams, A., Esq.	-	10 -			Armitage, E., Esq., R.A.	1	1 -		
Adams, E. T., Esq.	1	1 -			Armourers & Brasiers, Workshipful Company (1870-96, £252)			10	10 -
Adams & Co., Messrs. R.	1	1 -			Armstrong, The Rt. Hon. Lord, C.B.	1	1 -		
Adams, W. J., Esq.	1	1 -			Arnison, Mrs. (1892-6, £2)			1	- -
Adamson, S., Esq.	1	1 -			Arnott, Mrs.	3	3 -		
Agerup, Petersen & Co., Messrs.	1	- -			Ashby, Mrs. James	-	10 6		
Agius, Ed. T., Esq.	1	1 -			Ashington Co-op. Soc., Ltd.			2	2 -
Aglionby, Colonel	1	- -			Ashmole, Wm., Esq.	1	1 -		
Aglionby, Miss C. M.	-	10 -			Ashton, Robt., Esq.	5	-	-	
Ailsa, The Most Hon. the Marquis of	5	- -			Aste and Sons, Messrs. J.	1	1 -		
Albright, W. A., Esq. (1888-96, £16 ls.)			5	- -	Astley, Miss C. C.	2	-	-	
Aldenham of Aldenham, The Right Hon. Lord	2	2 -			"A Thank-offering for many journeying mercies by land and by sea"—(anonymous)			10	- -
Alexander & Co., Messrs. Jno.	-	10 -			Atkinson and Co., Messrs.	1	1 -		
Alexander, The Misses	1	- -			Atkinson, John, Esq. (1893-6, £55)			10	- -
Allan, Miss, Sydenham	1	1 -			Atkinson, J. B., Esq.			-	10 -
Allen, A. J., Esq.	1	1 -			Atkinson, Mrs. Bradford	1	1 -		
Allen Bros. & Co., Messrs.	1	1 -			Atkinson, Mrs. E.	5	-	-	
Allen, Francis, Esq.	10	- -			Atkinson, W., Esq.	1	1 -		
Allen, J. E., Esq.	2	2 -			Auerbach, Emil, Esq.	1	1 -		
Allen, J. W., Esq.	2	2 -			Austen, A., Esq.	-	10 6		
Allen, Miss J. C.	1	- -			Austen, Mrs. G. Powell	1	-	-	10 -
Allen, Rev. Canon J., D.D.	1	1 -			Austin, F., Esq. (1880-96, £45)			5	- -
Alloa Co-operative Society, Limited	5	- -			Austin, Mrs. H. N.	1	-	-	
"A Lover of the Sea"			-	5 -	Ayling, E. J., Esq.	-	10 6		
Alrutz & Co., Messrs.	1	1 -			Aylmer, Major-Gen. H. (1884-96, £13 13s.)			1	1 -
Alsop, Mrs. (for 1897)	1	- -							
"Amice"	-	10 -							
Amos, Mrs. Herbert	2	2 -							

Carried forward . £112 15 6 2053 16 -

Carried forward . £166 13 - 2098 6 6

	Ann. Subs.		Donations.			Ann. Subs.		Donations.				
	£.	s. d.	£.	s. d.		£.	s. d.	£.	s. d.			
Brought forward	166	13	-	2098	6	236	3	6	2203	2	8	
B. H. C. (1872-96, £250)				10	-							
Backhouse, James E., Esq.	5	-	-									
Bacup Co-operative Store Limited	10	-	-									
Badley, Mrs. Laura E.	2	2	-									
Bagot, Walter, Esq.	1	1	-									
Bailey, Arthur, Esq.	2	-	-									
Bailey, E. H., Esq.	1	1	-									
Baillie, Mrs. E. F.	1	1	-									
Baily, Miss A. L.	1	1	-									
Baker, A. W. W., Esq., M.D. (1887-96, £27 8s.)				1	1							
Baker, John, Esq.	1	-	-									
Baker, Mrs. John	-	10	-									
Baker, Mrs., Kottayam	1	-	-									
Baker, Rev. Sir T. H. B., Bart. <i>Ballaarat</i> , s.s., collected on board, per Capt. Angus				18	18	2						
Balston, Mrs.				10	10	-						
Banbury Co-operative Industrial Society, Ltd. (1895-6, £4 4s.)				2	2	-						
Bancroft, S. B., Esq.	2	2	-									
Bankes, Mrs. Scott	1	1	-									
Banks, Dr. J. and Family (1888-96, £10 2s.)				2	-	-						
Barber and Co., Messrs. J.	1	1	-									
Barclay and Sons, Messrs., Limited (Ann. Sub. £1 1s., paid in 1897).												
Barclay, Hanbury, Esq.	1	1	-									
Barker, The Misses	5	-	-									
Barkworth & Spaldin, Messrs.	1	1	-									
Barlow - Massicks, Thomas, Esq., J.P. (for 1895)				-	10	6						
Barnston, Miss				3	-	-						
Barnard, Miss A. C.	1	1	-									
Barnett Bros., Messrs.	2	2	-									
Barningham, Thomas, Esq.	10	-	-									
Barrett, Messrs. R. & Son, Limited	1	1	-									
Barrow, Miss	-	10	6									
Barry, J. H., Esq. (1891-6, £15 5s.)				5	-	-						
Barton, Bertram F., Esq.	2	2	-									
Ditto (1891-6, £61).				21	-	-						
Barton, Charles, Esq. (1890-6, £1)				-	5	-						
Barton, Mrs. T. M.				1	-	-						
Bartram, Rev. H., M.A. (Ann. Sub. £1 1s., paid in 1897).												
Bastard, T. Horlock, Esq.	1	-	-									
Batey, Chas. J. H., Esq.	1	1	-									
Batho, the late Wm., Esq., Surgeon, "In Memoriam," per Mrs. Batho	1	1	-									
Bathurst, The Right Hon. The Earl	2	-	-									
Batten, Messrs. J. & I. & Co.	1	1	-									
Battersea Chapel Sunday School Benevolent Society	1	1	-									
Bathyan-Strattmann, The Prince	1	1	-									
Baucher, W., Esq.	-	10	6									
Baxendale, J. W., Esq.	1	1	-									
Bayley and Ridley, Messrs.	1	1	-									
Baylis, T. C., Esq.	2	2	-									
Baynes, General R. S.	1	1	-									
Beauchamp, The Hon. Lady (in aid of <i>Beauchamp</i> Life-boat at Caister) (1895-6, £50)				30	-	-						
Beattie, Miss S.				5	-	-						
Beaumont, G., Jun., Esq.	1	1	-									
Beaumont, Mrs.	-	10	6									
Beckett, Rev. W. P., B.A.	-	5	-									
Beckh, W. W., Esq.												
Beckh, Mrs. W. W.	-	10	6									
Beddoes, Miss A. F. E.	2	-	-									
Bedford, Henry, Esq.	1	1	-									
Bedford, Her Grace the Duchess of	-	10	-									
Bedlington Industrial Co-operative Society, Limited				2	2	-						
Beeston, Miss (1891-6, £10)				2	-	-						
Begbie, Ross & Gibson, Messrs.	1	1	-									
Belfield, A. B., Esq.	1	-	-									
Belhaven and Stenton, the Right Hon. Lord												
Bell, Messrs. Alexander, & Co.	1	1	-									
Bell, Mrs. Mary	1	1	-									
Bell, Robert, Esq. (1883-96, £65)												
Bellas, Messrs. Hugh and Thos.				1	-	-						
Belsham, Mr. J.	-	10	-									
Bembridge, S.S., collected by dog, per Mr. W. Butler												
Benetfink & Co., Messrs.	1	1	-									
Bennett, Mrs. G. M. (1893-6, £1 5s. 6d.)												
Bennett, T. Wheeler, Esq.	1	1	-									
Bennets, Miss Olympia (1864-96, £105)												
Bentwitch, Herbert, Esq., LL.D.	1	1	-									
Berger, Mrs. (1895-6, £55)												
Berman's Charity, Trustees (1872-96, £252)												
Bernard, Mrs. (1888-96, £7 2s.)												
Berry, Barclay & Co., Messrs.	1	1	-									
Bettell, Wm., Esq. (1874-96, £51 9s.)												
Bianca, barque, collected by Capt. J. Reid from several of the crew												
Bibby, Col. August												
Bickerstaff, Wm. Martin, Esq.	1	1	-									
Bieber and Co., Messrs.												
Bingley Industrial Co-operative Society, Limited												
Birch, J. W., Esq.	1	1	-									
Birch-Reynardson, Rev. J., M.A.												
Birchall, J. Dearman, Esq.	1	1	-									
Bird, Stanley G., Esq.	1	1	-									
Birkbeck, Sir Edward, Bart, V.P., Chairman (1861-96, £1,401 9s.)												
Birkbeck, Henry, Esq.												
Birkbeck, Robert, Esq.	3	3	-									
Birmingham Industrial Co-operative Society, Limited												
Birt, Messrs. J. & A. W.	4	4	-									
Bischoff & Sons, Messrs. Jas.	1	1	-									
Bischoff, Thos. W., Esq.	1	1	-									
Black, Mrs. Alexander (1886-96, £100, in addition to gift of Life-boat).												
Blackburne, Col. Wm.	1	1	-									
Blackwell, Samuel J., Esq.	2	2	-									
Blake, T. N., Esq.												
Blakiston, John R., Esq.	1	-	-									
Blakiston, M., Esq.	2	-	-									
Carried forward	£236	3	6	2203	2	8	£282	15	6	2401	15	2

	Ann. Subs.		Donations.			Ann. Subs.		Donations.	
	£.	s. d.	£.	s. d.		£.	s. d.	£.	s. d.
Brought forward	282	15 6	2401	15 2	Brought forward	356	19 6	2439	11 2
Blatch, H., Esq.	2	-			Brown, Miss	2	-		
Blathwayt, Mrs. C. W.	2	2	3	3	Brown, Miss A. M.	-	10	-	
Blaxland, Captain J. E., R.N. (1891-6, £7)			-	10	Brown, Miss E.	1	-	-	
Blenkinsop, B., Esq.	1	1	-	-	Brown, Miss Gilpin	1	1	-	
Blewitt, Mrs. (1889-96, £5)			-	10	Brown, Mrs. G. Herbert	1	-	-	
Block, Capt. A. H., R.A., collected on board ship			2	-	Brown, Mrs. W. A.	-	10	-	
Blyth, Mrs.	-	5	-	-	Brown & Hart, Messrs.	-	10	-	
Boadicea Ship Company, Limited (1890-6, £6 6s.)			1	1	Brown, Shipley, & Co., Messrs.	3	3	-	
Bonus, S., Esq.	1	-	-	-	Brown, The Misses	1	-	-	
Boord, Mrs. Joseph	1	1	-	-	Brown, William, Esq.	1	1	-	
Borthwick, Miss			2	-	Browne, Capt. Paul (for 1897)	-	10	6	
Borwick, Alfred, Esq.	1	1	-	-	Browne, G. B., Esq.	2	2	-	
Boston, collected from seamen, per Messrs. Ridlington Boston Shipwreck Association (1865-96, £160)			-	12	Browne, J. W., Esq.	5	5	-	
Ditto	5	-	-	-	Browne, Miss C.			-	5
Bott, Major Thos.	10	-	-	-	Browne, Mrs. H.	1	-	-	
Boulton, Babington, Esq.	1	1	-	-	Bruce, The Hon. Sir G.	1	1	-	
Boulton, M. Ernest, Esq.	2	2	-	-	Brumell, Mrs. M. E.	1	1	-	
Bourne, John K., Esq.	1	-	-	-	Brushfield, Mr. Richard	-	10	6	
Bouts, T., Esq.	1	1	-	-	Bryson, Mrs. W. H.	-	5	-	
Bouverie, Miss A. P.	2	-	-	-	Buchan, Miss Fordyce	2	2	-	
Bovill & Sons, Messrs. B.	1	1	-	-	Buchanan, Mrs.	1	-	-	
Bowden, Mrs.	2	-	-	-	Buck and Wootton, Messrs.	2	2	-	
Bowker, F. Esq. (1895-6, £10 10s.)			5	5	Buckingham, Miss S. C. (1868-96, £59 14s.)			1	-
Bowles, H. C. B., Esq.	2	2	-	-	Buckland, Mrs.	2	-	-	
Bowling-Trevanion, Henry P., Esq.	2	2	-	-	Buckle, Vice-Admiral C. M.	1	-	-	
Bowyer, G. T., Esq.	-	10	-	-	Buckle, Rev. John, M.A.	1	1	-	
Bowyer, W., Esq.	1	1	-	-	Buckton, G. B., Esq.	1	1	-	
Boyd, Alfred, Esq.	1	1	-	-	Budge, Rev. H. S., B.A.	1	1	-	
Ditto (1883-96, £14 4s.)			1	1	Bulkeley, Miss, the late (1866-96, £455)			20	-
Boyd, Miss E. J. (1885-96, £30)			5	-	Bullard, King, & Co., Messrs.	2	2	-	
Boys, Rear Adml. H. H.	1	1	-	-	Bullock, Messrs. J. & G., & Co.	3	3	-	
Braden, Chas. Esq.	1	1	-	-	Bulman, A. R., Esq. (Ann. Sub. £5 5s., paid in 1895).			2	2
Bradford, Mrs. H. W.	1	1	-	-	Bulmer, Mrs. Mary A.	2	2	-	
Bradford, Mrs. J. E.	1	1	-	-	Bunting, Mrs.	1	1	-	
Bradley, Lt.-Col. J. D. (1882-96, £12 10s.)			2	10	Burbidge, Pritchard, and Bartleet, Messrs.	1	1	-	
Braithwaite, Mrs. Lucas	1	1	-	-	Burden, Stephen, Esq.	1	-	-	
Bramly, W. J., Esq.	1	-	-	-	Burgess, Miss	-	10	-	
Brankston, W. A., Esq.			5	-	Burke, Miss M. A.	2	2	-	
Brassey, The Rt. Hon. Lord, K.C.B.	5	5	-	-	Burkitt, Rev. J., M.A.	-	5	-	
Brayne, Charles S., Esq.	-	10	-	-	Burmester, Miss	1	1	-	
Brecks, Mrs.	1	1	-	-	Burnell, W. A., Esq.	2	2	-	
Brettell, W. H., Esq.	1	1	-	-	Burnell, The Misses (1892-6, £12 10s.)			3	-
Bridges, Miss	1	-	-	-	Burnett, Miss F. E.	1	1	-	
Bridson, Josh., Esq.	2	-	-	-	Burnley Central Working Men's Club, G.U.O.O.F. (1892-6, £31 10s.)			5	5
Brien, F., Esq.	2	2	-	-	Burnopfield District Co-operative Society, Ltd. (1895-6, £4 4s.)			2	2
Brightside and Carbrook Co-operative Society, Limited (1895-6, £4 4s.)			2	2	Burrell, H., Esq.	1	1	-	
Bristol, The Most Hon. The Marquis of	2	2	-	-	Burrows, Miss, "In memory of John Burrows, for many years resident at Redcar"			1000	-
British Ship Owners' Co., Limited	2	2	-	-	Burrows, The late Canon, In memory of, per C. R. M.	1	-	-	
Broadmead, Miss (1893-6, £4 1s.)			1	1	Burstall & Co., Messrs. J.	1	1	-	
Brock, Mrs. Osmond de Beauvoir	2	2	-	-	Burton, Rev. R. C., M.A.	-	5	-	
Brocklehurst, W. W., Esq.	5	-	-	-	Bury District Co-operative Provision Society, Ltd. (1895-6, £30)			10	-
Brook, Mrs. Mary	1	1	-	-	Bushby, Mr. James			-	5
Brooke, John T., Esq.	1	1	-	-	Busk, Miss A. F. (1892-6, £15)			5	-
Brookman, Herbert, Esq. (1894-6, £2 2s.)			1	1	Butler, C., Esq.	-	10	-	
Brown, G. W., Esq.	1	1	-	-	Butlin, C., Esq.	1	1	-	
					Buttanshaw, Major	1	1	-	
					Byles, M. Bernard, Esq.	2	2	-	
					Byng, Adml. J. C., the late	1	1	-	
Carried forward	£356	19 6	2439	11 2	Carried forward	£418	8 6	3486	8 2

	Ann. Subs.			Donations.				Ann. Subs.			Donations.			
	£.	s.	d.	£.	s.	d.		£.	s.	d.	£.	s.	d.	
Brought forward	418	8	6	3486	8	2		Brought forward	486	6	6	3561	7	2
C. E. L. (Mr.) (1893-6, £42)				10	10	-		Cheetham, H., Esq.	1	1	-			
C. E. L. (Mrs.) (1891-6, £165)				25	-	-		Chester, C., Esq.	5	-	-			
C. H. B. (1890-6, £46)				10	-	-		Chester, Miss I.	2	-	-			
C. H. W.				-	10	-		Chetwynd, The Viscount	1	1	-			
C. & H. T.	2	2	-					Child and Co., Messrs.	2	2	-			
C. M. B.	2	-	-					Child, J. A. E., Esq.	1	1	-			
C. S. A. (1888-96, £42)				5	5	-		Child, Rev. T. H. I.				5	-	-
Cadenhead, Mrs. (for 1897)	-	10	-					Childers, Rt. Hon. H. C. E., The late	1	1	-			
Campbell, Mrs. M. G. (1895-6, £1 10s.)				-	10	-		Chippindale, Miss	1	1	-			
Campbell, Mrs. Emma R.	1	1	-					Christian, Readers of the, per Messrs. Morgan & Scott				10	6	-
Camperdown, s.s.	1	1	-					Christian World, Readers of the, per Messrs. Clarke & Co. Christie, Alexr., Esq.						
Candler, P. W., Esq.	2	-	-					Christopherson, Rev. A., M.A. Christy & Co., Limited Messrs.	1	1	-			
Cantlon, M., Esq. (1891-6, £13 13s.)				2	2	-		Church, F., Esq.	1	1	-			
Capel, Frank C., Esq.	5	5	-					Church and Son, Messrs.	-	10	-			
Caradoc Ship Co., Limited (1893-6, £4 4s.)				1	1	-		Clark, Bach & Co., Messrs.	1	1	-			
Carbutt and Co., Messrs.	1	1	-					Clark, C. S. Gordon, Esq.	1	1	-			
Carew, Col. R. Pole	1	-	-					Clark, Godfrey L., Esq. (1888- 96, £35)				10	-	-
Carlingford, The Right Hon. Lord	2	-	-					Clark, Miss E. L.	1	1	-			
Carlisle, The Right Hon. the Earl of	2	-	-					Clark, Mrs. Le Gros	1	-	-			
Caro, Messrs. H. & E.				-	15	-		Clarke & Co., Messrs. Ste- phenson	2	2	-			
Carpenter, Capt. Edwin, H.C.S.				1	1	-		Ditto (1888-96, £47 5s.)				5	5	-
Carpenters, The Worshipful Company of	10	10	-					Clarke, A. Gordon, Esq.	1	1	-			
Carr, W. I., Esq.	1	1	-					Clarke, Arthur Leslie, Esq.				2	2	-
Carstairs, Mrs. (1894-6, £2)				1	-	-		Clarke, Mrs. Cowden	1	1	-			
Carter, Paterson, & Co., Limited, Messrs.	1	1	-					Clarke, Miss	2	-	-			
Carter, Surgeon-Major Fredk. Cartwright, Capt. H. A.	5	-	-					Clarke, R. Stanley, Esq.	2	2	-			
Cartwright, Mrs.	1	1	-					Clarke, T. W. R., Esq.	-	10	-			
Castellain, Alfred, Esq. (1894-6, £5 5s.)				2	2	-		Clarke, W. G. & Sons, Messrs. (for 1896-7)	1	1	-			
Castleford Co-operative In- dustrial Society, Limited	2	2	-					Claudius & Chattaway, Messrs. Claypath Co-operative So- ciety, Limited (1895-6, £10) Clayton, Colonel Fitz-Roy, Deputy Chairman	-	10	-			
Causton, Sir J., & Sons	1	1	-					Clayton, C. H., Esq.	1	1	-			
Cave, L. T., Esq.	5	-	-					Clayton, F. S., Esq.	1	1	-			
Cave, Adm. J. Halliday, C.B. Cave-Browne-Cave, Mrs. Ed- ward F.	2	2	-					Clayton, Sir W. R., Bart.	1	1	-			
Cavell, John E., Esq.	1	1	-					Cleator Moor Co-operative Society, Limited				3	3	-
Cayley, H., Esq. (1883-96, £8 4s. 6d.)				1	1	-		Clegram, Mrs. W. B.	1	1	-			
Chads, Admiral Sir H., K.C.B.	1	-	-					Clerk, Major-Gen. H., R.A.	1	1	-			
Chadwick, Mrs.	1	1	-					Clerke, Chas. L., Esq. (1882- 96, £44)				3	-	-
Chalk, Mrs. (1883-96, £14 14s.)				2	2	-		Clermont, Lady	1	1	-			
Chamberlain, R., Esq.	1	1	-					Clive, Lieut.-Col. G. W.				5	-	-
Chamberlain, Major Tanker- ville J.	1	-	-					Clive, Mrs. A. S.	5	-	-			
Chamberlain, Pole & Co., Messrs.				1	1	-		Cloid, Routledge & Co., Messrs. Clough, C. T., Esq.	2	2	-			
Champion, F. C., Esq.	1	1	-					Clowes & Sons, Messrs. W., Limited				5	5	-
Chaplin, Edw., Esq. (1867-96, £62 15s.)				5	5	-		Coal Factors' Society	5	5	-			
Charlaw and Sacriston Col- lieries Company, Limited	2	2	-					Coal Merchants' Society of London	5	5	-			
Charles, R. S., Esq.				1	1	-		Coatbridge Co-operative Society, Ltd. (1895-6, £4) Coates, Joseph, Esq.				2	2	-
Charley, Mrs.				1	10	-		Coats, George, Esq. (1892-6, £15)						
Charrington, Miss M.	2	-	-					Cobb, James F., Esq.	-	10	6			
Charteris, Lady Margaret	2	2	-					Cobb, Mrs.	1	1	-			
Chatham and District Friendly Societies' Sports Committee Chatterton, John H., Esq.				1	1	-		Cobbold, Felix T., Esq.	3	3	-			
Chatterton, Mrs.	-	10	-					Cock, Miss F.	1	-	-			
Chavasse, Miss M. C.	1	1	-					Cockburn, Rev. J. Scott	-	10	6			
Chawner, Miss, Lyndhurst (1893-6, £4 4s.)				1	1	-		Cockey, E., Esq.	-	10	6			
Carried forward	£486	6	6	3561	7	2		Codrington, Major.	10	-	-			
								Carried forward	£579	-	-	3616	3	8

	Ann. Subs. Donations.			
	£.	s.	d.	£. s. d.
Brought forward	579	-	-	3616 3 8
Colchester and East Essex Co-operative and Industrial Society, Limited	2	2	-	
Coldicott, Henry, Esq.	-	10	6	
Cole, A. C., Esq.	1	1	-	
Coleman, Capt. G.	1	1	-	
Coleman, Rev. W.	-	10	-	
Coles, Alfred H., Esq. (for 1895-6)	10	-	-	
Collet, Sir M. W., Bart.	1	1	-	
Collier, Messrs. F. H. & A.	1	1	-	
Collin, Mrs. J.	1	1	-	
Collingwood, Miss M. A.	1	1	-	
Colman, Messrs. J. & J.	-	10	6	
Colnaghi, Sir D. E. (1892-6, £5)			1 - -	
Colne and District Co-operative Society, Limited (1st instalment) (1895-6, £6 6s.)		5	5 -	
Colonial Company, The, Limited	2	2	-	
Colossus, H.M.S. Ward Room Collection, per Rev. O. R. Hughes, R.N., M.A.		1	- -	
Colvill, Lieut.-Col. Thos. H. (1873-96, £8 10s.)			- 10 -	
Colville, The Right Hon. Lord, K.T.	2	2	-	
Colville, Capt. The Hon. Cecil, R.N., C.B.	4	-	-	
Commercial Steamship Company, The	5	5	-	
Comptoir National d'Escompte de Paris	3	3	-	
Compton, H., Esq.	1	1	-	
Connah's Quay, proceeds of "Maenor Welsh Costume Choirs" Concert		6	12 -	
Connorton & Co., Messrs.	1	1	-	
"Continental Daily Parcels Express"	1	1	-	
Coode, R. C., Esq.	5	-	-	
Cook, Masters Arthur and George, collected by			- 10 -	
Cook, Mrs. E. R.	2	2	-	
Cook, W. F., Esq.	3	3	-	
Cooke, Mrs. E. M. (1891-96, £12 2s.)		2	2 -	
Cooper, Mrs. T. E.	1	1	-	
Cooper, Mrs. S. M.	1	-	-	
Cooper, Miss	1	1	-	
Coote, Thomas, Esq.	1	1	-	
Copleston, Rev. W. C., M.A.	-	5	-	
Corbett, J., Esq.	2	2	-	
Corder & Haycraft, Messrs.	-	10	6	
Corkran, Colonel Seymour	5	-	-	
Cornell, Geo., Esq.	1	1	-	
Cornish-Bowden, Admiral W.	2	2	-	
Corrie, A. J., Esq.	3	3	-	
Corrie, Miss E.	2	2	-	
Corrie, Rev. E. S., M.A., "In memory of E. B. C."	-	10	-	
Corscaden, Mrs.	5	5	-	
Cotesworth, W., Esq.	1	1	-	
Courtenay, Miss (1880-96, £130)			10 - -	
Courthope, Mrs. G. C.	1	-	-	
Ditto, in aid of Sussex Life-boats	1	-	-	
Courtney, Mrs.	1	1	-	
Coutts and Co., Messrs.	10	-	-	
Carried forward	£669	4	6	3643 2 8

	Ann. Subs. Donations.			
	£.	s.	d.	£. s. d.
Brought forward	669	4	6	3643 2 8
Coventry, Sheppard & Co.	-	10	6	
Coventry Perseverance Co-operative Society, Ltd. (1895-6, £4 4s.)			2 2 -	
Cowan, Mrs.	1	-	-	
Cowburn, A. D., Esq., for East Coast Stations (1894-6, £26 5s.)		10	10 -	
Cowes Regatta, collected by Miss Frances H. Loyd and Capt. Burridge			8 17 8	
Cox and Co., Messrs.	5	5	-	
Cox, Miss M. A.	2	2	-	
Craig & Co., Messrs. R. H.	1	1	-	
Cramlington District Co-operative Society, Limited	2	2	-	
Cranfield, Wm., Esq.	1	1	-	
Craven, Miss S.	-	5	-	
Crawford, R. D., Esq.	1	1	-	
Crawford, J. Bruce, Esq.			1 1 -	
Crees, Mr. and Mrs. Henry (1889-96, £6 3s.)			1 1 -	
Crewe's Trustees, Lord	30	-	-	
Croft, Mrs. L.	2	2	-	
Crofton, Capt. and Mrs. Duke	1	-	-	
Crompton, H., Esq.	-	10	-	
Cronbach & Co., Messrs.	-	10	6	
Crook, W. J., Esq.	-	5	-	
Crookes, Alf., Esq.	1	1	-	
Crosbie, Rev. Howard A., M.A.	2	2	-	
Crosse, Mrs. St. Croix	1	1	-	
Crosse & Blackwell, Ltd.	5	5	-	
Croxall, Mrs. Tongue	2	2	-	
Cruddas, Charles J., Esq.	1	1	-	
Cruddas, W. D., Esq.	1	1	-	
Cullingford, W. H., Esq.	2	2	-	
Cullingworth, J. D., Esq.	1	-	-	
Cunninghame, Rev. H. C. R.	1	1	-	
Curling, Miss, in addition to gift of two Life-boats (1874-93, £100)		5	- -	
Currey, C. Herbert, Esq.	2	2	-	
Currie, Mrs. (1893-6, £15)			5 - -	
Curtis, Whitworth, and Co., Messrs.	1	1	-	
Cust, Lieut. Sir Chas. L., Bart., R.N.	2	-	-	
Cutler, Palmer & Co., Messrs. "Cypher"	1	-	-	
Czarnikow, C., Esq.	2	2	-	
D. J.	10	-	-	
D'Abreu, I. J., Esq. (1891-6, £24 4s.)			2 2 -	
Daggett, Mrs. S. J.	1	1	-	
Dallas, Sir Geo., Bt. (1873-96, £112)			5 - -	
Dalton-in-Furness Co-operative Socy., Ltd. (1895-6, £4 4s.)			2 2 -	
Dalton, H., Esq.	3	-	-	
Dalton, Mrs. H.	2	-	-	
Dalton, Miss	2	2	-	
Dand, J., Esq.	1	1	-	
Daniel, Mrs. Torrens	1	-	-	
Daniel, Major R. H.			- 10 -	
Danube, R.M.S., per Capt. Hicks, collection		12	1 6	
Ditto, Ditto, proceeds of Concert		20	- -	
Darling, Mrs. E.	1	1	-	
Carried forward	£772	7	6	3713 9 10

	Ann. Subs.		Donations.	
	£.	s. d.	£.	s. d.
Brought forward	772	7 6	3713	9 10
Darling, Mrs. S.	5	5 -		
Darnell, Messrs. W. & J. R.	1	1 -		
Darnley, The Right Hon. the Earl of	1	- -		
Darwen Industrial Co-operative Socy., Ltd.	2	2 -		
Daun, Mrs.	1	1 -		
Davey, Rev. Prebendary	-	10 -		
Davies-Colley, N., Esq.	1	1 -		
Davies, Miss		5 -		
Davis, Fredk., Esq.	1	1 -		
Davison, Newman, & Co.	1	1 -		
Davy, Yates, and Hicks, Messrs.	1	1 -		
Dawes, G. R., Esq.	1	1 -		
Dawson, Lt.-Col. F.	10	10 -		
Dawson-Scott, Major-General	1	1 -		
Day, Mrs. F.	1	- -		
Dean, Rosser S., Esq.	1	- -		
Debenham, Mrs. T. N. (1892-6, £25 5s.)			5	- -
De Chaville, Mrs. G. (1892-6, £4 4s.)			1	1 -
Deey, The Misses	1	- -		
De Kantzow, Admiral H.P.	1	1 -		
De Ros, General The Right Hon. Lord	1	1 -		
Delcomyn, Messrs. F. & A.	1	1 -		
Delmé-Radcliffe, Comr., R.N., and Mrs. F.	3	- -		
"Delta" (Ann. Subs. for 1893-7 of £10 10s., paid in 1893).				
Denison, Lady	5	- -		
Dennis, Mrs.	5	- -		
Denny, C., Esq.	1	1 -		
Denny, Messrs. C. & J.	1	1 -		
Denny, Mrs. (1889-96, £20).			4	- -
Denny & Sons, Messrs. T. R.	-	10 6		
Dent, T. W., Esq. (1888-96, £109).			10	10 -
De Saumarez, The Right Hon. Lord	5	- -		
Devey, Miss	5	- -		
Devitt and Hett, Messrs.	1	1 -		
Devizes College and High School			-	13 6
Dewar & Webb, Messrs.	1	1 -		
Dibdin, Charles, Esq.	1	1 -		
Dickinson, Rev. Fredk. B., M.A.	1	1 -		
Dickinson, Rev. Henry S., M.A.	2	- -		
Dickson, Mrs. W. R.	1	1 -		
Digby, Commander H. A., R.N.	5	- -		
Digby, Commander the Hon. G. F., R.N. (1894-6, £30)			10	- -
Dimsdale, J., Esq. (1889-96, £16 16s.)			2	2 -
Dinham & Co., Messrs. Charles	1	1 -		
Dixon, Capt. R. T., R.E.	5	- -		
Domville, Sir W., Bart.	2	2 -		
Don, R.M.S., Collected on board, per G. Ruthven Le Hunte, Esq.			3	- -
Douglas, Mrs. Robinson			3	- -
Dove, John, Esq.	-	5 -		
Dover River and Dist. Co-operative Society, Limited (1895-6, £4 4s.)			2	2 -
Carried forward	£852	16 -	3754	18 4

	Ann. Subs.		Donations.	
	£.	s. d.	£.	s. d.
Brought forward	852	16 -	3754	18 4
Downes, Edward Esq. (1895-6)	-	10 -		
Downes, Percy, Esq.		1 1 -		
Doxat, Miss C.	-	10 6		
Draeger, A., Esq.		2 2 -		
Draeger, G. F., Esq.		2 -		
Drew, Joseph, Esq.	1	1 -		
Droylsden Industrial Co-operative Society, Limited (1895-6, £4 4s.)			2	2 -
Drummond, Capt. Alfred M.	2	- -		
Drummond, Capt. C. G. A.	2	2 -		
Drummond, George J., Esq.	2	2 -		
Drummond, Messrs.	19	- -		
Dublin Port and Docks Board	75	- -		
Du Bois, The Misses	1	1 -		
Du Croz, F. A. Esq. (1882-96, £1093 10s.)			20	- -
Duff, Misses (1889-96, £15)			2	- -
Dugdale, J. B., Esq.	2	2 -		
Dugmore, Lieut.-Col. F. W.	1	1 -		
Duke of Argyll, collection, per Mr. A. D. Gange			1	2 -
Duncan, Mrs. C.	1	- -		
Duncan, Mrs. Hannah	2	2 -		
Dundas, Miss M. H. (1890-6, £4)			1	- -
Dundas, Wm., Esq. and Mrs. (1886-96, £24)			2	- -
Dunlop, The Misses	-	10 -		
Dunlop, W. W., Esq.	1	- -		
Dunn and Co., Messrs. W.	1	1 -		
Dunning, Mr. George B.	-	10 -		
Dunraven, The Right Hon. the Earl of	1	1 -		
Durrant, R.-Adml. F., C.M.G.	2	- -		
Dyer, John, Esq.	2	2 -		
Dyke, Col. Edwd. H.	1	1 -		
E.			5	- -
E. A. S. (1893-6, £2 10s.)			-	10 -
E. C. (Dublin).			-	5 -
E. C.	1	- -		
E. C. W. (1869-96, £21)			1	- -
E. H. E., "In memory of a beloved sister" (in aid of Life-boat Maintenance Fund)			1000	- -
E. L. (1894-6, £15)			5	- -
E. L. O.	2	2 -		
E. L. P. (1891-6, £27 17s.)			5	5 -
E. M. C.	5	- -		
E. P. (1890-6, £94 10s.)			21	- -
Eaden, J. F., Esq.	2	2 -		
Eaden, Mrs. Anne B.	1	1 -		
Eastwood, John F., Esq.	1	1 -		
Ecroyd and Sons, Messrs. Wm.	3	3 -		
Ecroyd, Miss	-	10 -		
Eddy, J. Ray, Esq.	5	- -		
Edgar, J., Esq.	1	- -		
Edwardes, T. D., Esq.	1	- -		
Edwards Brothers, Messrs.	-	10 6		
Egerton, Mrs. M. A. F.	5	- -		
Egremont Industrial Co-operative Socy., Ltd. (1895-6, £2 2s.)			1	1 -
Ekins, Mrs. P. J.	5	5 -		
Elder, Messrs. A. L., and Co.	1	1 -		
Elkins, Richard, Esq.	1	1 -		
Elliott, Wm., Esq.	1	1 -		
Ellis, Capt. F.	5	- -		
Carried forward	£1009	13 -	4822	3 4

	Ann. Subs. Donations.			
	£.	s.	d.	£. s. d.
Brought forward	1009	13	-	4822 3 4
Ellis, Henry, Esq.	1	1	-	
Ellis, Major C. D. C.	1	-	-	
Ellis, Mrs.	-	10	6	
Ellis, The Misses	1	-	-	
Ellison, F. B. Esq.				100 - -
Elsmore, Mrs.	1	-	-	
Elwes, Rev. E. L., M.A.	-	10	-	
Emery, William, Esq.	-	10	6	
England, Lieut.-Col. A. E.	1	-	-	
English, Lieut.-Col.	1	-	-	
Epps, Jas., Esq.,	1	1	-	
Epps, Jas., jun., Esq.	1	1	-	
Erskine, Miss L. C.	1	1	-	
Erskine, Sir Thos., Bart.	5	-	-	
Essington, Mrs.	2	2	-	
Ethelston, Lieut. A. P., R.N.	2	-	-	
Eustace, Chas. E., Esq.	3	-	-	
Evans, Miss Annis	1	1	-	
Evans, Joseph, Esq.	1	1	-	
Evans, Mrs. C. A.	2	-	-	
Evans, W., Esq.	1	1	-	
Evans, Wm. Esq. (1894-6, £4 2s.)				2 2 -
Everett, John, Esq.	2	2	-	
Ewart, Mrs.	5	-	-	
<i>Excellent</i> , H.M.S., collected from officers, per Rev. H. P. Dawson, R.N.				3 11 6
Eyre, G. F. Esq.				- 10 6
Eyre, Miss E.	-	5	-	
Eyre, Mrs. Robt.	-	10	6	
F. A. H. (1894-6, £2).				1 - -
F. A. M.				2 - -
F. E. G.	-	5	-	
F. G. D. (1889-96, £130 10s.)				10 - -
F. F. (1893-6, £37)				20 - -
Faber & Co., Messrs. A.	2	2	-	
Faber & Co., Messrs. J. V.	-	10	6	
Fair, J. W., Esq.	1	1	-	
Fairthorne, E., Esq.	2	2	-	
Fairthorne, Miss A.	1	1	-	
Fairthorne, Miss E.	1	1	-	
Falk, Victor, Esq.	1	1	-	
Falls, Miss A. E.	-	10	-	
Falmouth, The Right Hon. Lord Viscount	5	-	-	
Fane, Miss Blanche	1	-	-	2 - -
Fane, W. D., Esq.	2	2	-	
Fanshawe, Adm. Sir E. G., G.C.B.	5	5	-	
Fanshawe, Arthur A. Esq. (1891-6, £15)				5 - -
Farmer, Capt. Wm. R. G.	1	1	-	
Farncombe, Richard, Esq.	1	1	-	
Farnworth Co-operative Store (1895-6, £10 10s.)				5 5 -
Farrow, Miss M. (Ann. Sub. 6s., paid in 1895).				
Faversham Co-operative Industrial and Provident Society, Limited				2 2 -
Fawcett, Mrs. Walter	1	1	-	
Fearnside, Dr., the late	1	1	-	
Feeney, John, Esq.	1	1	-	
Fellows, Mrs. Horace	3	3	-	
Fellows, C. F., Esq.	5	-	-	
Fenn, Mrs.	2	-	-	
Fenwick, Admiral W. H.	1	1	-	
Fenwick, Capt. John	1	1	-	
Carried forward	£1086	1	-	4975 14 4

	Ann. Subs. Donations.			
	£.	s.	d.	£. s. d.
Brought forward	1086	1	-	4975 14 4
Fenwick & Sons, Messrs. John	5	5	-	
Ferguson, Mrs.	-	5	-	
Fernie, C. W. B., Esq. (1892-6, £9 4s.)				2 2 -
Ferraby, Miss A. (1892-6, £7 6s.)				2 2 -
Ferrier, Lieut.-Col., R.A. (1894-6, £3)				1 - -
Field, J. H. Esq. (1892-6, £12 2s.)				2 2 -
Field, J. P., Esq.	1	1	-	
Field, T. S., Esq., M.I.N.A., (1887-96, £21)				2 2 -
Fielden, Miss Sarah (1891-6, £60)				10 - -
Figgis, Samuel, Esq.	1	1	-	
Filliter, Freeland, Esq.	1	1	-	
Fincham, Miss E. J.	-	10	6	
Findlater, Gamble, and Co.	2	2	-	
Findlay, Mrs. James	1	1	-	
Finnis, Fisher, & Co., Messrs.	1	1	-	
Fisher, Miss Edith S.	2	2	-	
Fishguard and Rosslare Railways and Harbours Co.	5	5	-	
Fishmongers, Worshipful Company of (1873-96, £262 10s.)				105 - -
Flemming, S., Esq.	1	1	-	
Fletcher, H., Esq. (1892-6, £8 8s.)				2 2 -
Flexman, Joseph, Esq.	2	-	-	
Flood, Frederick, Esq.	5	5	-	
Foreman, Mr. Owen	-	10	-	
Foresters, Ancient Order of 140 Ditto, Court Victoria, No. 732				- 19 6
Ditto, Court Commonwealth, No. 8510				- 7 6
Ditto, Court Lumley				1 - -
Ditto, Court Pride of Devon, No. 3219	-	10	6	
Ditto, Court Pride of the Nile, No. 2772	-	5	-	
Forrest, Major-General, 11th Hussars	1	1	-	
Forster, G. B., Esq.	1	1	-	
Fortnum, Mason, and Co., Messrs.	2	2	-	
Foscolo, Mango, & Co., Messrs.	4	4	-	
Foster, Miss B.	-	10	-	5 -
Foster, Richard, Esq.	4	-	-	
Fowkes, Mrs. (1890-6, £26)				5 5 -
Francis, Mrs. Sarah	1	1	-	
Francis, T. M., Esq.	1	1	-	
Franklyn, Mrs.	2	2	-	
Fraser-Tytler, General Sir J. M. B., K.C.B.	2	-	-	
Free Gardeners, N.U. Order of, Aire and Calder Lodge				5 5 -
Freeland, Messrs. J. and A. B.	1	1	-	
Freeling, Mrs., the late (1869-96, £93 6s.)				3 3 -
Freeman, Mrs. A. D.				- 5 -
Freemasons, Temperance Lodge, No. 739	2	2	-	
Freer, The Ven. Archdeacon, M.A.	1	1	-	
Friends at Sunbury Common				- 7 6
Frith, Rev. Wm. A., M.A. (Annual Sub., £1 1s., paid in 1895).				
Frost, Brothers, Messrs.	1	1	-	
Carried forward	£1280	14	-	5119 1 10

	Ann. Subs.		Donations.			Ann. Subs.		Donations.	
	£.	s. d.	£.	s. d.		£.	s. d.	£.	s. d.
Brought forward	1280	14	-	5119	1	10			
Fry, The Right Hon. Sir Edward	2	-	-						
Fry, Thos. H. Esq.	1	1	-						
Fryer, Captain C. G., J.P.	1	1	-						
Fuller, The Misses	2	-	-						
G. G. B.			5	-	-				
G. H. (1894-6, £9)			3	-	-				
G. R. B. (1877-96, £94)			5	5	-				
Gabriel, Miss (1891-6, £6 5s.)			1	1	-				
Gale and Co., Messrs.	2	2	-						
Gall, C. E., Esq. (1893-6, £8 8s.)			2	2	-				
Galloway, Joseph, Esq.	1	-	-						
Galton, Erasmus, Esq.	2	2	-						
Gamlen, Miss Mary B.	2	-	-						
Gamman, Samuel, Esq.			1	1	-				
Ganthorp, Miss E.	1	-	-						
Gardiner, Miss Caroline	1	1	-						
Gardiner, Miss E.	1	1	-						
Gardiner, Miss Ellen	1	1	-						
Gardiner, Miss Emma S.	1	1	-						
Gardner, J. E., Esq.	10	10	-						
Gardner, Rev. T. J. C., M.A.	1	1	-						
Garnett, G. Russell, Esq.	1	1	-						
Garnham, A., & Co., Messrs.	2	2	-						
Garrett, Miss E. J.	2	2	-	5	5	-			
Garrett, Miss J. G.	3	3	-						
Garrett, Miss L. K. (1892-6, £60)			20	-	-				
Garrett, R. W., Esq. (1891-6, £12 12s.)			2	2	-				
Gaskell, Miss Marian.			1	-	-				
Gateshead Industrial Co-operative Socy., Ltd. (1895-6, £30)			10	-	-				
Gatty, Chas. Hy., Esq., LL.D.	2	2	-						
Gay and Co., Messrs. R. (1882-96, £163 16s.)			21	-	-				
Geary, Lady	1	-	-						
Gibbes, W., Esq.	1	-	-						
Gibbs, A. E., Esq.			5	5	-				
Gibson, David, Esq.	1	1	-						
Giesler and Co., Messrs.	3	3	-						
Gilbert, J. A., Esq.	1	1	-						
Girdlestone, Mrs. R. B.	1	-	-						
Girdwood & Co., Messrs.	-	10	6						
Gladstone, John E., Esq.	2	2	-						
Glen, Miss (1888-96, £20 10s.)			-	10	-				
Glenn, In memory of Wm. M.	2	-	-						
Glover Brothers, Messrs.	-	10	-						
Goddard, R. W. Esq.	1	1	-						
Godlee, Francis, Esq.	5	5	-						
Godlee, J. L. Esq.	1	1	-						
Godley, Miss R. M.	1	1	-						
Godsal, P. W., Esq.	2	-	-						
Goff, Colonel R. C.	1	-	-						
Goldsmid, Lady Louisa, (1893-6, £50)			10	-	-				
Gomonde, Mrs. (1864-96, £660)			20	-	-				
Gonne, Edward, Esq.	1	1	-						
Goode, Miss M. H. (1877-96, £11)			-	10	-				
Goodman, Miss (1889-96, £10 10s.) In remembrance of the late Misses Goodman			-	10	-				
Goodnestone School, collected at Service of Song			1	-	-				
Gordon, A. D., Esq.	2	2	-						
Gordon, Miss	1	1	-						
Carried forward	£1350	4	6	5233	12	10			
Brought forward	1350	4	6	5233	12	10			
Gordon, Mr. G.			1	-	-				
Gore, Miss E. E.	1	-	-						
Gorell, Miss	1	-	-						
Gorringe, Frederick, Esq.	3	3	-						
Gosling, Francis, Esq.	1	1	-						
Gosling, Mrs. C. H.	1	1	-						
Gosling, Mrs. Mary	1	1	-						
Gouffee & James, Messrs.	-	10	6						
Grafton, John H., Esq.	2	2	-						
Grafton, Mrs. Eliza	2	2	-						
Graham, Mrs. North	1	1	-						
Graham, Philip H., Esq.	1	1	-						
Grant, Ed., Esq.	1	1	-						
Grasett, Mrs. H. B.	3	3	-						
Grantham Equitable Co-operative Industrial Socy., Ltd. (1895-6, £4 4s.)			2	2	-				
Graves, Henry C., Esq.	1	1	-						
Gravesend, The Borough of, Co-operative Socy., Ltd.	1	1	-						
Gray, Dawes, & Co., Messrs.	10	10	-						
Gray, Matthew, Esq. (1887-96, £70)			20	-	-				
Gray, Rev. C., M.A.	-	5	-						
Grays Co-operative Industrial and Provident Society	2	2	-						
Great Harwood Co-operative Socy., Ltd. (1895-6, £2)			1	-	-				
Great Horton Industrial Socy., Ltd. (1895-6, £2)			1	-	-				
Green, Frederick, Esq.	1	1	-						
Green, Joseph F., Esq.	10	-	-						
Greene, A. D., Esq.	1	1	-						
Gregg, E. & E.	-	15	-						
Gregory & Co., Messrs.	-	10	6						
Gregory, G., Esq.			3	3	-				
Grey, The Misses (1893-6, £3 2s. 6d.)			1	-	-				
Grice, Wm. & Co., Messrs. (1862-96, £315)			5	-	-				
Griffith, Capt. C. W. Darby	1	-	-						
Griffiths, Tate, & Co., Messrs.	2	2	-						
Griggs, J., Esq. (1895-6, £2 2s.)			1	1	-				
Grimsdale & Sons, Messrs.	1	1	-						
Grimshaw Park Co-operative Society, Limited (1895-6, £4 4s.)			2	2	-				
Grocers, Worshipful Company of (1877-96, £750)			100	-	-				
Grosvenor, Capt. the Hon. Norman de l'A.	1	-	-						
Grosvenor, Chater, & Co., Messrs.	1	-	-						
Guiry, Mrs. (1891-6, £37 10s.)			10	-	-				
Guise, Mrs.	-	10	-						
Gun Makers, Worshipful Company of (1866-96, £331)			10	-	-				
Gurney, Henry, Esq.	1	1	-						
Guthrie, Mrs., in memory of the late Major C. O. James	5	-	-						
Guttridge, Mrs. H. E. (1892-6, £2)			-	10	-				
Gwyer, Mr. Joseph (proceeds of Sale of Lines on the Life-boat, in addition to collection on steamers, &c.)			2	16	6				
H. B.	2	2	-						
H. E. P. H. (1893-6, £3 5s.)			1	-	-				
H. H. T. S. (1895-6, £2 2s.)			1	1	-				
Carried forward	£1411	18	6	5411	8	4			

	Ann. Subs.		Donations.	
	£.	s. d.	£.	s. d.
Brought forward	1411	18 6	5411	8 4
H. R.	2	2 -		
H. W. H.	1	1 -		
Haarbleicher and Schumann.	1	1 -		
Haas, H. C., Esq.	1	1 -		
Hacon, The Misses	1	- -		
Haig, Mrs. F. (1894-6, £1 11s. 6d.)			10	6 -
Haley, Edward, Esq.			10	- -
Halford, Hon. Mrs.			10	- -
Halford, Lady			10	6 -
Halifax City, S.S., Collection, per Capt. Newton			1	10 -
Halifax Flour Society, Ltd.			2	2 -
Hall, Hawkesley, Esq.	1	1 -		
Hall, Miss Elizabeth	1	1 -		
Hall, Miss M. S.			10	- -
Hall, W. H., Esq.			5	- -
Hambro & Son, Messrs. C. J. (1892-6, £5)			1	- -
Hamilton, Admiral Sir R. V., G.C.B.	1	- -		
Hamilton, Col. H. B.			1	1 -
Hamilton, F. A., Esq.	10	10 -		
Hamilton, Lieut. A. S., R.N.	1	1 -		
Hamilton, Miss Daisy			1	- -
Hamilton, Miss Edith (on behalf of the correct competitors in the "Watizit" puzzle)			21	- -
Hamilton, Miss Mary E.			1	- -
Hamilton, Miss Mary, Executors of the late			20	- -
Hamilton, Mrs. George (1894-6, £15)			10	- -
Hamley, Miss	1	- -		
Hammond, Rev. Egerton D., M.A.	1	- -		
Hancock, Mrs. E. (1892-6, £5 1s.)			1	1 -
Hancocks, Miss C. E.			1	1 -
Hankey, Capt. F. T. B., R.N.	1	- -		
Hankey, Colonel Walter A. (1879-96, £20 10s.)			10	- -
Hannen, Reginald, Esq., F.S.I. (1892-6, £2 12s.)			1	1 -
Hansen, C. O. B., Esq.			1	- -
Hanson, Mrs.			10	6 -
Hardcastle, Miss (1892-6, £30)			5	- -
Hardell, Miss (1894-6, £3)			1	- -
Hardie, Thos. Kincaid, Esq., in addition to gift of Ayr Life-boat (1874-96, £280 5s.)			20	- -
Harding, The Misses	5	- -		
Harding, Mrs.	5	- -		
Hardisty, E., Esq.			1	- -
Hardwick, Chas., Esq.	1	1 -		
Hardwick, Mrs. M. L.	1	1 -		
Ditto (1891-6, £10)			5	- -
Hardy, Lady	1	1 -		
Hardyman, Miss C. J.	1	1 -		
Hare, Mrs. E. H.	1	6 -		
Hare, Rear-Admiral the Hon. H. Rich.	1	- -		
Harker & Co., Messrs. G.	1	1 -		
Harris Brothers & Co., Messrs.	1	1 -		
Harris, Miss	1	1 -		
Harris, Mrs.			5	- -
Harris & Dixon, Messrs.	2	2 -		
Harrison, A. P., Esq.	10	- -		
Harrison, C., Esq. (1895-6, £4 14s. 6d.)			2	12 6
Harrison, John, Esq.	2	2 -		

Carried forward . £1467 9 6 5519 17 4

	Ann. Subs.		Donations.	
	£.	s. d.	£.	s. d.
Brought forward	1467	9 6	5519	17 4
Hart, Wm., Esq.	1	1 -		
Hart-Dyke, Mrs. F.	1	1 -		
Hartlepool Co-operative Society, Limited			3	3 -
Harton, Miss M. (1890-6, £1 5s.)				5 -
Harton, Mrs. W. H.	2	2 -		
Hartopp, W. E., Esq.	1	1 -		
Hartshorne, Miss C. M.			5	- -
Harvey and Greenacre, Messrs.	5	5 -		
Harvey, H. Fairfax, Esq.	1	1 -		
Harwood, Mrs.			1	1 -
Haslam, Henry, Esq.	1	1 -		
Haslam & Makovski, Messrs.	1	1 -		
Hassell, Mrs. C. G.	10	10 -		
Hassell, Mrs. Susan	1	1 -		
Haswell Co-operative Provision Society, Limited (1895-6, £10)			5	- -
Haswell, Vice-Admiral W. H.	1	- -		
Hatch, General W. S.	1	1 -		
Hathornthwaite, The Rev. R., B.A. (1881-96, £37 16s.)			3	3 -
Hathornthwaite, Wm., Esq.	2	- -		
Hatton, Miss A.			10	6 -
Havard, D. Esq., J.P., M.D.				10 6
Havelock, M., Esq.			10	- -
Haverfield, Mrs. E.	1	1 -		
Hawick Co-operative Society, Limited	2	2 -		
Hawkins & Co., Messrs. J. E. (for 1896-7)	2	- -		
Hay, Mrs.			10	6 -
Hayes, George W., Esq.	2	2 -		
Hayes, Mrs. L.	2	- -		
Haynes, Edmund C., Esq.	1	1 -		
Hay's Wharf, Proprietors of	1	1 -		
Hayter and Hayter, Messrs.	1	1 -		
Hayton, H. F. Esq.			2	2 -
Hayward, B. W., Esq. (1886-96, £11 8s.)			1	1 -
Hayward, J. Fred., Esq. (1873-96, £108 6s.)				1 -
Hayward, Leonard W., Esq.	2	2 -		
Head and Co., Messrs. H.	2	2 -		
Heatley and Son, Messrs.	1	1 -		
Hefford, J. G., Esq.	1	1 -		
Hegan, C. J., Esq.	5	- -		
Hemery, C., Esq.			10	6 -
Henckell, Du Buisson, and Co., Messrs.	2	2 -		
Henderson, Miss F. (In memory of the late James Henderson, Esq., R.N.) (for 1895-6)			2	2 -
Henty, C. P., Esq.	1	1 -		
Hepburn, Mrs. Emily M.	1	1 -		
Herd, Mrs. J.	1	1 -		
Heron, The Misses Lila and Jean, and Mr. John (1889-96, £12)			1	10 -
Herring, Messrs. G. & A., & Co.	1	1 -		
Hewetson, Miss Hannah.	2	2 -		
Hewett, Sir Harold G., Bart.	1	- -		
Hewett & Co., Messrs. J. D.	1	1 -		
Hewitson, Messrs. R. & J.	1	1 -		
Hewson, Capt.	2	2 -		
Heyland, Gen. H. T., C.B.	1	- -		
Heywood, E. S., Esq.	2	2 -		
Hichens, A. K., Esq.	1	1 -		
Hicks, Ernest, Esq.			5	- -
Higham, W. S., Esq.	1	1 -		

Carried forward . £1548 13 - 5543 12 10

		Ann. Subs.		Donations.				Ann. Subs.		Donations.			
		£.	s.	d.	£.	s.	d.	£.	s.	d.	£.	s.	d.
Brought forward		1543	13					1628	1		5572	11	10
Highmoor, Rev. W., B.A. (1895-6, 11s.)						6		Hughes, Fredk., Esq. (1879-96, £49)				5	
Higginton, A. J. Esq.		1	1					Hugill, John, Esq.	1	1			
Hildyard, Mrs.			10					Hull, collection from seamen, by J. W. Day, Esq.				5	
Hilhouse, Miss Harriet			1					Hunt, A. J., Esq.	1	1			
Hill, F., Esq.			1					Ditto (1890-96, £17 17s.)				4	4
Hill, Miss (1894-6, £30)					10			Hunt, Miss					
Hill, Miss M. (1894-6, 10s.)						5		Hunt, Rev. William, M.A.	1	1			
Hill, The Right Hon. Lord Arthur Wm., M.P.		5	5					Hunter, Mark Wm., Esq. (1872-96, £85 1s.)				3	3
Hills and Underwood, Messrs.		1						Hunwicke, F. S., Esq.	1				
Hills, Mrs. C. M.			1					Hurst, Charles J., Esq.	1	1			
Hilton and Anderson, Messrs.			10					Hurst, G., Esq.				10	6
Hilton, Richard J., Esq.		2	2					Hurt, Miss Grace				5	
Hindley, W. H., Esq.			1					Hurt & Co., Messrs. F.				10	6
Hinrichs, Miss Elly (collections)					1	12		Hurwitz, C. B., Esq.	1	1			
Hinton, Joseph, Esq.			10					Hutchinson, Miss C. (1863-96, £80)				4	
Hird, John, Esq.			1					Hutchinson, Miss Fanny (1871-96, £62)				3	
Hoare, Alfred, Esq.		5						Hutchinson, Miss	1				
Hobson, Chas., Esq.		1	1					Hutchinson, Robert, Esq.	1				
Hockerell, Bishop's Stortford		2	2					Hutchinson, Thomas, Esq.				10	
Hodge, Miss Alma		1						Hyde Equitable Co-operative Society, Limited				2	2
Hodge, Ford, Esq.		1	1					Hylton, The Right Hon. Lord	3	3			
Hodgkinson, W. S., and Co., Messrs.		1	1					Hyne, Rev. C. W. N., M.A.	1	1			
Hodgson, F. C., Esq.		1	10										
Hodgson, F. W., Esq.		1	1										
Hodgson, J. H., Esq.		1	1										
Hodgson, Mrs. M. L.		5	5										
Hodgson, The Misses			5										
Hodson, M. Mackenzie, Esq.					10	10							
Hogan, John A. Esq.		1	1										
Hogg, Curtis, Campbell & Co., Messrs.		2	2					Image, W. E., Esq.	1	1			
Holden, E. T., Esq.		1	1					Ingilby, William, Esq.	1	1			
Holland, Alfred R. Esq.					1	1		Ingram, Rev. H. M., M.A.	1				
Holland, The Hon. Mrs. F.		2	2					"In Memoriam"	25				
Holland, Capt. S. C., R.N.		1	1					"In Memoriam"	5				
Holt, Miss A. (for 1896-7)		2	2					"In Memoriam" D. M. T. (1887-96, £10 10s.)				1	1
Holt, Mrs.		1	1					"In Memoriam" Richard Hoyle (1895-6, £10)				5	
Homer, Mrs. Charles G.		1	1					"In Memory of two sailor brothers lost at sea—A Widow's Mite"				5	
Homer, Rev. H., B.A.			10		6			"Inter Cruces" (1876-96, £22 1s.)				2	2
Hood of Avalon, Admiral the Rt. Hon. Lord, G.C.B.		2						Irby, The Hon. and Rev. L. C. R., M.A.	1	1			
Hooper, A. D., Esq.		1						Iredell, Miss E. A.	1	1			
Hooper, Miss E.			10					Isaac, Albert E., Esq.				5	
Hope, Philip B. Beresford, Esq.		1											
Hopkins, Rev. F., M.A.		2	2					J. B. S.	5				
Hopkins, The Misses		5						J. C.	2	2			
Hopton Congregational Chapel Sick and Funeral Society		3	3					J. C.				6	
Horn, Mr. J. E.		1	1					J. F.	5	5			
Horsfall, T. M., Esq. (1892-6, £33 2s.)					5	5		J. J. C.	1				
Hose, Rev. J. C., B.A.		1	1					J. P.	15				
Hotham, F. W., Esq.		2						J. S. A. (1872-96, £95 2s.)				5	5
Howell, Messrs. D. N. & Co.			10		6			Jackson, Miss E. M.	5	5			
Howlett, The Rev. W., M.A., and Mrs. (Ann. Sub. 5s., paid in 1895.)								Jackson, Mrs.				5	
Hoyland, Rev. J., M.A.		1	1					Jackson, Mrs. Corrie				1	1
Hoyland, Miss.			5					Jackson, S., Esq. (Ann. Sub. £1 1s., paid in 1895.)					
Hozier, Sir Wm., Bart.		10						Jackson & Till, Messrs.	1	1			
Hubbard, Col. the Hon. C. J.		1						Jacobs & Co., Messrs. A. M.	1	1			
Hubbuck, A. G., Esq.		1	1					James, Edward B., Esq.	1	1			
Hucknall Torkard Industrial Provident Socy., Ltd.		1	1					James, J. Stanley, Esq.	1	1			
Hudson, Frank, Esq., J.P.		1	1										
Hudson, Rev. William, M.A.		1	1										
Carried forward		£1628	1		5572	11	10	Carried forward	£1716	16		5614	10

	Ann. Subs.		Donations.	
	£.	s. d.	£.	s. d.
Brought forward	1716	16	5614	10
Janvrin, The Misses	1	1	-	-
Jarrow & Hebburn Co-operative Society, Ltd. (1895-6, £10 10s.)			5	5
Jauncey, G. M., Esq.	2	2	-	-
Jay, Mrs. E. A.	1	1	-	-
Jeffery, Miss	1	-	-	-
Jeffries, Miss (Annual Sub. 5s., paid in 1895).				
Jervoise, Miss E. M. E.	-	10	-	-
Jevons, Mrs. H. A. (1894-6, £2 6s.)			1	5
Jessop, Miss S. M.	-	5	-	-
Jobson, W. W., Esq.	1	1	-	-
Johnson, Miss	-	5	-	-
Johnson, Mrs.	1	1	-	-
Johnson, Mrs. M. E.	1	1	-	-
Johnston, F., Esq.	-	5	-	-
Johnston & Son, Messrs.	1	1	-	-
Johnston & Sons, Messrs. N.	1	1	-	-
Johnston, Son & Co., Messrs. E.	1	1	-	-
Johnston, T., Esq.	2	2	-	-
Jones, Miss Emily.	3	-	-	-
Jones, Miss F. A. (A New Year's Offering from The Towers, Upper Armley, Leeds) (1883-96, £14 16s.)			1	1
Jones, Major F. J.	2	2	-	-
Jones, H. Cadman, Esq.	1	1	-	-
Jones, Miss Isabella G. E.	-	10	-	-
Jones, Mrs. J. H.	1	-	-	-
Jones, R. A. A., Esq.	5	5	-	-
Jones & Son, Messrs. R. P. (Ann. Sub. 10s., paid in 1895).				
Judson, Miss E.	1	-	-	-
Julius, Arthur O., Esq.	5	5	-	-
Jupp & Sons, Messrs.	-	10	6	-
Justice, Mrs. (1890-6, £7 6s.)			1	-
K. E. H. (1893-6, £5 1s.)			1	-
Kaye, Miss E. F.	2	2	-	-
Keal, Miss	1	1	-	-
Keene, Messrs. S. W. & Co.	-	10	-	-
Keighley, Maxted & Co., Messrs.	1	1	-	-
Keiller, William, Esq.	1	1	-	-
Kelham, Chas. E., Esq.	-	5	-	-
Kelham, Charles Ross, Esq.	-	10	-	-
Kelly, C. A., Esq. (for 1896-7)	2	2	-	-
Kempster, Mr. and Mrs. John	1	1	-	-
Kendal Co-operative Society, Ltd.	1	1	-	-
Kendal, T. Herbert, Esq. (1871-96, £84 4s.)			5	-
Kennard, Steinmetz, and Co., Messrs.	1	1	-	-
Kennedy, Mrs. W.	1	-	-	-
Kenrick, Miss (1894-6, £3 2s.)			1	1
Kenrick, Mrs.	1	-	-	-
Kensit, Miss	2	-	-	-
Kent and Sons, Messrs. G. B.	1	1	-	-
Kent, Henry, Esq.	1	1	-	-
Kent, Mrs. Henry	1	1	-	-
Kent, T. J., Esq. (1891-6, £52 10s.)			10	10
Keppel, Admiral of the Fleet the Hon. Sir Henry, G.C.B.	1	1	-	-
Kerr, Captain T. Coulter.	1	1	-	-
Carried forward	£1772	6	6	5640

	Ann. Subs.		Donations.	
	£.	s. d.	£.	s. d.
Brought forward	1772	6	6	5640
Kidd, Miss Pringle	5	-	-	-
Ditto (1877-96, £83, in addition to gift of Life-boat).				
Kiddle, J. Nelson, Esq.	1	1	-	-
Kidner, Mrs. J. C.	2	2	-	-
Kilmarnock Equitable Co-operative Society			3	-
Kinahan, C. J., Esq.	1	1	-	-
King, Messrs. H. S. and Co.	2	2	-	-
King, Miss Edith	-	5	-	-
King, Samuel, Esq.	-	10	-	-
King, Messrs. T. & H.	1	-	-	-
Kinloch, Miss	1	1	-	-
Kitsell, A. William, Esq.	1	-	-	-
Klein & Sons, Messrs. W.	1	1	-	-
Knight, Miss E. C.	1	1	-	-
Knill and Co., Messrs. J.	2	2	-	-
Knowles, The late Miss M.	4	-	-	-
Kubler, A. A., Esq.	1	1	-	-
L. E. W., Croydon	-	10	-	-
L. J. E.	1	-	-	-
Laird, Miss Alice M.			5	-
La Marguerite, S.S. (Capt. Owen) Collections per Mr. J. Gwyer			1	7
Lambert Bros., Messrs.	2	2	-	-
Lambert, Rev. F. Fox, M.A.	1	1	-	-
Lambert, T., Esq.	2	2	-	-
Lamming, Walter, Esq.	1	-	-	-
Lamotte, L. W., Esq.	1	-	-	-
Lampson, Sir George C., Bart.	2	2	-	-
Landon, Mrs., C. A.	2	2	-	-
Landon, The Misses	1	1	-	-
Langley Mill and Aldercar Co-operative Society, Ltd.	2	2	-	-
Langton, Miss Maria	1	1	-	-
Lansdell, Miss	1	1	-	-
Lanyon, J. C., Esq.	1	1	-	-
Larcom, Mrs. Capt.	1	-	-	-
Larden, Rev. G. F., D.C.L.	1	10	-	-
Lark, Sons & Co., Limited	1	1	-	-
Latham, Charles H., Esq.	-	5	-	-
Latham, F. L., Esq.	2	-	-	-
Laurence, The Misses (1882-96, £30 10s.)			5	-
Law, Alfred, Esq.	1	1	-	-
Law, William, Esq.	1	1	-	-
Lawes, Mrs.			-	10
Lawrence, Miss	1	1	-	-
Lawrence, Mrs.	1	1	-	-
Lawrence, Arthur, Esq. (1894-6, £4)			1	-
Lawson, Miss Elizabeth	10	-	-	-
Layard, The Misses C. and R.	6	6	-	-
Layard, Mrs. Brownlow	1	1	-	-
Leach, Francis, Esq.	2	2	-	-
Leach, Lt.-Col. Sir George A.	1	-	-	-
Leaf, Charles J., Esq.	2	2	-	-
Le Lacheur, J. A., Esq.	1	1	-	-
Leake, Thos. S., Esq.	2	2	-	-
Leathersellers, Worshipful Company of (1874-96, £115 10s.)			21	-
Le Cocq, Capt. W. G., R.N.	5	-	-	-
Ledger & Co., Messrs. E. W.	-	10	-	-
Ledger, J. W., Esq.	1	1	-	-
Lee, J., Esq. (1876-96, £24 6s.)			2	2
Lee, Miss	2	2	-	-
Carried forward	£1860	5	6	5679

	Ann. Subs. Donations.					Ann. Subs. Donations.			
	£.	s.	d.	£. s. d.		£.	s.	d.	£. s. d.
Brought forward	1860	5	6	5679	2	4			
Lefroy, G. B. A., Esq.				-	10	-			
Le Geyt, W. B., Esq. (1881-96, £7)				1	-	-			
Leigh, Mrs. D. H.	1	1	-						
Leiningen, Admiral H.S.H. the Prince of, G.C.B.	1	1	-						
Leishman, Inglis, & Co., Messrs.	1	1	-						
Letchworth, Miss E.	1	1	-						
Lethbridge, Mrs. A. G.	3	3	-						
Lethbridge, Rev. J. K., M.A.	-	10	-						
Lethbridge, Mrs. J. K.	-	5	-						
Lett, H., Esq. (1894-6, £1 10s.)				-	10	-			
Lever-Jones, Mrs. S.	1	1	-						
Lewis, Mrs. Richd.	2	2	-						
Lewis, Professor T. Hayter (1872-96, £21)				5	5	-			
Lewis, R. E., Esq.	1	1	-						
Lewis, Richd., Esq.	1	1	-						
Liddell, E. H., Esq. (1885-96, £47 5s.)				5	5	-			
Liddon, Mrs. John	1	1	-						
Lightfoot, Miss	2	-	-						
Lighton, A. H. Digby, Esq.	1	1	-						
Lilley, Thomas, Esq. (1892-6, £3 1s.)				1	-	-			
Lincoln, Wm., Esq.	1	1	-						
Lindner, Miss A. J.	-	5	-						
Linford, Mrs. W. T.	2	1	-						
Lingen, The Rt. Hon. Lord, K.C.B.	2	2	-						
Lingham, Mrs.	1	1	-						
Ditto, in aid of Rhosneigr Life-boat	1	1	-						
Lister & Beck, Messrs.	1	1	-						
Lister, I. W., Esq. (1888-96, £42 2s.)				5	-	-			
Littlehales, L. W., Esq. (1891-6, £9)				5	-	-			
Liveing, Miss C., the late	-	5	-						
Llewellyn, R. W., Esq.	-	10	6						
Lloyd, J. E. H., Esq.	-	10	-						
Lloyd, Matheson, & Carrith, Messrs.	1	-	-						
Lockitt, Mrs. A.	-	5	-						
Lock & Co., Messrs. W.	-	5	-						
London and North Western Railway Company, in aid of Greenore Life-boat Station				10	10	-			
Long, Mrs.	5	-	-						
Longley, Mrs.	1	1	-						
Longman, C. J., Esq.	1	1	-						
Longridge, Miss	1	1	-						
Lopes, Lady	1	-	-						
Love, G. H., Esq.	-	10	6						
Low, Alex. F., Esq.	2	2	-						
Lowe, Mrs. Drury				1	-	-			
Lowndes, Rev. E. S., M.A.	1	1	-						
Lowndes, Rev. W. D., M.A.	-	10	6						
Lowrie, William, Esq.	1	1	-						
Loyd, Major Arthur P.	5	-	-						
Loyd, Mrs. Lewis (1859-96, £71 5s.)				5	-	-			
Luard, Admiral	1	1	-						
Luscombe, Mrs. S.	2	-	-						
Lushington, Mrs. J. D.	2	-	-						
Lutwidge, C. R. Fletcher, Esq.	1	1	-						
Luxmoore, Mrs.	2	2	-						
Lyall, W. H., Esq.	1	1	-						
Lyall, Mrs. F.	1	1	-						
Lyne, Miss	1	1	-						
Lyons, R. T., Esq., M.D.	1	1	-						
Carried forward	£1920	16	-	5719	2	4			
Brought forward	1920	16	-	5719	2	4			
M., Plymouth (1892-6, £4 4s.)				1	1	-			
M. (1867-96, £71)				2	-	-			
M. A. B.				-	10	-			
M. B.	10	-	-						
M. B.	1	1	-						
M. B. (1885-6, £8)				1	-	-			
M. D. G. (1887-96, £3 8s.)				3	3	-			
M. L. G.	5	-	-	10	10	-			
M., E. & A. (1890-6, £150)				25	-	-			
M. E. W. E. C.	-	15	-						
MacAndrew & Co., Messrs. R.	2	2	-						
Macbean, Mrs. Baillie	10	-	-						
Macclesfield Equitable Provident Society, Limited	2	2	-						
Macclesfield, The Right Hon. the Countess of (1891-6, £15)				5	0	0			
Macdonald-Lockhart, Lieut.-Col. Sir S., Bart.	2	2	-						
Machin, Miss F. C. (1893-6, £4 3s.)				1	-	-			
Mackenzie, Mrs.	-	5	-						
Mackenzie, Mrs. E.	2	2	-						
MacLeod, Mrs.	1	1	-						
Macleod, Norman M., Esq.	-	5	-						
Macmillan and Co., Ltd.	1	1	-						
MacMillan, G. A., Esq.	1	1	-						
Macpherson, Mrs. N. (1893-6, £1 4s.)				-	5	-			
Macpherson, Hugh M., Esq.	1	1	-						
Macvicar, Mrs. (1894-6, £2)				1	-	-			
MacWhirter, J. Esq., R.A. (1871-96, £72 18s.)				1	-	-			
Maddocks, Miss A.				-	10	-			
Magrath, Rev. J. R., M.A.	-	10	-						
Maidlow & Sons, Messrs.	-	10	-						
Maingay, W. B., Esq., and Mrs.	1	1	-						
Maitland, A. C. R., Esq. (1885-96, £16 2s.)				1	1	-			
Maitland, Rear-Admiral H. L.	1	1	-						
Majendie, Mrs. A.	1	-	-						
Major and Field, Messrs.	2	2	-						
Malcolm, W. E., Esq.	1	-	-						
Maltby, Lieut.-Col. E. P.	1	1	-						
Mankiewicz, F. J., Esq.	1	1	-						
Manley, A. E., Esq.	2	-	-						
Mann, Mrs. C.	1	1	-						
Manning, Miss M.E. (1886-96, £20)				2	-	-			
Mannock, W. M. S. P., Esq.	1	1	-						
Mansfield, G. J., Esq.	1	1	-						
Marcus, E. Esq.	-	5	-						
Margetts, Mrs. E. G.	1	1	-						
Marine and General Mutual Life Assurance Society	5	5	-						
Markham, Chas., Esq.	1	-	-						
Marriott, Messrs. R. & G. H.	1	1	-						
Marryatt and Sons, Messrs. J.	2	2	-						
Marshall Brothers, Messrs.	1	1	-						
Marshall, Col.				-	10	-			
Marshall, Rev. E., M.A.	1	1	-						
Marshall, J. M., Esq.	1	1	-						
Martin, Miss	5	5	-						
Martin, Mrs. Glanville	1	-	-						
Martin, Miss Louisa R.	2	2	-						
Martin, T., Esq.	1	1	-						
Martyn, Rev. T. W. (Ann. Sub. 10s., paid in 1895)				1	1	-			
Mathison, John, Esq.	1	1	-						
Matlock Bath, Lee Board School Concert				-	10	6			
Carried forward	£1999	9	-	5775	2	10			

	Ann. Subs.		Donations.	
	£.	s. d.	£.	s. d.
Brought forward	1999	9	-	5775 2 10
Matthews, W. E., Esq. (1893-6, £20)			5	- -
Matthews and Luff, Messrs.	1	1	-	-
Matveiff and Co., Messrs.	1	-	-	-
Maude, Edmund Esq.			1	- -
Maude, John, Esq.	1	1	-	-
Maxwell, Rev. E., M.A.	2	10	-	-
Maxwell, Col. G. Shirley	1	-	-	-
Maycock, Col. (Ann. Sub. £1 1s., paid in 1895).				
Mayer & Co., Messrs. C.	2	2	-	-
Mayer, Rev. J. H., M.A.	-	10	-	-
M ^c Andrew, John, Esq.	2	2	-	-
M ^c Arthur, Messrs. W. & A.	2	2	-	-
M ^c Culloch, Lady	10	-	-	-
M ^c Donogh, Mrs.	2	2	-	-
M ^c Dougall, Lieut.-Col. C. A., The late	1	-	-	-
M ^c Dougall, T., Esq.	2	2	-	-
M ^c Ewan & Co., Limited, Messrs. J.	1	1	-	-
M ^c Ewen, Mrs. E. (1889-96, £10)			2	- -
M ^c Ilwraith, M ^c Eacharn & Co., Messrs.	1	1	-	-
M ^c Killican, Mrs.	1	1	-	-
M ^c Kinna, David, Esq.	-	10	6	-
M ^c Laren, Jas., Esq.	1	1	-	-
M ^c Teir, F. Esq. (1893-6, £2 2s.)			1	1 -
Mead, J. B., Esq., The late	1	1	-	-
Meaden, W. J., Esq. (1893-6, £5 5s.)			1	1 -
Medill, T. S., Esq.	-	10	6	-
Medlycott, Capt. M. B., R.N.	1	1	-	-
Mee, Mrs. J. H.	1	1	-	-
Meesom, W. M., Esq.	1	1	-	-
Megaw & Norton, Messrs.	1	1	-	-
Megeson and Co., Messrs.	2	2	-	-
Mellish, Henry, Esq.	1	1	-	-
Mellish, Mrs. Leigh	1	1	-	-
Melville, Lady F.	1	1	-	-
Merchant Taylors, Worshipful Company of (1857-96, £283 10s.)			21	- -
Meredith, The Misses E. A. and D. (1893-6, £2 10s.)			-	10 -
Merewether, Mrs.	1	-	-	-
Merrick, Mrs.	1	-	-	-
Mersey Docks & Harbour Board.	1,000	-	-	131 - -
Metcalfe, Mrs. H. A.	1	1	-	-
Meux Brewery Company, Limited	5	5	-	-
Meyrick, Sir Geo., Bt.	2	-	-	-
Michell, Lady Frances (1888-96, £10)			1	- -
Michie, A. S., Esq.	1	1	-	-
Michie, Mrs. A. S.	1	1	-	-
Middlesborough Co-operative Society, Limited			2	2 -
Middleton and Tonge Industrial Socy., Limited (1895-6, £3 2s.)			1	- -
Middleton, Sir Arthur E. Bart.	1	1	-	-
Midhurst Church, Week Night Offertory, per Rev. S. Montgomery-Campbell.			1	8 1
Miland, Mrs. E.	2	-	-	-
Milburn & Co., Messrs. Wm.	5	5	-	-
Miller, B. A., Esq.	10	-	-	-
Miller, R. M., Esq.	1	1	-	-
Miller, Rev. N. J., M.A.	2	2	-	-

Carried forward . £3077 13 - 5943 4 11

	Ann. Subs.		Donations.	
	£.	s. d.	£.	s. d.
Brought forward	3077	13	-	5943 4 11
Miller, J. W., Esq.	1	-	-	-
Ditto. (1891-6, £26 4s.)			10	- -
Mills, George W., Esq.	1	1	-	-
Mills, Miss I.	2	2	-	-
Mills, John, Esq.	1	1	-	-
Milner, Isaac, Esq.	1	-	-	-
Minet, Mrs. (1892-6, £25)			5	- -
Mitchell, A. C., Esq.	1	1	-	-
Mitchell, Capt. Clayton, R.N.	3	3	-	-
Mitchell, T. H., Esq. (1891-6, £6)			1	- -
Mitchell, W. R., Esq.	1	1	-	-
Mitchell, Yeames & Co., Messrs.	5	-	-	-
Mitcheon, Richard E., Esq.	1	1	-	-
Mocatta, F. D., Esq. (1894-6, £15 10s.)			5	- -
Molle, Mrs. (for 1895-6)	4	4	-	-
Molony, Mrs. C. P.	-	5	-	-
Monckton, Lt.-Col. P. E. (1886-96, £46 12s.)			5	- -
Moncrieff, Major-General G. H.	1	-	-	-
Mongredien, Ellerly & Co., Messrs.	1	1	-	-
Montague, Leopold A. D., Esq.	1	1	-	-
Montgomerie & Workman, Messrs.	1	1	-	-
Montgomery, John, Esq.	5	-	-	-
Montgomery, Sir Graham G., Bart.	2	-	-	-
Montgomery, W. & Co., Messrs.	5	5	-	-
Moon, Sir Richard, Bart.	2	2	-	-
Moore, Capt. Richmond, R.N.	1	1	-	-
Moore, The late Lieut.-Gen. R. C., C.B.	2	-	-	-
Moore, Mrs.	2	2	-	-
Moore, Miss	1	1	-	-
Moore, Capt. W. U. (Ann. Sub. £1 1s., paid in 1895).				
Moorsom, Rev. J. R., M.A., the late	1	1	-	-
Moorsom, Miss	1	-	-	-
Ditto, in aid of Whitby Branch	1	-	-	-
Mordy, Wm., Esq.	1	1	-	-
Morgan & Co., Messrs. J. S.	1	1	-	-
Morley, Mrs., Derby	1	1	-	-
Morne, H. D., Esq.			-	5 -
Morphew, J., Esq.	1	-	-	-
Mortimer, Herbert E., Esq.	3	-	-	-
Morton, Rose, & Co., Messrs.	1	1	-	-
Mosenthal, Sons & Co., Messrs.	1	1	-	-
Moss, Mrs. G. W.	2	2	-	-
Mosse, John K., Esq., R.N.			-	5 -
Mossley Co-operative Industrial Society, Limited			3	3 -
Mountsteven, Major F. H.	1	1	-	-
Mountsteven, Mrs.			1	- -
Mowbray, John J., Esq.	10	-	-	-
Muggeridge & Co., Messrs.	1	1	-	-
Muir, Archibald, Esq. (1891-6, £70)			10	- -
Mullard, Thos. S., Esq.	-	10	6	-
Müller, C. J., Esq.	1	1	-	-
Mullins, Lieut.-Gen.	2	2	-	-
Munro - Mackenzie, Mrs. J. H.	1	-	-	-
Myers, W. H., Esq., M.P.	2	2	-	-
Mytton, Miss B. A.	2	2	-	-
Ditto (1890-6, £22 1s.)			3	3 -

Carried forward . £3159 13 6 5987 - 11

	Ann. Subs.		Donations.			Ann. Subs.		Donations.						
	£.	s. d.	£.	s. d.		£.	s. d.	£.	s. d.					
Brought forward . . .	3159	13	6	5987	-	11	Brought forward . . .	3111	16	6119	17	5		
Nairn, John, Esq.	5	-	-	-	-	-	Odd Fellows (M. U.), Loyal							
Napier-Clavering, Rev. J. W.,							Friend in Need Lodge . . .					- 13	6	
B.A.	1	1	-	-	-	-	Ditto, Princess Royal Lodge	1	1	-	-	-	-	
Nash, W. J., Esq.	1	1	-	-	-	-	Ditto, Prosperity Lodge . . .	1	1	-	-	-	-	
National Telephone Co.,							Ditto, Loyal Sons of the							
Limited	15	-	-	-	-	-	Thames Lodge, No. 3306,							
Naylor, Benzon, & Co., Messrs.	5	5	-	-	-	-	collection					- 15	6	
Naylor-Leyland, Mrs M. A. . .	5	5	-	-	-	-	Ditto	1	1	-	-	-	-	
Neilson & Sons, Messrs. Claud	2	2	-	-	-	-	Ditto, Ipswich District . . .	4	4	-	-	-	-	
Nelson Co-operative and In-							Offley, Forrester, & Co., Messrs.	2	2	-	-	-	-	
dustrial Society, Limited . . .			2	2	-	-	O'Neill, Mrs. S. L.	1	1	-	-	-	-	
Nelson, Dale, & Co., Limited	1	1	-	-	-	-	Onslow, Hon. Mary K. (1882-							
Nesbitt, Chas. M., Esq.	-	10	-	-	-	-	96, £31 10s.)					2	2	-
Nesbitt, Messrs. A. & W.							Onslow, Miss M.	1	-	-	-	-	-	
(for 1895-6)	2	2	-	-	-	-	Oppenheim, Henry, Esq. . . .	5	-	-	-	-	-	
"Nessie"	2	2	-	-	-	-	Oriole, s.s., collected on board							
Nettlefold, J. S., Esq.	1	-	-	-	-	-	by Mr. J. Gwyer					- 10	-	
Nettlefold, Miss C. M.	1	1	-	-	-	-	Orizaba, s.s., collected on							
Neumann, George, Esq.	1	-	-	-	-	-	board by Capt. Clarke					2	5	-
Newcastle Trinity Board . . .	10	10	-	-	-	-	Oruba, s.s., collection per Capt.							
Newcastle-upon-Tyne Co-							Lindsay Hay					5	-	-
operative Society, Limited							Osborne, Martin, Esq.	1	1	-	-	-	-	
(1892-6, £100)			25	-	-	-	Otter, R. H., Esq.	5	-	-	-	-	-	
Newcombe, F. W. D., Esq. . . .	1	1	-	-	-	-	Ottley, R. W., Esq.					1	1	-
Newsom, S. H., Esq.	1	-	-	-	-	-	Outram, Sir Francis B., Bart.	2	-	-	-	-	-	
Newton, Major J. W. Marsdin,							Outram, The Dowager Lady	2	-	-	-	-	-	
R.A.	1	1	-	-	-	-	Ouvry, Miss					1	1	-
Newton, Major W. H., R.A. . . .	5	-	-	-	-	-	Ditto, (1890-6, £2 11s.) . . .					- 10	-	
Nicholl, Henry F., Esq.	5	5	-	-	-	-	Ouvry, Miss Aimée	1	1	-	-	-	-	
Nicolls, F. H. S., Esq.			5	-	-	-	Ouvry, Miss Ethel A. E. . . .	1	1	-	-	-	-	
Nicholson, Mrs. Stuart	1	1	-	-	-	-	Owen, C. Whitley, Esq.					1	1	-
Nicolson, Admiral Sir F. W.,							Owen, Mrs. R. K. W.	1	1	-	-	-	-	
Bart., C.B.	1	-	-	-	-	-								
Nixon, Mrs. C. J.	-	10	-	-	-	-								
Nixon, Gower & Co., Messrs.	1	1	-	-	-	-								
Noble, R. H., Esq.	5	-	-	-	-	-								
Noble, Wilson, Esq.	2	2	-	-	-	-								
Noel, Com. G. H. U., R.N. . . .	1	1	-	-	-	-								
Norris, Miss A. H. (Ann.														
Sub. 10s., paid in 1895). . . .	1	1	-	-	-	-								
Norsworthy, G., Esq.	1	1	-	-	-	-								
Norsworthy, W. P. W., Esq. . . .	1	1	-	-	-	-								
Northampton, Admiral the														
Most Hon. the Marquis of . . .	10	-	-	-	-	-								
Northern Co-operative Co.,														
Limited (1895-6, £10)			5	-	-	-								
Northumberland. His Grace														
the Duke of, K.G.	2	-	-	-	-	-								
Northumberland Sailing														
Club, proceeds from Ad-														
vertisement Costume at														
Fancy Dress Ball worn by														
Mr. H. J. Richardson			6	6	-	-								
Norton, Mrs. A. H.	1	1	-	-	-	-								
Norwich Co-operative Society,														
Limited	2	2	-	-	-	-								
Norwood, Miss.			10	-	-	-								
Notting, Wm., Esq.	2	2	-	-	-	-								
Nottingham, Mrs.			50	-	-	-								
Nubia, s.s., collected on														
board, per Capt. Browne			5	1	-	-								
Oakes, J. H., Esq.	1	1	-	-	-	-								
Oakes, Mrs. S. C.	1	1	-	-	-	-								
Oakley, Christopher, Esq.	1	1	-	-	-	-								
O'Brien & Butcher, Messrs. . .	-	10	6	-	-	-								
O'Brien, Mrs. M.			10	-	-	-								
Odd Fellows, Independent														
Order of (M. U.)	50	-	-	14	7	6								
Carried forward	£3311	16	-	6119	17	5	Carried forward	£3376	12	6	6141	17	5	

	Ann. Subs.		Donations.	
	£. s. d.	£. s. d.	£. s. d.	£. s. d.
Brought forward	3376	12 6	6141	17 5
Pechey, J. T. P., Esq.	1	1	-	-
Peel, Edmund Yates, Esq.	1	-	-	-
Peirse-Duncombe, G. T., Esq.	3	3	-	-
Pembroke Castle, s.s., collection per Capt. Creaghe	-	-	6	5 6
Peninsular and Oriental Steam Navigation Company	5	5	-	-
Penn and Sons, John, Limited	1	1	-	-
Pennington, Mrs.	1	1	-	-
Pennay, W. B., Esq., R.N.	1	1	-	-
Penson, Mrs.	3	3	-	-
Perch, G. W. M., Esq.	1	1	-	-
Percy, The Right Hon. the Earl, P.C.	2	-	-	-
Perrott, Col. Sir Herbert C., Bart. "In Memoriam" Sir Edwd. G. L. Perrott, Bart.	1	1	-	-
Perth, City of, Co-operative Society, Limited (1895-6, £13 8s.)	-	-	10	-
Pete, W. H., Esq. (1894-6, £15)	-	-	5	-
Phillips, J. W., Esq.	2	2	-	-
Phillimore, Admiral Sir A., K.C.B.	3	-	-	-
Phillips, W. W., Esq.	1	1	-	-
Phillipps & Graves, Messrs.	1	1	-	-
Phillipson, Alfred T., Esq.	-	7	6	-
Philomel, s.s., collection by Mr. J. Gwyer	-	-	1	9
Phipson, Miss Caroline E.	1	-	-	-
Ditto (1891-6, £7)	-	-	4	-
Pick, Edgar S., Esq.	1	1	-	-
Pierce, Edward, Esq.	1	1	-	-
Pigot, Miss M. E.	1	-	-	-
Pigott, Commissary-General A. W. (1873-96, £49 7s.)	-	-	5	5
Pilcher, Giles T., Esq.	2	2	-	-
Pilcher, R. A., Esq.	1	1	-	-
Pitley, F. H., Esq.	1	1	-	-
Pilman & Phillips, Messrs.	-	10	-	-
Pinel, Mrs. M.	-	5	-	-
Pincock, W., Esq.	-	10	6	-
Pirie & Co., Messrs. John	2	2	-	-
Pitt, Miss Ellen	-	5	-	-
Pittar, Mrs.	-	-	10	-
Plummer, Rev. W. H., B.A.	-	-	10	-
Poß, Lt.-Col. W. Hutcheson, C.B., and Mrs. Poß	5	5	-	-
Pollock, Mrs. Robert	1	1	-	-
Pomeroy, W. K., Esq.	-	-	5	-
Ponteburn, ship, collected on board, per Capt. Jensen	-	-	1	1
Poole, Mrs. G. (1891-6, £8)	-	-	2	-
Pooley, Walter M., Esq., in aid of Giles' Quay Life-boat (for 1896-1900)	5	5	-	-
Pope, Miss C. E. S.	5	-	-	-
Pope, Miss M. J.	1	-	-	-
Port Blakeley, Washington, proceeds of concert given by officers of the ships <i>Senator</i> , <i>Rimac</i> and <i>Snaigow</i> , per H. B. Murdock, Esq.	-	-	2	15 5
Porter, Rev. C. F., M.A.	-	10	-	-
Porter, Capt. H. R.	1	1	-	-
Portsea Island Mutual Co-operative Society, Ltd. (1895-6, £10 5s.)	-	-	5	5
Potter, F. M., Esq.	-	10	-	-
Potter, Septimus C. Esq.	2	2	-	-
Powell, Messrs. T. J. and T.	1	1	-	-
Powney, C. du Pre, Esq.	5	-	-	-
Præd, Miss E. (1894-6, £3)	-	-	1	-

Carried forward . £3444 14 6 6201 8 4

	Ann. Subs.		Donations.	
	£. s. d.	£. s. d.	£. s. d.	£. s. d.
Brought forward	3444	14 6	6201	8 4
Prall, Z. E., Esq.	2	2	-	-
Prescott, H. W., Esq.	2	2	-	-
Preston, Miss Jane	-	-	5	-
Preston, Miss L. F. M.	5	-	-	-
Preston, R. A. B., Esq., in aid of Cornish Life-boats	50	-	-	-
Price, Miss (Beechworth) (1895-6, £2 1s.)	-	-	1	-
Price, Mrs. H. D.	5	-	-	-
Price and Pierce, Messrs.	5	5	-	-
Prichard, Thos., Esq., in aid of Anglesey Branch	-	10	-	-
Priestley, Wm., Esq.	1	1	-	-
Primrose, The Hon. B.F., C.B.	2	2	-	-
Prince, John, Esq.	2	2	-	-
Prince, Mrs. (1891-6, £30)	-	-	5	-
Prince Leopold, s.s., collection by Mr. J. Gwyer	-	-	1	2 8
Princess Helena, s.s., collection by Mr. J. Gwyer	-	-	-	7 9
Prior, Mrs.	-	10	6	-
Procter, Messrs. Robert & Sons	1	1	-	-
Procter, Robt., Esq.	1	1	-	-
Prowse, Capt. G. J. W.	1	1	-	-
Pulford, Alfred, Esq.	5	5	-	-
Pumphrey, T., Esq.	1	1	-	-
Purey-Cust, Commr. H. E., R.N., and Mrs. (1889-96, £19 10s.)	-	-	1	-
"Queenie" (1883-96, £23 2s.)	-	-	3	3
Quick, Mrs. R. H.	5	5	-	-
Quilter, Mrs. A. A.	-	-	5	-
"Quiver" Life-boat Fund, per Messrs. Cassell & Co., Ltd.	-	-	-	15
R. B. and Co. (1867-96, £199 7s.)	-	-	2	-
R. B. J. (1879-96, £90)	-	-	15	-
R. D. (1890-6, £3 10s.)	-	-	-	10
R. R.	-	-	5	-
Rackham, W., Esq.	1	1	-	-
Radstock Co-operative and Industrial Socy., Limited (1895-6, £10)	-	-	5	-
Rahn and Co., Messrs.	1	1	-	-
Ralli Brothers, Messrs.	2	2	-	-
Ralph, Mrs.	1	-	-	-
Ramsay, Capt. John, R.E.	2	-	-	-
Ramsbottom Industrial and Provident Socy., Limited (1895-6, £4)	-	-	2	-
Randells and Co., Messrs.	1	1	-	-
Randolph, Admiral G. G., C.B.	5	-	-	-
Raphael, E., Esq (1891-6, £4 7s.)	-	-	-	10
Rathbone & Son, Messrs. E.	1	1	-	-
Rawlins, Mrs. (for 1895-6)	2	-	-	-
Rayer, Miss	1	1	-	-
Raymond & Reid, Messrs.	1	1	-	-
Rayner, Miss G.	1	1	-	-
Rayner, Mrs. T. V.	1	1	-	-

Carried forward . £3557 13 - 6249 1 9

	Ann. Subs.		Donations.	
	£.	s. d.	£.	s. d.
Brought forward	3557	13	6249	1 9
Redcar, proceeds of performance on the sands by Australian Bellringers and entertainment arranged by Life-boat coxswain and crew on 21st August			10	- -
Rees, J., Esq.	-	10	6	
Reid, Major-Gen. James (1894-6, £2)			1	- -
Reid, Miss	5	-	-	
Reinachs, Nephew and Co.	-	10	6	
Reiss Bros., Messrs.	2	2	-	
Rendle, George, Esq.	1	1	-	
Beneau, Mr. & Mrs. R. P. W.	1	1	-	
Resolution, H.M.S., collected amongst officers, per Rev. G. H. Trehearne, R.N.			1	3 -
Reynolds, Rev. E. M., M.A.	1	1	-	
Reynardson, Miss E. M. B.	1	1	-	
Rhosuegir, net proceeds of concert in Life-boat house			15	1 6
Riach, General W. A.	2	2	-	
Riach, Miss E.	1	-	-	
Riadore, The Misses (1894-6, £2)			1	- -
Rice, Lionel K., Esq.	5	5	-	
Richardson Brothers and Co.	1	1	-	
Richardson, Dr. Wm., R.N.	3	3	-	
Richardson, Miss Rowley	1	1	-	
Richmond British School, collection, per Mr. J. Lancaster.			-	5 -
Richmond, J., Esq.	5	-	-	
Rickett, Smith & Co., Messrs.	1	1	-	
Ricketts, Master E. W. C.			-	5 -
Ridgway & Co., Messrs.	2	2	-	
Ridley, C. E., Esq.	2	2	-	
Ripley Co-operative Socy., Ltd. (1895-6, £4 4s.)			2	2 -
Ritchie, Miss			1	- -
Rivington, Capt. G., R.N.	-	10	6	
Roake, J. J., Esq.	-	10	-	
Robartes, The Rt. Hon. Lord	5	-	-	
Robbs, Miss	1	1	-	
Roberts, Alexr., Esq.	-	10	-	
Roberts, C. W., Esq.	2	2	-	
Roberts, Jas., Esq.	1	1	-	
Roberts, Miss	-	10	6	
Roberts, W. H. E. W., Esq., R.N.	-	7	6	
Robertson, Capt. G. M.	5	-	-	
Robertson, J. C., Esq.	1	1	-	
Robertson, Mrs. Graham.	10	10	-	
Robins, Miss	1	-	-	
Robins, Miss G.	1	-	-	
Robinson, Miss C. (1895-6, 10s.)			-	5 -
Robinson, F. J., Esq.	3	3	-	
Robinson, Mrs. (collection)			-	14 6
Robinson, Mrs. Ansley	1	1	-	
Robinson, Miss	-	10	-	
Robinson, Miss Martha (1891-6, £2 4s.)			-	5 -
Robinson, Rev. T. B. B., M.A.	1	1	-	
Robinson & Sons, Messrs. T.	-	10	6	
Rochester and District Co-operative Society, Limited.	1	1	-	
Rodney, S. S., Esq.	1	1	-	
Roe, Mrs.	1	-	-	
Ditto (1893-6, £2 10s.)			-	10 -
Roffey, G. & Son, Messrs.	1	1	-	

Carried forward . £3634 9 - 6282 12 9

	Ann. Subs.		Donations.	
	£.	s. d.	£.	s. d.
Brought forward	3634	9	6282	12 9
Rogerson, Mr. and Mrs. Alex. (for 1895-6)	1	-	-	
Rogers, Mrs. G. A.	1	1	-	
Roget, Mrs. F. (addition to gift of Life-boat)	1	1	-	
Roland & Philipps, Messrs.	1	1	-	
Rolle, The Hon. Mark	10	-	-	
Rooper, Major H. G.	1	1	-	
Rose, Lady	5	-	-	
Rosenthal & Co., Messrs., proportion of rate of guarantee on sale of "Grace Darling" Jubilee Penny Starch Boxes from 1st Jan. to 31st Dec., 1895			5	16 2
Ross, Miss B. M.	2	-	-	
Ross, Surg.-Gen.	1	1	-	
Rothschild & Son, Messrs. N. M.	10	10	-	
Rothschild, Baron Ferdinand James de, J.P.			50	- -
Routh, Miss			2	- -
Rowe, Arthur W., Esq.	1	1	-	
Rowlandson, Miss Ann B.	1	1	-	
Rowley & Davies, Messrs. (for 1895-6)	2	2	-	
Royal Arsenal Co-operative Society, Ltd. (1895-6, £10)			5	- -
Royal London Yacht Club	2	2	-	
Royal Mail Steam Packet Co.	10	-	-	
Royal Sovereign, s.s., collected by Mr. J. Gwyer			-	19 7
Royal Welsh Yacht Club	2	2	-	
Royal Yacht Squadron	10	-	-	
Rubie, J. P., Esq. (for 1896-7)	2	2	-	
Ruck Keene, Rev. B. (1891-6, £3)			-	10 -
Rudge, The Misses (1893-6, £1 15s.)			-	10 -
Rugby Industrial and Provident Co-operative Society, Limited (1895-6, £10 5s.)			5	5 -
Rumford, L. M. & Co., Messrs.	-	10	6	
Rust, George J., Esq.	1	1	-	
Rust, Miss	1	1	-	
Rutter, Mrs.	1	1	-	
Ryder, I. H. D., Esq. (1889-96, £8 8s.)			1	1 -
Rye Harbour Sailors' Home, proceeds of Magic Lantern Lecture, per Mr. T. Johnstone			-	14 6
S. B. S.	2	2	-	
S. D. R. S. D. (1864-96, £2122 15s. 6d.)			100	- -
S. E.			2	- -
S. G. S. (in aid of Irish Life-boats)	10	-	-	
Saddlers, Worshipful Company of (1877-96, £75 15s.)			5	- -
Sadler, Harrison, & Co.	2	2	-	
Sage, E. C., Esq., and Mrs. Sage	1	1	-	
St. George the Martyr, Southwark, Young Men's Bible Class, per Rev. J. Darlington, B.A.			-	13 -

Carried forward . £3717 12 6 6462 2 -

	Ann. Subs.		Donations.	
	£.	s. d.	£.	s. d.
Brought forward	3717	12 6	6462	2 -
St. Germans, The Rt. Hon. the Earl of	5	- -		
St. Maur, The Right Hon. Lord Percy (1895-6, £10)			5	- -
St. Michael's, Paddington, Life-boat Fund			13	6 -
St. Rogwald, a.s., collected during trips to the North Cape, per J. T. Woolrych Perowne, Esq., and H. B. Lunn, Esq.			14	8 11
St. Sunniva, steam yacht, collected during cruises, per J. T. Woolrych Perowne, Esq., and H. B. Lunn, Esq.			11	18 9
Salisbury, L., Esq.	1	1 -		
Salters, Worshipful Comp. of Saltoun, The Right Hon. Lord Salisbury, Mrs.	10	10 -		
Samuelson, Sir B., Bart., M.P.	5	5 -		
Sanders, Richard B., Esq.	1	- -		
Sanders, F., Esq.	1	1 -		
Sanderson, Edwd. M., Esq.	1	1 -		
Sanderson, Mrs. (for 1895-6)	2	2 -		
Sandford, Miss A.	-	5 -		
Sandys-Lumsdaine, Mrs.	1	1 -		
Sandys-Lumsdaine, Miss	1	1 -		
Sandys-Lumsdaine, Miss A.C.	1	1 -		
Sargent, George, Esq.	1	1 -		
Sassoon and Co., Messrs. D.	2	2 -		
Saunders, Capt. F. W.	1	1 -		
Saunders, Mrs. (Blackheath)	2	2 -		
Saunders, Mrs. (Haverford-west) 1891-6, £14			2	- -
Savage and Sons, Messrs.	2	2 -		
Savile, Mrs. Stewart	20	- -		
Savory and Moore, Messrs.	3	3 -		
Sawtell, Geo. H., Esq.	1	1 -		
Sawyer, Rev. D. H., M.A.	10	- -		
Saxe-Weimar, General H.S.H. Prince Edward of, G.C.B.	1	- -		
Schloss Brothers, Messrs.	-	10 -		
Scholey, Mrs.	1	1 -		
Schroder & Co., Messrs. H.	2	2 -		
Schuster, Rev. W. P., M.A., and Mrs.	2	2 -		
Schwabe, Mrs. G. C.	3	- -		
Scotfield, Mrs. R. S., in aid of Rhosneigr Life-boat	1	1 -		
Scorer, A., Esq.	1	1 -		
Scott, Claude S., Esq.			-	10 6
Ditto (for 1896-7)	1	11 6		
Scott, E., Esq. (1869-96, £24 ls.)			1	1 -
Scott, J. W., Esq.	-	5 -		
Scott, Mrs. E. H.	1	- -		
Scott, Mrs. J.	1	1 -		
Scott, Miss, in aid of Margate Life-boat.	2	2 -		
Scott, Rev. M. R., M.A., & Miss Scott	1	1 -		
Scottish Co-operative Wholesale Society, Limited (1893-6, £85)			13	- -
Scriven House, Scarborough, result of fines, per W. McConnell, Esq.			-	5 -
Seife, Mrs.	1	- -		
Senhouse, Miss (for 1896-7)	1	- -		
Seton, Reginald V. F., Esq.	-	10 6		
Seyern, J. P., Esq.	3	3 -		
Seyd & Co., Messrs.	1	1 -		
Seymour, Gen. W. H., C.B.	1	- -		

Carried forward £3808 15 6 6528 12 2

	Ann. Subs.		Donations.	
	£.	s. d.	£.	s. d.
Brought forward	3808	15 6	6528	12 2
Shakerley, The Dowager Lady (1891-6, £60)			10	- -
Shapley, F., Esq., M.R.C.S. (for 1895-6)			2	2 -
Sharp, Wm., Esq.	1	1 -		
Sharps and Wilkins, Messrs.	1	1 -		
Shaw, Miss H. P.	1	- -		
Shaw, Mrs.	1	1 -		
Shaw, Mrs. A.	1	1 -		
Sheepshanks, W., Esq.	1	1 -		
Sheldon, Miss Lillian	2	2 -		
Sheldon, Rev. J., M.A. (1881-96, £160)			10	- -
Shepard & Co., Messrs.	2	2 -		
Shepherd, A., Esq. (1869-96, £56)			2	- -
Shepherd, T., Esq.	2	2 -		
Shepherds, Loyal Order of Ancient (A. U.)			20	- -
Shiffner, Mrs.	1	1 -		
Shipwrecked Fishermen and Mariners' Society (Coll.)			1	4 -
Sibthorp, Colonel	5	5 -		
Silvester, Miss F. (The Misses, 1886-96, £31)			2	- -
Simm, Mrs. M.	1	1 -		
Simonds, Robt. Henville, Esq.	1	1 -		
Simpson, B. W., Esq.	1	1 -		
Simpson, Miss	-	10 -		
Simpson, Mrs. J. Brown	1	- -		
Simpson, J. B., Esq.	1	1 -		
Simpson, R., Esq.	1	1 -		
Sinclair, Bland G., Esq.			1	1 -
Sinclair, William Frederic, Esq., I.C.S. retired (1895-6, £15 10s.)			10	10 -
Sinnott, J. R., Esq.	-	5 -		
Sismey, Thomas, Esq., and Mrs. Sismey			2	2 -
Skelton Bros., Messrs.	1	1 -		
Skelton & Co., Messrs. T.	-	10 -		
Skinner, Edward, Esq.	1	1 -		
Skinner, The Misses	1	1 -		
Skinner, Thos., Esq., M.D.	2	2 -		
Skinner's, Worshipful Company of (1865-96, £231)			21	- -
Slater, Miss (1895-6, £1)			-	10 -
Slater, Miss	2	2 -		
Slatford, W. J., Esq.	-	10 -		
Sly, A. H., Esq.	1	1 -		
Smart, Mrs. (in addition to special Life-boat gifts)	5	5 -		
Smellie, Miss	2	2 -		
Smellie, Thos. D., Esq.	1	- -		
Smiles, S., Esq. (1892-6, £10 10s.)			5	5 -
Smith & Sons, Messrs. B.	1	1 -		
Smith and Sons, G., Messrs.	2	2 -		
Smith, A. E., Esq. (1893-6, £1)			-	10 -
Smith, Henry A., Esq.	2	2 -		
Smith, J. Duke, Esq.	1	1 -		
Smith, J. MacLaren, Esq. (for 1895-6)			20	- -
Smith, J. W., Esq.	1	1 -		
Smith, Gen. J. W. S., C.B.	1	1 -		
Smith, Miss Bryan	1	1 -		
Smith, Miss F. Felix	2	2 -		
Smith, Miss, Northiam (1893-6, £5)			1	- -
Smith, Mrs. A. Watson			1	1 -
Smith, Mrs. McLeod			2	2 -
Smith, Mrs. Vernon	1	1 -		
Smith, Mrs. W. Wilthew	5	- -		

Carried forward £3894 3 6 6616 15 2

	Ann. Subs. Donations.					Ann. Subs. Donations.							
	£.	s.	d.	£.		s.	d.	£.	s.	d.			
Brought forward	3894	3	6	6616	15	2	Brought forward	3980	4	6	6646	3	2
Smith, H. F., Esq. (1895-6, £4 4s.)				2	2	-	Stokes, Mrs.	1	1	-			
Smith, Samuel, Esq. (1892-6, £1 15s. 6d.)				-	5	-	Stolterfoht, Miss J. E. (1894-6, £2)				-	10	-
Smith, Sir C. Euan, K.C.B.	5	-	-				Stone & Co., Messrs. J.	2	2	-			
Smith, The Hon. W. F. D., M.P.	5	5	-				Stone, John, Esq. (1877-96, £36)				5	-	-
Smith, Elder & Co., Messrs. (1870-96, £172 2s.)				6	6	-	Stone, Mrs. John (Ann. Sub. £1, paid in 1895)						
Smitheman, The Misses (in addition to a Life-boat)	2	2	-				Stoneham, F., Esq.	-	10	6			
Smithers, H. W., Esq.	1	1	-				Stopford, Mrs. Grosvenor	1	-	-			
Smyth, Messrs. Ross & Co.	-	10	-				Storer, Mrs. Charles	1	-	-			
Smythies, G., Esq.	2	2	-				Strafford, The Rt. Hon. the Earl of	3	3	-			
Soames, W., Esq.	1	1	-				Straker, Mrs. Isabella	2	2	-			
Soden, Henry, Esq.	1	1	-				Stranack, Capt. H.	-	10	6			
Solari, Miss	1	1	-				Straton, Mrs. Alexr.	-	10	-			
Somerset, His Grace the Duke of (1894-6, £11 1s.)	5	-	-	5	-	-	Streatfield, R. J., Esq.	5	-	-			
Somes, Mrs. Maria.	1	1	-				Stringer, C. W., Esq.	-	5	-			
Soundy, Mrs. J. S. (in memoriam of her dear son Walter lost at sea)	1	1	-				Strong, Rawle, and Strong, Messrs.	2	2	-			
Souter, Miss	1	1	-				Stuart, Geo., Esq.	3	-	-			
Ditto, in aid of Rhosneigr Life-boat	1	1	-				Stuart, J. N., Esq.	5	5	-			
South Metropolitan Gas Light and Coke Company.	5	5	-				Stuart, Patrick Crichton, Esq.	1	1	-			
Southard and Co., Messrs.	2	2	-				Stuckenschmidt, L., Esq.	1	1	-			
Soutter, Ernest, Esq.	5	-	-				Stucley, Lieut.-Col. W. M. L.	1	-	-			
Soutter, William, Esq. (1891-6, £9 9s.)				2	2	-	Studd, Mrs. Kyneston				1	-	-
Spalding Shipwreck Society	1	1	-				Stunt, Miss (1891-6, £14)				2	-	-
Spawforth, Joseph, Esq.	5	5	-				Sturrock, Major Archibald	5	5	-			
Spencer, Mrs. E.	2	2	-				Sturt, E. A. Esq.				1	-	-
Spencer, Rev. W. M.	1	1	-				Sugden, Miss C.	1	1	-			
Sperling, Arthur, Esq.	1	1	-				Sullivan, Admiral T. B. M.	1	-	-			
Spies Brothers & Co., Messrs. (1879-96, £65)				5	-	-	Sums under 5s.	2	3	6	5	13	5
Spilsbury, Major-General	1	1	-				Sunderland Equitable Industrial Society, Ltd.	3	3	-			
Spottiswoode, Miss Mary.	1	-	-				Surr, Watson, Esq.	1	1	-			
Spratt's Patent Biscuit Co.	-	10	6				Surrey Commercial Dock Co.	5	5	-			
Sprawson, Miss C. C.				-	5	-	Sutcliff, Mrs.	-	10	-			
Sprigens, Miss	1	1	-				Sutherland, H., Esq.	1	1	-			
Spring-Rice, Lieut. the Hon. Francis, R.N.	1	-	-				Swain, E., Esq. (1895-6, 10s.)				-	5	-
Sprunt, Miss	1	1	-				Swainson, Rev. A.	1	-	-			
Squarey, Mrs. M. K. (1891-6, £24 14s.)				5	5	-	Swanzy, Messrs. F. and A.	1	1	-			
Squire, D. B., Esq.	2	2	-				Swinburne, Sir J., Bart., F.R.S.	5	-	-			
Stair, The Right Hon. the Earl of, K.T.	10	-	-				Swinton, The Hon. Mrs.				10	-	-
Standen, Wm., Esq.	-	10	-				Sykes, George H., Esq.	1	1	-			
Standidge and Co., Messrs.	1	1	-				Sykes, Joseph, Esq.	2	2	-			
Standing, Geo. C., Esq.	-	10	6				Sykes, John, Esq., M.D. (1893-6, £26)				1	-	-
Stanley, W. F., Esq.	1	1	-				Sykes, Miss M. A.	1	1	-			
Stanton, J. T., Esq.	1	1	-				Symonds, Wm. Thos., Esq.	2	2	-			
Starkey, W. J. S. Barber, Esq. (1891-6, £10 10s.)				2	2	-	T.				5	-	-
Starky, Mrs., the late.	1	-	-				T. (Weymouth)				2	2	-
Steele, Mrs.	1	1	-				T. W. R. (1891-6, £300)				50	-	-
Steib, A. C., Esq.	1	1	-				Taddy and Co., Messrs.	3	3	-			
Stephen, Leslie, Esq.	2	2	-				Tallow Chandlers, The Worshipful Company of (1887-96, £52 10s.)				5	5	-
Stephens, P. S., Esq., Q.C.	2	2	-				Ditto, a few members of the Court of Assistants, per M. F. Monier Williams, Esq.				4	4	-
Steuart, D. R., Esq.	1	-	-				Tangyes, Limited, Messrs.	1	1	-			
Steward, Mrs. J. C. (1895-6, £2 2s.)				1	1	-	Taniere, Mrs. J.	1	-	-			
Stewart, Robt., Esq.	-	10	-				Tantallon Castle, Royal Mail s.s., collected on board, per Capt. Robinson				30	-	-
Stiebel Brothers, Messrs.	1	1	-				Tanqueray & Co., Messrs. C.	2	2	-			
Stilwell & Sons, Messrs.	1	1	-				Tapling and Co., Messrs.				2	2	-
Stock, Mrs., in memory of Colonel Stock	-	1	-				Thomas, Limited	2	2	-			
Stock, Lieut. A. R. A., R.N.	1	-	-				Tarner, E. T., Esq.	1	-	-			
Carried forward	£3980	4	6	6646	3	2	Carried forward	£4055	2	-	6769	2	7

	Ann. Subs.		Donations.	
	£.	s. d.	£.	s. d.
Brought forward . . .	4055	2	6769	2 7
Tarner, G. Edward, Esq. . .	1	1	-	-
Tarner, Miss C. T.	1	-	-	-
Tarner, Miss L. T.	-	10	-	-
Tassell, Mr. J.	-	5	-	-
Tate, Miss C. E.	1	1	-	-
Tatham, Mrs. C. A. (1891-6, £5 3s.)	1	1
Tatlock, Miss H. H.	5	-
Tatton, Lees W., Esq.	1	1	-	-
Tatton, Mr. Samuel	-	10	-	-
Taylor, Miss M. E.	-	10	6	-
Taylor, Charles, Esq.	1	1	-	-
Taylor, G., Esq.	1	1	-	-
Taylor, Mrs. B.	1	1	-	-
Taylor, Mrs. E. H. (1892-6, £1)	-	5
Taylor and Sons, Messrs. J.	1	1	-	-
Taylor, Seth, Esq.	1	1	-	-
Teasdale, Isaac, Esq.	1	1	-	-
Temperleys, Carter, & Darke, Messrs.	1	1	-	-
Tesdorpf & Co., Messrs. A.	2	2	-	-
Tetley and Co., Messrs. J.	1	1	-	-
Thackthwaite, Miss C. M. (1895-6, £1)	-	10
"Thames" (1892-6, £3 13s.)	1	1
Thames & Mersey Marine Insurance Co.	10	10	-	-
Theobald, Mrs.	1	1	-	-
Thomas, Col. (1891-6, £7)	2	-
Thomas, Mrs. Charles.	-	10	6	-
Thomas, G. E., Esq.	-	5	-	-
Thomas, Miss	1	1	-	-
Thomas, Miss Frances	1	10	-	-
Thomas, Miss K. B.	1	1	-	-
Thomas, Mr. W.	-	10	-	-
Thomas, Mrs.	2	2	-	-
Thomas, W. F., Esq.	5	-	-	-
Thompson, Mrs., Bryn Alt	1	-	-	-
Thompson, Mrs., Glencairn	1	-	-	-
Thompson, Mrs., Rosemount, in aid of Rhosneigr Life-boat	1	1	-	-
Thompson, Messrs. W. J. & H.	2	2	-	-
Thomson, J. R., Esq., Collected by (vide New Quay Branch, p. 793)	19	16 6
Thorngate, W., Esq. (thelate), Trustees of	80	-	-	-
Thornton, T., Esq.	1	1	-	-
Thorpe, Mrs. B. K.	-	10	-	-
Threlfall, Charles, Esq.	5	5	-	-
Thresher, Capt. W.	2	2	-	-
Thurlow, Major Edwd. H.	1	1	-	-
Tilbury Pier, collected by Mr. J. Gwyer	-	9 7
Tillard, P. E., Esq., in aid of Gorleston Life-boat	1	1	-	-
Tindall, Riley, & Co., Messrs.	1	1	-	-
Tippings, Comm. L. F. G., R.N.	2	-	-	-
Tobin, Lady	1	-	-	-
Ditto (1895-6, £8)	5	-
Toller, Mrs. Wallis	1	1	-	-
Tomlinson, Miss (1891-6, £19 5s.)	2	-
Tooth, Mrs.	1	-	-	-
Toppin, The Misses	1	1	-	-
Touch, Lieut.-Gen. J. G.	1	1	-	-
Tower, FitzPatrick, Esq.	1	1	-	-
Toynbee, Capt. H. (Ann. Sub. £1 1s., paid in 1895)	1	4
Tracy, Mrs. (1895-6, £1 14s.)	1	4

Carried forward . £4200 9 - 6807 9 8

	Ann. Subs.		Donations.	
	£.	s. d.	£.	s. d.
Brought forward . . .	4200	9	6807	9 8
Trall, James P., Esq.	5	5	-	-
Trench, Louis, Esq.	1	-	-	-
Trimnell, Miss E.	1	1	-	-
Trotter, Mrs. H. E. (1888-96, £18 18s.)	2	2
Troyte, Colonel C. A. W.	1	1	-	-
Tryon, The Hon. Lady	1	-	-	-
Tubbs, Lewis & Co., Messrs.	1	1
Tuckerman, Mrs. M. F.	5	-
Tunstall, Miss Gertrude	-	10	-	-
Turle, Dr.	1	1	-	-
Turle, Mrs.	-	10	6	-
Turner, B. T., Esq.	1	1	-	-
Turner, J. S., Junr., Esq. (1894-6, £2)	1	-
Turner, Miss E. A. (1887-96, £6 3s.)	-	5
Turner, Miss I.	1	1	-	-
Tweddle & Co., Messrs., 35, South John Street, L'pool, W.	5	5	-	-
Twining, H. H., Esq.	1	1	-	-
Two Friends, per Miss Worcestercroft	1	-	-	-
Two Sisters.	-	5	-	-
Two in sympathy	1	1	-	-
Tydd, Mrs.	1	1	-	-
Tylden, Mrs.	1	1	-	-
Tyler, Arthur, Esq.	-	10	-	-
Tyndall, W. H., Esq.	1	1	-	-
Uthoff & Co., Messrs.	1	1	-	-
Upton, Henry, Esq. (Ann. Sub. £3 3s., paid in 1895)	1	1
Urwick, W. H., Esq.	1	1	-	-
Usborne and Sons, Messrs.	1	1	-	-
Ditto, for Mark Lane Life-boat	1	1
Usborne, Mrs.	1	1	-	-
Vale of Leven Co-operative Society, Limited (1895-6, £6 6s.)	3	8
Valetta, s.s., collected from Stewards, &c., per Mr. E. A. Williams	5	7 6
Vanner and Prest, Messrs.	1	1	-	-
Vardon, Henry, Esq.	1	1	-	-
Veasey, H., Esq.	1	1	-	-
Veasey, Rev. F. M.A.	1	-	-	-
Veitch, Mr. and Mrs. J. A.	5	-	-	-
Venning, Edgcombe, Esq.	1	1	-	-
Vernon, Lieut.-Col. G. A., the late (1894-6, £50)	25	-
Vernon, Miss	-	5
Vernon, Miss Emma P.	1	1	-	-
Vernon, Mrs.	1	1	-	-
Veyret, Madame P. A.	1	1	-	-
Vincent, J., Esq.	1	1	-	-
Vivian, Lt.-Col. A. P., C.B., J.P.	1	1	-	-
Vivian, Master G. L.	-	7
Vivian, Younger, and Bond, Messrs.	1	1	-	-
Vogan & Co., Messrs.	1	1	-	-
"Voluntary Taxation" (1892-6, £2 10s.)	-	10

Carried forward . £4249 - 6 6851 10 2

	Ann. Subs.			Donations.				Ann. Subs.			Donations.			
	£.	s.	d.	£.	s.	d.		£.	s.	d.	£.	s.	d.	
Brought forward	4249	-	6	6851	10	2		Brought forward	4348	16	-	6888	12	2
Von Roemer, Baron C. H. (1895-6, £20)				10	-	-		West Pelton District Co-operative Industrial and Provident Society, Limited (1895-6, £7 2s.)				5	-	-
Vortigern Ship Company, Ltd. (1891-6, £5 5s.)				1	1	-		Westbury, Claude, Esq.	1	1	-			
W. A. D.	10	-	-					Westminster, His Grace the Duke of, K.G., P.C., F.R.G.S.	10	-	-			
W. B.	-	10	6					Weston, James, Esq.	1	1	-			
Wakefield, Mrs. J.				1	-	-		Weston and Westall, Messrs.	1	1	-			
Wakeley Brothers, Messrs.	-	10	6					Weston, W., Esq.	1	1	-			
Waldegrave, Hon. E.				1	-	-		Whalley, F. R., Esq.	2	2	-			
Waldegrave, The Rt. Hon. the Earl	5	5	-					Wharton, Rear-Admiral W. J. L., C.B., F.R.S.	2	2	-			
Walker, C., Esq. (1885-96, £105)				10	-	-		Wharton, W. H. A., Esq.				20	-	-
Walker Co-operative Society, Limited	2	2	-					Whately, Mrs. (1888-96, £50)				10	-	-
Walker, Geo., Esq., Wimbledon	1	1	-					Wheeler, George, Esq.	1	1	-			
Walker, Mrs. Arthur	2	2	-					Wheeler, H. S., Esq.	1	1	-			
Walker, Miss, and Miss H. (1892-6, £3 10s.)				-	10	-		Wheeler, Robert D., Esq.	1	1	-			
Wall, Wm., Esq.	1	1	-					Whish, G. T., Esq.	1	1	-			
Wallace Brothers, Messrs.	3	3	-					Whish, Mrs., The late, "In memoriam"	1	1	-			
Walmsley, Miss				2	2	-		Whitaker, James, Esq.				1	-	-
Walpole, F. G., Esq.				1	-	-		Whitaker, Thomas Stephen, Esq.				20	-	-
Walrond, C. T., Esq., C.E.	1	1	-					Whitaker, W. Ingram, Esq. (Ann. Sub. £25, paid in 1895).				1	1	-
Ward, J. Brocks, Esq.	3	3	-					White Brothers, Messrs.	1	1	-			
Ward, Admiral Thomas Le Hunte, C.B.	1	1	-					White, Capt. J. Kearney	1	-	-			
Ware, Miss	3	3	-					White, His Honour Judge Meadows, Q.C. (1893-6, £10 5s.)				5	-	-
Warman, H. W., Esq.	-	5	-					White, Edward Felix, Esq.	50	-	-			
Warmsley, Mr.	-	5	-					White, Miss S. E.	25	-	-			
Warner Bros., Messrs.	-	10	-					White, Mrs. J. F., The late	1	1	-			
Warner, Mrs. S.	-	10	-					White, John, Esq.	1	1	-			
Warner, R., Esq.	1	1	-					Whiteley, Rev. J. H., M.A.	1	1	-			
Warren, W. T., Esq. (1894-6, £1)				-	10	-		Whiteman, Miss E. H.	1	1	-			
Warwick Castle, s.s., collected on board, per Capt. Wallace				3	5	-		Whiteman, Stephen, Esq., the late, In memory of	1	-	-			
Waterall, Nathaniel, Esq., Waddon, Croydon	1	1	-					Whiting, R. M. & H., Messrs.	-	10	-			
Waterall, Roby, Esq.	1	1	-					Whitley, E. G., Esq.	-	10	-			
Watson, Mrs. G. Bowes	1	1	-					Whitton, John, Esq.	-	10	-			
Watson, Mrs. E. M.	10	10	-					Whymper, Mrs.	1	1	-			
Watson, Col. W. H., R.A., in aid of Holy Island Life-boat	5	-	-					Whyte, Admiral W. H.	1	-	-			
Watt, Moon & Co., Messrs. (1894-6, £6 6s.)				2	2	-		Wieting & Richter, Messrs.	1	1	-			
Watters, Miss Agnes	1	1	-					Wigg, Mrs. E.	1	-	-			
Wattson, Benj. G., Esq.	-	10	6					Wiginton, Miss L. L.	1	1	-			
Webb, Mrs. F. E.	1	1	-					Wild, Miss Elizabeth	-	10	6			
Webb, Lieut. V. B., R.N.				-	5	-		Wilkinson, Mrs. R. J.				2	2	-
Weber, The Hon. Arthur, M.C.P., Demerara	1	1	-					Willcox, Robt. M., Esq.	2	2	-			
Weder, J. C., Esq.				-	15	-		Willlett, Dr.	1	1	-			
Weill, Louis, Esq.	1	1	-					Williams, G. Mawdsley, Esq. (1892-6, £18 9s.)				3	-	-
Welch, Margetson, and Co., Messrs.	1	1	-					Williams, Herbert S., Esq.	1	1	-			
"Well-wisher"				1	-	-		Williams, R. B., Esq.				1	-	-
"Well-wisher"				-	10	-		Williams, The Misses	1	-	-			
Welsh, Rev. A., M.A.	5	-	-					Williams, Miss Elizabeth	1	-	-			
Welsh, Mrs. W. I.	1	1	-					Williams-Hepworth, Major	1	-	-			
Wentworth, Miss L. M. H. V.	10	-	-					Williamson, Miss	2	-	-			
Were, Mrs.	10	-	-					Willink, H. G., Esq.	2	2	-			
Were, Mrs. Bouville	2	2	-					Willis, W. E., Esq.	1	1	-			
Wernher, Mrs. Julius	10	10	-					Wilson, Miss	4	4	-			
West Calder Co-operative Society, Limited (1895-6, £4 4s.)				2	2	-		Wilson, George W., Esq.	1	1	-			
								Wilson, Admiral J. E. M.	1	1	-			
								Wilson, J. E., Esq.	5	-	-			
								Wilson, James, Esq.	1	-	-			
								Wilson, Mr. & Mrs. Henry J.	1	-	-			
								Wilson, Mrs., Ardgour Lodge (1895-6, £35)				10	-	-
								Wilson, Mrs. Joshua (1885-96, £104)				5	-	-
Carried forward	£4348	16	-	6888	12	2		Carried forward	£4487	10	6	6970	14	2

LEGACIES RECEIVED IN 1896.

FOR SPECIAL TRUST PURPOSES.			FOR GENERAL PURPOSES.		
	£	s. d.		£	s. d.
Atherstone, J. G., Esq., Montrose (balance)	487	6 2	Arkwright, J. C., Esq., Cromford	100	- -
Chapman, Mrs. M. A., Cathcart Road, S.W.	1100	4 4	Beatson, Mrs. Eliza, Norsend (balance)	88	3 7
Dudley, J. W., Esq., Woodford	700	- -	Beattie, Mrs. J., Hastings	300	- -
Groome, Mrs. H., New Ferry	1050	- -	Bellamy, Mrs. J., Southampton (balance)	46	16 -
Gwilt, Alfred, Esq., Norbiton	1000	- -	Benn, G. C., Esq., Rugby	1000	- -
Haxton, Mrs. J., Kirkcaldy	2000	- -	Bird, Mrs. M. C., Plymouth	100	- -
Heartwell, Miss Emily, Upper Holloway	700	- -	Callander, Captain John, Curley Dow, Scotland	1062	17 3
Hills, F. E., Esq., Redleaf, Penshurst	1050	- -	Cassady, Mrs. Isabella, Dumfries	20	- -
Hosken, Mrs. Sarah, Penryn	1115	14 5	Chalmers, W. M., Esq., Felixstowe	200	- -
Levy, G., Esq., Wood Green	1000	- -	Conway, Miss S. M., Astley Bridge	10	- -
Simmons, Miss Ida B., Hove	720	- -	Curtis, Mrs. M., Worthing (additional)	-	11 -
Smart, Stanhope, Esq., Dalton, Huddersfield	750	- -	Davy, Francis, Esq., Topsham	22	10 -
Thomas, Mrs. F. E., Nunney (additional)	2	19 10	Dean, W. H., Esq., Stratford (additional)	26	16 1
Wilson, Joseph, Esq., Halifax	237	6 8	Dove, E. S., Esq., Kilsby	422	2 6
Wood, Major Lancelot, Army & Navy Club	800	- -	Evens, Miss S. B., Newton Abbot	8	19 7
			Fearnside, Henry, Esq., M.D., Bournemouth	300	- -
			Fildes, Mrs. D., Stretford	140	5 10
			Fletcher, Mrs. E., Sutton	50	- -
			Gordon, Miss Mary, Norwich	20	- -
			Guillan, David, Esq., Tayport	500	- -
			Hewetson, T., Esq., Ware Staverton	105	- -
			Janson, Miss M. E., Upper Clapton	100	- -
			Lawrence, Mrs. J., City Road	270	- -
			Lean, G. S., Esq., Bath	200	- -
			Lockyer, Mrs. E. M. A., Holloway	20	- -
			Methven, Robert, Esq., Cupar (balance)	429	11 -
			Moray, The Rt. Hon. the Earl of	15000	- -
			Noake, Israel, Esq., Melcombe Regis	461	8 10
			Osbaldeston-Mitford, Colonel J. P., Mitford	100	- -
			Pearl, H. B., Esq., Brighton	900	- -
			Pell, Richard, Esq., Forest Hill	20	- -
			Pratt, Mrs. M., Manchester	1800	- -
			Roberts, Miss Maria, Rusholme	65	8 2
			Robinson, Lady Harriet, Madron	540	- -
			Smith, John, Esq., Westbourne Terrace, W.	500	- -
			Snowden, Joseph, Esq., Stretford	300	- -
			Steuart, George, Esq., Dover	90	- -
			Stevenson, William, Esq., Glasgow	900	- -
			Syer, Mrs. A., Farnham All Saints	100	- -
			Taylor, T. C., Esq., Nottingham	1800	- -
			Walsh, Robert James, Esq., New Brighton	495	16 8
			Wilson, Joseph, Esq., Halifax	118	13 4
			Yates, W. E., Esq., Leeds	1000	- -
Total	£12,713	11 5	Total	£29,734	19 10

CONTRIBUTIONS RECEIVED FROM BRANCHES DURING THE YEAR ENDED
THE 31st DECEMBER, 1896.

	£.	s.	d.		£.	s.	d.
Aberdeen	34	16	6	Brought forward	5564	13	7
Acoc's Green, Yardley and Olton	29	19	-	Leek	15	15	-
Alloa	26	1	11	Liverpool, Port of.	900	-	-
Arbroath	25	-	-	Llandudno	50	-	-
Ardmore	4	10	-	Llanelly and Burry Port	45	-	-
Ardrrossan	25	-	-	Looe	8	-	-
Banff and Macduff	10	-	-	Lytham	39	-	-
Bannockburn	15	18	1	Manchester	120	-	-
Bath	11	9	6	Melrose	20	17	8
Belfast and Groomsport	45	6	10	Middlesbrough	100	-	-
Belper	18	8	-	Millom	11	1	3
Berkshire	146	12	3	Musselburgh	14	-	-
Birmingham	39	5	9	Newark	9	5	6
Blackburn	12	10	3	Newport (Mon.)	30	3	9
Blyth	50	-	-	Newton Abbot	9	12	10
Bolton	140	-	6	Norfolk	51	9	4
Bo'ness	6	5	4	Northampton	11	9	6
Bradford	159	15	9	North Berwick	60	-	-
Bridport	6	10	9	Nottingham	26	16	-
Brighouse	35	-	-	Ormskirk	9	15	6
Brighton	50	-	-	Peebles	43	-	6
Bristol	57	3	6	Penarth	25	-	-
Broadstairs	7	6	-	Perth	14	10	6
Burslem	20	9	-	Peterborough	32	8	5
Burton-on-Trent	50	-	-	Poole and Bournemouth	20	-	-
Cambridge	18	10	-	Ramsgate	1	1	-
Cavan	24	10	1	Rhosneigr	7	5	6
Cheltenham	15	6	-	Rochdale	92	16	-
Chichester	19	10	-	Rochester	40	-	-
City of London	2250	-	-	Runcorn	66	16	-
Clevedon	11	15	9	Scarborough	91	1	5
Courtmacsherry	1	-	-	Seascale	11	6	2
Dawlish	25	14	2	Settle	26	11	3
Derby	15	18	6	Sheffield	67	18	7
Douglas	100	-	-	Shropshire	30	-	-
Dover	18	-	-	Southampton	376	19	10
Dublin	65	-	-	Southport	104	18	-
Dundee	80	-	-	Stechford	15	10	9
Durham	3	3	-	Stirling	41	9	8
Eastbourne	10	10	-	Taunton	15	9	6
Edinburgh, Leith, and Granton	261	16	8	Teesdale	11	9	-
Enniskillen	34	12	6	Teignmouth	50	-	-
Exeter	49	10	-	Torquay	70	-	-
Exmouth	15	-	-	Tunstall	1	1	-
Falkirk	48	5	4	Valentia	-	8	2
Fraserburgh	10	-	-	Wakefield	13	12	6
Glasgow	614	8	4	Wells	11	17	6
Grangemouth	38	9	6	West Hartlepool	10	-	-
Greenock	3	-	-	Weymouth	1	14	-
Greystones and Bray	13	2	7	Wisbech	3	17	-
Grimsby	20	-	-	Wolverhampton	42	10	-
Halifax	71	16	2	Worcester	24	11	2
Henley-on-Thames	16	17	2	Worthing	40	-	-
Huddersfield	118	2	11	York	92	-	-
Hull	77	14	7				
Ipswich	22	18	9				
Isle of Purbeck	11	10	-				
Keighley	67	3	6				
Kelso	8	11	-				
King's Lynn	12	19	7				
Lakes	61	-	-				
Lancaster	120	11	2				
Leamington	34	10	6				
Leeds	146	7	3				
Carried forward	£5564	13	7	Amount paid by Branches on behalf of the Parent Committee, from con- tributions collected locally, to Cox- swains and crews for exercising the Life-boats quarterly and in other outlays on their Life-boat establish- ments	8,228	3	9
				Total	£16,822	7	5

**"LIFE-BOAT SUNDAY" OFFERTORIES AND COLLECTIONS RECEIVED
DURING THE YEAR ENDED THE 31st DECEMBER, 1896.**

EXCLUDING THOSE PAID DURECT TO BRANCHES.

	£.	s.	d.		£.	s.	d.
Aberford Church, Leeds, per Rev. A. L. Barnes Lawrence, M.A.	1	-	-	Brought forward	87	16	1
Adderley Church, Market Drayton, Offertory, per Rev. A. Corbett, M.A.	4	5	-	Hornsey, St. Andrew's Temporary Church, collection, per Mr. E. J. Mills	1	7	2
Aldenham Church, Watford, per Rev. Kenneth F. Gibbs, M.A.	17	3	-	Howe, H.M.S., Offertories per Rev. Horace S. Wansbrough, R.N., B.A.	1	8	6
Alloa Sabbath School, per A. P. Forrester Paton, Esq.	2	7	3	Icarus, H.M.S., Offertories on board, per Commander Fleet, R.N.	-	11	3
Arethusa, H.M.S., per Rev. W. W. Nicholson, R.N., B.A.	3	5	-	Impregnable, H.M.S., Offertories on board, per Rev. J. M. Clarkson, R.N., M.A.	1	11	9
Banbury Sunday School, collected by Mr. H. J. Hicks.	-	8	-	Junction Road, Upper Holloway, Congregational Sunday School collection, per John Forder, Esq.	3	10	6
Banbury Sunday School Class, per W. H. Haycock, Esq.	-	5	-	Kingston and Surbiton Church, Christmas Offertory, per W. Todd, Esq.	-	10	-
Barningham Church, Bury St. Edmunds, collection, per Rev. A. W. Edwards, M.A.	1	3	11	Lenham, Maidstone, Church, collected, per Rev. C. E. Nepean, M.A.	1	5	6
Bradwell Church, Great Yarmouth, per Rev. John Walker, M.A.	1	-	-	Linden Grove Sunday School, collected by Teachers and Scholars, per Mr. E. A. Hutchinson	2	6	6
Brockdish Church, Offertory, per Rev. J. H. White, M.A.	2	15	6	Midnight Sun, collections at services during Baltic cruises, per H. Riches, Esq.	17	10	7
Brown & Co., Messrs., St. Mary Axe, Lent Offerings from Employees	1	12	-	Offley Church, Offertory on St. Andrew's Day, 1895, per Rev. C. R. Hardy, B.A.	-	14	7
Cawthorne Church, collected at Children's Service, per Rev. C. T. Pratt, M.A.	3	-	10	Orford Church Offertory, per Rev. E. M. Scott	1	12	10
Chilton Church, portion of collection, per Rev. Herbert Smith, M.A.	-	15	-	Park Chapel Sunday School, Camden Town (Boys' Division), per F. Hynam, Esq.	-	5	-
Christchurch, Marylebone, Offertory, per Wm. Lawson, Esq.	-	7	4	Peckleton Church, Offertory, per Rev. T. E. E. Chataway, M.A.	-	12	10
Dartmouth "Life-boat Sunday," per H. Fooks, Esq.	13	19	5	Royal Naval School Chapel, Eltham, Offertories per Rev. R. Percival Brown, M.A.	1	6	-
Denmark Hill, St. Matthew's Sunday School Children's Harvest Festival, per W. H. Benham, Esq.	-	18	2	Saul Church Offertories, by Rev. R. Hall, M.A.	3	7	11
Durham County Asylum, Offertory in St. Luke's Chapel, per Rev. G. Bradshaw, M.A.	-	19	10	Shamley Green, Christ Church Offertory, per Rev. A. W. Leach, B.A.	2	13	6
Eastbourne, Offertory in St. Andrew's School, per Rev. E. L. Browne, M.A.	4	6	4	Shipley Congregational Church Sunday School, Special Service, per Mr. S. D. Pickard	1	10	6
Egypt, collected in Mena House Chapel, Cairo, per Rev. S. Majendie, M.A.	2	16	-	Southwold Parish Church Collection	6	-	-
Foresters, Ancient Order of, collections after Church Parades—				St. Sunniva, s.s., Sunday collections on board during cruises, per J. T. Woolrych Perowne, Esq.	5	9	-
Court Triumph, at Bearstead, per F. R. Cooper, Esq.	1	3	2	Sudbourn Church Offertory, per Rev. E. M. Scott	2	1	8
Court St. Dunstan, at Frinstead, per ditto.	1	-	-	Sunningdale School Chapel Offertories, per The Rev. Dr. Girdlestone.	2	-	-
Swansea, per Rev. E. J. Wolfe	2	2	-	Swinton, Manchester, Proceeds of Lent Boxes, per Rev. C. W. Birley, M.A.	-	17	3
Gartsherrie, Scotland, collection in Parish Church, Service for Young, per Rev. J. A. Ireland	1	1	4	West London School Chapel, Ashford, Staines, Boys' Offertory, per Rev. H. J. Flynn, D.D.	3	7	2
Hadnall Church, Salop, collection by Rev. Brooke C. Mortimer, M.A.	10	10	-	Westcott, Dorking, Offertories in Holy Trinity Church, per Rev. A. D. Woolley, B.A.	5	12	3
Hamble, Southampton, portion of offertory in St. Andrew's Church, per Rev. J. J. Curling, B.A.	1	12	6	Weston-under-Lyziard, Offertory at St. Andrew's Church, per the Hon. and Rev. J. Bridgeman, M.A.	6	3	1
Harby Church, collected by Rev. M. O. Norman, B.A.	2	4	-				
Haslingden, collected by the Ebenezer Baptist Y.P.S.C.E., per Miss Whitaker	-	15	6				
Hesperus, ship, of London, Sunday Services on board, per Capt. Barrett.	5	-	-				
Carried forward	£87	16	1	Total	£161	11	5

CONTENTS OF CONTRIBUTION BOXES, 1896.

EXCLUDING THOSE BELONGING TO BRANCHES.

	£.	s.	d.		£.	s.	d.
Allen, Ashton C., Esq.	7	7	-	Brought forward	138	13	7
Alloa Custom House	-	6	-	<i>Criccieth Castle</i> , ship	2	7	9
<i>Alvina</i> (yacht), per L. T. Cave, Esq.	1	4	-	Crystal Palace pillar boxes	1	2	8
<i>Amphitrite</i> , s.s.	2	10	-	Curle, Mr. H.	-	5	-
Anglo-American Telegraph Company, Valentia	-	14	5	Davies, Mrs. P.	1	13	-
Annual Meeting, R. N. Life-Boat Institution	8	19	10	Day, Messrs. R. & Son, Cork	-	7	8
Antwerp, Golden Anchor Hotel, per M. J. Minieri, Esq.	2	-	6	<i>Defiance</i> , H.M.S.	-	5	-
Ardrossan Custom House	2	11	6	Devoran, "Robartes Arms," per Mrs. Gilbert	-	10	6
Atty, Miss E. E.	-	5	-	Dewey, Mr. J., Sutton	-	6	6
Avonmouth Mercantile Marine Office	12	15	-	Didcot Railway Station	-	7	9
Ayr Custom House	1	-	-	Dock Street Mercantile Marine Office	1	11	8
Baker, Messrs. Charles & Co.	3	9	7	Douglas, J. Scott, Esq.	-	10	6
Bangor Custom House	-	7	-	Dublin Mercantile Marine Office	1	9	-
Barrow-in-Furness Custom House	-	15	1	<i>Eastern Monarch</i> , ship	1	11	5
Barry Mercantile Marine Office	8	5	-	<i>Ednyfed</i> , barque	1	2	-
Basingstoke Railway Station	-	5	7	Elworthy, E. M., Esq.	-	7	6
Beddoes, Mrs.	1	5	3	Ellis, W. C., Esq., M.D.	2	1	3
<i>Bellona</i> , H.M.S.	-	6	-	Englefield Workman's Club	-	16	-
<i>Bianca</i> , barque	1	5	-	<i>Eurydice</i> , ship	3	-	9
Birmingham, "Golden Lion," Solihull	-	12	2	Evans, P. H. L. Esq.	1	-	-
Ditto, "Plume of Feathers," Shirley	-	12	-	<i>Excellent</i> , H.M.S.	1	7	6
<i>Blenheim</i> , H.M.S.	3	10	-	Exeter Customs and Mercantile Marine	-	5	3
Bo'ness Custom House	-	19	6	Falmouth (Ditto)	-	7	9
Boncy, Mrs. E.	2	10	-	Farrar, Miss	-	17	6
Bowman, Dorothea, Humphrey and Clive, collected by	4	-	-	Fenchurch Street Railway Station	-	11	8
Brackstone, Mrs.	1	6	6	Finsbury Central Club	2	5	-
Bremhill and Foxham Reading Rooms	-	7	6	Ford, Miss	-	6	-
Bridgwater Custom House Mercantile Marine Office	-	9	4	<i>Forest Brook</i> , s.s.	1	2	10
Bristol, Capital and Counties Bank	-	15	-	Foresters, A. O. of, Court 3336, New Adelphi	-	10	-
Bristol Mercantile Marine Office	7	19	5	Ditto, Court 5525, Pride of Bramley	-	10	6
Bristol, Temple Meads Station.	-	6	6	Ditto, Court 2677, Royal Saxon	-	6	6
Brockman, Col. J. A.	4	-	-	Forman, E. H., Esq.	1	5	4
Bromley, C., Esq.	-	7	-	Forster, Mrs. M. E.	-	7	6
Brookes, Rev. W., B.D., Cannes	-	10	-	Fowey Customs and Mercantile Marine	-	8	6
Buckland, E. E., Esq.	-	11	9	Fulham, White Horse Hotel	-	14	8
Buffaloes, R. A.O., Lady Adeline Lodge	1	5	-	Gale, F. H., Esq.	-	10	-
Ditto, Prince of Wales Lodge	-	5	-	<i>Ganges</i> , H.M.S.	-	12	-
Burntisland Custom House	1	9	11	Garlieston, Queen's Arms Hotel.	-	16	5
Burr, Mr. J. M., in aid of Walton-on- Naze Life-boat	1	14	8	Glasgow, per James Johnston, Esq.	5	19	6
<i>Caledonia</i> , H.M.S.	-	8	-	Glasgow Mercantile Marine Office, per D. Charles Ross, Esq.	6	19	-
Cambrian Railway Company	7	12	9	Globe, The, Holborn	1	7	6
<i>Camden</i> , s.s.	3	8	6	Goole Custom House and Mercantile Marine	1	9	6
Canney, B., Esq.	-	18	11	Gostick, Mrs. J.	-	11	6
<i>Capenor</i> , s.s.	-	14	8	<i>Graffoe</i> , s.s.	-	6	6
<i>Cardinal</i> , s.s.	1	7	6	<i>Grappler</i> , s.s., per Capt. Dickinson	-	10	6
Carter, Thos. S., Esq.	-	7	6	Gravesend, "Three Daws" Tavern	-	6	-
<i>Castleventry</i> , s.s.	-	10	-	Gray, Duncan, Esq.	-	6	-
Cave, L. T., Esq.	1	-	-	Great Eastern Railway Steamships	1	2	7
<i>Cedar</i> , s.s., per Capt. McEwan	9	10	-	Greet, Miss H.	-	10	-
Chandos Hotel, Chandos Street	1	12	6	Grove, Mr. C.	-	12	-
Chittenden, A. G. F., Esq.	-	10	-	Guernsey Custom House	-	9	4
<i>City of Cork</i> , s.s.	1	-	-	Guest, H., Esq.	1	14	5
Clayton, Miss	-	19	-	Guildford Recreative Brigade Bible Class	-	10	-
<i>Clyde</i> , H.M.S.	-	12	-	Guildhall Tavern, King Street, E.C.	-	5	3
Collins, Mrs.	-	10	-	Ham, William, Esq.	-	5	3
Coalville Railway Hotel	1	6	6	Hammond, H. Lewis, Esq.	1	-	6
<i>Colossus</i> , H.M.S.	1	7	-	Hancock, J. T., Esq.	-	11	4
Cooper, Mrs. G. Halcott	-	6	-	Harker, R. A., Esq.	-	5	-
Coppack, Carter & Co., Messrs.	-	6	-	Harris, J. C., Esq.	-	11	-
Corbett, J. W., Esq.	-	5	-	Hawkins & Co., Messrs., Newbury	1	3	-
Corden, Victor E.	-	6	-	<i>Hazby</i> , s.s.	2	14	6
Couchman, Mrs.	1	1	-	Haydock, Mrs.	-	19	6
Cowes Customs	12	7	-	Hayes, Mrs. L.	2	10	1
Cox & Co., Messrs., Finsbury Pavement	1	4	9	<i>Hearty</i> , H.M.S.	-	13	6
				Henley-on-Thames, Red Lion Hotel	2	18	-
Carried forward	£138	13	7	Carried forward	£209	5	8

	£.	s.	d.		£.	s.	d.
Brought forward	209	5	8	Brought forward	324	19	9
Higgon, Master L. H.	-	10	-	Mersey, H.M.S.	-	8	8
Hoadley, Mrs.	-	13	6	Methil Custom House	1	11	-
Holmes, Mr. John S.	1	2	6	Meyer, Colonel Albert	1	8	9
Homan, E., Esq.	1	1	6	Meyer, Miss S. Boyle.	-	17	9
Hopcraft and Broadwater, Messrs.	-	5	-	Middlesbrough Mercantile Marine Office	1	15	-
Horn, J., Esq.	2	4	-	Minet, G. P., Esq.	-	8	-
Horn, Mr. J. E.	-	13	8	Montebello, s.s.	1	19	7
Hubbard, Mrs. R.	-	7	2	Montrose Custom House	-	11	4
Hudson, William, Esq.	5	15	-	Montrose Shore Dues Office	1	7	6
Hull Custom House	5	11	6	Moore, Miss, Cotherstone	-	5	-
Hutton, H. A., Esq.	1	15	-	Morven, steam yacht, per J. R. Hoare, Esq.	1	18	6
Inverness Custom House	3	6	-	Mostyn Arms Hotel, Mostyn.	-	7	6
Ipswich Custom House	-	10	3	Mostyn Custom House	-	9	4
Jack, Master Gordon	1	7	2	Myres, T. H. Esq.	-	11	4
Jeavous, Miss	-	6	7	Needell, Miss E.	-	8	-
Jessett, M. G., Esq.	1	7	6	Newark, s.s.	-	15	9
Jourdain, R. Esq.	-	10	11	Newbiggin, s.s.	-	5	6
Kennett, s.s.	-	13	-	Newcastle Steam Ship Company	-	11	-
Kent, Philip, Esq.	1	-	-	Newlyn, s.s.	-	5	-
Kidd, Miss Pringle	-	-	-	Newport (Mon.) Custom House	8	2	-
Kidderminster, Licensed Victuallers' Benevolent and Protection Society	-	19	6	Ditto, Mercantile Marine Office	10	19	-
Kinsale Custom House	1	10	-	Newport (Pem.), per D. Harvard, Esq., M.D., J.P.	-	16	9
Kippford, "Anchor Inn"	-	11	4	Newry Custom House	-	9	7
Kirkwall Custom House	-	6	6	Nith, s.s.	3	9	-
Koebler & Co., Messrs.	-	5	4	Northampton Working Men's Club and Institute	2	10	-
Lambeth Police Court	-	14	6	North Shields Sailors' Home	-	5	4
Lance, Mrs.	-	13	-	Old Bell Hotel, per Mr. A. C. Bunyer.	-	13	7
La Touche, Mrs.	-	9	-	"Olives" Life-boat	-	17	-
Lavington, Mrs.	1	3	5	Osborne, H.M. yacht	1	1	-
Learmouth, K. L., Esq.	-	5	-	Oxenham, Master	1	1	-
Leith Custom House	-	5	10	Oxford Station, G. W. Ry.	-	14	-
Lerwick Mercantile Marine Office	-	5	1	Paine's, Walsall, Customers at	-	18	4
Lewisham Conservative Club	2	-	-	Painter, Mrs. M.	-	8	6
Lewisham, "Roebuck" Hotel	-	16	6	Parry, Rear-Admiral Jones	-	12	-
Liddle & Sons, Messrs. T.	-	12	-	Patshull Fishing Temple	-	5	-
Limerick Custom House and Mercantile Marine	5	-	10	"Pegasus," Green Lanes, N.	1	6	-
Limn, Mr. John S.	2	2	-	Pembroke, H.M.S.	-	11	-
Lincoln Liberal Club Co., Limited	-	5	-	Perkins, The Misses	-	5	6
Lion, H.M.S.	-	13	5	Peterhead Custom House	2	3	-
Littlejohn, T. G., Esq.	1	7	-	Phillips, A., Esq.	1	-	-
Liverpool Custom House	3	8	9	Philpotts, J. R., Esq.	2	2	-
Liverpool Street Railway Station	-	15	1	Pitman, Lady	1	7	6
Ditto, Grill and Dining Rooms, per Mr. Amendt	1	19	1	Plover, H.M.S.	1	13	1
Llanberis, Dolbadarn Hotel	-	14	-	Plow, Miss M. K.	-	11	-
Lock, Mrs. H.	1	10	-	Plymouth Mercantile Marine Office	2	7	10
London and South Western Railway Stations	4	4	9	Plympton, s.s.	-	6	6
London Bridge Railway Station	1	6	1	Polruan Reading Room	1	1	-
London, Chatham & Dover Railway stations and steamers	1	19	-	Poplar Mercantile Marine Office	15	1	2
London Custom House	-	14	1	Port Glasgow Custom House	-	18	6
"Lord Cardigan," P.H., per Mrs. Jones	3	8	-	Portishead Seaman's Institute	-	5	3
Loyd, Miss Frances H.	9	-	-	Portsmouth Mercantile Marine Office	-	10	-
Lydia, s.s.	1	1	-	Powell, Mrs. J. C.	1	-	-
Lydny Railway Hotel, per Miss Ridler	6	5	6	President, H.M.S.	1	11	11
Machan, East London, South Africa	1	14	6	Preston Custom House	1	13	3
Mackay, W. J. Esq.	2	11	-	Putney "Jolly Gardeners," per Mr. Woolgar	2	-	-
Macquarie, ship	-	12	10	Ramage, Mrs.	-	14	-
Madeleine, s.s.	-	18	8	Ramsgate, Paragon Boarding House	-	9	6
Maderia, Reid's Hotel	2	-	-	Ramsgate, Pillar Hotel	-	19	11
Maelgwyn, Barque	1	-	6	Ramsgate Pillar Box, Pier Yard	2	6	1
Maldon Custom House	-	8	6	Rayner, Mr. G.	-	10	-
Malton Railway Station Refreshment Rooms	-	18	-	Rayner & Son, Messrs.	-	12	6
Malvina, s.s.	1	15	-	Reading Station, G. W. Railway	-	7	7
Manchester Mercantile Marine Office	1	-	6	"Red Cow," Mile End Road	1	5	-
Marina, s.s.	-	7	6	"Red Lion," Portland Street, W.	1	5	-
Marsh, Mr. S.	-	7	5	Repulse, H.M.S.	2	14	1
Mazepa, s.s.	-	15	-	Richmond Golf Club	-	15	1
May, R. W. Esq., Billingsgate	14	14	10	Roberts, Arthur, Esq.	-	11	2
Mcintire, Mrs.	1	1	-	Roberts, Rev. R. H.	1	10	-
				Robinson, H. P., Esq.	2	3	7
				Roehampton, s.s.	1	5	-
				Rogers, Miss E. C.	2	10	-
Carried forward	£324	19	9	Carried forward	£324	19	4

	£.	s.	d.		£.	s.	d.
Brought forward	431	19	4	Brought forward	463	18	2
Romford Railway Station	-	6	5	Teignmouth Custom House	-	16	-
Romsey, Capital & Counties Bank	-	6	-	Thompson, Dr.	-	17	6
Romsey Post Office	-	10	1	<i>Thunderer</i> , H.M.S.	1	2	3
Royal Corinthian Yacht Club	1	8	-	Tingle, H. Esq.	1	5	-
Royal Southampton Yacht Club	-	8	6	Tonge, Rev. A. W.	-	15	-
Sanders, Wake & Co., Messrs.	-	8	10	<i>Torrens</i> , ship, per Capt. Cope	12	17	-
Saunders, Harry, Esq.	-	8	-	Towers & Rayner, Messrs.	-	5	-
Scandinavian Sailors' Temperance				Turner, Mrs. H.	-	5	-
Home, per Mrs. Welin	1	11	6	Ufford, Mr. A. Ward	-	8	4
"Seven Stars," Starch Green	-	14	-	<i>Victoria & Albert</i> , H.M. yacht	-	7	7
Sewell, E., Esq.	-	5	-	Victoria Docks pillar box	1	15	6
<i>Shamrock</i> , s.s.	6	4	-	Victoria Railway Station pillar box			
Simpson and Son, Messrs. R. S.	-	13	6	(L. B. & S. C. R.)	1	2	3
Simpson, Mr. H.	-	17	7	Wakefield (Kirkgate) Railway Station	-	10	4
Sittingbourne Post Office	-	10	11	Walsh, Miss E.	1	4	6
Skinner, Mrs., Cambridge	-	6	4	<i>Warspite</i> , H.M.S.	-	14	3
Smith, Mrs. Bassett	-	5	6	Waterloo Railway Station pillar box	-	11	8
South Devon Railway Stations	1	4	9	Watts & Co., Messrs. F.	-	14	-
South Western and Midland Railway				Watts, H., Esq.	1	-	-
Companies Boxes	1	1	6	Webster, Mr. W.	2	2	-
Southampton Mercantile Marine	2	2	9	Wednesbury, "Bull's Head," Tarne			
South Western Police Court	-	18	6	Bridge	-	16	6
Spalding Club	-	15	-	Wells, Rev. C. A.	1	1	3
Sparks, E. L., Esq.	-	10	-	Welshpool, Royal Oak Hotel, per Mr.			
St. Mary Cray, "Blue Anchor"	-	5	7	D. Richards	-	14	10
<i>St. Vincent</i> , H.M.S.	-	12	9	West Hartlepool Custom House	-	16	7
Standing, J. R., Esq.	-	5	8	Westport Custom House and Mercantile			
Steadfast Brothers Bible Class	-	5	3	Marine Office	-	9	10
Stockton Custom House	-	5	-	Wexford Custom House	-	16	9
Strutt, Mrs. A., "In Memoriam Susan				Whitby Custom House	-	5	-
Strutt"	-	15	-	White, E. J. Esq.	1	-	-
Sturt, E. A., Esq.	2	-	-	Wick Custom House	-	10	6
Sutton Post Office	-	6	6	Woodd, A. B. Esq.	-	13	2
Sutton, "Ye Olde Cock" Hotel	-	5	2	"Woolpack," Gracechurch Street	2	6	6
Sutton, London & Provincial Bank	-	12	-	Wooten, Miss M. A.	-	7	6
Swansea Mercantile Marine Office	-	12	6	Yokohama, H. B. M. Consulate	1	16	3
Tait, J. W., Esq.	-	15	7	Sums under 5s.	15	18	2
<i>Tasso</i> , s.s.	1	16	-				
Taylor, Mr. A. D.	-	7	-				
Taylor, Mrs.	-	18	2				
Carried forward	£463	18	2	Total	£520	4	2



THE LIFE-BOAT TO THE RESCUE.

LIFE-BOAT SATURDAY FUND.

LIST OF OFFICERS.

PRESIDENT—

Capt. H.R.H. The DUKE OF YORK, R.N., K.G.

PRESIDENT OF THE LADIES' AUXILIARIES—H.R.H. The DUCHESS OF YORK.

CENTRAL COMMITTEE—

Sir EDWARD BIRKBECK, Bart., *Chairman*.

Delegates from Committee of Management—

Sir EDWARD BIRKBECK, Bart.
Colonel FITZROY CLAYTON.
Admiral J. HALLIDAY CAVE, C.B.
L. T. CAVE, Esq.

W. H. LYALL, Esq.
ROBERT A. B. PRESTON, Esq.
The Right Hon. the EARL WALDEGRAVE.
Admiral T. LE HUNTE WARD, C.B.

Delegates from East and South District Committee—

G. GIBBS, Esq.	Norwich.	Mr. Councillor HUTCHINGS.	Hastings.
F. S. SPENCER, Esq.			Maidstone.

Delegates from London District Committee—

Capt. ACLAND.
FRANK B. BELL, Esq.
W. B. FAULKNER, Esq.

C. OSCAR GRIDLEY, Esq.
C. W. LOVE, Esq.
Rev. C. A. W. ROBINS.

Delegates from Midland District Committee—

A. C. FAIRE, Esq.	Leicester.	C. KIRK, Esq.	Derby.
A. F. KIRBY, Esq.	Nottingham.	T. G. PRICE, Esq.	Birmingham.
	C. C. SMITH, Esq.		Birmingham.

Delegates from North of England District Committee—

G. R. BELLAMY, Esq.	Manchester.	H. J. PALMER, Esq., J.P.	Leeds.
Dr. BURDON	Newcastle-on-Tyne.	Rev. R. PERRY-CIRCUITT	Heywood.
E. G. DRAPER, Esq.	Sheffield.	P. J. RAMSAY, Esq.	Manchester.

Delegates from Scottish District Committee—

ALEXANDER A. E. DOWNIE, Esq.	Glasgow.	T. S. PATERSON, Esq., W.S.	Edinburgh.
W. R. FINLATOR, Esq.	Paisley.	GAVIN RALSTON, Esq.	Edinburgh.
DANIEL MCBRIDE, Esq.	Dumbarton.	JAMES H. STENHOUSE, Esq.	Glasgow.

Delegates from Western District Committee—

E. G. CLARKE, Esq.	Bristol.	JAMES LIVINGSTONE, Esq.	Swansea.
W. H. FRANK, Esq.	Bristol.	HORACE W. LYNE, Esq.	Newport, Mon.
J. H. HARRISON HOGGE, Esq.	Southampton.	H. J. VELLACOTT, Esq.	Penarth.

SECRETARY—Mr. A. P. SMITH, 3, Adelphi Terrace, London, W.C.

ORGANISING SECRETARIES—Messrs. A. J. BOYLE, W. MARTIN, J. REGINALD ROBERTS, and C. A. SWIFT.

ASSISTANT ORGANISING SECRETARY—Mr. E. H. JOHNSON.

BANKERS—Messrs. COURTIS & Co., 59, Strand.

AUDITOR—SAMUEL LOVELOCK, Esq., F.C.A.

SPECIAL LIFE-BOAT FUNDS.

CIVIL SERVICE LIFE-BOAT FUND.

Patron—
HIS ROYAL HIGHNESS THE DUKE OF
SAXE-COBURG AND GOTHA, DUKE OF
EDINBURGH, K.G., K.T., &c.

Treasurer—
CHARLES G. TURNER, Esq., C.B.

Hon. Secretary—
CHARLES DIBDIN, Esq., F.R.G.S.

Annual Subscriptions of 2s. 6d. and
donations have been given in aid of
the above Fund by 15,830 gentlemen
in the following Government Depart-
ments during the past year:—

Admiralty	750
Bankruptcy Department	48
Board of Agriculture	33
Board of Trade	133
British Museum	92
Charity Commission	67
Civil Service Commission	41
Colonial Office	30
Customs	527
Duchy of Lancaster Office	9
Ecclesiastical Commission	34
Education Department	79
Exchequer and Audit Office	120
Foreign Office	42
General Post Office	2317
Geological Survey Office	21
High Court of Justice	395
Home Office	770
House of Commons	45
House of Lords	31
India Office	148
Inland Revenue	2555
Local Government Board	120
Lunacy Commission	10
Miscellaneous Post Offices	2264
National Debt Office	34
Nautical Almanac Office	13
Office of Woods and Forests	61
Office of Works	91
Patent Office	110
Paymaster-General's Office	33
Privy Council Office	10
Public Record Office	15
Public Works Loan Office	12
Queen Anne's Bounty	30
Record Office of Seamen	14
Registrar-General's Office	70
Royal Army Clothing Depart- ment	15
Royal Hospital, Chelsea	50
Royal Mint	130
Royal Naval College, Greenwich	13
Royal Observatory, Greenwich	9
Science and Art Department	69
Scotch Education Department	31
Scottish Office, Whitehall	12
Stationery Office	51
Treasury	51
War Office	571
Miscellaneous	54

SCOTLAND.

Auditor of the Court of Sessions Office	2
Board of Lunacy	6
Board of Manufactures	7
Chancery Office	6
Commissionary Office	1
Customs	31
Exchequer	11
Fishery Board	7
General Post Office	239
General Register of Sasines, Hornings, &c.	71

Geological Survey of Scotland	17
Inland Revenue	125
Local Government Board	25
Lord Clerk Register's Office	9
Miscellaneous Post Offices	2256
Museum of Science and Art	3
Prison Commission	116
Registrar General's Office	8

IRELAND.

Board of Public Works, Dublin	30
Chief Secretary's Office	41
Customs	19
Department of Science and Art	30
Dublin Metropolitan Police	49
Dublin Metropolitan Police Office General Post Office	184
General Register Office	6
General Survey and Valuation Office	64
Geological Survey Office	6
High Court of Justice	8
Inland Revenue	38
Irish Land Commission	39
Local Government Board	38
Miscellaneous Post Offices	87
Office of National Education	53
Registry of Deeds Office	14
Royal Irish Constabulary Depôt, Dublin	5
Royal Irish Constabulary Office, Dublin Castle	13
Stationery Office	4
Teachers' Pension Office, Dublin	1
Treasury Remembrancer's Office	5
Total	15,830

Monro, E. Esq.	10	6
Monro, G. Esq.	1	1
Monro, G. Esq., jun.	10	6
Morgan, W. Esq.	1	1
Pallant, S. Esq.	1	1
Pankhurst, D. D. Esq.	10	6
Pink, T. Esq.	1	1
Pullen, J. Esq.	10	1
Read, B. Esq.	1	1
Rochford, J. Esq.	1	1
Rochford, John, Esq.	1	1
Rolles, E. Esq.	1	1
Rouse, J. Esq.	1	1
Tyffen, G. Esq.	1	1
Tilman, H. Esq.	10	6
Walker, H. G. Esq.	10	6
Webber, F. G. Esq.	10	6
Webber, M. & Co.	1	1
Woodard, J. Esq.	2	1
One Year's Dividend Parker's Legacy	19	6 8
	£59	16 8

THE "FORESTER,"
"FORESTERS' PRIDE,"
AND "SAMUEL SHAW-
CROSS" LIFE-BOATS
FUND.

List of Voluntary Contributions re-
ceived for the Fund from the following
DISTRICTS, COURTS, &c., of the ANCIENT
ORDER OF FORESTERS, from January 1
to December 31, 1896, per J. LISTER
STRAD, Esq., P.S., pro tem.

THE "COVENT GARDEN"
LIFE-BOAT FUND.

List of Subscriptions and Donations handed to the ROYAL NATIONAL LIFE-BOAT INSTITUTION by the Stew- ards of this Fund, being one year's Contribution (1896) in aid of the support of the Covent Garden Life- boat, stationed at Caister, near Great Yarmouth.	£. s. d.
Brough, Master	10
Beckett, Jos. Esq.	1 1
Blackford, A. Esq.	1 1
Buck, Mrs. H.	10 6
Butler, J. Esq.	1 1
Button, J. C. Esq.	1 1
Coleman, Messrs.	1 1
Cumberlege, Rev. S. F., M.A.	1 1
Day, W. H. Esq.	5
Dickson, T. A. Esq.	1 1
Dwelling, W. A. Esq.	1 1
Duncan, Dr.	2 2
Eart, J. Esq.	10
Freeman, A. Esq.	1 1
Geake, G. J. Esq.	10
Hewett, S. Esq.	10
Hobbs, C. Esq.	10
Jacobs, S. Esq.	1 1
Jay, T. Esq.	1 1
Jay, Mrs.	1 1
Kay, P. E. Esq.	2 2
Levy, H. Esq.	1 1
Levy, S. Esq.	10 6
May, G. Esq.	1 1
Messer, G. Esq.	10 6
Messer, G. E. Esq.	10 6

DISTRICTS.

Brighton	1	16
Cardiff	3	6
Colchester	5	9 11
Darlington	6	6
Benny	1	10
Perby, &c.	1	1
Devon, &c.	5	10 9
Flintshire	1	1
Framlingham	1	10
Greenwich	4	11 9
Hinckley	8	3
London, East, &c.	15	15
London, South	4	8 4
London United	24	15 7
Maldstone	10	10
Norwich, P. and P. O.	10	10
Rochester	2	8 8
Stalybridge	15	15
South and North Shields	2	8
South Western	5	10 10
Warminster	1	1

COURTS.

363	5	6
683	10	6
705	10	1
854	6	6
1112	6	1
1193	7	6
1275	10	6
1312	7	6
1400	1	1

	£.	s.	d.		£.	s.	d.
1418	1	1	-	3690	1	-	-
1498	-	5	-	3696	-	13	-
1544	-	6	6	3970	1	1	-
1594	1	-	-	4022	-	12	-
1701	-	10	-	4093	-	5	-
1709	1	4	-	4105	-	10	6
1952	-	10	-	4148	-	1	3
1995	-	10	-	4213	-	10	-
2003	-	5	-	4318	-	17	9
2089	2	2	-	4326	-	10	-
2140	-	5	-	4348	-	10	6
2293	1	1	-	4399	-	5	-
2309	1	1	-	4611	-	5	-
2413	2	1	-	5096	-	5	-
2436*	2	8	1	5106	-	5	6
2454	1	13	7	5132	-	5	-
2505	-	7	7	5136	-	10	-
2521	-	10	6	5171	-	10	-
2572	1	1	-	5249	-	5	-
2695	1	1	-	5308	-	6	-
2700	1	1	1	5319 (Bermuda)	1	-	-
2805	1	1	-	5378	-	18	6
2879	-	5	-	5390	-	10	-
2886	-	5	2	5415	-	11	9
2918	3	16	6	5480	-	10	-
2926	-	10	-	5515	-	10	-
2932	1	1	-	5588	-	5	6
2948	-	6	4	5677	-	5	-
3021	1	1	-	5802	-	1	-
3066	-	10	-	5809	-	5	-
3076	-	6	10	5810	-	5	-
3077	-	5	-	5838	-	5	5
3118 (N.Z.)	1	1	-	5882	-	8	6
3229	-	7	-	5921	-	5	-
3275	-	6	-	5946	-	10	6
3385	1	8	8	5956	-	15	-
3429	-	5	-	5982	-	5	-
3440	-	10	-	6104	-	5	-
3508	-	5	-	6183	-	14	2
3550	-	5	-	6249	-	10	-
3597	-	15	-	6277	-	10	-

	£.	s.	d.
6292	-	5	-
6429	-	10	-
6868	-	12	1
6873	-	16	-
6875	-	10	-
7218	2	5	-
7426	-	10	-
7672	-	5	-
7731	-	5	-
8261 (N.Z.)	1	2	6
Hire of Lanterns	1	10	-
Sums under 5s., and odd half-pence	3	14	-

Total.....£156 - 7

THE "MANCHESTER UNITY" LIFE-BOAT FUND.

Annual Subscription from THE INDEPENDENT ORDER OF ODD FELLOWS (Manchester Unity) FRIENDLY SOCIETY, for the year 1896, per THOMAS COLLINS, Esq., Secretary.

Donation per ditto	50	-	-
	14	7	6
Total	£64	7	6

INDEX TO THE BRANCHES.

	PAGE		PAGE		PAGE		PAGE
ABERDEEN	845	CRESSWELL	826	LANCASTER	814	PWLLHELI	791
ABERDOVEY	822	CRICCIETH	790	LEAMINGTON	836	RAMSEY	867
ABERSOCH	790	CROMER	823	LEEDS	841	REDCAR	842
ABERTSWITH	838	CULDAFF	861	LEEK	830	RHOSNEIGR	787
ACOCK'S GREEN	836	DARTMOUTH	797	LEICESTER	820	RHYL	806
ACKERGILL	848	DAWLISH	798	LIMERICK	863	ROBIN HOOD'S BAY	842
ALDBURGH	831	DERBY	796	LINCOLNSHIRE	821	ROCHDALE	819
ALLOA	848	DEWSBURY	838	LITTLEHAMPTON	834	ROCHESTER	813
ALNMOUTH	825	DONEGAL COUNTY	861	LITTLEHAVEN	828	RUNCORN	791
ANGLE	827	DURNOCH AND EMBO	858	LIVERPOOL	815	RUNSWICK	842
ANGLESEY	787	DOUGLAS	866	LIZARD	792	RYDE	810
ANSTRUTHER	851	DOVER	810	LLANELHAIARN	790	RYE	834
ARANMORE	861	DROGHEDA	863	LLANDDWYN	790	SALCOMBE	800
ARBRATH	851	DUBLIN	862	LLANDUDNO	790	SALTBURN	842
ARDMORE	864	DUNBAR	852	LLANDULAS	796	SCARBOROUGH	842
ARDROSSAN	840	DUNDALK	864	LLANELLY	789	SCILLY	795
ARKLOW	866	DUNDEE	851	LONDONDERRY	863	SEAHAM	803
ARRAN	847	DUNFERMLINE	851	LONGHOPE	856	SEASCALE	795
ATR	846	DUNGARVAN	864	LOOE	792	SEATON CAREW	803
BADRIGGAN	862	DUNGENESS	811	LOSSMOUTH	850	SELSEY	835
BALCARY	853	DUNMORE EAST	864	LOWESTOFT	831	SETTLE	843
BALLANTRAE	846	DUNWICH	831	LYME REGIS	801	SHEFFIELD	843
BALLYCOTTON	860	DURHAM	803	LYNMOUTH	799	SHERINGHAM	824
BALLYWALTER	861	EASTBOURNE	833	LYTHAM	818	SHOREHAM	835
BAMBURGH CASTLE	825	EDINBURGH	848	MANCHESTER	818	SHROPSHIRE	828
BANFF	847	ENISKILLEN	863	MARGATE	812	SIDMOUTH	800
BANSOCKBURN	857	EXETER	798	MARYPORT	795	SILLOTH	795
BARNMOUTH	822	EXMOUTH	798	MELROSE	857	SKERRES	863
BARNET	822	EYEMOUTH	847	MEYAGISSEY	792	SOUTHAMPTON	808
BARNSTAPLE	796	FALKIRK	857	MIDDLESBROUGH	842	SOUTHDEN (ESSEX)	805
BARROW	813	FALMOUTH	792	MILLOM	795	SOUTHPORT	820
BATH	829	FENIT	863	MONTROSE	852	SOUTHWOLD	832
BELFAST	859	FERRYSIDE	789	MULLION	792	ST. ANDREW'S	851
BELPER	796	FETHARD	865	MUNDESBLEY	824	ST. ANNE'S	819
BEMBRIDGE	810	FILEY	838	MUSSELBURGH	850	ST. DAVID'S	828
BERKSHIRE	787	FISHGUARD	827	NAIRN	856	ST. IVES	794
BERWICK	825	FLAMBOURGH	838	NEWARK	827	STAFFORDSHIRE	830
BIDEFORD	797	FLEETWOOD	814	NEWBIGGIN	826	STAITHES	843
BIRMINGHAM	836	FOLKESFONE	811	NEWBURGH	845	STECHEFORD	837
BLACKBURN	813	FRASERBURGH	845	NEWBURY	788	STIRLING	857
BLACKPOOL	813	GILES' QUAY	864	NEWCASTLE (DUNDRUM)	861	STONZHAVEN	853
BLACKROCK	864	GIRVAN	846	NEWCASTLE-ON-TYNE	826	STORNOWAY	853
BLAKENEY	823	GLASGOW	854	NEWHAVEN	834	STROMNESS	856
BLYTH	826	GOODWIN SANDS	811	NEWPORT (MONMOUTH)	822	SUNDERLAND	804
BOLTON	813	GORLESTON	851	NEWQUAY (CARDIGAN)	789	SWANAGE	803
BO'NESS	856	GOURDON	853	NEWQUAY (CORNWALL)	793	SWANSEA	806
BOSTON	821	GRANGEMOUTH	857	NEW ROMNEY	812	TAUNTON	829
BOULMER	826	GREENOCK	857	NEWRY	861	TEESDALE	804
BRADFORD	837	GREENORE	863	NEWTON ABBOT	799	TRIGNMOUTH	800
BRANCASTER	823	GRIMSBY	821	NORFOLK	823	TENBY	828
BRIDLINGTON	838	GUBENSBY	867	NORTHAMPTON	825	THORPE	832
BRIDPORT	801	HALIFAX	838	NORTH BERWICK	852	THURSO	848
BRIGHOUSE	838	HARTLEPOOL	803	NORTH SUNDERLAND	827	THURQUAY	800
BRIGHTON	832	HARWICH	805	NOTTINGHAM	827	TRAMORE	864
BRISTOL	807	HASBOROUGH	823	OLDHAM	818	TRON	846
BRIXHAM	797	HASTINGS	833	ORMSKIRK	819	TYRELLA	861
BROADSTAIRS	810	HAUXLEY	826	PADSTOW	793	WAKEFIELD	844
BUCKIE	847	HAYLE	792	PAKEFIELD	831	WALTON-ON-THE-NAZE	805
BUDE	791	HAYLING	807	PALLING	824	WATCHET	829
BURNHAM	829	HENLEY	827	PEEBLES	856	WELLS (NORFOLK)	821
BURRY PORT	789	HERNE BAY	812	PEEL	867	WELLS (SOMERSET)	829
BURTON-ON-TRENT	830	HOLYHEAD	787	PENARTH	866	WEST HARTLEPOOL	804
CADGWITH	792	HOLY ISLAND	826	PENZANCE	793	WESTON-SUPER-MARR	829
CAHORE	865	HORNSKA	839	PERTH	856	WEXFORD	865
CAMBRIDGE	788	HOWTH	862	PETERBOROUGH	825	WYEMOUTH	803
CAMPBELTOWN	845	HUDDERSFIELD	839	PETERHEAD	845	WHITEBURN	804
CARDIGAN	789	HULL	840	PLYMOUTH	799	WHITEY	844
CARNSORE	865	HUNA	847	POINT OF AYR	806	WHITEHAVEN	795
CARRICKFERGUS	859	HUNSTANTON	823	POLKERRIS	794	WHITELINK BAY	845
CASTLETOWN	866	HYTHE	812	POOLE	802	WHITHORN	813
CAVAN	860	ILEACOMBE	799	PORT ERIN	867	WICK	848
CHELTENHAM	807	IESWICH	831	PORT ERROLL	845	WICKLOW	866
CHESTER	791	IRVINE	846	PORTHCAWL	806	WINTERTON	824
CHESTERFIELD	796	ISLE OF WIGHT	808	PORTHDINLLAEN	791	WISBECH	788
CHICHESTER	833	JERSEY	867	PORTHLEVEN	794	WITHERSEA	814
CITY OF LONDON	778	JOHNHAVEN	853	PORTHOUSTOCK	794	WOLVERHAMPTON	830
CLACTON-ON-SEA	805	KEIGHLEY	840	PORTH RUFFYDD	787	WORCESTER	837
CLEVEDON	829	KELSO	857	PORT ISAAC	794	WORKINGTON	796
CLOUGHRY	861	KESSINGLAND	831	PORT LOGAN	858	WORTHING	835
CLOVELLY	797	KILMORE	865	PORT PATRICK	858	YARMOUTH	824
COLCHESTER	805	KINGSGATE	812	PORT ST. MARY	807	YEALM RIVER	801
CORK	860	KING'S LYNN	824	PORTTRUSH	859	YORK	844
COURTMACSHERRY	860	KINGSTOWN	852	PORTSMOUTH	807	YOUGHAL	869
COURTOWN	865	KIRKCUDBRIGHT	854	PRESTON	819		
CRAIL	851	LAKES' DISTRICT	836	PURBECK	802		

SPECIAL LIFE-BOAT FUNDS.

CIVIL SERVICE, 775; COVENT GARDEN, 775; FORESTERS', 775; ODD FELLOWS, 775.

CONTRIBUTORS TO THE BRANCHES OF THE ROYAL NATIONAL LIFE-BOAT INSTITUTION.

CITY OF LONDON BRANCH.

General Committee—

The Right Hon. The Lord Mayor.
The SHERIFFS OF LONDON.
The MEMBERS OF PARLIAMENT FOR THE CITY OF LONDON.
The Very Rev. The DEAN OF ST. PAUL'S.
The CHAIRMAN OF THE LONDON CHAMBER OF COMMERCE.
The CHAIRMAN OF LLOYD'S.
The CHAIRMAN OF THE STOCK EXCHANGE.
The CHAIRMAN OF THE COMMITTEE OF THE BAL TIC.
The CHAIRMAN OF THE LONDON COMMERCIAL SALE ROOMS.
The CHAIRMAN OF THE GENERAL STEAM NAVIGATION COMPANY.
The CHAIRMAN OF THE PENINSULAR AND ORIENTAL STEAM NAVIGATION COMPANY.
The DEPUTY MASTER OF THE MINT.
The DEPUTY MASTER OF THE TRINITY HOUSE.
Vice-Admiral A. J. CHATFIELD, C.B.
The Right Hon. Lord ALDENHAM.
The Right Hon. Sir JOHN LUBBOCK, Bart., M.P., F.R.S.
FREDERICK D. MOCATTA, Esq.
PERCIVAL A. NAIRNE, Esq.
H. N. HAMILTON-HOARE, Esq.

Hon. Secretary—Capt. F. E. D. ACLAND.

Hon. Treasurer—

The Right Hon. Sir JOHN LUBBOCK, Bart., M.P., F.R.S.

Hon. Auditors—Messrs. W. H. PANNELL & Co.
Bankers—Messrs. ROBERTS, LUBBOCK & Co.

Executive Committee—

Sir THOS. SUTHERLAND, K.C.M.G., M.P.
Capt. F. E. D. ACLAND.
J. W. FELTWELL, Esq., F.I.I.
W. HARDY, Esq.
Colonel HOZIER.
C. J. MORICE, Esq.
PERCIVAL A. NAIRNE, Esq.
E. B. PRESSLAND, Esq.
J. L. SAYER, Esq., Deputy.
EDWARD SEAMAN, Esq., C.C.
R. H. SIMPSON, Esq.

Organising Secretary—A. W. WEBSTER.

Office—HAMILTON HOUSE, 149, BISHOPSGATE STREET
WITHOOT, LONDON, E.C.

*Subscriptions, Donations and Collections from
1st January to 31st December, 1896.*

(See also under headings of "Billingsgate," "Central Markets," "Mark Lane," "Royal Navy," "Ships' Collections," and "Stock Exchange.")

	Dons. & Subs. Colls.		
	£.	s. d.	£. s. d.
Adam Bros.	1	1	-
Agra Bank, per F. W. Quanbrough			1 1 -
Alexander & Co.	1	1	-
Allatini Bros.	2	-	-
Alliston, Alderman F. P.	1	1	-
American and Red Star Line.	10	10	-
American Trading Co., per T. S. Stephenson	1	1	-
Andrews, W. & Co.			- 16 9
Anglo-American Telegraph Co., Ltd.	5	5	-
Ariadne Steamship Co., Ltd.	1	1	-
Artizan's Dining Rooms, per S. H. Gregg			- 6 0
Ashby Bros., per H. E. Lockington.		1	10 2
Ashby & Horner, per J. Roberts		1	14 5
" " " E. Tebby		1	14 -
" " " F. Moore		-	9 9
" " " H. Humphrey		-	7 6
" " " P. Cross		-	7 3
Atkin Bros., per J. C. Dodd		1	3 -
Atkins & Nisbet, per E. Smith		-	14 -
Australian Meat Co.	1	1	-
Austrian Lloyds Steam Navigation Co.	10	-	-
Baddeley Bros., per J. Harrold		2	4 4
Bailey, Frank & Co.	1	1	-
Bailey, W. H. & Co., per C. White	-	10	6 - 7 7
Bain, A. W. & Co., per T. Dickens		-	14 9
Baker's Chop House, per W. J. Palmer		-	9 -
Bank of Montreal, per the Manager.		2	11 6
Bank of Scotland " " "		-	12 6
Barclay & Co.	10	10	-
Barclay & Sons, Ltd., per W. Bennetton		-	16 -
Barker, F., & Son, per E. Edington		-	16 6
"Barley Mow," per E. G. Busbridge		-	16 6
Batger & Co.	2	2	- 1 7 6
Bayer, C & Co.	1	1	-
Belfast and County Down Railway	1	1	-
Benda & Benjamin, per A. Benjamin		-	5 -
Bennett, E. T., & Co., per A. J. Webb		-	13 8
Berry, N., per E. J. Harland and J. Berry		-	11 6
Bertram, Deputy J.	5	5	-
Beesler, Watcher & Co., per C. H. Clayton		-	1 13 -
Billingsgate Ward School, per Master H. Mills		-	7 -
"Bishop Blaize," per H. Barham		-	9 5
Binny & Co., per A. Senior		-	2 2 6
Birt, Potter & Hughes	1	1	-
Blades, East & Blades	1	1	-
Blake, Bisevain & Co.	5	5	-
Blandy Bros. & Co.	1	1	-
Blank, A., per R. F. Crow		-	6 -
Blundell, A. P., Taylor & Co., per A. E. Whittall		-	11 0
Bodega Co., Ltd. (Bucklersbury), per A. Campbell		-	5 -
Bodega Co., Ltd.		-	1 2 11
Bolton, F.	1	1	-
B oth, A. E. & Co.	1	1	-
Borneo Co., Ltd., per T. Simpson		-	2 3 -
Bott, W. E. & Co.	1	1	-
Bousfield, J. R. & Co., per J. Buswell		-	2 10 -
Bowen & McKechnie	1	1	-
Boys-Tombs, E., per A. Cole		-	5 -
Bowring, C. T. & Co.	5	5	-
Bradbury, Agnew & Co., Ltd.— Warehouse Department, per J. Barber		-	14 6
Machine Department, per J. Briggs		-	6 3
Composing Department, per W. Cresspin		-	6 -
Bradford Observer (London Office), per R. Pawson		-	8 6
Brabam, F.		-	7 6
Brandels, Goldschmidt & Co.	5	5	-
Brandram, Mrs.		-	2 -
Brettie & Co., per A. M. Gibson.	1	1	- 2 6
Briesemann's, F., Successors	2	2	-
Bristol Electric Safety Lamp Works.		-	1 1 3
British and Foreign Marine Insurance Co., Ltd., per A. Burdick		-	3 14 6
British & Foreign Wharf Co., Ltd.	1	1	-
Ditto, per S. Stotesbury		-	10 -
British India Steam Navigation Co., Ltd.	10	10	-
Brown, J. K., per G. Allen	-	13	6 - 6 6
Brown, Janson & Co.	5	-	-
Brown, Lenox & Co.	1	1	-
Bucknall Bros.	2	2	-
Bu'gett, S. & Co., Ltd., per W.G. Smith		-	1 18 6
Buecker's Hotel, per G. Hohly		-	2 19 6
Bull, H. & Co.	2	2	-
Burrell & Co.	1	1	-
Bu-ton, J.		-	8 -

ANNUAL SUBSCRIPTIONS AND DONATIONS TO BRANCHES.

779

	Dons. & Subs.		Colls.	Dons. & Subs.		Colls.
	£.	s. d.		£.	s. d.	
Byworth, H. A. & Co., per C. Fudge	..	9 -				
"C. C.," per R. Daniel	..	6 6				
Cam & Co.	..	5 -				
Campbell, J. S.	2 -	-				
Cannon Street Hotel Cigar Stores, per N. L. Tindell	..	8 7				
Capital and Counties Bank, Ltd., per R. C. Henderson	..	3 6 6				
Carlisle & Co. (10s. 6d. on each vessel)	7 17	6 -				
Carron Co.	..	5 15 -				
Carter, H. G., per T. French	..	1 -				
Carter, J., per T. Gillings	..	14 6				
Carter, J. & Sons	- 10 -	1 4 -				
Cate, W. Ltd., per P. Hoquard	..	13 6				
Ceylon Tea Plantations Co., Ltd.	2 2 -	-				
Chatfield, Vice-Admiral A. J., C.B.	1 1 -	-				
China Mutual Steam Navigation Co.	5 5 -	-				
Christensen & Co.	..	2 11 6				
City of London Wine Co., per H. W. Brown	..	18 -				
Clarkson, H. & Co.	1 1 -	-				
Clay, C. J. & Sons, per L. W. Brookes	..	5 -				
Clements, Newling & Co., per C. Raby	..	8 9				
Cloid, Routledge & Co., per H. Warcup	1 1 -	19 6				
Cockburn & Co.	..	12 6				
Cohen, B. & Sons, per C. E. Church	..	1 5 4				
Colgate, Robert	..	1 3 1				
Collins, F. L. H., & Sons	2 2 -	-				
Collyer, F.	1 1 -	-				
Colonial Bank, per G. Turner	..	1 6 6				
Commercial Cable Co.	5 -	-				
Consolidated Bank	..	4 9 -				
Continental Daily Parcels Express	..	8 6				
Canze & Simon	..	7 6				
Cook, John M.	5 -	-				
Cook, Sons & Co.	5 5 -	-				
Coombe & Co., Ltd.	5 5 -	-				
Cooper Bros. & Co.	1 1 -	-				
Copestake, Lindsay, Crampton, & Co., per W. A. Bell	..	8 5 1				
Corder, Wm.	1 1 -	-				
Corporation of the City of London	52 10	-				
Chamberlain's Office, per P. O. Pickering	..	17 -				
Mayor's Court, per A. H. White	..	1 2 -				
City Police, per Supt. J. Whatley	..	1 16 4				
City Sewers, per C. T. Bellaiby	..	15 1				
" " " W. Dudley	..	12 2				
" " " J. Jarratt	..	1 8 -				
"Weights & Measures, per A. G. Street	..	5 -				
Corry, J. P. & Co.	2 2 -	-				
Cory Bros. & Co., Ltd.	2 2 -	-				
Cory, W. & Son, per F. C. Dobbing	..	9 13 6				
Coverley & Westray	1 1 -	-				
Cowan, J. & Co., per F. G. Dyer	..	1 6 -				
Cripplegate Bank, Ltd., per C. Kershaw	..	1 -				
Crocker, Sons & Co.	1 1 -	-				
Cross & Co., per Miss M. A. Wade	..	7 9				
Crowthey & Goodman, per W. H. Chetham	..	13 -				
Cubitt, W. & Co., per J. Cavey	..	18 6				
Culliford & Clark	1 1 -	-				
Cunis, W. R.	..	10 6				
Corteis, Whitworth & Co.	1 1 -	-				
Czarnikow, C.	2 2 -	-				
Daily Telegraph Paper Mills, per C. Howard	..	13 1				
Davidson, Miss F. N. G.	..	10 -				
Davidson, Unwin & Co.	5 5 -	-				
Davies, Jones & Co.	..	5 -				
Davis Gas Stove Co., Ltd., per H. C. Turner	..	2 9 7				
Davison & Co., per A. Morris	..	1 2 6				
Dawney, W. A. & Co., per H. G. Boyd	..	6 6				
Dawson & Sons, Ltd., per E. Rogers	..	1 11 11				
De Keyser's Royal Hotel, per J. Barker	..	17 9				
Delagacion de la Compagnia Tras- atlantic	10 -	-				
Denny, Mott & Dickson	3 3 -	-				
Derenberg & Meyer	1 1 -	-				
Dessen Bros.	1 1 -	-				
Det Bergenske Dampskibsselskab	5 -	-				
Det Nordnordfjeldske Dampskibsselskab	5 -	-				
Dettelbach, W.	5 5 -	-				
Deuchar, Mrs. C. E.	10 -	-				
Dick, W. B. & Co., Ltd.	2 2 -	-				
Dickeson, R. & Co., per P. D. Day	..	1 15 2				
Dimier Bros. & Co., per G. Dimier	- 10 6	- 10 6				
"Distressed Father"	- 10 -	-				
Dixon, C. E.	1 1 -	-				
Doiland & Co., per F. Crawford	..	6 8 5				
" " " F. Berrett	..	19 9				
Dow, A. " "	- 10 -	-				
Dow, J.	- 10 -	-				
Drew, Bear, Perks, & Co., per L. Duchene	..	11 6				
Drysdale, J. W. & Co., per C. A. Comyn	..	14 -				
"Duke of York" Hotel, per F. Marshall	..	9 9				
Dunkelstuhler, A. & Co.	1 1 -	-				
Dunkham, C. A.	1 1 -	-				
Dusseldorfer Allgemeine Versiche- rungs-Gesellschaft	5 5 -	-				
Dyer & Dyer	2 2 -	-				
Eastern Steamship Co.	5 5 -	-				
Eastern Telegraph Co., Ltd.	5 -	-				
East London Waterworks Co. (City Office)	..	2 - -				
Eastwood & Holt	2 2 -	-				
Electrician Printing and Publishing Co., Ltd., per A. Morris	..	16 4				
Elkan & Co.	1 1 -	-				
Erlebach, Livingston & Co.	1 1 -	-				
Ermen & Roby, per W. J. King	..	7 3				
Evans, Sir David	2 2 -	-				
Eve, G. F. & Co., per W. G. Angell	..	5 -				
Evening Standard (Composing De- partment)	..	10 -				
Express Dairy Co. (seven boxes)	..	1 11 11				
Fairey, Humphery & Co.	1 1 -	-				
Falk, Max	1 1 -	-				
"Falstaff Restaurant," per F. C. Thomas	..	3 18 10				
Farmiloe, G. & Son, per E. J. Roberts	..	1 3 -				
Farrington, G. H., per C. Forwood	..	5 -				
Farrow & Jackson	..	1 15 10				
Feltwell, J. W.	1 1 -	-				
Fenwick, Stobart & Co., Ltd.	1 1 -	-				
Field and Queen (Composing Dept.), per T. Burgess	..	1 4 -				
Findlay, Durham & Brodie	2 2 -	-				
Finsbury and City of London Sav- ings Bank, per E. Scargill	..	8 6				
Finsler, A.	1 1 -	-				
Fisher, E. & Co.	..	12 9				
Fisher, F.	1 1 -	-				
Fitch, H. & Co., per W. A. Noble	..	14 6				
Fitzgerald & Co., per A. S. Ballard	..	2 2 6				
Fletcher, S.	..	15 6				
Foster & Cranfield, per W. H. H. Carpenter	..	2 16 6				
"Fountain, The," per Green & Sons	..	10 -				
Francis, Times & Co.	1 1 -	-				
France, W. & Co., Ltd.	1 -	2 - 6				
Freeman, H.	..	8 -				
Friedlander, W.	1 1 -	-				
Fruhling & Goschen	10 10 -	-				
Funck, Henry, & Co.	5 5 -	-				
Furness Railway Co., per H. Cook	2 2 -	-				
Furness, Withy & Co.	2 2 -	-				
Fyfe & Enness	..	5 -				
Gawthorp, T. J., per J. W. H. Gibbs	..	16 8				
Gee, C. & Co.	- 10 6	-				
General Steam Navigation Co.	5 5 -	-				
"George" Hotel	..	5 -				
Gibberd & Co.	1 1 -	-				
Gibbs, G. & Son, per F. Church	..	5 -				
Gilbey, W. & A., Ltd.	10 10 -	-				
Gilliard & Holt	..	5 -				
Globe Express, per H. Fowler	..	4 3 -				
Godebye, Mrs., per Miss Jinks	..	6 6				
Godlee, T.	10 10 -	-				
Good, H. & Son, per H. W. Butter- field	..	10 6 - 10 6				
Gouffe & James	..	10 6				
Gow, John, Ltd.	1 -	1 10 6				
Gow, Wilson & Stanton	2 2 -	-				
Grant, J. and R.	1 1 -	-				
Great Eastern Hotel, per H. C. Amond	..	5 8				

	Dons. & Subs.		Colls.			Dons. & Subs.		Colls.	
	£.	s. d.	£.	s. d.		£.	s. d.	£.	s. d.
Great Eastern Railway Co.	10	10	-		Lavington Bros., Ltd., per T. Hawkins	-	6 7
Great Northern Railway Co., per Mr. Pope	-	7 -	Law, Russell & Co.	1	1	-	
Great Western Railway Co. (West Smithfield Cartage Dept.), per R. C. Wintle	-	12 10	Lawrence, Sir J. C., Bart.	1	1	-	
Grey, H., Junr., per G. Fonn	1	0 0	Lawrence's Restaurant, per T. W. Lawrence	-	12 -
Gridley & Co., per F. B. Pike	1	7 -	Lawson, John	-	6 6
Haas, H. C.	-	13 6	Lazard Bros. & Co.	5	5	-	
Hais and Squire	-	19	-		Lazarus & Rosenfeld	1	1	-	
Haines, Lee & Co., per G. Bone	-	15 3	Lee, Mrs. E. & Miss	2	-
Hamburg-American Line	10	10	-		Lehnhoff, F. A.	1	1	-	
Hamburg Sudamerikanische Dampfschiffahrts-Gesellschaft	10	10	-		Lewis, S. & Co., per F. F. Davis	-	12 2
"Hansa" Co. of Bremen, The	10	10	-		Lewis, W. & Sons	-	5	-	
Hanson, Son & Barter, per R. Brambleby	2	- 6	"Life-boat Saturday," Station and Bridge Boxes	31	19 6
" " " " C. Wicks	1	- 4	Lindley, R., Sons & Davison	1	1	-	
" " " " W. Wilton	-	8 8	Line, J. & Sons	-	15 -
Harrison, John, per E. Linge	-	13 6	Linen and Woollen Drapers' Institution, per the Secretary	-	10 6
Hawkins & Tipson, per W. Noskes	1	1	-	8 6	Linoleum Manufacturing Co., Ltd., per J. J. Wright	-	15 6
Hazell, Watson & Viney, per W. Whittlemore	-	19 2	Liou Brewery Co., Ltd.	5	5	-	
" ditto, per G. Carrick	-	14 -	Lloyd, Attree & Smith, per E. Tomkins	-	10 6
" H. B."	1	1	-		Lloyd's Bank, Ltd., per A. Howard	3	-
Herbert Bros., per R. J. Winter	-	7 -	Lockbarts, Ltd.	7	4 11
Hewetson, H. & Co.	1	1	-		London & County Banking Co., Ltd., per W. Dean	7	12 6
Hill & Sons	2	2	-		London & County Banking Co. (Islington)	2	2 -
Hill, W. & Son, per C. Green	1	3 -	London & Northern Steamship Co., Ltd.	5	-	-	
Hobbs, Hart & Co.	-	6 -	London & Provincial Bank, Ltd.	9	8 -
Home and Colonial Stores, Ltd.	10	10	-		London and South Western Bank, Ltd., per the Manager	17	8 6
Hope Bros	1	7 9	London & South Western Bank, Ltd., per	1	5 -
Hopkins, J. & Co.	1	1	-		London & South Western Rly. Co.	5	5	-	
Hotz, J. C. P. & Sons	1	1	-		London County Council, per Lieut. R. G. Warwick	-	13 -
Houlder, H. & Co.	1	1	-		London Paper Mills Co., Ltd., per T. Edwards	-	6 6
Houlston & Sons, per H. Worster	-	6 9	London Rifle Brigade, per G. Uttridge	1	18 -
House Property and Investment Society, per A. Morton Smith	3	11 -	London Salvage Corps, per C. Bridges	-	7 6
Howard, C. & Sons	2	2	-		London Steamers, Ltd.	1	1	-	
Hutchinson, W. J. & Co., per J. F. Cropp	-	7 1	-	13 11	London Trading Bank, Ltd.	1	1	-	
Huth, F. & Co.	10	10	-		Lorelleux & Co., per E. J. Waller	-	8 6
Hutton, W. & Sons, Ltd., per G. R. Cole	1	9 -	Lovegrove, W.	-	8 9
Hyam, M. & Co.	2	2	-	1 6 5	Lownds, M. & Son, per W. Edwards	1	2 6
" " " " per Mr. Green	1	11 8	Lynch & Co., Ltd., per F. Benbow	1	7 2
Ide & Christie	2	2	-		Lyon, F. J. & Co.	1	1 -
Imperial Bank of Persia	1	1	-		Lyons & Co., Ltd. (10 Depots)	1	1 3
Imperial Ottoman Bank	2	2	-		Lubbock, Sir John, Bart., M.P.	5	-	-	
" " " " per T. A. Sumpson	2	10 -	Mable, Todd & Bard, per H. Dixon	1	1	-	14 9
Ind, Coope & Co., Ltd.	10	10	-		MacIntyre Bros. & Co.	2	2	-	
Isaacs, M. & Sons, Ltd.	1	1	-		McDonald, John	2	2	-	
Ismay, T. H.	5	5	-		McGregor, Gow & Co.	3	3	-	
Italia Insurance Co. of Genoa	2	2	-		McIntyre, Hogg & Co.	1	1	-	
" J. G. G."	5	5	-		McKenna, C. & Co., per A. Herd	-	11 6
Jackson, Pixley, Browning, Husey & Co.	2	1	-		McMeekin & Co.	2	2	-	
James & Co., per Mr. Hampton	-	5 9	Maddin & Selman, per P. Hix	-	10 -
James, G. H. & Co., per F. England	-	8 3	Main, A. J. & Co., Ltd.	1	-
James & Pike, per H. E. Wood	2	3 6	Malcolm, W. F. & Co.	3	3	-	
James, W. & Co., per H. Farrow	-	10	-	14 6	Manchester, Sheffield & Lincolnshire Rly.	10	10	-	
Jenner, R. H. & Sons	2	2	-		Manhattan Steamship Co., Ltd.	5	5	-	
Jerrard, Darby & Clagg	2	2	-		Manley, H. W.	1	1	-	
Jessup, G. J.	1	1	-		Mann, Crossmann & Paulin	10	10	-	
Johnson, Mathey & Co., Ltd., per J. J. Land	2	4 3	Mappin, H. T.	1	-	-	
Joseph, N., per H. T. Michl.	-	12 6	Marie Elsie Steamship Co., Ltd.	1	1	-	
Kendrick, H.	2	2	-		Marine Insurance Co., Ltd.	10	10	-	
Kenny, Mahon & Co.	-	10 6	-		"Market House," per W. J. Adams	-	13 -
Keyes, S. K., per E. W. Pryke	-	10 6	Marks, T. & Sons	-	5	-	
Killick, Martin & Co.	1	1	-		Matheson & Co.	5	5	-	
"King's Head," per C. L. Saunders	-	7 6	Mathews & Luff	1	1	-	
King, J. & Co., Ltd.	-	16 -	Meadows, The Misses	-	17 6
Kingdon, W. (Kingstown Disaster Fund)	1	18 -	"Mecca" Cafés, Ye, per F. J. Sheppard	1	- 6
Klein's Hotel, per A. Wanner	-	18 3	Medina, Ltd., Ye, per E. P. Cook	-	5 2
Kleinwortz, Sons & Co.	10	10	-		Melchers, Runge & Co.	1	-	-	
Knight & Petch	-	10 6	-		Merchants' Marine Insurance Co., Ltd., per A. Dawson	1	1	-	13 -
Koninklyke West-Indische Maildienst	5	-	-		Messageries Maritimes de France	20	-	-	
Krieger, V.	-	5	-		Metropolitan Credit Co., per W. H. Mitchell	-	10	-	8 -
Kuhn, B., per T. Birch	1	1 -	Midland Railway Co. ("Castle and Falcon")	-	8 6
Ladenburg, W.	1	1	-		Middlesex (24th) Post Office Rifle Volunteers, per Sergt.-Major Hoy	-	10 1
Laingmaid, W.	2	12 5	Miller, Miss Nettie	2	4 -
Lake's Restaurant, per F. E. Smith & Co.	-	12 6	Mills, F.	-	8 -
Laming, A. & Co.	1	1	-						
Lampough, W. & E. S.	1	1	-						
Lane & MacAndrew	1	1	-						
Latter, W. & Son	1	- 6					

ANNUAL SUBSCRIPTIONS AND DONATIONS TO BRANCHES. 781

Dons. & Subs. Colls.		Dons. & Subs. Colls.	
£.	s. d.	£.	s. d.
Mills, G.	..	13	-
Moffatt, W., per C. Burcham.	..	6	-
Moir, A., per A. Tackley.	1 1	-	14 6
Morgan, A. & Co.	..	11	4
Morgan, E. W. & Co.	1 1	-	-
Morrison, Pollexfen & Blair	1 1	-	10 6
Morley, I. & R.	10 10	-	-
(Factory), per N. Martin	..	1 6	6
Morning Post, Stereotyping Dept., per G. Le Grys	..	10	-
Mosbacher, E.	1 1	-	-
Moseley, A.	1 1	-	-
Mosenthal, Sons & Co.	1 1	-	-
Mountford, J., per G. Penhallow	..	10	3
Muhlberg, M. & Co.	1 1	-	-
Muller, F.	- 10	6	-
Murdoch, J. C., Ltd.	..	16	1
Murray & Co., per T. J. Line	..	1 2	1
Mustart, J. & Son, per Mr. Stephens	..	1 2	8
F. Mustart	..	1	3
Myer & Turner	..	8	4
Nairns, P. A.	1 1	-	-
National Amalgamated Coal Porters' Union (Canning Town Branch), per H. Brown	..	1 14	6
National Provincial Bank of England, per C. Polliott	..	8	2
Navigazione Generale Italiana	10	-	-
Naylor, F. J.	1 1	-	-
Nederland Steamboat Co.	5	-	-
Negretti & Zambra (collected by Staff)	..	6 10	-
Nethorpe, Mrs. E. L., per A. E. Nethorpe	..	2 3	6
Netherlands-American Steam Navigation Co.	10 10	-	-
Neue Dampfer Co. of Stettin	5	-	-
Neumann, S. & Co.	10 10	-	-
Newbold & Bulford	..	8	9
Newman, E. & Co., per W. M. Swain	..	14	-
Newman, Smith & Newman	1 1	-	-
"New Merlin's Cave," per F. Thomas	..	1 10	3
Newnham, L. E. & Co., per A. T. Stevens	..	8	9
Nickolls, E. C. & Co., per H. Lavington	- 10	-	1 8 6
Nippon Yusen Kaisha	5	-	-
North German Lloyd Steamship Co.	20	-	-
North Met. Tramways Co., per R. L. Adamson	..	51 5	8
Norton, R. M.	1 1	-	-
Ocean Marine Insurance Co., Ltd.	21	-	-
Odell, Miss Kate	..	1	-
Oldfield, F. W. & Co.	..	10	6
"Old Rodney," per Mr. Unwin	..	7	5
Oriental Café Co., per E. W. Brightman	..	9	9
Osborne, Folks & Co.	- 5	-	-
Osborn, T. & Sons, per E. H. Chandler	..	5	-
Ostlandske Lloyd Steamship Co., Ltd.	5	-	-
Owen, Joseph	1 1	-	-
Owtram, R. & Co.	1 1	-	-
Partridge, W. S. & Co.	1 1	-	-
Patterson's Hotel per J. B. D'Ardenne	..	5	7
Pawsons & Leaf, Ltd., per W. H. King	..	1 7	-
Payne, C.	- 5	-	-
Peall, Roy & Co.	1 1	-	-
Pearce, A. R.	..	1 1	-
Pearson (Adam) & Co.	1 1	-	-
Peninsular & Oriental Steam Navigation Co. (and £5 ss. paid through Chief Office)	14 15	-	-
Peunellier, D. & Co.	..	11	9
Petersen, Boksen & Co.	- 10	6	-
Phillips, Owen C., Esq., J.P.	1 1	-	-
Pim, W. H., Junr., & Co.	1 1	-	-
Pimm & Co. (Threadneedle St.), per E. Launede	..	10	-
Pinillos, Izquierdo & Co.	2	-	-
Pirie, A. & Sons, Ltd., per A. Laird and G. S. Smith	..	19	1
Pittman & Woodman, per V. M. Pittman	..	10	-
Playfair, G. G.	2 2	-	-
Poole, R. C.	- 10	-	-
Potter, A. J., & Co.	1 1	-	16 9
Powell, G.	- 5	-	-
Prentice J., per Miss M. L. Gregory	..	7	6
Pressland, E. B.	1 1	-	-
Previté & Co.	1 1	-	-
Price, Forbes & Co.	1 1	-	-
Prince & Faugh, Ltd., per A. Ashdown	..	18	9
Printing & Advertising Co., Ltd., per J. S. Phillips	..	6	6
Prudential Insurance Co., Ltd., per J. Horsley	..	9 12	-
Raban, E. T.	1 1	-	-
Railway Passengers' Assurance Co., per A. Vian	..	1 10	-
Raphael, R. & Sons	10 10	-	-
Rayment's Hotel, per G. Rayment	..	6	3
Read, G. N., Son & Co., per A. S. Mundy	1 1	-	9 -
Redfern, G. F. & Co., per A. Allott	1 1	-	11 -
Rennit, J. T., Son, & Co. (1895, £1 ls.; 1896, £1 ls.)	2 2	-	-
Rickmers, Reismuhlen, Ebederei & Schiffbau, A. G.	5	-	-
Riordan, R. V. (for Electric Fittings)	1 5	-	-
Roberts, Lubbock & Co.	..	3 10	-
Roberts, J. F. & H. Ltd.	1 1	-	-
Robinson, A. G., Roberts & Co.	1 1	-	-
Rodenacau, Th.	2 2	-	-
Rogers, E. H. (Sheriff)	..	16	1
Ronaldson, T. & Co.	1 1	-	-
Rosenheim, L. & Sons	1 1	-	-
Rosing Bros. & Co., per G. W. Mason	..	16	-
Rotterdamse Lloyd	5	-	-
Rowson, Drew & Co.	..	4 4	-
Royal Exchange Assurance Corporation (for Electric Fittings)	2	-	-
Russian Steam Navigation & Trading Co.	- 10	-	-
"Rutland," The, per C. Fullen	..	15	6
Rylands & Sons, Ltd.	2 2	-	-
per S. Barratt, Composing Dept., per C. Cannon	..	5	-
Samuel, M. & Co.	2 2	-	-
Saunders, H., per H. Frost	..	8	-
Sayer, Miss G. H.	..	5	-
Scottish Plate Glass Insurance Co., Ltd., per C. G. Ferguson	- 5	-	-
Seager, L. J. C., per W. Wood	..	1 7	-
Seaman, Miss M.	..	5	-
Searight, Belt & Co.	1 1	-	-
Searle, Gordon & Co., per A. Bramwell	..	10	-
Searle & Hayes	2 2	-	-
Seaward Bros., Ltd.	1 1	-	-
Selig, Sonnetthal & Co.	1 1	-	-
Sendall & Wade	..	12	-
Shannon, Ltd., per D. P. Parlanean	..	1 2	6
Shaw, M. T. & Co., Ltd.	..	3 13	9
Shaw, Savill & Albion Co., Ltd.	5 5	-	-
Shaw, W. & Co., per C. J. R.	..	10	6
"Ship" Binding Works, per Mrs. E. Madge	..	13	-
Short & Co., per W. H. White	..	6	6
Short & Mason, per G. Goddard	- 5	-	1 2 -
Sidney Thomas Steamship Co.	1	-	-
Si-verlock, H., per J. Farrell	..	1 16	6
Simpkin, Marshall & Co., Ltd., per W. G. Reynolds	..	1 3	2
Sinclair, Hamilton & Co.	1 1	-	-
Sinclair, Hamilton & Co., per G. Hounslow	..	17	6
Sloman, R. M. & Co.	5	-	-
Smith, Fk.	- 10	6	-
Smith, Garrett & Co., Ltd.	5 5	-	-
Smith, H. A. & Son, per H. Smith	..	8	-
Smith & Lister	1 1	-	-
Smith, Wood & Co.	1 1	-	-
Société Generale de Paris	1 1	-	-
Sollas & Sons, per G. Sollas	..	7	-
South British Fire & Marine Insurance Co. of New Zealand	1 1	-	-
Sowden & Stoddart	1 1	-	-
Sperling & Williams	- 5	-	-
Sporting Life, Staff of	..	2	-
Spottswoode & Co., per Mr. Prestoe	..	9	6
Sprague, W. W. & Co., per G. Yarrow and G. Bantlin	..	2 4	2
Standard, Composing Staff, per J. Lott	..	1	-

	Dons. & Subs. Cols.		
	£.	s.	d.
Parsons, B. W.	-	5	-
Pickard, H. & Co.	1	3	6
Pinnock, W. R.	-	7	-
Pope, S. E.	1	1	-
Pringle & Co.	-	7	7
Reynolds, C. H.	-	1	-
Salter & Stokes	-	10	6
Saunders, W. H. & Son	-	5	6
Scoones, Miss C.	-	11	-
Smith & Taylor	-	11	-
Walkden, R. P. & Co.	-	10	-
Ward, H. & Co.	-	10	-
Weatherley, E.	-	5	-
Webb, Henry J.	2	10	6
Wilson, A. & Sons	1	1	-
Young Bros.	-	6	3
Zwanenberg, A. V.	-	5	-

"Mark Lane" Life-boat Fund.

Adams, R. & Co.	1	1	-
Agerup, Petersen & Co.	-	10	-
Alexander, Jno. & Co.	-	10	-
Aste, John, & Sons	1	1	-
Baucher, W.	-	10	6
Begbie, Ross & Gibson	1	1	-
Berry, Barclay & Co.	1	1	-
Bovill & Sons	1	1	-
Bowyer, G. T.	-	10	-
Braden, Chas.	1	1	-
Brown & Hart	-	10	-
Burstall, J. & Co.	1	1	-
Chatterton, J. H.	1	1	-
Clark, Bach & Co.	1	1	-
Clarke, W. G. & Sons (1896, 11/6; 1897, 10/6)	1	1	-
Claudius, C. F. & Chattaway	-	10	-
Colman, J. & J.	-	10	6
Connorton, T. & Son	1	1	-
Corder & Haycraft	-	10	6
Coventry, Sheppard & Co.	-	10	6
Craig, R. H. & Co.	1	1	-
Cronbach & Co.	-	10	6
Darnell, W. & J. R.	1	1	-
Delcomyn, F. & A.	1	1	-
Denny, C.	1	1	-
Denny, C. & J.	1	1	-
Denny, T. R. & Sons	-	10	6
Dewar & Webb	1	1	-
Edwards Bros.	-	10	6
Flexman, Jos.	1	1	-
Garnham, A. & Co.	1	1	-
Girdwood, A. & Co.	-	10	6
Gregory, F. & Co.	-	10	6
Grimdale & Sons	1	1	-
Harris Bros. & Co.	1	1	-
Haslam & Makovski	1	1	-
Hewetson, R. & J.	1	1	-
Howell, D. N. & Co.	-	10	6
Hurt, F. & Co.	-	10	6
Jupp & Sons	-	10	6
Keene, S. W. & Co.	-	10	-
Keighley, Maxted & Co.	1	1	-
Klein, W. & Sons	1	1	-
Ledger, E. W. & Co.	-	10	-
Lock, W. & Co.	-	5	-
Maidlow & Sons	-	10	-
Marcuse, Eugène	-	5	-
Medill, T. S.	-	10	6
Messon, W. M.	1	1	-
Mongredien, Ellerby & Co.	1	1	-
Muggeridge & Co.	1	1	-
Nixon, Gower & Co.	1	1	-
O'Brien & Butcher	-	10	6
Palmer, C. H.	1	1	-
Paul, R. & W.	1	1	-
Pechey, J. T. P.	-	10	6
Pilman & Phillips	-	10	-
Pinnock, W.	-	10	6
Rathbone, E. & Son	1	1	-
Raymond & Reid	1	1	-
Robinson, T. & Sons	-	10	6
Roffey, G. & Son	1	1	-
Roland & Phillips	1	1	-
Rumford, L. M. & Co.	-	10	6
Skelton Bros.	1	1	-
Skelton, T. & Co.	-	10	-
Statford, W. J.	-	6	-
Smith, B. & Sons	1	1	-
Smyth, Ross T. & Co.	-	10	-

	Dons. & Subs. Cols.		
	£.	s.	d.
Spratts' Patent, Ltd.	-	10	6
Taylor, G.	1	1	-
Taylor, Seth	1	1	-
Usborne & Son	1	1	-
Vogan & Co.	1	1	-
Wakeley Bros.	-	10	6
Winter Bros.	1	1	-
Wood, W. P. & Co.	-	10	6
Woodley, M. F. & Co.	1	1	-

Royal Navy Collections.

H.M.S. Active, per G. L. Atkinson, Capt., and J. P. Rolleston, Commander	1	-
" Amelia, per G. H. Greenham, Chief Officer in Command	3	7
" Ardent, per Godfrey Mandy, Commander	1	11
" Argus, per J. G. Fletcher, Commanding Officer	-	10
" Astraea, per H. D. Barry, Capt.	2	7
" Australia, per W. A. D. Acland, Capt., A.D.C., and Rev. J. H. Pitman, M.A.	2	10
" Benbow, per E. Rooke, Capt., and Rev. H. H. Mitchell	3	14
" Blazer, per Officer in Command	-	4
" Bruiser, per A. Halsey, Lieut. Commander	2	2
" Buffalo, per W. Hitches	-	7
" Caledonia, per R. S. D. Cum- mings, Commander, and Rev. W. Wilfred Nichol- son, B.A.	-	8
" Charybdis, per J. M. McQuhae, Capt., A. J. Brows, and H. R. Dolby	2	2
" Circe, per Hon. F. C. B. Addington, Lieut. and Commander	3	15
" Conqueror, per C. H. Hopkins, Staff-Commander, and O. W. Durston, M.A.A.	1	10
" Eagle, per E. H. Archer, Commander	-	15
" Fire Queen, per T. Hawkins Smith, Staff-Commander	-	10
" Ganges, per C. H. Coke, Commander, and Rev. R. H. Donovan	1	5
" Hermione, per C. R. Arbuth- not, Capt.	2	4
" Jason, per A.G.M. Meredyth, Lieut. and Commander	1	3
" Lapwing, per R. H. Story, Lieut. and Commander, and F. Tregloban, Assis- tant Paymaster	6	7
H.M. Brig Nautilus, per F. H. Keyton, Lieut. and Com- mander	-	18
H.M.S. Northumberland, per R. G. Boe, Staff-Commander, and J. Muir, Lance-Sergeant, R.M.L.L.	-	15
" Pembroke, per H. R. Evans, Commander	10	-
H.M. Brig Pilot, per F. M. Walker, Lieut. and Commander	-	10
H.M.S. Racer, per H. W. Steele, Commander	1	4
" Redwing, per W. H. Waity, Commanding Officer	1	7
" Research, per W. U. Moore, Capt.	-	6
H.M. Steam-tug Sampson, per G. Bartlett	-	15
H.M. Brig Seaflower, per H. G. Monckton, Lieut. and Commander, and T. G. Southwood, Boatswain	-	13
H.M.S. Tartar, per F. G. Stopf- rd, Commander	2	5
" Terror, per J. A. Bracken- bury, Rear Admiral	1	8
" Triton, per G. Pirie, Com- mander, and L. G. Stovin, Accountant Officer	7	3

Ships' Collections.		Dons. & Subs. Colls.		Dons. & Subs. Colls.	
		£.	s. d.	£.	s. d.
S.S. Abana, per Capt. A. J. Wilson		1	—	S.S. Easington, per Capt. F. J. Courtman	1 11 —
" Adra " Cox		2	6 —	" Eastern Prince, per the Capt.	4 17 6
" Aldgate " G. H. Chesshire		3	8 —	" Eastlands, per Capt. F. McEwan	3 7 6
" Aldersgate " T. Harland		4	—	" Eddystone " R. Care	6 10 —
" Alford " W. J. Wilson		5	—	" Eden " C. B. Morck	2 4 6
" Amaryllis " W. H. Sanders		2	5 6	" Eglantine " R. Mount	2 3 —
Barque Andaman, per Capt. Winter		2	— 6	" Elbe, per W. J. A. Baker (Purser)	10 16 6
S.S. Appomattox, per Capt. G. R. Foale		2	—	" Elizabeth, per Capt. R. Turnbull	2 13 3
" Ariadne Alexandra, per Capt. Maclean		3	10 —	" Emily " A. Street	— 10 —
" Ariadne, per Capt. R. J. Dossar		2	13 0	Ship Ems " N. G. Hatch	2 16 6
" Aries " J. C. Disney		6	—	S.S. Esk, per the Captain	— 6 —
" Ashbrooke, per the Captain		4	1 6	" Essequibo, per Capt. H. Greaves	6 5 —
" Assaye, per Capt. Carruthers		1	14 —	" Ethelbert, per Capt. Wood	— 19 —
" Astraea " G. H. Sergeant		3	2 6	" Etona, per Capt. W. J. Enright	2 4 2
" Atala " Ball		3	5 6	" F. D. Lambert, per Capt. A. B. Taylor	2 8 —
" Atlantic " A. E. Inwood		3	16 —	" Fenton, per Capt. R. Herring	1 14 —
" Atrato " R. L. Dickenson		3	1 6	" Finchale, per the Captain	1 — 6
Ship Auckland " James		7	10 1	" Flambro', per Capt. Moorsom	2 4 —
" Avon " C. Kristenson		1	1 —	" Florence " D. Adams	1 13 —
S.S. Avona " A. Widless		3	5 —	Ship Fonth " Kydd	2 2 6
" Azalea " J. Petrie		4	13 —	S.S. Foscolino " F. J. Huntley	2 13 2
" Banff-hire " B. Goull		1	9 —	" Foyle " W. D. Stanney	3 10 —
" Barraclough, per Capt. D. McGregor		3	14 —	Ship Foyle, per the Captain	3 14 —
" Bay of Bengal, per Capt. E. D. Campbell		3	11 6	S.S. Gardenia, per Capt. W. H. Rutherford	1 7 6
" Belgian Prince, per Capt. Lambert		4	2 —	R.M.S. Garth Castle, per Capt. Rendall	3 3 —
Ship Beltana, per Capt. H. Bright		3	4 6	S.S. George Allen, per the Captain	3 7 —
S.S. Benabour " F. Bunkewitz		2	16 6	" George Royle	3 10 6
" Berrington, per the Captain		1	10 —	" Georgian Prince, per Capt. W. L. Flett	2 12 6
" Bertie, per Capt. H. Hintzke		—	19 —	" Germania, per Capt. W. H. Miller	3 14 —
" Black Prince, per the Captain		2	9 —	" Gladiolus, per Capt. G. Wright	1 14 —
" Blenheim, per Capt. H. Watson		2	9 6	" Gladys Royle, per the Captain	3 14 6
" Bombay, per Capt. W. E. Robertson		—	19 —	" Glanmbanta, per Capt. Midgley	1 3 —
" Bona, per Capt. G. Muir		7	5 —	" Golconda, per Chief Officer H. Borders	2 — —
" Branksome Hall, per the Captain		1	14 —	" Goldsbro', per Capt. F. Evans	3 2 —
Ship British Peer, per Capt. Jones		1	11 1	" Gordonia " J. Lamb	3 14 6
S.S. British Queen, per Chief Steward R. Waters		2	16 6	" Gotha " J. Coates	1 2 —
" Burdon, per Capt. W. Edwards		3	18 4	R.M.S. Grantully Castle, per Capt. S. E. Brown	10 10 —
" Burham " A. Cowens		3	2 —	Ship Grecian, per the Captain	4 10 —
" Caldj " E. H. Lillley		1	7 —	S.S. Greylands, per Capt. Symonds	3 — 0
" Camelia " T. H. Smith		3	8 —	" Guy Colin " H. Partridge	2 14 6
" Caspian " H. B. Beard		2	4 —	" Guyers " Ross	1 15 —
" Castlefield " T. J. Johnston		4	—	" Hampstead " E. Way	3 10 —
" Charterhouse, per Capt. H. W. F. l'd		3	—	" Hampton " R. W. Moon	4 — —
" Chelydra, per Capt. G. Dobson		3	—	" Hanaton " T. Burton	1 1 6
" City of Belfast " J. McGhie		1	10 —	" Harlech Castle, per Capt. Warden	8 — —
" City of Worcester, per Capt. W. C. Fortune		3	—	" Hartburn, per Capt. D. H. Clark	2 2 —
" Clandeboye, per Capt. H. T. Hay		1	12 —	" Hereford " A. Fox	5 15 6
" Clintonia, per Capt. G. Bulman		1	15 —	" Heledon, per the Captain	2 6 6
" Coabam " G. A. Couzens		3	7 —	" Highland Prince, per the Captain	4 7 —
" Concord " W. Day		2	7 6	" Hildebrand, per Chief Officer, W. C. Pont	4 — —
" Consent, per the Captain		1	17 —	" I. M. Strachan, per Capt. J. Kennedy	1 1 —
" Cossett, per Capt. Liddle		1	10 —	" Ifafa, per the Captain	5 2 3
" Cordova " G. Mathews		1	10 —	" Illovo	2 1 6
" Coronilla " T. Rogers		2	13 —	" Imperial Prince, per Capt. W. S. Jameson	7 4 6
" Courtfield " Sheldrake		—	10 —	" Indian Prince, per the Captain	1 15 —
" Crathorne " G. Lewis		1	17 —	" Isle of Elba, per S. Purvis (Second Mate)	1 — —
" Cydonia " E. S. Winspear		1	10 6	" Isle of France, per the Captain	— 16 —
" Cynthiana " A. W. Wade		3	11 6	" Isle of Hastings, per Capt. R. Hodge	3 12 —
" Damascus " A. H. H. G.		12	11 —	" Isle of Iona, per Capt. J. Schatter	3 13 6
" Douglas, R.N.R.		3	8 —	" Italian Prince, per Capt. P. C. Knudson	12 2 —
" Danish Prince, per Capt. R. C. Turner		5	—	" Ixia, per Capt. W. Churnside	2 7 —
R.M.S. Danube, per Capt. G. M. Hicks		1	1 —	" J. R. Hilde, per Capt. W. Scott	2 — —
" Delaware, per Capt. J. Thomas		2	3 6	" James Malam, per Capt. W. Williams	1 17 6
" Denaby, per Capt. R. Moore		4	17 6	" James Westoll, per the Captain	2 14 —
" Deramore " G. Buchan		1	9 —	" Jesmond, per Capt. E. Jones	1 5 —
R.M.S. Derwent, per Capt. W. A. S. Copp		4	6 6	" John Ray " R. H. Cook	1 17 6
S.S. Devonshire, per Capt. G. Bell		2	6 10	" Joseph John " R. W. B'ackin	2 — —
" Diligent, per Capt. M. Henderson		2	6 10	" Junna " Sanders	2 2 6
" Don " F. G. Powles		1	17 —	" Kaffir, per Capt. E. W. Bean	5 1 —
" Dresden " E. P. Atkinson		3	4 —	" Kaiser " H. J. Hyde	1 12 6
" Dulwich " R. M. Cox		55	—	" Kara " Walker	5 14 6
R.M.S. Dunottar Castle, per Capt. W. Hay		11	18 6	" Karoon " G. A. Freeman	2 7 6
R.M.S. Dunvegan Castle, per H. Zimmermann		2	— 3	" Kent " G. A. Brotherton	1 11 —
" Lito, per Capt. J. C. Robinson		1	9 6	" King Biddyn, per Capt. J. Taylor	1 9 6
				" Kingtor, per Capt. P. Symons	1 15 —

ANNUAL SUBSCRIPTIONS AND DONATIONS TO BRANCHES. 785

	Dons. & Subs. Colls.			Dons. & Subs. Colls.	
	£.	s. d.		£.	s. d.
S.S. Kinsale (see S.S. Wo'd)	..	—	S.S. St. Moran's, per J. Jacobsen	..	3 13 6
" Koh-i-Noor, per Capt. C. Martin	..	1 6 3	" Samuel Laing, per Capt. W. Shoe- bridge	..	- 19 7
" Lackenby, per Capt. M. F. Ker	..	2 2 -	" Scawsby, per Capt. J. Higgins	..	2 18 -
" Lady Ann, per Capt. R. Benson	..	1 6 -	" Science " Hocken	..	7 5 -
" Lady Beatrice, per Capt. E. S. Parker	..	1 1 -	" Selby " W. Guy	..	14 13 6
" Lambton, per the Captain	..	1 3 -	" Shagbrook, per the Captain	..	2 - 6
" La Marguerite, per Capt. A. R. Owen	..	1 15 4	" Shenandoah, per C. pt. G. Buckingham	..	1 13 6
Ship Lena, per the Captain	..	3 9 6	" Sir Galahad, per Capt. T. E. Lovitt	..	3 15 6
S.S. Leny, per Capt. Forbes	..	3 13 -	" Strona, per Capt. W. Wood	..	- 10 6
" Leven " A. E. Stiles	..	2 12 -	" Skerryvore " A. von Puttkam r	..	2 8 6
" Linhope, per the Captain	..	1 8 -	" Skidby " J. Strachan	..	6 10 -
" London Belle, per Capt. E. Mills	..	5 18 6	" Slingsby " Robin-ou	..	1 12 -
" Ludgate, per Capt. H. Nicholson	..	3 - -	" S.M.S. Solent " Young	..	2 4 6
" Lundy " Kearney	..	1 13 6	S. E. Rly. Co.'s Steamers, per Capt. Boxer, R.N.	..	5 - 8
" Lutetia " R. Holliday	..	- 12 10	S.S. Southwark, per Capt. S. J. Harrison	..	- 7 2
" Lynton " D. J. Jenkins	..	3 18 6	" Stag, per Cap. A. J. Bruce	..	1 10 7
" Lyon " E. L. Simpson	..	- 10 -	" Staphanotis, per Capt. M. M. Wallace	..	1 9 6
" Magda " P. Eggert	..	2 2 -	" Stranton, per Capt. G. F. S. Wright	..	3 - -
R.M.S. Magdalena, per Capt. J. Pope	..	28 10 10	" Surrey, of London, per Capt. J. Morgan	..	2 3 6
S.S. Maggie Macnair, per Capt. G. L. Alexander	..	3 16 9	" Swainby, per Capt. A. Finney	..	1 14 -
Ship Main, per Capt. H. C. Robinson	..	4 18 6	R.M.S. Tamar, per Capt. Constantine	..	1 10 -
S.S. Malaga, per Capt. Russell	..	1 2 6	S.S. Tartar Prince, per Capt. Hesketh	..	9 - -
" Malvina " J. Main	..	1 2 -	" Tekoa, per Capt. D. Stuart	..	3 8 -
" Manitoba " Griffith	..	- 8 9	" Thames " J. Brander	..	5 - -
" Marnion " Dawson	..	1 4 3	" Thornaby " A. H. Golds- worthy	..	12 10 -
" Marpessa " W. Geary	..	2 - -	" Thurburn, per the Captain	..	5 11 6
" Maryland " E. O. Marshall	..	5 - -	" Toledo, per Capt. J. Wishart	..	1 4 -
" Massachusetts, per Capt. Bocquet	..	- 9 -	" Tom John Taylor, per Capt. T. Fraser	..	4 12 -
" Matin, per Capt. G. A. Lucas	..	1 1 6	" Trinidad, per Capt. A. Harlow	..	- 13 -
" Maude " Wood	..	3 - -	" Trocis, per W. Wilton (Chief Officer)	..	3 14 8
" Megantic " F. D. Lugg	..	1 17 -	" Turbo, per Capt. J. A. Moses	..	5 2 6
" Menzaleh " J. Morrison	..	1 12 9	" Tudor Prince, per the Captain	..	3 5 -
" Merchant Prince, per Capt. J. L. Stagg	..	2 4 2	" Turkish Prince	..	4 10 -
" Minnesota, per Capt. Cannons	..	1 19 -	" Tynehead, per Capt. D. Morgan	..	4 12 -
" Mississippi " Gates	..	4 13 -	" Uplands, per the Captain	..	4 6 6
" " Cannons	..	5 1 6	" Val Halla, per Capt. E. K. Stonehouse	..	- 16 6
" Mobile " Leyland	..	3 12 5	" Vala, per Capt. F. D. Seaborne	..	1 14 8
" Mobawk " T. F. Gates	..	5 - 8	" Vedra " R. H. Prout	..	1 4 0
" Montana " Watkin	..	2 10 -	" Velleda " R. Hocken	..	3 19 6
" Montezuma " W. Taylor	..	2 1 -	" Vernon " J. H. Charlton	..	2 2 -
" Moorgate " W. Cass Smith	..	2 17 8	" Wave " J. McCarthy	..	- 16 6
" Mortlake " L. S. Forster	..	8 8 6	" Wearmouth " D. Jones	..	3 16 -
" Moss Brow " Elmev	..	3 5 6	" Webster " A. Demyer	..	1 5 -
" Munroe " J. Bartlett	..	1 - -	" Welbury " W. J. Dennis	..	1 10 -
" Naples " J. Harrison	..	3 - -	" Weybridge " J. Evans	..	2 14 6
" Nerite " W. Daniels	..	2 13 -	" Whetstone " J. G. Saville	..	2 11 -
" Niveveh " N. Allan	..	5 10 -	" Whitburn " R. N. Hutton	..	3 - -
Ship North Star " T. P. Gluzelier	..	3 6 -	" Widdington, per Capt. L. An- derson	..	2 2 -
S.S. Northumbria " W. Winspear	..	2 13 6	" William Adamson, per Capt. W. Forrest	..	5 5 2
" Northwood " J. Cook	..	- 19 -	" Wintorpe, per Capt. E. J. Minter	..	1 15 -
" Nymphaea " D. Munro	..	4 5 -	" Wolf and S.S. Kinsale, per Capt. Cator	..	1 2 -
" Obi " Clark	..	5 17 6	" Wolviston, per Capt. J. G. Snowdon	..	7 1 -
" Ocean King " Steven	..	1 14 10	" Woolwich Belle, per Capt. J. W. Prior	..	5 10 -
" Ocean Prince " W. B. Barton	..	1 9 6	" Yarrawonga, per Capt. H. G. Thomas	..	2 6 2
" Offerton " R. Drakard	..	2 5 -	" Yedmandale, per Capt. R. W. Webber	..	1 14 6
Ship Old Kensington, per Capt. J. G. McKechnie	..	4 11 -	" York, per Capt. J. W. Smith	..	4 3 -
S.S. Orfoness, per Capt. H. J. Litten	..	5 2 6	" Zenobia " Bowling	..	1 18 6
" Orinoco " W. Gilles	..	13 - 3	" Zero " C. P. Carlson	..	- 17 -
" Ottercaps " A. B. Watt	..	- 19 -	" Zeta " W. Wilson	..	3 14 4
" Pallon " W. H. Preutice	..	2 6 6	" Zylpha " G. Sutton	..	2 5 0
R.M.S. Para " W. H. Milner	..	12 18 1			1 16 -
S.S. Paradox " J. Fielder	..	1 - -			- 11 -
" Pectan " N. Hocken	..	2 6 6			
" Pelaw " Biggs	..	1 - -			
" Pembroke Castle, per Capt. Marshall	..	1 10 -			
" Perthshire, per Capt. P. Wallace	..	6 4 9			
" Pondo " W. Tangye	..	3 10 -			
" Picton " C. J. Payne	..	2 5 -			
" Provencal " G. Simmonds	..	2 2 6			
" Redcar " J. Waller	..	3 6 6			
Ship Rhine, per the Captain	..	6 7 6			
S.S. Rhone, per Capt. J. Smith	..	3 1 -			
" Ribston " J. T. Robinson	..	3 9 -			
" Rimpha, per the Captain	..	1 3 -			
" Rimutaka, per Capt. Greenstreet	..	5 - -			
" River Derwent, per Capt. Harris	..	- 19 -			
" Robert Eggleton " P. Marshall	..	3 17 -			
" Robiua, per Capt. G. W. Lash	..	2 7 6			
" Rockcliff " T. Whittingham	..	1 16 -			
" Roecliff, per the Captain	..	1 18 -			
" Rounton, per Capt. G. Dalziel	..	2 13 -			
" Rowland " R. Sanderson	..	3 - -			
" Rubens " A. Reid Smith	..	3 1 6			
" Ruysdael " W. R. Bennett	..	1 17 -			

Stock Exchange.

Ansell, Mankiewicz & Tallerman	..	10 10 -
Asch, Wm.	..	5 5 -
Atkin, G. D.	..	1 1 -
Baker, Alfred	..	5 5 -
Baker, E.	..	1 1 -
Baker & Kelsey	..	2 2 -

	Dons. & Subs.		Colls.	
	£.	s. d.	£.	s. d.
Balfour, Jno. & Co.	10	10	-	-
Barber, J.	2	2	-	-
Barnett, W. H. L.	1	1	-	-
Beazley & Mitchell	10	10	-	-
Benfield, G. G.	1	1	-	-
Birks, H. W.	1	1	-	-
Birnstingl, A. L.	1	1	-	-
Blake, J. W.	1	1	-	-
Bland-Hunt, V. R.	1	1	-	-
Blyth & Teesdale	4	4	-	-
Boldero, F.	1	1	-	-
Borthwick, Wark & Co.	5	5	-	-
Braikenridge, W.	5	5	-	-
Brenton, F. G.	1	1	-	-
Bristowe Bros.	10	10	-	-
Burdett & Harris	1	1	-	-
Burman, W. H.	2	2	-	-
Cazenove & Akroyd	10	19	-	-
Chinnery Bros.	10	10	-	-
Cohen, S. C.	1	1	-	-
Colliver, F. P.	1	1	-	-
Corbett, J. R.	1	1	-	-
Cripps & Hickman	2	2	-	-
Cutbill, E. & Co.	2	2	-	-
Dadson, J. T.	1	1	-	-
Dare, W. P.	1	1	-	-
Day, W. G.	1	1	-	-
De Neufville, W.	1	1	-	-
Dorling, W.	1	1	-	-
Duforest & Pitel.	3	3	-	-
Foster & Braithwaite	5	5	-	-
Goldney, T.	1	1	-	-
Goldsmid & Co.	5	5	-	-
Goodson, H. J.	1	1	-	-
Gordon (Panmure), Hill & Co.	10	19	-	-
Govett, Sons, & Co.	5	5	-	-
Gundry, Mills & Co.	5	5	-	-
"H."	1	1	-	-
Hancock, C. B.	2	2	-	-
Hardy, Bros.	2	2	-	-
Hawkings, G.	1	1	-	-
Heriot, C. H.	5	5	-	-
Heseltine, Powell & Co.	10	19	-	-
Hichens, J. K.	1	1	-	-
Hickman, W. F.	1	1	-	-
Hill, A.	1	1	-	-
Hodding King & Co.	5	5	-	-
Hyam Bros.	10	19	-	-
Inglis, R. W.	10	10	-	-
Ingram, G. J.	1	1	-	-
Isaacs, Maurice	1	1	-	-
Jacks, C. H.	1	1	-	-
Jackson, G. H.	2	2	-	-
Johnstone, The Hon. G.	2	2	-	-
Kelham, G. M. L.	2	2	-	-
Kent, A.	1	1	-	-
Kennedy, S. & Co.	10	10	-	-
Kennedy & Robertson	10	10	-	-
La Verge, A.	1	1	-	-
Lack & Allcard	10	19	-	-
Laing & Fletcher	10	10	-	-
Laurie, Millbank & Co.	5	5	-	-
Lazarus, S. L.	2	2	-	-
Leigh, A. H.	2	2	-	-
Lomer & Bennie	1	1	-	-
MacGregor, G.	1	1	-	-
Marks, Butteel, Mills & Co.	10	10	-	-
Marks, M. & Co.	1	1	-	-
Marham, J. & Co.	5	5	-	-
Marshall, H. W.	1	1	-	-
Martin, W. H.	1	1	-	-
Marzetti & Co.	5	5	-	-
Metcalf, G.	1	1	-	-
Midlane & Co.	10	10	-	-
Millin, P. W.	1	1	-	-
Montague, Oppenheim & Co.	2	2	-	-
Morris, W. & Sons	2	2	-	-
Nathan & Young	1	1	-	-
Neame, D. J.	2	2	-	-
Newall, W.	10	10	-	-
Nivison, R.	10	10	-	-
Nye, T. & Son	2	2	-	-
Overbury, J. W.	2	2	-	-
Palmer Bros.	2	2	-	-
Payne, W. R.	1	1	-	-
Peckham, H. T.	2	2	-	-

	Dons. & Subs.		Col's.	
	£.	s. d.	£.	s. d.
Pember, G. H.	5	5	-	-
Pim, Vaughan & Co.	10	10	-	-
Pollak, J. & Co.	10	10	-	-
Pott, R. B.	1	1	-	-
Powell, C. J.	5	5	-	-
Renton Bros. & Co.	10	10	-	-
Saulfeld, A.	5	5	-	-
Samuelson, L.	1	1	-	-
Sandeman, Clark & Co.	5	5	-	-
Sargeant, E. W.	1	1	-	-
Scott, W. C.	1	1	-	-
Seligman, A. & Co.	1	1	-	-
Sheppards, Felly & Co.	10	10	-	-
Simpson Bros.	5	5	-	-
Skinner, E.	-	10	-	-
Solomon, A. H.	1	1	-	-
Solomon, J. H.	1	1	-	-
Sopper Bros.	3	3	-	-
Sperling & Co.	5	5	-	-
Steer, Lawford & Co.	10	10	-	-
Stewart, A. B. & Co.	1	1	-	-
Stoneham & Messenger.	10	10	-	-
Swaine, H. P.	5	5	-	-
Symons, S. & Co.	5	5	-	-
Tatham, B.	1	1	-	-
Tatham & Gibbs	1	-	-	-
Taylor, J.	2	2	-	-
Terry, J. E.	1	1	-	-
Thorpe, E. F.	1	1	-	-
Trew, J. P. & Co.	5	5	-	-
Tuckwell, E.	1	1	-	-
Twycross, T. E.	1	1	-	-
Tydd, G. B.	1	1	-	-
Vivian, Gray & Co.	10	10	-	-
Waller, E. T.	1	1	-	-
Waterer, P.	1	1	-	-
Weguelin, B. H.	1	1	-	-
Williams, Meyers & Co.	10	10	-	-
Womersley, Dale	1	1	-	-
Wrightson & Murlless	2	2	-	-

Collections in Stockbrokers' Offices.

Baker, Dickinson, and Hardcastle, per P. Heybourn	..	1	10	0
Blyth & Teesdale, per O. Knight	..	-	10	0
Booth Bros., per A. W. Whitefield	..	2	8	6
Burdett & Harris, per C. J. Wilbe	..	1	1	-
Christopherson & Tonge, per H. J. Glassborough	..	-	7	6
Coates, Son, & Co., per N. P. Hodgson	..	1	18	0
De Zoet & Gorton, per the Chief Clerk	..	2	1	10
Derenberg & Co., per W. H. Lewis	..	2	-	-
Douglass, J. M., & Co., per J. Donaldson	..	1	1	6
Gledstanes & Co., per H. C. Brown	..	1	5	-
Greenwood & Co., per E. G. eggs	..	1	8	-
Gundry, Mills, & Co.	..	3	5	-
Hart, W. H., per T. G. Henslar	..	1	7	6
Hollebone Bros. & Trench	..	1	16	6
Hopkins & Giles, per T. Partridge	..	-	12	6
Jacobson, G., & Son, per V. Gordon	..	-	12	6
Kitchen, G., & Co., per the Chief Clerk	..	-	8	-
Mason, J., & Son, per F. Taylor	..	-	10	-
Morris, W. and Sons, per N. V. Hall	..	1	5	6
Renton Bros. & Co., per E. H. Bainbridge	..	1	7	6
Schweder, P. E., & Co., per A. Evans	..	-	10	-
Shirreff, J. A. & E. C., per W. K. Littlewood	..	-	15	6
Sperling & Co., per E. C. Robson	..	3	5	0
Thomson, D. L. & Co., per H. R.	..	0	14	0
Turie & De Yongh, per F. G. Saich	..	0	17	0
Vivian, Gray & Co., per H. W. Moore	..	3	14	6
Sums under 5s. and odd halfpence	..	1	5	- 8 4 1
		£1,575	9 7	1,733 9 7

Total Subs. & Dons.	..	1,575	9 7
„ Collections	..	1,733	9 7
		£3,308	19 2

ENGLAND AND WALES.

Anglesey.

ANGLESEY BRANCH.

President—
The Most Hon. the MARQUIS OF ANGLESEY.

Vice-President—
SIR RICHARD WILLIAMS BULKELEY, Bart.

Local Committee—
Col. T. L. HAMPTON LEWIS, Chairman.

S. TAYLOR CHADWICK, Esq.
Mr. J. SLATER.

Treasurer and Hon. Sec.—
WILLIAM M. PRESTON, Esq.

Assistant Hon. Sec. and Treasurer—
LEONARD HEPPWORTH, Esq.

Annual Subscriptions.

	£.	s.	d.
Anglesey, Most Hon. the Marquis of	10	-	-
Ashurst, Miss	5	-	-
Ashworth, Ed. Esq.	2	-	-
Atkinson, John, Esq.	10	-	-
Beaumont, L. G. Esq.	1	-	-
Boston, The Right Hon. Lord	2	-	-
Bulkeley, Sir Richard Williams, Bart.	5	-	-
Burton, Jas. H. Esq.	1	-	-
Chadwick, Mrs.	1	-	-
Chadwick, S. Taylor, Esq.	1	-	-
Clegg, Henry, Esq.	1	-	-
Cox, G. R. Esq.	1	-	-
Cross, W. C., Red Hill	1	-	-
Davies, R. Esq.	2	-	-
Davies, Rd. Esq.	2	-	-
Duff, H. A. Esq.	1	-	-
Fluett, Miss	1	-	-
Griffith, W. G. Esq.	1	-	-
Hampton, Miss	10	-	-
Heppworth, Mrs.	1	-	-
Heygate, Mrs.	10	-	-
Hughes, H. R. Esq.	1	-	-
Jones, T. Nicholls, Esq.	1	-	-
Lewis, Col. Hampton	1	-	-
Lewis, J. L. Hampton, Esq.	10	-	-
Massey, Mrs.	10	-	-
Massey, W. Esq.	10	-	-
McCorquodale, Mrs.	1	-	-
Meyrick, Sir George, Bart.	2	-	-
Morgan, W. E.	5	-	-
Neave, The Hon. Lady	10	-	-
Owen, Rev. H. Davies	1	-	-
Pearce, T. Esq.	10	-	-
Penrhy, The Right Hon. The Lord	10	-	-
Platt, J. H. Esq.	5	-	-
Platt, Col.	1	-	-
Poole, Henry R. Esq.	1	-	-
Preston, N. Francis, Esq.	10	-	-
Pritchard, R. N. Esq.	1	-	-
Pritchard, Rev. H.	10	-	-
Pritchard, Thos. Esq.	10	-	-
Pritchard, Miss	1	-	-
Reade, Lady	1	-	-
Ramsay, Lady	1	-	-
Rathbone, R. R. Esq.	1	-	-
Slater, Mr. J.	10	-	-
Smith, G. W. Duff Assheton, Esq.	1	-	-
Smith, Mrs. Duff Assheton	1	-	-
Smith, J. Esq.	1	-	-
Smith, Mrs. Bramston	1	-	-

	£.	s.	d.
Tattersall, Mrs.	1	-	-
Verney, Sir E.	1	-	-
Vivian, Right Hon. Lady Mary	1	-	-
Welsh National Press Co.	1	-	-
Williams, M. Esq.	3	-	-
Williams, Mrs. H. O.	1	-	-
Total	£91	2	6

Donations and Collections, 1895-96.

	£.	s.	d.
Contribution Boxes, per—			
Boswell, A. Houghton, Esq.	1	9	4
Bulkeley Arms Hotel, per Miss Williams	1	8	3
Lewis, Col. Hampton	-	16	6
Lewis, Miss Adelaide	-	13	3
Vivian, Lady Mary	1	1	6

	£.	s.	d.
Collected in—			
Amlwch Churches and Chapels, per Mr. John Hughes	10	18	2
Llanfaethlu Church, per Rev. R. H. Williams	1	-	-
Llangoed Church, per Rev. M. Griffith	3	18	3
Penmon and Llanfaes Churches, per Rev. T. Lloyd Kyffin, M.A.	8	16	5
Pentaceth Branch, per Rev. E. P. Howell	2	-	-
Proceeds of Concert at Beaumaris, by the Kentucky Darkies	4	8	4
Bangor May Day Procession	40	3	-
Total	£76	13	-

RHOSNEIGR STATION.

	£.	s.	d.
Local Committee—			
Rev. Canon WILLIAMS, Chairman.			
Mr. D. T. ELIAS.			
Mr. ROBERT HOTTON.			
Rev. J. C. JONES.			
Mr. JOHN O. JONES.			
Mr. ROBERT JONES.			
Mr. HUGH WILLIAMS.			
Mr. WILLIAM WILLIAMS.			

Honorary Secretary—
Mr. WILLIAM JONES.

	£.	s.	d.
Annual Subscriptions.			
Elias, D. T. Esq.	1	1	-
Jones, H. Esq.	-	5	-
Jones, J. R. Esq., J. P.	-	5	-
Jones, R. E. Esq.	-	10	-
Owen, Mrs.	1	1	-
Williams, Rev. Canon	10	-	-
Total	£3	12	-

	£.	s.	d.
Donations.			
Sums under 5s.	1	-	6
Total Dons.	£91	14	6
Total Subs.	£77	13	6
Total	£172	8	-

HOLYHEAD AND PORTH RHUFFYDD BRANCH.

President—
The Right Hon. LORD STANLEY OF ALDERLEY.

Local Committee—
Capt. CLAPP, R.N., Chairman.
Capt. BINNIE.
Mr. CARTER, Chief Officer H.M. Coast Guard.
Mr. E. C. CORBET.
Mr. R. J. EDWARDS.
Mr. J. LLOYD GRIFFITH.
Dr. E. T. HUGHES.
Mr. J. HUGHES.
Capt. J. JONES.
Capt. PINCHIN.
Capt. ROCHR.
Capt. ROBERTS.
Mr. E. G. ROBERTS, Solicitor.

Treasurer—
Rev. JAMES JONES.
Honorary Secretary—
Capt. KENDALL.

Annual Subscriptions.

	£.	s.	d.
Adeane, Miss	10	6	-
Binney, Capt.	1	-	-
Brereton, Mrs.	10	-	-
Clapp, Capt., R.N.	10	6	-
Corbet, Mr. E. C.	1	-	-
Edwards, Mr. R. J.	10	6	-
Griffith, Mr. J. Lloyd	1	-	-
Hughes, Dr. E. T.	10	6	-
Hughes, Mr. J.	5	-	-
Jones, Capt.	5	-	-
Jones, Mr., R.N.	5	-	-
Kendall, Capt.	1	-	-
Lewis, Mr., Bangor	10	6	-
London and North Western Railway Co.	10	-	-
Owen, Miss	10	6	-
Peake, Miss, Bangor	5	-	-
Pigott, Mr.	10	-	-
Pinchin, Capt.	10	6	-
Roberts, Mr. E. G.	10	-	-
Roberts, Mr. T. J.	5	-	-
Roche, Capt.	1	-	-
Thomas, Capt.	10	6	-
Thomas, Canon D.	10	-	-
Walter	10	-	-
Thomson, Capt.	1	1	-
Varian, Capt.	10	6	-
Sums under 5s.	2	6	-
Total	£24	7	-

	£.	s.	d.
Donations.			
Various amounts	2	5	-
Total	£26	12	-

LADIES' COMMITTEE.

President—Mrs. KENDALL.
Hon. Treasurer—
Mrs. ORR.
Hon. Secretary—
House-to-house Collection.
Northern District—
Miss Roberts 5 11 6
North Eastern District—
Hughes, Mrs., and Miss Johnson 6 14 -
Eastern District—
Kendall, Mrs., and Miss Shaw 3 10 9
Southern District—
Miss Lewis 11 12 11

West-ern District—

	£.	s.	d.
Lewis, Miss G., and Miss A. Hughes	2	14	3
North Central—			
Orr, Mrs.	5	10	-
South Central—			
Blower, Mr., Clapham Cammon	1	1	-
Clay & Williams, Messrs.	2	12	10
Hilton & Son, Messrs., Leicester	-	10	-
Lewis, Messrs. S. & Co., Bangor	1	1	-
Norton & Co., Messrs.	-	10	6
Star Tea Co.	-	10	6
Stead & Simpson	1	1	-
Waterhouse, Mr., Macclesfield	1	-	-
Total	44	3	-

Proceeds of Rum-mage Sale 28 2 7

	£.	s.	d.
Collections in Churches—			
Ebenezer, Kingsland	1	-	-
English Presbyterian	5	-	-
Glyn Ceirog-Ruabon	1	-	-
Old Tabernacle	1	-	-
St. Cybi and St. Seiriol's	4	10	-
Work Sold	2	-	-
Total	£71	17	10

Berkshire.

BERKSHIRE BRANCH.

(No Local Committee.)

Honorary Secretary—
C. STEPHENS, Esq.

Annual Subscriptions.

	£.	s.	d.
Allsop, Mr. R. J.	10	-	-
Ayres, Messrs. C. & G.	10	6	-
Barnett, F. C. C. Esq.	1	1	-
Barningham, W. Esq.	1	1	-
Bartholomew, A. C. Esq.	10	-	-
Baynes, Mr. E.	10	6	-
Baylis & Co., Messrs.	10	6	-
Beale and Martin, Messrs.	1	1	-
Beale, Miss	10	6	-
Benyon, R. Esq.	3	3	-
"Berks Chronicle" Proprietors of	10	6	-
Birch, Mrs.	1	-	-
Bird, Mr. H.	10	6	-
Blandy, F. J. Esq.	1	1	-
Blandy, H. B. Esq.	1	1	-
Blandy, W. F. Esq.	1	1	-
Botley & Lewis, Messrs.	10	6	-
Bottrell & Son, Messrs.	10	6	-
Bracher and Sydenham, Messrs.	10	6	-
Bradley & Son, Messrs.	10	6	-
Bradley, Mr. Chas.	10	6	-
Brain, Mr. W. J.	10	6	-
Brain, Mr. S.	10	6	-
Briun, Mr. W. I. J.	10	6	-
Brown, Messrs. J. D. & Son	1	-	-

	£.	s.	d.
Brown, Mr. Jno.	10	-	-
Brown, Lt.-Col.	10	6	-
Butler, Mr. C.	10	6	-
Clarke, R. L., Esq.	10	-	-
Cobham, Capt. A. W.	1	1	-
Cobham, A. C. Esq.	1	-	-
Cocks, Messrs. C. & Co.	10	6	-
Cocks, Miss E.	10	6	-
Colebrook & Co., Messrs.	10	6	-
Collins, Chas. Esq.	10	6	-
Collins, Henry, Esq.	10	6	-
Cook, Mr. J. R.	10	6	-
Cooper, Mr. J. O.	10	-	-
Cooper, Mr. J. J.	10	-	-
Cowslade, W. W. Esq.	1	1	-
Crawshaw, W. T. Esq.	1	1	-
Cromwell, Rev. Canon	10	6	-
Dodd, Son & Rawstone	10	6	-
Doveton, Lt.-Col. H.	10	6	-
Dowsett Bros., Messrs.	10	6	-
Dunlop & Son, Messrs.	10	6	-
East, Mr. A. H.	10	6	-
E. C. P.	1	1	-
Eppstein, Rev. W. E.	10	6	-
Ferguson & Sons, Messrs.	10	6	-
Fellowes, J. H. Esq.	1	1	-
Flanagan, Mr. W. G.	10	6	-
Forbes, A. C. Esq.	1	1	-
Garland, Mrs.	1	1	-
Garry, Rev. Canon	1	1	-
Goodenough, Mr. F.	10	6	-
Greenslade, Mr. H. E.	10	6	-
Griffith, Mr. S.	10	-	-
Hankey, Sidney A. Esq.	1	1	-
Harris, Miss S.	1	1	-
Haslam & Sons, Messrs.	10	6	-
Hawker, The Misses	1	1	-
Hawkins, H. Esq.	10	-	-
Haynes, Mr.	10	-	-
Heelas & Sons, Messrs.	2	2	-
Hewett, C. E. Esq.	10	6	-
Hewett, Robt. Esq.	1	1	-
Hewett, T. E. Esq.	1	1	-
Higgs & Sons, Messrs.	10	6	-
Hill, Arthur, Esq.	10	6	-
Hill, Mr. T. E.	10	6	-
Hurley, Mr. A.	10	6	-
Kingham, Messrs. W. & Sons	10	6	-
Knipe, Lt.-Col.	1	1	-
Knox, H. Esq.	1	1	-
Long, Messrs. Sons & Everard	1	1	-
Maurice, O. C. Esq.	10	6	-
McIlroy, Mr. W.	10	-	-
Messers, Limited	10	6	-
Millar, Mr. W. G.	10	6	-
Milsom, J. & Sons, Messrs.	10	6	-
Monck, J. B. Esq.	1	1	-
Morris, Mr. E.	10	6	-
Morris, Mr. Josh.	1	1	-
Mount, W. G. Esq., M.P.	1	1	-
Murdoch, C. T. Esq., M.P.	1	1	-
Nicholas, Mr. W. R.	10	6	-
Oakshott, Mr. R.	10	-	-
Outen, Miss	10	6	-
Palmer, A. Esq.	5	-	-
Palmer, George, Esq.	1	1	-
Palmer, G. W. Esq.	3	-	-
Palmer, W. H. Esq.	1	1	-
Palmer, A. J. Esq.	1	1	-
Palmer, Walter, Esq.	1	1	-
Petty & Sons, Ltd.	10	6	-
Philbrick, Messrs. C. and G.	1	1	-
Philp & Son, Messrs.	10	6	-
Player, Mrs.	10	-	-
Porter, Thomas, Esq. (the late)	1	1	-
Poulton, Mr. W.	10	-	-

	£.	s.	d.
Powys, Miss E. C.	1	1	-
Ridley & Son, Messrs.	1	1	-
Rogers, G. E. B. Esq.	10	6	-
Sawyer, Major	1	1	-
Searle, Mr. T. H.	1	1	-
Simonds, B. Esq.	10	6	-
Simonds, H. J. Esq. (the late)	1	1	-
Simonds, John, Esq.	1	1	-
Simonds, W. Esq.	1	1	-
Sisley & Goodall, Messrs.	10	6	-
Slaughter, Mr. Chas.	10	6	-
Smith, Chas. Esq.	10	-	-
Soundy & Sons, Messrs.	1	1	-
Spokes, Sir P.	1	1	-
Stephens, Rev. W. R. W.	1	1	-
Stephens, C. Esq.	2	2	-
Stephens, Capt. F.	1	1	-
Stevens, Mr. S. B.	5	-	-
Strange, J. T. Esq.	1	1	-
Strange, W. J. Esq.	1	1	-
Stransom & Sons, Messrs.	10	6	-
Sutton, A. W. Esq.	1	1	-
Sutton, Alfred, Esq.	1	1	-
Sutton, Herbert, Esq.	1	1	-
Sutton, M. H. Esq.	1	1	-
Sutton, M. J. Esq.	1	1	-
Sutton, Leonard, Esq.	1	1	-
Taylor, J. O. Esq.	10	6	-
Thoyts, Major	1	1	-
Tunbridge, Mr. F.	10	6	-
Valpy, R. H. Esq.	3	-	-
Venner & Sons, Messrs.	10	-	-
Wallis, Son, & Wells, Messrs.	10	6	-
Wallis, Miss B.	10	-	-
Waterhouse, A. Esq.	1	1	-
Wellsted & Son, Messrs.	1	1	-
Wheatley, Mr. A.	10	6	-
Wheeler Brothers, Messrs.	1	1	-
Wildor, F. Esq.	10	6	-
Wildor, Mr. Jno.	10	-	-
Withers, Mr. M. J.	10	6	-
W. B. R.	1	1	-
Sums under 10s.	12	5	-
Total	£137	7	-

Donations.

Wantage, Lord, V.C.	5	-	-
Boxes—			
Pillar	1	4	-
Queen's Hotel	17	-	-
Victoria Cafe	1	-	-
Sums under 5s.	2	6	-
Total Dons.	7	19	10
Total Subs.	137	7	-
	£145	6	10

NEWBURY DISTRICT.

(No Local Committee.)

Collector—

Mr. WM. GAMBLE.

Annual Subscriptions.

Arkwright, Mrs.	10	6	-
Barker, R. H., Esq., M.D.	5	-	-
Baxendale, Lloyd H. Esq.	1	1	-
Blackburne - Maze, W. P. Esq.	10	-	-
Bodman, Mr. Charles	5	-	-
Browning, J. Esq.	1	1	-
Burn-Blyth, Mrs.	1	1	-

	£.	s.	d.
Chattock, R. S. Esq.	5	-	-
Dela Salle, C. R. Esq.	5	-	-
Fellowes, Mrs. T. A.	10	-	-
Forster, Paul F. Esq.	1	-	-
Herbert, Admiral	5	-	-
Howard, Lady Louisa	5	-	-
Keyser, C. E., Esq.	10	-	-
Leney, Mrs.	5	-	-
Maitland, Capt. A. F.	10	-	-
Mullens, Rev. R. H.	5	-	-
Myers, Mrs.	1	-	-
Nash, Majr W. P.	5	-	-
Ridley, Mrs.	5	-	-
Riley, Canon	5	-	-
Robinson, Rev. J. H.	5	-	-
Shuter, Mrs.	5	-	-
Skirne, Rev. H. H.	10	6	-
Stratford, Captain Wingfield	10	-	-
Townshend, Colonel G. P.	3	15	-
Tull, A. R. Esq.	1	1	-
Vandeleur, Mrs. Boyle, Oakhurst	10	6	-
Walton, W. Esq.	1	1	-
Woolfryes, Surgeon-Gen. J. A.	5	-	-
Sums under 5s.	17	6	-

	£19	8	-
Boxes	10	-	-
Total	£19	18	-

Cambridgeshire.

CAMBRIDGE BRANCH.

(No Local Committee.)

President—

Rev. E. H. PEROWNE, D.D

Vice-President—

His Worship the MAYOR

Treasurer—

OSCAR BROWNING, Esq., M.A., Fellow of King's College.

Hon. Secretary—

Annual Subscriptions.

	£.	s.	d.
Adams, Mrs.	10	-	-
Ansell, Mrs. J.	5	-	-
Bumpsted, T. B. E. q.	1	-	-
Darwin, Mrs. (the late)	10	-	-
Fawcett, W. M. Esq.	1	1	-
Foster, C. F. Esq.	3	-	-
Going, Mrs.	10	-	-
Graves, Rev. C. E.	10	-	-
Hedley, Miss J.	2	2	-
Lilley, Mr. W. E.	1	1	-
Orpen, Rev. T. H.	1	-	-
Perowne, Rev. E. H., D.D.	1	-	-
Prior, Rev. C. H.	5	-	-
Routh, Mrs.	10	-	-
Sidgwick, Mrs.	1	1	-
Smith, Mr. John	1	-	-
Thrower, Miss	10	-	-
Thurnall, Miss E.	10	-	-
Thurnall, Miss F. (the late)	10	-	-
Todhunter, Mrs.	1	1	-
Sums under 5s.	2	6	-
Total Subs.	£17	18	6

Donations.

Contribution Boxes	1	2	4
Total	£19	10	-

WISBECH BRANCH.

(No Local Committee.)

Honorary Secretary—
WILLIAM G. HAMILTON, Esq.

Annual Subscriptions.

	£.	s.	d.
English Bros.	1	1	-
Peckover, A., Esq.	1	1	-
Ropkins & Co., Messrs.	1	1	-
Total Subs.	£3	3	-

Donations.

Contribution Boxes—			
Custom House	15	5	-
Boxes under 5s.	3	-	-
Total	£4	1	5

Cardiganshire.

ABERYSTWYTH BRANCH.

Local Committee—
His Worship the MAYOR, Chairman.

W. H. COLLEY, Esq.

GEO. DAVIES, Esq.

PETER JONES, Esq.

B. E. MORGAN, Esq.

Capt. T. MORRIS.

JOHN WATKINS, Esq.

C. M. WILLIAMS, Esq.

Rev. J. WILLIAMS.

E. P. WYNN, Esq.

Honorary Secretary—

Captain THOMAS COUGHTON

Annual Subscriptions.

	£.	s.	d.
Aberystwyth Ship Insurance Society	1	1	-
Colby, W. H. Esq.	10	-	-
Cosens, Capt. G. W.	5	-	-
Davies, Geo. Esq.	10	-	-
Davies, Joseph, Esq.	5	-	-
Doughton, Capt. T.	5	-	-
Doughton, R. Esq.	10	-	-
Edwards, Mr. Evan	5	-	-
Evans, Howell, Esq.	5	-	-
Evans, Mr. Evan	5	-	-
Francis, J. Esq.	10	-	-
Fryer, H. C. Esq.	10	-	-
Griffiths, Tuo. Esq.	5	-	-
Harris, T. D. Esq.	5	-	-
Hopkins, I.	5	-	-
Jones, Peter, Esq.	5	-	-
Jones, Misses, Frog Terrace	10	-	-
Levi, Rev. Thomas	5	-	-
Morgan, John, Esq.	10	-	-
Morrice, Rev. T. R., M.A.	10	-	-
Morris, Capt. T.	5	-	-
Perrott, J. D. Esq.	5	-	-
Protheroe, Arch-deacon	5	-	-
Roberts, F. R. Esq.	5	-	-
Roberts, Messrs. R. and Sons	10	-	-
Roberts, Principal, M.A.	5	-	-
Rowlands, Dr. J. J.	10	-	-
Smith, C. C. Esq.	10	-	-
Waddingham, T. J. Esq.	1	-	-
Watkins, John, Esq.	10	-	-
Williams, C. M. Esq.	5	-	-

Williams, Rev. Prebendary, M.A.	5	-
Wynne, E. P. Esq.	5	-
Sums under 5s.	1	5
Total	£14	1

Donations.

Pillar in B. at-house.	3	5	11
Boxes at Hotels.	-	8	1
Pillar on Slip.	1	11	10
Collections, on days of Exercise.	24	1	6
Total Dons.	29	7	4
Total Subs.	14	1	4

£43	8	4
------------	----------	----------

CARDIGAN BRANCH.

Local Committee—

W. PICTON EVANS, Esq.,
Chairman.
MR. BUCKHAM.
LEVI JAMES, Esq.
Capt. JOHN PHILLIPS.
Capt. GEORGE RICHARDS.
C. E. D. MORGAN RICHARDSON, Esq.

Honorary Secretary—
MR. WILLIAM JOSEPH.

Annual Subscriptions.

Brigstoke, W. O. Esq.	10	-
Brigstoke, Mrs.	1	-
Colby, Mrs. J.	1	-
Davies, Mrs.	5	-
Evans, W. P. Esq.	10	-
Howell, Colonel.	1	-
Howell, Misses.	5	-
James, Levi, Esq.	5	-
Jenkins, L. H. Esq.	5	-
Jones, Morgan, Esq.	1	-
Lloyd's Bank.	10	-
Mitchell, J. F. Esq.	5	-
Parry, Capt. Jones.	5	-
Phillips, J. Esq., M.D.	5	-
Richardson, C. E. D.	10	6
Morgan, Esq.	1	8
Sums under 5s.	1	8
Total	£9	3

Donations.

Capt. Jno. Evans, Esq.	3	14
Specialist.	1	4
Collections at Bethesda Baptist Church, Cardigan.	1	12
Collections at Fethsaida Baptist Chapel, St. Dogmels.	2	1
Mr. Studt's Gondolas.	3	3
Contribution Boxes.	2	2
Total Dons.	12	13
Total Subs.	9	3
£21	16	11

NEWQUAY & ABERAYRON BRANCH.

Local Committee—

Rev. STEVEN JONES, Rector,
Chairman.
Capt. THOMAS EVANS.
Dr. THOMAS EVANS.
JOHN EVANS, Esq., Penwig.
Capt. T. JONES.
JOHN PATRICK, Esq.
Mr. EDWARD SHARLOCK.

Honorary Secretary—
Capt. DAVID REES.

Annual Subscriptions.

Bronwyd, Sir Martin Lloyd.	1	-
Campbell, Mrs.	5	-
Davies, Capt. T.	5	-
Davies, E. F. Esq.	5	-
Davies, T. Esq.	10	-
Evans, Dr.	5	-
Evans, J. Esq., Pen-yuig.	5	-
Jones, Capt. Thos.	5	-
Jones, Rev. Steven.	5	-
Lewis, Colonel.	5	-
Lewis, Mrs. Col.	2	2
Lloyd, Mr. and Mrs.	12	6
National Provincial Bank.	2	-
Patrick, J. Esq.	5	-
Rees, Capt. D.	5	-
Stewart, Capt. All-tyroden.	10	-
Thomas, Miss.	5	-
Sums under 5s.	7	6
Total Subs.	£16	16

Donations

Box collections.	10	-
Total.	£17	6

Carmarthenshire.

FERRYSIDE AND CARMARTHEN BAY BRANCH.

President—
VISCOUNT EMLYN.

Vice-President—
RICHARD E. JENNINGS, Esq.

Local Committee—

A. BRIGSTOCKE, Esq.
NORL CHURCH, Esq.
PERCY DOUGLAS-WILLAN, Esq.
T. W. DOUGLAS-WILLAN, Esq.
DUDLEY W. DRUMMOND, Esq.
CYRIL A. JONES, Esq.
R. A. NEVILL, Esq.
Capt. A. NEWLAND.
R. W. PELL, Esq.
J. J. SCOTT, Esq.
Capt. W. THOMAS.
D. LEWIS WILLIAMS, Esq.

Honorary Secretary—
Lieut.-Col. J. H. PELLY FRV.

Annual Subscriptions.

Bath, Edward H. Esq.	1	-
Bell, J. Williams Esq.	5	-
Brigstocke, Mrs.	1	-
Cawdor, The Right Hon. the Earl of.	5	-
Church, Noel, Esq.	10	6
Ditto, 1895.	10	6
Colby, Mrs.	1	-
Cross, Miss Arengo.	10	6
Douglas - Willan, Percy, Esq.	10	6
Drummond, Dudley W. Esq.	1	-
Dynevor, The Right Hon. Lord.	5	-
Emlyn, Viscount.	1	1
Evans, Exors. of late W. Esq.	1	1
Falkener, F. Esq.	1	1
Fry, Lieut.-Col. J. H. Pelly.	1	1
Fry, Miss H. L.	10	6
Fry, Miss E. J.	10	6
Gwynne-Hughes, Col.	10	6
Gwyn, Miss.	5	-
Harrison, Captain Nicolls.	1	1
Hills-Johnes, Sir J., G.C.B., V.C.	1	1
Jennings, Richard E. Esq.	1	1
Jones, Cyril A. Esq.	10	6
Jones, D. Jeffreys, Esq.	1	1
Morris, C. S. Esq.	10	-
Nevill, R. A. Esq.	10	6
Nevill, Mrs. R. A.	10	6
Newland, Capt. A.	1	1
Norton, Mrs. W.	1	1
Peel, Mrs.	10	-
Peel, E. W. H. Esq.	1	-
Peel, R. W. Esq.	1	1
Potter, G. W. Esq.	1	1
Priest, Mrs.	10	-
Richards, R. W. Esq.	5	-
Saunders, W. Esq.	1	-
Scott, J. J. Esq.	10	-
St. David's, The Bishop of.	2	2
Thomas, Lester & Co., Messrs.	1	1
Thomas, Mrs. Henry.	1	1
Timms, S. J. Esq.	1	1
Tregoning, J. S. Esq.	1	1
Warburton, Mrs.	1	-
Williams, D. Lewis, Esq.	10	6
Total.	£14	8

Donations.

Bevan, Miss.	10	-
Drummond, Sir James, Bart.	1	-
White, H. Brunel, Esq.	10	-
Llanstephan Church per G. W. Potter, Esq.	1	1
Mydrim Church, per Rev. A. Bri ten.	1	7
Collecting Card, per Miss M. Evans.	9	-
Collecting Card, per Miss J. Williams.	8	-
Contribution Boxes.	19	11
Total Dons.	6	4
Total Subs.	44	8
£50	12	11

LLANELLY AND BURRY PORT BRANCH.

Local Committee—

The EARL OF ASHBURNHAM,
President.
HUGH NEVILL, Esq., Vice-President.
MR. W. I. COLLIVER.
MR. P. COLIN FOWLER.
MR. THOMAS GRIFFITHS.
MR. W. GUNTER.
MR. GEO. HANCOCK.
MR. E. NORTHMORE JONES.
MR. H. ELLIS POOLE.
MR. D. L. REES.
MR. D. W. REES.
MR. R. S. SEYMOUR.
MR. J. G. THOMAS.
MR. T. REES THOMAS.
MR. ERNEST THURSHAW.
MR. E. WILCOX, Chief Officer I.L.M. Coastguard.

Honorary Secretary—
GERARD ELKINGTON, Esq.

Annual Subscriptions.

Ashburnham, The Earl of.	5	5
Ashburnham Tin-plate Co., Ltd.	1	1
Bevan, S., Bevan & Son, Messrs.	10	6
Bond, Mr. F. W.	1	1
Bond, Mr. H. C.	1	1
Buckley Brothers, Messrs.	1	1
Buckley, Dr.	10	6
Burry Port and Gwent Breath Valley Co.	2	2
Bythway, Mr. W.	10	6
Colliver, Mr. W. I.	10	6
Edmunds, Mr. Henry.	5	-
Edwards, Mr. D. C.	10	6
Elkington, Mr. G. B.	1	1
Elkington, Mr. H.	1	1
Elkington, Mr. J. B.	1	1
Elliott's Metal Co., Limited.	2	2
Evans, Mr. David.	1	1
Evans, Mr. Gwilym.	5	-
Ferry, Mr. L. G. de.	1	1
Fowler, Mr. Colin P.	10	6
Gilchrist, Messrs. R. & Co.	1	1
Griffiths, Mr. Thomas.	10	6
Howell, Mr. W.	5	-
John, Mr. David.	5	-
Jones, Mr. E. Northmore.	10	6
Jones, Mr. T. Wesley.	5	-
Lewis, Mrs. C. W. Mansel.	1	1
Lewis, Mr. W.	5	-
Llanelly Harbour Commissioners.	5	-
Maclaren, Mr. Rowland.	10	6
Margrave, Mr. Robt.	10	6
Mayberry, Mr. Joseph.	5	-
Nevill, Druce & Co., Messrs.	3	-
Nevill, Messrs. R. & Co., Limited.	1	1
Pemberton, Mr. H. W.	2	2
Pembrey White Lead Works Co.	1	1
Poole, Mr. H. Ellis.	10	6
Randell, J. & Son, Messrs.	5	-
Rees, Mr. Bernard.	5	-
Rees, Mr. D. L.	5	-
Rees, Mr. D. W.	10	6
Rees, Mrs. Mansel.	1	1
Roderick, Mr. W. Buckley.	10	6

	£.	s.	d.
Rogers, Mr. John H.	1	1	-
Seymour, Mr. R. S.	5	-	-
Stephens, D., & Co.	10	6	-
Stepney, Sir A. K.			
Cowell	3	-	-
Thomas, Mr. J. G.	5	-	-
Thomas, Mr. Owen	10	6	-
Thomas, Mr. T. Rees	5	-	-
Thomas, Mrs. Henry	1	1	-
Tregoning, Mr. J. S.	1	1	-
The Waddle "Patent"			
Fan & Engineering			
Co.	2	2	-
Williams, Mr. H.	5	-	-
Western Tinplate			
Co., Limited	2	2	-
Sums under 5s.	5	-	-
Total	£56	4	6

Donations.

Evans, Mrs.	10	-	-
Rogers & Wright,			
Messrs.	1	1	-
Contribution Boxes.	16	1	-
Collected on Burry			
Port Regatta day,			
7th August	3	8	6
Ditto, 11th Sept.	2	11	9
Total Dons.	8	7	4
Total Subs.	£61	11	10

Carnarvonshire.

ABERSOCH BRANCH.

Local Committee—
W. ANTHONY, Esq., Mayor of Pwllheli, Chairman.
T. L. MANCHESTER, Esq., Vice-Chairman.
DR. HUNTER HUGHES, Capt. GEORGE.
J. G. JONES, Esq., J. P.
MR. O. ROBYS OWEN,
ARTHUR O. OWEN, Esq.,
RICHARD ROBERTS, Esq.,
Capt. JOHN THOMAS.

Hon. Secretary—
Capt. E. JONES.

Annual Subscriptions.

	£.	s.	d.
Ashton-Smith,			
G. W. D., Esq.	2	10	-
Evans, Owen, Esq.	1	-	-
Nanney, H. J. Ellis,			
Esq.	1	-	-
Port Madoc Mutual			
Marine Insurance,	5	-	-
Total	£9	10	-

CARNARVON AND LLANDDWYN BRANCH.

Local Committee—
The Hon. F. G. WYNN, Chairman.
J. H. GRIFFITH, Esq.,
LLOYD HUGHES, Esq.,
C. A. JONES, Esq.,
Rev. J. W. WYNN JONES,
M.A. (Vicar).

JOHN OWEN, Esq.,
W. H. OWEN, Esq.,
EDWD. H. OWEN, Esq.,
Sir LLEWELYN TURNER,
Lieut.-Col. ROBT. WILLIAMS,
THE COLLECTOR, H.M. CUSTOMS, *ex-officio.*
THE CHIEF OFFICER OF H.M. COASTGUARD, *ex-officio.*

Honorary Secretary—
HUGH RICHARDS, Esq.

Annual Subscriptions.

	£.	s.	d.
Griffith, J. H., Esq.	1	1	-
Hughes, Lloyd, Esq.	1	1	-
Jones, C. A., Esq.	10	6	-
Jones, Rev. J. W.			
Wynne, M.A.	1	1	-
Owen, E. H., Esq.			
(1895-96)	2	2	-
Owen, John, Esq.			
(1895-96)	2	2	-
Owen, W. H., Esq.			
(1895)	1	1	-
Turner, Sir Llewelyn			
(1895-96)	2	2	-
Williams, Lieut.-Col.			
Robt.	1	1	-
Wynn, The Hon. F.G.			
(1895-96)	2	2	-
Total	£14	3	6

Donations.

Boxes—

H.M. Custom			
House	5	16	3
Royal Welsh Yacht			
Club	1	5	1
Carnarvon Castle	13	7	-
Llanddwyn Station	5	1	-
Mr. Parnham	13	-	-
Hon. Sec.'s Office			
Box	15	7	-
Royal Hotel	8	1	-
Capt. Thos. Owen	7	6	-
"Ship and Castle"	3	8	-
Silent Battery	12	3	-
Total Dons.	11	5	1
Total Subs.	£14	3	6
	£25	8	7

CRICCIETH BRANCH.

Chairman—
J. E. GREAVES, Esq.

Local Committee—
RANDAL CASSON, Esq.,
J. E. GREAVES, Esq.,
H. M. GREAVES, Esq.,
Capt. EVAN JONES,
Capt. MORRIS JONES,
Capt. D. RICHARDS,
Capt. ROBERT WILLIAMS.

Treasurer and Hon. Secretary—
RANDAL CASSON, Esq.

Annual Subscriptions.

Casson, Randal, Esq.	1	1	-
Ellis-Nanney, H. J.			
Esq.	1	-	-
Evans, Owen, Esq.	1	1	-
Greaves & Sons,			
John W.	1	-	-
Greaves, J. E. Esq.	1	1	-
Greaves, R. M. Esq.	1	1	-
Hopkinson, Mrs.	10	6	-

	£.	s.	d.
Jones, Wm. Esq.	1	-	-
Lowson, W. Esq.	10	6	-
Mutual Insurance			
Society	5	-	-
Oakeley, W. E. Esq.			
(for 1895)	5	-	-
Priestley, Misses	1	-	-
Roche, F. W. A. Esq.	1	1	-
Total Subs.	£20	6	-

Contribution Boxes.

Criccieth	13	7	-
Total	£20	19	7

LLANAEHAIARN BRANCH.

Local Committee.

W. ANTHONY, Esq., Ex-Mayor of Pwllheli, Chairman.
T. L. MANCHESTER, Esq., Vice-Chairman.
DR. HUNTER HUGHES,
Capt. GEORGE.
J. G. JONES, Esq., J. P.
ARTHUR O. OWEN, Esq.,
MR. O. ROBYS OWEN,
RICHARD ROBERTS, Esq.,
Capt. JOHN THOMAS.

Honorary Secretary—
Capt. E. JONES.

(No list in 1896.)

LLANDUDNO (ORME'S HEAD) BRANCH.

President—
The Right Hon. Lord MOSTYN.

Local Committee—
DR. K. H. BOLD WILLIAMS, J.P., Chairman,
RD. CONWAY, Esq.,
S. DUNPHY, Esq.,
GEORGE A. HUMPHREYS, Esq.,
Rev. F. G. JONES,
Rev. J. MORGAN, M.A.,
Hon. H. LLOYD MOSTYN, J.P.,
THOS. WILLIAMS, Esq.,

Treasurer—
J. ADEY WELLS, Esq.,
N.P. Bank, Llandudno.

Honorary Secretary—
Rev. JOHN RAYMOND.

Annual Subscriptions.

Arnold & Hughes	10	6	-
Barker, Thos., J.P.	1	1	-
Bone, E. E.	10	6	-
Bartley, S.	5	-	-
Broome, J., J.P.	1	1	-
Charlton, Henry	1	1	-
Conway, Richard	10	6	-
Dunphy, S.	10	6	-
Edge, Thos.	10	6	-
Evans, A.	10	6	-
Fisher, Miss.	10	6	-
Goode, Mrs.	10	6	-
Hanmer, Miss.	10	-	-
Hinde, Mrs.	10	-	-
Morgan, Rev. J.,			
M.A.	10	6	-

	£.	s.	d.
Mostyn, Hon. H.			
Lloyd, J.P.	1	1	-
Mostyn, Lady Augusta			
.....	1	1	-
Nicol, Dr. J. P.	10	6	-
Pilkington, O. S. (2			
years)	1	-	-
Roberts, I.	10	6	-
Slater, Isaac	10	6	-
Walker, John	1	1	-
Wells, J. Adey	1	1	-
Williams, Bold, Dr.,			
J.P.	1	1	-
Williams Mrs., Corwen	5	-	-
Williams, Thomas	10	6	-
Wilson, M. M.	1	1	-
Total	£23	10	6

Donations.

Mr. Thos. Barton	2	-	-
Concert by the			
K.D.A.M.S.	10	15	6
Total	£12	15	6

LADIES' LIFE-BOAT SATURDAY COLLECTION.

Donations.

Barker, Miss, Hon. Treasurer	10	6	-
Broome, Mrs.	1	-	-
Fincham, Mrs.	5	-	-
Hall, C. R. Esq.	5	-	-
Jones, Elias, Esq., J.P.	10	6	-
Jones, Revd. F. Griffith	10	-	-
Mostyn, Hon. Mrs. Henry Lloyd	1	-	-
Parry, Mrs. Williams Jones	2	-	-
Williams, Mrs. Thomas	10	-	-
Total	£5	11	-

District Collection.

No. 1. Mme. Riviere	4	7	-
No. 2. Mrs. Bold Williams and Miss Heiland Browne	3	2	9
No. 3. Mrs. Raymond and Miss Roberts, Melifont	12	4	8
No. 4. Miss C. Roberts, Wave Crest	10	12	3
No. 5. Miss Amelia Barker	2	17	-
No. 6. Miss A. Tyrer	1	12	10
No. 7. Misses Hindie and Miss Maude Butters	2	1	9
No. 8. Masters Hewitt and Cooper	19	1	-
No. 9. Miss Jones, Trostreay	1	5	-
No. 10. Misses L unphye	1	2	10
No. 11. Misses Turner	1	10	4
No. 12. The Rt. Hon. Lady Augusta Mostyn	3	17	3
No. 15. Mrs. Adey Wells	2	18	6
No. 16. Grosvenor Restaurant	8	9	-
No. 17. Miss Melson			
con va l e s c e n t			
Home, Llanrhos	5	-	-
Total Col.	49	5	-
Total Dons.	6	11	-
Total	£55	16	-

Collections at Hotels and Boarding Establishments on Sunday preceding August Bank Holiday.

	£.	s.	d.
Ashby Manor	1	8	
Alexandra	9	7	
Bryn Arvon	14	6	
Craig Side Hydro	7	5	
Clarence	14	5	
Craig-y-Don	4	-	
Evans' Temperance	2	10	
Ferndale	16	8	
Glan-y-Mor	13	7	
Goulding's	1	6	2
Goodwin's	1	-	
Heath House	12	8	
Holly Bank	2	-	
Hydro	1	4	4
Imperial	5	-	
Jackson's	17	2	
Lockyer's	1	18	
Marine	2	2	6
Moon's	1	7	-
Metropole	5	3	
Neville	6	11	
Overstrand	13	6	
Parade Hotel	10	-	
Prince of Wales	13	5	
Queen's	1	10	1
Royal	10	-	
St. George's	5	4	2
St. Kilda	13	1	
Vincent's	12	10	
Wave Crest	3	2	-
West End	1	-	
White House	12	5	
Sums under 5s.	7	3	
Total	£11	15	7

Collecting Boxes.

Promenade box and collected on sand	5	19	10
Pier box	1	15	-
Penmenmaur box	2	3	6
Total	£9	18	2

Total Dons.	130	5	4
Total Subs.	23	10	6
£153	15	10	

PORTHDLINLLAEN BRANCH.

Local Committee—
Dr. J. EVANS HUGHES, J.P., Chairman.

Honorary Secretary—
Captain H. ROBERTS.

Annual Subscriptions.

Asheton-Smith, G. W.	2	10	
D. Esq.	10	-	
Carreg, Robert, Esq.	10	-	
Evans, O. Esq.	1	1	
Finch, Col. Wynne	2	-	
Hughes, J. E. Esq.	5	-	
Millar, H. E. Esq.	10	-	
Yale, Wm. Corbett, Esq.	1	1	
Yardley, Mrs.	5	-	
Total Subs.	£8	2	-

Donations.

Collecting Boxes	19	2	
Collecting Boxes	6	10	3
Total	£16	11	5

PWLLHELI BRANCH.

Local Committee.
W. ANTHONY, Esq., ex-Mayor of Pwllheli, Chairman.

T. L. MANCHESTER, Esq., Vice-Chairman.

Capt. GEORGE DR. HUNTER HUGHES.
Mr. O. ROBYNS OWEN.
Capt. JOHN THOMAS.
J. G. JONES, Esq., J.P.
ARTHUR O. OWEN, Esq.
RICHARD ROBERTS, Esq.

Hon. Secretary—
Capt. E. JONES.

Annual Subscriptions.

	£.	s.	d.
Anthony, W. Esq., ex-Mayor	10	6	
Eady, Seymour, Esq.	5	-	
Evans, Capt.	5	-	
Griffith, Dr.	5	-	
Griffiths, R.	5	-	
Hughes, Dr. Hunter	10	-	
Lewis, Capt.	5	-	
Owen, A. O. Esq.	10	6	
Roberts, Richd. Esq.	1	1	-
Solicitor	1	1	-
Williams, Mr. Owen	5	-	
Willoughby, Mr. John	5	-	
Winslow, Thos. Esq.	5	-	
Sums under 5s.	5	10	6
Total Subs.	£10	2	6

Donations.

Contribution Boxes	12	6	
Collected on Beach (Illuminations, &c.)	10	-	
Total	£11	5	-

Cheshire.

CHESTER BRANCH.

(No Local Committee.)

Hon. Treasurer—
J. R. THOMSON, Esq., J.P.

Annual Subscriptions.

	£.	s.	d.
Dixon, T. H. Esq.	5	-	
Dixon, Mrs., Stanley Place	1	1	-
Fleming, T. R. Esq.	1	-	
Granger, Mrs.	1	1	-
Massie, Admiral	1	1	-
Rogers, John, Esq.	1	1	-
Tilston, Miss.	1	1	-
Wood, A. Esq., J.P.	1	1	-
Total	£12	6	-

RUNCORN BRANCH.

(No Local Committee.)

Honorary Secretary—
J. H. HAMILTON, Esq.

Annual Subscriptions.

Ashley, Miss M. E. and J. F.	10	-	
------------------------------	----	---	--

	£.	s.	d.
Anderton Company	10	6	
Ashton, J., Colonel	10	-	
Ashworth and Sons, Ltd.	10	6	
Barker, R. & Co.	1	1	-
Bellamy, Mr. G.	5	-	
Bolton and Sons, Messrs. T.	10	6	
Bolton, G. H. Esq.	2	2	
Branch, H. Esq.	5	-	
Brookes, Sir Richard	1	-	
Brundrit, J. Esq.	1	1	-
Buck, Mr. A.	5	-	
Buckley, J.	5	-	
Burton, J. Esq.	5	-	
Carter, Mr. W. J.	5	-	
Collier, Mr. Walter	5	-	
Cooper, Mr. W.	10	-	
Crossfield, J. J. Esq.	10	-	
Davidson, R. H.	10	6	
Davies, Capt. E.	5	-	
Davis, Mr. J. S.	5	-	
Deacon, H. W. Esq.	1	-	
Dobson, Mr. J.	5	-	
Earp, W. R. Esq.	10	-	
Forrester, J. Esq.	5	-	
Fox Bros.	5	-	
Frith, J. R. Esq.	5	-	
Frith, W. B. Esq.	5	-	
Gandy, E.	10	-	
Gerrard, J. Esq. Jun.	5	-	
Gilliat, J. S. Esq., M.P.	1	1	-
Hailwood, G.	5	-	
Hankinson & Sons	5	-	
Harrison, C. R. H. Esq.	5	-	
Hayes, G. W. Esq.	1	1	-
Haye, Miss H. F.	5	-	
Haywood & Masey	5	-	
Hazelhurst, Mrs.	1	1	-
Higson, J. H. Esq.	1	1	-
Holland, J. B. Esq.	5	-	
Hough, A.	5	-	
Imison, E. Esq.	5	-	
Jolliffe, W. D. Esq.	10	-	
Knight, G. J. Esq.	5	-	
Lake, F. A. Esq.	10	-	
Lees, Mrs.	5	-	
Lightburn, J. W. Esq.	5	-	
Linaker & Linaker, Messrs.	5	-	
Littler, Mr. James	5	-	
Littler, Mr. John	5	-	
Miles, W.	5	-	
Moore, R.	5	-	
Norman, F. J. Esq.	5	-	
Norman, J. R. Esq.	5	-	
Peapoint, Mr. R. W.	5	-	
Pickering, W. H. Esq.	10	-	
Potter & King, Messrs.	5	-	
Potter & Co., Messrs. J. W.	5	-	
Price, T. E. Esq.	5	-	
Pritchard, J.	5	-	
Rigby & Son, Messrs.	5	-	
Robinson, Dr.	5	-	
Rowland, Wm. Esq.	10	6	
Runcorn Co-operative Industrial and Provident Society	2	2	-
Salt Union, Ltd.	1	1	-
Savage, Captain	6	-	
Savage, Mr. J.	5	-	
Salkeld, J. H.	5	-	
Simpson, Davies & Sons, Messrs.	1	1	-
Speakman & Sons, Messrs.	10	6	
Steel, Mr. J.	10	-	
Steele, Dr. M.	10	6	
Taylor, S. Esq.	1	1	-
Vicars & Son, Messrs.	1	1	-
Walker & Sons, Messrs. P.	2	2	-
Wass, Mr. W. R.	5	-	
Weston, Mr. J. H.	5	-	
Wigg, Charles, Esq.	1	1	-
Wright, Miss E.	1	-	
Wright, Miss H.	1	-	
Whinyates, Mr. T.	5	-	
White, H. Esq.	5	-	

	£.	s.	d.
Whittaker, Wm. Esq.	10	-	
Woodland, J. W.	5	-	
Yond, Mr. W.	5	-	
Sums under 5s.	2	4	-
Total Subs.	£45	10	6

Donations.

Brunner, Mond & Co. Messrs.	10	-	
Contribution Boxes	4	1	6
Total	£59	12	-

Cornwall.

BUDE BRANCH.

President—
The Right Hon. Sir T. DYKE ACLAID, Bart.

Local Committee—

Col. FIELD.
A. MILLS, Esq.
The Rev. BARTON MILLS.
MR. TICKELL.

Treasurer—

Capt. OLIVER DAVEY.

Honorary Secretary—

WILLIAM ROWE, Esq.

Annual Subscriptions.

	£.	s.	d.
Acland, Sir T. D. Bart.	5	-	
Constable, Mrs. A.	10	6	
Cowie, Mr. and Mrs. C. Morgan	10	-	
Field, Colonel	1	-	
King, John, Esq.	10	-	
Mills, Rev. Barton R. V.	5	-	
Mills, A. Esq.	1	1	-
Mucklow, Edward, Esq.	2	-	
Thynne, F. J. Esq.	3	-	
Total	£13	16	6

Donations.

Arm'tage, Mrs.	5	-	
Atkins, Mrs.	5	-	
Balfour, John, Esq.	1	-	
Fabian, Mrs.	5	-	
Gartington, J. E., Esq.	5	-	
Haigh, Mr. & Mrs.	5	-	
Mauls, Hon. Mrs. and Miss	5	-	
Pilcher, Mrs. A. C.	12	6	
Saunders, Misses	5	-	
Sums under 5s.	5	10	9
Total Dons.	£18	3	6
Total Subs.	£13	16	6

£22 14 9

CADGWITH BRANCH.

Local Committee—
Mr. JOSEPH NICHOLLS, Cadg-
with, Chairman.
Mr. J. D. DOOLAN, H.M.C.G.
Officer.

Honorary Secretary—
Rev. J. J. MALLOCK.

Annual Subscriptions.

	£	s.	d.
Lord St. Levan (1895-6).....	2	2	-
Davey, J. Sydney, Esq. (Rent of Boat- house).....	-	2	-

Donations.

Collecting Boxes ...	2	2	6
Total.....	£4	6	6

FALMOUTH BRANCH.

President—
W. G. CAVENTISH BENTINCK,
Esq.

Local Committee—
Comm. G. H. B. REED,
R.N., Chairman.

Capt. A. F. BEALEY.
Messrs. BROAD & SONS.
Mr. A. CHARD.
J. E. DOWNING, Esq.
H. FOOKS, Esq.
Messrs. G. C. FOX & CO.
Mr. T. R. GRYLLES.
Lieut. HEATHCOTE, R.N.
Mr. W. H. LEAN.
Mr. W. H. SOLOMON.
Commander A. T. TARGET,
R.N.
Mr. H. TILLY.
Mr. A. WILMORE.

Treasurer—
W. M. GRYLLES, Esq.

Honorary Secretary—
GEORGE CARTER, Esq.

Annual Subscriptions.

Anderson, E. D.....	1	-	-
Bassett's Estate.....	3	-	-
Boltho, Williams, Forster, Coode, Grylls & Co., Ltd	1	1	-
Broad and Sons, Messrs.....	1	1	-
Carne, Messrs. W. and E. C.....	1	1	-
Corkfield, Mr. W.....	5	-	-
Deakin, A. N.....	5	-	-
Fawcus, W. A. (two years).....	5	-	-
Fox and Co., Messrs. G. C.....	2	2	-
Grylls, T. E.....	5	-	-
Horniman, F., M.P.	1	1	-
Jenkins, Mr. W.....	5	-	-
Olver, Mrs. J.....	5	-	-
Reed Comm. G. H. B., R.N.....	1	-	-
Rogers, Mrs.....	10	-	-
Solomon, Mr. W. H.	5	-	-
Target, Lieut.....	5	-	-
Tilly, Genl., C.B.....	10	-	-
Williams, F. & C. H.	5	-	-
Wilmore, Mr. A.....	5	-	-
Sums under 5s.....	2	6	-
Total Subs.....	£14	18	6

HAYLE BRANCH.

Local Committee—

Rev. Canon HOCKIN,
Chairman.
Capt. E. BOLITHO, R.N.,
Coastguard.
JOHN GRAHAM, H.M. Cus-
toms.
F. HARVEY.
F. H. HARVEY.
W. E. ROSEWARNE.
J. SYMONS, Harbour-
Master.
H. H. TREVITHICK.
J. VIVIAN.
H. J. WARREN.

Honorary Secretary—
Mr. HENRY THOMAS.

Annual Subscriptions.

	£	s.	d.
Bain, D. W. Esq. ...	5	-	-
Basset, A. F. Esq. ...	2	-	-
Bazeley, Mr. Jas. ...	5	-	-
Boltho and Co., Ltd., Messrs.....	1	1	-
Burall, Mrs. J. H.....	1	1	-
Harvey and Co., Ltd. Messrs.....	5	-	-
Harvey, F. Haniel, Esq.....	10	-	-
Harvey, Frank, Esq.	1	1	-
Hitchens, J. Esq.....	5	-	-
Hockin, Rev. Canon.	1	1	-
Hosken, Trevithick, Polkinhorn & Co., Messrs.....	2	2	-
Mudge, James, Esq....	10	-	-
Millett, R. O. Dr.....	1	1	-
Nicholls, M. L. Esq....	10	-	-
Pearce, G. B., Esq....	5	-	-
Pool, Messrs. J. & F.	5	-	-
Pool, Mr. P. B.....	5	-	-
Rodd, Francis R. Esq.....	1	1	-
Rosewarne, W. E. Esq.....	10	-	-
St. Aubyn, Rev. H. Molesworth.....	1	1	-
St. Levan, The Right Hon. Lord.....	1	1	-
The National Explo- sives Co., Ltd.....	2	2	-
Trevithick, H. H. Esq.....	10	-	-
Tyritgham, R. W. G. Esq.....	2	2	-
Vivian, John, Esq....	10	-	-
Sums under 5s.....	10	-	-
Total Subs.....	£26	14	-

Donations.

Proceeds of Concert .	5	10	6
Contribution Boxes .	-	16	9
Church and Chapel Collections.....	1	4	6
Total	£34	5	9

LIZARD BRANCH.

Local Committee—

Rev. C. S. VIVIAN,
Chairman.
W. H. COX.
J. A. HILL.
J. H. HILL.
T. R. HOCKING.
J. BOSS, R.N.
C. M. WOOD.

Honorary Secretary—
H. APPLETON, Esq., M.R.C.S.

Annual Subscriptions.

	£	s.	d.
Robartes, Lord.....	10	10	-
St. Levan, Lord.....	1	1	-
Western Morning News Co.....	1	1	-
Total Subs.....	£12	12	-

Donations.

Collection Boxes ...	-	16	5
Total	£13	8	5

LOOE BRANCH.

President—

Sir WM. TRELAWNY, Bart.

Local Committee—

JOHN WHITE, Esq. Chairman.
Mr. E. BAWDEN.
Mr. S. BROCK, Coastguard
Officer, *ex officio*.
Capt. H. DAVEY.
Rev. E. H. GLENCROSS.
W. A. JENKIN, Esq.
J. B. KERSWILL, Esq.
Mr. JOHN POAD.
R. A. PETER, Esq., J.P.
J. K. RICHARDS, Esq.
ROBERT THOMAS, Esq.
Rev. B. W. J. TREVALDWIN.
Capt. JOHN WALTERS.

Honorary Secretary—
Mr. S. BROCK.

Annual Subscriptions.

Allen, Misses.....	5	-	-
Andrew, T. H. Esq....	5	-	-
Bawden, Mr. E.....	5	-	-
Bishop & Peter.....	10	6	-
Bush, Rev. Canon....	10	-	-
Campbell, John, Esq., C.B.....	10	-	-
Carew, Colonel.....	1	1	-
Caunter, Henry, Esq....	10	6	-
Childs, Borlase, Esq....	10	6	-
Coad, J. L. Esq.....	5	-	-
Courtney, The Rt. Hon. L., M.P.....	1	-	-
Davey, Capt. Hy.....	5	-	-
Elliott, Miss.....	5	-	-
Fisher, Mrs.....	10	6	-
Foster, L. C. Esq.....	10	-	-
Foster, Rd. Esq.....	1	1	-
Garrett, Rev. S.....	10	-	-
Gill, Dr.....	5	-	-
Glanville, Rev. H. C.	10	-	-
Glencross, Rev. Ed. H.....	10	-	-
Glencross, Rev. Jas. and Mrs.....	1	-	-
Glubb, A. L. C. Esq....	5	-	-
Grigg, John, Esq.....	10	6	-
Hermon, Rev. G.....	10	6	-
Houghton, L. F. Esq....	10	-	-
Jago, Mr.....	5	-	-
Jenkin, S. W. Esq....	10	-	-
Jenkin, W. A. Esq....	5	-	-
Jenkin, Rev. D.....	5	-	-
Kemble, Rev. A.....	1	1	-
Kerswill, J. B. Esq....	10	-	-
Kitson, Rev. J. B.....	10	-	-
Kitson, Rev. J. F.....	10	-	-
Lyons, Andrew, Esq....	10	-	-
Marshall, L. Carring- ton, Esq.....	10	-	-
Marshall, W. N. C. Esq.....	5	-	-
Newport, Mr.....	5	-	-
Norris, Hon. Justice	2	2	-
Norris, Miss.....	10	-	-
Peter, R. A. Esq. J.P.	10	6	-
Poad, Mr. John.....	5	-	-

Polkinghorne, Wm. Esq.

Polkinghorne, Wm. Esq.	5	-	-
Power, Mrs.....	5	-	-
Richards, J. R. Esq....	5	-	-
St. Germans, The Earl of.....	1	-	-
St. Germans, The Countess of.....	10	-	-
Sneyd, Mrs.....	10	-	-
Thomas, Robert, Esq....	10	-	-
Trelawny, General Jago.....	1	1	-
Trelawny, Sir W. L.S.	1	1	-
Trevaldwyn, Rev. E. W. J.....	10	6	-
Trevaldwyn, Mrs.....	10	6	-
Trewren, J. Cymo, Esq.....	10	-	-
Walters, Capt. John...	5	-	-
Walters, Mr. John...	5	-	-
Westmacott, Rev. A....	5	-	-
Webb, Dr. J. Eustace...	10	-	-
Wheeler, Rev. H. N....	5	-	-
White, J. Esq.....	1	1	-
White, Mrs. J.....	10	6	-
Total Subs.	£31	7	6

Donations.

Pillar Boxes.....	1	13	-
Small sums under 5s.	-	2	6
Total.....	£33	3	-

MEVAGISSEY BRANCH.

Local Committee—

JOHN TREMAYNE, Esq., J.P.,
President.
Capt. WALTER WILLIAMS,
Chairman.
W. U. TRELLEAVEN, Esq.,
Treasurer.
Capt. J. BALL FARRAN,
Honorary Secretary.

Annual Subscriptions.

Coode, Arthur, Esq....	10	-	-
J.P.....	10	-	-
Farran, Capt. J. B....	5	-	-
Higman, J. W. Esq....	10	6	-
J.P.....	10	6	-
Mt. Edgecombe, Lord	3	-	-
Petherick, Mrs. Geo.	1	-	-
Smith, J. Dunn, Esq.	1	1	-
Tremayne, J. Esq., J.P.....	2	-	-
Walker, Dr. J. C.....	10	6	-
Williams, J. C. Esq., M.P.....	3	-	-
Total.....	£11	17	-

MULLION BRANCH.

Local Committee—

J. SYDNEY DAVEY, Esq., J.P.,
Chairman.
Mr. H. APPLETON.
Mr. J. BROWN.
Mr. W. DENNIS.
Mr. JOSIAH GEORGE.
Mr. T. H. SHEPARD.
Mr. W. T. SICH.
Mr. JOS. THOMAS.

Honorary Secretary—

Rev. J. H. SCHOLEFIELD.

Annual Subscriptions.

Davey, Mr. J.	1	-	-
Sydney.....	1	-	-
Kemphorne, Mr. J. B.....	10	-	-

	£.	s.	d.
Robarts, Lord.....	5	5	-
Thomas, Mr. Joseph.....	5	-	-
Vyvyan, Rev. Sir			
Vyell, Bart.....	1	1	-
Smaller sums.....	1	2	6
Total Subs.....	£9	3	6

Donations.

Boxes.....	-	10	5
Total.....	£9	13	11

NEWQUAY BRANCH.

Committee—
 Capt. W. ALLEN, R.N.
 J. ENNOR, Esq.
 Dr. HARDWICK.
 G. HICKS, Esq.
 W. HICKS, Esq.
 W. HUXTABLE, Esq.
 Capt. W. JENKIN.
 J. V. S. MULLER, Esq.
 J. PEARCK, Esq.
 Lieut. R. O. POLWHELE, R.N.
 A. STEPHENS, Esq.
 Capt. W. THOMAS.
 J. THOMSON, Esq.
 Capt. W. H. WILLIAMS.

Honorary Secretary—
 Mr. W. H. THOMAS, H.M.C.G.

Annual Subscriptions.

Allen, Lieut. R.N.	-	10	6
Arnall, W. Esq.	-	5	-
Boltho, Williams, Foster, Cooche, Grylls & Co.	-	10	6
Buckthought, Mrs.	-	5	-
Cardell, T. Esq.	-	5	-
Clarke, C. O. Esq.	-	5	-
Cock, W. H. Esq.	-	5	-
Ennor, J. Esq.	-	10	6
Essington, Rev. R.	-	10	-
Hardwick, Dr.	-	5	-
Hicka, G. Esq.	-	10	6
Hicka, W. Esq.	-	10	6
Huxtable, W. Esq.	-	5	-
James, Miss	-	5	-
Jenkin, A. Esq.	-	5	-
Jenkin, Capt. W.	-	5	-
Martyn, H. Esq.	-	10	-
Martyn, Wm. Esq.	-	5	-
Norway, Dr.	-	5	-
Parnell, R. W. Esq.	-	5	-
Pearce, J. Esq.	-	5	-
Pearce, Miss	1	-	-
Polwhele, R.O. Lieut. R.N.	1	-	-
Sparkes, A. F. Esq.	-	5	-
Stephens, A. Esq.	-	10	6
Taylor, R. H. Esq.	-	10	-
Thomas, Capt. Wm.	-	5	-
Thomson, J. Esq.	1	1	-
Treffry, C. E. Esq.	1	1	-
Vyvyan, Sir Vyell, Bart.	1	-	-
Williams, Capt. W. H.	-	5	-
Wilson, R. W. Esq.	-	10	6
Total Subs.....	£14	11	6

Donations.

Contribution Boxes.....	10	17	6
Collected by J. R. Thomson, Esq.			
Baker, A. E. Esq.	1	1	-
Bliss, J. Esq.	-	5	-
Bradley, James, Esq.	-	10	6
Brown, S. B. Esq.	-	5	-
Cole, H. A. V. Esq.	-	10	-

	£.	s.	d.
Cole, Robert, Esq.	-	5	-
Cowdell, H. S.	-	10	6
Evans, S. Esq.	-	10	6
Graham, E. S. Esq.	-	10	-
Greenfield, F. G. Esq.	-	5	-
Gripper, H. Esq.	-	10	6
Gripper, A. Esq.	-	5	-
Haynes, T. H.	-	10	6
Hyde, E. Esq.	-	5	-
Jepece, J. D. E. q.	-	10	6
Mason, W. S. Esq.	13	6	-
Nicholson, W. B. Esq.	-	5	-
Oakley, W. Esq.	-	10	6
Ptcairn, Jno. Esq.	-	10	6
Pratt, E. W. Esq.	-	5	-
Rolt, James, Esq.	-	10	6
Simonds, H.F. Esq.	-	10	6
Simonds, Tom, Esq.	-	10	6
Taylor, R. H. Esq.	-	5	-
Terrera, M. Esq.	-	10	-
Thomson, Mrs. C.	-	10	6
Thomasset, E. Esq.	-	10	6
Tyffe, E. W. Esq.	-	10	-
Sums under 5s.	6	13	-
Total Dons.....	£30	14	-
Total Subs.....	£14	11	6
Total.....	£45	5	6

PADSTOW BRANCH.

Local Committee—
 C. G. PRIDEAUX BRUNE, Esq. Chairman.
 Mr. CHAS. ALLFORT.
 Mr. JOHN BOLT, Chief Officer of Coast Guard.
 Mr. WM. THOS. HISCOX, Principal Officer of Customs.
 Mr. R. PALK GRIFFIN.
 Mr. JAS. GROSE.
 Mr. JNO. HAWKEN.
 Mr. F. HARVEY.
 Mr. JOS. HICKS.
 Mr. R. SUSSRX LANGFORD.
 Capt. WALTER M-AR.
 Capt. BERNHARD NILSEN.
 Rev. E. F. NUGENT.
 ROBT. A. B. PRESTON, Esq.
 Mr. WM. QUICK.
 Capt. CHAS. RAWLE.

Honorary Secretary—
 Capt. W. H. POPE.

Annual Subscriptions.

Allport, Mr. Chas.	-	5	-
Allport, Mrs. Sam.	-	10	-
Bonney, Mr. Rich.	-	5	-
Bray, Mr. Frank	-	10	-
Broad, Mr. Arch. J. B.	-	10	-
Clemow and Son, Messrs.	-	10	6
Cory & Sons, Messrs.	1	1	-
Griffin, Mr. R. Palk.	-	5	-
Grose, Jas., Esq.	1	1	-
Guy, Mark, Esq.	-	10	-
Hamilton, J. P., Esq.	1	1	-
Harvey, Mr. F.	-	10	6
Hawken, Mr. John.	-	10	-
Hicks, Mr. Joseph.	-	10	-
Hiscox, Mr. W. Thos.	-	5	-
Lander, Mr. Henry	-	5	-
Langford, Mr. R. Sussrex	-	5	-
Lloyd, Mr. J. S. H.	-	5	-
Loving, Miss	-	10	-
Marley, Mr. Hen. F.	-	5	-
Martyn, Mr. Hy. John	10	6	-
Martyn, Mr. I.	1	1	-
Martyn, Mrs. Anne.	-	5	-
Mear, Capt. Walter	-	5	-
Molesworth, The Rev. Viscount	1	1	-

	£.	s.	d.
Molesworth, Beatrice, Lady	-	10	6
Nilsen, Capt. Bernhard	-	5	-
Nugent, Rev. E. F.	-	10	6
Paynter, Rev. F.	1	1	-
Peter, Mrs.	1	-	-
Pope, Mr. W. H.	-	10	-
Preston, Robt. A. B. Esq.	1	1	-
Prideaux-Brune, C.G. Esq.	2	-	-
Quick, Mr. Wm.	-	5	-
Ramsey, Miss Emily	1	-	-
Rawley, Capt.	-	5	-
Rickard, Mr. T.	-	10	-
Robarts, Lord	1	1	-
Sums under 5s.	1	16	-
Total	£24	11	6

Donations.

Life-boat Boxes	-	6	9
Bosccastle Box, per Mrs. Smith	1	4	6
Total Dons.	£1	11	3
Total Subs.	£24	11	6
Total	£26	2	9

PENZANCE AND SENNEN COVE BRANCH.

Local Committee—
 (The Mayor), Chairman.
 W. H. ASH.
 J. BANFIELD.
 E. BATTEN.
 J. H. BENNETTS.
 Capt. BROOKS, R.N.
 F. W. BONE.
 JOHN B. CORNISH.
 R. P. COUCH.
 R. DAVEY.
 E. DOBLE.
 A. HOLBROOK.
 R. T. HOLBROOK.
 F. HOLMAN.
 A. H. JAMES.
 HY. JONES.
 W. H. JULYAN.
 H. MABBOTT.
 E. T. MATHEWS.
 A. O. MICHELL.
 H. T. READING.
 Major ROSS.
 W. F. ROWE.
 N. H. SYMONS.
 JAS. THOMAS.

Hon. Treasurer—
 P. MARRACK, Esq.

Honorary Secretary—
 T. H. CORNISH, Esq.

Annual Subscriptions.

Arm-trong, Mrs., of Nancealverne	-	10	-
Ash, J. Wilton	-	5	-
Backhouse, Mrs.	-	5	-
Banfield, John	-	5	-
Bazeley and Sons, Messrs. George	-	10	-
Bennett, W. S. Esq.	-	5	-
Bennetts, J. H.	-	10	-
Bodilly and Co.	-	10	-
Bodilly, R. H. Esq.	-	5	-
Boltho, M as N.	-	5	-
Boltho, Col. O. G.	-	5	-
Boltho, Miss Segre L.	-	5	-

	£.	s.	d.
Boltho, R. F. Esq.	1	-	-
Boltho, T. Bedford, Esq. M.P.	1	-	-
Boltho, T. Robins, Esq.	1	-	-
Borlase, The Misses, of Castle Horneck.	-	5	-
Borlase, Mrs. W.	-	5	-
Borlase, Walter H. Esq.	-	10	-
Boyns, Nichs, Bur-yan	-	5	-
Branwell and Sons, Messrs. R. M.	-	10	-
Bune, F. W., Esq.	-	5	-
Carne, Miss	2	-	-
Chenbells, A. Esq.	-	5	-
Chirgwin, P. T.	-	10	6
Code, Mrs. Marazion	2	2	-
Colenso, R. & Son	-	5	-
Cornish, J. B. Esq.	-	5	-
Cornish, Fras. J.	-	5	-
Cornish, Major T. H. Corporation of Penzance	-	5	-
Couch, R. P.	-	5	-
Couch, The Misses	-	5	-
Criddle & Smith	-	5	-
Dale, S. Y.	-	5	-
Dale, Charles F., Esq.	-	5	-
Davy, Messrs. R. V. and H.	-	5	-
Dennis, Mrs.	-	5	-
Dry Dock Co.	-	5	-
Field, Col. T. W.	-	10	6
Fitzgerald, Sir George & Lady	1	-	-
Fowler, Geo.	-	5	-
Freeman & Sons, J.	-	10	6
Gartrell, J. H.	-	10	-
Harvey & Co., Ld.	-	10	-
Harvey, Mrs. Nichs.	-	5	-
Hedglind, Rev. P., M.A.	-	5	-
Helm, Dr.	-	5	-
Holman, N. & Sons.	-	10	-
Hora, Mrs. A. H.	-	5	-
Howell, Mrs. D.	-	10	-
J. M. A.	-	10	6
Jago, the Misses	-	5	-
James, Major A. H., of Burnuhall	-	5	-
L. I. W., R. M.	-	10	-
Laity, Henry, Esq., Sennen	-	5	-
Laity, Hy., of Tregurnow	-	5	-
Lavin, Mr. Chas.	-	5	-
Lawrence, William W.	-	5	-
Lean, Thos., Marazion	-	5	-
Le Grice, Chas. D. N. Esq.	-	10	-
Lillingston, Mrs. E.	-	10	-
Macreight, A. F. H.	-	5	-
Marrack, Major P.	-	10	-
Martyn, Rev. R. J., St. Buryan	-	5	-
Mathews, E. T.	-	5	-
Michell, A. H. & Sons	-	5	-
Michell, Major A. O.	-	10	6
Millett, E. L., Bosavern, St. Just	-	5	-
Milton, J. P. Esq.	-	10	-
Montgomery, Dr. Hugh	-	5	-
Montgomery, Dr.	-	5	-
Mudge, Jas., Marazion	-	5	-
Oilard, I. F.	-	6	-
Pascoe and Son, Messrs.	-	5	-
Peacock, Miss	-	5	-
Percy, Mr. W. Herbert	-	5	-
Pernewan, Mrs., Queen's Hotel	-	10	-
Polseu, Mr. J.	-	5	-
Pool and Son	-	5	-
Reading, H. T. Esq.	-	5	-
Redruth Brewery Co.	-	5	-

	£.	s.	d.
Richards, E.	5	-	-
Rogers, the Misses	10	-	-
Ross, C. C. Esq.	10	6	-
Ross, Major J. J.	10	-	-
Saundry, J., Sennen.	5	-	-
Scobell, Mrs. Geo.	1	-	-
St. Levan, Lord	1	1	-
Silvester, Rev. P. D'O.	-	-	-
St. Levan	5	-	-
Sincock, Miss J.	5	-	-
Symons, John, Esq.	5	-	-
Symons, R. H. Esq.	5	-	-
Thomas, Major R.	5	-	-
Tonkin, Rev. John, St. Buryan.	10	-	-
Trelawny, Mrs. H. B.	5	-	-
Tremenheere, W. B.	5	-	-
Tremewen, Mr. N. T., St. Levan.	5	-	-
Trevithick & Mabpoit	5	-	-
Vignurs, Mrs.	10	-	-
White, Major Richd.	-	-	-
Trewellard, St. Just	5	-	-
Willan, Mrs., Regent Terrace.	5	-	-
Wingfield, Rev. W. W.	5	-	-
W.	5	-	-
Young, O.	5	-	-
Sums under 5s.	17	18	6
Total	£62	4	6

Donations.

Sums under 5s.	4	-	-
Pillar Boxes—	-	-	-
Gurnard's Head	6	18	11
Land's End	9	11	8
Logan Rock	8	-	7
Promenade	-	-	-
St. Michael's Mount	10	-	-
Other Boxes—	-	-	-
Cast'e Hotel	5	-	-
Customs	13	4	-
Dolphin Hotel	5	3	-
Union Hotel	6	2	-
Western Hotel	5	-	-
Mr. Woolas	10	-	-
Sums under 5s.	12	11	-
Not-specified credit	1	13	-
Total Dons.	29	15	10
Total Subs.	62	4	6
£92	-	4	-

POLKERRIS AND FOWEY BRANCH.

President—
JONATHAN RASHLEIGH, Esq.

Local Committee—
EVERETT W. RASHLEIGH, Esq., Chairman.
EDWARD ATKINSON, Esq.
ARTHUR COODE, Esq., Treasurer.
A. PERCY DAVIS, Esq.
MR. A. DINGLE.
FOWEY HARBOUR COMMISSIONERS.
W. J. GRAHAM, Esq.
LOFTUS LONG, Esq.
MR. A. NANKIVELL.
REV. H. N. PURCELL.
JONATHAN RASHLEIGH, Esq.
MR. C. L. TOYNE.
Messrs. TREFFRY, CLUNES & Co.

Honorary Secretary—
W. E. GRACH, Esq.

Honorary Collector—
MR. FREDK. A. ALLCHIN.

Annual Subscriptions.

	£.	s.	d.
Atkinson, Edw. Esq.	1	1	-
Broken-haw, G. B. M. Esq.	5	-	-
Carlyon, E. Esq.	1	1	-
Cocks, Mrs. C. Lygen, In Memoriam,	-	-	-
C. L. C.	1	1	-
Coode, Arthur, Esq.	1	1	-
Corbet, Mrs.	10	6	-
Davis, A. Percy, Esq.	5	-	-
Dingle, Mr. A.	5	-	-
Fortescue, J. B. Esq.	1	-	-
Fowey Harbour Commissioners	1	1	-
Graham, W. J. Esq.	5	-	-
Geach, W. Littleton, Esq.	5	-	-
Long, Loftus, Esq.	1	1	-
Martin, W. Esq.	1	1	-
Nankivell, A. Esq.	10	-	-
Purcell, Rev. H. N.	5	-	-
Rashleigh, E. W. Esq.	1	-	-
Rashleigh, Jonathan, Esq.	2	2	-
Robartes, Lord	1	1	-
Stephens, John, Mr.	10	6	-
Stopford - Sackville, Mrs.	2	2	-
Toyne, Mr. C. L.	5	-	-
Trefry, C. E. Esq.	1	1	-
Trefry, Clunes & Co.	10	6	-
Tregaskes, Mr. B.	5	-	-
Tregaskes, Mr. W. S.	5	-	-
Wreford, Mrs.	5	-	-
Sums under 5s.	2	6	-
Total Subs.	£20	7	-

Donations.

Contribution Boxes	3	4	9
Collected at Powey	-	-	-
Regatta	1	7	3
Total	£24	19	-

PORHLEVEN BRANCH.

Local Committee—
R. S. JAMES, Esq., Chairman.
T. BATH, Esq.
W. K. JENKINS, Esq.
J. HAYNES, Esq.
W. M. THOMAS, Esq.
W. BICKFORD-SMITH, Esq., M.P.
W. A. HOLLOWAY, Esq.
R. S. JAMES, Esq.
A. E. RATCLIFFE, Esq.
W. E. ROE, Esq.

Honorary Secretary—
Rev. H. W. CORRY.

Annual Subscriptions.

Baddeley, W. C. Esq.	1	1	-
Bassett, A. Esq.	1	1	-
Bath, T. Esq.	5	-	-
Bickford-Smith, W., Esq.	1	1	-
Boltho, Sons & Co.	1	1	-
Cade, Mr. R.	5	-	-
Cotton, Mr. H.	5	-	-
Dale, Mr. W.	5	-	-
Harvey, F. Esq.	2	2	-
Hill, F. V. Esq.	5	-	-
Hocking, Mr.	5	-	-
Lawrence, E. Esq., M.P.	2	2	-
Martyn, Mr. R.	5	-	-
Ratcliff, A. E. Esq.	5	-	-
Reed, Mr. J. G.	5	-	-
Robartes, Lord	5	5	-
Rogers, Capt. J. P., R.A.	1	1	-

	£.	s.	d.
Rowe, W. Ellis, Esq.	1	1	-
St. Aubyn, Rev. St. A. M.	1	1	-
St. Levan, Lord	1	1	-
Vyvyan, Rev. Sir	-	-	-
Vyell, Bt.	1	1	-
Williams, J. C. Esq.	3	-	-
Wise, Rev. R. F.	1	1	-
Sums under 5s.	3	2	6
Total	£28	6	6

PORHOUSTOCK BRANCH.

Local Committee—
EDWD. LEVERTON SPRY, Esq., Chairman.
MR. JOHN COAD.
REV. W. A. DIGGENS.
MR. HEARLE.
MR. WM. JAMES.
MR. J. LINDSAY.
MR. B. MORE.
MR. JAMES PENGILLY.
A. E. PILLING, Esq.
MR. G. W. ROSKRUGE.

Honorary Secretary—
MR. E. P. ROSKRUGE.

Annual Subscriptions.

Coad, Mr. Jno.	10	-	-
Dickinson, W. Esq.	1	1	-
Hearle, Mr.	5	-	-
James, Mr. Wm.	10	-	-
Lindsay, Mr. J.	5	-	-
More, Mr. B.	5	-	-
Pengilly, Mr. Jas.	5	-	-
Pilling, A. E. Esq.	1	1	-
Robartes, Lord	2	2	-
Roskruge, Mr. E. P.	5	-	-
Roskruge, Mr. G. W.	5	-	-
Smelt, Rev. M. A.	10	-	-
Spry, Edwd. Leverton, Esq.	10	-	-
St. Levan, Lord	1	-	-
Tremayne, Colonel	1	-	-
Vyvyan, Rev. Sir	-	-	-
Vyell	1	1	-
Williams, P. D., Esq.	1	-	-
Total Subs.	11	15	-

Donations.

Mrs. Saunders Clark	1	1	-
Contribution Boxes	4	1	-
Total	£13	-	1

PORT ISAAC BRANCH.

Local Committee—
W. R. GUY, Esq.
MR. THOS. JOHNSON.
MR. MARTIN, Chief Officer
H.M. Coastguard.

Honorary Secretary and Treasurer—
R. JULYAN GEORGE, Esq., M.D.

Annual Subscriptions.

Boltho, Williams, Foster & Co.	1	1	-
Cowie, M/s.	1	-	-
Dodsworth, Sir Matthew	5	-	-

	£.	s.	d.
Ebrington, Viscount	1	-	-
George, Dr. R. J.	10	-	-
Guy, W. R. Esq.	10	-	-
Johnson, Mr. Thos.	5	-	-
Magor, Mrs.	10	6	-
Old Delabole Slate Co. (for 1893-6)	2	2	-
Paterson, John, Esq.	10	-	-
Pearse, Mrs.	10	6	-
Robartes, Lord	1	-	-
Scott, Mrs.	5	-	-
Stephens, Darell, Esq.	1	1	-
Trevan, F. A. Esq.	1	1	-
Wharnccliffe, Earl	2	2	-
Williams, Captain Edwin	5	-	-
Total	£13	18	-

Donations.

Contribution Box	19	5	-
St. Minver Church	2	18	1
Total Dons.	3	17	6
Total Subs.	13	18	-
£17	15	6	-

ST. IVES (CORNWALL) BRANCH.

Local Committee—
The Mayor, ex officio.
MR. EDWARD HAIN, jun., J.P.
Capt. T. R. HARRY.
Capt. JOHN HODGE.
Rev. J. B. JONES, Vicar.
Dr. J. M. NICHOLS, J.P.
J. H. RICHARDS, Chief Officer
H.M. Coastguard.
Dr. G. T. A. STAFF, J.P.
Rev. R. F. TYACKE, Vicar of Lelant.

Treasurer and Honorary Secretary—
MR. W. T. TRESIDDER.

Annual Subscriptions.

Bennett, Mrs. E. G.	5	-	-
Boase, Mr. Edward	5	-	-
Bolthos & Co. Messrs.	1	1	-
Brown, Mr. J. K.	5	-	-
Carr, S. H.	5	-	-
Chellev, Capt. J.	5	-	-
Chellev, Mr. T. J.	5	-	-
Cowley, Earl	2	2	-
Daniel, Mr. Joshua, J.P.	5	-	-
Dow, Thos. Millie	10	-	-
Dillon, Harrowing & Co., Messrs.	1	1	-
Hain, Capt. Edward	5	-	-
Hain, Edw., & Son, Messrs.	3	3	-
Harry, Capt. T. R.	10	6	-
Hughes, Miss	5	-	-
Jones, Rev. Canon	10	6	-
Lang, Mr. T. A.	5	-	-
Martyn, Mr. W. T.	5	-	-
Nicholls, Dr., J.P.	5	-	-
Paynter, Capt. W. J., J.P.	5	-	-
Permewan, Mr. R. H.	5	-	-
Read, Mr. R. S. J.P.	5	-	-
Robartes, Lord	1	1	-
Rosewall, Mr. G. B., J.P.	5	-	-
Staff, Dr. J.P.	5	-	-
Stevens, Capt. Jas.	5	-	-
Stevens, Mr. E. F.	5	-	-
St. Ives Harbour Authority	5	5	-
St. Levan, Lord	1	1	-
Tresidder, Mr. W. T.	1	1	-
Trehella, Mr. W., J.P.	10	-	-

Trehwella, Miss.	£.	s.	d.
Tyacke, Rev. R. F. . . .	-	10	-
Warren, Wm.	-	5	-
Yorke, Miss.	-	5	-
Sums under 5s.	6	2	6
Total.	£29	18	6

Donations.

Crew of Life-boat . . .	2	12	-
Ditto, re "Alexander Yeals" . . .	1	6	-
Ditto, re "Dashedwood"	1	6	-
Proceeds of Entertainment at Porthminster Hotel.	1	1	-
Proceeds of Entertainment at Public Hall	1	-	-
Contribution Box at Tregenna Castle Hotel	1	-	8
Total Dons.	8	5	8
Total Subs.	29	18	6

SCILLY ISLANDS BRANCH.

President—
T. A. DORRIEN-SMITH, Esq.

Local Committee—
W. GLUYAS, Esq.,
Chairman.
H. G. ALLEN.
Rev. W. E. GRAVES.
D. W. EVANS.
T. THORNTON MACKLIN, M.B.
E. N. V. MOYLE.
W. ROGERS.

Honorary Secretary—
Mr. E. J. BLUETT.

Annual Subscriptions.

Bluett, E. J.	-	5	-
Dorrien-Smith, T. A., Esq.	1	1	-
Evans, D. W.	-	5	-
Gluyas, W.	-	5	-
Graves, Rev. W. E. . . .	-	5	-
Legg, Wm.	-	5	-
Macklin, T. Thornton, M.B.	-	5	-
Jackson, F. W.	-	5	-
Sums under 5s.	-	2	6
Total Subs.	£2	18	6

Donations.

Contribution Boxes . . .	1	-	8
Total.	£3	19	2

Cumberland.

CARLISLE AND SILLOTH BRANCH.

President—
The MAYOR OF CARLISLE (JOHN CORBETT, Esq., J.P.)

Treasurers—
Messrs. CARR & CO., Carlisle.

Local Committee—
Mr. W. CRABB, Chairman.
Mr. J. GRAHAM.
Mr. A. IRVING.
Mr. D. MCCALLUM.
Mr. G. MUNDELL.
Mr. A. PARKER.
Mr. J. STRONACH.

Honorary Secretary—
Mr. WILLIAM IRVING.

Annual Subscriptions

Banks, E. H., Esq., J.P. (1896-97)	2	2	-
Barnes, J. Esq. (1896-97)	1	-	-
Fell, Rev. J. A.	1	1	-
Graham, John, Esq.	-	10	-
Sutton, A., Esq.	-	10	-
Teadale, J., Esq.	1	1	-
Todd, Rev. H. M. (two years)	1	1	-
Wheatley, J. A., Esq.	-	10	6
Total Subs.	7	15	6

Donations.

Contribution Boxes.	4	3	2
Total	£11	18	8

MARYPORT BRANCH.

President—
H. P. SENHOUSE, Esq., J.P.

Vice-President—
Col. WOOD.

Local Committee—
HENRY CARR, Esq.
WILFRID HINE, Esq., J.P.
JOHN HEWETSON, Esq.
E. W. LIGHTFOOT, Esq.
JOHN MAUGHAN, Esq.
Capt. NELSON.
E. P. TYSON, Esq., J.P.
JOHN WILLIAMSON, Esq., J.P.

Hon. Secretary & Treasurer—
QUINTIN MOORE, Esq.

Annual Subscriptions.

Addison, John, Esq.	-	5	-
Bookless, Miss.	1	1	-
Brynton Domain Colliery	1	1	-
Carr, Hugh, Esq., J.P.	-	5	-
Carr and Co., Messrs.	1	1	-
Cartmell, Jos.	-	5	-
Flimby & B. Moor Colliery	1	1	-
Gibb, A.	-	5	-
Gibson, Miss.	1	1	-
Hine Bros., Messrs.	1	1	-
Johnston, Miss.	-	5	-
Lightfoot, E. W.	-	5	-
Little, Dr.	-	10	-
Maryport & Carlisle Railway Company	2	2	-
Maryport Brewery, Ltd.	-	10	-

President—
W. W. Esq.

Treasurers—
Messrs. CARR & CO., Carlisle.

Local Committee—
Mr. W. CRABB, Chairman.
Mr. J. GRAHAM.
Mr. A. IRVING.
Mr. D. MCCALLUM.
Mr. G. MUNDELL.
Mr. A. PARKER.
Mr. J. STRONACH.

Honorary Secretary—
Mr. WILLIAM IRVING.

Annual Subscriptions

Banks, E. H., Esq., J.P. (1896-97)	2	2	-
Barnes, J. Esq. (1896-97)	1	-	-
Fell, Rev. J. A.	1	1	-
Graham, John, Esq.	-	10	-
Sutton, A., Esq.	-	10	-
Teadale, J., Esq.	1	1	-
Todd, Rev. H. M. (two years)	1	1	-
Wheatley, J. A., Esq.	-	10	6
Total Subs.	7	15	6

MILLOM BRANCH.

President—
W. I. BARRATT, Esq., J.P.

Local Committee—
Rev. J. IRVING, M.A., J.P.
Major C. J. MYERS, J.P.
W. POSTLETHWAITE, Esq. (Silcroft).
P. B. STONEY, Esq.
CEDRIC VAUGHAN, Esq., J.P.

Treasurer—
W. T. LAWRENCE, Esq.

Hon. Secretary—
Miss F. STONEY.

Bankers—
Cumberland Union Bank, Millom.

Annual Subscriptions.

A Friend	1	1	-
Barratt, Mrs. James	-	5	-
Beever, Miss M. H.	-	5	-
Bryce, Mrs.	-	5	-
Cross, Viscountess.	-	5	-
Heelis, Mrs.	-	5	-
Hodbarrow Mining Company	3	3	-
Kewley, Rev. W.	-	5	-
Lawrence, T. W. Esq.	-	5	-
Lewthwaite, W. Esq.	1	1	-
Myers, C. J., Esq.	1	1	-
Plant, Dr. Charles	-	5	-
Postlethwaite, Mrs.	-	5	-
Stoney, P. Butler, Esq.	-	5	-
Vaughan, Cedric, Esq.	-	10	6
Sums under 5s.	-	15	6
Total	£10	17	-

Donations.

Collection on Life-boat Saturday	13	15	-
A Friend	-	10	-
Cycle Parade	2	4	6
Total Dons.	16	9	6
Total Subs.	10	17	-
Total.	£27	6	6

SEASCALE BRANCH.

Treasurer—
Mr. WALKER WHITTLE.

Hon. Secretary—
Mr. JOHN WRIGLEY.

Annual Subscriptions.

Barratt, the Misses, Carleton Hall.	1	-	-
Brocklebank, Sir T.	1	-	-
Colebank, Capt. I.	1	1	-
Wordsworth, Rev. J.	-	10	6
Wrigley, Mr. John.	-	5	-
Total Subs.	3	16	6

Donations.

Contribution Boxes, &c.	-	1	8
Total	£3	18	2

WHITEHAVEN BRANCH.

President—
The Right Hon. THE EARL OF LONSDALE.

Local Committee—
Capt. MANN, 3 Hilton Terrace, Chairman.
JAS. BRODIE.
J. COSGROVE.
J. G. DEES.
J. I. FISHER.
A. HELDER, Esq., M.P.
GEO. HODGSON.
Dr. I'ANSON.
Capt. JACQUES.

Honorary Secretary—
Mr. J. G. OLDFIELD.

Annual Subscriptions.

Ainsworth, D. Esq.,	-	10	6
Armstrong, Mr. J. W.	-	5	-
Broadbent, Mr.	-	5	-
Brodie, Mr. J. S.	-	5	-
Brown, Mr. T.	-	10	-
Burnyeat, Dalzell & Co., Messrs.	-	15	-
Collis, Mr. Isaac.	-	10	-
Dees, Mr. J. G.	-	10	-
Dixon, Mr. T. C.	-	10	-
Fisher, Dr.	-	10	6
Fisher, Mr. J. L.	-	5	-
Graham, Mr. R.	-	5	-
Helder, A. Esq., M.P.	1	1	-
Hodgson, Mr. Geo.	-	10	-
Howson, Mr. Thos.	-	10	-
I'Anson, Dr.	-	10	-
Jackson, Dr.	-	5	-
Jackson, Messrs. J. and W.	-	10	6
Jacques, Capt.	-	10	6
Jefferson, Messrs. R. and H.	1	1	-
Jenkins, Mr.	-	10	-
Leconfield, Lord.	1	1	-
Lindow, S. and J., Messrs.	-	2	2
Lonsdale, Lord	-	5	5
Mason, Mr.	-	5	-
McKevie, Mr.	-	5	-
Metcalf, Mr. T. K.	-	5	-
Moore & Co., Messrs.	-	10	-
Mossop, Mr. J. B.	-	5	-
Muriel, Dr.	-	5	-
Murphy, Father	-	5	-
Nicholson & Franks	-	10	-
Oldfield, Mr. J. G.	-	5	-
Pattinsons & Winter	-	10	-
Pearson & Son	-	5	-

	£.	s.	d.
Robinson, Mr. J. H.	10	-	-
Robinson, Mrs.	5	-	-
Rothery, Mr. Jno.	5	-	-
Simpson, Mr. R.	5	-	-
Steward, Mr. J. B.	5	-	-
Stirling, Mr. John	2	2	-
Walker, Mr. W.	10	-	-
Were, Mr. A. B.	5	-	-
Whitehaven Colliery Company	2	2	-
Wilson and Kitchen	10	-	-
Sums under 6s.	4	8	-
Total Subs.	£33	14	-

Donations.

Contribution Boxes.	1	7	1
Trustees of the late Miss Lowther's estate	14	2	-
Total	£49	3	1

WORKINGTON BRANCH.

President—
The Right Hon. The EARL OF LONSDALE.

Local Committee—
Hr. BOWES, Esq., J.P., Chairman.
J. G. DEES, Esq.
Jos. EDEN, Esq.
W. L. FLETCHER, Esq.
J. HIGHT, Esq.
R. H. HODGSON, Esq., J.P.
G. B. McMULLEN, Esq.
CECIL THOMPSON, Esq.
E. A. THOMPSON, Esq., J.P.
JAS. THOMPSON, Esq.
R. WILLIAMSON, Esq.
E. H. WILLIAMSON, Esq.

Honorary Treasurer—
JONATHAN SCOTT, Esq.

Honorary Secretary—
J. C. THOMPSON, Esq.

Collectors—
Mr. F. W. SIMMONDS.
H. S. WILSON, Keswick.

Annual Subscriptions.

Friend, A.	5	-	-
Bee-hive Co-operative Society	3	3	-
Bouch, the Misses	2	-	-
Burchell, Miss	1	-	-
Crothwaite, J.	-	-	-
Fisher	5	-	-
Curwen, H. F. Esq.	1	-	-
Dees, J. G., Esq.	5	-	-
Duffield, Jas. Esq.	2	-	-
Dunn, J. M.	5	-	-
Fletcher, W. L.	10	-	-
Hartley, T.	1	1	-
Iredale Brothers	1	-	-
Jackson, Thomas	10	-	-
Jaques, Miss	10	-	-
Lonsdale, Lord	5	-	-
Martindale, Mrs.	10	-	-
Richardson, Joseph	5	-	-
Thompson, Miss A.	10	-	-
Valentine, C. J.	1	-	-
Williamson, Messrs.	2	2	-
Sums under 6s.	3	-	-
Total	£23	4	-

Donations.

	£.	s.	d.
Contribution Boxes	1	5	-
Life-boat Saturday	22	-	-
Total Dons.	23	5	-
Total Subs.	23	4	-
	£46	9	-

Denbighshire.

LLANDDULAS BRANCH.

President—
The Right Hon. the EARL OF DUNDONALD.

Local Committee—
J. P. FAICHNEY, Esq.
P. JONES, Esq.

Honorary Secretary—
JOHN DAVIES, Esq.

Annual Subscriptions.

	£.	s.	d.
Beckett, Miss	10	-	-
Davy, W. J. Esq.	10	6	-
The Right Hon. the Earl and Countess of Dundonald	5	-	-
Hill, Major	10	6	-
Jones, A. L. Esq.	10	6	-
Jones-Bateman, Rev. B.	1	1	-
Kneeshaw Lupton, and Co., Messrs.	5	-	-
Llanddulas Quarry Company	5	-	-
Pipon, Rev. J. C. C.	1	1	-
Raynes & Co. Messrs.	5	-	-
Thurlow, Lieut.-Col.	1	1	-
Turner, Mrs. Horace	1	-	-
Walker, A. O. Esq.	1	1	-
Total Subs.	£27	5	6

Donations.

Contribution Boxes	10	4	-
	£27	15	10

Derbysire.

BELPER BRANCH.

(No Local Committee.)

Chairman—
H. LOMAS, Esq.

Treasurer—
W. WINTERBOURNE, Esq.

Honorary Secretary—
W. P. ADSHEAD, Esq.

Annual Subscriptions.

	£.	s.	d.
Allen, Dr.	5	-	-
Adshead, Mr.	1	1	-
Adshead, Miss	10	6	-
Bakewell, Mr.	5	-	-
Bourne, Mrs.	1	1	-
Burklnshaw, Mr.	5	-	-
Calvert, Mr.	5	-	-
Cartwright, Mr.	5	-	-
Fletcher, Mr. J. B.	5	-	-
Friend, Rev. F. A.	5	-	-
Green, Mr.	5	-	-
Hanson, Mr.	10	6	-
Hawkins, Mr. S.	5	-	-
Hibbert, Mr. T.	5	-	-
Holmes, Mr.	5	-	-
Hunter, Mr. J.	1	1	-
Hunter, Mr. M.	5	-	-
Jackson, Mr. F.	10	6	-
Jacoby, Mr., M.P.	1	1	-
Johnston, Mr.	5	-	-
Loverock, Mr.	10	6	-
Loving, Mr.	5	-	-
Manlove, Mr.	1	1	-
McAuslan, Mrs.	5	-	-
Pym, Mr. Jas.	5	-	-
Pym, Mr. Josh.	5	-	-
Smedley, Mr. E.	10	6	-
Smedley, Mr. J., J.P.	10	6	-
Southern, Mr.	5	-	-
Stillman, Mr.	5	-	-
Strutt, Mr. H., J.P.	1	1	-
Wheeldon Brothers, Messrs.	5	-	-
White, Mr.	5	-	-
Sums under 5s.	3	14	-
Total Subs.	£18	8	-

CHESTERFIELD BRANCH.

Local Committee—
ALFRED BARNES, Esq., D.L., Chairman.
The Hon. and Rev. R. E. ADDERLEY.
Rev. N. L. ASPINALL, M.A., Holy Trinity Rectory.
GEORGE BOOTH, Esq., J.P.
J. M. CLAYTON, Esq., J.P.
B. DOUGLAS, Esq.
EDWARD EASTWOOD, Esq., J.P., Alderman D. C. C.
T. GRIFFIN, Esq.
Hon. Canon C. J. LITTLETON, Vicar of Chesterfield.
W. B. ROBINSON, Esq., C.C.
Rev. GEORGE WINDRAM.

Honorary Treasurer—
JOHN NAYLOR, Esq., J.P.

Honorary Secretaries—
JAMES ARMISTEAD, Esq.
W. S. SYMES, Esq.

Collector—
JAMES WRIGHT, Accountant, Market Hall Chambers.

Bankers—
CROMPTON AND EVANS' UNION BANK, Chesterfield.

Annual Subscription.

Eastwood, Edward, Esq., J.P.	5	5	-
Total	£5	5	-

DERBY BRANCH.

(No Local Committee.)

Honorary Secretary—
T. H. HARRISON, Esq., J.P.

Annual Subscriptions.

	£.	s.	d.
Bothamley, W. W. Esq.	5	-	-
Bottomley, Geo. & Co. Woollen merchts.	10	6	-
Derby	10	6	-
Brindley, J. E. Esq.	5	-	-
Cox, S. R. Esq.	1	1	-
Curzon, N. C. Esq.	1	1	-
Evans, Henry, Esq.	1	1	-
Evans, Walter, Esq.	2	2	-
Harrison, T. H. Esq.	1	1	-
Holden, Rev. J. S.	1	1	-
Moody, Miss	5	-	-
Newbold, J. W. Esq.	10	6	-
Newton, C. E. Esq.	1	1	-
Robotham, W. B. Esq.	1	1	-
Schwind, C. Esq.	1	1	-
Smith, Sir John	1	1	-
Swingler, Alfred, Esq.	1	1	-
Total Subs.	£14	8	-

Debnshire.

BARNSTAPLE AND BRAUNTON BRANCH.

Vice-Patron—
The Right Hon. The EARL FORTESCUE.

Local Committee—
W. P. HIERN, Esq., Chairman.
C. H. BASSETT, Esq.
J. BREWER, Esq.
EDWARD DENNIS, Esq.
T. J. DENNIS, Esq.
J. W. FIELD, Esq.
H. C. GUPPY, Esq.
Rev. Dr. NEWTON.

Honorary Secretary—
CLAUDE GOULD, Esq.

Annual Subscriptions.

A Friend	5	-	-
Alford, Mrs. Wm.	5	-	-
Arthur, Rev. T.	5	-	-
Ashton, R.	5	-	-
Berry, Mr. S.	5	-	-
Basset, Mr. C. H.	10	-	-
Bird, Mr. J. S.	10	6	-
Bosson, Mr. J.	5	-	-
Brady, Mr. Jas.	10	6	-
Brewer, Mr. J.	1	1	-
Brown, Mr. W. E.	5	-	-
Chapple, Mr. A. L.	5	-	-
Christie, Mr. A. L.	5	-	-
Crang, Miss	5	-	-
Croft, Mr.	5	-	-
Davie, Miss	1	10	-
Dennis, Mr. T. J.	10	-	-
Dennis, Mr. Edwd.	10	-	-
Downing, Mrs.	5	-	-
Edger, Mr. Edward	10	-	-
Edwards, Dr. H. J.	5	-	-
Farleigh & Sons, Messrs.	5	-	-
Fletcher, The Misses	3	-	-
Fortescue, Rt. Hon. Earl	3	3	-

ANNUAL SUBSCRIPTIONS AND DONATIONS TO BRANCHES.

797

	£.	s.	d.
Fox, Fowler & Co. Messrs.....	10	-	-
Gotto, Rev. E. R.....	5	-	-
Gould, C. W. S.....	5	-	-
Gould, Mr. W.....	10	6	-
Gregory, Mrs. M. A.....	5	-	-
Gribble, Miss.....	10	-	-
Guppy, Mr. H. C.....	5	-	-
Hambling, Mr. J. G.....	10	-	-
Harper, Mr. Jos.....	10	-	-
Hiern, Mr. W. P.....	10	-	-
Hunt, Messrs.....	5	-	-
Laurence, W.....	10	6	-
Nat. Prov. Bank of England, Limited.....	10	-	-
Rafarel, Mr. W. C.....	10	6	-
Rawle, Gammon & Co. Messrs.....	5	-	-
Roberts, Mr. W. A.....	5	-	-
Robinson, Mrs.....	5	-	-
Seldon & Son, Messrs.....	5	-	-
Seldon, Mr. A.....	5	-	-
Snow, Mr. J.....	5	-	-
Tamlyn, Mr. J. Q.....	10	6	-
Tatham, Mrs.....	1	1	-
Thomson, Capt.....	10	-	-
Toller, Mr. W. H.....	10	-	-
Wills, Miss.....	5	-	-
Sums under 5s.....	12	6	-
Total.....	£26	-	6

BIDEFORD AND APPLEDORE BRANCH.

Local Committee—
 Sir W. CAMERON GULL,
 Bart., M.P., President.
 J. E. BURNARD, Esq.
 J. W. FIELD, Esq.
 CLAUD S. GOULD, Esq.
 Rev. A. GURNEY-GOLD-
 SMITH.
 G. E. PRIDEAUX-BRUNE,
 Esq.
 S. HEARD, Esq.
 J. M. KIRKWOOD, Esq.
 Major MALLETT
 Rev. E. CALDON PIGOTT.
 Rev. R. W. SEALY.
 Rev. H. W. J. SMART.
 E. J. TATTERSILL, Esq.
 Rev. J. WHITE.
 CHIEF OFFICER OF H.M.
 COASTGUARD.

Honorary Secretary—
 F. A. SEARLE, Esq.

Annual Subscriptions.

APPLEDORE.

Cock & Son, Messrs.....	7	6	-
Land, Mr. J. W.....	5	-	-
Pickard, Mr. William.....	5	-	-
Sums under 5s.....	7	6	-
Total.....	£1	5	-

BIDEFORD.

Anson, Mrs.....	5	-	-
Ascott, Mr. H.....	5	-	-
Bazeley, Mr. H. M.....	10	-	-
Boyle, Mr. G.....	5	-	-
Cock and Lamerton, Messrs.....	10	-	-
Cooper, Mr. and Mrs. G.....	1	-	-
Dawe, Mr. Henry.....	5	-	-
Dayman, Miss.....	1	-	-
Djdam, Mrs.....	5	-	-

	£.	s.	d.
Dowell, Admiral Sir William, G.C.B.....	10	-	-
Fox, Fowler & Co.....	5	-	-
Giddie, Mr. W.....	5	-	-
Graves, Mrs.....	1	1	-
Gull, Sir Cameron W.....	2	2	-
Han-on, Mrs.....	5	-	-
Heard, Mr. G.....	10	-	-
How & Co., Messrs.....	10	-	-
Hutchinson, Col.....	1	-	-
Kirkwood, Major.....	10	-	-
Lockley, Mr. J. H.....	1	1	-
Lockley, Mrs.....	1	1	-
Narraway, Mr. J.....	5	-	-
Pine-Coffin, Mrs.....	1	1	-
Portsmouth, Coun- tees, The Downer Prideaux-Bruno, Mr. G. E.....	1	1	-
Pridham & Son, Messrs. W.....	10	6	-
Reynolds, Miss.....	5	-	-
Rogers, Mr. T.....	10	-	-
Searle, Mr. F. A.....	5	-	-
Slater, Rev.....	10	-	-
Smith, Colonel.....	5	-	-
Somes, Mrs.....	1	1	-
Stucly, Sir Geo. S.....	1	1	-
Tardrew, Mr. H. P.....	5	-	-
Tattersill, Mr. E. J.....	10	-	-
Thompson, Dr. C. S.....	5	-	-
Thompson, Mrs.....	5	-	-
Trapnel and Mere- field, Messrs.....	7	6	-
Treffry, Mr. J. T.....	10	-	-
Turner, Mr. George.....	5	-	-
Vidal, Mrs. E. U.....	10	-	-
Vincent & Duncan, Messrs.....	10	6	-
Willett, Rev. W. S.....	5	-	-
Sums under 5s.....	4	12	-
Total.....	£23	9	6

NORTHAM AND WESTWARD HO!

Rathe, Mrs.....	5	-	-
Rowles, Mrs.....	10	-	-
Boyd, Mr. A. H.....	10	-	-
Carver, Major.....	1	1	-
Chambers, Mrs.....	5	-	-
Cooke, Mr. Francis F.....	1	-	-
Dalton, Col. Wade.....	5	-	-
Drew, Miss.....	10	-	-
Field, Mr. J.....	10	-	-
Fraser, Miss.....	5	-	-
Fuller, Miss.....	5	-	-
Fuller, Surg.-Gen.....	5	-	-
Gardiner, Mrs.....	10	-	-
Gordon, Capt.....	10	-	-
Gosset, Mrs.....	10	-	-
Hake, Mr. G.....	5	-	-
Hunt, Miss.....	5	-	-
Kelsey, Mr. E. F.....	5	-	-
Lang, Mr.....	5	-	-
McLaren, Mr. J. C.....	1	-	-
Monroe, Col.....	1	-	-
Faynter, Miss.....	5	-	-
Peard, Mr. G. O.....	5	-	-
Roberts, Mrs. (per J. W. F.).....	2	2	-
Sawer, Mrs.....	10	-	-
Scott, Colonel Stanley.....	1	1	-
Sibthorpe, Gen.....	10	-	-
Siddall, Dr. J. B.....	10	-	-
Smart, Miss.....	5	-	-
Stapledon, Mr. W.....	1	1	-
Templeman, Colonel.....	10	-	-
Temple, Col.....	2	2	-
Thrupp, Mrs.....	10	6	-
Townley, Col.....	5	-	-
Waddington, Mr. G.....	5	-	-
Winterscale, Col.....	5	-	-
Wren, The Misses.....	10	-	-
Wren, Mrs. R. F.....	5	-	-
Sums under 5s.....	19	6	-
Total.....	£22	2	-

TORRINGTON.

	£.	s.	d.
Adams, Mr. John.....	5	-	-
Dew, Mss.....	5	-	-
Glubb, Mr. W.....	5	-	-
Lake, Miss.....	5	-	-
Mack, Mr. T.....	5	-	-
Mallet, Major.....	10	-	-
Scott, Capt.....	5	-	-
Stevens, Mr. J. C. M. I.....	1	-	-
Stevens, Major R. A. Moore.....	5	-	-
Sutchiffe, Dr.....	5	-	-
Yonge, Colonel.....	1	1	-
Sums under 5s.....	6	11	6
Total.....	£11	2	6

INSTROW.

Dorsett, Mr. George.....	1	1	-
Dorsett, Mrs.....	1	1	-
Fraser, Mrs.....	5	-	-
Hinchcliff, Mrs.....	5	-	-
Loveband, Mrs.....	5	-	-
Molloy, Colonel.....	10	-	-
Paton, Mr. J.....	5	-	-
Pigott, Rev. E. C.....	5	-	-
Finkett, Capt.....	5	-	-
Robertson, Mr. G.....	5	-	-
Winter, Major.....	5	-	-
Sums under 5s.....	7	6	-
Total.....	£4	19	6

BARNSTAPLE.

Codd, Mr.....	5	-	-
Total Subs.....	£63	3	6

Donations.

Contribution Boxes—
 Couldridge, Mr. J. W..... - 13 6
 No. 1 Station..... 1 7 1
 No. 2 Station..... 1 1 9
 Royal H., Bideford..... 5 -
 Royal H., West-
 ward Ho!..... 5 6
Total Dons..... 3 12 10
Total Subs..... 63 3 6
£71 16 4

BRIXHAM BRANCH.

Local Committee—
 The Rt. Hon. LORD CHEBSTON,
 Chairman.
 GEO. T. BARRY.
 D. DEWDNEY.
 JOHN HARRIS.
 THOS. LAKEMAN.
 WM. LOVELL.
 J. SMITH.
 Rev. STEWART SIM.
 W. G. TULLY.
 Dr. A. E. HAYWARD.
 J. W. WHEATON, Harbour-
 master.
 Mr. PADDON, Chief Officer
 of Coastguards.

**Honorary Secretary
 and Treasurer—**
 ALFRED KENDRICK, Esq.

Annual Subscriptions.

Alexander, K. A. A.....	5	-	-
Arbarthscott, D.....	10	-	-
Atkinson, S.....	5	-	-
Bartlett, O. S.....	5	-	-
Broomhead, Miss.....	5	-	-

£. s. d.

Broughton, O.....	10	-	-
Caine, Mrs.....	5	-	-
Churston, Lond.....	1	-	-
Elliot, C. T. R.....	5	-	-
Gray, Mrs. A. C.....	5	-	-
Hall, Mrs.....	5	-	-
Hogg, Miss.....	10	-	-
Kendrick, A.....	10	-	-
Kennedy, Mrs.....	5	-	-
Lakeman, T.....	5	-	-
Lakeman, T., jun.....	5	-	-
Lyde, Mrs.....	5	-	-
MacGeorge, G. W.....	5	-	-
Moalle, J. H.....	5	-	-
Moalle, N.....	10	-	-
Newton, Isaac.....	5	-	-
Shiel, M.....	5	-	-
Singer, W. M. G.....	2	-	-
Sloggett, Mr. W. H.....	5	-	-
Spens, A. L.....	5	-	-
Stewart Sim, Rev.....	5	-	-
Syngs, Lady C.....	5	-	-
Syngs, Lady R.....	5	-	-
Turner, Major H.....	10	-	-
Twynnam, Colonel.....	10	-	-
Upham, J. W. & A.....	5	-	-
Sums under 5s.....	11	-	-
Total Subs.....	23	-	-

Donations.

Contribution Boxes. - 3 -
Total..... £23 3 -

GLOVELLY BRANCH.

Local Committee—
 F. HAMLYN, Esq., J.P.,
 Chairman.
 Capt. W. J. WELL.
 Capt. R. MILL.
 Capt. W. MOSE.

Treasurer—

Honorary Secretary—
 Mr. DANIEL PEARCE.

Annual Subscriptions.

	£.	s.	d.
Bakewell, Miss.....	10	-	-
Bakewell, Miss E.....	10	-	-
Berriman, Mr.....	5	-	-
Elwes, R. Esq.....	1	1	-
Feehey, Mr.....	1	-	-
Hamlyn, Mr. and Mrs. F.....	2	2	-
Harrison, Rev. Wm. (the late) and Mrs. 1 - -	1	-	-
Stucely, Col.....	1	-	-
Tucker, I. Pitts, Esq.....	10	-	-
Vine, Mrs.....	5	-	-
Total Subs.....	£28	3	-

Donations.

Contribution Boxes. 13 14 4
£21 17 4

DARTMOUTH BRANCH.

Local Committee—
 Capt. ORME WEBB, R.N.,
 Chairman.
 Capt. S. E. HUCKPITT.
 Mr. JOS. NEWMAN, C.O.
 Coastguard.
 E. TEW, Esq., J.P.
 Capt. J. R. TOLMAN, J.P.
 Capt. W. H. ANGEL.
Honorary Secretary—
 T. J. MITCHELL, Esq.

Annual Subscriptions.

	£.	s.	d.
Angle, Capt. W. H.	5	-	-
Bartlett, J. Esq.	10	-	-
Buckpitt, Capt.	5	-	-
Channel Coaling Co.	10	-	-
Collins, G. H., & Co., Messrs.	10	-	-
Darval, Esq.	1	10	-
Evans, J. Esq.	5	-	-
Orme-Webb, Captain, R.N.	1	1	-
Philip, A.	5	-	-
Renwick & Wilton, Messrs.	10	-	-
Tew, E. Esq.	10	-	-
Teage, The Misses	5	-	-
Tolman, J. J.	5	-	-
Tolman, J. R.	5	-	-
Whitmore, Lieut. R.N.	1	-	-
Total Subs.	£7	16	-

Donations.

Angel, Capt. W. H.	1	-	-
Brown, Capt. W. B.	17	3	-
Coleman, Capt. J.	2	6	-
Collins, G. H.	7	6	-
Life-boat Sunday	16	8	-
Contribution Boxes:—			
H.M.S. "Britannia"	5	8	-
Life-boat House	5	9	-
Messrs. Casey Bros.	5	4	-
Boxes under 5s.	14	9	-
Total Dons.	£19	19	5
Total Subs.	£7	16	-
	£27	15	5

DAWLISH BRANCH.

Local Committee—
 Sir THOMAS LRA, Bart. M.P.,
 Chairman.

Honorary Treasurer—
 ALEX. McCASLAND, Esq.

Honorary Secretary—
 T. CLAYTON DRAKE, Esq.

Bankers—
 CAPITAL & COUNTIES BANK.

Collector—
 Mr. JAMES HOLMAN, R.N.

Annual Subscriptions.

Alford, Rev. W. P.	5	-	-
Bagshaw, Mrs. F.	10	6	-
Bayldon, Mr. E. H., J.P.	10	6	-
Benthall, Miss	10	6	-
Browning, Mr. Colin	5	-	-
Craigie, the Misses	1	1	-
D'Alcorn, Mr.	10	6	-
Douglas, Lady	1	1	-
Doxat, Capt. R.N., J.P.	5	-	-
Durham, Mr. T. C.	10	-	-
Drake, Rev. Canon	10	6	-
Ermen, Mr. G.	1	-	-
Ferris, Mr. R. B.	10	-	-
Fortescue, the Misses	5	-	-
Garland, Mrs. Bland	10	-	-
Hall, Miss	5	-	-
Helyar, Mrs.	10	-	-
Hodgkinson, Mr. H.G.	5	-	-
Jackson, Mrs.	1	-	-
Lea, Sir Thos., Bart., M.P.	3	3	-
Marshall, the Misses	5	-	-
Maye, Mr. T.	1	1	-
McCasland, Mr. A.	1	1	-
Nosworthy, Mrs.	10	6	-

Annual Subscriptions.

Ogborne, Mr. E. H.	5	-	-
Pardoe, Mr. C. A.	5	-	-
Parker, Mrs. Town-ley	1	-	-
Pierce, Miss F.	5	-	-
Pike, Mrs. W. J.	10	6	-
Pike, Mr. J. B.	5	-	-
Pinder, Mrs. H. S.	1	1	-
Raggett, Mr. G. B.	10	-	-
Riall, Major	5	-	-
Salmon, Mr. E. A.	5	-	-
Turner, Mrs. C. H.	5	-	-
Washington, Mr. J. W. C., J.P.	10	-	-
Waterfield, Mr. W.	10	-	-
Welch, Mr. T.	10	-	-
Whidborne, Mr. J.S.	10	6	-
Wiley, Mr. T. W.	5	-	-
Winstanley, Mrs.	1	-	-
Wyles, Mr. M.	5	-	-
Sums under 5s.	7	6	-
Total Subs.	£24	19	6

Donations.

Bayldon, Mr. E. H., J.P.	10	-	-
Falcon, Mr. F. A.	10	-	-
Helyar, Mrs.	10	-	-
Mirsky, Princess C.	10	-	-
Partridge, Mrs.	5	-	-
Wiley, Mr. F. W.	5	-	-
Sums under 5s.	5	6	-
Pillar and Collecting Boxes	3	5	-
Total.	£30	15	5

EXETER BRANCH.

President—
 The Right Hon. and Rev. the EARL OF DEVON.

Local Committee—
 Vice-Admiral WHITE, C.B. Chairman.
 Rev. Canon W. J. EDMONDS, B.D.
 Captain SWINTON, R.N.
 R. B. WEST, Esq.

Honorary Treasurer and Secretary—
 COURTENAY H. EDMONDS, Esq.

County Chambers.

Collector—
 Mr. JOHN VANSTONE, Haven Banks, Exeter.

Annual Subscriptions.

Acland, The Right Hon. Sir F. D., Bart.	1	1	-
Bond, The Misses	10	-	-
Brembridge, Miss M. W.	1	1	-
Buckingham, A. W. Esq.	5	-	-
Drake, Miss	5	-	-
Edmonds, Rev. Canon, B.D.	10	6	-
Edmonds, Courtenay H. Esq.	10	6	-
Franklin, G. Esq., J.P.	10	-	-
Gray, Miss J.	5	-	-
Green & Son, Messrs.	5	-	-
Harris, J. D. Esq.	5	-	-
Hickley, Admiral H. D.	1	-	-
Holmes, The Misses James, Rowe, & Co., Messrs.	10	6	-
Kingdon, Mrs. D.	1	-	-
Kingdon, G. C. Esq.	5	-	-
Lloyd, H. C. & Son, Messrs.	10	6	-

Annual Subscriptions.

Mathews, Miss	5	-	-
McGrath, Rev. H. W.	1	1	-
Milford, Miss, S. E.	10	-	-
Mortimore, W. Esq.	5	-	-
Norman and Pring, Messrs.	1	1	-
Northcote, The Hon. Sir Stafford, Bart., C.B., M.P.	1	1	-
Pinder and Tuckwell, Messrs.	5	-	-
Swinton, Captain, R.N.	5	-	-
Thomas, J. L. & Co. Messrs.	10	-	-
Tucker, Mrs. J. T.	5	-	-
Varwell, P. Esq.	5	-	-
West, R. B. Esq.	25	-	-
White, Vice-Admiral, R. D., C.B.	1	1	-
Wilcocks, Messrs.	10	6	-
Williams, F. J. Esq.	5	-	-
Wilson & Son, Messrs.	5	-	-
Wippell, H. H. Esq.	5	-	-
Sums under 5s.	5	-	-
Total	£12	3	6

Donations.

Contribution Boxes—
 Royal Clarence Hotel, Exeter, per J. H. Stanbury, Esq. 8 7
 Half Moon Hotel, Exeter, per J. H. Stanbury, Esq. 5 10
 Queen St., Exeter 6 -
 London Hotel, Exeter, per R. Pople, Esq. 11 6
 Boxes under 5s. 2 6

Total Dons. 1 14 5
Total Subs. 42 3 6
£43 17 11

Annual Subscriptions.

Bates, Mrs.	10	-	-
Bazalgette, Colonel	10	-	-
Beacon No. 17	5	-	-
Belfield, General	5	-	-
Belson, Mrs.	5	-	-
Benmore, G. P. Esq.	5	-	-
Bevans, Mrs.	10	-	-
Birch, Lt.-Col.	10	-	-
Bond, Rev. E. C.	5	-	-
Brent, The Misses	5	-	-
Brown, Mrs. Tod	5	-	-
Brown, W. S.	5	-	-
Browne, Rev. G.	1	19	6
Bryce, J. P. Esq.	1	-	-
Carr, Rev. C. R.	5	-	-
Carter, P. E.	5	-	-
Charnier, E.	5	-	-
Chanter Roylands, J. J.	5	-	-
Chetwynd, Rt. Hon. Viscountess	1	1	-
Christian, T. T.	3	3	-
Clark, H.	10	-	-
Clerk, H.	5	-	-
Cock, John	5	-	-
Coles, H. J.	5	-	-
Copleston, J. H. H.	5	-	-
Cowdry, N.	5	-	-
Cripps, Rev. J. M.	5	-	-
Cruise, W. H.	5	-	-
Darke, A. J. Esq.	5	-	-
Davies, W. Stanley	5	-	-
Dewes, Mrs.	5	-	-
Drake, Dr.	5	-	-
Drayton, P. J.	5	-	-
Drummond, H. W.	5	-	-
Eates, Mrs.	5	-	-
Echlin, P.	10	-	-
Edgar, Rev. & Mrs.	10	-	-
Field, A. K.	10	-	-
Forbes, Mrs.	1	1	-
Forbes, Mrs.	5	-	-
Forster, Lt.-Col.	1	1	-
Freeman, Richard	10	-	-
Gardiner, Misses	5	-	-
Gordon, J. Esq.	1	1	-
Granger, N.	10	-	-
Grenfell, Mrs.	5	-	-
Greaswell, Mrs.	10	-	-
Grieve, Com. M., R.N.	1	1	-
Grove, C. B.	1	1	-
Hamilton, A.K. Esq.	5	-	-
Hanly, Mrs. Calmady	5	-	-
Hargreaves, G.	5	-	-
Hayman	5	-	-
Hetzler, Miss	5	-	-
Hume-Long, Mrs.	1	1	-
Hunter, J.	10	-	-
Hunter, Mr.	10	-	-
Kavanagh, Mrs.	1	1	-
Kennedy, Sir C.	5	-	-
Kensington, Miss	5	-	-
Lair, G.	5	-	-
Lang, E.	5	-	-
Langley, John, Esq.	10	-	-
Langton, C. Esq.	5	-	-
Leach, Miss	10	6	-
Lethbridge, W. Esq.	1	1	-
Ley, R.	1	1	-
Lightfoot, Mr. & Mrs.	5	-	-
Lloyd, Col.	1	1	-
Maberly, G. F.	5	-	-
Macaulay, The Misses	5	-	-
MacKenzie, Mrs.	5	-	-
Metcalfe, Rev. W. H.	1	1	-
Moore, Col. J. L.	5	-	-
Moorman, Adml. R.	10	-	-
Ord, E.	10	-	-
Orwin, E.	5	-	-
Pein, Mr. and Mrs. Tucker	1	1	-
Pateman, H. C.	5	-	-
Pember, G. H.	5	-	-
Pepys, Capt. A.	10	-	-
Peters, Gen. H. B.	10	-	-
Phear, Sir John	1	1	-
Pigott, H. A.	5	-	-
Pinckney, Miss	10	-	-
Purcell, Rev. W. H. D.	5	-	-
Rocke, General	10	-	-
Rolle, Hon. Mark	1	5	-

Donations.

Contribution Boxes—
 Royal Clarence Hotel, Exeter, per J. H. Stanbury, Esq. 8 7
 Half Moon Hotel, Exeter, per J. H. Stanbury, Esq. 5 10
 Queen St., Exeter 6 -
 London Hotel, Exeter, per R. Pople, Esq. 11 6
 Boxes under 5s. 2 6

Total Dons. 1 14 5
Total Subs. 42 3 6
£43 17 11

EXMOUTH BRANCH.

Patron—
 Hon. MARKE ROLLE.

Local Committee—
 Admiral R. MOORMAN, Chairman.
 Colonel ADAMS.
 Rev. C. R. CABR. A. J. DARKE.
 MCKENZIE GRIEVE, Commander, R.N.
 JOHN LANGLEY.
 RICHARD LEY.
 Capt. W. D. MORRISH, R.N.
 Captain SQUIRE.
 K. TUCKER PAIN.
 Commander J. B. TRIGGS, R.N., Inspecting Commander H.M. Coast-guard.

Honorary Secretary—
 M. F. MORSBY, R.N., Paymaster-in-Chief.

Collectors—
 Mr. EDWARDS.
 Mr. T. HEYDON.

Annual Subscriptions.

Acton, Miss	5	-	-
Adams, Colonel	10	-	-
Aldwell, T. D.	5	-	-
Arthur, Capt. E. S.	5	-	-
Baker, H. G.	10	-	-
Baillie, Mrs.	5	-	-
Baldock, Mrs.	5	-	-
Bamfield, Gen.	5	-	-
Baruberger, L. Esq.	5	-	-

Annual Subscriptions.

Pateman, H. C.	5	-	-
Pember, G. H.	5	-	-
Pepys, Capt. A.	10	-	-
Peters, Gen. H. B.	10	-	-
Phear, Sir John	1	1	-
Pigott, H. A.	5	-	-
Pinckney, Miss	10	-	-
Purcell, Rev. W. H. D.	5	-	-
Rocke, General	10	-	-
Rolle, Hon. Mark	1	5	-

£.	s.	d.
Salter, J. E.	5	-
Simms, Rev. & Mrs. E.	5	-
Squarey, Mary K.	5	-
Squire, Capt.	5	-
Stewart, Mrs. H.	10	-
Stewart, Miss	10	-
Stuart, Lady	5	-
Thomas, Coln C. F.	1	1
Thomas, M. J.	5	-
Tyacke, Colonel	10	-
Ware, H.	5	-
Warren, D. S.	5	-
Webber, A. B.	5	-
William, Mrs.	5	-
Wyndham, Rev. E.	1	-
Sums under 5s.	27	4 5
Total Subs.	£85	12 5
<i>Donations.</i>		
Contribution Boxes	1	12 6
Total	£87	4 11

ILFRACOMBE AND MORTHOE BRANCH.

Local Committee—
Dr. THOROLD, Chairman.
G. ADAMS, Esq.
The Rev. H. BARNES.
C. G. BARNETT, Esq.
H. A. G. BARNETT, Esq.
C. J. COFNER, Esq.
W. C. DALLIN, Esq.
C. DARBYSHIRE, Esq., J.P., C.C.
H. M. GARDNER, Esq.
W. H. GOULD, Esq.
DUNCAN GUILDING, Esq.
Lieut. LOLNE, R.N.
Rev. T. W. PIGOT.
WM. WALTERS, Esq.

Treasurer—
Capt. J. C. DENNIS.

Honorary Secretary—
Mr. WILLIAM COLE.

Annual Subscriptions.

Adams, G. Esq.	5	-
Barnett, C. G. Esq.	5	-
Beer, F. Esq.	5	-
Burchell, F. Esq.	5	-
Burton, A. M. Esq.	5	-
Benkinsopp, Rev. E. L.	5	-
Chichester, Lady	1	-
Chugg, F. Esq.	5	-
Clay, Mrs. Stewart	5	-
Cole, Mr. Wm.	5	-
Copner, C. J. Esq.	5	-
Corrie, Miss	5	-
Dallin, W. Cooke, Esq.	5	-
Davis, Mrs.	5	-
Darbyshire, C. Esq., J.P.	1	-
Dennis, Capt.	5	-
Dickinson, C. H. Esq., J.P.	5	-
Down, Miss	5	-
Draper, Mrs.	5	-
Exeter, Ld. Bishop of	10	-
Faber, Misses	5	-
Fursdon, Mrs.	5	-
Gabriel, Mrs.	10	-
Gardner, Dr.	5	-
Gardner, H. J. Esq.	1	1
Gardner, H. M. Esq.	5	-
Garratt, Mrs.	5	-
Girardot, Misses	6	-
Gould, Mr. W. H.	5	-
Guilding, D. Esq.	5	-
Heginbottom, Mrs.	10	-

£.	s.	d.
Henshall, E. Esq.	5	-
Huxtable, Rev. Prebendary	5	-
Jackson, Rev. H.	10	-
Langton, Mrs.	5	-
Leish, Gen.	5	-
Lewis, G. Hilton, Esq.	10	-
Martin, Miss A.	10	6
Martin, Rev. R.	5	-
Maulic, G. N. Esq., J.P.	1	1
Maunder, Misses	5	-
Naish, J. G. Esq., J.P.	10	-
Roberts, Mrs.	5	-
Robinson, Rev. A. E.	1	-
Scott, Miss	5	-
Simmons, Mrs.	5	-
Sopwith, Mrs.	10	-
Stephens, Admiral	5	-
Stewart, Mr.	5	-
Thorold, Dr.	5	-
Toogood, Mrs.	5	-
Toquet, Dr.	5	-
Tween, Miss	5	-
Wall, R. v. Garrett	5	-
Willis, Mrs.	5	-
Wren, Miss	5	-
Sums under 5s.	11	10 6
Total Subs.	£36	4 -
<i>Donations.</i>		
Gabriel, Mrs.	5	-
Collected at Montebello Hotel, per G. Carnell, Esq.	4	10 6
Collected at Imperial Hotel	1	7 6
Collected at Collingwood Hotel	2	10 -
Contribution Boxes—		
Parade Pillar Box	2	16 2
Pavilion Do.	-	15 8
Pier Do.	-	6 10
Boat House	3	2 2
Woolacombe Pillar Box	1	17 9
Boat House Box	1	4 5
Boxes under 5s.	-	5 5
Total Dons.	23	16 5
Total Subs.	36	4 -
£60	-	5 -

LYNMOUTH BRANCH.

Local Committee—
E. B. JEUNE, Esq., President and Chairman.
Mr. BAKER.
Mr. BECK.
Mr. BEVAN.
Mr. BROMLEY, Coastguard Officer.
Mr. CROOK.
Mr. TOM JONES.
Mr. PEDDER.

Honorary Secretary—
Rev. A. K. HOCKLEY, The Vicarage, Lymouth.

Annual Subscriptions.

Baker, Mr.	10	6
Beck, Mr.	5	-
Bevan, Mr. C. N.	10	6
Briggs, Mr.	1	1
Cosway, Miss	1	-
Cox, Rev. W. E.	10	-
Crook, Mr. J.	10	6
Erdrge, Mr.	10	6

£.	s.	d.
Hockley, Rev. A. R.	10	-
Hubbard, Dr.	10	-
Hume, Gen.	10	-
Hume, Capt.	10	-
Jeune, Mr.	10	-
Jones, Messrs.	10	-
Ley, Mrs.	5	-
Newnes, Sir George	5	-
Pedder, Mr.	10	6
Pitt Nine, Mr.	5	-
Riddell, Mr.	5	-
Riddell, Mrs.	5	-
Stanack, Mr.	5	-
Taylor, Mr.	10	-
Tonge, Mr.	1	-
Sums under 5s.	11	6
Total Subs.	£16	15 -
<i>Donations.</i>		
Life-boat Saturday	6	3 8
Life-boat Boxes	1	14 -
Total Dons.	7	17 8
Total Subs.	16	15 -
£21	12 8	

NEWTON ABBOT BRANCH.

(No Local Committee.)

Honorary Secretary—
Mr. R. L. LLOYD.

Collector—
Mr. J. B. TOMPKINS.

Annual Subscriptions.

£.	s.	d.
Baker, Miss	5	-
Baker, Mrs. R. H. M.	10	-
Bearne, Mr. J. A.	5	-
Devon and Courtenay Clay Co.	1	1
Harris, Rev. S. G.	5	-
Hext, G. Esq.	5	-
Hill, General	10	-
Jones, Mrs. Owen	10	-
Rendell & Symons	5	-
Scrutton, D. R. Esq.	1	-
Stockman Bros.	5	-
Watts, Blake, Bearne, and Co.	1	-
Sums under 5s.	2	5
Total Subs.	£8	6 -
<i>Donations.</i>		
Sums under 2s. 6d.	-	2 -
Pillar Contribution Box in Park	-	5 10
Total	£8	13 10

PORT OF PLYMOUTH BRANCH.

Local Committee—
Rear-Admiral J. E. M. WILSON, J.P., Chairman.
Rev. H. C. BAKER.
D. BANKS, Esq.
ROBERT BAYLY, Esq., J.P.
G. E. FOX, Esq.
T. H. GIBBONS, Esq.
Capt. GREY.
T. HUDSON, Esq.
H. HURELL, Esq.

Capt. G. H. INSKIP, J.P., R.N.	
W. LEMAN, Esq.	
F. PHILLIPS, Esq.	
Capt. J. PRINKHAM.	
Capt. T. RADFORD.	
E. ROSEVEARE, Esq., J.P.	
Staff-Capt. G. I. TOMLIN, R.N.	
Admiral Sir GEORGE WATSON, K.C.B.	
G. F. WATSON, Esq.	
F. B. WESTLAKE, Esq.	
Treasurer—	
J. CUMMING, Esq., J.P.	
Honorary Secretary—	
J. ROONEY, Esq.	

Annual Subscriptions.

£.	s.	d.
Adams, B.	5	-
Adams, Clark, and Linton	10	-
Alger, W. H.	10	6
Allen & Sons, John	10	-
Ash, A.	10	6
Bellamy, J. A.	1	1
Bennett, J. N.	5	-
Bewes, C. E. Esq.	1	-
Boolds, G. C.	10	-
Bourne, James, Mrs. 2	-	-
Brown, Wills, and Nicholson	10	-
Bragg, The Misses	1	1
Browne, Solomon (Landrace)	1	1
Burd, J. S.	1	1
Burnard, R.	10	6
Butt, Vosper & Knight	5	-
Campbell, Mrs.	10	-
Coates and Co., Distillery	1	1
Collier Brothers	1	1
Crowther, Mrs.	5	-
Cuddeford, Mr. Thos.	10	-
Derry and Co. Wm.	10	6
Devon and Cornwall Banking Co. Ld.	1	1
Edgcombe, Mount, Earl of	1	1
Elworthy, Curtis, and Dawe	10	-
Ferguson, Dr. E., R.N.	1	1
Foale and Son, W.	10	-
Fowler, The Misses	1	-
Fox, Eliot, and Co.	10	-
Fox Roy Co.	1	1
Fox, Sons, and Co.	10	-
Gas Co., Plymouth	2	2
Gidley, G.	5	-
Goldsmith, J.P.	1	1
Goulding, F. H.	10	-
Greenway, John	10	-
Haycroft and Pethick	10	-
Hicks and Co.	10	6
Holmes, Mrs. A. E.	10	-
Hudson, T.	5	-
Hurrell and Co.	5	-
Jackman, William	5	-
James & Rosewall	10	-
James and Sons, E.	2	2
Lethbridge, J.	5	-
Marshall, E.	5	-
Matthews, H. & Sons	10	-
Matthews, J. W.	5	-
Maynard, H.	5	-
Mortimer, J. F.	5	-
Nathan, Jacob (Trustees of)	1	6 4
Naval Bank	1	1
Nevington, Charles, and Co.	1	1
Orient Line	5	5
Page, Keen and Page	10	-
Parkhouse & Sons	5	-
Pearl, Mrs.	1	1
Peck, W.	1	1
Penrose, R. A.	5	-

	£.	s.	d.
Pethick, J.	-	10	-
Pitts, Son & King, Limited	-	5	-
Popham, Radford & Co.	-	10	-
Rolston, G. T.	-	5	-
Rooker, Miss	-	10	-
Rooney, J.	-	10	-
Roseware, E.	-	10	-
Rundle, Rogers, and Brook, Ltd.	1	1	-
St. Levan, Lord	1	1	-
Seymour, J. and Co.	-	5	-
Shelly, John	-	5	-
Shilston, Wm. H.	-	5	-
Skardon, Mrs. E. J.	-	5	-
Smith, Mrs. G.	-	10	-
Sparrow and Co.	1	1	-
Spooner and Co.	-	10	6
Steadman and Co.	-	10	6
Stoll, Mrs.	1	-	-
Tanner, C. F.	-	10	-
Treleaven, G. F.	-	5	-
Tripe, General	-	10	6
Watson, Admiral Sir George	2	2	-
Watt, C. and Co.	-	5	-
Watts, R. J.	-	5	-
Webber, J.	-	10	-
Western Counties Marine Co, Ltd.	-	10	-
Westlake, F. B.	-	5	-
Whiteford, Mrs. H.	-	5	-
Wilkinson, Archdn.	-	5	-
Willoughby Brothers, Limited	-	10	-
Wills & Co.	-	10	6
Sums under 5s.	1	5	-
Total	£62	19	10

Donations.

Collecting Boxes—			
Chubb's Hotel	-	11	6
Fox, Sons & Co.	-	7	5
Duke of Cornwall Hotel	-	6	1
Royal Hotel, Devonport	-	6	2
G. W. R. passengers' waiting-room	-	7	8
Smeaton Tower	2	1	10
Boxes under 5s.	1	3	9
Total Dons.	5	4	5
Total Subs.	£62	19	10
	£63	4	3

SALCOMBE & HOPE COVE BRANCH.

President—
Major J. BENNETT.

Local Committee—
Rev. E. EDMONSON, M.A.
ASHLEY FROUDE, Esq., C.M.G.
F. GULSTON, Esq.
J. S. HURRELL, Esq., C.C.
Lieut. KELLETT, R.N., D.O. H.M. Coast-guard.
G. McDONOGHUR, H.M. Customs.
Capt. RYALL, R.A.
Capt. W. SHAW, R.A.
Capt. TWYSDEN, R.N., J.P.
Dr. V. TWISING, M.D., M.A.

Honorary Secretary—
Commander C. W. HERBERT, R.N., J.P.

Annual Subscriptions.

Arundel, Rev.	-	5	-
Bashall, Dr. C. E.	-	10	-

	£.	s.	d.
Bennett, Major	1	-	-
Birks, Rev. H. A.	-	5	-
Borlase, Mrs. E.	-	10	-
DeCourcy, Hon. Miss	-	5	-
Dibbin, E. H. Esq.	-	5	-
Douglass, Miss	-	10	-
Edmondson, Rev. E. W.	-	5	-
Elliott, Dr. E.	-	5	-
Finzel, Rev. F.	-	5	-
Foster, Miss	-	10	-
Froude, A. Esq.	-	10	-
Herbert, Commander, R.N., J.P.	-	10	-
Herbert, Mrs.	-	10	-
Heriot, R. Esq.	1	-	-
Hopkins, E. Esq.	-	10	-
Hurrell, John S. Esq.	-	10	-
Ilbert, Mrs. P. A.	-	10	-
Ilbert, W. R. Esq., J.P.	-	10	-
Kelly, Rev. Maitland	1	-	-
Langdon, W. Esq.	-	10	-
Latham, T. W. Esq.	-	10	-
Lewis, Rev. T. C.	-	10	-
Mildmay, F. B. Esq., M.P.	1	1	-
Pace, G. Esq.	-	5	-
Pearce, A. Esq.	-	5	-
Pitman, Rev. W.	-	10	-
Robinson, C. Newton Esq.	1	-	-
Ryall, W. P., Esq.	1	-	-
Seaton, W. S. Esq.	-	5	-
Shaw, Capt. W. J.	-	10	-
Stretton, Hon. Mrs.	-	10	-
Turner, Misses	1	-	-
Twining, Dr. V.	-	10	-
Twysden, Capt. R.N., J.P.	1	-	-
Watson, Rev. W.	-	10	-
Contribution Boxes	-	11	10
Sums under 5s.	1	19	6
Total	£22	12	4

SIDMOUTH BRANCH.

Local Committee—
The Rev. H. G. J. CLEMENTS, Chairman.
W. M. FLOYD, Esq.
A. C. GRAY, Esq.
W. H. HASTINGS, Esq.
Mr. J. NEWMAN.
Mr. S. J. PILE.
Mr. RIDGE, Chief Officer of H.M. Coast-guard.

Honorary Secretary—
W. J. D. WHITAKER, Esq.

Annual Subscriptions.

Allured, W., Esq.	1	1	-
Balfour, Capt. J. E. H.	2	2	-
Cave, Miss M.	-	10	-
Clements, Rev. H. G. J.	1	1	-
Cowan, Mrs. E. J.	-	5	-
Cowell, Mrs.	-	5	-
Darnell, Colonel	-	5	-
Flood, Miss	-	5	-
Floyd, W. M. Esq.	1	-	-
Freer, Rev. W. H. (the late)	-	10	-
Gordon, Mrs. Stewart Gray, A. C. Esq.	-	10	-
Guterres, Mrs.	-	5	-
Harrison, Miss	-	10	-
Hastings, W. H. Esq.	10	6	-
Isaacs, G. T. Esq.	-	5	-
Kennedy, Miss M.	1	-	-
Kennet-Were, T. Esq., Leese, Sir J., Q.C., M.P.	-	5	-
Mewburn, Col.	1	1	-
Moulton Barrett, H. Esq. (the late)	1	1	-

	£.	s.	d.
Morritt, J. M., Esq.	-	5	-
Power, H. Esq.	-	5	-
Radford, J. G. G. Esq.	-	10	-
Radford, Dr.	1	-	-
Smith, Mrs. Brooke	-	5	-
Spiller, Mrs.	-	5	-
Stainton, Miss A.	-	5	-
Stanford, E. Esq.	-	5	-
Taylor, R. Esq.	-	5	-
Wood, R. H. Esq.	1	1	-
Sums under 5s.	4	14	6
Total Subs.	£22	2	-

Donations.

Contribution Boxes	2	19	10
Total	£25	1	10

TEIGNMOUTH BRANCH.

Local Committee—
Mr. STONE, Chief Officer of Coast-guard.
Mr. C. W. BURNETT.
Mr. C. R. COLLINS, C.C.
Mr. G. F. FLEMMICH.
Mr. T. W. HUTCHINGS.
Mr. H. RICHARDS.
Mr. P. WARD.

Treasurer and Hon. Sec.—
Mr. W. J. BURDEN.

Annual Subscriptions.

Aldham, Mrs. Cornwallis	-	5	-
Atkins, Mrs.	-	10	-
Bower, J. B., Major	-	5	-
Brown, Lewis, Major, J.P.	-	5	-
Browne, Mrs. Hall	-	5	-
Browne, Rev. W. B.	-	10	-
Burden, W. J.	-	10	-
Burnett, C. W. Esq.	-	5	-
Collins, C. R. Esq.	-	10	6
Colston, C. H., Dr.	-	5	-
Compton, Mrs.	-	5	-
Cooke, T. O. Preston, Esq.	-	5	-
Crossfield, W. Esq.	-	5	-
Dry, Lady	-	5	-
Ermen, Miss	-	10	-
Franklin, Mrs.	1	1	-
Farley, the Misses	-	5	-
Flemmich, G. F. Esq.	-	10	6
Flemmich, Mrs.	1	1	-
Friend, G. P. Esq.	-	5	-
Fripp, Miss	-	10	-
Fry, H. P. Esq.	-	5	-
Fry, Mrs.	-	10	-
Glanville, Rev. O. F.	-	10	-
Glanville, Miss	-	10	-
Gulson, J. R. Esq.	-	10	-
Halford, Mrs.	-	5	-
Hornor, Capt. J.	-	10	-
Hutchings, T. W. Esq.	-	10	-
Hutchings, Rev. H.	-	10	-
James, T. Esq.	-	10	-
Jordan, W. R., Hall & Son	-	5	-
Key, Miss E.	3	10	-
Langley, Miss	1	1	-
Leah, Miss	-	10	-
Lloyd, Capt.	-	10	-
Loddiges, C. Esq.	-	10	6
Mainwaring, General	-	10	-
Metcalfe, Rev. J.	-	5	-
Morrison, Colonel	-	5	-
Morrison, J. W. Esq.	-	5	-
Morrison, Mrs.	-	5	-
Notton, J. Esq.	-	5	-
Oliver, Mrs.	-	10	-
Parsons, Mrs.	-	5	-
Paul, Capt. A. G.	-	5	-
Rewse, Mrs. J. Smith	-	5	-
Richards, H. Esq.	-	5	-

£135 10 11

	£.	s.	d.
Richards, Miss	-	10	-
Rowbotham, Mrs.	-	5	-
Ryder, The Very Rev. Cyril	-	5	-
Spencer, H. H. Esq.	-	10	-
Spencer, Mountford, Esq.	-	10	-
Sprat, Miss	-	5	-
Stayner, Mrs.	-	5	-
Tab, J. G. Esq.	-	5	-
Teignmouth Harbour Commissioners	-	10	-
Walton, W. H. Esq.	-	5	-
Ward, P.	-	5	-
Williams, G. Esq.	-	10	-
Wood, C. H. Esq.	-	10	6
Young, Geo. Esq.	-	10	-
Sums under 5s.	9	18	3
Total	£47	8	3

Donations.

Annual Demonstration	81	-	8
Black Diamond Minstrels	1	18	10
Loddiges, Collected by Master C.	-	10	-
Newman, C.W. Esq.	-	5	-
Contribution Boxes	4	8	2
Total Dons.	88	2	8
Total Subs.	47	8	3

TORQUAY BRANCH.

President—
R. S. S. CART, Esq.

Vice-President—
R. MALLOCK, Esq.

Local Committee—
J. KIRSON, Esq., Chairman.
Rev. B. R. AIRY.
W. BALL, Esq.
Gen. CHAMBERLAYNE.
R. A. OUS CLARK, Esq.
Rev. A. P. OX.
Commander D. CROFTON, R.N.
W. GROGAN, Esq.
Rev. J. HEWITT.
Mr. M. HOLMES, Chief Officer H.M. Coastguard, Torquay.
Lieut. F. G. INNIES-LILLINGSTON, R.N.
Rev. H. W. MAJENDIE.
Commander C. MILNE, R.N.
J. BANNER NEWTON, Esq.
B. C. SALMONSON, Esq.
Rev. G. H. STATHAM.
Mr. J. HESSE THOMAS, R.N.R., H.M. Customs.

Hon. Secretary & Collector—
Mr. J. G. NEVIN, late R.N., 11, Trafalgar Terrace, Torquay.

Annual Subscriptions.

A Friend	1	-	-
Airy, Rev. B. R.	-	10	-
Anslie, W. Esq.	1	1	-
Aldum, The Misses	-	5	-
"Alvanly"	-	7	6
Apthorp, Mrs.	-	5	-
Ash, W. Hargood, Esq.	-	5	-
Backhouse, A. Esq.	1	-	-
Baillie, Mrs. Alex.	-	5	-
Bainbridge, Col., and Mrs.	-	10	-

£.	s.	d.	£.	s.	d.
Barkley, Mrs. Trevor	1	1	Hewett, Rev. J.	10	-
Barley, Mrs.	5	-	Hockin, Admiral C.	-	-
Beckett, Hon. Mrs.	-	-	L. R.N.	5	-
(the late)	1	-	Hooper, H. Dundee,	-	-
Benbow, Vernon,	-	-	Esq.	10	6
Esq.	10	-	Hole, Mrs. Florence	1	1
Bernard, Mrs. Henry	5	-	Holl, Miss	5	-
Bigge, F. E. Esq.	1	-	Hounsell, Mrs.	-	-
Boileau, Mrs. F. W.	10	-	Strangways	5	-
Boileau, Miss M.	5	-	Humphrey, Miss	10	-
Bosanquet, F. B. Esq.	-	-	Hundley, Rev. O. C.	5	-
(the late)	1	-	Huxley, Dr.	10	6
Bovill, B. Esq.	10	-	Innes - Lillingston,	-	-
Bovey, E. P. Esq.	5	-	L'eat. F. G., R.N.	10	-
Bower, Rev. E. J.	5	-	J. C.	1	-
Boyd, H. C. Esq.	5	-	Jourdan, F. Esq.	5	-
Brandt, Miss E. C.	10	-	Johnston, Miss E. S.	10	-
Bridson, Major	1	1	Jolly, Miss Isabel	5	-
Bright, J. Esq.	1	1	Julyan, Sir P. G.	5	-
Brown, H. C. Esq.	5	-	Keates, J. A. Esq.	10	-
Budd, Miss	5	-	Kimber, J. W. Esq.	5	-
Burchardt, Mrs. Otto	1	-	Kinloch, Gen. Alex.	-	-
Bu-hly, P. W. Esq.	1	1	A. A.	5	-
Calley, Miss	1	-	Kitson, Mrs. (the late)	1	1
Calthrop, Mrs.	5	-	Kitson, W. H. Esq.	10	6
Campbell, the Misses	5	-	Kitson, John, Esq.	10	6
Capel-Cure, Mrs. E.	5	-	Knox-Gore, Major-	-	-
Cary, R. S. S. Esq.	1	-	General Saunders.	10	-
Cash, Mrs.	5	-	Lake, The Very Rev.	-	-
Caspersz, Mrs.	10	-	Dean	10	-
Casson, Rev. G.	5	-	Langton Miss	5	-
Cave, F. E. Esq.	5	-	Lavers, Miss	5	-
Chamberlayne, Gen.	10	-	Layard, Mrs. Brown-	-	-
Chatto, D. Potts, Esq.	1	-	low	1	1
Chillingworth, Col.	-	-	Lee, the Misses	10	-
J. G.	10	-	Lee, H. W. Esq.	5	-
Churchill, Miss H.	10	-	Lloyd, E. R. Esq.	-	-
Clark, R. Audus, Esq.	1	-	(the late)	5	-
Clarke, Rev. H.	5	-	Lombo, Rev. E.	5	-
Clifford, Mrs. Morgan	5	-	MacAndrew, Miss	5	-
Cole, Mrs. R. Henry	5	-	MacAndrew, Mrs.	5	-
Collett, Mrs. Chas.	10	-	MacDougall, Col.	5	-
Compton, Mrs.	5	-	Macintosh, The Misses	5	-
Congreve, Mrs.	10	6	Maddison, Rev.	10	-
Coulthurst, J. Esq.	1	-	Majendie, Rev. H. W.	10	6
Cousen, J. Esq.	1	-	Mallock, R. Esq.	1	1
Cox, Maj.-Gen. C. W.	10	-	Mann, Rev. C. N.	5	-
Craig, Mrs. S.	5	-	Manning, Major	5	-
Croker, E. J. Esq.	1	-	Marj-ribanks, Lady	10	-
Cubitt, The Hon.	-	-	Martin, C. E. Esq.	5	-
Helen	10	-	Maude, General Sir	-	-
Cumming, Mrs.	-	-	F. F.	1	-
Hamilton	5	-	Middley, Miss	5	-
Cutler, G. O., Esq.	5	-	Mills, R. Esq. (the	-	-
De Montmorency,	-	-	late)	10	-
Mrs.	5	-	Milne, Com. C. R. N.	5	-
Donne, Mrs.	5	-	Mould, Rev. J. G.	10	-
Drane, Mrs.	5	-	Musgrave, G. A. Esq.	5	-
Drinkwater, P. B. Esq.	1	1	Newton, J. Banner,	-	-
Drury, Rev. B. H.	5	-	Esq.	10	-
Du Buisson, Mrs.	10	-	Norris, W. E. Esq.	5	-
Dundas, Mrs. Hamil-	-	-	Odell, Dr. W.	5	-
ton	5	-	Orfeu, C. H. Esq.	10	6
Durrant, The Misses	1	-	Oldfield, W. H. Esq.	5	-
Edgelow, Dr. W. Ford	5	-	Pungelly, Miss	5	-
Elliott, Mrs.	5	-	Perks, R. Esq. (the	-	-
Erie, Miss E.	10	6	late)	5	-
Erskine, H. H. Esq.	5	-	Petty, G. Esq.	5	-
Exmouth, Viscount	10	-	Phillips, Mrs. Legh	5	-
Fenton, Wingate W.	-	-	Phillips, Captain	-	-
E. Esq.	1	-	Winsloe	5	-
Fordyce, Mrs. Chas.	10	-	Phillips, The Misses	1	-
Garrett, Mrs., and	-	-	Phillipotts, Capt. A.,	-	-
Friend	5	-	R.N., M.P.	10	-
Gairder, W., Esq.	10	-	Pitt, Mrs.	5	-
Gausson, Mrs.	10	-	Pope, Rev. A.	5	-
Gausson, The Misses	7	6	Powell, Dr.	5	-
Gau-sen, Capt. R. G.	1	-	Power, Mrs. E.	5	-
George, Mrs. F.	5	-	Proctor, Mrs.	5	-
Gooch, Mrs. (the late)	1	1	Ravenscroft, E. W.	-	-
Gooch, Miss	10	-	Esq.	5	-
Greaves, Rev. Talbot	5	-	Renwick & Wilton,	-	-
Gregor, Miss G. M.	1	10	Messrs.	5	-
Grylle, Hill H. Esq.	5	-	Richmond, Rev.	-	-
Hale, Miss	5	-	W. A.	5	-
Hamilton, Com. C. Lt.	-	-	Ridley, M's.	5	-
Cole, E. N.	1	-	Ringrose-Ion, M's.	1	-
Hammick, Lady	5	-	Robinson, J. Blythe,	-	-
Heawood, Mr. & Miss	5	-	Esq. (the late)	10	-
Henderson, Mrs.	1	-	Robinson, Col. and	-	-
Heskerh, Mrs. E.	-	-	Mrs.	5	-
Bamford	1	-	Robson, The Misses.	1	-

Rogerson, Mrs.	10	-
Rossal, J. H. Esq.	10	-
Ryder, R. C. W. Esq.	1	-
Salmonson, B. C. Esq.	1	-
Sanders, J. S. Esq.	1	-
Saunders, Mrs. J. B.	5	-
Schuster, Mrs. S.	10	-
Sealy, Rev. W.	5	-
Sermon, E. Esq.	5	-
Shannon, A. Esq.	1	-
Shapley & Sons,	-	-
Messrs.	10	-
Slade & Sons, Messrs.	5	-
Smith, Dr. Clement	5	-
Snelgrove, John, Esq.	2	2
Sparke, Morton, Esq.,	-	-
(the late), in Me-	-	-
moriam	5	-
Stewart, N. B. Esq.	1	-
Stonestreet, F. Esq.	1	-
Struben, F. Esq.	1	-
Squire, Capt.	10	-
Taylor, C. W. Esq.	10	-
Taylor, Mrs. Harry	5	-
Taylor, Mrs. Henry	5	-
Thompson, Mrs.	-	-
Joseph	1	-
Timperley, F. Esq.	5	-
Tottenham, Capt.	-	-
J. F., R.N.	10	-
Tooke, Miss E. L.	1	1
Trehane, J. Esq.	5	-
Trevenen, The Misses,	-	-
"Fernhill"	5	-
Trevenen, The Misses,	-	-
"Fosaway"	5	-
Tucker, W. Thorn-	-	-
hill, Esq.	1	-
Tucker, Capt. W.	-	-
Fane	5	-
Turnbull, Mrs. J. R.	5	-
Underhay, Miss W.	10	-
Vivian, Mrs. W. (the	-	-
late)	10	-
Wate fall, Mrs. W.	1	-
Waterhouse, G. M.	-	-
Esq.	5	-
Webb, Miss L. A.	5	-
West, J. J. Esq.	5	-
Whidborne, The	-	-
Misses	5	-
White, G. F. Esq.	5	-
Whitehead, J. N. Esq.	5	-
Whitway and Ball,	-	-
Messrs.	10	-
Wilks, Dr. (the late)	1	1
Wilson, Miss	5	-
Williams, Hamilton,	-	-
Esq.	5	-
Wilton, Mrs.	10	-
Withington, Capt.	5	-
Woodhouse, Mrs.	-	-
Secretan	5	-
Wright, Commander	-	-
D., R.N.	5	-
Total	£105	13

Donations.

Offertory, St. Mark's	-	-
Church	6	10
Offertory, Babla-	-	-
combe Church	1	9
Collecting Boxes	4	5
Sums under 6s.	12	6
Total Dons.	24	10
Total Subs.	105	13
	£137	3

YEALM RIVER BRANCH.

Local Committee—
BALDWIN J.P. BASTARD, Esq.,
Chairman.
The Right Hon. Lord REVEL-
STOKE.
N. S. CHAFFE, Esq.
V. HOLBERTON, Esq.
J. STONE, Esq., R.N.
M. WILLIAMS, Esq.
Rev. C. B. YONGE.

Hon. Secretary—
JOHN YONGE, Esq.

Annual Subscriptions.

£	s.	d.
Collinsplatt, Hawtrey,	-	-
Esq.	1	1
Hicks, Miss	1	1
Holberton, Colonel, &	-	-
V. Holberton, Esq.	1	1
Bastard, B.J.P., Esq.	1	1
Yonge, Miss	1	1
Yonge, J. E., Esq.	1	1
Yonge, John, Esq.	1	1
Contribution Box	-	6
Total	£7	7

Dorsetshire.

BRIDPORT DISTRICT BRANCH.

(No Local Committee.)

President—
W. COLFOX, Esq.
Secretary and Collector—
Mr. J. H. EWENS.

Annual Subscriptions.

£	s.	d.
Colfox, Mrs.	1	-
Colfox, W.	1	-
Colfox, T. A.	5	-
Ewens and Turner	5	-
Gundry, F. W.	5	-
Hounsell, H. B.	5	-
Hounsell, W.	10	-
James, W.	5	-
Knight, W.	5	-
Rendall & Coombs	5	-
Palmer, C. and R.	5	-
Tucker, Henry	5	-
Williams, Col., M.P.	1	1
Sums under 5s.	1	2
Total	£6	18

LYME REGIS BRANCH.

Local Committee—
T. E. D. PHILPOT, Esq.,
J. P. Chairman.
A. J. CHALMERS, Esq., J.P.
Capt. W. E. COOKSON, R.N.
Z. EDWARDS, Esq., J.P.
Lieut. F. ELTOY, R.N.
H. HENLEY, Esq., J.P.
E. HOMAN, Esq., J.P.
Alderman G. OSBORN,
Mayor, J.P.

Treasurer— F. WILLS, Esq.		C. CARTER, Esq.		Goad, Mrs. M.		£. s. d.		Donations.	
Honorary Secretary— M. C. PRESTON, Esq.		Rev. C. F. DE JERSEY.		Godwin, J. P. Esq.		10 - -		Miss Weller 10 10 -	
Annual Subscriptions.		Canon E. C. DUGMORE.		Habgood, G. E. q. jun. 1		1 - -		Mr. Gwyer (The	
£. s. d.		Rev. — ELIOT.		Hankinson, T. J. Esq. 10		- 10 -		Penge Post (Col-	
Allhusen, Wilton,	- 10	J. P. GODWIN, Esq.		Hartley, Captain ... 5 6		- 5 6		lecting Box) ... 6 - -	
Ambrose, W. Esq.	- 5	Mr. W. J. HILL.		Hawker, H. C. Esq. ... 5		- 5 -		Kemble, Dr. A. C.,	
Andrews, Miss, and	- 5	A. C. KEMBLE, Esq.		Hedges and Butler,		- 5 -		Proceeds of Cong. rt	
Miss Edwards,	- 5	Major MAUNSELL.		Messrs. 5		- 5 -		Pillar Box, Pier Ap-	
Barlow, Mrs.	- 5	W. McFAUL, Esq.		Hill, C., Esq. 5		- 5 -		proach, Bourne-	
Bosanquet, Rev. F.	- 5	J. McWILLIAM, Esq.		Hill, W. J. Esq.		- 5 -		mouth 2 17 11	
C. T.	- 5	Rev. Father MORFORD.		(2 years) 10		- 10 -		Ditto, Pier, - 13 8	
Brandram, A. Esq.	- 5	Naval Instructor C. SMITH.		H. Miray, G. Esq. ... 5		- 5 -		Visitrs, Manchester	
Chalmers, A. J. Esq.	- 5	Mr. CHAS THRESH.		Hopkins, Rev. F. ... 1		- 1 -		Hotel (Mr. G. Cole)	
Coode, Mrs.	- 5	Colonel VENNOR.		Hutchinson, Maj.-		- 5 -		Box at Coastguard	
Cooper, H. J., Esq.	- 5	Honorary Secretary—		Gen 5		- 5 -		Station, Bourne-	
Edwards, Z. Esq.,	- 5	Mr. H. BURDEN, Jun., West		Hyde, Miss C. 2		- 2 -		mouth 1 5 11	
J. P.	- 5	Shore Wharf, Poole.		Ichester, The Right		- 5 -		Collecting Boxes ... 7 2 -	
Escott, Mrs.	- 5	Honorary Treasurer—		Hon. the Earl of ... 5		- 5 -		Various donations &	
Gordon, A. B., Esq.	- 5	Mr H. E. SHAVE, "Annand-		Ingle, Miss. 5		- 5 -		sums under 5s. - 19 11	
Gordon, Mrs.	- 5	dale," Longfleet, Poole.		Jersey, Rev. C. F. de		- 5 -		Total Dons. 35 15 4	
Hayward, Miss.	- 5	Collector—		King, Mr. H. 10 6		- 10 6		Total Subs. 75 - 6	
Henley, H. Esq., J. P.	1	Miss E. DAVID, 1, Cumnor		Knight, Mr. B. 5		- 5 -		110 15 10	
Homan, E. Esq., J. P.	1	Terrace, Bournemouth.		Lane, C. Esq. 5		- 5 -		Net Proceeds of	
Hooper, Mrs.	- 5	Annual Subscriptions.		Lawson, Rev. J. A. ... 5		- 5 -		"Life-boat Satur-	
Lister, Mrs.	- 5	£. s. d.		Lees, Sir E. Holt, Bart.,		- 1 1 -		day" at Bourne-	
Mallock, Col.	- 7 6	Adam, Lady 5		M. P. 1		- 1 -		mouth and Poole. 84 0 0	
Matthew, J. W., Esq.	- 5	Aldridge, H. M. Esq. ... 5		Littlehale, Mrs. 10		- 10 -		4194 15 10	
Matthey, Miss 5	- 5	Allen, J. & Co. 5		Linton, Rev. 5		- 5 -			
Mitchell, Mrs. 5	- 5	Andrews, Mr. J. R. ... 5		Loring, Rev. H. N., ... 10		- 10 -			
Munroe, Col. 10	- 10	Arnold, Lady C. 5		Maberley, Maj.-Gen. 1		- 1 -			
Newall, G. F. Esq.,	- 5	Ashton, C. Esq. 1		Mahon, Mr. & Mrs.		- 3 -			
J. P.	- 5	Backhouse, Messrs ... 5		R. H. D. 3		- 3 -			
Otton, Rev. G. W. 5	- 5	Baker, E. W. Esq. 5 6		Marshall, Maj.-Gen. 5		- 5 -			
Paine, Mrs. Lewis. 10 6	- 10 6	Baker, Rev. A. L. F. ... 5		Mau-sell, Major. 1		- 1 -			
Pares, Miss 5	- 5	Ballard & Son, Messrs. 5		McFaul, W. Esq. 5		- 5 -			
Philpot, Mrs. 5	- 5	Beckford, F. J. B.		McKenzie, L. Esq. ... 2 10		- 2 10 -			
Philpot, T. E. D.	1	Esq., (2 years) 2		McWilliam, G. Esq. ... 5		- 5 -			
Esq., J. P.	1	Belben, G. Esq. 10 6		McWilliam, J. Esq. ... 10		- 10 -			
Preston, J. W. Esq.,	- 5	Belben, T. Esq. 10 6		Monckton, S. Esq. ... 10 6		- 10 6			
J. P.	- 5	Bell, Miss. 5		Moore, W. W. Esq. ... 5		- 5 -			
Shipley, Orby, Esq. 5	- 5	Bennett, H. M. Esq. ... 5		Morford, Rev. A. ... 5		- 5 -			
Shore, Mrs. 5	- 5	Blanchard, E. N. Esq. ... 10		Morres, Mrs. 5		- 5 -			
Stanger-Leathes, the	- 5	Bandy, Mrs. 5		Morris, J. T. Esq. ... 5		- 5 -			
Misses 5	- 5	Boraston, Mrs. 5		Newcastle Coal Co. ... 5		- 5 -			
Talbot, J. R. C. Esq.,	- 10	Boyd, General D. 10		Oakes, M. S. 5		- 5 -			
J. P.	- 10	Bradford, General ... 5		Oakley, Bros., Messrs. 5		- 5 -			
Talbot, J. Reginald	- 10	Bright, F. J. Esq. 5		Parker, Miss. 5 6		- 5 6			
F. G. Esq., J. P.	- 10	Bright, Miss. 10		Penney & Co., Messrs.		- 5 -			
Talbot, Reginald A.	- 5	Brown, Mrs. A. 5		G. R. 5		- 5 -			
Esq.	- 5	Brown, L. G. Esq.		Pig-u, Rev. H. C. 1		- 1 -			
Vivian, Hon. Mrs. E. ... 5	- 5	(1895-6) 2 2		Pinney, R. E. Esq. ... 5		- 5 -			
White, Rev. W. H. ... 5	- 5	Brook, Mrs. W. 5		Foole & Baltic		- 5 -			
Williams, Col. R. ... 1	- 1	Buckley, Titus Esq. ... 5		Timber Co. 5		- 5 -			
Wynch, W. M. Esq. ... 5	- 5	Buckley, J. W. Esq. ... 5		Popham, Mrs. 5		- 5 -			
Sums under 5s. 4 10 6	- 4 10 6	Burden & Son, Messrs 5		Powys, Miss. 5		- 5 -			
Total Subs. ... £18 5 6	- 18 5 6	Burden, Messrs. H.		Punch, Mrs. 5		- 5 -			
Donations.		& Co., Junr. 5		Roberts, Mrs. A. 10		- 10 -			
Contribution Boxes, 1 10 11	- 1 10 11	Burrows, Rev. C. L. ... 10		Robinson, Miss H. R. ... 5		- 5 -			
£19 16 5	- 19 16 5	Butler, Mrs. 5		Rogers, Mrs. H. 5		- 5 -			
POOLE AND BOURNEMOUTH BRANCH.		Cairns, Dowager		Rogers, Rev. M. 5		- 5 -			
Patron—		Countess. 10		Rollo, General. 5		- 5 -			
The Right Hon. the Earl of		Curry & Co. Messrs. ... 5		Rough, Captain D. ... 5		- 5 -			
ILCHESTER, Lt.-Lieut. of		Carter & Co., Messrs. ... 10		Sercombe, Mrs. E. ... 5		- 5 -			
Poole.		Carus, Mrs. 5		Sharp, R. D. E. q. ... 5		- 5 -			
President—		Canum, Mrs. 5		Shave, Mr. H. E. 5		- 5 -			
The Right Hon. Lord		Cecll, H. Esq. 5		Simmons, Misses ... 5		- 5 -			
WIMBORNE.		Chislett & Co., Messrs. 5		Simpson, H. Esq. ... 1		- 1 -			
Chairman—		Cooke, General. 5		Smith, J. J. Esq. 10		- 10 -			
Rev. J. A. LAWSON, M.A.		Cox, Thomas, Esq. ... 1		Soul, T. P. Esq. 10 6		- 10 6			
Local Committee—		Cocker, J. A. Esq. 5		Sydenham & Co.,		- 5 -			
Mr. J. ANDREW.		Damer, Mrs. L. Daw-		Messrs. 5		- 5 -			
Mr. W. J. BACON.		son 1		Taylor, L. Esq. 6		- 6 -			
Rev. A. L. F. BAKER.		Denny, Chas. Esq. ... 1		Thomas, Dr. 5		- 5 -			
Captain BALFOUR.		Dorset Ironfoundry		Thompson, Mrs. R. ... 5		- 5 -			
H. M. BENNETT, Esq.		Co. 5		Tuck, Mrs P. 10 6		- 10 6			
		Druitt, J., Esq., sen. ... 10		Venner, Col. 1		- 1 -			
		Druitt, J. Esq., Jun. ... 5		Wadhams, W. Esq. ... 5		- 5 -			
		Dugmore, Canon. 5		Walker, Rev. C. 10		- 10 -			
		Easton, Capt. F. 5		Walker, Mrs. C. 10		- 10 -			
		Elton, Miss. 10		Waterman, W. E.		- 5 -			
		Elwes, G. R., Capt. ... 5		Esq. 5		- 5 -			
		Fair, John, Esq. 1		Way, Mrs. 5		- 5 -			
		Fawkes, Rev. 1		Webb, Mr. D. 10		- 10 -			
		Forde, H. Esq. 5		Well-r, Miss. 1		- 1 -			
		Foster, Mrs. 10		Witt, A. K. Esq. 1		- 1 -			
		Fullerton, Mrs. A. ... 5		Wimbome, Lord ... 2 2		- 2 2 -			
		Fullerton, Mrs. W. ... 5		Wollaston, Mrs. E. O. ... 5		- 5 -			
		Furnell, T. S. Esq. ... 5		Wood & Co., Messrs. ... 5		- 5 -			
		Garfit, Miss L. 5		Sums under 5s. 4 9		- 4 9 -			
				Total £75 - 6		- 75 - 6			
								Donations.	
								Bond, W., Collected	
								by 3 -	
								Ricketts, Miss, Col-	
								lected by 11 6	
								Robertson, Mrs., Col-	
								lected by 1 3 6	
								War-ham Church	
								Collection 6 4 -	

Williams, W., Col- lected by	£. s. d.
Yearsley, Miss, Col- lected by	17 1
	6 -
Total Dons.	9 5 1
Total Subs.	26 17 6
	£36 2 7

SWANAGE BRANCH.

President—
JOHN MOWLEM BURT,
Esq., J.P.

Local Committee—
Lieut. F. BARRET, R.N.,
D. O.
Mr. F. A. BURT.
Mr. HENRY W. BURT.
Mr. JOHN DOWDESWELL.
Mr. JAMES HAYSON.
Mr. JOHN HAYSON.
Mr. GEORGE HORLOCK.
Mr. JOHN VYE.
Mr. WALTER WHITE.
Mr. LOUIS HAYSON.
Mr. WILLIAM HAYSON.

Treasurer—
G. C. DE LA MOTTE, Esq.

Honorary Secretary—
Mr. EDWARD BRUNSEN.

Annual Subscriptions.

Aldridge, Mr. H. M.	5 -
Anderson, K., Esq.	1 1
Burt, The Misses.	10 -
Burt, J. M. Esq.	2 2
Burt, Mr. F. A.	5 -
Cossins, Mr. G. D.	5 -
Digby, Hon. Lord	1 -
Goodham, Mr. J. H.	5 -
Hickman, Mrs.	5 -
Kensington, Mr. T.	5 -
Manwell, Miss	10 -
Randell, Mrs.	5 -
Robinson, Sir Chas.	2 2
Slade, J. R., Esq.	5 -
Slater, E. Esq.	1 1
Sturt, Hon. H. M.P.	1 -
Sums under 5s.	17 6
Total	£12 3 6

Donations.

Colson, Miss	5 -
Crew of Steam Yacht "Gladys"	1 -
E. W.	4 -
Fawcett, Mrs. S.	5 -
G. R.	4 -
Hetherington, W. L., Esq.	5 -
In Memoriam	1 -
J. S. V.	5 -
Legg, Mrs. E. W.	5 -
Mills, Miss & Mester Dowdeswell, Col- lected by	3 2 3
Other Sums	2 -
Proceeds of Concert	16 5 7
Contribution Boxes.	12 4 10
Total Dons.	37 5 8
Total Subs.	12 3 6
	£49 9 2

WEYMOUTH BRANCH.

Patron—
**The Right Hon. the EARL
OF STRAFFORD.**

President—
**The Right Hon. LORD
ASHLEY.**

Local Committee—
GEORGE EDWARD ELIOT, Esq.
J.P., Chairman.
The Mayor of Weymouth.
A. L. W. CAMERON, Esq.,
Collector of Customs.
Sir Rich. Howard, J.P.
Captain PRETOR, J.P.
HUGH SPEKE, Esq., J.P.
Capt. E. PAYNE GALWEY.
Capt. GEO. E. WINGFIELD.

Honorary Secretary—
Mr. HENRY WARREN.

Annual Subscriptions.

Bayley, E. Esq. J.P.	1 1
Devenish and Co., Ld., Messrs. J. A.	10 6
Eliot & Co. Messrs.	1 1
Eliot, George, Esq.	10 6
Ford, Mr. J. E.	5 -
Groves & Son	5 -
Hodges, J. F. & Co.	10 6
Hopkins, B. Esq., J.P.	5 -
Howard, Sir Rich. J.P.	5 -
Lynes, Rev. J.	5 -
Moorhead, Dr.	10 -
Pretor, Capt.	5 -
Simpson, Dr.	5 -
Speke, H. Esq.	5 -
Steward, Col.	10 6
Welsford, G. B. Esq.	5 -
Williams, Messrs. R. and H. and Co.	1 1
Sums under 5s.	10 -
Total	£8 10 -

Donations.

S.S. <i>Empress</i> , Capt. Stone	1 3 -
S.S. <i>Albert Victor</i> , Capt. Hardy	5 8 9
S.S. <i>Premier</i> , Capt. Masters	3 -
S.S. <i>Victoria</i> , Capt. Cox	19 16 -
S.S. <i>Queen</i> , Capt. Rawle	6 2 9
Collins, G. H. & Co., Portland	3 18 6
Boxes:— Crown Hotel and Shades	9 -
Weymouth Rlwy. Station	10 9 -
Pillar Box	6 5 -
Pier	7 3 -
Sums under 5s.	1 1 -
Total Dons.	42 3 5
Total Subs.	8 19 -
	£50 13 5

Durham.

DURHAM BRANCH.

Local Committee—
Col. ROWLANDSON.

Honorary Secretary—
Rev. Canon FIRTH, M.A.

Annual Subscriptions.

Greenwell, Canon.	£. s. d.
Hays, Miss (1897)	10 6
Herschell, Lord	2 2 -
Total	£3 3 -

HARTLEPOOL BRANCH.

President—
Major BURDON.

Local Committee—

R. BARWICK, Esq.
W. BELK, Esq.
R. HOOPER, Esq.
J. HORSLEY, Esq.
T. MUDD, Esq., Mayor.

Honorary Secretary—
S. HERBERT BELK, Esq.

Assistant Hon. Secretary—
ALFRED BELK.

Annual Subscriptions.

Belk, Alfred, Esq.	1 1 -
Belk, Mrs. Ewd.	1 1 -
Burdon, Major	3 3 -
Coverdale, R. H. Esq.	1 1 -
Furness, Sir C.	2 2 -
Furness, Withy & Co.	1 1 -
Hartlepool Port and Harbour Commis- sioners	5 5 -
Johnson, J. E. Esq.	10 6 -
Neilsen, C. Esq.	1 1 -
Richardson, Thos. Esq., M.P.	3 3 -
Ropner, Col.	1 1 -
Total	£20 9 6

Donations.

Berry, C.	5 -
"Abbotsford," per E. J. Restall.	5 7 -
The master and crew of the S.S. <i>Aller- wash</i>	1 17 8
Ditto, 2nd donation	1 19 4
Voluntary contribu- tions from Ship- ping	43 8 11
Proceeds of Hartle- pool Amateur Swimming Club Water Gala	19 - -
Sums under 5s.	2 6 -
Total Dons.	66 19 -
Total Subs.	20 9 6
	£87 8 6

SEAHAM BRANCH.

President—
**The Most Noble
The MARQUIS OF LONDONDERRY, K.G.**

Local Committee—
Rev. A. BETHUNE, M.A.,
Chairman.

J. J. CANDLISH, Esq., J.P.
Rev. J. COLLING.
S. J. DITCHFIELD, Esq.
J. H. BERKLEY, Esq.
Mr. JOHN SMITH.
**The Chief Officer of H.M.
Coast Guard.**

Honorary Secretary—
WILLIAM WARHAM.

Annual Subscriptions.

Londonderry, The Marquis of, K.G.	£. s. d.
Barrett, C. R. Esq., J.P.	3 3 -
Berkeley, J. H. Esq.	5 -
Bethune, Rev. A.	10 -
Brough, T. Esq.	5 -
Brydon, R. Esq.	5 -
Candlish, J. J. Esq., J.P.	10 -
Clazey, J. O.	5 -
Chilton, Thos. Esq.	5 -
Colling, Rev. J.	5 -
Corbett, V. W. Esq.	5 -
Ditchfield, S. J. Esq.	5 -
Eminson, J. B. Esq.	10 6 -
Every, Rev. E. F.	10 6 -
Hardy, G. Esq.	5 -
Lambert Brothers	2 2 -
Lough, W. Esq.	5 -
North Hetton Coal Company	2 2 -
Smith, John	5 -
Smith's Dock Co.	1 1 -
The South Hetton Coal Company	2 2 -
Thorman, Robt. Esq.	10 6 -
Warham, William	5 -
Woods & Co., Messrs.	1 1 -
Total	£17 7 6

Donations.

Collected from Ships	9 19 5
Contribution Boxes— S.S. <i>Kronos</i>	1 - -
S.S. <i>Longneaton</i>	19 -
S.S. <i>Vane Tempest</i>	7 -
S.S. <i>Viceroy</i>	11 -
S.S. <i>Viscount Castle- reagh</i>	1 7 6
Other Boxes under 5s.	7 10 -
Total Dons.	14 11 9
Total Subs.	17 7 6
	£31 19 3

SEATON CAREW BRANCH.

Local Committee—
T. HARRY TILLY, Esq.,
Chairman.

E. W. GARBUTT, Esq.
E. B. MOUNSEY, Esq.
HIGSON SIMPSON, Esq.

Treasurer and Honorary
Secretary—
Rev. C. B. HUNTER, M.A.

Annual Subscriptions.

Eldon, The Earl of.	5 - -
Backhouse, Mrs. A.	1 1 -
Backhouse, Mrs. Ed.	1 1 -

	£.	s.	d.
Backhouse, Edmund, Esq.	2	2	-
Borne, Lord	3	3	-
Clarke, G. Esq. (in memory of)	1	1	-
Garbutt, E. W. Esq.	1	1	-
Dale, Sir David	1	1	-
Gladstone, Arthur, Esq.	1	1	-
Hodgkin, J. B. Esq.	1	1	-
Hull, Blyth & Co.	1	1	-
Hunter, Rev. C.	1	1	-
Lawson, The Misses	2	2	-
Mounsey, E. B. Esq.	2	2	-
Phillips, T. Esq.	10	0	-
Stmpson, H., Esq.	1	1	-
Tilly, Mrs.	1	1	-
Tilly, T. Harry, Esq.	1	1	-
Total Subs.	27	11	

Donations.

Collected at Volunteer Review 5 - -

Church and Chapel Collections ("Life-Boat Sunday") 6 14 -

Total Dons. 11 14 -

Total Subs. 27 11 -

£39 5 -

SUNDERLAND BRANCH.

Local Committee—
 Col. REED, J.P., Chairman.
 Rev. J. B. BARTON.
 G. BUTCHART, Esq.
 FAIRLEY DOWNES, Esq.
 J. HOPPER, Esq.
 R. HUMBLE, Esq.
 R. T. NICHOLSON, Esq.
 T. STOCKDALE, Esq.
 J. TAYLOR, Esq.
 H. H. WAKE, Esq.
 THE COLLECTOR OF H.M. CUSTOMS.
 THE CHIEF OFFICER OF H.M. COASTGUARD (Capt. E. A. LESLIE, R.N.).

Honorary Secretary and Treasurer—
 FRED O. PINKNEY, Esq.,
 55, John Street, Sunderland.

Collector—
 Mr. DOUGLAS RENNISON.

Annual Subscriptions.

Anderson, Horan, & Co., Messrs.	5	-	-
Armstrong, Addison & Co., Messrs.	1	1	-
Austin, S. P. & Son, Limited	1	1	-
Backhouse and Co., Messrs.	1	1	-
Bartram & Sons, Messrs.	1	1	-
Barwick, J. S. Esq., J.P.	3	7	-
Blumer & Co. Messrs.	5	-	-
Booth, G. R. Esq. J.P.	10	6	-
Bramwell and Co., Messrs.	1	1	-
Briggs, Wm. & Sons, Messrs.	10	6	-
Broderick, J.W. Esq.	5	-	-
Clark, Henry, Esq.	10	6	-
Craven and Speeding Bros., Messrs.	1	-	-
Davidson, R. G. Esq.	5	-	-
Dickinson, J. & Sons	10	6	-
Dixon, J. B. & Co.	10	6	-

	£.	s.	d.
Doxford, Wm. & Sons, Limited	1	1	-
Durham, Right Hon. Earl of	2	2	-
Elliot, Thomas, and Son, Messrs.	10	0	-
Fenwick, Arthur, Esq. J.P.	1	1	-
Fenwick, Robt. & Co., Messrs.	1	1	-
Gayner, R. H. Esq. J.P.	1	1	-
Grimshaw W. and Sons, Messrs.	10	0	-
Harrison, W. B. Esq.	10	6	-
Hill, J. G. Esq.	10	6	-
Laing, Sir James, J.P.	1	1	-
Laing and Co. Messrs.	5	-	-
Lambton and Co., Messrs.	1	1	-
Lumadon, Byers, and Co. Messrs.	1	1	-
Morton, H. T. Esq., J.P.	10	6	-
Mounsey, Misses.	10	0	-
Newcastle Breweries, Ltd.	1	1	-
Pemberton, R. L. Esq., J.P.	1	1	-
Porrett, Mrs.	5	-	-
Pumphrey, T. E. Esq., J.P.	10	6	-
Reed, Colonel, J.P.	1	1	-
Richardson, S. Esq., J.P.	10	6	-
Ritson, John & Sons, Messrs.	5	-	-
Robinson, G. H. Esq.	5	-	-
Robson, E. C. & Sons, Messrs.	10	0	-
Sanderson, W. Esq. J.P.	5	-	-
Service and Phillips, Messrs.	5	-	-
Shadforth, Alderman Robt., J.P.	1	-	-
Short Bros., Messrs.	10	6	-
Steel, Thomas, Esq., J.P.	5	-	-
Stobart, William, Esq., J.P.	10	0	-
Taylor & Sanderson, Messrs.	1	1	-
Thompson, J. L. and Sons, Messrs.	1	1	-
Fone, William, Esq.	10	6	-
Gyzack & Branfoot, Messrs.	1	10	0
Vaux, C. and Sons, Messrs.	5	-	-
Wilson, C. Stanfield, Esq.	10	6	-
Woods & Co. Messrs.	1	1	-
Total	£40	2	6

Donations.

Contribution Boxes, 1 12 -

Sundry Donations, per H.M. Customs 98 9 5

Total Dons. 100 1 5

Total Subs. 40 2 6

£140 3 11

TEESDALE BRANCH.

Local Committee—
 Lieut.-Gen. BLAIR, C.B., V.C. Chairman.
 G. A. WALKER, Esq., M.P. Rev. A. W. M. CLOSE, Hon. Secretary and Treasurer.

Annual Subscriptions.

Blair, Lieut.-Gen., C.B., V.C.	1	1	-
--------------------------------	---	---	---

	£.	s.	d.
Close, Rev. A. W. M.	5	-	-
Easton, Miss.	5	-	-
Parker, Miss.	5	-	-
Walker, Dr.	10	-	-
Sums under 5s.	17	6	-
Total	£27	18	6

Donations.

Harvest Thauks-giving at Barningham Church 2 11 1

Life-boat Box (Thorpe Hall) 9 - -

Life-boat Sunday, Hutton Magna Church 1 3 6

Sums under 5s. 3 7 -

Total Dons. 4 7 2

Total Subs. 7 18 6

£12 5 8

WEST HARTLEPOOL BRANCH.

JOHN BLAND, Esq., J.P., Chairman.

T. APFLEBY, Esq., J.P.
 T. BARNACLOUGH, Esq.
 J. P. FEA, Esq.
 Sir W. GRAY, Knt., J.P.
 G. HODGSON, Esq.
 R. HOOPER, Esq.
 R. IRVINE, Esq., Jun.
 W. H. KINCH, Esq., C.E.
 W. MACLEAM, Esq., J.P.
 R. MURRAY, Esq., C.E., J.P.
 T. POUNDER, Esq.
 G. PYMAN, Jun., Esq., J.P.
 T. ROBINSON, Esq., J.P.
 R. ROPNER, Esq., J.P.
 Capt. W. WATSON.
 Chief Officer Coastguard (G. E. CHURCH, Esq.).
 Collector of H.M. Customs (J. W. HAY, Esq.).

Honorary Secretary—
 JOHN N. TAYLOR.

Annual Subscriptions.

Appley & Co. T., Messrs.	1	1	-
Beck, F. L. Esq.	1	1	-
Blacklin, J., Esq.	5	-	-
Bland, J. Esq., J.P.	10	6	-
Brown, C. Esq.	5	-	-
Cameron & Co. Ltd., Messrs. J. W.	1	1	-
Casebourne & Co. Ltd.	5	-	-
Casper & Co., Messrs.	10	6	-
Chalton, Ley, Esq.	5	-	-
Crosby, Magee & Co., Messrs.	10	6	-
East Coast Insurance Association (G. J. H. Hogg)	1	1	-
Fisher, W. H. Esq., J.P.	10	6	-
Fryer, E. Esq.	5	-	-
Furness, Withy & Co., Ltd., Messrs.	1	1	-
Gladstone & Cornforth, Messrs.	10	6	-
Gray, Sir W. & Co., Ltd., Messrs.	2	2	-
Harland & Co., Messrs. G. B.	5	-	-
Herskind & Co. Messrs.	10	6	-
Horsley & Son, Messrs. Geo.	1	1	-

	£.	s.	d.
Irvine & Co., M. ssrs.	1	1	-
R.	1	1	-
Jones, Geo. Esq.	19	-	-
Kinch, W. H. Esq., C.E.	5	-	-
Lauder & Co., Messrs. R.	10	6	-
Lilly & Co., Messrs. J.	10	6	-
Livingston, Conner & Co., Messrs.	18	6	-
Maclean, Doughty & Co., Messrs.	1	1	-
Merryweather & Co., Messrs. J.	10	6	-
Murray, R. Esq., J.P.	10	6	-
Pease & Partners, Ltd., Messrs.	1	1	-
Pyman & Co., Messrs. G.	1	1	-
Rickinson & Son, Messrs. M.	10	6	-
Robinson & Co., Messrs. R. W.	5	-	-
Robinson, Sons & Co., Messrs. T.	10	0	-
Ropner & Co., Messrs. I.	1	1	-
Seaton Carew Iron Co. Ltd.	1	1	-
Swanwick, Dr.	10	6	-
Sykes, Rev. E., M.A.	5	-	-
Trechmann Bros., Messrs.	1	1	-
Wade, Sons & Co., Messrs. R.	1	1	-
West Hartlepool Steam Navigation Co.	1	1	-
Wilson & Co., Messrs. J. F.	10	6	-
Wood & Co., Messrs. J.	1	1	-
Total	£29	9	6

Donations.

Collected at the Dock Office 42 6 3

Collected on board s.s. *Middlebro*, of Middlebro', per Capt. Stephenson 6 6

Contribution Box at Dock Head 2 3

Total Dons. 42 15 -

Total Subs. 29 9 6

£72 4 6

WHITBURN BRANCH.

Local Committee—
 Sir HELOWORTH WILLIAMSON, Bart., Chairman.
 Mr. W. A. BOWMAN.
 Mr. Wm. JOHNSON.
 Rev. G. F. PRICE, D.D.
 Mr. JOSEPH SMITH.
 Mr. W. THINKLER.

Hon. Secretary—
 W. H. WILLIAMSON, Esq.

Annual Subscriptions.

Barnes, Mrs.	3	3	-
Bowman, W. A. Esq.	10	-	-
Dawson, Wm. Esq.	1	1	-
Fox, Rev. H. E. (Durham)	1	1	-
Haggie, P. S. Esq.	2	2	-
Johnson, W.	5	-	-
Price, Rev. G. F., D.D.	1	1	-
Smith, Joseph.	10	-	-

	£.	s.	d.
Thompson, R. Esq.	1	1	-
Tinkler, W.	5	-	-
Williamson, Sir H., Bart.	4	-	-
Williamson, W. H. Esq.	2	2	-
Woodcock Charitable Institution Fund, per Ch. Wright, Esq., Sunderland.	2	13	1
Total	£19	14	1

Donations.

Contributions	6	7	6
Contribution Boxes, &c.	6	4	11
"Life-boat Saturday" collection	2	18	-
Total Dons.	15	10	5
Total Subs.	19	14	1
	£35	4	6



CLACTON-ON-SEA BRANCH.

President—
The Rt. Hon. the EARL OF WARWICK.

Vice-President—
Sir JOHN H. JOHNSON.

Local Committee—
J. AS. HARMAN, Esq., Chairman.
F. COLLINS, Esq.
E. B. DAWSON, Esq.
Rev. C. J. GAYLER.
ORLANDO HARMAN, Esq.
Mr. HAZELL, Chief Officer
Coastguard.
R. G. HURELL, Esq.
Mr. ROBERT LEGERTON.
J. MANN, Esq.
Dr. MURRAY.
C. TIGHE, Esq.
T. URSDELL, Esq.

Honorary Secretary—
F. W. LEWELLEN, Esq.

Annual Subscriptions.

	£.	s.	d.
Chamberlayne, A. R. Esq.	1	1	-
Christie, Mrs.	1	1	-
Clark, A. Esq., F.C.S.	10	6	-
Collins, F. Esq.	10	6	-
Dawson, E. B. Esq.	10	6	-
Ellis, James, Esq.	10	6	-
Finch, W. Esq.	10	6	-
Furniss, T. Esq.	1	-	-
Furniss, Mrs.	10	-	-
Furniss, Miss	5	-	-
Gayler, Rev. C. J.	1	1	-
Gurneys, Round, Green & Co.	1	1	-
Harmar, J. Esq.	1	1	-
Harmar Bros.	10	6	-
Hudson, Matthews, and Co.	1	1	-
Johnson, Sir John H.	2	2	-
Kitching, A. G. Esq., J.P.	10	6	-
Kitching, The Misses	12	6	-
Knight, Mrs.	10	6	-
Lewellen & Co.	10	6	-
Mackenzie, D. Esq.	10	6	-
Mitchell, J. Esq.	10	6	-
Murray, Dr.	10	6	-
Penfold, A. Esq.	10	6	-
Purvis, G. Esq.	1	1	-

	£.	s.	d.
Round, J. Esq., M.P.	1	1	-
Scholte, Mrs. F.P.	10	6	-
Stephens, C. J. Esq., J.P.	1	1	-
Tabrum and Jones	10	6	-
Tighe, C. Esq.	1	1	-
Topp, J. Esq.	10	6	-
Ursdell, T. Esq.	10	6	-
Wallis, Mrs. Fredk.	10	6	-
Young, T. Esq.	1	1	-
Total	£25	9	6

Donations.

Green, P. Esq., Magic Lantern Entertainments	1	5	6
Pier Co. Concert	14	19	9
Player, Misses, Concert	3	13	3
Total Dons.	19	18	6
Total Subs.	25	9	6
	£45	8	-

COLCHESTER BRANCH.

(No Local Committee.)

Honorary Secretary.

Bankers—
Messrs. GURNEYS, ROUND, GREEN & Co.

1895.

Annual Subscriptions.

Colchester and East Essex Co-operative and Industrial Society, Ltd. 2 2 -

Donations.

Net Proceeds of Amateur Concert by the Excelsior Choir, per Mr. G. Woodthorpe 2 19 10
Other sums 15 - -
Total **£5 16 10**

HARWICH BRANCH.

Local Committee—

Mr. ANABONA, Chief Officer, Coastguard.
R. S. BARNES, Esq.
S. EVANS, Esq.
W. GROOM, Esq.
JAMES N. JUSTICE, Esq.
E. RUSSELL, Esq., Collector of Customs.
Lieut. WILSON, R.N., Divisional Officer, Coastguard.

Honorary Secretary—
JOHN PATERSON, Esq.

Annual Subscriptions.

Barnes, R. S. Esq. 10 6
Bevan, C. F. Esq. 10 -
Collisson, C. F. Esq. 1 1 6
Cottingham, F. Esq. 10 6
Eley, Chas. Esq. 1 1 -
Evans, S. Esq. 1 1 -
Evans, Mrs. 10 6
Foster, Mrs. Osborne - 5 -
Groom, W. Esq. 1 1 -
Jacoby, W. Esq. 5 -

	£.	s.	d.
Jervis, H. J. W. Esq.	1	1	-
Justice, J. N. Esq.	10	6	-
Nalborough, W. J. Esq.	10	6	-
Patrick, J. R. Esq.	1	1	-
Royal Harwich Yacht Club	2	2	-
Wilson, Lieut. R.N.	10	6	-
Total Subs.	£12	11	-

Donations.

Collecting Boxes	5	1	-
Dovercourt "Life-boat Saturday," per Misses Nalborough	30	-	-
Total	£42	16	1

SOUTHEND BRANCH.

Local Committee—
C. WOOSNAM, Esq., Chairman, J.P.

Major A. E. BALDWIN.
Councillor J. R. BRIGHTWELL, J.P.

H. BROWN, Esq.
Councillor W. J. CHIGNELL.
Alderman T. DOWSETT, J.P.

Councillor J. C. HUDSON, J.P.

W. GREGSON, Esq., Town Clerk.
Capt. KELLY.
H. LUKER, Esq.
JAMES RICHMOND, Esq.
Lieut. WILLIAMSON, R.N.

Honorary Secretary—
GEO. S. MANUELLE, Esq.

Annual Subscriptions.

Baldwin, Mrs. J. 10 6
Baldwin, Major A. E. 10 6
Boyc, Mr. W. 1 1 -
Brightwell, J. R., Councillor, J.P. 10 6
Brown, Mr. Hy. 1 1 -
Burdett, Mr. J. 10 6
Deeping, Dr. G. D., J.P. 10 6
Dowsett, Thos., Alderman J.P. 10 6
Gregson, F. 10 6
Gregson, Wm., Town Clerk. 10 6
Howard, Ald. J. B., J.P. 10 6
Hudson, J. C., Councillor J.P. 1 1 -
Kernahan, Mr. Coulson 10 6
Luker, Mr. Hy. 10 6
Manuelle, Mrs. 1 1 -
Manuelle, Miss 10 6
Richmond, Mr. Jas. 10 6
Tyler, Mrs. W. 10 6
Vandervord, Messrs. G. & E. 10 6
Waters, Mr. Saml. 2 - -
Wise, Mr. W. Lloyd, J.P., C.C. 10 6
Webster, Mr. Joseph 10 6
Woosnam, Mr. Chas. J.P. 10 6
Purvis, M. H. J. 1 1 -
Total **£16 14 -**

Donations.

Alexandra Yacht Club, per Mr. H. J. Purvis. 2 2 -

	£.	s.	d.
Balance from Dog Sh w, per Mr. A. Harrington	1	2	1
Benefit Football Match	2	15	-
Campbell, Mr. R. B.	1	1	-
Clark, Mr. W.	10	-	-
Collected at "Old Ship," Rochford, on Boxing Day	-	11	-
Davis, Mr. Mark	1	1	-
Ellen, Mr.	1	1	-
Fowler, Mr. W.	1	1	-
Friendly Societies Church Parade	3	8	3
Gammage & Hollingum, Messrs.	1	1	-
Glover, Mr. F.	1	1	-
Hewett, Mr. J.	10	6	-
Pettitt, Mr. Z.	10	6	-
Richardson, Mr.	1	1	-
Skinner, Mr. A. E.	1	1	-
Vernon, Dr.	10	6	-
Walker, Howard & Co., Messrs.	1	1	-
Walker, Mr. J.	1	1	-
Waterman, Mr.	1	1	-
Willes, Mr. W. E.	1	1	-
Wood, Mr. F.	1	1	-
Young, Mr. J.	10	6	-
Collecting Boxes	12	14	5
Total Dons.	38	17	9
Total Subs.	16	14	-
	£55	11	9

WALTON-ON-THE-NAZE BRANCH.

President—
Colonel R. P. DAVIS, J.P.

Local Committee—
Mr. BOTHAM.
Mr. DAVIS.
Mr. EAGLE, J.P.
Mr. HOWE.

Treasurer—
J. W. EAGLE, Esq. J.P.

Honorary Secretary—
Rev. J. T. COOKE.

Annual Subscriptions.

Barclay & Co. 1 1 -
Craven, Rev. Dacre. 1 - -
Davie, Mr. 5 - -
Davis, Col., J.P. 1 - -
Eagle, Mr. J. W. J.P. 1 1 -
Johnson, Sir J. H. 2 2 -
Palmer, Mr. S. R. 5 - -
Round, Mr. James, M.P. 1 1 -
Taylor, Mrs. John. 5 - -
Walker, Miss. 1 - -
Wood, Mrs. Angell. 10 6
Total **£9 10 6**

Donations.

Life-boat Boxes 5 5 3
Ditto, per Mr. J. M. Burr 1 14 8
"Life-boat Day" .. 6 19 6
Total Dons. **13 19 5**
Total Subs. **9 10 6**
£23 9 11

Flintshire.

POINT OF AYR BRANCH.

Honorary Secretary—
C. BATTERS, Esq.
(No List for 1896.)

RHYL BRANCH.

President—
H. R. HUGHES, Esq., L.L. of
Flintshire.

Local Committee—
T. GRIFFIES DIXON, Esq.,
Chairman.

J. AIDNEY, Esq.
R. H. WROE COCROFT, Esq.
JOHN FOULKES, Esq.
G. F. GUNNER, Esq.
ROBERT HUGHES, Esq.
J. FISHER JONES, Esq.
C. W. JONES, Esq.
ROBERT JONES, Esq.
Capt. E. W. KEATINGE, J.P.
E. L. PUGH, Esq.
Capt. STUBBS.
Capt. VEALE.
Capt. WILDERS.

Treasurers—
NORTH AND SOUTH WALES
BANK.

Honorary Secretary—
J. PIERCE-LEWIS, Esq.
Solicitor, Town Hall, Rhyll.

Annual Subscriptions.

	£.	s.	d.
Aidney, J., Esq.	5	-	-
Buddicom, H. W., Esq.	2	-	-
Day, S., Esq.	5	-	-
De Rance, Mrs.	1	1	-
Dixon, T. Griffies, Esq.	1	1	-
Dundonald, Countess of	5	-	-
Foulkes, John, Esq.	5	-	-
Gladstone, Rev. S. E.	10	-	-
Hughes, H. R., Esq.	5	-	-
Kimmel, W., Esq.	5	-	-
Johnson, G., Esq., Bang 1 (2 years)	10	-	-
Lewie, Mr. Charles, Plas yn Cwm, St. Asaph	1	1	-
Meslam, Col.	10	-	-
Pennant, P. P., Esq.	1	-	-
Sneyd, Miss	1	-	-
Snowden, Chas., Esq.	5	-	-
Stubbs, Capt.	10	-	-
Wilkin, W., Esq.	1	1	-
Williams, Rev. T., Dean of St. Asaph	1	1	-
Williams, Miss S. A.	1	1	-
Wood, Jos., Esq.	1	1	-
Wynn, Mrs. A.	1	-	-
Williams, Cefn	1	1	-
Total	£25	8	-

Donations.

Wynne-Jones, Capt.	
E. D.	1 1
Collection Boxes—	
Alexandra Hotel	10 3
Bellamy, Mrs.	
River St.	7 3
Chilwell, Miss	
Winnie	7 2

	£.	s.	d.
Hollingsworth, Masters Chas. & Edw., Wolver- hampton	10	2	-
Hidge, Miss and Master, Wolver- hampton	10	-	-
Imperial Hotel	5	-	-
Ludlow, Master E. and Miss Eva	7	6	-
Mackie, Master Andrew & Miss Nellie, Longton	13	-	-
Mitchell, Mrs., Plastrion, Rhyll	13	6	-
Parade Pillar Box	3	11	10
Rushbrook, Master G. H. & Friends	15	-	-
Williams, Miss S. A., Clwyda, St. Asaph	13	2	-
Wooliatt, Master W. & Miss Amy, Derby	6	7	-
Sums under 5s.	4	12	9
Total Dons.	15	4	2
Total Subs.	25	8	-
	£10	12	2

Glamorganshire.

CARDIFF AND PENARTH BRANCH.

Patron—
RT. HON. LORD WINDSOR.

Local Committee—
MR. VALENTINE TRAYES, J.P.
Chairman.
MR. A. BEASLEY.
Colonel GUTHRIE, J.P.
MR. ALFRED HOLMAN.
Capt. ROSSER.
Major A. THORNLEY, J.P.
The Chief Officer Coastguard,
Penarth (ex officio).

Treasurer—
MR. SAMUEL THOMAS,
Penarth Dock.

Honorary Secretary—
H. J. VELLACOTT, Esq.

Annual Subscriptions.

	£.	s.	d.
A. D. A.	5	-	-
Adams & Wilson	5	-	-
Andrews, S. and Son	10	6	-
Anning Bros.	5	-	-
Arnell, Mr. H.	5	-	-
Beynon, T. & Co.	5	-	-
Brain, S. A. & Co.	1	1	-
Brown, Foster and Rees	1	1	-
Burness, Jas. & Sons	1	1	-
Burnyeat, Brown & Co.	10	6	-
Bute, Marquis of	10	-	-
Chambers, Mr. W. H.	5	-	-
Chelwell & Hodges	5	-	-
Christie & Co.	10	6	-
Cloake, Capt. H.	5	-	-
Collings, W. Jun.	5	-	-
Cope, Matthew	10	6	-

	£.	s.	d.
Cory Bros. and Co., Limited	2	2	-
Cory, J. and Sons	1	1	-
Davis, D. & Sons, Ltd.	1	1	-
Downing, E. C.	5	-	-
Duncan, J. T. & Co.	10	6	-
Evans, C. E. & Co.	5	-	-
Fisher, Renwick & Co.	5	-	-
Foster, Hain & Co.	5	-	-
Frazer and Co.	10	6	-
Gibbs & Lee	5	-	-
Gibson, Bros.	5	-	-
Great Western Col- liery Co.	5	-	-
Gueret, L. & H.	10	-	-
Guthrie, Heywood & Co.	10	6	-
Hacquoit, J. & Co.	10	6	-
Hall Brothers	5	-	-
Hardy, Wilson & Proctor	5	-	-
Harrison, Moore and Moore	10	6	-
Hill, Col. Sir E. S., K.C.B., M.P.	1	1	-
Hurley, Matthews & Co.	5	-	-
Huxtable, W. D.	5	-	-
Insole, G. and Sons	1	1	-
Jam's, R. W. and Co.	10	6	-
Johnston, Mr. S. D.	5	-	-
Jotham and Sons	5	-	-
Krueger & Schliemann	5	-	-
Lee, Finch, & Co.	5	-	-
Lewis' Merthyr Coal Co.	10	6	-
Lucovich, A. T.	10	6	-
Locket's Merthyr Coal Co.	5	-	-
Martin & Marquand	5	-	-
Marychurch, J. & Co.	1	1	-
Morel Bros. & Co.	10	6	-
Nell, Dr. R. F.	10	6	-
Nixon's Navigation Coal Co.	1	1	-
Ocean Coal Co.	1	1	-
Osborn & Wallis	5	-	-
Page, Col.	1	1	-
Powell, Duffryn Coal Co.	1	1	-
Prie, W. & Son	5	-	-
Pyman, Watson, and Co.	10	6	-
Radford, D. & Co.	5	-	-
Rea, R. & J. H.	10	6	-
Richards, Mr. D.	5	-	-
Rous, Miss	1	1	-
Spillers & Bakers, Ltd.	1	1	-
Stephens, Mawson and Goss	5	-	-
Stephens, T. H.	10	6	-
Stowe, Mr. R. L.	5	-	-
Taylor, W. H. & Co.	10	6	-
Tellefsen and Co.	10	6	-
Thomas, E., Radcliffe & Co.	10	6	-
Thomas, S. (2 years)	10	-	-
Thomas, W. & Co.	5	-	-
Thompson, Chas. (2 years)	2	-	-
Thompson, Mr. G. Carlslake, L.L.M.	5	-	-
Thompson, Herb. M. I. cott	1	-	-
Thompson, H. Wool-			
Thomson, Captain A.	5	-	-
Tillet, W. J. & Co.	10	6	-
Todd, Mr. R. R.	5	-	-
Trayes, Mr. Valen- tine	1	1	-
Troedyrhew Coal Co.	10	6	-
Turnbull Bros.	10	6	-
Taylor and Lewis	10	6	-
Vellacott, Mr. H. J.	5	-	-
Wain, Mr. R.	5	-	-
Wills, G. H. & Co.	10	6	-
Windsor, Lord	2	-	-
Worms and Co.	1	1	-
Sums under 5s.	5	-	-
Total	£8	15	6

Donations, &c.

	£.	s.	d.
Cardiff Oddfellows	1	1	-
Collection at Penarth			
Yacht Club Regatta	15	5	-
Reimbursement, from J. Vaughan, from Parent Society	10	-	-
Boxes:—			
Cardiff Docks Con- servative Club	1	11	9
Cardiff M. M.			
Office	1	8	6
Penarth Dock Pillar	9	-	-
Penarth M. M.			
Office	3	10	8
Boxes under 5s.	10	11	-
Total Dons.	10	17	3
Total Subs.	58	15	6
	£69	12	9

PORHCRAWL BRANCH.

Local Committee—

J. BROGDEN, Esq.
E. BREFFITT, Esq.
E. DAVID, Esq.
Rev. R. W. GORDON.
Rev. W. JONES.
F. ROGERS, Esq.
W. SCRIVENER, Esq.
Col. J. PICTON TURBERVILLE.
T. WILSON, Esq.

Honorary Secretary—
JOHN GRACE, Esq.

Annual Subscriptions.

Bute, The Marquis of	5	-	-
Clark, G. T., Esq.	1	-	-
Connop, Harry, Esq.	1	1	-
Dunraven, Earl	5	-	-
Guest, the Hon. Ivor	5	5	-
Gwyn, Mrs. Howell	1	1	-
Knox, Mrs. E. (two years, 1895-6)	2	2	-
Morris, Mrs. G. Ryng	1	-	-
Talbot, Miss	2	2	-
Traherne, Major	1	1	-
Turberville, Col.	1	1	-
Turberville, Mrs.			
Picton	1	1	-
Wilson, Thos., Esq.	10	6	-
Total	£27	4	6

Donations.

Ashman, Mr. Wm.	1	-	-
Box at—			
Esplanade Hotel	13	10	-
Portcawl Hotel	10	1	-
Post Office	4	6	-
Rock Hotel	2	6	-
Braithwaite, Miss	5	-	-
Friendly Societies			
Demonstration	6	9	2
Pillar-box, Esplanade	1	9	6

Total Dons.	9	15	7
Total Subs.	27	4	6
	£37	-	1

SWANSEA AND PORT EYNON BRANCH.

Local Committee—

R. BECK.
E. H. BOWERS.
W. R. COLLINS.
Capt. ELIAS, R.N.
E. B. HAYNES.
E. C. NETTELL.
T. N. T. STRICK.
P. L. THOMAS.

Honorary Secretary—
T. W. ISLAY YOUNG.

Assistant Secretary for Port
Eynon—
C. BEVAN.

Annual Subscriptions.

	£.	s.	d.
Bath, Henry & Son	2	2	-
Beck, R.	1	1	-
Bostock, Miss	-	10	-
Bradford, F.	-	10	6
Bristol Channel Yacht Club	1	1	-
Burgess & Co.	1	1	-
Chalk, H.	1	1	-
Cook, G. E.	-	10	6
Cory, T.	1	1	-
Collins, W. B.	1	1	-
Davies, Rev. J. D.	-	10	-
Davies, Morgan W.	-	5	-
Davies, V. P.	-	10	6
Evans, B.	1	1	-
Evans, J. Moy	-	10	6
Gilbertson, W. & Co.	1	1	-
Goldberg & Sons	-	10	6
Hall, Joseph	1	1	-
Haynes, G. B.	-	10	6
Hedley, H. M.	-	5	-
James, T. W.	-	10	6
Jenkins, Sir J. J.	1	1	-
Jenkins, Dd.	-	10	6
Launder, W.	-	10	6
Létrichoux & David	-	10	6
Llewellyn, Sir J. T. D., Bart.	1	1	-
Melland, Miss	-	10	6
Melland, Rev. W.	-	10	6
Meanier & Co.	-	10	6
Nettell, E. C.	-	10	6
Peel, C. E. & H. M.	1	1	-
Penrice, T.	1	1	-
Rawlings, Dr.	-	5	-
Richards, L. M.	-	5	-
Richards, T. P.	1	1	-
Richardson, J. C.	1	1	-
Richardson & Co.	2	2	-
Swansea, Lord.	1	1	-
Swansea United Brewers, Ltd.	-	10	6
Talbot, Miss	1	1	-
Thomas, Mrs. Ildid	1	1	-
Thomas, Watkins, & Co.	-	10	6
Trustees of Swansea Harbour	50	-	-
Tulloch, L.	-	10	6
Vivian, Hon. A.	-	10	-
Vivian, W. G.	1	1	-
Walters, Nash & Co.	-	10	6
Wedlake, Towers & Co.	-	10	6
Williams, Wm. & Co.	1	1	-
Yeo, F. C.	-	5	-
Young, T. W. Islay	-	10	6
Total	£88	5	-

Donations.

Boxes—			
Castle Hotel	14	-	-
Port Eynon	17	-	-
Collections, per—			
Hughes, James	1	7	6
Lucas, Miss	1	1	-
Pillar Box at Mumbles	1	-	3
Simons, Mrs. & the Misses	3	1	-
Total Dons.	8	-	9
Total Subs.	£88	5	-
	£86	5	9

Gloucestershire.

BRISTOL BRANCH.

(No Local Committee.)

Chairman—
MARK WHITWILL, Esq.

Hon. Treasurer—
W. H. FRANK, Esq.,
Shannon Court, Corn Street.

Annual Subscriptions.

	£.	s.	d.
Brdminster Co-operative Society	1	1	-
Goody, Cripps, & Co.	1	1	-
Grace, J. & H.	-	10	6
Hill, C. & Sons	2	2	-
Jecks, Charles	-	10	-
King, R. & W.	1	1	-
Lavington, C. E.	-	10	-
McArthur, Nash & Co.	1	1	-
Phillips, A., the late	1	1	-
Powell, W. & Sons	2	2	-
Society of Merchant Venturers	10	10	-
Strickland, N.	-	10	6
Terrell, W. & Sons, Limited	1	1	-
Thomas, C. & Bros., Limited	1	1	-
Wansey, A. H.	1	1	-
Whitwill, M. & Son	1	1	-
Wills, W. M.	-	10	6
Total	£26	14	6

Donations.

Boxes—			
Albion Hotel, Prince Street	10	-	-
Bank Hotel, Bridge Street	13	-	9
Bathurst Hotel, per Mr. Ireland	1	-	7
Bristol Station	1	1	6
Bunch of Grapes, per Mr. Whittaker	5	2	-
Custom House	5	1	-
Dunlop, Mackie & Co. Messrs.	16	5	-
Imperial Fire Office	7	6	-
Merchant's Arms, per Mrs. Folkes	6	10	-
Oliver & Son, per J. Brookman	16	6	-
Priory Restaurant, Drawbridge	7	4	-
Royal Hotel, Avonmouth	6	8	-
Royal Oak, Priuce Street	5	9	-
Steam Packet, Hotwell Road	6	-	-
Thatched House, Hotwells	7	-	-
White, Mr., Navigation School	7	5	-
Sums under 5s.	2	8	11
Total Dons	11	12	5
Total Subs.	£26	14	6
	£38	6	11

CHELTENHAM BRANCH.

President—
W. N. SKILLICORNE, Esq.

Local Committee—
Admiral CHRISTIAN.

Hon. Secretary—
Captain G. E. HODGSON.

Collector—
Mr. A. E. DANGERFIELD.

Annual Subscriptions.

	£.	s.	d.
Baker, W. M. Esq.	1	1	-
Cavendish House Company (Limited)	10	-	-
C. C. W.	1	-	-
Cox, Mrs. James	1	1	-
Christian, Admiral	-	10	-
Colledge, Major	-	10	-
Cookes, Mrs.	1	-	-
Dickerson, Miss	1	1	-
Evans, J. Bowle, Esq.	-	10	-
F. B.	5	-	-
Ford, Mrs. St. Clair	-	10	6
Gardner, Rev. G.	-	10	-
Gardner, J. T. Agg.	-	10	-
Gardner, W. Esq.	-	10	-
Goodwyn, J. W. Esq.	1	1	-
Hawkins, Miss	-	10	-
Henry, Miss E.	-	10	-
Hodgson, Capt. G. E.	1	1	-
Kay, Sir Brook, Bart.	-	10	6
Lance, John & Co., Messrs.	-	5	-
Maitly, Mrs.	-	5	-
Martin & Co. Messrs.	-	10	-
Mil'e, Mrs. Murray	5	-	-
Plant, Thos. & Co.	-	5	-
Sharpe, Messrs. W. & Son	-	5	-
Shirer and Haddon, Messrs.	-	10	-
Skillicorne, W. N. Esq.	-	10	-
Ticehurst, R. Esq.	-	10	-
Voile, Thomas & Co.	-	10	-
Warter, Mrs.	-	10	-
Whitehouse, Miss	-	10	-
Young, The Misses	1	-	-
Total Subs.	£23	11	-

Donations.

Boxes	7	-	-
Total	£23	13	-

Hampshire.

HAYLING ISLAND BRANCH.

Local Committee—
Lieut.-Colonel T. S. WALFORD,
Chairman.

E. C. DOWLEY, Esq.
W. J. HOWLE, Officer,
Coastguard.

W. GANN, Esq.
C. J. PARK, Esq.
D. E. ELLIS, Esq.

Hon. Secretary—
Mr. H. R. TRIGG.

Annual Subscriptions.

	£.	s.	d.
Bacon, Francis, Esq.	1	-	-
Blake, Mr. W. W.	-	5	-

	£.	s.	d.
Cave, L. T. Esq.	5	-	-
Craufurd, Sir C. Bart.	-	10	-
Dowley, E. C. Esq.	-	10	6
Ellis, Mr. D. E.	-	5	-
Fillis, Mr. R.	-	5	-
Gann, W. Esq.	-	10	6
Gloynne, W. Esq.	-	10	6
Menda, J. S. Esq.	1	1	-
Mundy, Lady J. L.	-	10	-
Padwick, F. W. Esq.	1	1	-
Padwick, Miss J. M.	1	1	-
Park, C. J. Esq.	-	1	-
Proctor, Rev. F. O.	-	10	-
Pullen, Mr. C.	-	5	-
Reddaway, J. G. W. Esq.	-	10	6
Tatchell, A. G. Esq.	-	10	6
Trigg, Mr. H. R.	-	10	6
Walford, Col. T. S.	-	10	-
Watson, P. Esq.	-	5	-
Total Subs.	16	12	-

Donations.

Contribution Boxes	7	4	6
Total	£23	16	6

PORTSMOUTH AND SOUTHSEA BRANCH.

President—
The Worshipful the MAYOR
OF PORTSMOUTH (GEORGE
E. COUZENS, Esq.).

Local Committee—
Commander LORD ROBERT T.
B. BRUCE, R.N.

The Worshipful the MAYOR
OF PORTSMOUTH.

Capt. W. H. FAWKNER, R.N.
J. S. HALL, Esq.

R. L. HODGES, Esq.
J. T. HYNES, Esq., Collector
of H.M. Customs.

Commander GEORGE IZAT,
R.N., Inspector
Commander of H.M. Coastguard.

Capt. H. J. LANCASTER.
L. A. VANDEBERGH, Esq.

C. VINE, Esq.
The Rt. Rev. J. VIRTUE, D.D.

Lord Bishop of Portsmouth.
PIERCE J. WHELDON, Esq.

Honorary Secretary—
WM. PAYNE, Esq. J.P.

Assistant Hon. Secretary—
J. HUGH PAYNE, Esq.

Annual Subscriptions.

Allnut, Sam. F. Esq.	5	-	-
Ash, S. Esq.	-	5	-
Austen, Rev. G.	-	10	-
Baldev, Rev. F.	-	5	-
Bathellor & Son	-	5	-
Beale, J. Esq.	-	5	-
Boughton, J. W. Esq.	-	5	-
Bruce, Rt. Hon. Lord Robert T. B., R.N.	-	10	-
Bull, Wm. Esq.	-	10	-
Chads, Adml. Sir H., K.C.B.	-	5	-
Chambers, The Misses	-	10	-
Cook, E. Esq.	-	5	-
Couzens, G. E. Esq.	-	5	-
Crampton, J. T. Esq.	-	10	6
Dunlop, Capt., R.N.	-	5	-
Dunning, Jno. Esq.	-	10	6
Fawkner, Capt.	-	-	-
W. H., R.N.	-	10	-
Ford, R. W. Esq.	-	5	-
Gillman, Wm. Esq.	-	10	-

	£.	s.	d.
Grant & Co., Messrs.	1	1	-
Harris, J. Esq.	10	6	-
Hodges, R. L. Esq.	10	6	-
Holbrook, Col.	10	-	-
Holdsworth, Miss.	10	6	-
Jephson, Major-Gen.	10	-	-
Sir S. W. Bart, C.B.	10	-	-
King, Sir Wm., J.P.	10	-	-
D.L.C.	10	-	-
Knott, Dr. Charles	5	-	-
Lancaster, Capt. H. J.	10	-	-
Langdale, Rev. J.	5	-	-
Leonard, His Honor Judge	1	1	-
Lush & Co., Messrs.	10	6	-
Lush, J. Esq.	10	-	-
Palmer, W. E. Esq.	5	-	-
Pares, John, Esq., J.P.	1	1	-
Payne, W., J.P.	5	-	-
Pike, Spicer, & Co. Messrs.	1	1	-
Power, Fred. Esq.	5	-	-
Protheroe, Thomas, Esq. (Clifton)	10	6	-
Read, John, Jun. Esq.	10	6	-
Read, W. Esq.	5	-	-
Reader, C. Esq.	5	-	-
Stokes, Capt., R.N.	1	-	-
Stokes & Co. Messrs., Wine Merchants (The Hard)	1	-	-
Tredgold, Mrs.	10	-	-
Vine, Charles, Esq.	5	-	-
Virtue, Right Rev. John, Bishop of Portsmouth	10	-	-
Voesper, H. E. Esq.	10	6	-
Williams, T. H. Esq.	10	6	-
Young, J. Esq.	10	6	-
Sums under 5s.	2	6	-
Total	£23	7	-

Donations.

Contribution Boxes, and Pillars	5	16	9
Total Dons	5	16	9
Total Subs.	23	7	-
	£29	3	9

SOUTHAMPTON BRANCH.

President—
THE MAYOR OF SOUTHAMPTON.

Local Committee—
 Admiral C. ROWLEY, Chairman.
 Colonel BUCKNILL.
 Admiral R. COOTE, C.B.
 Major EYRE CRABBE.
 J. DIXON, Esq.
 Colonel F. DUGMORE.
 P. ANDERTON GREENWOOD, Esq.
 Colonel O. GRIMSTON.
 R. C. HANKINSON, Esq.
 Sir O'BRYEN HOARE, Bart.
 J. H. HARRISON HOGGE, Esq.
 C. W. A. JELICOE, Esq.
 Colonel H. J. LENTHALL.
 G. Y. MERRICH, Esq.
 Admiral G. PARSONS.
 W. PERKINS, Esq.
 W. F. G. SPRANGER, Esq.

Treasurer—
 W. G. DAVY, Esq.

Honorary Secretary—
 Major A. MACQUEEN.

Annual Subscriptions.

	£.	s.	d.
Bance, Col.	10	-	-
Barlow, A. Esq.	10	-	-
Bevis, Capt. T. (the late)	1	1	-
Bucknill, Col.	10	-	-
Bridges, Colonel	1	1	-
Chamberlain, Gen.	1	-	-
Sir N. K.C.B.	1	-	-
Child, Capt.	1	-	-
Chipperfield, R. Esq.	1	1	-
Coles, Harry, Esq.	10	6	-
Cooper, Miss	1	-	-
Coote, Admiral, C.B.	10	6	-
Crabbe, Major Eyre	10	-	-
Darwin, W. E. Esq.	10	6	-
Davy, W. G. Esq.	10	-	-
Daw, J. Esq.	10	-	-
Day, Summers & Co. Messrs.	1	1	-
Dennys, Genl.	1	1	-
Dixon, J. Esq.	10	6	-
Dugmore, Col.	10	-	-
Dunlop, Archibald C. Esq.	1	1	-
Farquharson, Colonel, R. E., C.B.	10	6	-
Garret and Haysom, Messrs.	10	6	-
Garton, W. Esq.	2	2	-
Gayton, E. Esq. (The Mayor)	10	-	-
Glasspool, Mrs. W. H.	10	6	-
Green, H. G. Esq.	10	6	-
Greenwood, J. Anderson, Esq.	5	-	-
Grimston, Colonel	10	-	-
Hampshire Advertiser	10	6	-
Hankinson, R. C. Esq.	10	6	-
Harvey, Rev. J.	1	-	-
Hoare, Sir O'Bryen, Bart.	10	-	-
Hodgson, Mrs.	10	-	-
Hogge, J. H. Harrison, Esq.	10	6	-
Hooper and Ashby, Messrs.	5	-	-
Horseman, Mrs.	10	6	-
Jellicoe, C.W.A. Esq.	10	6	-
Jellicoe, S. J. G. Esq.	1	-	-
Lemon, J. Esq.	10	6	-
Lenthall, Col. R. J.	10	-	-
Litton, Mrs.	1	1	-
Macdonald, The Misses	10	-	-
Mackinnon, Charles, Esq.	1	1	-
Macqueen, Major A.	10	-	-
Martin, Admiral T. (the late)	10	-	-
Mercer, G. Y. Esq.	5	-	-
Napier and Son, Messrs.	5	-	-
Paris, Smith and Randall, Messrs.	10	6	-
Parker, Mrs. J. F.	10	-	-
Parsons, Admiral	10	-	-
Perkins, W. Esq.	10	6	-
Ramsay, William, Esq.	10	-	-
Randall, Sloper and Co. Messrs.	10	6	-
Rowley, Admiral C.	10	-	-
Sampson, J. King, Esq.	10	-	-
Shum, Miss E. H.	2	2	-
Smith, A. H. Esq.	1	1	-
Smith, C. Crowther, Esq.	1	1	-
Southampton St am Ship Coal Co.	1	1	-
Spranger, W. F. G. Esq.	10	-	-
Spooner, Albert, Esq.	1	1	-
Summers & Payne, Messrs.	5	-	-
Tagart, Morgan & Co., Limited	10	6	-
Thompson, Mrs. H. H.	10	-	-
Trend, Dr. Theophilus	10	6	-

Waller, J. Esq.	5	-	-
Wingrove, Mrs. M.A.	10	-	-
Total	£49	10	6

Donations.

Crown Hotel	11	7	-
Hunt, Miss	10	-	-
King's Arms	17	4	-
L. & S. W. Railway Co.'s Boxes and Pillars	3	2	3
Mariner's Arms	16	9	-
Marsh Hotel	10	-	-
N & P. Bank	12	3	-
Collecting Boxes:— Union Company's Steamers— Athenian	44	2	11
Gaul	11	16	6
Goth	13	7	8
Greek	27	13	5
Guelph	13	10	3
Mexican	60	2	3
Moor	27	2	8
Norman	453	9	11
Pretoria	23	19	7
Scot	20	8	6
Spartan	2	15	-
Tartar	94	17	9
Trojan	12	12	-
Isle of Wight Boats	2	12	5
Other boxes under 10s.	1	12	6
Bank interest	4	18	9
Total Dons	827	2	3
Total Subs.	49	10	6
	£876	12	9

Isle of Wight.

ISLE OF WIGHT BRANCH.

Patron—
 H.R.H. PRINCESS HENRY OF BATTENBERG, Governor of the Isle of Wight.

President—
 SIR CHARLES SEELY, Bart.

Vice-Presidents—
 R. H. ALEXANDER, Esq.
 F. W. BURNETT, Esq.
 Lt.-Gen. The Hon. SOMERSET J. G. CALTHORPE, J.P.
 Lord LAMINGTON.
 Rear-Admiral LOWTHER, R.N.
 THE MAYOR OF NEWPORT.
 J. RING, Esq.
 Capt. J. B. SEELY.
 Sir J. S. BARRINGTON SIMON, Bart., M.P., J.P.
 FRANS. W. SLADE, Esq.
 EDMUND GRANVILLE WARD, Esq., J.P.
 HENRY WARREN, Esq., J.P.
 Sir R. E. WESTER, Q.C., M.P., G.C.M.G.

Representative Committee—
 Mr. J. H. ATHEY.
 Mr. HERBERT BROWN.
 Mr. J. MULMAN BROWN.
 Capt. BURT.
 Col. R. P. CROZIER, J.P.
 Mr. F. DABELL.
 Mr. J. W. FISK.
 Mr. A. E. MARVIN.
 Mr. H. C. MILLS.
 Mr. DANIEL MORGAN.
 Mr. T. MORGAN.
 Mr. W. COLE NORMAN.

Capt. O. DELANO OSBORNE.
 Mr. HENRY WAY.
 Dr. WHITEHEAD, J.P.
 Mr. W. H. WOOLDRIDGE.

Hon. Auditor—
 JAMES GEORGE, Esq., J.P.

Hon. Surveyor—
 Mr. F. W. B. WATERWORTH.

Honorary Secretary—
 H. ELDRIDGE STRATTON, Esq.

Hon. Treasurer—
 Mr. HARRY SHEPARD, Newport, I.W.

Local Committees—
Brightstone Grange.

Mr. JAMES BUCKETT, Ex-Coxswain.
 Mr. H. FINLAY, Chief Officer H.M. Coastguard.
 Mr. J. W. FISK.
 Mr. G. HALL.
 Mr. GEORGE HOWARD.
 Mr. T. MORGAN.
 Mr. G. PARSONS.

Honorary Secretaries—
 Rev. Canon HEYGATE, M.A., Rector of Brightstone.
 Rev. G. E. JEANS, M.A., Rector of Motliston and Vicar of Shorwell.

Assistant Hon. Secretary—
 Rev. L. KNIGHTS SMITH, Curate of Brightstone.

Brooke.

SIR CHARLES SEELY, Bart., Chairman.
 Capt. A. W. S. DOUGLAS, R.N.
 Mr. HERBERT BROWN.
 Mr. JOHN HAYTIE, Ex-Coxswain.

Mr. T. HENNING.
 Mr. JAMES HILLIER.
 Mr. WILLIAM HILLIER.

Honorary Secretary—
 Rev. R. LESLIE MORRIS, M.A., Rector of Brooke.

Atherfield.

Rev. G. E. JEANS, Chairman.
 Captain DOUGLAS, R.N.
 Mr. GEO. HEAL.
 Rev. C. W. HEALD.
 Dr. JOLLIFFE.
 J. D. JOLLIFFE, Esq.
 Mr. J. LININGTON.
 H. C. MILLS, Esq.
 Rev. H. C. M. SPURRIER.
 Hy. WAX, Esq.

Honorary Secretary—
 CHARLES DABELL, Esq.

Totland.

Col. CROZIER, J.P., C.A., Chairman.
 Mr. A. RATLIFF.
 Com. BLENNERHASSETT, R.N.
 F. W. BURNETT, Esq.
 J. DOVER, Esq.
 Dr. HANDS.
 Mr. W. HAYMAN.
 J. RING, Esq.
 ALEX. PARIS, Esq.
 Lord TENNYSON, J.P.
 G. PICKERING, Esq.
 Mr. W. J. WATERHOUSE.

Hon. Secretary—
 Lieut. J. FROST R.E.

McClintock, R.L. Esq.	5	-	-
Money, Miss	5	-	-
Moon, Mrs. F.	5	-	-
Paget, A. Fitz Clarence, Esq.	5	-	-
Richmond, O. R. Esq.	5	-	-
Shedden, G. Esq.	10	-	-
Thellusson, Hon. Hugh	5	-	-
Sums under 5s.	1	4	6
Total Dons.	47	2	6

Collecting Boxes.

Per Mr. C. Dabell, Blackgang :-			
Blackgang Bazaar, per Mrs. A. Dabell	15	2	
Blackgang Hotel, per Mr. Rotter	5	7	
Boxes under 5s.	8	9	
Per A. Harbottle Escount, Esq., J.P. :-			
Carisbrooke Castle	2	3	2
Per A. E. Marvin, Esq., Cowes :-			
Atkey, Messrs. P. & Sons, Cowes	1	1	
Boxes under 5s.	16	5	
Per Rev. R. Leslie Morris, M.A. :-			
Brook Life-boat house	8	-	
Hillier, Mr. W., Compton	10	-	
Boxes under 5s.	8	6	
Per W. Cole Norman, Esq., Ventnor :-			
Hart, Mr. W., late Mr. Price Owen	14	-	
Queen's Hotel, 1896	5	5	
Royal Hotel, per Mr. Clouts, 1895 and 1896	12	4	
Saunders, Mr., Rosenheim, Bonchurch	5	10	
Boxes under 5s.	2	7	
Per Miss Scovell :-			
Girls' Bible Class, Carisbrooke Church School	1	5	-
Brightstone Grange Life-boat-house	9	5	
Mew, Langton & Co., Messrs. W. B., Newport	17	-	
Other boxes under 5s.	1	1	6
Total Dons.	67	19	1
Total Subs.	170	18	6
	£238	17	7

TOTLAND BAY BRANCH.

Per Lieut. JAS. FROST, R.E. :-			
Alum Bay Hotel	7	5	
Alum Bay Pier Pillar	15	10	
Brookenhurst Railway Station, 2 boxes	5	4	
Bugle Hotel, Yarmouth	8	-	
Elkins, Mr. H., Totland	7	1	
Totland Hotel Restaurant	8	5	
Totland Regatta	2	13	
Totland Pier Pillar	16	7	
Totland Supply Stores	9	-	
Totland Life-boat House	18	-	
Yarmouth Pier Pillar	8	6	
Boxes under 5s.	9	9	
Total Dons.	67	19	1
Total Subs.	170	18	6
	£238	17	7

BEMBRIDGE BRANCH.

Local Committee—
Lieut.-Col. W. L. N. CLAYTON.
J. B. DENISON.
Capt. E. DU BOULAY.
Mr. FLYNN, R.N., Chief Officer Coastguard.
Mr. T. JORDAN.
Lieut.-Col. MORETON.
Lieut.-Col. MURRAY.
Mr. W. OSBORNE.
Rev. J. N. PALMER.
Mr. R. TUFFLEY.
Mr. WEEKS, R.N.
Major WINDHAM.

Honorary Secretary—
Rev. J. N. PALMER.

Annual Subscriptions.

	£.	s.	d.
B., Mr.	10	-	0
Dashwood, Mr. A.	5	-	0
Day, Mr. R. E.	5	-	0
Denison, J. B.	1	-	0
du Boulay, Capt. E.	1	-	0
Francis, Rev. E. H.	10	-	0
Friend	5	-	0
Grueber, Mr. H. A.	5	-	0
Hall, Mrs. Farmer	2	-	0
Hoare, Mr. Sidney	10	-	0
Jordan, Mr. T.	5	-	0
Moreton, Col. A.M.D. 1	1	-	0
Murray, Lt.-Col.	5	-	0
Oglander, Mr. J. H.	1	-	0
Palmer, Rev. J. N.	1	1	0
Pasterle, Mr. H.	5	-	0
Pike, Mr. J. W.	5	-	0
Richards, Rev. W. H.	1	-	0
Ridley, Mr. S. E.	1	-	0
Rowlatt, Mr. S. A.	10	-	0
Shilson, Rev. Charles	10	-	0
Summers, Rev. E.	10	-	0
Thomas, Mr. M. O.	1	1	0
Thornycroft, Mr. John I.	10	-	0
Vigo, Mr. J. G.	5	-	0
Small subscriptions	1	2	0
Total Subs.	17	1	0

Donations.

Contribution Boxes.	11	4	
Total	£17	12	4

RYDE BRANCH.

President—
Admiral BONHAM.
Local Committee—
Rev. J. SHARME, M.A., Vicar, Chaplain.
Capt. BOGGER, R.N.
Capt. COLLINS, R.N.
Major LOWTHER CROFTON.
Lieut. GARTSIDE - TIPPING, R.N.
GEORGE H. HARRISON, Esq., J.P.
The Mayor of RYDE.
Mr. H. SOUTHCOTT.
PERCY THELLUSSON, Esq., Sec. R.V.Y.C.
Capt. WALFORD.

Hon. Se retary—
Alderman MARVIN, J.P.

Annual Subscriptions.

Abbott, Gen. Sir Jas., K.C.B. (the late)	5	-	0
Blunt, Col.	5	-	0
Bloxam, Miss	5	-	0

Boger, Capt., R.N.	10	-	0
Bonham, Admiral	5	-	0
Boxer, Miss	5	-	0
Brigstocke, Miss	10	-	0
Brigstocke, W. P. Esq.	1	1	0
Brook, J. O. Esq.	5	-	0
Browne, Gen. Sir Sam., V.C., G.C.B.	5	-	0
Cameron, Rev. W. M.	5	-	0
Carter, Mrs. E.	1	-	0
Clayton, Mrs. S. W.	5	-	0
Collins, Capt., R.N.	5	-	0
Craddock, Col. & Mrs.	5	-	0
Crofton, Major G. Lowther	5	-	0
Davies, Mrs.	5	-	0
Douglas, Rev. J. W.	5	-	0
Duffield, J. W. Esq.	10	6	
Ellery, T. F. Esq.	10	-	0
Forsyth, Commander, R.N.	5	-	0
Gibbs, W. Esq.	5	-	0
Gillson, Miss M. A.	5	-	0
Gough - Calthorpe, Gen. the Hon. S.	5	-	0
Grant, General S.	5	-	0
Hamilton, Miss	5	-	0
Harrison, G. H. Esq., J.P.	1	1	0
Hutt, George, Esq.	5	-	0
Jessop, E. Esq.	1	-	0
Le Marchant, Miss	5	-	0
Lindon, Rev. T. A.	10	6	
Liscombe, Mrs.	10	6	
Macnaghten, Miss	10	-	0
Marvin, Alderman E., J.P.	5	-	0
Maybrick, M. N. Esq.	5	-	0
Maynard, Mrs. R.	5	-	0
Murray, Mrs. E.	10	-	0
Newall, General	10	6	
Pannell, C. L. Esq.	5	-	0
Peters, E. H. Esq.	5	-	0
Rich, Evelyn, Esq.	5	-	0
Royal Victoria Yacht Club	1	1	0
Simonds, Professor, J.B., J.P.	5	-	0
Skinner, J. Holt, Esq.	5	-	0
Sutton, Lady	10	-	0
Sutton, Miss	5	-	0
Sutton, Miss Zoe	5	-	0
Tipping, Lieut. H. G., R.N.	1	-	0
Sums under 5s.	11	4	6
Total	£30	9	6

Donations.

The Mayor, Ald. E. Groves	10	6	
Price, George, Esq.	5	-	0
Sums under 5s.	5	-	10
Contribution Boxes: Esplanade Hotel	1	-	0
Pier Pillar Box	10	-	0
Salisbury Restaurant	10	2	
R. V. Y. Club	1	10	2
Boxes under 5s.	1	8	
Total Dons.	4	8	4
Total Subs.	30	9	6
	£34	17	10

Rent.

BROADSTAIRS BRANCH.

Local Committee—
Mr. P. W. ALLNUTT.
Dr. H. G. BIDDLE.
Dr. F. BRIGHTMAN.
Mr. G. G. KENNEDY, J.P.
Rev. FRANK T. MILLS.
Mr. WM. THOMAS, Station Officer H.M. Ct.Gd.
Mr. J. WALLACE, Ex-Station Officer H.M. Ct.Gd.

Honorary Secretary—
Mr. T. JACKSON.

Annual Subscriptions.

	£.	s.	d.
Allnutt, P. W. Esq.	5	-	0
Ashley, C. F. Esq.	1	1	0
Banting, W. Esq.	2	2	0
Biddle, Dr. H. G.	10	-	0
Brightman, Dr. F.	10	-	0
Churchill, Rev. W. H., M.A.	1	1	0
Delo, The Misses	5	-	0
Elyard, Lieut.-Col.	10	-	0
Elyard, The Misses	1	1	0
Jackson, T.	5	-	0
Kennedy, G. G. Esq., J.P.	1	-	0
North, Hon. H. F.	1	1	0
Reed, H. H.	1	1	0
Whitehead, Mrs.	10	-	0
Wyatt, Sir R. H.	1	1	0
Total	£12	3	0

Donations.

Dodd, Mr. F. K.	5	-	0
Holbourn, Mr. W.	10	-	0
Boys and Inmates of Lindenthorpe School	1	-	0
Collected, per Rev. T. Davies	1	10	2
Pillar and Boxes	7	9	3
Sums under 5s.	3	1	0
Total Dons.	10	17	6
Total Subs.	12	3	0

DOVER BRANCH.

Local Committee—
E. W. KNOCKER, Esq., Chairman.

Honorary Secretary—
Lieut.-Gen. BRUCE, C.B.

Annual Subscriptions.

Atkins, Mr.	5	-	0
Back, Mr.	5	-	0
Baggally, T. W. Esq.	10	-	0
Baldwin, J. L. Esq.	10	-	0
Bampton, Mrs.	1	-	0
Barlow, Percy, Esq.	5	-	0
Bradley, Messrs.	10	-	0
Bootle, Mrs.	5	-	0
Brenchley, Mrs.	1	-	0
Browne, Mrs. E. W.	5	-	0
Bruce, General, C.B.	10	6	
Cay, Capt., R.N.	10	-	0

	£.	s.	d.
Chisol, Rev. T. A.			
and School.....	1	8	4
Chitty, E. Esq.....	1	1	-
Coleman, E. P. Esq.	10	-	-
Crundall, Sir W. H.	1	1	-
Cureton, Mr.....	5	-	-
Curtis, Mrs., and family	1	-	-
De Moleyns, Mr.....	5	-	-
De Moleyns, Mrs.....	5	-	-
Dickson, Sir R.	1	1	-
Ditmas, Mrs.....	5	-	-
Elliott, Mrs.....	5	-	-
Eason, General.....	5	-	-
Ewing, Rev. J. W.	5	-	-
Flashman, Mr.....	5	-	-
Frith, Major.....	2	2	-
Graves, Mr.....	5	-	-
Graves, W. Esq.....	5	-	-
Grosvenor, Lady.....	1	-	-
Hammond, Messrs.			
G. & Co.....	5	-	-
Hammond, Mr.....	5	-	-
Harcourt, Mrs.....	5	-	-
Hayward, H. Esq.....	5	-	-
Heath, General.....	1	-	-
Hickman, Major.....	5	-	-
Hills, Mr.....	5	-	-
Iglesden, Mr. E. A.	5	-	-
Jenken, Mrs.....	10	-	-
Jull, Mrs.....	10	6	-
Knight, General.....	1	-	-
Knocker, W. Esq.....	1	1	-
Loring, Mrs.....	5	-	-
Manning, H. Esq.....	1	-	-
McMeekam, Mrs.....	5	-	-
Mello, J. A. Esq.....	10	-	-
Metcalf and Mayes, Messrs.....	10	-	-
Morgan, Mrs.....	10	-	-
Mowll Worsfold, Esq.....	5	-	-
Munns, Mrs.....	10	6	-
Neate, Captain.....	10	-	-
Pinhorn, R. Esq.....	10	-	-
Powell, Colonel.....	10	-	-
Ramsbottom, Miss.....	5	-	-
Rose, Miss.....	1	-	-
Shepherd, Mrs.....	1	-	-
Smith, Rev. B.....	10	-	-
Statham, Rev. S.....	5	-	-
Stilwell, J. Esq.....	5	-	-
Sutton, Dr.....	1	1	-
Taylor, Miss Herbert.....	10	-	-
Thompson, Miss.....	5	-	-
Watson, T. Esq. (1894-5).....	2	2	-
Worsfold, — Esq.....	5	-	-
Wright Bros. Messrs.....	10	-	-
Sums under 5s.....	18	-	-
Total.....	£42	1	10

Donations.

Churchward, Mrs.	1	-	-
Coleman, H. Esq.....	10	-	-
Jacoby, Mr. W.....	1	-	-
Lawes, Mrs.....	1	1	-
Lewis, Mrs.....	10	-	-
M. R. M. per Messrs. Boyton & Sons.....	1	-	-
Sherrard, F. Esq.....	5	-	-
Collecting Boxes.....	7	3	-
Proceeds of an Entertainment at the Town Hall, 16th January.....	8	15	-
Total Dons.....	20	14	-
Total Subs.....	42	1	10
£62	15	10	

DUNGENSES BRANCH.

Local Committee—
 EDWIN FINN, Esq., J.P., Chairman.
 R. BEVAN, Esq., L.R.C.P., D.P.H.
 W. BLACKLOCKS, Esq.
 Rev. F. S. DALE.
 ARTHUR FINN, Esq., J.P.
 J. C. PROCTER, Esq., J.P.
 J. A. PROCTER, Esq., M.R.C.S.
 S. RAYNER, Esq.
 Lieut. SMYTHIES, R.N.
 Mr. R. TART.
 Rev. — WILKINSON.

Honorary Secretary —
 Capt. HAROLD FINN.

Annual Subscriptions.

	£.	s.	d.
Bartholomew, Mrs.			
William.....	1	1	-
Bas, E. T. Esq., J.P.	10	-	-
Blacklocks, W. Esq.	10	-	-
Dale, Rev. F. S.....	10	6	-
Donne, Mrs. Alured.....	10	6	-
Donne, General.....	1	-	-
Finn, Adolphus, Esq.	5	-	-
Finn, Arthur, Esq., J.P.....	10	-	-
Finn, Edwin, Esq., J.P.	1	1	-
Finn, Harold, Esq., J.P.....	10	-	-
Hutchings, Lewis, Esq.....	10	-	-
Mackitt, Mr. Thos.....	5	-	-
Procter, J. C. Esq., J.P.	10	-	-
Procter, J. A., Esq., M.R.C.S.....	10	-	-
Rayner, S. Esq.....	10	-	-
Samson, W. Esq., J.P.....	10	-	-
Smythies, Lieut R.N.	10	-	-
White, Messrs. A. and W. T.....	10	-	-
Wood, Field and Hanbury, Messrs.....	1	1	-
Total.....	£11	4	-

FOLKESTONE BRANCH.

President—
 Sir EDWARD W. WATKIN, Bart., M.P.
Chairman—
 Lieut.-Col. PENFOLD, J.P., C.C.
Treasurer—
 J. R. DAVEY, Esq., National Provincial Bank.
Hon. Secretary—
 Mr. W. D. FAGG.
Committee—
 D. BAKER, Esq.
 JOHN BANKS, Esq., J.P. Mayor.
 Capt. BOXER, R.N.
 H. B. BRADLEY, Esq.
 C. J. CHAPMAN Esq.
 E. C. CONDRY, Esq.
 Dr. F. EASTES.
 WILLIAM FOWLE, Esq.
 H. B. GARLAND, Esq.
 Admiral HARR.
 Capt. HEATHCOTE, R.N.
 Capt. HIGGIN, R.N.
 G. PEDEN, Esq.
 A. E. ROZE, Esq.
 Alderman GEO. SPURGEN.
 THOS. VAUGHAN, Esq.
 A. M. WATKIN, Esq., J.P.

Annual Subscriptions.

	£.	s.	d.
Adolphus, Miss.....	1	-	-
Allott, Col. H.....	1	1	-
Alwin, C. Esq.....	1	1	-
Barrows, T. Hill, Esq.	10	-	-
Bradley, H. B. Esq.....	1	1	-
Buchanan, Miss.....	1	-	-
Carter, Capt. Wiloughby.....	2	2	-
Chapman, C. J. Esq.....	10	-	-
Condy, E. Esq.....	1	1	-
Courage, Miss.....	1	1	-
Dawson, Mrs.....	1	1	-
Dyer, Miss Maitland.....	1	1	-
Edwards, Gen. Sir Bevan, M.P.....	1	1	-
Fowle, W. Esq.....	1	1	-
Gardner, Joseph, Esq.....	1	1	-
Garling, H. B. Esq.....	1	1	-
Gilbourne, Surgeon-Gen., J.P.....	1	1	-
Holden, J. Esq., J.P.....	1	1	-
Hussey, Rev. A. L.....	1	1	-
Larkin, W. F. Esq., J.P.....	1	1	-
Lawrence, Rev. R. M. A.....	1	1	-
Master, Mrs. C.....	1	1	-
Nicholson, Mrs.....	1	1	-
Sturton, Mrs.....	1	1	-
Rdsdale, Rev. C. J., B. A.....	10	6	-
Spurgen, Ald. Geo., J.P.....	1	1	-
Sturt, Mrs Napier.....	2	2	-
Watkin, A. M. Esq.....	1	1	-
Wilkinson, Mrs.....	1	1	-
Woodhouse, Rev. F.....	1	1	-
Total.....	£32	16	6

Donations.

Alprea, Rev. M.A.....	1	-	-
Barle, Rev. H.....	10	-	-
Boykett, F. Esq.....	1	1	-
Brooker, J. H.....	1	1	-
Crombie, A. Esq.....	5	-	-
Cross, Rev. E.H., D.D.....	1	-	-
Eustice, Lady F. E.....	10	-	-
Gardner, Commander A. M., R.N.....	3	3	-
Goddard, Capt.....	10	-	-
Haughton, Mrs.....	1	-	-
Hill, Gen. Sale, C.B.....	1	-	-
Hutchins, Col. F.....	10	-	-
Irving, Sir Henry.....	1	-	-
Isherwood, A. Esq.....	10	-	-
Le Grice, Col.....	10	-	-
Leyton, Capt. Miller Maclean, Miss St. Richardson, Miss St. John.....	5	-	-
Richardson, Mrs. St. John.....	10	-	-
Seymour, L. A.....	10	-	-
Style, Sir Wm. Bari, and Lady Style.....	1	1	-
Taylor, R. W. Esq.....	1	-	-
Frotter, Miss A. M.....	1	1	-
Walter, C. Esq.....	1	-	-
Wampach, C. C. Esq.....	1	1	-
Weatherall, Capt. F. A., R.N.....	1	1	-
Collected at Life-boat House.....	24	2	2
Collected on Regatta Day.....	5	2	5
Folkestone Life Box.....	9	5	-
Harbour Pillar Box.....	1	7	9
Leas Pillar B x.....	7	3	9
Norfolk Hotel Box.....	8	-	-
Sums under 5s.....	4	-	-
Total Dons.....	61	16	6
Total Subs.....	32	16	6
£94	13	-	

GOODWIN SANDS AND DOWNS BRANCH.

Patron—
 The Right Hon. LORD NORTHBOURNE.
Local Committee—
 Admiral GORDON DOUGLAS, Chairman.
 Rev. F. B. BLOGG.
 Capt. BUSHE, R.N.
 JULIAN COAST, Esq.
 Capt. COLEMAN.
 Dr. DAVEY.
 Rev. T. LL. GRIFFITH.
 Lieut. GUNN, R.N. Ct Gd.
 Capt. HAGGARD, R.N.
 Rev. H. VENN.
 A. WOLLASTON, Esq.

Treasurer and Hon. Sec.—
 Rev. T. S. TREANOR.

NORTH DEAL LIFE-BOAT.

Annual Subscriptions.

	£.	s.	d.
Banks, E. Esq.....	1	-	-
Cinque Port, Pilots (8) at 2s. 6d. each.....	1	-	-
Ellbecks, Miss.....	10	-	-
Ellerby, Mrs.....	2	2	-
Frost, H. G.....	10	-	-
Gransmore, Miss.....	10	-	-
Green, W. J. Esq.....	10	-	-
Griffith, Rev. T. Ll.....	10	6	-
Grove, E. Esq.....	1	1	-
Hilton, Mrs.....	10	-	-
Honeyball, F. T. Esq.....	5	-	-
Hovell, J. R. Esq.....	1	1	-
Hulke, Dr. F.....	10	6	-
Morris, Mrs.....	1	1	-
Northbourne, Lord.....	3	3	-
Roope, T. Esq.....	10	6	-
Stringer, Mrs.....	1	1	-
Watts, Miss.....	10	6	-
Wood, W. H. Esq. (1895-6).....	1	-	-
Sums under 5s.....	5	-	-
Total Subs.....	£17	11	6

Donations.

Hubatt, Mrs.....	1	-	-
£18	11	6	

WALMER LIFE-BOAT.

Annual Subscriptions.

Bushe, Capt., R.N.....	10	-	-
Davey, Dr.....	10	-	-
Douglas, Admiral.....	10	-	-
Griffith, Rev. T. Ll.....	10	6	-
Halse, Miss.....	5	-	-
Northbourne, Lord.....	2	2	-
Not, Mrs.....	1	1	-
Roget, J. Esq.....	10	-	-
Rosher, W. H. B. Esq.....	10	6	-
Royse, Admiral.....	10	6	-
Thompson and Sons, Messrs.....	1	-	-
Venn, Rev. H.....	10	-	-
Watts, Miss.....	10	6	-
Wollaston, A. Esq.....	10	6	-
£9	10	6	

Contribution Boxes and Collections.

Black Horse Hotel.....	5	7	-
Collected on Deal Beach by Mr. Joseph Gwyer.....	1	6	-

	£.	s.	d.
Collected on Pier ...	2	17	6
Kingsdowne Boat-house	9	5	
North Deal Boat-house.....	1	6	2
Pillar Box on Pier ...	1	3	
Royal Hotel	1	14	
Walmer Boat-house. 5	4		
Small amounts.....	6	10	
	£14	6	1

North Deal Subs.....	17	11	6
Walmer Subs.	9	10	6
Donations	1		
Contribution Boxes .	14	6	1
Total	£42	8	1

HERNE BAY, HERNE & RECLUVER BRANCH.

President—
The Right Hon. A. AKERS DOUGLAS, M.P.

Local Committee—
DR. E. C. FENOULHET, C.C., Chairman.
MR. P. H. ASHWELL.
MR. G. BARTON.
MR. J. BOWES.
MR. J. H. BRABAZON.
G. BURGESS, Esq., J.P.
MR. E. D. COLLARD.
MR. SIDNEY KEEN.
MR. F. S. WACHER.
MR. J. S. WHITE.
F. H. WILBER, Esq., J.P.

Bankers—
LONDON AND COUNTY BANK, Herne Bay.

Honorary Secretary—
HENRY C. JONES, Esq.

Donations.

Collected on "Life-boat Saturday" ..	21	13	5
Contribution boxes ..	7		
Total	22	13	5

HYTHE AND SANDGATE BRANCH.

President—

Local Committee—
Capt. SMITHS, R.N., Chairman.
THE CHAIRMAN OF THE SANDGATE LOCAL BOARD OF HEALTH.
THE CHIEF OFFICER OF COASTGUARD, Sandgate.
J. DU BOULAY, Esq., J.P.
H. T. COBAY, Esq., J.P.
BENJAMIN HORTON, Esq., J.P.
THE MAYOR OF HYTHE.
Com. A. P. MANSELL, R.N., J.P.
J. SCOTT, Esq.

Treasurer—
J. R. DAVY, Esq.,
N. P. Bank, Folkestone.

Honorary Secretary—
GEORGE WILKS, Esq., Hythe.

Annual Subscriptions.

	£.	s.	d.
Brockman, F. D. Esq. J.P.	10	6	
Deedes, Mr. Col. H.	1		
duBoulay, J. Esq., J.P.	10	6	
Horton, B. Esq., J.P.	10	6	
Hughes, C. W.	5		
Jeal, Mr. J. J.	10		
Kirkpatrick, J., Esq., J.P.	10	6	
Man, Lionel, Esq.	1	1	
Mackeson, Mrs.	10	6	
Nelson, Miss J.	5		
Porter, F. W. Esq. J.P.	10		
Sandlands, E. C. Esq.	10	6	
Sidle, Mrs.	10		
Tournay, Tournay W. Esq., J.P.	1	1	
Valentine, J., Esq.	10	6	
Wildash, Mrs.	5		
Wilks, George, Esq.	10		
Sums under 5s.	17	6	
Total	£10	8	—

Donations.

Mrs. Wildash.	1	1	
Anonymous.	10		

Boxes.

Royal Kent Hotel, Sandgate	13	7	
Swan Hotel, Hythe ..	1	5	1
White Hart Hotel, Hythe	1	10	
Beau, Mr.	11		
Pillar Boxes	14	6	
Boxes under 5s.	14	3	
Total Dons.	6	19	5
Total Subs.	10	8	—
	£17	7	5

KINGSGATE BRANCH.

Local Committee—
Commander L. DICK, R.N.
F. H. BORRADILLE, Esq.

Honorary Secretary—
Col. H. W. ISACKE, R.A.

Assistant Secretary—
Mr. W. JENKINS,
Chief Officer of H.M. Ct. Gd.

Annual Subscriptions.

Borradille, F. H. Esq.	1	1	
Edmeades, Major-General, R.A.	1	1	
Isacke, Capt., H.C.S.	1	1	
Isacke, Col., R.A.	10	6	
Maclean, H. Esq.	1	1	
Metcalfe, Col., C.B., the late, per Mrs. Metcalfe.	1	1	
Webb, Mrs.	10		
Weekly, Mrs.	10		
Whitehead, Rev. A.	10		
Total	£7	5	6

Donations.

Donations and Contribution boxes ..	8	15	3
Total Dons.	8	15	3
Total Subs.	7	5	6
	£16	—	9

MARGATE BRANCH.

Local Committee—
J. T. FRIEND, Esq., J.P., Chairman.
W. GREEN, Esq., J.P.
C. O. Coastguard.
Capt. HATFIELD, J.P.
Colonel HILL.
G. FOORD-KEECEY, Esq.
J. PARAMOR, Esq.
C. E. TROUGHTON, Esq.

Honorary Secretary—
T. JEPHCOTT.

Annual Subscriptions.

	£.	s.	d.
Barrett, T. J. Esq.	1	1	
Bayly, Mr. John.	5		
Bobby, F. J., Esq.	10		
Cobb, A. B. Esq.	10		
Cobb, F. C. Esq.	1		
Crawford & Co.	1	1	
De Vayne, Miss	1		
Edwards, Mrs.	1		
Emptage, Mr. D.	5		
Fagg, Mrs. W. A.	5		
Foord-Kelcey, G. Esq.	10	6	
Friend, J. T. Esq., J.P.	1		
Green, W. Esq., J.P.	5		
Harvey, Mr. W. S.	5		
Hatfield, Capt., J.P.	1	1	
Hubbuck, A. G.	1	1	
Hume, Mr. J.	5		
Isaacson, Mrs.	5		
Larkin, John, Esq.	1	1	
Malins, Mr. J. B.	5		
Mayor, Mrs. G.	2	2	
Mercer, W. Esq.	5		
Paramor, Messrs. R. and Son	5		
Pittock, Dr. J. P.	5		
Powell-Cotton, P. H. G., Esq.	1		
Price, Dr. W. P.	5		
Purdey, J. Esq.	1	1	
Rowe, Dr. T. S.	10		
Rowe, Mr. T. S.	5		
Scott, Miss.	2	2	
Taylor, J. Esq.	1		
Thornton, Miss.	2	2	
Treves, W. K. Esq.	5		
Troughton, C. E. Esq.	5		
Wastall, E. Esq.	5		
Willet, Mr. F. W.	5		
Woodruff, Mr. W. C.	5		
Total	£25	2	6

Donations.

Boxes—

Boat House	7	3	
Collected at a Launch by— Epps, B.	3	10	7
Henry	3	10	7
Epps, J. Jun.	5		
Crosier, E.	5		
Epps, J. Jun.	9	4	
Gwyer, J.	1	5	
Henton, Hiram.	1	1	
Bume, Mrs.	13		
Jet y Extension.	12	2	
Rose Hotel, Canterbury	17	9	
Ship Hotel, Margate.	1	4	4
Wright, W.	10		
Sums under 5s.	2	6	
Total Dons.	10	17	11
Total Subs.	25	2	6
	£36	—	5

NEW ROMNEY BRANCH.

Local Committee—
H. COBB, Esq., Chairman.
Rev. R. M. SOUTH.
E. CASE, Esq.
J. HUMPHREY, Esq.
G. B. ANDERSON, Esq.
W. VIDGEN, Esq.
J. BANNON, Esq.
P. H. TUBBS, Esq.
A. HUTCHINSON, Esq., Jun.
Major H. BYRNE.
Mr. E. BOWE, Chief Boatman H.M.C.G.

Honorary Secretary—
F. W. STILLWELL, Esq.

Annual Subscriptions.

	£.	s.	d.
Anderson, Geo. Esq.	5		
Austen & Son, Messrs.	5		
Bannon, J. Esq.	5		
Byrne, Major H.	1	1	
Case, E. Esq.	10	6	
Cobb, H. Esq.	10		
Gravett, Thos.	5		
Hardy, L. Esq., M.P.	2	2	
Hills, R. Esq.	5		
Humphery, J. Esq.	10		
Hutchinson, A. Jun.	5		
Jones, J. Esq.	1	10	
Littlestone Golf Club ..	1	1	
Mackay, R. Esq.	1	1	
Moate, R. P. Esq.	5		
Moody, J. Esq.	5		
P. Lister, F. Esq.	1	1	
Pouppard, A. Esq.	10		
Smith, J. Rd. Esq.	5		
Smith, Mrs. W. B.	5		
South, Rev. R. M.	5		
Stillwell, F. W. Esq.	10		
Tubbs, Percy, Esq.	1	1	
Tunbridge, T. F. Esq.	5		
Welden, W. Esq.	5		
Wood, Mrs.	5		
Sums under 5s.	2	13	6
Total	£16	11	—

Donations.

Aspen, E. Esq.	1	1	
Charles, R. S. Esq.	1	1	
Cock, C. Esq.	5		
Ellis Bros., Messrs.	5		
Jones, Major G.	5		
"K. A. C."	10	6	
Kimber, W. Esq.	5		
Perks, R. W. Esq., M.P.	5		
Rowlandson, Mrs.	10		
Tubbs & Lewis, Messrs.	1	1	
Vidgen, W. Esq.	5		
Sums under 5s.	5		
Collecting Boxes— Anderson, G. Esq.	5	7	
Graud Hotel	6	8	
Littlestone Life-boat Station.	1	4	1
Stillwell, F. W. Esq.	5	3	
Sums under 5s.	14	7	
Total Dons.	13	9	8
Total Subs.	16	11	—
	£30	—	8

ROCHESTER BRANCH.

Local Committee—
The MAYOR OF ROCHESTER,
Chairman.
C. ARKCOLL, Esq.
Rev. C. H. BANNING.
W. HATMEN, Esq.
J. S. HILLS, Esq.

Honorary Secretary—
FREDERICK F. SMITH, Esq.

Annual Subscriptions.

	£.	s.	d.
Arkcoll, Mr. C.....	1	1	
Ball, Mr. W.....	1	1	
Day, Miss.....	1	1	
Day, Miss S.....	5		
Foord, J. R., Esq... 1	1	1	
Foord, T. H., Esq... 1	1	1	
Foord, the Misses... 1	1	1	
Fremlin Brothers... 1	1	1	
Haymen, Mr. W.....	1	1	
Hayward, Sir M. W. - 10	10		
Hills, Mr. J. S.....	10		
Hilton, Anderson & Co.....	1	1	
Lee, Son & Co.....	1	1	
Medway Steam Packet Co.....	1	1	
Payne, Mr. H.....	5		
Tingey & Son, Messrs. W.....	1	1	
Tuff, C., Jun., Esq. - 10	10		
Watson & Gill, Messrs. - 10	10		
Winch & Sons, Messrs. E.....	3	3	
Sums under 5s.	2	6	
Total.....	£18	9	

Donations.

Boxes:—

Cheffins, C. H. P. Esq.	1	11	
Conservative Club, Rochester and Strood	19		
Custom House, Rochester.....	13	10	
Offertory, Rochester Cathedral.....	9	9	7
Shenanikins' Box. - 16	16		6
Boxes under 5s. ... 1	5		
Total Dons.	27	6	6
Total Subs.	18	9	6
Total.....	£45	15	6

Lancashire.

BARROW BRANCH.

President—
His Grace the DUKE OF
DEVONSHIRE, K.G.

Local Committee—

Admiral BARNETT (Chair-
man).
W. DURIE, Esq.
JOHN FISHER, Esq., J.P.
Capt. FOLL.
Capt. GARLAND.
R. N. HORSFALL, Esq.
C. W. HUNTER, Esq.

J. W. LITTLE, Esq., J.P.
W. A. MAIN, Esq.
J. M. MAWSON, Esq.
Capt. PORTER, J.P.
Capt. STORES, J.P.
W. F. A. WADHAM, Esq.

Honorary Secretary—
Mr. WALTER CARTER.

Collector—
Mr. ROBERT ECCLES.

Annual Subscriptions.

	£.	s.	d.
Aslett, Alfred, Esq. 1	1	1	
Barnett, Admiral... 1	1	1	
Barrow Co-operative Society, Ltd.....	2		
Barrow Working Men's Club	1	1	
Beesley and Sons, Messrs.....	10	6	
Bolton & Co. Messrs. - 5	5		
Butler, T. F. Esq. ... 10	10		
Caird, D. Esq.....	1	1	
Case and Co. Messrs. - 10	10		
Cook, H. Esq., J.P. 1	1	1	
Crossfield, F. J. Esq., J.P.....	10		
Devonshire, His Grace the Duke of, K.G. 2	2		
Dick & Co. Messrs. W. B.....	5		
Durie, W. Esq.....	10		
Fisher and Sons, Messrs. J.....	2	2	
Foll, Capt.....	1	1	
Garland, Capt.....	1		
Geldart and Sons, Messrs. J.....	5		
Gowan, A. B. Esq... - 10	10		
Hannay and Clarke, Messrs.....	10	6	
Heath, G. S. Esq.... 1	1	1	
Horsfall, R. N. Esq. - 10	10		
Hunter, C. W. Esq.. 1	1	1	
Lancaster Banking Co.....	2	2	
Little, J. W. Esq., J.P.....	2	2	
Lowden and Postle- thwaite, Messrs. - 5	5		
Mackereth, Exors. of H. W.....	10	6	
Main, W. A. Esq. ... 1	1	1	
Mawson, J. M. Esq. - 10	10		
McKechnie, J. Esq. - 10	10		
Miller & Co. Messrs. R. F.....	1	1	
Newcomb, R. N. Todd, Esq.....	2		
North Lonsdale Iron and Steel Co., Ltd. 1	1	1	
O'borne Flynn and Co., Messrs.....	1	1	
Phillips, Venerable Archdeacon	5		
Porter, G. Esq., J.P. - 10	10		
Roberts, W. Esq. ... 5	5		
Sansom, E. Esq.....	5		
Stark, P. W. Esq. M.D.....	10	6	
Shaw & Lee, Messrs. - 5	5		
Smith, J. T. Esq., J.P. 1	1	1	
Smith, J. P., Esq. ... 10	10		
Siteman, F. Esq.....	10	6	
Thompson, Jas. Esq. - 10	10		
Townson and Ward, Ltd., Messrs.....	10	6	
Wadham, E. Esq., J.P.....	1	1	
Wadham, Walter F. A. Esq.....	1	1	
Wards, Capt.....	5		
Williams, J. Esq. ... 5	5		
Wilson, T. Newby- Esq., J.P.....	10	6	
Total	£40	19	

Donations.

	£.	s.	d.
Committee of Charity Ball	1	1	
Committee of Cycling Parade... 2	10		
Collected on H.M.S. Powerful, per Naval Construction and Armaments Co., Ltd.....	10		
Collecting Boxes ... 7	10	4	
Total Dons.	21	1	4
Total Subs.	40	19	
£62	—	4	

BLACKBURN BRANCH.

(No Local Committee.)

President—
His Worship the MAYOR.

Hon. Treasurer—
J. S. POLLITT, Esq.,
Manchester and County Bank.

Honorary Secretary—
JOSEPH BRIBERLEY, Esq., C.E.

Annual Subscriptions.

Hart, Thomas	2	2	
Haydock, Mrs.	10		
Higham, Miss.....	1	1	
Pollitt, J. S.....	5		
Radcliffe, Thos.	1		
Total Subs.	4	13	
<i>Donation.</i>			
Radcliffe, Thos.	3		
Total.....	£7	13	

BLACKPOOL BRANCH.

President—
Councillor JAMES WARD.
(Mayor of Blackpool.)

Local Committee—
Rev. Wm. EVANS. (Chair-
man)
W. A. BAMBER, Esq.
Ald. J. BICKERSTAFFE.
ROBERT BICKERSTAFFE, Esq.
R. P. BOLTON, Esq.
Geo. BONNY, Esq.
R. BOWMAN, Esq.
Rev. S. Y. B. BRADSHAW.
W. R. BRANDWOOD, Esq.
T. M. S. DOBSON, Esq.
JOHN L. SMITH, Esq.
T. H. SMITH, Esq., J.P.
J. A. TAYLOR, Esq.
C. H. TURVER, Esq.
JAS. WARD, Esq., J.P., C.C.

Honorary Treasurer—

Honorary Secretary—
J. WALTER SMITH, Esq.

Annual Subscriptions.

Bamber, W. A. (1895 and 1896)	1	1	
Barton, Mrs. E. J. ... 10	10		
Brandwood, W. R. ... 10	10		

	£.	s.	d.
Bolton, R. P.	5		
Bonny, Geo.	10	6	
Bowman, R.	10	6	
Dobson, T. M. S. ... 10	10	6	
Doleman, Mr. & Mrs. 1	1	1	
Firth, Arthur P. ... 1	1	1	
Grime, John	10	6	
Handley, R.	1	1	
Jacques, James ... 1	1	1	
Kettlewell, Miss E.A. 1	1	1	
Meredith, Mrs. A. A. 1	1	1	
Parke, G. W.	1	1	
Parrott, James ... 1	1	1	
Smith, T. H.	1	1	
Stott, Dr. F. W. A. ... 5	5		
Taylor, Mrs. J. A. ... 1	1	1	
Turser, C. H.	10	6	
Ward, Jas.	10	6	
Total	£16	4	

Donations.

2nd East Lancashire
Volunteers..... 6 3 -
Contribution Pillars
and Boxes 16 18 -
Collected on s.s.
Greyhound 6 - -
Total Dons. 23 7 -
Total Subs. 16 4 -
£39 11 - -

BOLTON BRANCH.

Chairman—
B. A. DOBSON, Esq.

Hon. Treasurer—
G. R. CARTER, Esq.

Hon. Secretary—
THOMAS H. WINDEK, Esq.

Annual Subscriptions.

(In addition to Bolton "Life-
boat Saturday" Fund.)

Ainsworth, Mrs. Frank	10	6	
Armitage, Mrs.	2	2	
Appleyard & Son, Messrs. R.....	5		
Ashworth & Sons, Messrs. John... 1	1	1	
Ashworth & Sons, Messrs. H.	3	3	
Atkinson, Mr. J. ... 7	6		
Barben, Mr. John ... 10	6		
Bardsley, Mr. G. W. - 10	6		
Barlow, Mr. J. R., J.P.....	1	1	
Barlow, The Misses. 1	1	1	
Barnes, Dr.	10	6	
Barnes, Mr. Harold A.	1		
Bolton and District Billposting & Ad- vertising Co., Ltd. - 5	5		
Bradshaw, Mr. Joseph.....	1		
Bridgman, Col. F. C. 1	1	1	
Broadbent, Mr. H. ... 1	1	1	
Bromley, Mrs.	1	1	
Brown, Mr. James W., J.P.....	1	1	
Brown, Mr. Thos. H. 1	1	1	
Brown, W. H., & S. n 1	1	1	
Burke, Rev. J. A. ... 5			
Butler, Mrs.	10		
Carter, Mr. G. R. ... 1	1	1	
Coie, Mr. Benjamin - 10	6		
Conway, Miss (the late)	10		
Coope, Mr. F. W. ... 1	1	1	
Crook, Mrs.	1	1	
Crook, Mrs. Ed. T. ... 10	6		
Crook, Mr. Joshua. 1	1	1	

£. s. d.		£. s. d.		£. s. d.		£. s. d.	
Crook, Mr. J. B.	1 - -	Marsden & Sons,	1 1 -	Honorary Secretary—		Donations.	
Howard	1 - -	Messrs. Jas.	1 1 -	ERNEST CROSSBY, Esq.			
Cross, Mrs. H.	10 - -	Marsden, Miss.	10 - -	Annual Subscriptions.		Balance of Abram	
Croose, Mr. Edward.	1 - -	Mather, Mr. Harold.	1 1 -			and Greenall Mem-	
Crumblehulme, Mr.		Mather, Mr. Walter.	1 1 -			orial Fund, per	
W.	10 - -	Mather, Mr. Herbert.	1 1 -	Addie, Mr. R. For-	10 6 -	Hon. Sec.	3 4 1
Dobson, Ald. B. A.,		Midgley, Mr. W. W.	5 - -	rester		Collected by Capt.	
The Mayor	1 1 -	Mess. Mr. Richard.	10 - -	Armistead, Mr. Jas.	5 - -	Crispey on board	
Duxbury, Mrs.	1 1 -	Munro, Mrs.	1 1 -	Armour, Mr. J.	5 - -	s.s. Forest Brook	7 7
Duxbury & Sons,		Naisby, Mr. William.	1 1 -	Beeching, Mr. George	10 6 -	Donations and col-	
Messrs. Yates	2 - -	Nicholson, Mr. Wil-		Blezard, Mrs.	5 - -	lections from the	
Eccles, Mr. and Mrs.		liam, J.P.	1 1 -	Bridges, Rev. Thos.	5 - -	Marine Depart-	
A. E.	2 2 -	Nightingale, Mr.		Cardwell, Mr. J.	10 6 -	ment of the L. & Y.	
Eckersley, Mr.		Frederick	2 6 -	Clarkson, Mr. Jno.	5 - -	and L. & N. W.	
Joseph	1 1 -	Peace, Mr. James	10 - -	Clemesha, Mr. B.	10 6 -	Joint Railways,	
Fawell & Sons,		Pikington, Mr. Jas.	10 - -	Cook, Capt.	10 6 -	Fleetwood, per	
Messrs. Geo.	10 - -	Pollitt, Mr. William	10 - -	Crossdale, Mrs. Eliz.	5 - -	Capt. Jackson	8 10 3
Ferguson, Mr. H. S.	10 6 -	Proctor, Mr. Jonas.	1 1 -	Crookall, Mr. John.	5 - -	Fleetwood Industrial	
Finney, Mr. James.	1 1 -	Robinson, Mrs.	1 - -	Crosby, Mr. E.	10 6 -	Co-operative So-	
Gass, Mrs. J. B.	10 - -	Scowcroft, Miss	10 6 -	Curwen, Messrs. H.		ciety	3 3 -
Glaister, Mr. Thos.		Sharman, Mr. Joseph	1 - -	& G. & Co.	1 1 -	Gibson, Mr. George.	5 - -
J.P.	1 1 -	Shaw, Mrs.	2 - -	Davies, Mr. Alex.	5 - -	Hadfield, Mr. G. S.	
Gives, Mr. Thomas	5 - -	Shaw, Mrs. F. W.	1 1 -	Dickinson, Mr. D. W.	5 - -	Derby, collected by	10 6 -
Godt & Little Bolton		Shaw, Mr. Chas. H.	1 1 -	Drewry, Mr. Thomas.	5 - -	Life-boat Box, per	
o-op. Society, Ltd.	10 10 -	Shaw, Mr. R.	10 6 -	Drummond, Messrs.		Hon. Sec.	10 - -
Green, Mr. William.	10 - -	Simpson & Co.,		G. A. & Sons	10 6 -	Majury, Mr. A.	
Greenhalgh & Bleak-		Messrs. Thos.	1 1 -	Duckworth, Mr. Fred	5 - -	per Capt. Hughan	17 6 -
ley, Messrs.	5 - -	Slater & Co., Messrs.	2 2 -	Dunderdale, Mrs.	1 1 -	Rossall School Chap-	
Greenhalgh, Mr. E.		Slater, Mrs.	1 1 -	Fausse, Dr.	5 - -	Offertory, per Rev.	
P., J.P.	10 6 -	Stronge, Mr. Robert	1 1 -	Fish, Mr. J. W.	5 - -	C.C. Tancock, M.A.	7 16 -
Greg, Mr. Ernest.	1 - -	Swanson, Mr. Geo.	10 6 -	Fish, Mr. Thos.	5 - -	Sums under 5s.	13 6 -
Haddock, Miss	10 - -	Taylor, Mrs. Charles	1 1 -	Fisher, Mr. Thomas	5 6 -		
Hardcastle, Miss	10 - -	Thomasson, Mr. J.P.	5 - -	Fleetwood Estate Co.	3 3 -		
Hardcastle, Mr.		Thompson, Mrs.	5 - -	Fogg, Mr. R.	10 6 -	Boxes and Pillars.	
Frank	1 1 -	Thompson, Mr. J.W.	5 - -	Gaulter, Mr. J. R.	5 - -	Dock Gates	7 7 -
Hardcastle, Mr.		Thwaites, Mr. and	2 2 -	Gibson, Mr. A. T.	5 - -	Fielden Institute	4 6 -
Thomas, J.P.	1 1 -	Mrs.	2 2 -	Gibson, Mr. J. R.	10 6 -	Mr. Schjöh's Office.	1 8 -
Harper, Mr. W. A.	1 1 -	Thwaites, Mr. Edw.	2 2 -	Greenwood, Mr.		Life-boat House	7 9 -
Harrison, Mrs.	1 - -	Tillotson, Mrs.	1 1 -	Adam	5 - -		
Harwood & Son,		Walker & Sons,		Grimshaw, Dr.	5 - -		
Messrs. R.	10 6 -	Messrs. Wm.	1 1 -	Higham, Capt. (for		Total Dons.	34 - 2
Harwood, Mr. John.	2 2 -	Walmsley & Fisher,		1895-6)	10 - -	Total Subs.	38 15 -
Haslam & Co., Ltd.,		Messrs.	10 - -	Hance, Mr. Frank.	5 - -		
Messrs. John	1 1 -	Walmsley, Miss.	1 1 -	Hudson, Mr. Lucas.	5 - -		
Haslam, Mr. Lewis,		Walsh, Mr. Robert.	5 - -	Hughan, Capt. J.	10 6 -		
J.P.	2 - -	Watts-Jones, Mrs.	10 - -	Ingham, Mr. W. C.	10 6 -		
Haslam, Mr. Wil-		Wilkinson, Mr.		Jackson, Capt. J. E.	10 6 -		
Ham	1 - -	Thomas, J.P.	1 1 -	Johnson, Mr. John	5 - -	LANCASTER	
Hebden & Son, Messrs.		Winder, Mr. Thos.		Kean, Mr. Jas. H.	5 - -	BRANCH.	
John	1 1 -	Wolfe, J.P.	1 - -	Kelsall, Mr. Edmund	10 6 -	President—	
Henderson, Mr.		Wolfenden, The		Kemp, Miss.	1 1 -	Lieut.-Col. GARRER.	
George	2 6 -	Misses.	2 2 -	Lancaster Bank Co.	2 2 -	Local Committee—	
Hesketh & Sons, Ltd.,		Young, Mr. William	2 - -	Leadbetter, Mr. Rd.	5 - -	E. B. DAWSON.	
Messrs. T. M.	3 3 -	Total	£150 - 6	Leadbetter, Mr. N.	5 - -	A. GREG.	
Heywood, Mr. John,				Miller, Mr. George.	5 - -	J. LEMING.	
J.P.	2 2 -			Morrison, Mrs. Emma	10 - -	G. W. MAXTED.	
Hick, Mrs.	1 1 -			Nicholson, Mr. Miles	10 - -	J. SANDERSON.	
Higson, Miss	1 1 -			Parkinson, Mr. Jno.	5 - -	Sir T. STORRY.	
Holden, Mr. A. T.	1 1 -			Pearson, Mr. A.	5 - -		
Holdsworth, Mr. R.				Penman, Dr.	10 - -	Hon. Treasurer—	
J.	10 - -			Poste, Mrs. Isabella.	10 - -	R. BRIGGS.	
Horrocks, Mrs.				Preston, Mr. Joseph	10 - -	Honorary Secretary—	
James	10 - -			Rankin, Mr. Douglas	10 - -	M. SIMPSON.	
Hulton, Son & Har-				Reeve, Rev. E. J.	5 - -		
wood, Messrs.	1 1 -			Riley, Mr. Thos. J.P.	5 - -		
Jackson, Mr. J. O.	5 - -			Robertson, Capt. J.	1 1 -		
Kay, Mr. William.	5 - -			Robertson, Messrs.			
Kershaw & Sons,				Jas. & Son.	5 - -		
Messrs. Joshua.	1 1 -			Schjöh, Mr. G.	5 - -		
Kershaw, Dr. Alfred	10 6 -			Scott, Mr. S.	10 6 -		
Kevan, Mr. Peter	10 6 -			Singleton, Messrs.			
Knowles, Mr. Arthur	1 1 -			W. & Bros.	10 - -		
Knowles, Mr. Wil-				Smith, Mr. H. C.	2 - -		
liam, J.P.	1 1 -			Sowerby, Mr. W. M.	10 6 -		
Knowles, Mr. Ernest	1 1 -			Sykes, Mr. Robert	5 - -		
Lerd, Hampson &				Taylor, Messrs. Chas.			
Lord, Ltd., Messrs.	2 - -			Sons & Co.	1 1 -		
Lawson & Ormrod,				Thompson, Mr. F. J.	10 6 -		
Messrs.	1 1 -			Ward, Mr. John N.			
Lee, Mr. Henry, J.P.	1 1 -			Exors. of late	10 6 -		
Lever, Miss	10 6 -			Ward, Messrs. Jno.			
Lomax, Sons &				N. & Son	5 - -		
Mills, Messrs.	1 - -			Williams, Mr. Phil.	5 - -		
Longworth & Co.,				Wood, Mr. R. J.	3 3 -		
Messrs.	1 1 -			Woods & Jackson,			
Makant, Mr. J. W.,				Messrs.	10 6 -		
J.P.	2 - -			Woods, Mr. Thomas	5 - -		
Makant, Miss	2 2 -			Yates, Mr. Peter	5 - -		
Mallett, Dr. F. B.,				Sums under 5s.	7 6 -		
J.P.	1 1 -			Total	£38 15 -		
Marsden, Messrs. J.							
H. & G.	1 1 -						

	£.	s.	d.
Cooper, Rev. M. Ker	10	-	-
Copeland, Mrs., Morecambes	5	-	-
Cottam, Proctor W.	1	1	-
Croft, J.	5	-	-
Diggins, James	5	-	-
Dixon, Miss M.	10	-	-
Donaldson, J. H., London	1	1	-
Edmondson, T., London	10	-	-
Edmondson, Mrs., do.	10	-	-
Fenton, J.	10	6	-
Ford, W.	1	1	-
Gibbins, Mrs. J., Birmingham	2	2	-
Greene, Lieut.-Col. D. C.	2	2	-
Greene, T. E.	10	6	-
Greenwood, Robert	10	-	-
Greg, Albert	1	-	-
Hylwen, Mrs.	10	-	-
Hartley, Mrs. H. B., Morecambes	10	-	-
Hatch, J. & Sons	10	6	-
Helme, James	10	6	-
Hinde, Miss, South Place	1	-	-
Hodgson, Thomas	10	-	-
Hornby, E. G. S.	10	-	-
Jackson, Edmund, the late	5	-	-
Lampert, Miss F. A.	10	-	-
Lancaster Quay Commissioners	5	5	-
Lancaster Banking Co.	3	3	-
Leeming, Misses	10	-	-
Leeming, J.	1	-	-
Leeming, J. W.	1	-	-
Lord, James	10	-	-
Lowndes, Miss	10	-	-
Lowndes, Miss Kate	1	-	-
Mansergh, R.	5	-	-
Maxsted, G. W.	1	1	-
Mitchell, W., Belle Vue	1	1	-
Moss, Mrs. A. E.	10	-	-
Noon, Mrs.	10	-	-
Parker, Mrs. M. E.	1	1	-
Peacock, Mrs.	1	-	-
Preston, J. T.	10	-	-
Pritt, Rev. F. D.	10	-	-
Ray, R.	10	-	-
Richmond, W.	5	-	-
Rigby, Rev. J. P.	10	6	-
Roper, W. O.	5	-	-
Ross, the Rev. Dr.	10	6	-
Royds, Rev. C. T.	1	1	-
Royds, Mrs., Heysbam Cottage	1	1	-
Russell, Capt. A.	10	6	-
Sanderson, J.	10	6	-
Satterthwaite, A.	10	6	-
Saunders, C. M.	1	1	-
Seward Abram	5	-	-
Sharp, Mrs. Jno., the late	1	1	-
Sherson, Miss	1	1	-
Simpson, M.	1	1	-
Skirrow, J.	5	-	-
Slinger, J.	10	-	-
Sly, Colonel	5	-	-
Stokes, Major	1	1	-
Storey, Edward	10	6	-
Storey, Str T.	1	-	-
Storey, Mrs. Joseph	10	-	-
Swainson, Wm.	5	-	-
Taylor, J.	1	-	-
Taylor, R.	1	-	-
Thompson, S. & Co.	1	-	-
Townley, Miss	10	-	-
Walker, Mrs.	5	-	-
Walmsley and Smith	1	-	-
Watson, Mrs.	5	-	-
Wearing, J. W.	10	-	-
Welch, W. G.	1	1	-
Welch, Miss	5	-	-
Wells & Sons	10	6	-
Wilkinson Bros.	5	-	-
Wingate-Saul, Dr.	10	6	-
W. W.	10	6	-

	£.	s.	d.
Woods, Miss	10	-	-
Wright, Harold	5	-	-
Sums under 5s.	1	2	6
Total	276	16	6

Donations.

Anonymous	45	-	-
Briggs, Master W. N.	15	-	-
Conservative Club	12	-	-
County Hotel	9	8	-
Harrison, Master E. 2	6	-	-
Hornby, E. G. S.	25	-	-
Moss, Mrs. A. E.	10	-	-
Offertory, Children's, at Christ Church, per Rev. M. Ker	3	11	-
Cooper	3	11	-
Sums under 5s.	17	-	-
Bank Interest	1	8	2
Total Dons.	80	3	4
Total Subs.	76	16	6
	156	19	10

PORT OF LIVERPOOL BRANCH.

President—

The LORD MAYOR OF LIVERPOOL.

Vice-Presidents—

The MAYOR OF BIRKENHEAD.
The MAYOR OF BOOTLE.
WILLIAM RATHBONE.
SAMUEL SMITH, M.P.
R. D. HOLT, J.P.
T. H. ISMAY.
STEPHEN WILLIAMSON.
SIR WILLIAM B. FORWOOD.
EDMUND TAYLOR.

Liverpool Committee—

F. HENDERSON, C.C., J.P.,
Chairman.
H. D. BATESON, Deputy
Chairman.
W. CHADWICK.
D. CUNNINGHAM.
W. R. GARDNER.
Rev. CHARLES GARRETT.
Admiral GOUGH, C.B.
Rev. CANON LESTER.
R. E. LANGRISH.
W. D. MACK.
Rev. CANON STEWART.

Hon. Treasurer—

J. ASTLEY GARDNER.

Joint Hon. Secretaries—

A. R. MARSHALL.
P. HUGH MARSHALL.

LADIES' AUXILIARY.

President—

The Countess of DERBY.

Vice-Presidents—

Mrs. OLDAM.
Mrs. BELL.

Hon. Treasurer—

Miss BOWRING.

Hon. Secretary—

Mrs. W. B. BOWRING.

New Brighton Committee—

WILLIAM BELL, J.P.,
Chairman.
F. J. CHEESBROUGH.
Capt. F. I. I. ELLIOT, R.N.

Captain HERRON, J.P.
Rev. C. H. HYLTON STEWART.
B. J. KIRKHAM.
J. H. MACDONALD.
F. NEWSTEAD.
Hon. Sec.—HUGH B. KENT.

Birkenhead Committee—

President—
The MAYOR OF BIRKENHEAD.
C. J. BUSHELL.
F. C. DANSON.
H. H. GRAYTON.
R. HENDERSON.
C. LIVINGSTONE.
N. MACVICAR.
Hon. Sec.—G. H. POTTER.

Bootle Committee—

President—
W. POULSON, J.P.

The MAYOR OF BOOTLE (ISAAC
A. MACK, J.P.).

B. S. JOHNSON, J.P.
J. W. SCHOLEFIELD, J.P.
E. W. CROPPER, J.P.
THOMAS FALLOWS, J.P.
Capt. THOMAS DURRANT,
R.N.R.

Capt. A. WELLESLEY
BREMNER.

WILLIAM THOMAS, J.P.
Capt. THOMAS.

Capt. PRIEST.
JOSEPH FORRESTER.

Hon. Sec.—W. H. HICKSON.

Hon. Treasurer—

JOSEPH GARDNER, J.P.

Hoylelake Committee—

Patron—

His Grace THE DUKE OF WESTMINSTER.

President—

T. H. ISMAY.

ALEXANDER SINCLAIR, Chair-
man.

ST. CLARE BYRNE.
GEORGE H. COX.

J. GLYNN.
JOHN JOLLY.

Rev. A. H. KING.
HAROLD WRIGLEY.

J. T. COCHRANE.
J. HICKS.

Hon. Sec.—W. C. GLOVER.

Formby Committee—

President—

JOHN FORMBY.

J. S. BEAUFORD, Chairman.
HAROLD L. BOWER.

S. GIBSON SINCLAIR.
Capt. LOW.

Capt. BELLINGE, R.N.R.
S. W. HIGGIN.

Hon. Sec.—

Capt. PHILLIPS, R.N.

Assist. Sec. at Liverpool—
MATTHEW HENDRIE.

Assist. Treasurer at New
Brighton—

T. J. BAILEY.

Assist. Sec. at New Brighton—
DAVID O'BRIEN.

Annual Subscriptions.

	£.	s.	d.
Abraham, Miss E. C.	1	1	-
Abraham, Mrs. M. H.	1	1	-
Adam, E. Esq., M.D.	1	1	-
Adamson, Wm. Esq.	1	1	-
Alexander, Robt. Esq.	1	1	-

	£.	s.	d.
Alexander, W. H. Esq.	1	1	-
Allardice, D. W. Esq.	1	-	-
Anderson, D. Esq.	1	1	-
Anderson, Miss	10	-	-
Anderson, W. B. Esq.	1	1	-
Anderson, W. H. Esq.	1	1	-
Anglo-American Rope & Oakum Co.	1	1	-
Ashe, T. F. & Nephew, Messrs.	1	1	-
Aspinal, Son, and Brooke, Messrs.	1	1	-
Atkinson, H. Esq.	1	-	-
Austin, W.	10	-	-
Bacon, J. S. Ltd.	2	2	-
Bacon, S. S.	1	1	-
Badger, Joseph R. Esq. (the late)	2	2	-
Balfour, Williamson, and Co. Messrs.	20	-	-
Banner, Hartwood & Son, Messrs.	1	1	-
Banner, Miss.	10	6	-
Baring, W. B.	1	-	-
Barrow, James, Esq.	1	1	-
Bartlett, J. Adams, Esq.	1	1	-
Bartlett, Thos. Esq.	1	1	-
Bartlett, Wm. Esq.	1	1	-
Bates, E. and Sons, Messrs.	2	2	-
Bateson, H. D. Esq.	1	1	-
Baylis, T. H. Esq. Q.C.	1	1	-
Beauford, J. S.	1	1	-
Beazley, James H., Esq.	1	1	-
Belcher, Wm. M., Colonel	10	6	-
Bellinge, Capt.	1	1	-
Beloe, Charles H. Esq.	1	1	-
Bennett, Geo. W. Esq.	1	1	-
Bibby, Brothers & Co.	2	2	-
Bickersteth, Herbert, Esq.	10	-	-
Blain, Mrs.	1	1	-
Blessig, Braun & Co. Messrs.	1	1	-
Boadle, J. W. Esq.	1	1	-
Booker, Geo., & Co.	3	3	-
Booth, Alfred, & Co.	10	10	-
Booth Steamship Co., Limited	10	10	-
Bouch, T. W. Esq.	1	1	-
Bowring, C. T. & Co. Messrs.	2	2	-
Boxwell, Wm. Esq.	1	1	-
Boyd, Mrs. E.	1	1	-
Boyd, Mrs. M.	1	1	-
Bradburn, Isaac, Esq.	1	1	-
Bradbury & Hirsch	2	2	-
Branker, John, Esq.	1	1	-
Brandreth, H. P. Esq.	1	1	-
Brandreth, Thos. Esq.	2	2	-
Bretherton, F. S. Esq.	1	1	-
Brierley, Rowley & Co., Messrs.	2	2	-
Bristow, J. Esq.	1	1	-
British and African Steam Navigation Company	2	2	-
British and Eastern Shipping Company, Limited	2	2	-
Brocklebank, Ralph	2	2	-
Brocklehurst, G. W., Esq.	5	5	-
Brocklehurst, H. Esq.	2	2	-
Brocklehurst, R. Esq.	1	1	-
Brocklehurst, S. Esq.	1	1	-
Bull, James G. Esq.	1	1	-
Bulman, Richard, & Co.	1	1	-
Burrows, Henry, Esq. (the late)	2	-	-
Bushby, John, Esq.	1	1	-
Calvert, Capt.	1	1	-
Cameron, John, Esq., M.D.	2	2	-

£.	s.	d.	£.	s.	d.	£.	s.	d.	£.	s.	d.
Campbell, Mrs. Pitcairn	1	1	Gooftass, Walt, and Co. Messrs.	1	1	Laird Bros. Messrs.	2	2	Pickford Brothers, Messrs.	1	1
Cannington, Shaw & Co., Ltd., Messrs.	1	1	Goodwin, G. S. Esq.	1	1	Laird, Miss A. M.	1	1	Pitkington, Geo. Esq.	1	1
Carver Bros. and Co., Messrs.	1	1	Gordon, James & Co. Messrs.	1	1	Lampont and Holt, Messrs.	5	5	Porter, W. S. Esq.	1	1
Cheesbrough, F. J. Esq.	1	1	Gordon, Mrs.	1	1	Langlands and Sons, Messrs.	1	1	Porter, Wm. & Co. Messrs.	1	1
Clar., Mrs. J. F. Leigh	1	1	Gossage, Mrs. F. H.	1	1	Langton, Chas. Esq.	1	1	Pratt, John R. Esq.	1	1
Clarkson, Wm. Esq.	1	1	Gostenhofer, C. T. Esq.	3	3	Langton, Miss	1	1	Quiggin, John M. Esq.	10	6
Clayton, Mrs. J. S.	1	1	Gough, Admiral, C.B.	1	1	Law, Fredk. F. Esq.	1	1	Rae, George, Esq.	2	2
Cliff, Mrs.	1	1	Graham, Mrs. Henry	2	2	Lawrence, W. F. Esq., M.P.	1	1	Ralli, Robt. Messrs.	2	2
Cliff, Miss A. M.	2	2	Graham Rowe & Co.	5	5	Lemonius, A. H. Esq.	1	1	Rankine, Adam G. Esq.	1	1
Cockbain, Alhardie & Co., Messrs.	2	2	Greenhields, T. E. Esq.	1	1	Lewis & Mounsey	1	1	Rathbone, Benson, Mrs.	2	2
Coffe, Mrs.	5	5	Greenhields, Cowie, & Co., Messrs.	2	2	Lindley, Mrs.	1	1	Rathbone, H. R. Esq.	5	5
Comber, Thos. Esq.	1	1	Gruning & Co. Messrs.	2	2	Lister, Jas. Esq.	1	1	Rathbone Brothers and Co. Messrs.	5	5
Cookson, Edward H., Esq.	1	1	Hautner, Thos. Esq.	10	6	Litherland, W. & Co. Messrs.	1	1	Rathbone, S. G. Esq.	2	2
Cookson, Mrs. T. W.	1	1	Hanway and Co. Messrs.	2	2	Little, William, Esq.	2	2	Rathbone, Wm. Esq.	5	5
Cookson, T. W. Esq.	1	1	Harding, Thos. Esq.	1	1	Liverpool Steam Tug Co., Limited	1	1	Rawdon, J. F. Esq.	10	6
Cope, Miss Alice	1	1	Harris, W. S. Esq.	1	1	Lockett, W. & J., Messrs.	2	2	Rayner, Mrs. Lloyd	1	1
Cox, G. R. Esq.	1	1	Harrison, E. H. Esq.	1	1	Lord Bishop of L'pool	5	5	Read, Col. Alfred	2	2
Crook, Walter H. Esq.	1	1	Harrison, Fred. J. Esq.	2	2	Macfie & Sons, Messrs.	2	2	Reade, T. Mellard, Esq.	1	1
Crooks, Mrs.	1	1	Harrison, H. P. Esq.	2	2	McDiarmid, J. Esq.	1	1	Rees, Miss	1	1
Crooks, B. F. Esq.	2	2	Harrison, Jas. Esq.	1	1	McDiarmid, Miss Eva	5	5	Rew, Mrs.	1	1
Crosbie, Col. Chas. E.	1	1	Harrison, James B. Esq.	1	1	Macrae, G. G. Esq.	5	5	Rhyner, Chas. Esq.	1	1
Crosfield, C. J. Esq.	1	1	Harrison, Thos. Esq.	1	1	McCulloch, A. M. & Co., Messrs.	1	1	Rigby, Colonel W. A.	1	1
Crosfield, Wm. Esq.	1	1	Harrison, T. Fenwick, Esq.	1	1	McPherson, Miss F.	10	10	Rigby, Miss L. E.	10	10
Crothwaite, Arthur, Esq.	1	1	Harrison, T. and J. Messrs.	5	5	MacIver & Co.	2	2	Roberts, E. F. & W.	2	2
Cunard S.S. Co., Limited	10	10	Hartley, W. P. Esq.	2	2	Macvicar, Marshall, and Co.	2	2	Roberts & Co., Messrs.	1	1
Currey, Major Henry	1	1	Hayes, W. Jun. Esq.	3	3	Mack, Mrs. W. D.	1	1	Robert, Limited	1	1
Darsie, Geo. R. Esq.	1	1	Hayward, G. F. & Co.	1	1	Mack, W. D. Esq.	1	1	Robertson, Crowe & Co. Messrs.	1	1
Davidson, E. W. Esq.	2	2	Heap, R. R. Esq.	1	1	Maddock, F. T. Esq.	1	1	Robin, Rev. Canon	1	1
Davidson, Mrs.	1	1	Hecht, Lewis & Kahn, Messrs.	1	1	Mahler, John, Esq.	1	1	Robinson, Miss M. E.	1	1
Davies, Ellis & Co., Messrs.	1	1	Henderson, F. Esq.	1	1	Mahler, John, Junr., Esq.	1	1	Robinson, Robt. Esq.	1	1
De-Jersey & Co.	1	1	Henderson, Capt. H.	1	1	Makin, T. Esq. (the late)	1	1	Robinson, Thos. Esq.	1	1
Dempster, John, Esq.	1	1	Henderson, John, Esq., J.P.	2	2	Malandrinos, B. A.	10	6	Robinson, W. L. Esq.	1	1
Derby, Right Hon. The Earl of, G.C.B.	5	5	Henderson, W. G. Esq.	2	2	Maples Bros.	1	1	Rome, Thomas, Esq.	1	1
Dowie, James, & Co. Messrs.	1	1	Herschell, Adolph, Esq.	1	1	Marquis, Robt. Esq.	1	1	Ronald and Rodger, Messrs.	3	3
Duncan Fox & Co.	1	1	Higgin, Capt.	1	1	Maxwell, W. Esq.	2	2	Rundell, T. W. Esq.	1	1
Duranty, Widow & Son, Messrs.	1	1	Hill, J. E. Gray, Esq.	1	1	Meade-King, R. R. Esq.	1	1	Samuelson, James, & Sons.	2	2
Earles and King, Limited, Messrs.	1	1	Hind, J. H. & Co.	2	2	Mellor, G. H. Esq.	1	1	Sanday, S. & Co.	3	3
"E. C."	1	1	Holder, James, Esq.	1	1	Mellor, J. H. Esq.	1	1	Scholefield, J. W. Esq.	1	1
Eccles, Alex. & Co., Messrs.	1	1	Holder, Thomas, Esq. (the late)	1	1	Mersey Docks and Harbour Works	1000	1000	Sellars, Frank, Esq.	20	20
Eccles, E. S. Esq.	1	1	Holland, Walter, Esq.	1	1	Mill, Mrs. Jas.	1	1	Servaes, Julius, Esq.	1	1
Edwards, T. H.	2	2	Holt, Alfred, Esq.	1	1	Minton, R. R. & Co. Messrs.	1	1	Shaw, Ad. Thos.	10	6
Ellis & Co.	2	2	Hope, T. A. Esq.	1	1	Montreal Ocean S.S. Co.	5	5	Simpson, Walter Maddoc, Esq.	1	1
Elder, Dempster, and Co. Messrs.	1	1	Horaby, H. H. Esq.	1	1	Moore, Miss Sophia	1	1	Sinclair, W. P. & Co., Messrs.	1	1
Elkington and Co. Messrs., Limited	1	1	Horsfall, H. Douglas, Esq.	2	2	Morgan, Walter, Esq.	10	6	Slater, J. Esq.	1	1
Fallows, John	10	6	Hough, Samuel, Esq.	1	1	Morris & Jones, Messrs.	10	6	Smart & Co., Messrs.	2	2
Fletcher, G. H. & Co. Messrs.	1	1	Houghton, Miss Jane	1	1	Moses, George E. Esq.	2	2	Smith, Alexander M. and Co., Messrs.	3	3
Franceys, A. Esq.	1	1	Houder Brothers & Co., Messrs.	2	2	Muspratt, E. K. Esq.	1	1	Smith, Edwards & Co. Messrs.	2	2
Friend, E. C. and Co. Messrs.	10	6	Hughes, John W. Esq.	1	1	Neill, James, Esq.	1	1	Smith, Elisha, Esq.	1	1
Gair, H. W. Esq.	2	2	Hughes, Thos. Esq.	1	1	Neilson, R. L. Esq.	1	1	Smith, James, Esq., J.P.	1	1
Gamble, Col. D.C.B.	1	1	Hutchinson, Edward, Esq. (the late)	2	2	Neilson, Miss E. M.	1	1	Smith, J. Barkeley, Esq.	1	1
Gardner, Col. T.	1	1	Iblers & Bell, Messrs.	1	1	Neilson, R. L. Esq.	1	1	Smith, Robt. Esq.	1	1
Gardner, G. N. & Co.	1	1	Imrie, W. Esq.	1	1	Nicol, Messrs. Wm. & Co.	1	1	Smith, Robert H. Esq.	1	1
Gardner, Henry, Esq.	1	1	Innes, James, Esq.	1	1	Nicholson & McGill, Messrs.	1	1	Smith, Samuel, Esq., M.P.	5	5
Gardner, W. R. Esq.	5	5	Ismay, Imrie, & Co. Messrs.	2	2	Nicholson, R. & Sons, Messrs.	1	1	Smyth, Ross, T. & Co. Messrs.	2	2
Gardner, J. Astley, Esq.	10	6	J. K. C.	1	1	Nickels, J. T. & Co., Messrs.	2	2	Soley, G. T. & Co., Limited	1	1
Gardner, Miss M. R.	10	6	Jackson, Alfred, Esq.	1	1	Neilson, R. L. Esq.	1	1	Sparrow, A. Esq.	1	1
Gardner, W. Esq.	1	1	Jackson, R. Esq.	10	6	Owen Owen, Esq.	1	1	Springmann & Co. Messrs. E.	10	6
Garnier, Rev. J. C.	1	1	Japp & Kirby, Messrs.	1	1	Pacific Steam Navigation Co.	5	5	Squarey & Kendall	1	1
Garnett, Alex. Esq.	1	1	Jardine, D. Esq.	5	5	Pain, Coard S. Esq.	1	1	Stevenson, Geo. Esq.	2	2
Geddes, Wm. & Sons, Messrs.	1	1	Johnston, W. and Co. Messrs., Ltd.	5	5	Papayanni and Co. Messrs.	2	2	Stevenson, John, Esq.	1	1
Gillespie & Co. Messrs.	1	1	Jones, Edw. W. Esq.	1	1	Parker, A. T. Esq.	1	1	Stevenson, John & Co.	1	1
Gillson & Chadwick	2	2	Jones, Mrs. C. W.	1	1	Parker, E. Esq.	10	6	Stone, Geo. Esq.	10	6
Gilmour, H. B. Esq.	1	1	Jones, Thos. & Co. Ltd.	1	1	Parker, Mrs. Ellen	1	1	Stringer, Miss	1	1
Given, John, Esq.	1	1	Just, Wm. & Co.	1	1	Parke, W. E.	10	6	Swire, John, & Sons, Messrs.	2	2
Gladstone, Robt. Esq.	1	1	Karck, Geo. F. Esq.	10	10	Parr, H. B. Esq.	2	2	Tate, Henry & Sons, Limited	1	1
Glynn, Jno. & Son, Messrs.	1	1	Ker, The Misses	10	10	Perkins, Hugh, Esq.	3	3	Taylor, Chas., Sons, & Co., Messrs.	1	1
Goffey, Thomas, Esq.	1	1	King, W. Esq.	1	1	Perrin, E. H. & Co.	2	2	Taylor, Edmund, Esq.	1	1
Goodison, G. W. Esq., J.P.	1	1	Kurtz, Charles & Sons, Messrs.	2	2	Perry, S. H. Esq.	1	1	Taylor, Staveley & Co., Messrs.	1	1
						Phillip, Son, and Nephew, Messrs.	1	1			

ANNUAL SUBSCRIPTIONS AND DONATIONS TO BRANCHES.

	£.	s.	d.
Temple, Miss.....	1	-	-
Thompson, Anderson, and Co. Messrs.	1	1	-
Thompson, E., Esq.	10	6	-
Thomson, I. Esq.	1	1	-
Thomson, W. Esq.	1	1	-
Thraves, Arth. Esq.	1	1	-
Thraves, E. Esq.	10	6	-
Threlfall's Brewery Co. Limited.....	2	2	-
Tilston, Jos. R. Esq.	1	1	-
Timmis, Mrs. Jane.	1	1	-
Timmis, T. Sutton, Esq.	5	5	-
Tomlinson, Hodgetta and Co. Messrs.	1	1	-
Turner, Alfred, Esq. (the late).....	2	2	-
Turner, Geo. Esq.	1	1	-
Turner & Dunnett, Messrs.	1	1	-
Turner, Mrs.	2	2	-
Tyzer, Alfred, Esq.	1	1	-
Waddell, R. Kerr, Esq.	1	-	-
Wainwright, Mrs. R.	1	1	-
Walker, A. and Co. Messrs.	2	2	-
Warren, G. H. Esq.	2	2	-
Warrington Wire- Rope Works, Ltd., per J. Temple, Esq.	1	-	-
Waterhouse, Miss M. E.	1	-	-
Watson, Charles S. Esq.	1	1	-
Watson, Christopher, Esq.	1	1	-
Watson, Hy. Esq.	1	1	-
Webster, James, Esq.	1	1	-
West, Montague, Esq.	1	1	-
West India and Pacific Steam Ship Co., Limited.....	2	2	-
"White Star Line," per Messrs. Ismay, Laurie & Co.	5	5	-
White, Alex. & Sons, Messrs.	1	1	-
Wigan Coal & Iron Co. (Lim.) Messrs.	1	1	-
Williams, Owen Hugh, Esq.	1	1	-
Williamson, Milligan & Co. Messrs.	1	1	-
Windram, G. Esq.	1	1	-
Wood & Cousin.	1	1	-
Wood, Henry, & Co. Messrs.	1	1	-
Wright, Crossley & Co. Messrs.	1	1	-
Wright, W. & Co.	2	2	-
Wylie, Miss Annie.	1	1	-
Yates, E. W. and Co. Messrs.	1	1	-
Young, F. W. Esq.	5	5	-
Total	£1627	14	-

Box List.

Bateon, Walter, Esq.	1	-	-
Birkenhead Railway Station Refresh- ment Room.....	19	3	-
Cowden, Joseph.....	12	-	-
Cox, Miss.....	7	1	-
Lawoove Golf Club, per Mr. Cromarty.	14	4	-
Mercantile Marine Office, Canning Place.....	19	8	2
Mercantile Marine Office, Garston.....	13	8	-
Mercantile Marine Office, Burton St.	1	6	3
Royal Restaurant, per Geo. E. Moses.	1	7	9
Simpson's Refresh- ment Rooms, Land- ing Stage.....	5	8	-

St. Margaret's, Princes Park.....	5	2	-
Woodside Ferry.....	15	0	-
Sums under 5s.....	12	5	-
Total	£29	6	9

Donations.

A. Friend, per W. Fawcett.....	2	-	-
Austin, Wm. Esq.	5	-	-
Bank of Liverpool, Clerks of.....	1	-	-
Bates, E. and Sons, Messrs.	10	-	-
Bell, Geo. Esq.	1	1	-
Bewley, Jno. Esq. (the late).....	1	1	-
Brown, Geo. Henry, Esq.	1	-	-
Cowie, C. G. Esq.	1	-	-
"D.".....	1	-	-
Davies, T. Esq.	1	1	-
De Ker, H. Esq.	1	1	-
Jones, E. Stewart, Esq.	1	-	-
Latham, Hy. A. Esq.	5	-	-
Maxwell, Wm. Esq.	5	-	-
Maxwell, Welwood, Esq.	10	-	-
Piedmendes, W.	1	-	-
Proceeds of Enter- tainment by Pupils, Windsor High School, per Mrs. E. Bckett.....	56	18	-
Proceeds New Brighton Fancy Dress Ball, per C. Huxley, Esq.	25	-	-
Proceeds New Brighton Cyclists Parade, per Dr. Bell.....	110	-	-
Ratbone, S. G. Esq.	5	-	-
Ratner, W. Esq.	1	-	-
Rocoe, W. Esq.	5	-	-
Rutter, F. W. P.	1	-	-
Sanders, J. jun.	5	-	-
Shaw, Frank, Esq.	5	-	-
Ship Strabo, per Mr. Jardine.....	2	5	6
Ship Stronsa, Capt. Chas. Brooks	2	-	-
Smith, Edwards & Co., Messrs.	5	-	-
S.S. Orellana, Capt. Cook.....	1	12	9
S.S. Pedro.....	1	1	4
Terry, W. F.	5	-	-
Walthew, Wm. Esq.	10	6	-
Sums under 5s.....	2	6	-
Total	£214	18	7

Legacies.

Groome, Mrs. Helen (the late).....	1050	-	-
---------------------------------------	------	---	---

Church and Chapel Collections.

Brassey Street Mis- sion, Birkenhead (Bible-class), per Arnold Herschell, Esq.	1	1	-
Queen's Road Presby- terian Church.....	1	11	6
St. Luke's Church, Formby.....	8	1	7
St. Nicholas Church, Blundellsands.....	5	9	-
Total	£16	3	1

LADIES' AUXILIARIES.

Branch Collections.

Aigburgh (Mrs. Hors- fall, President).....	30	16	10
---	----	----	----

Birkenhead (Mrs. Adham, President).....	5	3	6
Blundellsands (Lady Forwood, Presi- dent).....	35	9	8
Bootle (Mrs. Mack, President).....	26	6	-
Central Liverpool (Mrs. Bowes, Presi- dent).....	21	1	3
Garston and Cressing- ton (Miss Tinne, President).....	23	11	11
Hoyle and West Kirby (Mrs. Sin- clair, President).....	61	2	-
New Brighton (Mrs. Che-sbrough, Presi- dent).....	65	-	-
Princes Park (Mrs. Gordon Brown, President).....	17	1	-
Rock Ferry (Mrs. Atkin, President).....	45	8	6
Seaforth and Water- loo (Mrs. E. K. Muspratt, Presi- dent).....	62	3	1
Upton (Mrs. Hannay, President).....	9	13	-
Wavertree, Broad Green and Od Swan (Miss Bram- well Jones, Presi- dent).....	51	4	2
Woolton, Allerton, Gateacre and Hall- wood (Mrs. Brockle- bank, President).....	14	17	9
"A Friend".....	2	6	-
Collecting Boxes, per Treasurer.....	19	10	-
Total	£530	1	-

COLLECTED AT NEW BRIGHTON.

Subscriptions.

Bailey, J. Esq.	5	-	-
Bell, W. Esq. M.D.	1	1	-
Browne, Miss M. F.	10	-	-
Comberbach, W. S. Esq.	10	-	-
Clover, Clayton & Co., Messrs.	2	2	-
Cunningham, H. Esq.	1	1	-
Esgrigge, R. A. Esq.	10	6	-
Evans, T. Esq.	5	-	-
Greenwood, W. H. Esq.	1	-	-
Gunson, Messrs. G. & Son.....	1	1	-
Harris, George, Esq.	10	6	-
Hamilton, J. L. C. Esq.	1	1	-
Hind, Mis.....	5	-	-
Houghton, H. J. Esq.	1	1	-
Hutchison, W. H. Esq.	10	6	-
Marshall, Bulley & Sons.....	1	1	-
Martin, J. T. Esq.	10	6	-
Molyneux, Mrs.	1	1	-
Monk, Mrs. J.	10	-	-
Murless, C. F. Esq.	5	-	-
Naylor, R. E. L. Esq.	2	-	-
Newstead, F. Esq.	10	6	-
North, F. Esq.	1	1	-
Peers, Messrs. J. & Sons.....	10	6	-
Pim, Miss.....	5	-	-
Ravenscroft, W. E. Esq.	1	1	-
Roberts, J. S. Esq.	5	-	-
Roberts, Mrs.	10	-	-
Rose, C. Esq.	5	-	-
Sampson, T. & W.	5	-	-
Scott, F. F. Esq.	5	-	-
Smith, H. Esq.	5	-	-
Smith, Miss A.	1	1	-
Snow, E. G. E. Esq.	5	-	-

Steel, R. Esq.	10	6	-
Stewart, Rev. C.	1	1	-
Hyton.....	1	1	-
Tate, W. N.	1	1	-
Theckston, J. Esq.	5	-	-
Thornwell, E. J. Esq.	1	1	-
Tyson, J. B. Esq.	1	1	-
Williams, W. A. Esq.	1	1	-
Total	£29	10	6

Donations.

McDonald, J. W.	1	1	-
Montpelier Club.....	1	-	-
Total	£3	1	-

Boxes.

New Brighton Hotel	6	10	-
New Brighton Stage	10	3	-
Sayers, Mrs.	6	-	-
Victoria Hotel.....	5	-	-
Boxes under 5s.	14	3	-
Total	£2	2	4

COLLECTED AT HOYLAKES.

Subscriptions.

Jantou, H. Esq.	1	1	-
King, Rev. A. H.	5	-	-
Sinclair, A. Esq.	1	1	-
Westminster, His Grace the Duke of, K.G.	5	-	-
Wrigley, H. Esq.	2	2	-
Total	£3	9	-

Donations.

Box.....	1	9	6
Mrs. Spencer's chil- dren.....	1	2	1
Bowdle, A., and Mar- wood, J. H.	1	1	11
Bagshaw, Professor, 4	12	-	-
Boxes under 5s.	14	5	-
Total	£3	19	11

COLLECTED AT FORMBY.

Subscriptions.

Formby, J.	1	1	-
Subscriptions per Mr. Jellico.....	2	10	-
Total	£3	11	-

Donations.

Collected by Capt. Bellings.....	5	5	-
Collected at christen- ing.....	4	2	-
Collected by Mr. Der and Miss V. Phillips.....	10	-	-
St. Nicholas Church, Blundellsands.....	18	9	-
Total	£27	17	9

COLLECTED AT BOOTLE.

Subscriptions.

Atkinson, J. H. F. Esq.	1	1	-
Barnes, James, Esq.	1	1	-

Cowley, Ed. Esq.	5	-
Forrester, J. Esq.	1	1
Forshaw, John, Esq.	1	1
Gardner, Joseph, Esq.	5	-
Hickson, W. H. Esq.	10	-
Inglis, Capt.	10	-
Kelson, F. C. Esq.	10	6
Pennington, A. Esq.	1	1
Pidgeon, W. P. Esq.	10	6
Poulsom, Wm. Esq.	5	-
Priest, Capt.	10	-
Stuart, Dr. Peter	1	1
Thomas, W. Esq.	1	-
Wells, Chas. Esq.	1	1
Total	£21	3

SUMMARY.

Subscriptions	1627	14
Donations	244	7
Legacies	1050	-
Collecting Boxes	29	6
Church and Chapel Collections	16	3
Ladies' Auxiliaries	530	1
New Brighton	33	10
Hoylake	18	8
Formby	31	9
Bootle	21	3
Total	£3603	6

LYTHAM BRANCH.

Local Committee—

- Rev. CANON HAWKINS, Chairman.
- Mr. R. L. ASCROFT.
- Mr. G. R. BELLAMY.
- Mr. SOLM BUTCHER.
- Mr. J. TALBOT FAIR.
- Mr. THOS. FAIR, J.P.
- Dr. FISHER.
- Mr. F. FLETCHER.
- Mr. HANRINSON.
- Mr. J. H. HARRISON.
- Mr. W. H. HINCKMAN, J.P.
- Mr. S. WARTENBERG.
- Mr. T. WINDEBANK.

Hon. Treasurer—
Mr. W. P. FULLAGAR.

Hon. Secretary—
Mr. C. A. MYERS.

Annual Subscriptions.

Ascroft, R. L. Esq.	5	-
Bazley, The Dowager Lady	1	1
Bellamy, G. R. Esq.	10	6
Clegg, Miss	5	-
Clifton, John Talbot, Esq.	3	3
Cockcroft, Miss	10	-
Fair, J. Talbot, Esq.	1	1
Fair, Thos. Esq., J.P.	1	1
Fisher, Dr.	1	1
Fletcher, F. Esq.	10	6
Fullagar, W. P. Esq.	10	6
Harrison, Miss	10	-
Hawkins, Rev. Canon	1	1
Hinckman, Major, J.P.	1	1
Jewison, Mrs.	1	1
Leigh, Mrs.	5	5
Makinson, Mr.	1	1
Mellor, E. W. Esq.	1	1
Morewood, Mrs.	1	-
Munspratt, J. P. Esq.	10	6
Ormerod, Miss	1	1
Ormerod, Miss J.	1	1
Ormerod, Mrs.	1	1
Salt, Mrs.	1	1
Smith, Miss E.	1	-
Thompson, R. Heywood, Esq.	1	1

Thornley, W. E. Esq.	10	6
Threlfall, Mrs.	1	-
Wartenberg, S. Esq.	1	-
Sums under 5s.	7	6
Total	£31	12

SPECIAL SUBSCRIPTIONS AND DONATIONS FROM THE MEMBERS OF THE LYTHAM AND ST. ANNE'S GOLF CLUB.

Haworth, G. C. Esq.	5	-
Hemingway, C. R. Esq.	5	-
Lees, Gilbert, Esq.	5	-
Midwood, T. C. Esq.	1	1
Parke, Herbert Esq.	2	2
Pilkington, C. Esq.	1	1
Pilkington, L. Esq.	1	1
Smith, C. T. Esq.	5	-
Total	£14	14

Less one-half to St. Anne's Branch 7 7

Legacy.

Hampson, Mrs. Sarah (the late)	£240	4
--	------	---

Contribution Boxes.

Life-boat House and Promenade Pillars. Ship Hotel. Lytham Yacht Club. Market Hotel. Crozier, Mr. R. Clifton Arms Hotel. Edmondson, Mr. J. Railway Hotel. Queen's Hotel.	8	9
Gregson, Master Chas.	8	1
Collection at St. Cuthbert's Church 16 17 5		
Bank Interest	17	8
Total Dons	26	3
Legacy	240	4
Total Subs.	£305	7

MANCHESTER BRANCH.

Local Committee—

- THOMAS HARKER, J.P., Chairman.
- A. W. WILSON, Deputy Chairman.
- G. R. BELLAMY.
- R. P. BLAKELBY.
- D. B. BLES, J.P.
- J. A. CARSE.
- J. CORBETT.
- J. H. CORNS.
- Chevaliere FREGELICH.
- A. A. GILLIES.
- S. B. KENDAL.
- B. LOCKWOOD.
- H. MARSDEN.
- JONATHAN NORBERT.
- H. L. PRICE.
- P. J. RAMSAY.
- F. SHORE.
- C. STEVENSON.
- W. B. SUTTLE.

Honorary Treasurer—
A. MUIR.

Secretary—
F. WOMERSLEY, 1, Piccadilly, Manchester.

Annual Subscriptions.

Agnew, J. H. & Br.	10	6
Andrew, G. and Sons	1	1
Armistead, R.	1	1
Ashton, Thos.	2	2
Aspell Bros.	2	2
Barbour, Robt. & Br.	3	3
Barclay, R. and Co.	1	1
Barlow, T. & Bros. for 1895	1	1
Barlow & Jones, Ltd.	1	1
Beattie, Altgeldt, and Co.	1	1
Behrens, the Messrs.	4	4
Bell, W.	10	6
Bles, S. D. and Sons.	1	1
Briggs, T.	1	1

British and Foreign Marine Insurance Co., per J. H. Jones.	5	5
Brown, A. C. & Co.	10	6
Bruton, F. A.	10	6
Burton, F.	1	1
Carver Bros. and Co.	1	1
Clayton, G. E.	10	-
Craibtree, H. & Sons	1	1
Craig, Mrs. Jas.	1	1
Credwood, A.	1	1
Crofton, Craven and Worthington	2	2
De Trafford, Sir H. F. Bart.	5	-
Dewhurst, G. and R.	1	1
Dods, Ker, and Co.	1	1
Dugdale, J.	2	2
Eller & Co.	1	1
England, E. B.	1	5
Finlater & Mackie	1	1
Foster, T. B.	1	1
Fothergill & Harvey	1	1
Gaddud and Co.	1	1
Galbraith and Co.	2	2
Goldschmidt, Messrs. P.	1	1
Gray, Mrs.	1	1
Grover, F. A.	5	-
Gysl and Kleinjung.	1	1
Harker, T.	1	1
Harrison, Griffin and Co.	1	1
Heywood, A. H.	2	2
Higgin, Lloyd & Co.	2	2
Holliday, Wise & Co.	1	1
Hoyle, J., and Sons (Limited)	2	2
Hillingworth, Heywood & Agnew	2	2
Kendal, Milne & Co.	2	2
Kilvert, N., and Sons	1	1
King, Mrs.	1	1
Kolp and Co.	2	2
Langsdorf, F.	1	1
Lodge, M.	10	6
Liebert, E.	1	1
Lomnitz & Duxbury	1	1
Lyon, Lord, and Co.	1	1
Mark, John, J.P.	1	1
McKeand, Mrs.	1	1
Melland and Coward	1	1
Mertens and Co.	1	1
Moseley, D. & Sons.	1	1
Murray, A.	1	1
Nuttall, Harry	1	1
Patteson, J. & H.	1	1
Petrocchino Bros.	1	1
Phillips, H., J.P.	2	-
Phillips, J. & N. & Co.	10	10
Poltachi, G.	10	-
Railton, J.	1	1
Ralli Bros.	1	1
Ramsay, P. J.	1	1
Roberts, Miss	10	-
Samson, H.	1	1
Schwabe and Co., S.	2	2

Schuster, Fulda & Co.	1	1
Slagg and Co., John.	1	1
Smith, Walter	1	1
Taylor, Garnett & Co.	2	2
Thames and Mersey Marine Insurance Company	5	5
Toller, T. N.	1	1
Tootal, Broadhurst, Lee Co. Ltd.	5	5
Watts, E.	1	1
Whitworth, E.	1	1
Wilson, A. W.	1	1
Wilson, Knowles & Co.	1	-
Woodhouse, Rev. Canon.	5	-
Woolley, H.	1	-
Wright and Co., J.	1	1
Ziegler, Ph. and Co.	1	1
Total	£132	6

Legacy.

Exors. of the late Mrs. Mattha Pratt, of Stanley House, Stanley Grove, Oxford Road, Manchester, per Messrs. Ormerod & Allen, Solicitors 1800

Donations.

Adamson, John, Son & Co.	1	1
Bank Interest	1	1
Barker, Thomas, J.P., special donation on the occasion of his Jubilee with Messrs. Rylands & Sons, Ltd.	25	-
Charleston Gospel Temperance Mission Harvest Thanksgiving Collection, per O. B. Dickens	2	5
Webster, Tom	10	6
Total Dons	29	16
Total Subs.	332	6
Total Legacy	1800	-
Total	£1962	3

OLDHAM BRANCH.

Chairman—
His Worship THE MAYOR.

Local Committee—

- Mr. THOS. ASHTON, J.P.
- Mr. JOSEPH BALL.
- Mr. ISAAC BAMFORD, J.P.
- Mr. J. W. CLEGG, J.P.
- Mr. JOHN DODD, J.P.
- Mr. ALFRED ERMOTT, J.P.
- Mr. F. HARDERN, J.P.
- Mr. JOSEPH LEEB, J.P.
- Mr. EDWARD MELLOR, J.P.
- Mr. F. NEWTON.
- Mr. S. R. PLATT, D.L., J.P.
- Mr. THOS. PLATT, J.P.
- Mr. EDWIN SCOTFIELD, J.P.
- Mr. SIDNEY STOTT.
- Mr. J. T. WARBURTON.

Hon. Treasurer—
Mr. A. WAYTE, J.P.

Hon. Secretary—
Mr. A. NICHOLSON.

Secretary and Collector—
Mr. R. W. COWFEE.

Annual Subscriptions.

	£.	s.	d.
Bamford, I., J.P.	1	1	-
Bodden, William, J.P.	1	1	-
"Backbone"	1	1	-
Cheetham, J. M.	1	1	-
Clegg, Abraham	1	1	-
Clegg, Jas. W., J.P.	3	3	-
Clegg, James W., High Crompton	1	1	-
Clegg, John E.	1	1	-
Clegg, Mrs. H., High Crompton	1	1	-
Clegg, Miss Mary T.	1	1	-
Crompton, Seville	1	1	-
Dodd, John, J.P.	1	1	-
Dronsfeld, Samuel	1	1	-
Emmott, Alfred, J.P.	1	1	-
Emmott, W. R.	1	1	-
Hamilton, Miss Marianne	1	1	-
Knott, Miss Hester A.	10	6	-
Leach, J. W.	1	1	-
Lees, Josh., J.P.	2	2	-
Newton, Frank	10	6	-
Newton, Jno. E., J.P.	10	6	-
Newton, Miss Emily	10	6	-
Newton, Mrs. F.	10	6	-
Oldham Equitable Co-oper. Soc., Ltd.	10	10	-
Oldham Industrial Co-oper. Soc., Ltd.	10	10	-
Palm Mill Co., Ltd.	1	-	-
Platt, S. R., J.P., D.L.	5	-	-
Platt, Thos., J.P.	1	1	-
Radcliffe, Mrs. S. J.	1	1	-
Rowland, John, J.P.	1	1	-
Schofield, Edwin, J.P.	2	2	-
Simister, A.	10	-	-
Smith, Josh., J.P.	1	1	-
Stott, Sidney	1	1	-
Swales, Geo., J.P.	1	1	-
Taylor, Isaac, J.P.	1	1	-
Taylor, Thos., J.P.	1	1	-
Taylor, Wm. (Shaw)	1	1	-
Whyte, A., J.P.	1	1	-
Whittaker, Robt., J.P.	1	1	-
Total	265	15	6

ORMSKIRK BRANCH.
(No Local Committee.)

President—
Rev. J. E. WOODROW,
Vicar of Ormskirk.

Treasurer—
LUKE BRIGHOUSE, Esq.

Hon. Secretary—
MICHAEL COOK, Esq.

Annual Subscriptions.

Berry, Peter, Esq.	10	-	-
Brighouse, Luke, Esq.	1	1	-
Brighouse, Mrs., The Cottage	10	-	-
Bromley, Jas. Esq., Latham	1	-	-
Casteja, The Hon. Count de	3	3	-
Garside, S. A. Esq.	10	-	-
Holcroft, Thos. Esq.	5	-	-
Lax, Miss	5	-	-
Morison, John, Esq.	10	6	-
Shaw, Mrs. J. H.	10	-	-
Wareing, Miss	1	-	-
Wignall, E. Esq.	1	1	-
Woodrow, Rev. J. E.	10	6	-
Total	£10	16	-

PRESTON BRANCH.

President—
His Worship THE MAYOR.

Local Committee—
SIDNEY A. HERMON, Esq.,
Chairman.
E. H. BOOTH, Esq.
W. B. ROPER, Esq.
Rev. G. STEELE.

Treasurer—
F. W. PONTING, Esq.

Hon. Secretary—
(No list for 1896.)

ROCHDALE BRANCH.
(No Local Committee.)

Honorary Secretary—
BENJAMIN HEAPE, Esq.

Annual Subscriptions.

	£.	s.	d.
Ashworth, Miles, Esq.	1	1	-
Ashworth, Miss	10	-	-
Ashworth, Wm. Esq.	10	-	-
Baron, Wm. Esq., J.P.	10	6	-
Best, W. H. Esq.	1	1	-
Booth, Geo. J. Esq., J.P.	1	1	-
Brierley, Abraham, Esq., J.P.	1	1	-
Brierley, James, Esq., J.P.	1	1	-
Bright, F. J. Esq.	1	1	-
Bright, J. A. Esq., J.P.	1	1	-
Calvert, J. M. Esq.	1	1	-
Chadwick, G. T. Esq.	1	1	-
Clegg, James W. Esq.	1	1	-
Clegg, John, Esq.	1	1	-
Crompton, Abel, Esq.	1	1	-
Crompton, John, Esq., J.P.	1	1	-
Crompton, Josh. Esq., J.P.	1	1	-
Crowther, A. H. Esq.	1	1	-
Crowther, F. G. Esq., J.P.	1	1	-
Davenport, J. M. Esq.	1	1	-
Dearden, J. G. Esq.	1	1	-
Dimmock, Mrs.	1	1	-
Duckworth, James, Esq., J.P.	1	1	-
Entwisle, J. B. N. Esq.	1	1	-
Haigh, J. W. Esq.	1	1	-
Hartley, J. R. Esq.	1	1	-
Heap, Arthur, Esq.	1	1	-
Heape, Benj. Esq., J.P.	1	1	-
Holden, James, Esq.	1	1	-
Hurst, Richard, Esq., J.P.	1	1	-
Hutchinson, Mrs.	1	1	-
Jackson, Geo. Esq.	1	1	-
Jones, Jas. E. Esq.	1	1	-
Kay, W. H. Esq.	1	1	-
Kemp, Mrs.	2	2	-
King, J. Russell, Esq.	1	1	-
King, Mrs.	10	6	-
King, W. H.	10	6	-
Lancashire, J. H. Esq., J.P.	1	1	-
Law, Messrs. A. & W.	2	2	-
Lee, John, Esq.	1	1	-
Lee, Thomas, Esq.	1	1	-
Littlewood, J. S. Esq., J.P.	1	1	-
Lord, James, Esq.	1	1	-
Lord, T. K. Esq.	1	1	-
Mellor, Zachary, Esq.	1	1	-
Milne, J. H. Esq.	1	1	-
Milne, Mrs. J.	1	1	-

	£.	s.	d.
Molesworth, A. Esq., J.P.	1	1	-
Moore, Miss	1	1	-
Ogden, William, Esq.	10	-	-
Openshaw, J. H. Esq.	1	1	-
Ormerod, W. E. Esq.	1	1	-
Petrie, George, Esq., J.P.	1	1	-
Petrie, Jno. E. Esq., J.P.	1	1	-
Petrie, Mrs. James	1	1	-
Petrie, W. S. Esq.	1	1	-
Pilling, Edwin, Esq.	1	1	-
Radcliffe, Arthur, Esq., J.P.	1	1	-
Radcliffe, Herb. Esq., J.P.	1	1	-
Radcliffe, J. Ashton, Esq.	1	1	-
Radcliffe, Walt. Esq.	1	1	-
Robinson, T. N. Esq.	1	1	-
Robinson, C. J. Esq.	1	1	-
Rochdale Equitable Pioneers Society	1	1	-
Royds, Capt. C. R. N. Beawicke	1	1	-
Schofield, J. H. Esq., J.P.	1	1	-
Scott, Walter, Esq.	1	1	-
Shaw, Messrs. Wm. & Sons	2	2	-
Slack, Robert, Esq.	1	1	-
Smithson, Thos. Esq., J.P.	1	1	-
Standring, John, Esq.	1	1	-
Stevens, Allan, Esq.	1	1	-
Tomlinson, Chas. Esq.	1	1	-
Tomlinson, John D. Esq.	1	1	-
Turner, John, Esq., J.P.	1	1	-
Turner, Robert, Esq.	2	2	-
Twycross, Mrs.	1	1	-
Watson, Mrs.	1	1	-
Whittaker, Chas. Esq., J.P.	1	1	-
Worth, J. T. Esq.	1	1	-
Wrigley, Fred. Esq., J.P.	1	1	-
Wrigley, O. O. Esq., J.P.	1	1	-
Wrigley, Miss	2	2	-
Total	£90	1	6

ST. ANNE'S-ON-THE-SEA BRANCH.

President—
Rev. W. G. TERRY, M.A.

Local Committee—
MR. CHARLES W. MACA RA,
J.P. Chairman,
MR. A. R. ROGERSON,
Vice-Chairman,
Rev. W. ELSTUB,
MR. T. HOLT,
MR. R. H. IRVING,
Major JONES,
MR. A. E. SMITH,
MR. S. R. STOTT,
MR. G. SWAINSON,
MR. J. WAINWRIGHT.

Donations.

Turner, Samuel, Esq.	1	1	-
Walker, Robert, Esq.	1	1	-
Pillar Box	2	7	8
Total Dons	4	9	8
Total Subs.	90	1	6
Total	£94	11	2

Hon. Treasurer—
Mr. H. PORRITT.

Hon. Secretary—
Mr. THOMAS BRADLEY.

Hon. Auditor—
Mr. RICHARD BOWMAN, C.A.

Ladies' Committee—
President—
Mrs. C. W. MACARA.

Committee—
Mrs. BOOTH,
Mrs. E. CATTERALL,
Miss COTTRILL,
Miss H. COLLRILL,
Mrs. ELSTUB,
Mrs. FERGUSON,
Miss HOLT,
Miss KINGSLEY,
Miss LAWRENCE,
Miss ORR,
Miss E. ORR.

Hon. Secretary—
Mrs. J. A. BROWN.

Annual Subscriptions.

	£.	s.	d.
Bannerman, Mr. J. A.	1	1	-
Banister, Mr.	10	6	-
Banister, Mr.	5	-	-
Barlow, Mr. J.	5	-	-
Bayley, Mrs.	5	-	-
Bentley, Mrs.	5	-	-
Boddington, Mr. R.	1	1	-
Booth, Dr.	5	-	-
Booth, Misses	10	-	-
Bowman, Mr. H.	10	6	-
Bradley, Mr. T.	5	-	-
Brown, Mr. J. A.	10	6	-
Brownwood, Mr. F.	5	-	-
Buckley, Mr. J.	1	1	-
Buckley, Miss	1	-	-
Catterall, Mr. E.	10	6	-
Catterall, Mr. F. W.	10	6	-
Cooper, Mr. E.	10	6	-
Cooper, Mr. J.	1	1	-
Cottrill, Mrs.	1	1	-
Deighton, Mrs.	5	-	-
Diggle, Mr. S.	1	-	-
Dunn, Mr. W. H.	1	1	-
Elliott, Dr.	5	-	-
Ellison, Rev. C. H.	5	-	-
Elstub, Rev. W.	10	6	-
Ferguson, Mr. H. S.	10	6	-
Gardiner, Miss	5	-	-
Garlick, Mrs.	5	-	-
Gillibrand, Mr. R. T.	1	1	-
Grime, Miss	5	-	-
Hacking, Mrs.	5	-	-
Hamer, Mr.	10	6	-
Hargreaves, Mr. R.	5	-	-
Harper, Mr.	5	-	-
Higson, Mrs.	5	-	-
Holloway, Mrs.	10	6	-
Hoare, Mr.	5	0	-
Holt, Mr. T.	5	-	-
Irving, Mr. R. H.	10	6	-
Jackson, Mr. G. B.	1	1	-
Jones, Captain T. A.	5	-	-
Jones, Mrs.	5	-	-
Lawrence, Mr. J.	1	1	-
Leach, Mr. D.	5	-	-
Lowe, Mr. G.	5	-	-
Macara, Mr. C. W.	2	2	-
Macbeth, Mr. N.	10	6	-
Manley, Mr.	10	-	-
Margerison, Mrs.	10	-	-
Mellor, Mrs.	5	-	-
Menzies, Mr.	10	6	-
Metcalfe, Mr. C.	1	1	-
Moscrop, Mr.	1	1	-
Moscrop, Miss	1	1	-
Newbigging, Mr. W.	1	-	-
Orr, Mr. J.	10	6	-
O'Connor, Dr.	5	-	-
Peel, Mr. R.	1	1	-
Peel, Mrs.	5	-	-
Raw, Miss	5	-	-

	£.	s.	d.
Rains, Mrs.	10	6	
Redfern, Mr.	10	6	
Redfern, Mr.	5		
Rhodes, Mr. G.	5		
Rogerson, Mr. A. R.	1	1	
Royle, Mr. J.	10	6	
Sharpe and Hall, Misses	10	6	
Shepherd, Mr. R.	10	6	
Sacre, Mrs.	1	1	
Sagar, Mr.	5		
Sargent, Mr. J.	10	6	
Staley, Dr.	5		
Swainson, Dr.	5		
Swainson, Mrs.	5		
Stott, Mrs.	1	1	
Surr and Shotten, Misses	5		
Taylor, Mr.	5		
Terry, Rev. W. G.	1	1	
Thompson, Mr. J.	10		
Tod, Mr. A.	1		
Todd, Mr.	5		
Varley, Rev. J. W.	5		
Wade, Mr. R. J.	10	6	
Wainwright, Mr. J.	10	6	
Whipp, Mr. E.	5		
White, Mr.	5		
Whitehead, Mrs.	5		
Wilson, Mr. E.	10	6	
Wood, Mrs.	10	6	
Williamson, Mr. R. W.	1	1	
Worthington, Mrs.	10	6	
Yorke, Mr. J.	10	6	
Sums under 5s.	10	12	10
Total	£61	5	4

Donations.

Hartley, Mrs., Brierfield	5		
Proceeds of Golf Concert	4	5	
	£9	5	

Golf Club Fund—

Half Lytham and St. Anne's Golf Club Fund	7	7	
---	---	---	--

Places of Worship—

Wesleyan Church	9	1	10
-----------------	---	---	----

Collecting Boxes—

Monument	13	11	5
Pier Entrance	1	3	5
Pier Jetty	1	2	4
Crossley Hall Congregation, per Crossley Bros.	2	5	8
	£18	2	10
Total Dons.	43	16	8
Total Subs.	61	5	4
	£105	2	

SOUTHPORT BRANCH.

President—
The Rt. Hon. The EARL OF LATHOM.

Local Committee—
R. NICHOLSON, Esq., J.P., Chairman.
G. AUSTREFIELD, Esq., J.P. Commander
BRAGO, R. N.E. B. CHEETHAM, Esq. T. O. CLINNING, Esq., J.P., C.C.
H. MATHWIN, Esq., J.P.

Sir G. A. PILKINGTON, J.P., C.A.
E. J. RIMMER, Esq., J.P.
CHAS. SCARISBRICK, Esq., J.P.
JOHN SMALLSHAW, Esq.
Rev. Canon THOMPSON, M.A.
Rev. T. SUTCLIFFE, M.A., J.P.

JOHN UNWIN, Esq., J.P., C.C.
Col. WELSBY, J.P.
JAMES WOOD, Esq., J.P., LL.D.
STANLEY WILSON, Esq.

Honorary Treasurer—
C. D. ANDERSON, Esq.

Honorary Secretaries—
WM. THOMAS, Esq., J.P.
W. H. SHAW, Esq.

Collector—
Mr. MARTIN.

Annual Subscribers.

	£.	s.	d.
Austrefield, G. Esq., J.P.	10	6	
Ashworth, Dr. Percy	5		
Barlow, Mr., Councilor	5		
Barnes, Miss	1	1	
Barrow, W. A. Esq.	1	1	
Blacklock, Mrs.	2	2	
Bland, W. E. Esq.	1	1	
Bocock, Mr., Councilor	10	6	
Boothroyd, A. E. Esq.	1		
Boothroyd, Wm. Esq.	10	6	
Boyd, Miss	5		
Bradbury, Mrs. (the late)	1	1	
Bragg, Commander, R.N.E.	1	1	
Brierley, J. Esq.	1		
Burdon, P. Esq.	1	1	
Cheetham, B. Esq.	1	1	
Clinning, T. O. Esq., J.P., C.C.	1	1	
Craven, S. B. Esq.	10	6	
Curzon, Hon. G. N., M.P.	1	1	
Davenhill, Mrs.	1	1	
Eastwood, Mr., Councilor	1	1	
Fennell, Mrs.	1	1	
Garton, Miss	1	1	
Geddes, Miss	1	1	
Geddes, Miss S.	1	1	
Glover, Isaac, Esq.	1	1	
Glover, Miss S.	1	1	
Glover, W. H. Esq.	10	6	
Gregory, Mrs. H. L.	1	1	
Halliday, Mrs.	1	1	
Haydock, Mrs.	2	2	
Heald, W. N. Esq., J.P.	2	2	
Heap, Ralph, Esq.	1	1	
Heaton, Charles, Esq., J.P.	1	1	
Hesketh, Mrs.	1	1	
Hulme, Wm. Esq., J.P.	2	2	
Jackson, Miss	1	1	
Johnson, J. H. Esq., J.P.	1	1	
Jones, Wm. Esq., J.P.	10	6	
Knowles, Mrs.	10	6	
Lancashire and Yorkshire Railway Co.	3	3	
Lathom, Earl of	5	5	
Leyland, Mrs. Naylor	1	1	
Macfie, Col., J.P.	1	1	
Mathwin, H. Esq., J.P.	1	1	
Mathwin, H. Esq., jun.	1	1	
Maxwell, J. M. Esq.	1	1	
McKerrow, J. Esq.	1	1	
Midwood, A. H. Esq.	1	1	
Monks, Thos. E. q.	1	1	
Nicholson, R. Esq., J.P.	1	1	

Openshaw, Fred, Esq., J.P.

Openshaw, O. O. Esq.

Perring, R. B. Esq.

Pilkington, Sir G.A., J.P., C.A.

Rimmer, E. J. Esq., J.P.

Ryley, Mrs.

Scarisbrick, Chas. Esq., J.P.

Scarisbrick, Wm. Esq., J.P.

Shaw, W. H. Esq.

Smith, Miss

Skelton, Miss

Stead, J. F. Esq., J.P.

Stewart, W. J. Esq., J.P.

Stopford, Mrs.

Sutcliffe, Rev. T., M.A., J.P.

Thomas, Wm. Esq., J.P.

Thompson, Rev. Canon, M.A.

Todd, James, Esq.

Unwin, John, Esq., J.P., C.C.

Weaver, James, Esq., M.D.

Welsby, Colonel, J.P.

West, Misses

Wood, James, Esq., J.P., LL.D.

Wood, Misses

Wilson, Stanley, Esq.

Sums under 5s.

Total £81 18

Donations.

Crook, J. Esq.	10		
Other amounts	4	6	
Contribution Boxes	19	16	3
Total Dons.	20	10	9
Total Subs.	81	18	
	£102	8	9

Leicestershire.

LEICESTER BRANCH.

President—
SIR ISRAEL HART.

Vice-Presidents—
W. H. WALKER, Esq.
E. CLEPHAN, Esq.
J. H. COOPER, Esq.
H. SIMPSON GEE, Esq.

Local Committee—
THE MAYOR, J. H. MARSHALL, Esq., J.P.
Mr. Alderman UNDERWOOD.
SIR THOS. WRIGHT.
Mr. Alderman E. WOOD.
Mr. Alderman BARFOOT.
Mr. Councillor S. FAIRE.
Mr. Councillor POCHIN.
Mr. Councillor VORLEY.
Col. S. DAVIS.
Mr. W. H. BATES.
Mr. Councillor GEO. BANTON.
Mr. J. H. BUCKLEY.
Mr. ALFRED COLSON.
Mr. J. BANCROFT ELLIS.

Mr. R. H. ELLIS.
Mr. E. F. COOPER.
Mr. A. H. BURGESS.
Mr. J. C. CLARKE.
Mr. F. HEWITT.
Mr. F. HEWITT, Jun.
Mr. S. ODAMES.
Mr. C. A. SPENCER.
Mr. W. STANTON.
Mr. B. C. WATES.
Mr. J. A. HOPPS.
Mr. J. PARSONS.
Mr. C. T. GREEN.
Mr. W. RAVEN.
Mr. JOS. GODDARD.
Mr. Superintendent ELY.
Mr. MORRIS.
Mr. KENNY.

Treasurer—
E. CLEPHAN, Esq.

Honorary Secretaries—
Mr. WILLIAM GREEN.
Mr. ALBERT G. FAIRE.

Annual Subscribers.

	£.	s.	d.
Adkinson, Mr. R. L.	5		
Atkins, Mr. A. F.	5		
Bates, Mr. W. H.	1	1	
Bellairs, Colonel	5		
Bonner, Mr. F.	1	1	
Bowmar, Mrs.	10	6	
Bowmar, Mr. Walter	1	1	
Bowmar, Miss	10	6	
Burgess, Mr. Josh.	1	1	
Burton, Mr. J.	10	6	
Chamberlain, Mr. T.	5		
Charlesworth, Mr. T. G.	5		
Clephan, Mr. E.	1	1	
Collis, Mrs., Birmingham	1	1	
Colson, A.	5		
Cook, Mrs. John M., London	1	1	
Cooper, Mr. J. H.	1	1	
Ellis, Mrs. G. H.	1	1	
Everard, Mr. J. B.	1	1	
Everard, Mr. T. W.	5		
Franklin, Dr.	5		
Gillson, Mr. H. T.	1	1	
Gimson and Co., Messrs.	1	1	
Goddard, Mr. J. W.	5		
Goddard, Mr. Josh.	10	6	
Hardington & Elliott, Messrs.	5		
Harrison and Sons, Messrs. T.	5		
Hearth, Mr. J.	5		
Hewitt, Mr. F.	10	6	
Hewitt, Mr. F. Jun.	5		
Interest on borough loan	3	8	6
Johnson, Mr. J.	10	6	
Johnson, Mr. T. F.	1	1	
Jones, Messrs. T. & J.	10	6	
Kempson, Mrs. W.	1	1	
Lakin, Dr. Chas.	5		
Lead, Mr. W. H.	5		
Leicester Butchers' Association, The.	1	1	
Livens, Mrs. F.	10	6	
Marriott, Dr.	1	1	
McAlpin, Miss J. W.	5		
Morley and Sons, Messrs. R.	10	6	
Paget, Mr. Alfred	1	1	
Paget, Miss L.	10		
Pickard, Messrs. J. E. & Sons	10	6	
Raven, Mr. W.	5		
Rollston, Mr. J. F. L.	10	6	
Sarson, Messrs. J. and Sons	5		
Sewell, Mrs.	10	6	
Sidley, Mrs. C. M.	1	1	
Spencer, Mr. C. A.	1	1	
Stanyon, Mr. W.	1	1	
Stretton and Sons, Messrs.	10	6	

ANNUAL SUBSCRIPTIONS AND DONATIONS TO BRANCHES.

	£.	s.	d.
Thomson, Mr.	10	6	
Turner, Mr. Luke (the late)	1	1	
Walker, R. & Sons.	10	6	
Walker, Mr. W. H. 1	1		
Wand, Mr. Stephen.	5		
Wates, Mr. B. C.	10	6	
Webster, Messrs. T. & Co.	5		
Went, Rev. J.	5		
West, Mr. A. J.	5		
Wilson, Mr. Geo.	10	6	
Sums under 5s.	10		
Total	£41	19	

Donations.

Pillar Boxes.	1	9	7
Collected by— Halfpenny, Mr. W. G.	1	4	
Total Dons.	2	13	7
Total Subs.	£41	19	
£44	12	7	

Lincolnshire.

LINCOLNSHIRE SHIPWRECK ASSOCIATION BRANCH.

Central Committee—
Rear-Admiral BUCKLE.
W. D. GAINSFORD, Esq.
T. C. GARFIT, Esq.
REV. A. GEDGE.
C. GRANTHAM, Esq.
B. R. LANGTON, Esq.
J. S. LISTER, Esq.
C. MASSINGBERD-MUNDY,
Esq.
COL. PRESTON.
W. H. SMYTH, Esq.
REV. J. S. WARREN.
The Commander H.M.
Coastguard.

Treasurer—
WILLIAM GARFIT, Esq.
Joint Honorary Secretaries—
REV. R. W. CRACROFT and
REV. E. RAWNSLEY.

Annual Subscriptions.

	£.	s.	d.
Allenby, Miss.	1		
Ancaster, Rt. Hon. Earl of.	5		
Artindale, Mr.	5		
Aubertin, E. Esq.	1		
Bethlem Hospital, Governors of.	5	5	
Booth, F. H. Esq.	1	1	
Borradaile, Rev. F.	1	1	
Boucherett, Miss.	1	1	
Bradley, Mrs.	1		
Brownlow, Earl.	20		
Buckle, Rear-Ad- miral.	1	1	
Chaplin, H., Rt. Hon. M. P.	2	2	
Cheales, Rev. H. J.	10	6	
Clayton, W. L. Esq.	1	1	
Cockburn, N. C. Esq.	2	2	
Cracroft, E. W. Esq.	1	1	

	£.	s.	d.
Cracroft, Rev. R. W. 1	1		
Crowder, F. Esq.	2	2	
Davy, J. W. Esq.	10	6	
Dixon, Miss.	1	1	
Erle - Erle - Drax, Mrs.	2		
Eva, Mr. Jas.	5		
Gainsford, W.D. Esq.	1	1	
Garfit, Wm. Esq.	2	2	
Garfit, T. C. Esq.	1	1	
Gedge, Rev. A.	1	1	
Harrison, R. Esq.	10		
Henage, the Right Hon. Lord.	1	1	
Higgins, J. Esq.	10	6	
Hollway, H. Esq.	1	1	
Hopkinson, Rev. W. 1	1		
Hornsby, W. Esq.	1		
Ingilby, Sir H. D. Bart.	2	2	
Ladd, Rev. J. S.	5		
Langton, Bennet, Esq.	2	2	
Lincoln, Bishop of.	2	2	
Lincoln, Dean of.	1	1	
Lister, J. S. Esq.	1	1	
Mackinder, H. Esq.	5		
Massingberd, Rev. W. 1	1		
Massingberd-Mundy, C. F. Esq.	1		
Ogilvy, Mrs. R. Hamilton.	1		
Oxenbridge, Viscount Pocklington-Coltman, Mrs.	1	1	
Preston, Colonel.	10	6	
Pretyman, E. G. Esq.	2	2	
Pretyman, Rev. Canon 1	1		
Rawnsley, E. P. Esq.	1	1	
Rawnsley, Rev. Edw. 1	1		
Reynardson, C. B. Esq. 1	1		
Rice, B. F. Esq.	10		
Robinson, J. N. Esq.	10		
Rogers, H. Esq.	1	1	
Ruston, Joseph, Esq.	2	2	
Sale, Rev. T. W.	1	1	
Scraton, Rev. G.	1	1	
Shuttleworth, A. Esq.	2	2	
Sibthorp, C. C. Esq.	3		
Sibthorp, M. W. Esq.	1	1	
Sibthorp, Miss Waldo 2	2		
Sibthorp, Mrs. Waldo 1	1		
Simons, Mr. B.	10		
Smith, Ellison & Co. 2	2		
Smyth, W. H. Esq.	1	1	
Stanhope, J. B. Esq.	2	2	
Stanhope, The Hon. Mrs. E.	3		
Staniland, M. Esq.	1	1	
Swan, J. Esq.	10	6	
Swan, R. Esq.	10	6	
Swan, Rev. C. T.	1	1	
Tennant, Mrs.	1		
Thimbleby, T. W. Esq. 1	1		
Turcor, E. Esq.	1	1	
Ward, Rev. G.	10	6	
Warren, Rev. J. S.	1	1	
White, F. T. Esq.	1		
Williamson, Mr. Jas 5	5		
Willoughby, Ld. M. P. 2	2		
Wilson, Mr. J.	5		
Wingate, Miss.	5		
Yarborough, the Right Hon. the Earl of.	2	2	
Yorke-Dallas, T. Esq. 1	1		
Sums under 5s.	2	6	
£121	17		

Local Committee—
Mr. G. WATTS.
Mr. W. DONSON.
Mr. R. HOULDEN.
Messrs. H. & T. WILSON.
Hon. Secretary—
Mr. G. HOULDEN.

Annual Subscriptions.

Hill, Rev. T.	7	6
Houlden, Mr. G.	10	
Houlden, Mr. R.	5	
Longley, Rev. T.	5	
Lougheed, Dr.	5	
Simpson, Mr. H. D.	5	
Sums under 5s.	7	6
£2	5	

MABLETHORPE BRANCH.
Local Committee—
Mr. WOOD.
Mr. STRAWSON.
Mr. DAUBNEY.
Mr. MALKINSON.
Hon. Secretary—
Dr. IREDALE.

Annual Subscriptions.

Allott, Rev. R.	1	1
Bell, Mr. J.	10	
Gray, H. H.	10	
Grimstone, Lady.	1	
Iredale, Dr.	5	
Michaelson, Rev. E., per.	14	
Sums under 5s.	10	
£4	10	

Local Committee—
Mr. WOOD.
Mr. STRAWSON.
Mr. DAUBNEY.
Mr. MALKINSON.
Hon. Secretary—
Dr. IREDALE.

Annual Subscriptions.

Chapel Branch.	2	4	3
Contribution Boxes.	7	4	3
Interest on Mr. Hud- son's Legacy.	6	8	
Interest on N. E. Railway Debent- ures.	43	10	
Skegness Branch.	2	1	4
Wells, Miss, the late, Trustees of.	17	4	11
Total	£212	11	9

NORTH SOMERCOOTES BRANCH
Local Committee—
Mr. G. WATTS.
Mr. W. DONSON.
Mr. R. HOULDEN.
Messrs. H. & T. WILSON.
Hon. Secretary—
Mr. G. HOULDEN.

Local Committee—
Mr. WOOD.
Mr. STRAWSON.
Mr. DAUBNEY.
Mr. MALKINSON.
Hon. Secretary—
Dr. IREDALE.

Annual Subscriptions.

Allott, Rev. R.	1	1
Bell, Mr. J.	10	
Gray, H. H.	10	
Grimstone, Lady.	1	
Iredale, Dr.	5	
Michaelson, Rev. E., per.	14	
Sums under 5s.	10	
£4	10	

Local Committee—
Mr. WOOD.
Mr. STRAWSON.
Mr. DAUBNEY.
Mr. MALKINSON.
Hon. Secretary—
Dr. IREDALE.

Annual Subscriptions.

Chapel Branch.	2	4	3
Contribution Boxes.	7	4	3
Interest on Mr. Hud- son's Legacy.	6	8	
Interest on N. E. Railway Debent- ures.	43	10	
Skegness Branch.	2	1	4
Wells, Miss, the late, Trustees of.	17	4	11
Total	£212	11	9

BOSTON BRANCH.
(No Local Committee.)
Collector—
Mr. J. G. KILLINGWORTH.

Local Committee—
Mr. WOOD.
Mr. STRAWSON.
Mr. DAUBNEY.
Mr. MALKINSON.
Hon. Secretary—
Dr. IREDALE.

Annual Subscriptions.

Chapel Branch.	2	4	3
Contribution Boxes.	7	4	3
Interest on Mr. Hud- son's Legacy.	6	8	
Interest on N. E. Railway Debent- ures.	43	10	
Skegness Branch.	2	1	4
Wells, Miss, the late, Trustees of.	17	4	11
Total	£212	11	9

Local Committee—
Mr. WOOD.
Mr. STRAWSON.
Mr. DAUBNEY.
Mr. MALKINSON.
Hon. Secretary—
Dr. IREDALE.

Annual Subscriptions.

Chapel Branch.	2	4	3
Contribution Boxes.	7	4	3
Interest on Mr. Hud- son's Legacy.	6	8	
Interest on N. E. Railway Debent- ures.	43	10	
Skegness Branch.	2	1	4
Wells, Miss, the late, Trustees of.	17	4	11
Total	£212	11	9

Local Committee—
Mr. WOOD.
Mr. STRAWSON.
Mr. DAUBNEY.
Mr. MALKINSON.
Hon. Secretary—
Dr. IREDALE.

Local Committee—
Mr. WOOD.
Mr. STRAWSON.
Mr. DAUBNEY.
Mr. MALKINSON.
Hon. Secretary—
Dr. IREDALE.

Annual Subscriptions.

Chapel Branch.	2	4	3
Contribution Boxes.	7	4	3
Interest on Mr. Hud- son's Legacy.	6	8	
Interest on N. E. Railway Debent- ures.	43	10	
Skegness Branch.	2	1	4
Wells, Miss, the late, Trustees of.	17	4	11
Total	£212	11	9

Local Committee—
Mr. WOOD.
Mr. STRAWSON.
Mr. DAUBNEY.
Mr. MALKINSON.
Hon. Secretary—
Dr. IREDALE.

Annual Subscriptions.

Chapel Branch.	2	4	3
Contribution Boxes.	7	4	3
Interest on Mr. Hud- son's Legacy.	6	8	
Interest on N. E. Railway Debent- ures.	43	10	
Skegness Branch.	2	1	4
Wells, Miss, the late, Trustees of.	17	4	11
Total	£212	11	9

Local Committee—
Mr. WOOD.
Mr. STRAWSON.
Mr. DAUBNEY.
Mr. MALKINSON.
Hon. Secretary—
Dr. IREDALE.

£. s. d.	
Guy & Smith, Messrs.	5 -
Haagensen, H. Esq. 1 -	1 -
Haddlesley, Mr.	10 6
Hagerup, Doughty & Co., Messrs.	1 1 -
Hamilton, Mr. H. A. P.	10 6
Henage, E. Esq.	1 1 -
Hewitt, Bros., Ltd., Messrs.	1 1 -
Hewson & Co., Limited, Messrs.	10 6
Hill, Mr. W.	1 1 -
Hird, Mr. H.	5 -
Howell, Capt.	10 6
International Steam Trawling Co., The	1 1 -
Jeffs, Mr. C., jun. . .	5 -
Jowers, Capt.	5 -
Lord, Mr. F.	5 -
Luxmore, C. N.	1 1 -
Mackintosh, David. .	5 -
Mackintosh, Donald. .	5 -
Mackrill & Son, Messrs.	6 -
Manchester, Sheffield, and Lincolnshire Railway Company	10 10 -
Marshall and Son, Messrs.	1 -
Meadows, J. Esq.	1 1 -
Miller, Capt. C. A. . .	5 -
Nainby, W.	2 -
Nainby, C. Esq.	1 1 -
Northwold Fishing Co., The.	1 1 -
Oates, T. & S., Messrs. 1 -	1 1 -
Ocean Steam Fishing Co., Ltd.	1 1 -
Olsen, Mr. O. T.	5 6
Palmer & Son, Messrs	10 -
Pioneer Steam Fishing Co., Ltd.	1 1 -
Reed, Mr. A. J.	10 6
Riggall & Son, Messrs.	5 -
Robinson, J. Esq.	10 6
Rose, Downs and Thompson, Messrs. 1 -	1 1 -
Seddon & Shepherd . .	10 6
Smith Bros., Messrs. 1 -	1 1 -
Smith & Son, Messrs. G.	5 -
Soames, Messrs.	1 1 -
Stephenson & Mountain	1 1 -
Sutcliffe, J.	1 1 -
Swaby, Mr. T. W.	5 -
Williams, Mr. T. M. .	10 6
Wintingham & Son 1 -	1 1 -
Wood, Mr.	5 -
Wood, Mr. F.	1 1 -
Worms, Josse & Co., Messrs.	1 1 -
Yarboro', The Earl of	2 2 -
Young, Rev. J. P.	5 -
Sums under 5s.	2 - 6
Total	£75 9 -

Total £75 9 -

Donations.

Dixon, Mrs. Jamieson.	10 6
Hansen, Mr. D. C. . .	10 6
Lord, Mr. F.	5 -
Pickerden & Son, Messrs.	5 -
Sums under 5s.	2 6
Contribution Boxes—	
Kapper, Miss, Antwerp.	16 -
James, Mr., Antwerp.	9 3
Reynolds, Mr.	16 -
S.S. Ashton.	1 15 6
„ Chester.	1 10 6
„ Huddersfield. . .	14 -
„ Leicester.	10 -
„ Lincoln.	11 6

£. s. d.	
S.S. Lutterworth . .	2 1 4
„ Northenden . . .	15 -
„ Nottingham. . .	13 6
„ Oldham.	1 4 6
„ Retford.	7 -
„ Sheffield.	1 18 -
„ Staveley.	1 1 6
„ Warrington. . .	1 4 6
Sums under 5s.	12 6
Total Dons	18 14 1
Total Subs.	75 9 -
£94 3 1	

Merionethshire.

ABERDOVEY BRANCH.

Local Committee—
Dr. F. H. V. GROSHOLZ,
Chairman.
Rev. JOHN ROWLANDS, Vicar
Vice-Chairman.
MARMADUKE LEWIS LEWIS,
Esq., J.P.

Honorary Secretary—
Capt. ENOCH LEWIS.

Annual Subscriptions.

£. s. d.	
Brampton, Fred. Esq. 1 -	1 -
Grosholz, Dr.	10 -
Howell, Joseph M. Esq.	10 -
Howell, Mrs.	5 -
Kershaw, Dr. W. E. Es., Treas.	10 6
Lewis, Enoch.	10 6
Lewis, Marmaduke Lewis, Esq., J.P. . .	10 -
Rowlands, Rev. John .	10 6
Wright, S. Barlow, Esq., Pontidol. . .	10 -
Wynne, W. R. M. Esq., Lord Lieutenant of Merioneth.	1 1 -
Sums under 5s.	17 6
Total Subs.	£6 16 -
Donations.	
Various Donations. .	4 17 6
Total,	£11 13 6

BARMOUTH BRANCH.

Local Committee—
Major BEST, Chairman.
E. BUCKLEY, Esq., Vice-Chairman.
JOHN EVANS, Esq.
Rev. E. HUGHES, B.A.
Capt. WM. JONES.
W. H. GATTY JONES, Esq., J.P.
R. JONES, Esq.
Alderman LEWIS, J.P.
Dr. LISTER.
Dr. LLOYD, J.P.
W. J. MORRIS, Esq., J.P.
R. PRYSE OWEN, Esq., J.P.
E. OTTO PARTBRIDGE, Esq.
Capt. EVAN RICHARDS.
R. S. WAYNE, Esq.
ELLIS WILKIN, Esq.
Dr. CHARLES WILLIAMS, J.P.
Honorary Secretary—
Mr. JOHN LLOYD.

Annual Subscriptions.

£. s. d.	
Allsop, B. J. Esq.	1 1 -
Best, Major.	1 1 -
Dorsett, J. A., Esq. .	1 1 -
Griffith, Miss, "Arianfryn" . . .	10 -
Morris, W. J. Esq. J.P.	5 -
Perrins, C. W. D. Esq.	2 2 -
Perrins, Mrs. F. S. . .	1 1 -
Talbot, Mrs.	2 2 -
Trustees of Bathmouth Harbour. .	3 3 -
Total	£12 6 -

Donations.

Massey, Mr., of Liverpool, proceeds of Fireworks display	14 5
Pillar Box. s.	8 15 8
Total Dons.	9 10 1
Total Subs.	12 6 -
£21 16 1	

Middlesex.

BARNET, ENFIELD, SOUTHGATE, FRIERN BARNET AND NEW SOUTHGATE BRANCH.

President—
The Right Hon. THE EARL OF STRAFFORD.

Ladies' Committee—
Mrs. JOHN A. EVASON.
Miss WOOD.

Honorary Treasurer and Secretary—
JOHN A. EVASON.
(No List for 1896.)

Annual Subscriptions.

£. s. d.	
Lord Tredegar.	5 -
Bailey, C. H.	10 6
Blaenavon Co., Ltd. .	10 6
Budd & Co.	5 -
Burton & Sons.	1 1 -
Cartwright, T. G.	10 6
Comerford, Jas.	5 -
Cory, J., Sons & Co. .	5 -
Cox, E.	5 -
Cox, T.	10 6
Davies, I.	5 -
Davies, J.	5 -
Davies, J.	5 -
Ebsworth, C.	5 -
Ebbw Vale Steel, Iron & Coal Co. (1895 & 1896)	6 6 -
Evans, W. J.	10 6
Filleul & Co., A. P. .	5 -
Fisher, W. H.	5 -
Fry, Henry J.	5 -
Gilmore, J.	5 -
Gilmore, Isaac.	5 -
Goldsworthy, H. T. .	5 -
Gould, J. G.	5 -
Griffiths, M. H.	10 6
Isca Foundry Co.	10 6
Jones, Rees.	10 6
Jones, T. G.	5 -
Lewis, S. J.	5 -
Lloyd, W. J.	1 1 -
Lynne, H. S.	10 6
McAtee, J.	5 -
Mordey, Carney & Co. 1 -	1 -
Newport (Alexandria) Dock Co. Ltd.	1 1 -
Mitchell, F. J. (1895 & 1896)	4 4 -
Orders & Handford . .	10 6
Partridge, Jones & Co. 1 -	1 -
Pearce, W. J.	5 -
Phillips, F.	10 6
Phillips, J.	10 6
Pyman Watson & Co. .	10 6
Ray, W., senior.	5 -
Small, E.	5 -
Small, S. J.	10 6
Summers, E. J.	10 6
Thompson, J.	10 6
Thompson, W.	10 6
Tredegar Iron and Coal Company. . .	1 1 -
Watts, Wm.	5 -
Weeks, T. S.	5 -
Sums under 5s.	5 -
Total	£36 14 6

Donations.

Collecting Boxes—	
Elliot Home.	1 8 8
Serjeant & Son.	1 2 1
Webb, E.	10 6
Sums under 5s.	4 1

Total Dons 3 5 4
Total Subs. 36 14 6

Monmouthshire.

NEWPORT BRANCH.

President—
The Right Hon. LORD TREDEGAR.

Local Committee—
HENRY BURTON,
THOMAS JONES,
W. J. LLOYD,
W. S. SMYTH,
J. THOMPSON.

Treasurer—
HORACE S. LYNE, Esq.

Hon. Secretary—
A. J. PHILLIPS, Esq.

Norfolk.

NORFOLK BRANCH.

(No Local Committee.)

Honorary Secretary—
F. O. TAYLOR, Esq., Norwich

Annual Subscriptions.

	£.	s.	d.
Amherst of Hackney, The Rt. Hon. Lord (1895).....	3	3	—
Ditto (1895).....	3	3	—
Bagshaw, H. G. Esq. 1 1	1	1	—
Barclay, J. G. Esq. 2 2	2	2	—
Bensly, W. T. Esq., L.L.D.	1	1	—
Birkbeck, Wm. Esq. 5 5	5	5	—
Blake, Henry Esq. 1 1	1	1	—
Boulderson, Mrs.	1	1	—
Buxton, Geoffrey F. Esq.	5	—	—
Buxton, S. G. Esq.	2	2	—
Cator, Albemarle, Esq.	10	—	—
Cooper, G. H. Esq.	10	6	—
Cozens-Hardy, H. H. Esq., Q.C., M.P.	2	2	—
Cubitt, Major F. A. 1 1	1	1	—
Dowson, E. T. Esq. 1 1	1	1	—
Fletcher, B. E. Esq. 1 1	1	1	—
Fountaine, Mrs.	2	2	—
Gillett, Thos. Esq.	2	2	—
Hamond, R. H. Esq. 3 1	3	1	—
Harmer, F. W. Esq. 1 1	1	1	—
Heavyside, Rev. Canon Hinde, Francis, Esq.	10	6	—
Howlett, Miss.	1	—	—
Irby, Mrs. Isabella H. 2 2	2	2	—
Jex-Blake, Mrs. Frances.	1	1	—
Ladell, R. F. Esq.	10	6	—
May, Geo. Esq.	1	1	—
Millard, Mrs.	1	1	—
Mills, J. Arthur, Esq. 1 1	1	1	—
Nevill, Rev. Canon 1 1	1	1	—
Norwich, Very Rev. the Dean of.	1	1	—
Raikes, Mrs.	1	—	—
Ray, Rev. H.	1	1	—
Ripley, Rev. Canon 2 2	2	2	—
Steward, Pattenon & Co. Ltd.	1	1	—
Taylor, F. O. Esq. Hon. Secretary.	1	1	—
Wild, Edward, Esq. 1 1	1	1	—
Wodehouse, Mrs. C. 2 2	2	2	—
Total	£60	3	6

BLAKENEY BRANCH

Local Committee—
GEORGE HUDSON, Esq.
C. J. TEMPLE LYNES, Esq.
M. F. PAGE, Esq.

Treasurer and Honorary Secretary—
Rev. R. H. TILLARD, M.A.

Annual Subscriptions.

	£.	s.	d.
Amherst of Hackney, The Rt. Hon. Lord	1	1	—
Boulnois, E. Esq.	5	—	—
M.P.	5	—	—
Brumell, Rev. E.	10	6	—
Burroughs, T.H. Esq.	5	—	—
Cooke, Mr. Robins. 1 1	1	1	—

	£.	s.	d.
Hardy, C. W. H. Cozens, Esq.	1	1	—
Hudson, George, Esq. 1 1	1	1	—
Jodrell, Sir A., Bart. 1 1	1	1	—
Page, M. F. Esq.	1	1	—
Pearson, J. Esq.	10	—	—
Temple Lynes, C. J. Esq.	10	—	—
Tillard, Rev. R. H.	1	1	—
Total	£9	6	6

BRANCASTER BRANCH.

Local Committee—

SIMMS REEVE, Esq., Chairman.
Mr. S. G. ARCHBOULD.
Rev. H. E. BULWER.
Mr. H. MUSSETT.
Mr. F. PALMER.
Mr. C. V. YOUNG.
Honorary Secretary—
Rev. E. K. KERSLAKE, B.A.

Annual Subscriptions.

	£.	s.	d.
Ames-Lyde, Mrs.	10	—	—
Archbould, Mr. S. G.	10	6	—
Bircham, Mrs.	5	—	—
Blomefield, Rev. E.	5	—	—
Bulwer, Rev. H. E.	10	—	—
Bygott, Mr. R.	5	—	—
Cook, Mr. Henry	10	—	—
D'Angibau, Rev. G.	5	—	—
Everitt, Mr. Thomas	5	—	—
Francis, Mr. J. P.	10	6	—
Green, Mr. John	10	6	—
Hare, The Rev. Canon.	10	6	—
Hollway — Caithrop H. C. Esq.	1	1	—
Hosie, Miss.	1	1	—
Ingleby, H. Esq.	1	1	—
Kerslake, Rev. E. K. 1 1	1	1	—
Knight, Rev. J. L.	10	—	—
Lamb, Rev. J.	5	—	—
Leslie, W. H. Esq. 1 1	1	1	—
Lord Bishop of Thetford, The.	10	—	—
Mack, Mr. Thos. T.	10	—	—
Mann, T. Esq.	10	—	—
Mussett, Mr. Hy.	5	—	—
Overman, Mr. R.	5	—	—
Oxley, Mrs.	10	—	—
Palmer, Mr. F.	10	—	—
Palmer, Mr. L.	10	6	—
Porritt, Mr. Wm. L. 1 1	1	1	—
Reeve, Simms, Esq. 2 2	2	2	—
Ringer, Mr. T. W.	10	—	—
Savory, Mr. A. E.	5	—	—
Savory, Mr. John. 1 1	1	1	—
Sherringham, Mr. H. V.	10	—	—
Seymour, C. Esq.	10	—	—
Seymour, Mrs.	1	1	—
Sharman, Mr. W.	5	—	—
Toynbee, P. Esq.	1	1	—
West Norfolk Golf Club.	1	1	—
Young, Mr. C. V.	1	1	—
Sums under 5s.	15	6	—
Total Subs.	£25	11	—

Donations.

Contribution Boxes.	16	7	—
Total	£23	7	7

CROMER BRANCH.

Local Committee—
Right Hon. LORD SUFFIELD, Chairman.
Mr. McARTHUR, Chief Officer of Coast-guard.
R. W. BARCLAY, Esq.
Mr. J. S. CURTIS.
Sir T. FOWELL BUXTON, Bart.
JOHN HENRY GURNEY, Esq., Jun.
SAMUEL HOARE, Esq., M.P.
HENRY MCCLURE, Esq.
Mr. B. RUST.
Mr. G. W. RUST.

Honorary Secretary—
W. G. SANDFORD, Esq.

Annual Subscriptions.

	£.	s.	d.
Suffield, the Rt. Hon. Lord	2	2	—
Amherst of Hackney, The Rt. Hon. Lord	1	1	—
Barclay, R. W. Esq. 1 1	1	1	—
Buxton, Sir T. F. Bt. 2 2	2	2	—
Buxton, T. F. Esq. 2 2	2	2	—
Buxton, The Dowager Lady.	2	2	—
Gurney, John Henry, Esq., Jun.	1	1	—
Hoare, Richard, Esq. 2 2	2	2	—
Hoare, Samuel, Esq., M.P.	2	2	—
McClure, Henry, Esq.	1	1	—
Rust, B.	5	—	—
Sandford, W. G. Esq. 10 10	10	10	—
Total Subs.	17	11	—

Donations.

Contribution Boxes:— Esplanade and Life-boat House 4 16 10	4	16	10
Total	£22	7	10

HASBOROUGH BRANCH.

Local Committee—
A. G. GIBBS, Esq., Chairman
MR. GEORGE BOND.
MR. D. F. DUCKER.
MR. GEORGE GIBBS.
Rev. R. A. HITCHCOCK.
MR. JOHN MILLAR.
MR. SOLOMON, Coastguard.

Honorary Secretary—
Rev. G. SPACKMAN, B.A.

Annual Subscriptions.

	£.	s.	d.
Amherst of Hackney, The Rt. Hon. Lord	1	1	—
Birkbeck, Sir Edward, Bart.	1	—	—
Bond, Mr. & Mrs.	5	—	—
Daniels, Mr. T. A.	5	—	—
Durrant, Miss.	2	2	—
Forster, Wm. Esq.	1	—	—
Gibbs, A. G. Esq.	5	—	—
Gwyn, Rev. P. P.	10	—	—
Hitchcock, Rev. R. A. 1 1	1	1	—
Hudson, Robert A. Esq.	5	—	—
Ives, George, Esq.	1	—	—
Keith, F. T. Esq.	5	—	—
Kimberley, Earl of. 2 2	2	2	—
Morgans & Co., Messrs. 1 1	1	1	—
Penson, R. Esq.	1	1	—
Routh, Amand, Esq.	10	—	—

	£.	s.	d.
Rudd, Ash, Esq. J. P.	10	—	—
Shepherd, Mrs.	1	—	—
Slater, Lt.-Col. Barry.	10	—	—
Spackman, Rev. G. 1 1	1	1	—
White, Rev. J. & Mrs. Neville.	7	6	—
Wilkinson, John, Esq.	1	1	—
Sums under 5s.	2	6	—
Total	£18	—	—

Donations.

Phillips, E. J. Esq.	5	—	—
Contribution Boxes— Ash Rudd, Esq., J.P.	1	5	6
Cubitt, Mrs. Hill House Hotel.	7	9	—
Gwyn, Mrs.	13	2	—
Slater, Master Geoffrey.	1	—	—
Sums under 5s.	7	10	—
Total Dona.	3	19	3
Total Subs.	18	—	—
Total	£21	19	3

HUNSTANTON BRANCH.

President—
H. LE STRANGE, Esq.

Local Committee.

MR. R. BAGGE.
Rev. H. D. BARRETT.
MR. W. DODMAN.
MR. J. W. HUNN.
MR. E. KITTON.
Rev. C. M. MOORE.
MR. J. C. MORGAN-BROWN.
Lieutenant OLIVER, Inspector Coastguard.
MR. W. H. REECE.
Rev. PERCY C. STANLEY.
MR. F. W. ROBINSON.
MR. B. G. SUMPTER.
Rev. H. WALKER.
DR. WHITTY.

Honorary Secretary—
Rev. H. D. BARRETT.

Annual Subscriptions.

Ainslie, Miss.	10	—	—
Ames-Lyde, Mrs.	1	1	—
Amherst of Hackney, The Rt. Hon. Lord	1	1	—
Bagge, Mr. R.	10	—	—
Bagge, Miss M.	10	—	—
Bagge, Miss L.	10	—	—
Barrett, Rev. H. D.	10	—	—
Beckett, Rev. W. T. 1 1	1	1	—
Beckett, Miss.	5	—	—
Bellamy, Rev. Dr.	1	1	—
Blyth, Robt., Esq.	10	—	—
Burgis, Mr. R.	5	—	—
Cresswell, C. A. Esq. 1 1	1	1	—
Curry, Percival, Esq. 1 1	1	1	—
Davy, the Misses.	10	6	—
Dodman, Mr. W.	1	1	—
English Brothers.	1	—	—
Eyre & Co. Messrs.	1	1	—
Fraser — Campbell, Mrs.	5	—	—
Gates, Mrs.	1	1	—
Gilliatt, Howard, Esq.	1	1	—
Green, Lady.	5	—	—
Gurney & Co. Messrs. 2 2	2	2	—
Heading, Mr. G.	10	—	—
Howard, Miss.	10	6	—
Hunn, Mr. J. W.	1	1	—
Hunt, W. F. Esq.	1	—	—

	£.	s.	d.
Ibberson, Mr. Chas.	10	6	
Lambert, Mr. Jas.	5		
Lancaster, Mr. W. J.	10		
Lawson, Mr. C.	5		
Lennard, Lady	1	1	
Le Strange, Hamon, Esq.	2	2	
Margetts, Mr. H.	5		
Martin, Mrs.	1	1	
Morgan-Brown, Rev.	10		
Morgan-Brown, Mr. J. C.	10		
Reece, W. H. Esq.	10		
Robinson, C. T. Esq.	10		
Robinson, Mr. F. W.	10		
Rolfe, E. N. Esq.	2	2	
Rolfe, Mrs. E.	1	1	
Selous, Mrs.	1	1	
Taylor, Joshua, Esq.	10	6	
Thompson, Jno. Esq.	1	1	
Wales, Mrs. S. A.	5		
Walker, Rev. H.	10		
Wharton, Mr. L.	10		
Whitmore, G. Esq.	1	1	
Whitty, Dr.	10		

Total Subs. £12 19

Donations.

Boat House, &c.	2	6	6
Total	£45	5	6

KING'S LYNN BRANCH.

(No Local Committee.)

Treasurer—
G. F. A. CRESSWELL, Esq.
Honorary Secretary—
Mr. C. H. LEMMON, Bank, King's Lynn.

Annual Subscriptions.

Archer, T. G. Esq.	10		
Bagge, T. E. Esq.	1	1	
Bird, Mr. F. A.	10		
Blencowe, Miss	1	1	
Boon, Mr. W. D.	5		
Burch, Miss John	1	1	
Cresswell, G. F. A. Esq.	1	1	
Everard, R. C. F. Esq.	1	1	
Freeman, J. Esq.	1	1	
Groom, John, Esq.	10	6	
Groom, Major J. E.	5		
Gurney, S. A. Esq.	1	1	
Hare, T. L. Esq. M.P.	1	1	
Mills, Mr. G. W.	5		
Queensberry, Marchioness of	1	1	
Stevenson, Mr. T. S.	5		
Thompson and Co. Messrs.	1	1	
Total Subs.	£13	6	

Donations.

Duke's Head Hotel	9	4	
Boxes under ss.	5	11	
Total	£13	15	9

MUNDESLEY BRANCH.

(No Local Committee.)

Honorary Secretary—
F. O. TAYLOR, Esq., Norwich.
Annual Subscriptions.
Amherst, Lord, of Hackney (1896) .. 2 2

	£.	s.	d.
Caley, J. W. & Co. (1896)	5		
Chamborlin & Smith (1896)	5		
Dolphin, Mrs. (1895)	5		
Haldimstein & Sons (1895-6)	1		
Jarrold and Sons (1895)	5		
Scriven, C. H. (1895-6)	10		
Southall & Co. (1895)	10		
Wild, Edward (1896)	5		
Total	£5	7	

PALLING BRANCH.

Local Committee—
Mr. CHARLES RODGERS, Chief Officer H.M. Coastguard.
Rev. T. A. A. CROSSLE.
J. WISEMAN, Esq.
Dr. RUDD.

Honorary Secretary—
Mr. E. FRENGH.

Annual Subscriptions.

Birkbeck, Sir Edward, Bart.	1	1	
Total Subs.	£1	1	

Donations.

Collected by Mr. J. Wiseman	1	1	6
Contribution Box	5		
Total	£2	7	6

SHERINGHAM BRANCH.

President—
H. M. UPCHER, Esq., J.P.
Local Committee—
Rev. J. S. BARFORD, M.A., Chairman.
JONATHAN DYBALL.
FORBES EDEN, Esq.
Major HORACE STUMPFORD.
Dr. ERNELEY STOPPER.
The CHIEF OFFICER H.M. COASTGUARD.
Honorary Secretary—
WYNDHAM CREMER, Esq., J.P.

Annual Subscriptions.

Amherst of Hackney, The Rt. Hon. Lord	1	1	
Barclay, J. G. Esq.	2	2	
Burrell, Mr. W. H.	10	6	
Buxton, Sir Powell, Bart.	2		
Cremer, W. Esq.	1	1	
Dixon, Mrs.	10		
Eden, Forbes, Esq.	10		
Mansfield, Hon. J. W.	1		
Moore, Mrs.	1		
Rogers, John, Esq.	10		
Stumpter, Dr. Erneley	5		
Total Subs.	£10	9	6

Donations.

Contribution Boxes and sums under 5s.	5	8	
Life-boat Sunday	11	2	2
Total	£21	17	4

WELLS BRANCH.

Patron and President—
The Right Hon. The EARL OF LICHFESTER, K.G.

Local Committee—
HERBERT DEWING.
G. EVERITT.
Rev. G. H. N. INGLE.
F. W. KERSLEY.
EDWD. B. LOYNES.
Capt. JNO. LOYNES.
J. T. MACK.
C. MIDDLETON.
A. W. RALLING.
Lieut. H. A. OLIVER, R.N.
G. F. SMITH.
JOHN M. WOOD.

Honorary Secretary—
HERBERT E. LOYNES.

Annual Subscriptions.

	£.	s.	d.
Amherst of Hackney, the Rt. Hon. Lord	1	1	
Andrews, Mr. G.	5		
Boulcott, Miss	5		
Brown, M.	5		
Dewing, Mr. Herbert	5		
Digby, Rev. C. T.	10		
Eade, Lady	1	1	
Emerson, R. Esq.	1		
Everitt, G. Esq.	5		
Gurney & Co. Messrs.	2		
Haycock, J. J. Esq.	5		
Ingle, Rev. G. H. N.	10		
Kersley, F. W.	5		
Lelcester, The Right Hon. The Earl of, K.G.	5		
Loynes, E. B.	10		
Loynes, H. E.	10		
Mack, Messrs. J. & J.	5		
Middleton, C. Esq.	10		
Nelson, E. Esq.	5		
Oliver, Lieut. H. A., R.N.	10		
Ralling, A. W.	10		
Rippingall, F. T. S. Esq.	1	1	
Scott-Chad, J. S. Esq.	1		
Smith, Messrs. F. & G., Ltd.	2	2	
Total	£20		

WINTERTON BRANCH.

Local Committee—
Rev. K. BAGNALL-OAKELEY.
H. K. BOND, Esq.
E. CONNOP, Esq.
Mr. FRANCOMBE, R.N.
Rev. W. A. GREEN.
Rev. G. MERRIMAN.
Rev. R. J. TACON.

Honorary Secretary—
Rev. W. A. GREEN, M.A.

Annual Subscriptions.

Birkbeck, Sir Edward, Bart.	1		
Connop, E. Esq.	10		
Green, Rev. W. A.	10		
Grissel, T. P. Esq.	1	1	
Hume, Mrs. Burdley	2		
Lucas, Rev. C. J.	1	1	
Merriman, Rev. G.	10		
Percival, A. P. Esq.	10		
Tacon, Rev. R. J.	10		
Total Subs.	£7	14	

Donations.

Offerings at Fishermen's Thanksgiving, Winterton Church (1895), per Rev. W. A. Green	2	3	1
Ditto, 1896	1	1	1
Total	£10	18	2

YARMOUTH AND CAISTER BRANCH.

President—
Sir JOHN COLOUB, M.P.
Local Committee—
WALTER BROWN, Esq., Chairman.

C. DYVER, Esq.
F. BURTON, Esq.
H. E. BUXTON, Esq.
W. DYVER, Esq.
J. H. FELLOWS, Esq.
Capt. PRICKETT, R.N.
T. B. STEWARD, Esq.
Capt. THORP (Trinity Service).
H. YOUELL, Esq.

Honorary Secretary—
A. F. CLOWES, Esq.

Annual Subscriptions.

Arnold Brothers	10	6	
Barge, S.	10	6	
Beeching Brothers	2	2	
Biddlecombe and Boring, Messrs.	10	6	
Birkbeck, Sir Edward, Bart.	1	1	
Brown, Walter	10	6	
Burton, F.	10	6	
Buxton, H. E.	1	1	
Chamberlin, H.	10	6	
Clowes, A. F.	10	6	
Clowes, J. E.	10	6	
Clowes, Miss Fanny	10	6	
Connop, E. M.	1	1	
Crabtree, W. F.	10	6	
Diver, C.	10	6	
Diver, W.	10	6	
Fellows, J. H.	10	6	
Gurneys & Co.	2	2	
Hart, E. J.	10	6	
Johnson and Sons	1	1	
Lacons, Youell, & Co.	1	1	
Leach, J.	10	6	
National Provincial Bank of England	1	1	
Palmer, Mrs. W. D.	1	1	
Saul, T. & Son	1	1	
Steward, Colonel	10	6	
Thorp, Captain (Trinity Service)	1	1	
Total	£22	1	

Donations.

Lady Visitor, per Miss Fox	1		
Officers and men of the Trinity Service	1	7	
Contribution Boxes	25	18	
Total Dons.	28	5	
Total Subs.	22	1	
Total	£50	6	

Northamptonshire.

NORTHAMPTON BRANCH.

(No Local Committee.)

Chairman—
T. P. DORMAN, Esq.
Treasurer—
W. G. HOBBS, Esq.
Collector—
Mr. A. H. KILBURN.

Annual Subscriptions.

	£.	s.	d.
Barry, James, Esq., J.P.	1	—	—
Bostock, F., Esq.	—	10	6
Chandler, H. P. Esq.	—	10	—
Dorman, T. P. Esq.	1	—	—
Grafton, His Grace the Duke of	—	—	—
Hesleden, B. Esq.	—	5	—
Hobbs, W. G. Esq.	—	5	—
Jones, Mrs.	—	10	6
Kilburn, Mr. A. H.	—	5	—
Manfield and Sons, Messrs.	—	10	—
Markham, J. M. Esq.	—	10	6
Osborn, T. Esq.	—	5	—
Page, A. Esq.	—	5	—
Phipps, P. Esq.	1	—	—
Ratcliffe and Jeffery, Messrs.	—	10	—
Sheffield, D. Esq.	—	5	—
Shoosmith, W. Esq.	—	10	—
Turner Bros., Messrs.	—	10	—
Total	£9	13	6

PETERBOROUGH BRANCH.

President—
J. HENRY BERRY, Esq., J.P.
Treasurer—
Lieut.-Col. SROONG, J.P.
Honorary Secretaries—
ANDREW PERCIVAL, Esq.
W. MELLOWS, Esq. (Town Clerk).

Annual Subscriptions.

Argles, Mrs.	—	5	—
Bali, Rev. Canon.	—	5	—
Barford & Perkins, Messrs.	—	1	—
Barrass, Rev. T. C.	—	5	—
Bays, E. J. & A. C.	—	10	—
Beaver, Mr. Alderman, J.P.	—	5	—
Beeby, Mr. Councillor	—	1	—
Beresford, Rev. J. J.	—	10	—
Bird, Mrs.	—	1	—
Bodger, Mrs.	—	5	—
Bristow, Mr. J.	—	1	—
Cadge & Colman, Messrs.	—	1	—
Capron, Rev. G. H.	—	10	—
Clarabut, Mr. W.	—	10	—
Clayton, Rev. Canon	—	10	—
Cliffe, Mr. Councillor, J.P.	—	5	—
Clifton, Mr. Councillor.	—	5	—
Collins, Mr. C. W.	—	5	—
Crick, Mrs. C.	—	5	—
Crisp, Mr. E.	—	5	—
Dandy, Mr. Charles.	—	5	—

Davis, Mr. G. J.	—	5	—
Ellis, Mr. J. Shipley	—	10	6
Elsey, Mr. R. W.	—	10	6
English, Mr. H. H., J.P.	—	1	—
Everard, Mr. C.	—	1	—
Fairweather, Mr. J.	—	5	—
Fitzwilliam, Mr. G. C. W., J.P.	—	1	—
Fox & Vergette, Messrs.	—	5	—
Gray, Mr. G. J.	—	5	—
Harrison, Mr. J.	—	5	—
Hill, Mr. R.	—	5	—
Johnson, Mr. T. R.	—	1	—
Jolly, Dr. R. W.	—	10	6
Jones, Rev. L. T.	—	5	—
Keeble, Mr. A. J.	—	5	—
Keeble, Mr. G., J.P.	—	5	—
Kirkwood, Dr. G.	—	10	6
Little, Mr. H.	—	5	—
McDonnell, Rev. Canon, 1895-96	—	10	—
Mellows, Mr. W.	—	10	6
Northampton Brewery Co.	—	1	—
Nuti, Mrs.	—	5	—
Pank, Mr. H.	—	5	—
Payling, Mr. R.	—	5	—
Percival, Mr. A.	—	1	—
Phipps & Co., Messrs.	—	10	6
Purvis, Mr. R., M.P.	—	1	—
Redhead, Alderman D. H., J.P.	—	10	—
Sharpe, Mr. W. H.	—	5	—
Simpson, Mr. J.	—	1	—
Smith, Miss	—	5	—
Southern, Miss	—	10	—
Stones, Mr. T.	—	5	—
Strong, Mr. C.L., J.P.	—	1	—
Sykes, Mr. A.	—	10	—
Tansley, Mr.	—	5	—
Walker, Mrs., senr.	—	10	—
Walker, Miss	—	5	—
Wenlock, Mr. J.	—	5	—
Sums under 5s.	—	2	19
Total	£33	3	6

Donations.

Caster, Mr. A.	—	10	—
Thompson, J. Esq., J.P., Mayor	—	1	—
Tryon, Rev. F.	—	1	—
Sums under 5s.	—	14	6
Total Dons.	3	4	6
Total Subs.	33	3	6
	£36	8	—

Northumberland.

ALNMOUTH BRANCH.

Local Committee—
J. W. PEASE, Esq., Chairman.
H. E. BROWN, Esq.
Mr. ROBERT SIMPSON.
Rev. D. MOORE.
Mr. W. ROBERTSON.
Mr. W. STROTHER.
Mr. H. W. WALTON.

**Honorary Secretary—
The Rev. D. MOORE.**

Annual Subscriptions.

	£.	s.	d.
Northumberland, The Duke of	—	2	—
Armstrong, Lord	—	1	—

Brown, H. E. Esq.	—	10	—
Browne, A. H. Esq.	—	1	—
Chrisp, L. C. Esq.	—	10	6
Crewe, Lord, Trustee of	—	1	—
Gibson, T. G. Esq.	—	2	—
Hindmarsh, W.T. Esq.	—	1	—
Moore, Rev. D.	—	10	—
Pease, J. W. Esq.	—	2	—
Percy, Earl	—	1	—
Purvis, Mr. H. T.	—	10	—
Robertson, Messrs.	—	5	—
Scott, H. Esq.	—	1	—
Shilbottle Colliery, Lessees of	—	10	—
Simpson, Mr. Robt.	—	5	—
Stanton, C. Harrison, Esq.	—	1	—
Strother, Wm. Esq.	—	5	—
Tate, T. Esq.	—	10	—
Thew, Arthur H. Esq.	—	10	—
Walton, H. W.	—	5	—
Wheeler, Mrs.	—	1	—
Willyams, H. J. Esq.	—	10	—
Woods, James, Esq.	—	1	—
Sums under 5s.	—	2	6
Total Subs.	£20	11	—

Donations.

Contribution Boxes	—	5	8
Total	£20	16	8

BAMBURGH CASTLE BRANCH.

Local Committee—
The Rt. Hon. Lord ARMSTRONG.
J. A. H. BURDON-SANDERSON, Esq.
R. BURDON-SANDERSON, Esq.
J. FOSTER, Esq.
Dr. HODGKIN.
J. F. HUTCHINSON, Esq.
T. HUTCHINSON, Esq.
Rev. CANON LONG.
W. E. LONG, Esq.
Dr. MACASKIE.
G. ROSS, Esq.
W. A. WATSON-ARMSTRONG.

**Honorary Secretary—
J. F. HUTCHINSON, Esq.**

Annual Subscriptions.

Anderson, J. the late	—	5	—
Armstrong, The Rt. Hon. Lord	—	1	—
Armstrong, W. A.	—	1	—
Watson, Esq.	—	1	—
Burdon - Sanderson, J. A. H. Esq.	—	10	—
Hodgkin, Dr.	—	1	—
Hutchinson, T. Esq.	—	10	—
Long, Rev. Canon.	—	10	6
Long, W. E. Esq.	—	10	6
Macaskie, Dr.	—	10	—
Ross, G. Esq.	—	5	—
Total Subs.	£6	1	—

Donations.

Interest upon £1,000 given by Miss Betty Cuttell for the maintenance of the Bamburg Castle Life-boat	—	30	—
Contribution Boxes	—	7	4
Total	£36	8	4

BERWICK BRANCH.

Local Committee—

Rev. C. BALDWIN, Chairman.
R. G. BOLAM.
ROBERT BOSTON.
Dr. F. CAHILL.
COLLECTOR OF CUSTOMS.
THOMAS DARLING.
Capt. FORBES, R.N.
HARBOUR-MASTER.
DAVID HERRIOT.
INSPECTING COMMANDER OF COASTGUARD.
Capt. NORMAN, R.N.
A. T. ROBERTSON.
Rev. E. RUTTER.
ROBERT WEDDELL.

Honorary Secretary—

B. G. SINCLAIR, Esq.

Annual Subscriptions.

	£.	s.	d.
Alder, Wm. & Son	—	5	—
Allan Bros., Messrs.	—	10	6
Batty, Geo. Esq.	—	5	—
Berwick Salmon Fisheries Company	1	—	—
Bolam, R. G. Esq.	—	10	—
Broadway, J. Esq.	—	5	—
Cahill, Dr. F.	—	5	—
Crossman, the Misses	2	—	—
Edney, J. M. Esq.	—	5	—
Fleming, L. T. & J.	—	5	—
Forbes, Capt. R.N.	—	10	—
Forster, Col. James	—	1	—
Harrison, G. A. Esq.	—	10	—
Johnson & Darlings, Ltd.	—	10	6
MacLagan, Dr. C.	—	5	—
Marshall, R. Esq.	—	5	—
McCraith, H. Esq.	—	5	—
Norman, Capt. J.P.	—	10	—
Paxton and Purves	—	5	—
Riddell, Mrs.	—	5	—
Rutter, Rev. Evan.	—	5	—
Sanderson, S. Esq.	—	10	—
Shipwrecked Mariners' Society	—	10	3
Sinclair, B. G. Esq.	—	5	—
Smith, Mrs.	—	5	—
Stevie, G. F. Esq.	—	5	—
Stevenson, J. Esq.	—	5	—
Vicar, The	—	5	—
Watson, Askew Robertson, Esq.	—	1	—
Weatherston, Joseph Esq.	—	5	—
Weddell, Robt. Esq.	—	5	—
Woods & Co. Bankers	1	1	—
Sums under 5s.	—	3	13
Total	£18	13	3

Donations.

Borderers' Association	—	1	—
Concert at Spittal	—	5	—
Johnston, Mrs. Geo.	—	10	—
Melrose Sabbath School	—	5	—
Life-boat boxes	—	3	4
Total Dons.	£19	10	9
Total Subs.	£18	13	3
	£38	4	—

BLYTH BRANCH.

Local Committee—
Mr. MICHAEL REDMOND,
 Chairman.
 Chief Officer of Coastguard
PRATT.
Mr. JOHN DENT.
Mr. GEORGE DINGSDALE.
Mr. A. H. DROMGOOLE.
Mr. JOHN EASTON.
Mr. JOHN HEDLEY.
Mr. J. KEENLYSIDE, Sen.
Dr. NEWSTEAD.
Mr. THOMAS C. NICHOLSON.
Mr. W. C. WINSHIP.

Honorary Secretary—
Mr. JOHN R. EASTON.

Annual Subscriptions.

	£.	s.	d.
Anderson, C. W.	5	-	-
Armstrong, Lord.	1	-	-
Ashington Coal Co.	1	1	-
Bedlington Coal Co.	2	2	-
Bell, Robert & Co.	10	6	-
Blyth Dry Dock Co., Ltd.	10	-	6
Blyth & Tyne Brewery Co.	5	-	-
Blyth Foundry Co.	5	-	-
Blyth Ship Building Company, Ltd.	10	6	-
Burdon, A. E. Esq. (for 1895-6)	2	-	-
Cowpen Coal Co., Ltd.	2	2	-
Craggs, Thos.	5	-	-
Cummings, Geo.	5	-	-
Dawson, Mrs. G.	10	-	-
Dent & Co.	10	-	-
Guthrie & Guthrie	5	-	-
Hedley and Co.	10	6	-
Hodgkin, Barnett, Pease, Spence & Co.	3	3	-
James, Rev. C. W.	5	-	-
Keenlyside, J.	5	-	-
Lambton and Co.	3	3	-
Laycock, Jos., & Co.	1	1	-
Lee, Jos.	5	-	-
Lynn & Rutherford.	5	-	-
Mathwin & Son	5	-	-
Moust, John.	5	-	-
Newstead, Dr.	5	-	-
Petersen, Tate & Co.	5	-	-
Ridley, Sir M. W. Bart., M.P.	5	-	-
Saunders & Co.	5	-	-
Saunders & Co.	5	-	-
Seaton Delaval Coal Co., Limited	2	2	-
Sidney, M. W. Esq.	10	6	-
Smith, W. R.	10	-	6
Thompson, J.	1	1	-
Thornton and Croft Trustees, per Mr. Gough.	2	2	-
Ward, W. M.	5	-	-
Watson Bros.	5	-	-
Watts, Watts & Co.	5	5	-
Willson, Walter	10	-	6
Woods & Co.	3	3	-
Worms, Josse & Co.	10	6	-
Wright, G. & N.	5	-	-
Sums under 5s.	4	7	-
Total	£48	9	6

Donations.

Dues collected at Custom House	72	11	9
Contribution Box at Ditto	22	12	6
Ditto at Blyth Dock.	14	12	6
Ditto at Blyth Shipyard.	3	14	3
Total Dons.	113	10	6
Total Subs.	48	9	6
£162			

BOULMER BRANCH.

Local Committee—
Rev. H. G. DICKINSON, Chair-
man.
Mr. THOMAS DODDS.
Rev. CHAS. GREEN.
JAS. GREY, Esq.
Mr. JOHN MIDDLEMAS.

Honorary Secretary—
ROBERT BROWN, Esq.

Annual Subscriptions.

	£.	s.	d.
Allgood, Rev. James	1	-	-
Bell, Mrs.	1	-	-
Bosanquet, C. B. Esq.	1	1	-
Brown, Robert	1	-	-
Browne, A. H. Esq.	1	1	-
Collinson, Mr.	10	-	-
Craster, T. W. Esq.	10	-	-
Dickinson, Rev. G. H.	10	6	-
Dodds, Thomas.	10	-	-
Green, Rev. C.	10	6	-
Grey, The Earl.	2	-	-
Grey, Jas. Esq.	10	-	-
Grey, Sir E. Bart. M.P.	1	-	-
Middlemas, Messrs.	10	-	-
Northumberland, The Duke of.	2	-	-
Percy, Earl	1	-	-
Ronaldson, Mrs.	10	-	-
Smith, The Misses.	5	-	-
Tankerville, Earl of.	1	-	-
Tate, J. Esq.	10	-	-
Thorpe, Rev. W.	10	-	-
Total Subs.	£17	8	-

Donations.

Contribution Boxes	7	1	-
Total	£17	15	1

CRESSWELL BRANCH.

(No Local Committee.)

Honorary Secretary—
F. WITKRELL, Esq.

Annual Subscriptions.

Cresswell, A. F. B. Esq.	10	-	-
Total	£10	-	-

HAUXLEY BRANCH.

Local Committee—
S. F. WIDDRINGTON, Esq.,
 J.P., Chairman.
MIDDLETON H. DAND, Esq.,
 J.P., Vice-Chairman.
H. ANDREWS, Esq.
THOS. CLUTTERBUCK, Esq.,
 J.P.

Rev. CANON DIXON.
C. T. MALING, Esq.
Geo. SANDERSON, Esq.
T. H. BAINBRIDGE, Esq.
JOHN D. MILBURN, Esq.
EDWARD THEW, Esq.
JAMES ANGUS, Esq.

Honorary Secretary—
Rev. JAMES FAIRBROTHER.

Annual Subscriptions.

Northumberland, His Grace the Duke of	2	-	-
Bainbridge, T. H. Esq.	2	2	-

	£.	s.	d.
Carr, Rev. T. W.	1	-	-
Clutterbuck, T. Esq.	1	1	-
Dand, M. H. Esq.	1	1	-
Dixon, Canon	10	6	-
Huggup, Miss.	10	6	-
Lawson-Smith, E. M. Esq.	2	-	-
Maling, C. T. Esq.	1	1	-
Milburn, John D. Esq.	2	2	-
Sanderson, Geo. Esq.	1	1	-
Thew, Edw. Esq.	10	6	-
Warkworth Harbour, Commissioners of	10	-	-
Widdington, S. F. Esq.	2	2	-
Total	£27	1	6

HOLY ISLAND BRANCH.

Local Committee—
Maj.-Gen. Sir Wm. CROSSMAN,
 K.C.M.G., R.E., Chairman.
Mr. JOHN JONES (Coast-
 guard).

Honorary Secretary—
Rev. D. BAYSON.

Annual Subscriptions.

Armstrong, L.	1	1	-
Border Brewery Co.	10	6	-
Crew's, L. Trustees.	2	2	-
Crossman, Major-G. Sir W.	2	2	-
Cruddas, W. D. Esq.	1	1	-
Douglas, Mr.	1	-	-
Grey, J. Esq.	10	-	-
Robertson, W. A.	1	1	-
Total Subs.	£29	7	6

Donations.

Contribution Boxes.	2	4	-
Total	£11	11	6

NEWBIGGIN BRANCH.

Local Committee—
Rev. O. RHODES, Chairman.
WILLIAM ALMOND.
Mr. ABBE, Coastguard.
JOHN BROWN.
ROBERT GRAY.
T. RENNER.
JOHN TATE.
J. W. WOOD.

Honorary Secretary—
JOHN TATE.

Annual Subscriptions.

Bell, J. Lowthian	1	1	-
Foster, Robert.	1	1	-
Gray, Robert.	1	1	-
Lownds, J. R.	10	-	-
Maling, J. P.	10	6	-
Nesham, T. C. M.D.	1	1	-
Northumberland, His Grace the Duke of	2	-	-
Rhodes, Rev. O.	10	-	-
Sample, Thos.	10	-	-
Shortt, Mrs.	1	1	-
Tate, John	10	-	-
Watts, Mrs.	10	-	-
Wood, J. W.	10	-	-
Total	£10	15	6

Donations.

	£.	s.	d.
Donations	7	5	-
Contribution Boxes	17	8	-
Total Dons.	8	2	8
Total Subs.	10	15	6
£18 18 2			

NEWCASTLE, TYNE-MOUTH & CULLERCOATS BRANCH.

Vice-Patrons—

Rt. Hon. EARL RAVENSWORTH.
Right Hon. LORD HASTINGS.
W. B. BEAUMONT, Esq. M.P.

President—

HUGH TAYLOR, Esq.

Local Committee—
Rev. CANON HICKS,
 Chairman.

H. E. P. ADAMSON.
JOHN BAUCE, Harbour-
master, North Shields.
COLLECTOR OF CUSTOMS,
 North Shields.

C. B. GOLDSON.
J. L. GRACE.
JOSEPH GREEN.
JAMES HALL.
E. JONES, Chief Officer
 Coastguard, Tyne-
 mouth.

F. E. MESSENT.
S. MORRISON.
JOHN FORSTER SPENCE.
ALEX. S. STEVENSON.

JOHN WAIT.
J. A. WILLIAMSON.
JOHN M. WINTER.

Treasurer—

RALPH E. LAMBTON, Esq.

Hon. Sec. at Tynemouth—

Hon. Sec. at Cullercoats—
R. J. LRESON, Esq.

Hon. Auditors—

J. M. WINTER & SON, Ac-
 countants, Newcastle-on-
 Tyne.

Annual Subscriptions.

Angus, Geo., & Co.	1	1	-
Armstrong, Sir W. G., & Co., Ltd.	2	2	-
Bainbridge & Co.	1	1	-
Benson, W. & Son	1	1	-
Bessler, Waechter & Co., Limited	1	1	-
Borries, Craig & Co.	10	6	-
Brown, J. J.	10	6	-
Brown, Ralph	2	2	-
Charlton, Henry	5	-	-
Clapham, H. & Co.	10	6	-
Clayton, J. R.	1	1	-
Dees, R. E. Esq.	10	6	-
Dixon, S. & C.W., & Co.	10	6	-
Farley, Clarke, and Berkeley	1	1	-
Fenwick, Gerard	1	1	-
Fenwick, Mark	1	1	-
Forster, James J.	10	6	-
Foster, Blackett and Wilson	10	6	-
Greene, J. and Son.	1	1	-
Haggie Bros.	1	1	-
Hart, J. De	1	1	-
Hawthorn, Leslie, & Co.	1	1	-
Holmes, W. H.	1	1	-

	£.	s.	d.
Joicey, Jas. & Co.	1	1	-
Laing, Alex. & Co.	10	6	-
Lamb, R. O.	1	1	-
Lambton & Co. Messrs.	5	5	-
Maling, C. T.	1	1	-
Neelson, Donkin, & Co.	1	1	-
Newcastle Branch of National Provincial Bank of England.	3	3	-
Owners of Charlaw Colliery	10	6	-
Owners Pelaw Main Colliery	2	2	-
Ors. Backworth Colly.	1	1	-
Owners of Bedlington Colliery	2	2	-
Palmer, Sir C. M.	1	1	-
Priestman, Mrs.	1	1	-
Pyman Bell & Co.	1	1	-
Ravensworth, Rt. Hon. Earl	2	-	-
Richardson Bros.	10	6	-
Ridley, Son, & Tully, John	10	6	-
Smith, T. & W.	1	1	-
Stephens & Mawson.	5	-	-
Straker, Chas. E.	1	1	-
Tyne General Ferry Company	5	5	-
Watson, S. O.	10	6	-
Wilkinson, W. B. & Co.	1	1	-
Woods and Co.	5	5	-
Woods, J. A.	1	1	-
Total	£62	7	-

Donations.

North Shields Co-operative Society.	1	1	-
Tynemouth Boxes—Box on Pier	1	8	9
Hop Pole Inn, South Shields	8	8	-
Cullercoats Boat-house	6	1	-
Total Dons.	3	4	6
Total Subs.	£62	7	-
	£68	11	6

NORTH SUNDERLAND BRANCH.

President—
E. C. CRASTER, Esq.

Local Committee—
Lieut.-Col. MARSHALL,
Chairman.
Mr. JAMES EWING.
Mr. W. KING.
Capt. ORDE.
Mr. G. RAYNARD.
Mr. GEORGE TAIT.
Rev. C. F. THORP.

Honorary Secretary—
Rev. A. M. MACPHER.

Annual Subscriptions.

Lord Crewe's Trustees	30	-	-
Bentley, Mrs.	10	-	-
Browne, A. H. Esq.	1	-	-
Clark, G. D. A. Esq.	10	-	-
Crafter, E. Esq.	5	-	-
Ewing, Mr. James	1	-	-
King, W.	10	-	-
MacPhee, Rev. A. M.	10	-	-
Marshall, Anthony, Esq.	1	-	-
Marshall, Mrs. I. C. R.	1	-	-
Marshall, Mrs. T. B.	10	-	-

	£.	s.	d.
Orde, Capt.	10	-	-
Sanderson, Mrs. J. B.	10	-	-
Taylor, John, Esq.	10	-	-
Thorp, Rev. C. F.	1	-	-
Total Subs.	£44	-	-

Donations.

Contribution Boxes	4	9	-
Total	£44	4	9

Nottinghamshire.

NEWARK BRANCH.

(No Local Committee.)

Honorary Secretary—
Mr. E. T. SIMMONS.

Annual Subscriptions.

	£.	s.	d.
Bainbridge and Co. Messrs.	10	-	-
"Boat"	-	3	-
Branston, Mr.	10	-	-
Branston, Mr. J. G.	10	-	-
Chew, Mrs.	5	-	-
Clarke, Mrs. W. P.	5	-	-
Easterfield, Mr. J. E.	5	-	-
Falkner, Mr. E. S.	10	-	-
Gilstrap, Mrs. Geo.	10	-	-
Hodgkinson, Mrs.	10	-	-
Ironmonger, Miss	5	-	-
Martin, Rev. H. A.	1	1	-
Oakden, Mr. R.	1	1	-
Parker, Miss	5	-	-
Plaster, Rev. H.	10	-	-
Riddell, Mr. E. M. H.	1	1	-
Simmons, Mr. E. T.	5	-	-
Subscribers of half-crowns	10	-	-
Tallents, Mr. W. E.	10	-	-
Tallents, Mr. G.	10	-	-
Thorpe, Colonel	10	-	-
Total	£9	18	3

NOTTINGHAM BRANCH.

Local Committee—
Mr. A. BRADLEY.
Mr. A. J. BUTLER.
Mr. CHRISTALL.
Mr. FRED. W. FOX.
Mr. G. F. GASCOYNE.
Mr. ALFRED PAGE.
Mr. J. M. PERRY.
Mr. J. WEINBERG.
Dr. T. WRIGHT.

Honorary Secretary—
A. ERNEST HEAZELL, Esq.

Annual Subscriptions.

Armitage, S. F. Esq.	1	1	-
Birklin, T. J. Esq.	1	1	-
Bradley, A. Esq.	2	2	-
Cowen, G. R. Esq.	10	-	-
Dale, Miss	5	-	-
Dale, Mr. T. B.	5	-	-
Goater, Alfred, Esq.	1	1	-
Goodlife, W. F. Esq. Jun.	5	-	-
Goldschmidt, E. Esq.	10	6	-
Heazell, W. A. Esq.	10	-	-
Heazell, A. Ernest, Esq.	10	6	-

	£.	s.	d.
Heymann, A., Esq.	1	1	-
Jacoby & Co. Messrs.	1	1	-
Kenrick, George, Esq.	1	1	-
Miller, W. W. Esq.	10	6	-
Page, Alfred, Esq.	1	1	-
Perry, J. M. Esq.	1	1	-
Seeley, Colonel, M.P., and Sir Charles	2	2	-
Simon May and Co., Messrs.	1	1	-
Sollory, Mrs.	5	-	-
Sulley, Ed. Esq.	2	2	-
Terry, William, Esq.	1	1	-
Thorpe, Henry, Esq.	1	1	-
Ward, Mr. Jas.	5	-	-
Woodward, Walter, Esq.	10	-	-
Woolley, Miss	1	1	-
Wright, Dr. T.	1	1	-
Wright, Miss	1	1	-
Wright, Miss Elizabeth	1	1	-
Total	£23	5	6

Oxfordshire.

HENLEY-ON-THAMES BRANCH.

(No Local Committee.)

Chairman—
C. LUCEY, Esq.

Honorary Secretary—
A. R. AWBERRY.

Annual Subscriptions.

	£.	s.	d.
Awbery, A. R.	10	6	-
Barnett, Mrs.	10	-	-
Brakspear, A. Esq.	1	1	-
Buckham, Mrs.	10	-	-
Child, Miss	10	-	-
Coates, W. T.	5	-	-
Cooper, J. Esq.	10	-	-
Crisp, F. Esq. (for 1895-6)	2	2	-
Lockey, Miss	1	1	-
Lucey, C. Esq.	1	1	-
Monk, C. Esq. (1895-6)	10	-	-
Morgan, F. Esq.	1	1	-
Page, J. Esq.	5	-	-
Pinckney, Rev. W. P.	1	1	-
Boxes	16	10	-
Total	£11	14	4

Hampshire.

ANGLE, MILFORD HAVEN, BRANCH.

Local Committee—
The Right Hon. the EARL OF CAWDOR.

Sir OWEN SCOURFIELD, Bart.

Honorary Secretary—
R. W. B. MIREHOUSE, Esq.

Annual Subscriptions.

	£.	s.	d.
Allen, H. Seymour, Esq.	1	-	-

	£.	s.	d.
Allen, Lady Catherine	1	-	-
Allen, H. Esq. Q.C.	1	1	-
Astley, D.	1	-	-
Cawdor, Earl of	2	2	-
Davis, Major	10	-	-
Fitzgerald, Admiral Penrose	1	-	-
Gibson, Capt. B.N.	2	-	-
Grenfell, Lieut., R.N.	1	-	-
Gulston, G.	1	1	-
Lambton, Col.	1	1	-
Lambton, Lady V.	1	1	-
Leach, Lt.-Col.	1	1	-
Lloyd, Rev.	10	-	-
Mirehouse, Mrs.	1	-	-
Monsley, T.	1	1	-
Murdock, Major	1	-	-
Burn, R. E.	1	-	-
Phillips, Mrs. Lort.	10	-	-
Phillips, Sir Charles	1	-	-
Puckridge, Rev.	5	-	-
Roch, N.A. Esq.	1	1	-
Royal Artillery Officers	2	-	-
Saurin, Col.	10	-	-
Scourfield, Sir Owen, Bart.	5	5	-
Scourfield, Lady	1	1	-
Stokes, A. Esq.	10	-	-
Watson, Capt. Burgess, R.N.	1	-	-
Total Subs.	£31	10	-

Donations.

Sundry Donations	10	-	-
Total	£32	-	-

FISHGUARD BRANCH.

Patron—
The Right Hon. LORD KENSINGTON.

Local Committee—
Mr. DAVID VAUGHAN, Vice-Chairman.
Mr. J. C. BOWEN.
Capt. C. F. COOKE.
Mr. HUGH DAVIES.
Capt. W. G. EVANS.
Capt. DANIEL GEORGE.
Capt. W. HARRIES.
Mr. J. MONK, Coast Guards.
Dr. H. L. SWETE, J.P.
Capt. WILLIAM WILLIAMS.

Honorary Secretary and Treasurer—
WALTER J. VAUGHAN, Esq.

Annual Subscriptions.

Clarke, Miss	10	-	-
Cooke, Capt. C. F. and Family	7	-	-
Evans, E. Eaton, Esq.	10	-	-
Johns, Rev. T.	5	-	-
Jolly, F. Esq.	10	6	-
Kensington, Lord	2	-	-
Laurie, General, M.P.	10	-	-
Mathias, Mrs. J.	1	1	-
Mortimer, Rev. T. G.	10	-	-
Owen, Dr. J. M.	5	-	-
Riddick, R. F. Esq.	10	6	-
Rowlands, J. Esq.	1	1	-
Sharp, — Esq.	5	-	-
Williams, W. Esq., J.P.	5	-	-
Winterbotham, W. H. Esq.	1	1	-
Yorke, Mrs.	1	-	-
Sums under 5s.	1	19	-
Total	£12	10	-

Donations.

	£.	s.	d.
Emery, F. W. Esq.	5	-	-
Hamilton, J. M. L.	1	1	-
Esq.	1	1	-
Contribution Boxes.	15	2	-
Nett proceeds of Concert.	4	1	6
Total Dons	7	2	8
Total Subs.	12	10	-
	£19	12	8

LITTLEHAVEN (ST. BRIDE'S) BRANCH.

Local Committee—
 Rev. J. O. HARRIS.
 Rev. J. MEARS.
 J. PHILPIN.
 R. ROGERS.

Treasurer—
 Rev. J. O. HARRIS, B.A.

Hon. Sec.—
 Mr. R. ROGERS.

Annual Subscriptions.

Baker, T. Esq.	5	-	-
Goldwyer, Mr. E.	10	-	-
Grainger, Mr.	5	-	-
Harvey, J. Wilkes	1	1	-
James, H. Esq.	10	-	-
John, Mr. W.	5	-	-
Marsh, T. E. M.	10	-	-
Thomas, Joseph, Esq.	10	-	-
Williams, Miss	10	-	-
Contribution Boxes	4	3	-
Total	£4	10	3

ST. DAVID'S BRANCH.

Patron—
 Right Rev. Lord Bishop of St. David's.

President—
 Rev. Canon LEWIS, M.A.

Local Committee—
 SAMSON T. WILLIAMS, Esq., Chairman.
 W. WATTS WILLIAMS, Esq., J.P., Vice-Chairman.
 The Very Rev. Dean ALLEN.
 Mr. W. ARNOLD.
 Capt. T. DAVIES.
 GILBERT D. HARRIS, Esq.
 Rev. J. B. JONES.
 Rev. J. PHILLIPS.
 Capt. S. ROACH.
 J. M. WILLIAMS, Esq.
 Mr. W. WILLIAMS.
 Dr. W. W. WILLIAMS.

Honorary Secretary—
 W. PEREGRINE PROBERT, Esq., LL.D.

Annual Subscriptions.

Allen, Very Rev. Dean	1	1	-
Allen, Miss	1	1	-
Arnold, Mr. W.	5	-	-
Bevan, The Ven. Archdeacon	1	1	-
Bishop of St. David's	1	1	-
Bishop of Swansea	10	6	-
Cawdor, Earl of	2	2	-
Davies, Capt. T.	5	-	-
Harries, Geo. Esq.	2	-	-
Harries, G. D. Esq.	10	-	-

	£.	s.	d.
Hicks, Dr., F.R.S.	10	-	-
Howell, Col.	1	-	-
Jones, Rev. J. R.	10	-	-
Lewis, Rev. Canon.	1	1	-
Mashiter, W. Esq.	1	-	-
Mashiter, Mrs. W.	1	-	-
Morgan, Mrs.	10	6	-
Mortimer, Rev. F. W. M.	5	-	-
Mortimer, Mr. W.	5	-	-
Phillips, Very Rev. Dean	5	-	-
Phillips, Rev. J.	5	-	-
Proper, Dr.	5	-	-
Proper, M. D. Esq.	5	-	-
Rees, Togarmah, Esq.	5	-	-
Roach, Capt. S.	5	-	-
Thomas, Miss	1	1	-
Williams, Rev Canon	5	-	-
Williams, J. M. Esq.	5	-	-
Williams, S. T. Esq.	5	-	-
Williams, Mr. W. W.	5	-	-
Williams, Mr. T. R.	5	-	-
Williams, Mr. W.	5	-	-
Williams, W. Watts, Esq.	5	-	-
Total	£20	4	-

Donations.

Sums under 5s.	1	11	7
Total Dons	1	11	7
Total Subs.	20	4	-
	£21	15	7

TENBY BRANCH.

President—
 CLEMENT J. WILLIAMS, Esq.

Local Committee—
 Captain HENDERSON, R.N., Chairman.
 Mr. GEORGE BOWEN.
 Dr. BRYANT.
 Mr. BURCH.
 ALDERMAN FAR EY.
 H. HARRIS, Esq.
 Captain LILLE.

Treasurer and Hon. Sec.—
 J. GRIFFITH LOCK, Esq., M.R.C.S., J.P.

Annual Subscriptions.

Allen, Egerton, Esq.	7	6	-
Baker, Miss	5	-	-
Black, Rev. C.	10	-	-
Blyth, A.	10	-	-
Booker, Mrs.	5	-	-
Bowen, General	10	-	-
Bromley, Mrs.	10	-	-
Brook, Mrs.	5	-	-
Brooks, Miss	5	-	-
Bryant, E. Esq.	5	-	-
Bull, Mrs.	5	-	-
Chater, Miss	5	-	-
Elliot, C. Esq.	10	-	-
Elliot, Rear-Admiral	10	-	-
Fisher, O. H. Esq.	5	-	-
FitzGerald, Col.	5	-	-
Geach, Mrs.	5	-	-
Graves, J. B. Esq.	5	-	-
Greenish, R. Esq.	5	-	-
Grinshaw, Miss	5	-	-
Gwynne, Dr. Cust.	10	-	-
Hamilton, B. Esq.	5	-	-
Henderson, Captain, R.N.	1	-	-
Hulton, H. Esq.	5	-	-
d'Ivanka, Madame	5	-	-
James, Miss	5	-	-
Jones, Mrs. Boileau	4	-	-
Kendall, B. Esq.	10	-	-

	£.	s.	d.
Laurie, Gen., M.P.	10	-	-
Lile, W. Esq.	5	-	-
Lock, Mrs. J. Griffith	10	-	-
Lock, Mrs. R.	5	-	-
Lock, R. Esq.	5	-	-
Logan, G. H. Esq.	5	-	-
Marchant, Mrs.	5	-	-
Mathias, Mrs.	5	-	-
Maunsel, Mrs.	1	-	-
Morgan, A. P. Esq.	10	-	-
Morris, Rev. D. M.	5	-	-
Nash, Rev. P.	5	-	-
Owen, S. H. Esq.	5	-	-
Parcell, Mrs.	5	-	-
Phillips, Mrs. Lloyd	5	-	-
Power, Mrs.	10	-	-
Richards, Mrs.	10	-	-
Ropes, Mrs.	10	-	-
Sparrow, A. Esq.	5	-	-
St. Mildred's Sisters	5	-	-
Stokes, C.W. R. Esq.	10	-	-
Thomas, Capt. Evan	5	-	-
Trash, C. H. Esq.	10	-	-
Vaughan, Mrs.	5	-	-
Vachell, J. W. Esq.	10	6	-
Vickerman, C.R. Esq.	1	-	-
Vickerman, C.H. Esq.	5	-	-
Westby, Mrs.	5	-	-
Williams, C. Esq.	2	2	-
Williams, D. Esq.	10	6	-
Willcock, Mrs.	10	-	-
Wilson, F. Esq.	1	1	-
Total Subs.	£29	10	6

Donations.

Sums under 5s. and Collecting Boxes	29	8	3
Total	£58	18	9

Shropshire.

SHROPSHIRE BRANCH.

Honorary Secretary—
 Mrs. SANDFORD, of Sandford.

Bankers—
 NATIONAL PROVINCIAL BANK, Whitechurch, Shropshire.
 BIRMINGHAM, DUDLEY, AND DISTRICT BANK, Shrewsbury.

Annual Subscriptions.

	£.	s.	d.
Beckett, Mr.	1	-	-
Bibby, Mr.	10	10	-
Billings, Mrs.	10	-	-
Blunt, Mrs.	10	-	-
Botfield, Garnet, Rev. W. B.	10	-	-
Boughy, Lady	2	2	-
Broughton, Mrs.	10	-	-
Broughton, Miss	10	-	-
Charlewood, Rev. G.	10	-	-
Clowes, Mrs.	5	-	-
Clowes, Miss	5	-	-
Cooke, Mrs.	5	-	-
Cooke, Miss	5	-	-
Collier, Mrs.	1	1	-
Dod, Mrs.	2	2	-
Dugdale, Mr.	10	-	-
Egerton, Rev. Canon	5	-	-
Ethelston, Mr.	1	-	-
Faulkner, Rev. E.	1	1	-
Finch, Mrs.	5	-	-
Goodwin, Mr. R. C.	5	-	-
Gwynne, Dr.	10	6	-
Hall, Mrs.	10	-	-
Hammond, Mr.	10	6	-
Harrison, Mr. J. G.	10	6	-

	£.	s.	d.
Hayhurst, Mr. H. H.	2	2	-
France	10	-	-
Herbert, Lady Mary	10	-	-
Honyman, Sir Wm.	2	-	-
Howe, Mr. Wm.	10	-	-
Kent, The Misses	1	1	-
Keyworth, Mrs.	5	-	-
King, Roff, Mr.	5	-	-
Kynnersley, Mrs.	5	-	-
Lee, Col. H.	1	-	-
Lindsay, The Lady Jane	10	-	-
Marston Bros. Messrs.	5	-	-
Marston, Mr. R.	5	-	-
Neilson, The Misses	2	2	-
Pearson, Mr. R.	5	-	-
Peele, Mr. E. C.	10	-	-
Phillips, Mr.	1	-	-
Phillips, Mrs.	5	-	-
Poole, Miss	5	-	-
Poole, Mr. C. H.	1	-	-
Price, Rev. H.	1	-	-
Sandbach, Mrs.	10	-	-
Smith, Mr. R. T.	10	-	-
Stoker, Mrs.	10	-	-
Stamer, Lady	5	-	-
Thompson, Mr.	1	-	-
Twemlow, Mr. (Peaswood)	1	-	-
Wakeman, Sir Ofley	1	-	-
Walford, Mrs.	5	-	-
Walker, Mr. C. C.	1	1	-
Watson, Mr. (Trustees of)	5	-	-
Wingfield, Mrs.	10	-	-
Wood, Rev. J. Cooper	10	-	-
Wright, Rev. H.	5	-	-
Sums under 5s.	3	6	-
<i>The following (£6 8s.) was collected by Miss A. Downward, The Castle, Shrewsbury:—</i>			
Adams, Mr.	5	-	-
Adnitt & Naunton, Messrs.	5	-	-
Alltre, Messrs.	5	-	-
Burd, Dr.	5	-	-
Caswell & Bowden, Messrs.	5	-	-
Chance, Mr. A. F.	5	-	-
Downward, Miss	5	-	-
Downward, Miss H.	5	-	-
Downward, Miss A.	10	-	-
Forrest & Sons, Messrs.	5	-	-
Harding, Mr. W. E.	5	-	-
Hughes, Mr. H. H.	5	-	-
Lang, Mr.	5	-	-
Lea, Mr.	5	-	-
Lee, Henry & Co. Messrs.	5	-	-
Maddox & Co. Messrs.	5	-	-
Moss, Rev. H. W.	10	-	-
Poole, Mr. T. F.	5	-	-
Salter, Mr. J. B.	5	-	-
Walker, Mr. W. B.	5	-	-
Wilding, Mr. J. L.	5	-	-
Sums under 5s.	13	-	-
Total	£58	12	6

Donations.

Hanson, The Misses	2	-	-
Lower Heath School Box	6	-	-
Sandford, Mrs., of Sandford, Sale of Work	6	-	-
Do., Sale of Fruit	1	-	-
Offerory in Shavington Chapel, per Rev. R. Faulkner	6	2	3
Pengwern Boat Club	1	-	-
Interest	1	3	-
Total Dons	17	12	3
Total Subs.	58	12	6
	£76	4	9

Somersetshire.

BATH BRANCH.

Collector—
Mr. SILCOCKS.

Annual Subscriptions.

	£.	s.	d.
Armitage, Miss	1	1	-
Badd, S. P. Esq.	1	1	-
Bridges, Mrs.	5	-	-
Coats, Miss	5	-	-
Davis, Miss	5	-	-
Fletcher, Mrs. Scott	1	1	-
Formby, R. T. Esq.	2	2	-
Gilmore, Miss	5	-	-
Greathead, Rev. S.	5	-	-
Grosvenor, Mrs.	10	-	-
Hall, Mrs.	1	-	-
Knight, C. R. Esq.	5	-	-
Knight, Miss	5	-	-
Lean, Mrs. Stuckey	10	-	-
Marshall, C. J. Esq.	5	-	-
Offley, Mrs. (2 years)	1	-	-
Pagden, Mrs. F. J.	5	-	-
Sheppard, Miss	5	-	-
Smith, Miss Portia	5	-	-
Stother, Mrs. (2 years)	1	10	6
Thompson, Miss	10	-	-
Waterfield, Miss	1	-	-
Sums under 5s.	1	12	-
Total	£15	13	6

BRIDGWATER AND BURNHAM BRANCH.

President.
The Worshipful the MAYOR OF BRIDGWATER.

Local Committee—

A. GOSSET, Esq., Chairman.
Dr. F. C. BERRY.
THOMAS HOLT, Esq.
W. S. HOLT, Esq., Junr.
G. B. SULLY, Esq.
H. PIRRS, Esq.

Honorary Secretary—
WILLIAM STOATE, Esq.

Collector—
Mr. JNO. COX.

Annual Subscriptions.

Akerman, W. S. Esq.	10	6	-
Berry, Dr. F. C.	10	-	-
Bouverie, H. H. P. Esq.	2	-	-
Braithwaite, J. B. Esq.	1	1	-
Broadmead, T. P. Esq.	1	-	-
Corporation of Bridgewater (per the Mayor)	10	-	-
Gosset, A. Esq.	10	-	-
Holt Bros. Messrs.	1	1	-
Holt, W. S. Esq.	1	1	-
Jolliffe, The Hon. H. G. H.	1	1	-
Kennard, The Rev. Canon	1	1	-
Luttrell, Mrs.	1	-	-
Paget, Col Sir R. H., Bart., M.P.	1	1	-
Piers, H. Esq.	10	-	-
Stephenson, Rev. Prebendary	1	1	-
Stoate, W. Esq.	10	-	-
Sully, A. W. Esq.	5	-	-
Sully, G. B. Esq.	10	-	-
Thompson, H. J. K.	10	-	-
Total Subs.	£25	2	6

Donations.

	£.	s.	d.
Chapel Collections ("Life-boat Sunday")	10	-	-
Contribution Boxes	19	4	-
Total	£26	11	10

CLEVEDON BRANCH.

(No Local Committee.)

Honorary Secretary—
Miss LUCY A. CARTER.

Annual Subscriptions.

Aitchison, Misses	5	-	-
Berryman, F. Esq.	10	-	-
Carter, Misses	10	6	-
Cope-Proctor, C. W. Esq.	1	1	-
Day, H. C. A. Esq.	10	-	-
Elton, Str E. H. Bart.	1	1	-
Hill, C. Esq.	1	1	-
Knight, W. T. Esq.	10	6	-
Lavington & Son, Messrs. W. F.	1	1	-
Lindrea, G. Esq.	10	-	-
Newnham, Capt.	1	1	-
Sheldon, T. Esq.	1	1	-
Wright, Misses	5	-	-
Sums under 5s.	5	-	-
Total	£9	12	-

Donations.

Collected in Clevedon on Saturday, 4th November	5	-	-
Contribution Boxes	18	-	-
Total Dons.	5	18	-
Total Subs.	9	12	-
Total	£15	10	-

TAUNTON BRANCH.

(No Local Committee.)

Honorary Secretary—
Admiral JOHNSON.

Annual Subscriptions.

Badcock, Mrs. Robert	5	-	-
Badcock, H. J.	10	-	-
Bastard, Mrs.	1	-	-
Brames, Mrs.	5	-	-
Berger, Mrs.	1	-	-
Bourdillon, F. D.	10	-	-
Coldhurst, G. E.	10	-	-
Ewing, Mrs.	5	-	-
Fitzroy, Mrs.	10	-	-
Johnson, Admiral	1	-	-
Kinglake, Mrs. H.	5	-	-
Liddon, Edward, M.D.	1	1	-
Penny, T.	10	6	-
Penny, T. S.	1	1	-
Perry, Mrs.	10	-	-
Rawlinson, W.	1	-	-
Sweet, Capt. H. C.	10	-	-
Sweet, Mrs. H.	5	-	-
Thomson, Mrs.	10	-	-
Wakefield, Mrs.	2	2	-
Sums under 5s.	10	-	-
Total	£13	19	6

WATCHET BRANCH.

Patrons—
Sir A. A. HOOD, Bt., M.P.
G. F. LUTTRELL, Esq.
JOHN HALLIDAY, Esq.

Local Committee—

Rev. C. H. HEALE, Chairman.
JOHN ALLEN.
W. L. COPE.
L. HOLE.
A. VAUGHAN HORNE.
W. STOATE.
R. J. THORNE.

Honorary Secretary—
WILL. HORNE.

Collector—
RICHARD OWENS (Coastguard).

Annual Subscriptions.

	£.	s.	d.
Acland, Sir T. D., Bt.	2	-	-
Andrew, J. H.	5	-	-
Atton, Mrs. E.	5	-	-
Badcock, Daniel, Esq.	10	6	-
Barrow, R. P. Esq.	10	-	-
Bosanquet, H.R. Esq.	5	-	-
Brown, J. H. S.	5	-	-
Copp, Mr. W. L.	5	-	-
Daniel, Rev. A. H.	1	1	-
Davis, John	5	-	-
Escott, Rev. H. Sweet	10	-	-
Evered, T.	5	-	-
Gimblett, Miss	5	-	-
Halliday, Capt.	1	-	-
Hanbury Brewery Co.	1	-	-
Hawkes, Mr. T.	10	-	-
Heale, Rev. C. H.	10	-	-
Heathcote, Rev. S. J.	10	-	-
Herringham, Rev. W.	5	-	-
Herringham, J. P.	5	-	-
Hole, L.	5	-	-
Hood, Sir A. A. Bt.	2	-	-
Horne, A. V.	10	-	-
Jones, Thos. Esq.	5	-	-
Killick, Dr.	5	-	-
Luttrell, Capt.	10	-	-
Luttrell, G. F. Esq.	2	-	-
Luttrell, Rev. A.	1	-	-
Meade King, Rev. F.	10	-	-
No'ley, Marwood, Esq.	1	-	-
Ollerhead, Dr.	5	-	-
Paramore, J. R. Esq.	5	-	-
Penn, H. Esq.	1	-	-
Perifull, Miss	5	-	-
Peter, Rev. L. Y.	5	-	-
Sadler, Rev. O.	10	-	-
Siderfin & Co.	10	-	-
Somes, Mrs.	1	1	-
Stoate and Sons, Messrs.	10	-	-
Strange, W. Esq.	5	-	-
Thorne and Son, Messrs.	10	-	-
Trevisis, Hon. J. S.	5	-	-
Trevelyan, Sir Walter, Bart.	1	1	-
Trollope, Hon. R. C.	10	-	-
Vernon, Rev. J. R.	10	-	-
Wansbrough, A. C. Esq.	10	-	-
Wilson, Mr. G.	5	-	-
Sums under 5s.	7	-	-
Total Subs.	£34	3	6

Donations.

Contribution Boxes	1	12	10
Total	£35	16	4

WELLS BRANCH.

Collected by Miss BERTHA JEN-BLAKE.

Annual Subscriptions.

	£.	s.	d.
Badcock, Mrs.	5	-	-
Barnard, Miss	5	-	-
Barnard, Rev. Canon	10	-	-
Brancker, Miss	10	-	-
Brougham and Vaux, Right Hon. Lord (1895-6)	2	2	-
Buckle, Rev. Canon	5	-	-
Everett, J. G. Esq.	5	-	-
Fairbanks, Dr.	5	-	-
Fry, J. S. Esq.	5	-	-
Halliday, Miss	5	-	-
Harris, R. Esq.	5	-	-
Harte, Mrs.	5	-	-
Hippisley, E. Esq. (1895-6)	10	-	-
Hippisley, E. M. Esq.	5	-	-
Hippisley, W. J. Esq.	5	-	-
Hobhouse, Mrs.	5	-	-
Holloway, J. H. Esq.	5	-	-
Livett, Dr.	5	-	-
McLean, Mrs.	5	-	-
Moore, E. G. Esq.	1	-	-
Parfitt, Mrs. & Misses	10	-	-
Purnell, Dr.	5	-	-
Sugden, Hon. Mrs.	5	-	-
Tate, Messrs.	5	-	-
Way & Sons, Messrs.	5	-	-
Wish, Mrs.	1	1	-
Woods, Miss	5	-	-
Woods, Miss R. O.	5	-	-
Sums under 5s.	9	6	-
Total	£11	17	6

WESTON - SUPER-MARE BRANCH.

President—
T. MULLINS, Esq., J.P., C.C.

Local Committee—
S. E. BAKER, Esq.
J. J. BARSTOW, Esq., J.P., C.C.
J. P. CAPELL, Esq.
Capt. GAMMELL, R.N.
T. MULLINS, Esq., J.P., C.C.
Rev. E. A. SALMON.

Honorary Secretary—
CONWAY G. WARNE, Esq.

Annual Subscriptions.

Baker, E. Esq.	5	-	-
Baker, S. E. Esq.	5	-	-
Barstow, J. J. Esq.	1	1	-
Bennett, Miss	10	-	-
Brocklehurst, Capt.	5	-	-
Buck, Mrs.	5	-	-
Campbell, Mrs. J.	5	-	-
Capell, J. P. Esq.	5	-	-
Cox, D. Esq.	5	-	-
Cox, M. C. Esq.	5	-	-
Drake, Mrs.	10	-	-
Gammell, Capt. R.N.	5	-	-
Hall, Mr. C. R.	5	-	-
Harris, Miss	5	-	-
Heap, B.	5	-	-
Hooker, R. H.	5	-	-
Hunt, Mrs.	5	-	-
Le Marchant, W. H.	1	-	-
Lunell, The Misses	5	-	-
Major, W.	5	-	-
Martin, E. Esq.	5	-	-
Morton, Miss	5	-	-
Mullins, Thomas	5	-	-
Murray, Mrs.	5	-	-
Newman, F. W.	5	-	-
Peake, Messrs.	5	-	-

	£.	s.	d.
Pemmell, James.....	5	-	-
Pethick, H.	10	-	-
Phillips, Mrs. W. F. .	5	-	-
Rector, The (Rev. Preb. Salmon).....	10	-	-
Rossiter, Mrs.	5	-	-
Talbot, The Misses .	5	-	-
Theobald, Dr.	5	-	-
Tomkins, Rev. H. G. .	5	-	-
Sums under 5s.	16	18	3
Total Subs.	£27	19	3

Staffords hire.

BURTON-ON-TRENT BRANCH.

President—
The Rt. Hon. LORD BURTON.
Local Committee—
The Rt. Hon. LORD HINDLIP.
C. J. CLAY, Esq.
S. EVERSHED, Esq., M.P.
E. D. SALT, Esq.

Treasurer and Hon. Sec.—
Mr. W. BENNETT.

Annual Subscriptions.

	£.	s.	d.
Bass, Ratcliff & Grattan, Ltd.	10	-	6
Bell & Co.	10	-	6
Brown, Edwin A.	10	-	6
Cartledge, E.	5	-	-
Drewry, J. & W. J. .	1	1	-
Eadie, James, & Co., Ltd.	1	1	-
Elliott, R. S.	1	1	-
Evans, William	5	-	-
Evershed, Sydney, M.P.	1	1	-
Goodger, Henry	10	-	6
Gretton, Miss	1	1	-
Harrison, Charles .	10	-	6
Howarth, W.	5	-	-
Hunt, Mrs.	5	-	-
Ind. Coope, and Co. Ltd.	5	-	-
Lea, H. S.	10	-	6
Lowe, Thos. & Sons. .	10	-	6
Albion Brewery, Ltd. .	10	-	6
Marston, John, & Son, Ltd.	10	-	6
Meakin, L. & G.	1	1	-
Morris, J. & Son.	5	-	-
Oakden, W. S.	5	-	-
Porter & Son.	1	1	-
Ratcliff, Miss.	10	-	6
Ratcliff, Robert	1	1	-
Salt, Miss.	10	-	6
Salt, Thomas, & Co., Limited.	3	3	-
Thompson and Son, Ltd.	2	2	-
Tresise, J. N.	5	-	-
Truman, Hanbury, and Co., Ltd.	1	1	-
Walker, P. & Son, Ltd. .	2	2	-
Whitehead, T. N.	10	-	6
Worsey, F.	5	-	-
Worthington & Co., Ltd.	3	3	-
Wright and Son	1	1	-
Sums under 5s.	17	6	-
Total.	£44	12	-

Donations.		£.	s.	d.
Committee of Saturday's Life-boat Demonstration.	3	16	-	-
Pillar Boxes—				
White Hart Hotel .	8	1	-	-
Recreation Ground .	5	10	-	-
Sums under 5s.	12	2	-	-
Total Dons.	5	2	1	-
Total Subs.	44	12	-	-
	£49	14	1	-

LEEK BRANCH.

(No Local Committee.)

Treasurer—
Capt. T. J. SMITH.

Honorary Secretary—
ARTHUR NICHOLSON, Esq., J.P.

Annual Subscriptions.

Brealey, John, Esq., J.P.	1	1	-
Brough, Wm. S. Esq., J.P.	1	1	-
Challinor, Jos. Esq., C.C.	6	6	-
Hall, John, Esq., J.P. .	1	1	-
Heaton, Edwin, Esq. (the late).....	1	1	-
Jones-Byrom, W. R. Capt.	1	1	-
Nicholson, Arthur, Esq., J.P.	2	2	-
Nixon, B. B. Esq.	1	1	-
Ward, Mrs. Jane	1	1	-
Total.	£15	15	-

STAFFORDSHIRE POTTERIES BRANCH.

Treasurer—
FRED. ALLEN, Esq., Hanley.

BURSLEM.

Honorary Secretary—
G. W. GARLICK, Esq.

Annual Subscriptions.

Baker, C. G. Esq.	10	6	-
Boote, T. & R., Ltd. .	1	1	-
Boulton, Wm. Esq. .	10	6	-
Burgess and Leigh, Messrs.	1	1	-
Clive, Mrs. C. H.	1	1	-
Craig, W. Y. Esq.	1	1	-
Dunn, Bennett & Co., Messrs.	1	1	-
Emery, J. P. Esq. the late, Executors of. .	10	6	-
Emery, Robt. Esq.	10	6	-
Furnivals, Messrs. Ltd.	1	11	6
Garlick, G. W. Esq. .	1	1	-
Gibson, Samuel, Esq. .	1	1	-
Hughes, Thos. Esq. .	10	-	6
Hulme, Thos. Esq., Port Hill	1	1	-
Maddock, John, and Sons, Limited.	1	1	-
Shaw, A. Esq.	1	1	-
Smith & Ford, Messrs. .	10	6	-
Sneyd Colliery and Brickworks Co. Ltd. .	1	1	-

	£.	s.	d.
Tennant, F. Esq.	1	1	-
Till, T. and Sons.	1	1	-
Wood, Reginald N. Esq.	1	1	-
	£19	8	-

HANLEY AND NEWCASTLE. Per F. ALLEN, Esq.

Allen, Fred. Esq.	1	1	-
Baxter, Miss Patty .	10	6	-
Coghill, H. Esq.	1	1	-
Meakin, J. & G. Ltd. .	2	2	-

TUNSTALL.

Honorary Secretary—
C. H. WATSON, Esq.

Hollinshead, E. W. Esq.	1	1	-
Total.	£25	3	6

WOLVERHAMPTON BRANCH.

(No Local Committee.)

Chairman—
THOMAS SKIDMORE, Esq.

Honorary Secretary—
MR. SAMUEL HAND.

Annual Subscriptions.

Andrews & Co., F.	5	-	-
Armstrong, G.	10	6	-
Bayliss, Jones, and Bayliss.	1	1	-
Bissell, Mrs. S. M.	1	1	-
Blakemore, E.	5	-	-
Bridges and Son.	5	-	-
Butler, J. H.	10	6	-
Butler, W. & Co. Ltd. .	1	1	-
Clarke, T. & C. & Co. .	10	6	-
Colebourne, W. H.	5	-	-
Colledge and Bridgen	10	6	-
Cooke and Son, T. J. .	10	6	-
Cooley, W. B.	5	-	-
Cooper, John.	5	-	-
Cope Bros.	5	-	-
Cope, Captain T. B. .	10	6	-
Cope, Wm., & Co.	5	-	-
Cox, J. B.	5	-	-
Cozens and Shaw	5	-	-
Craddock Bros.	10	-	6
Crane, C. H.	10	-	6
Crane, Geo.	5	-	-
Davia Bros.	10	-	6
Edwards & Son, T. .	5	-	-
Enamel Chromographic Co.	10	6	-
Evans & Son, J.	5	-	-
Farwell, F. G.	10	6	-
Fleeming, W. L.	5	-	-
Gatis, Thos.	5	-	-
Gibbons, James.	5	-	-
Gibbons, J. L.	10	6	-
Glaze, S.	10	6	-
Graham, Thos.	5	-	-
Hardy, Peake & Co. .	10	6	-
Hickman, E.	1	1	-
Hollingsworth, A. .	5	-	-
Howell, Thos.	5	-	-
Hunter, E.	5	-	-
Keyseil, W.	5	-	-
Langley, Shaw & Co. .	10	6	-
Langman, Mrs. F.	10	-	6
Lavender, T.	10	-	6
Lea, Messrs. W. & Co. .	10	6	-
Lee, Arthur	10	6	-
Lysaght & Co., Ltd. .	10	6	-
Mander Bros.	1	1	-

	£.	s.	d.
Martin, G. M.	5	-	-
Meynell and Sons.	5	-	-
Miller, Jos. N.	1	1	-
Mills, Miss M.	1	1	-
Mureton, J. and Co. .	1	1	-
Muras, R.	5	-	-
Nock, B. B.	10	6	-
Newnham, Dr. C. A. .	10	-	6
Orme, Evans & Co. .	5	-	-
Owen and Fendelow .	1	1	-
Plant, W. & J.	5	-	-
Reynolds, W. B.	5	-	-
Rogers, Sons & Co., H. .	1	1	-
Russell, Thos.	10	-	6
Shaw and Son, John .	1	1	-
Skidmore, Thomas. .	10	-	6
Smith, Son & Wilkie .	5	-	-
Snappe, Geo.	5	-	-
Steward, J. F.	1	1	-
Thomas, W. Esq.	5	-	-
Tonks & Son, S.	10	6	-
Underhill & Son, Jno. .	10	6	-
Underhill, J. E.	10	6	-
Walters and Co., B. .	5	-	-
Walton Bros.	5	-	-
Ward, G. Esq.	1	1	-
Watren, R. B.	1	1	-
Weaver, W. H.	10	6	-
Wood, H.	5	-	-
Wood, Mrs. John.	1	1	-
Total.	£38	11	-

Donations.

Atkinson & Aden-brooke.	5	-	-
Allen, W. Gough .	5	-	-
Baker, Joseph	10	6	-
Beard & Son, J.	5	-	-
Chilton, H. H.	5	-	-
Day, Thomas	1	1	-
Dallow, Thomas.	5	-	-
Dobbs Bros.	10	6	-
Haslam, T. P.	7	6	-
Hunt, Thomas.	5	-	-
Jenks, I. J. & Son. .	10	6	-
Kemp & Wilcox.	5	-	-
Lewis, Price.	5	-	-
Miller, D. & Co.	5	-	-
Morgan, J. B.	5	-	-
Riley, John	1	1	-
Robinson, W. & Co. .	10	6	-
Sankey, W.	5	-	-
Sherwood, Wm.	5	-	-
Skidmore, A. C.	5	-	-
Smith, H. P.	5	-	-
Smithson & Co., G. R. .	5	-	-
Taylor, Horace.	5	-	-
Thorne, G. R.	5	-	-
Vernon, John	5	-	-
Other Sums.	2	6	-
Total Dons.	9	3	-
Total Subs.	£38	11	-
	£47	14	-

Suffolk.

ALDEBURGH BRANCH.

President—
THOMAS V. WENTWORTH, Esq., J.P.
 Local Committee—
VERNON ALLEN, Esq.,
 Chairman,
MR. AHEARN,
JOS. FLINTHAM, Esq.,
MR. S. MILLS.
 Honorary Secretary—
J. O. WILLIAMS, Esq., R.N.,
 Divisional Officer H.M. Coastguard.

Annual Subscriptions.

	£.	s.	d.
Adair, Sir H. E. Bart.....	1	1	-
Allen, Bulkeley, Esq. 2	2	-	-
Allen, Vernon, Esq. 3	3	-	-
Flintham, J. Esq.	10	-	-
Harrison, Miss Mabel 5	5	-	-
Janson, Miss.....	5	5	-
Joyson, R. H. Esq. 1	1	-	-
Lynn, Miss.....	1	-	-
Morris, Miss Sophia, In Memoriam of the late.....	1	-	-
Richards, Mrs. M. C. 1	1	-	-
Wentworth, T. V. Esq. 2	2	-	-
Total.....	£33	5	-

Donations.

Collection Boxes ...	9	1	-
Pillar Box	2	0	9
Proceeds of Concert given for R.N.L.B. Institution by Alfred Tuxef and G. V. Brown, Esqrs. 4	11	6	-
Thanksgiving Service, Aldeburgh Church, per Rev. H. Thompson, B.A.	7	2	-
Total Dons.....	17	8	6
Total Subs.	23	5	-
£40	13	6	

DUNWICH BRANCH.

Local Committee—
 Lieut.-Col. St. John **BARNE,**
 Chairman.
J. R. GRIMSEY, Esq.,
G. F. JOSSELYN, Esq.,
 Chief-Boatman-in-Charge,
S. WALK, H.M. Coastguard.

Honorary Secretary—
EDWARD T. LINGWOOD, Esq.

Annual Subscriptions.

Barne, Lieut.-Col.	2	2	-
Barne, Lady Constance	1	1	-
Barne, Miss.....	1	-	-
Baylie, W. E. Esq., and Mrs. Baylie ..	1	-	-
Couper, John, Esq., and Mrs. Couper ..	3	3	-
Dilly, Capt. and Mrs.	5	-	-
Grimesy, J. R. Esq.	5	-	-
Joselyn, G. F. Esq.	10	-	-
Lingwood, E. T. Esq.	5	-	-

	£.	s.	d.
Lomax, Thos. Esq.	1	-	-
Packard, H. W. Esq., and Mrs. Packard -	10	-	-
Scrivener, E. Levett, Esq.	1	-	-
Total	£12	1	-

Donations.

Fry, Lewis G. Esq.	10	-	-
Contribution Boxes at Dunwich.....	1	10	10
Contribution Boxes at Yoxford	6	7	-
Dunwich Church Offerory, per Rev. H. D. Day, M.A.	3	5	7
Sums under 5s.	7	1	-
Total Dons... 6	-	1	-
Total Subs.	12	1	-

GORLESTON BRANCH.

Local Committee—
 Capt. W. G. **ALDRICH, R.N.,**
 Chairman.
J. P. BAUMGARTNER, Esq.,
 Col. COLCOCKE.
DR. GILMORE,
W. G. LEWIS, Esq.,
C. S. ORDE, Esq.,
J. TOLVER WATERS, Esq.

Honorary Secretary—
DOUGLAS HEWETT, Esq.
 Assistant Hon. Secretary—
H. W. CASE, Esq.

Annual Subscriptions.

A few friends in			
China	10	-	-
Aldrich, Capt. R.N.	10	-	-
Baumgartner, Miss. 1	-	-	6
Baumgartner, J. P. Esq.	10	-	6
Birkbeck, Sir E. Bart. 1	-	-	6
Case, H. W.	10	-	6
Cockrill, Mr. Wm.	5	-	-
Coleman, Messrs. J. and J.	2	2	-
Coombe, Colonel.	10	-	6
Gilmore, Dr.	10	-	6
Hammond, Mr. Phillip	5	-	-
Hewett, Douglas, Esq.	10	-	6
Orde, C. S. Esq.	1	-	-
Ray, Colonel A. W.	10	-	6
Wright, G. Esq.	5	-	-
Sums under 5s.	5	-	-
Total Subs.	£10	5	6

Donations.

Contribution Boxes . 3	10	7
Total.....	£13	16

IPSWICH BRANCH.

Local Committee—
W. ALEXANDER, Esq.,
A. WAINCH, Esq.

Honorary Secretary—
J. F. TITCHMARSH, Esq.

Annual Subscriptions.

Alexander, W. Esq.	10	6
Biddell, G. A. Esq.	1	1
Boby and Jannings.	10	-

	£.	s.	d.
Brown, W. & Co.	1	1	-
Bunn, R. E. Esq.	2	2	-
Byles, Mrs.	1	1	-
Cobbold, Mrs. J. P.	1	1	-
Cornell and Cornell, Messrs.	5	-	-
Fish and Son, Messrs. F.	1	1	-
Filson, J. O. Esq.	10	-	-
Footman, Pretty, and Co., Messrs.	1	1	-
Fosdick, F. H. Esq.	10	6	-
Goddard, D. F. Esq., M.P.	10	6	-
Gwydyr, Right Hon. Lord	1	1	-
Ipswich Steam Shipping Company	1	1	-
Kerrison, Roger, Esq. 1	-	-	1
Limmer, Mr. John.	5	-	-
Mason, Admiral.	1	1	-
May, Mr. John.	5	-	-
Miller, R. M. Esq.	10	-	-
National Provincial Bank, per E. Nicklin, Esq.	10	-	-
Paul, Messrs. R. & W.	10	-	-
Ransomes & Rapier. 1	1	-	-
Titchmarsh, E. Esq. 1	1	-	-
Titchmarsh, J. F.	10	-	-
Tollemache Brothers 1	1	-	-
Turner, Messrs. E. R. and F.	1	1	-
Turner, Messrs. W. and A. J.	1	1	-
Wrinch, A. Esq.	10	6	-
Total Subs.	£23	14	-

Donations.

Odd fellows and Foresters Amalgamated Fete Committee.....	5	5
Total	£28	19

KESSINGLAND BRANCH.

(No Local Committee.)

Honorary Secretary pro tem—
MR. J. SYLLES.

Donations.

Contribution Boxes.	5	9
-----------------------------	---	---

LOWESTOFT BRANCH.

Local Committee—
 The Rev. C. J. **STEWART, M.A.,** Chairman.
W. L. BELL, M.D.,
Sir S. B. CROSSLEY, Bart.,
E. W. FOWLER, Esq., J.P.,
E. K. HARVEY, Esq., J.P.,
H. MORGAN, Esq.,
Capt. CHARLES REEVE, R.N.,
J.P.,
Col. SEPPINGS, J.P.,
W. A. S. WYNN, Esq., M.D.

Honorary Secretary—
B. PRESTON, Esq., M.A.,
J.P. Lowestoft.

Collector—
MR. J. E. COOK.

Annual Subscriptions.

Arnold, Mrs.	1	1
Andrews, Rev. W. H., M.A.	1	1

	£.	s.	d.
Andrews, Rev. L. W. H., M.A.	10	6	-
Barclay & Co., Messrs. 2	2	-	-
Barrett, Mrs. J.	1	1	-
Barrett, S. G. Esq.	10	6	-
Birkbeck, Wm. Esq., J.P.	1	-	-
Buxton, H. E. Esq., J.P.	1	1	-
Clemence, J. L. Esq., J.P.	5	-	-
Clubbe, Mrs.	1	1	-
Colman, J. J. Esq. 2	2	-	-
Crossley, Sir Savile, Bart.	2	2	-
Davey, Miss M.	1	1	-
DuCroiz, T. C. M. Esq.	10	-	-
Farrer, J. D. Esq.	1	1	-
Fowler, E. W. Esq., J.P.	1	1	-
Gibson, The Venerable Archdeacon, M.A.	10	-	-
Hanmer, J.G.J. Rear-Admiral	10	6	-
Harvey, E. K. Esq., J.P.	1	1	-
Johnson, Mrs.	1	1	-
Lawrence, Rev. Canon, M.A.	10	-	-
Leathes, P. Esq.	10	6	-
Lucas, Sir Thomas, Bart.	1	1	-
Morgan, H. Esq.	1	1	-
Morse, Frederick, Esq.	1	1	-
Payne, J. Bruce, Esq., M.A.	1	-	-
Peto, J. Esq., J.P.	10	6	-
Preston, Benj. Esq., M.A., J.P.	18	6	-
Reeve, Capt. C., R.N.	10	6	-
Shann, W. A. Esq., M.B.	10	-	-
Seppings, Lieut.-Col., J.P.	10	6	-
Stebbing, Mr. A.	5	-	-
Steward, Rev. C. J., M.A.	2	2	-
Thirle, Mr. T. E.	5	-	-
Welchman, F. R. Esq.	10	6	-
Wingfield, Mrs.	1	-	-
Worthington, J. C. Esq., J.P.	10	6	-
Wynne, W. A. S. Esq., M.D.	1	1	-
Youngman, W. Esq., J.P.	10	6	-
Total Subs.	£34	12	6

Donations.

Collecting Boxes ...	7	5	6
Total.....	£41	18	-

PAKEFIELD BRANCH.

Local Committee—
THOMAS DAVIES, Esq.,
 Chairman.
E. E. JOHNSON, Esq.,
 Captain LESLEY,
 Rev. LEWIS PRICE,
 T. SERGEANT, Esq.,
MR. W. COLBY.

Honorary Secretary—
T. F. DAVIES, Esq.

Annual Subscriptions.

Farracough, A.	5	-
Bayard, E.	5	-
Berry, W.	5	-
Bradbeer, B. S.	10	6
Davies, T.	2	2

	£.	s.	d.
Davies, C. L.	5	-	-
Davies, T. F.	10	6	-
Elsey, G.	1	1	-
Johnson, E. E.	10	-	-
Lesley, P.	10	-	-
Notley, A. G.	10	6	-
Price, Rev. Lewis. .	1	1	-
Read, Walter.	10	6	-
Reynolds, H. G.	1	1	-
Sergeant, T.	5	-	-
Slipper, R. G.	10	-	-
Smith, S.	1	1	-
Stebbing, Walter. .	5	-	-
Tattersall, J. F.	1	1	-
Waller, H. G.	5	-	-
Warman, W.	10	-	-
Wilson, J.	10	-	-
Sums under 5s.	2	6	-
Total,	£13	16	6

Donations.

J. F. T.	1	1	-
Contribution Boxes. .	1	4	6
Church Collection ("Life-boat Sunday")	1	5	-
Total Dons.	3	10	6
Total Subs.	13	16	6
£17	7	-	

SOUTHWOLD BRANCH.

Local Committee—
J. EUSTACE GRUBBE, Esq.,
 Chairman.
 ERNEST R. COOPER.
 MR. JAMES CRIMMEN.
 CHARLES DRAKEN.
 MR. E. D. DEBNEY.
 MR. H. J. DEBNEY.
 MR. W. H. ELMY.
 Rev. J. N. F. EWVE.
 ARTHUR GRUBBE, Esq.
 EUSTACE E. GRUBBE, Esq.
 D. R. GOODING, Esq.
 MR. J. D. SARGENT, C. O.
 H.M. Coastguard.
 Rev. C. H. SUTTON.
 Dr. WOOLLETT.

Honorary Secretary—
Mr. JOHN SINCLAIR, R.N.

Annual Subscriptions.

Cooper, E. R. Esq. .	10
Crimmen, Mr. James	10
Croft, G. C. Esq. .	1
Crowfoot, Mrs.	1
Deaken, C. Esq.	5
Debney, Mr. H. J.	10
Debney, E. D.	10
Edwards, H. R. Esq. .	1
Elmy, Mr. W. H.	10
Ewen, Rev. F. Esq. .	1
Foster, Charles, Esq. .	2
Gannon, Miss.	1
Gaussen, Mrs.	1
Gooding, D. R. Esq. .	10
Grubb, Mrs. E.	5
Grubbe, Arthur, Esq. .	10
Grubbe, Capt.	10
Grubbe, Eustace E. Esq.	1
Grubbe, E. W. Esq. .	2
Grubbe, J. E. Esq. .	2
Lodar, John, Esq. .	1
McMinn, F. A. Esq. .	1
Parry, James, Esq. .	1
Powell, Laurence, Esq.	1

	£.	s.	d.
Powell, Mrs.	10	-	-
Remnant, Mrs.	10	-	-
Steele, Mrs.	10	-	-
Sutton, Rev. C. H. .	1	-	-
Whitaker, Mrs.	1	-	-
Total	£25	10	6

Donations.

Freeman, Mr.	5	-	-
Gooding, J. Bruce, Esq.	10	-	-
Gouldby, Mr. James	10	-	-
Landell, Mrs.	1	-	-
Ratcliffe, Mrs.	1	1	-
Rowden, Mrs.	10	-	-
Sunday Church Collection.	6	-	-
Proceed of sale of Tricycle given by Mr. Hardingham. .	2	7	6
Collecting Boxes—			
North Cliff.	1	12	2
Life-boat house. .	1	10	11
Gun Hill.	1	19	6
Mr. E. W. Moore's office.	5	8	5
Four other boxes. .	1	5	0
Total Dons.	23	14	9
Total Subs.	25	10	6
£49	5	3	

THORPE BRANCH.

Local Committee—
 C. P. OGILVIE, Esq.,
 Chairman.
 T. P. BORRETT, Esq. J.P.
 FRANK GARRETT, JUN., Esq.
 Rev. C. du G. MAKEPEACE.
 Chief Officer KEMP.
 Chief Boatman MAC-MENAMY.
 Hon. Secretary—
 H. P. TODD, Esq.

Annual Subscriptions.

Borrett, T. P. Esq. J.P.	1	1
Carr, Mrs.	5	-
Cotton, Henry, Esq. .	2	2
Garrett and Sons, Messrs.	2	2
Stanford, Edward, junr., Esq.	1	1
Stevenson, F.S. Esq. M.P.	1	1
Ogilvie, C. P. Esq. .	2	2
Todd, H. P. Esq.	1	1
Total	£10	15

Donations.

Concert given by Hon. Sec.	9	-	-
Aldringham Church Collection.	5	16	7
Leiston Church Collection.	3	15	-
Contribution Boxes. .	8	7	-
Total Dons.	19	2	-
Total Subs.	10	15	2
£29	15	2	

Sussex.

BRIGHTON BRANCH.

Local Committee—
 Mr. Alderman A. H. COX,
 J.P., Chairman.
 Mr. Councillor E. BOOTH,
 Vice-Chairman.
 G. F. ARTHUR, Esq.
 W. BENNETT, Esq.
 His Worship THE MAYOR (Mr. Alderman J. J. BLAKE, J.P.).
 Mr. Ald. W. BOTTING, J.P.
 W. J. C. CONNINGHAM, Esq.
 Sir JOSEPH EWART, J.P.
 Capt. FORSTER, R.N.
 Mr. W. L. MARTIN, Chief Officer of H.M. Coastguard.
 H. A. PERRY, Esq.
 Mr. Alderman SENDALL.
 A. H. SUTHERLAND, Esq.
 F. W. TILLSTONE, Esq.
 Captain YOUNG, R.N., Commander of H.M. Coastguard, Brighton Division.
Honorary Secretary—
 A. H. FRY, Esq.
Bankers—
 Messrs. BARCLAY, BEVAN, TRITTON, RANSON, BOUVERIE & Co., Brighton Union Bank.

Annual Subscriptions.

Abbey & Sons.	10	6
Alhambra, The.	5	-
Amber Ale Brewery. .	5	-
A. W. W.	5	-
Arnold, Perrett & Co. .	5	-
Ashby & Co., Bedford Brewery.	1	1
Attree & Kent.	10	6
B. Geo.	5	-
Bakewell, J. W.	5	-
Barclay, J. G.	5	-
Barnard, J.	5	-
Banbury, Henry.	10	-
Banfield & Co.	5	-
Beckwith, Miss.	5	-
Bell, Sir William.	5	-
Bellard, Capt. J. B., R.N.	5	-
Bevan, R. T.	10	6
Bevan, The Misses. .	5	-
Beves & Co.	1	1
Bingham, Capt. the Hon. R., R.N.	5	-
Broadwood, J.	5	-
Booth, Edwin.	10	6
Boothby, C. E.	5	-
Brighton Cycle & Motor Co.	5	-
Brighton & Hove Co-operative Assoc. .	10	6
Bryan, Mrs.	1	-
Bunbury, Sir Henry, Bart.	10	-
Burchall, Mrs.	1	1
Burnaud, Mrs.	5	-
Bush, J. E.	5	-
Capel, F. C.	10	-
Capital and Counties Bank.	10	6
Catt, John & Co.	10	6
Cattley, W.	5	-
Cawthorne, James. .	1	1
Chamberlin, W. B. .	10	6
Chapman & Co., Black Lion Brewery.	10	6
Chipperfield & Butler	5	-
Clark, J.	5	-
Cockburn, W. H.	10	6

	£.	s.	d.
Coleman, J.	5	-	-
Collver, Mrs.	5	-	-
Cooper, The Rev. W. Selbert, M.A. .	5	-	-
Copestake, S.	1	1	-
Coppleston, Mrs.	5	-	-
Costa, I. de.	5	-	-
Cox, Alderman A.H., J.P.	1	1	-
Crunden, Frederick. .	10	6	
Dover, Geo. F.	5	-	
Druce, Mrs.	5	-	
Drew, F.	10	-	
Duncombe, Geo.	5	-	
E. C. C.	5	-	
Edwards, Mrs. Samuel Elliott & Sons.	10	6	
Evershed, J. & Sons	5	-	
Ewart, Sir Joseph, J.P.	10	6	
Fair, James.	5	-	
Farmlooe, S. E.	5	-	
Findlater, Mackie & Todd.	5	-	
Foster & Sons, M. B. .	5	-	
Fraser, A.	5	-	
Fry, R. & Co.	5	-	
Gem, Col.	5	-	
G. M. S. Mrs.	5	-	
Goob, Lady.	5	-	
Goob, Thomas.	5	-	
Hammond, G. H.	5	-	
Hannington's, Ltd. .	1	1	
Hansard, Mrs.	5	-	
Hawley, Sir H.	5	-	
Hind, E.	10	-	
Hockley, Henry.	5	-	
Jones, Mrs. Stewart. .	5	-	
Kidd & Hotblack. .	10	6	
Knipe, H. R.	10	-	
Langton, A.	5	-	
Larkin, S., Collected by.	6	10	
Lawrence, Sir Wm. .	1	-	
Letchworth, Thomas	5	-	
Lever Brothers.	5	-	
Levett & Brown.	5	-	
Littell, Mrs.	5	-	
Lockyer, George.	5	-	
Loder, Gerald W., Erskine, Esq. M.P., J.P.	1	1	
Lloyds Bank.	10	-	
London and County Bank, per J. A. Strachan.	1	1	
Lyon & Hall.	10	6	
Mace, Mrs.	5	-	
Mace, Mrs. W. R. .	5	-	
M. A. W., Mrs.	1	-	
Marshall, Charles. .	1	1	
Mason, G.	1	1	
Mason, T. F.	1	1	
Matthews.	5	-	
Mees, E.	5	-	
Montenuis, A.	10	-	
Moodie, Miss.	5	-	
Mountain, Mrs.	5	-	
Munster, The Earl of	5	-	
Murray, Mrs.	10	-	
Napper, Mrs. T.	10	-	
Newton, Mrs.	5	-	
Nile, J. M.	5	-	
Northen, Mrs.	5	-	
Pain, Rev. P.	5	-	
Parry, Mrs. F.	10	-	
Parsons & Sons.	5	-	
Patman, J. P.	5	-	
Paton, Mrs.	10	-	
Peyton, John E. H. .	1	-	
Pilcher, Mrs. J. G. .	10	-	
Pocock, Sir Geo., Bart. .	5	-	
Potts, R. & Co.	10	6	
Ramford, Mrs. Frank	5	-	
Repton, Mrs. J. Hall	5	-	
Ridding, The Misses	1	-	
Robertson, Lt.-Col. .	5	-	
Robins, E. & Sons, per J. K.	5	-	
Robins, Mrs. E. W. .	5	-	
Royce, Mrs.	5	-	

ANNUAL SUBSCRIPTIONS AND DONATIONS TO BRANCHES.

£.	s.	d.	£.	s.	d.
Russell, G.	5	-	De Bathe, General	2	-
S. W.	10	-	Sir H. P. Bart.	1	-
Sandeman, Mrs.	5	-	Drewitt, Mrs.	1	-
Sandeman, Mrs. T. F.	5	-	Edgell, Mrs.	10	-
Sandeman, A.	5	-	Fletcher, Mrs. (Bog	5	-
Sassoon, A. D.	5	-	nor)	2	-
Sassoon, Mrs. Keuben	5	-	Fletcher, Mr. C. J.	5	-
	5	-	Foster, Mr. R.	5	-
Sebillig, H. & Co.	5	-	Frampton, Rev. Pre-	1	-
Simmonds, H. & G.	5	-	bendary	1	-
Singer, Mrs. A. M.	1	-	Gaisford, Rev. G.	5	-
Skelton, J.	5	-	Garnham, Lt-Colonel	1	1
Soper, S. H.	5	-	Gibbings, Mrs.	5	-
Smith, Arthur	5	-	Gorham, Mr. J.	10	-
Smith, O.	5	-	Greene, R. T.	5	-
Smithers and Sons,	5	-	Gruggen, Mr. F. W.	5	-
Messrs.	5	-	Haines, Mr. W. T. S.	5	-
Stamp, W. E. B.	5	-	Halsted, Mrs. C. T.	5	-
Stewart, Alex. J. R.	5	-	Hanson, Mr. E.	5	-
Stratton	1	-	Heington, Mr. E.	5	-
Sutton & Evershed.	5	-	Hobgen, F. N.	5	-
Templin & Sons.	1	1	Hutchinson, Rev. C. H.	5	-
Tebb, Mrs.	5	-	Kent, Miss.	5	-
Tonides, C. A.	5	-	Knight, Mr. C. R. B.	5	-
Tooth, John.	5	-	Landgale, Rev. G. A.	5	-
Trist, J. & Son.	5	-	Leconfield, Lord	1	1
Trist, Miss	5	-	Legge, Mr. C. E.	5	-
Truord, S.	5	-	Lewis, Rev. H. C.	5	-
Turnbull, G. D.	5	-	Matthews, Miss	5	-
	5	-	Norman, Mr. W.	1	-
Turner, Col.	5	-	Paxton, Colonel	10	-
Vahl, A. de.	5	-	Pearson, Rev. G. F.	5	-
	5	-	Raper, Sir Robert	5	-
Vallance, Catt & Co.	1	1	Riadore, Rev. G. J. E.	10	6
Vale, Miss.	5	-	Richmond & Gordon,	2	2
Wallace, Lady.	1	-	The Duke of, K.G.	5	-
Wallis, Holder and	1	-	Sadler, Mr. H.	5	-
Lee	1	1	Sutton, Rev. Archdn.	10	-
Welse, Mrs. J.	10	-	Teedale, C. L. M.	5	-
Welsford, H. N.	5	-	Turing, Lady	1	-
Wentworth, B. C.	1	-	Weller-Poley, Mrs.	10	-
Vernon, Esq., M.P.	1	1	Wellesley, Lady V.,	3	3
Wilkinson, Son and	10	6	the late.	3	3
Welch	10	6	Woodbridge, Mr. G.	5	-
Winter, J. N.	5	-	Woods, Mr. John W.	10	-
Wood, W. & Sons.	5	-	Sums under 5s.	5	-
Woodhead, Major.	5	-			
Woolley & Bevis	5	-			
Total	£69	1 4	Total Subs.	£28	14 6

Donation.

Henty, Mrs.	5	-
Total	£33	14 6

EASTBOURNE BRANCH.

President—
His Grace the DUKE OF DEVONSHIRE, K.G.

Local Committee—
Rev. H. BICKERSTETH
ORTLEY, Chairman.

- Capt. BACON.
- Rev. W. A. BATHURST.
- Lt. A. W. BECKETT.
- Mr. THOS. BENNET.
- J. H. C. COLES, Esq.
- R. COLGATE, Esq.
- Mr. H. CROOK.
- H. DURLACHER, Esq.
- Mr. H. M. EMART.
- Mr. H. W. EVENDEN.
- J. FARNCOMBE, Esq.
- H. WEST FOYARGUE, Esq., Town Clerk.
- Mr. R. M. GLOYNE, Boro' Surveyor.
- Mr. Alderman C. H. HAINB.
- R. INSOLL, Esq.
- R. C. LAMBERT, Esq., J.P.
- Mr. JAMES MORRIS.
- Mr. H. FLUMB, Chief Constable.
- Mr. Alderman J. RUDD.
- Mr. GEO. SAWDIE.
- Mr. JNO. W. SDEWICK,
- Chief Officer of H. M. Coastguard.

CHICHESTER.

President—
The Right Rev. the LORD BISHOP OF CHICHESTER.

Chairman—
General Sir HENRY P. DE BATHE, Bart.

Honorary Secretary—
Sir ROBERT RAPER, Kt.

Treasurers—
Messrs. MILBANKE, WOODBRIDGE & Co.

Annual Subscriptions.

Adames, Miss E.	1	1
Arnold, E. Esq.	10	-
Bennett, Rev. Pre-	5	-
bendary	5	-
Beverly, Rev. H. W.	5	-
Buckell, Dr. L.	5	-
Christy, Mrs. R.	10	-
Cogan, Mr. T. S.	5	-
Davey, Rev. H. M.	5	-
Deedes, Miss	10	-
Total Dons	£138	19 9
Total Subs.	69	1 4
Total	£208	1 1

£.	s.	d.	£.	s.	d.
Mr. Alderman SKINNER,			Pearce, Mrs. M. S.		
Mayor of Eastbourne.			Plummer & Lawford,		
Rear Admiral J. E. STOKES.			Messrs.		
Mr. Alderman H. SUTTON.			Queen's Hotel Co.	7	6
Mr. C. TOMES.			Roberts, Col. T. W.		
W. L. WALLIS, Esq.			Roberts, Dr.		
Dr. E. WILLET.			Roberts, Mrs. (Rook-		
			hurst)		
Treasurer—			Rodwell, E. Esq., Q.C.		
Major H. P. MOLINEUX.			Roper, F. C. S. Esq.,		
			the late.	1	1
Honorary Secretary—			Rudd, Mr. Alderman		
			Salway, Rev. H.		
Collector—			Sampson, Mrs. King	5	-
Mr. J. CRISP.			Schreiner, Fredk. Esq.		
Annual Subscriptions.			Scott, Mrs. James	5	-
			Scott, Mrs. Mary		
			Scott, Rev. H. Von E.		
Ackermann, Miss A.			Sherwood, Dr. A. P.	5	-
P.			Shorthland, Rev. H. V.	5	-
Atkins, Mrs. de			Skinner, Mr. Alderman		
Courcy			man, Mayor of		
Bacon, Capt.			Eastbourne	10	6
Batho, Mrs.			Skinner, Mrs.		
Bathurst, Rev. W. A.	5	-	Mayoress.	10	6
Bennett, Mr. Thos.	10	6	Soddy, B. Esq.		
Bindon, Mr. S.			Steadman, Miss M.R.		
Blackburn, H.B. Esq.	10	-	Strange & Atkinson,		
Blackden, W.H. Esq.	1	-	Messrs.	5	-
Boulton, Mrs.	10	-	Sutton, Mr. Thos.		
Bradley, Miss.			Sutton, Mr. T. jun.		
Brown, G. & Co.			Sutton, Mr. Alderman		
Browne, Mr. H. R.	5	-	H.	10	-
Bruford and Son,			Swift, Miss	1	1
Messrs.	5	-	Thomas The Hon.		
Cardwell, W. A. Esq.	1	-	Mrs. (Ratton)		
Childell, J. Esq.			Toms, Mr. S. R.		
Cholditch, J. & Co.			Towner, Mr. J. C.	5	-
Coles, J. H. C. Esq.	10	-	Tudor, Rev. O. L.		
Colgate, R. Esq.	10	-	Twells, Mrs.	10	-
Crampton, Dr. H.			Wallis, W. L. Esq.	1	1
Crook, Mr. H.	10	-	Watkins, B. Fox, Esq.	5	-
Dale & Kerley,			Whelpton, Rev. H.R.	10	-
Messrs.			Willet, Mrs.	1	1
Devonshire, His Grace			Winter, Miss		
the Duke of.	1	1	Wragge, Mrs.	5	-
Dicker & Co., Messrs.			Wrangham, A. B.		
Durlacher, H. Esq.	1	1	Esq.	1	-
Earnshaw, Mr. B. K.	5	-	Young and Bawley,		
Edwards, James, Esq.	10	-	Messrs.	10	6
Ellis, John, Esq.	10	-	Sums under 5s.	2	6
Emary, H. M.	5	-			
Evenden, Mr. H. W.	10	6	Total	£27	11 -
Foran, J. C. Esq.					
Garratt, S. Esq.	5	-	Donations.		
Gilbert, C. D. Esq.	1	1	Bindon, Mr. S.	5	-
Gloyne, Mr. H. M.			Cass, Col. A. H.	1	1
Boro' Surveyor.	10	6	Collecting Boxes	15	17
Grand Hotel Co.	5	-	Hood, A. Esq.	5	-
Green, Rev. G. B.			Jones, R. Hesketh,	1	1
Gregg, Mrs.			Esq.	1	1
Habgood, Dr. H.	5	-	"Life-boat Saturday"		
Haine, Mr. Alder-			Collection and		
man C. H.			Ladies Auxiliary	121	9 5
Heasman, Miss E.			Rutland House Col-		
Hollins, F. Esq.	5	-	lecting Box—		
Hood, A. Esq.			Lack, Mr.	5	8
Hood, Mrs. W. J.	10	-	St. Mary's Church		
Hooper, Horace B.			Collection	1	10 6
Esq.			Sums under 5s.	19	2
Insoll, R. Esq.					
Jameson, Rev. H. G.			Total Dons.	£147	16 11
Keay, Mr. Alderman	5	-	Total Subs.	27	11 -
Langham, J. G. Esq.	10	-			
Leaf, The Misses			£175	7 11	
Lee, Miss	5	-			
Lethbridge, Mr. G.					
Executors of.	5	-			
Lewes Old Bank	10	-			
London and County					
Bank	1	1			
Maitland, J. A. Esq.					
Manby, Mrs.	10	-			
Mann, Mr. W. C.					
McQueen, Dr. T.	5	-			
Moore, Mrs. R. W.					
Morris, Mr. James	5	-			
Morris & Son, Messrs.	5	-			
Mullen, Haskings &					
Co.	5	-			
Oliver, Mrs.					
Palmer, Rev. J. H.					
Paulin, J. Esq.					

HASTINGS AND ST. LEONARDS BRANCH.

Local Committee—
Rev. J. W. TOTTENHAM, M.A., President.
Hon. T. ALLNUTT BRASSEY, J.P., Vice-President.
His Worship THE MAYOR OF HASTINGS.
H. M. BAKER, Esq., J.P.

Chief Constable CHAS. F. BAKER.	
C. PEMBERTON CARTER, Esq., J.P.	
E. CHALINDER, Esq.	
W. VANDELEUR CRAKE, Esq., M.A.	
Commander H. B. ELWYN, R.N.	
Mr. R. WHITE FORD.	
Rev. H. BRERETON FOYSTER, M.A.	
Rev. G. ALFRED FOYSTER, M.A.	
F. G. HAVILAND, Esq.	
A. VALMONTINE HOLLAND, Esq. Councillor	
JOSHUA HUGGETT, J.P.	
Hon. Capt. NEEDHAM, R.N.	
PHILIP PRITCHARD, Esq. Councillor	
Major - General SHERRER.	
WILLIAM STUBBS, Esq., J.P.	
STIVERS T. P. VORES, Esq., J.P.	
H. BARLOW WEBB, Esq.	
Treasurer—	
ANDREW MURRAY, Esq.	
Auditor—	
Councillor JOSHUA HUGGETT, J.P.	
Secretary—	
Councillor HUTCHINGS.	

Annual Subscriptions.	
	£. s. d.
Adey, Mrs.	5 3
Arkooll, J. Esq.	10 6
Back, Miss.	10 6
Bealey, Dr.	5 -
Beaumont, Mrs.	10 6
Brassey, Hon. T. A. 5 -	-
Brassey Lord, K.C.B. -	10 6
Brisco, Miss.	10 6
Burton, A. H. Esq.	10 6
Campbell, Miss.	5 -
Carter, C. P. Esq.	10 6
Christian, Mrs.	5 -
Convent, The.	5 -
Crake, W. V. Esq.	5 3
Dawson, Mrs.	10 6
Field, Miss.	10 -
Forster, A. Esq.	10 6
Ginner & Son, Messrs. (2 years)	5 -
Hastings Pier Company.	1 1 -
Haviland, F. G. Esq.	10 6
Holland, A. V. Esq.	10 6
Howell, John, Esq.	5 3
Hume, Miss.	5 -
Hutchings, Mrs. Lewis.	5 -
Kaye-Smith, Dr.	10 6
King, Miss.	5 -
Laming, Mrs.	5 -
Leigh, Lady.	10 -
Lloyd's Bank.	5 3
Lowther, Mrs.	10 6
Macbraire, Mrs.	5 -
Mitchell, C. M. Esq.	10 6
Moore, Capt., G.H., R.N.	10 6
Murray, Andrew, Esq.	5 3
Ponthien, Madame de Vismes de.	5 -
Ross, Mrs.	5 -
Ryle, W. F. D. Esq.	10 -
Sayer-Milward, Rev. W. C.	5 -
Scholfield, Rev. C. R.	5 3
Scrivens, S. Esq.	5 -
Sherer, Maj.-Gen.	5 -
Shorter, W. Esq.	10 6
Stanford, George, Esq.	5 -
Stephens, Mrs.	10 -
Stubbs, Wm. Esq.	5 -
Sutton, Rev. R. S.	10 -

Tottenham, Rev. J. W.	10 6
Tree, B. H. W. Esq.	10 6
Vores, S. T. P. Esq.	10 6
Webb, H. Barlow, Esq.	10 6
Weston, Major S. T.	5 -
Willoughby, Miss.	10 -
Young, W. B. Esq.	10 6
Sums under 5s.	9 17 6
Total.	£36 - 6

Donations.	
Corporation of Hastings.	10 - -
Collected on "Life-boat Sunday"	42 11 8
Boxes—	
West Marina, Victoria Library, Warrior Square, White Rock, Carlisle Parade, Marine Parade, Boat-House.	31 - 6
Total Dons.	83 12 2
Total Subs.	£119 12 8

LITTLEHAMPTON BRANCH.

Local Committee—	
Capt. E. H. HILLS, R.N., J.P. Chairman.	
UPPERTON LEAR, Esq. Capt. LEFROY, R.N. GEORGE NEAME, Esq. CHARLES POLAND, Esq. Mr. W. SEWELL, Harbour Master.	
Mr. A. SHELLEY.	
Hon. Secretary and Collector—	
Mr. W. AULD.	
Hon. Collector for Arundel—	
Mr. CHARLES R. JEFF.	
Annual Subscriptions.	
Butt, Mr. John.	10 -
Butt, Messrs. J. E. & Sons.	10 -
Candy, Rev. J. H.	5 -
Constable, Mr. A. J. 1 -	-
De Graves, Mr. H.	5 -
Dixon, Mr. Fredk.	5 -
Fetherston, Rev. Sir G. R., Bart.	5 -
Fletcher, Col. Sir Henry, Bart., M.P. -	10 -
Harvey, Messrs. J. and W. B.	10 -
R.N., J.P.	5 -
Kemp, Mrs. William 1 -	-
Lear, Mr. and Mrs.	5 -
Lefroy, Capt., R.N.	5 -
Neame, Mr. N.	5 -
Parkin, Vice-Admiral -	10 -
Parry, Dr.	10 -
Poland, Mr. Charles -	5 -
Robinson, Mr. Jos. -	5 -
School House, per Mr. Cooper.	5 -
Senior, Mr. J.	1 1 -
Stansfield, Rev. E.	5 -
Talbot, Lord Edmund, M.P.	1 1 -
Warren, Mr. R. A., J.P.	1 1 -
Whitehead, Mr. John -	5 -
Sums under 5s.	3 12 6
Total.	£15 1 6

Donations.	
Life-boat Sta. Boxes. 4 9 1	
Railway Sta. Box .. - 8 -	
Terminus Hotel - 5 -	
Total.	£5 2 1

ARUNDEL.

Annual Subscriptions.	
Elliott, Mr. Wm.	5 -
Holmes, Mr. Carleton -	5 -
Lambert & Norris. 1 1 -	-
Middleton, Major A. T.	10 -
Mitchell, Mrs. F.	10 -
Moor, Rev. G. H.	5 -
Mostyn, Mr. E. J.	5 -
Norfolk, His Grace The Duke of, E.M., K.G.	5 -
Rolls, Mr. A. G.	10 -
Sums under 5s.	1 6 -
Total.	£9 17 -

Donations.

Box at Norfolk Hotel -	12 8
Total.	£10 9 8
Total Subs.	£24 18 6
Total Dons.	£5 14 9
Total.	£30 13 3

NEWHAVEN BRANCH.

Local Committee—	
W. L. MASSY, Esq., Chairman.	
J. H. BULL, Esq. Major L. T. CROOK. Captain H. M. LAMBERT. Capt. H. N. LEWIS. Capt. E. SHARP. F. S. SHENSTONE, Esq., J. P. R. TOWNER, Esq. Capt. R. G. WHITE. Mr. W. P. WOOLLEY, Chief Officer Coastguard. Capt. J. MORRIS.	
Honorary Secretary—	
J. W. NOEL, Esq.	
Collector—	
Mr. EDWARD KNIGHTLEY.	

Annual Subscriptions.	
Bannister, J. Esq.	10 6
Barrett, H. Esq.	5 -
Blaauw, Mrs.	10 -
Blencowe, J. G. Esq. 1 -	-
Bull, J. Esq.	10 6
Catt, Messrs. J.	1 1 -
Christie, W. L. Esq. J.P.	1 - -
Clarke, Gen., C.B.	10 6
Cook & Sons, Thos. Messrs.	2 2 -
Crook, L. T. Esq.	10 6
Eastwood, Mrs. W.	5 -
Ellington, C. T. Esq. -	10 6
Every, J. Esq.	5 -
Farncombe, Miss S. -	10 6
Gage, Viscount.	2 - -
Godlee, Mrs. M. A.	10 -
Gosling, W. Esq.	5 -
Hale, Capt. H. M.	5 -
Holland, Mrs. H.	1 1 -
Lamb, R. Esq.	5 -
Lewis and Holman, Messrs.	10 6
Lowdell & Co., Messrs. -	10 -
Madgwick & Adams, Messrs.	5 -

Molinueux & Co., Messrs.	1 1 -
Monk & Sons, Messrs. -	10 6
Morgan, Dr. W. P.	5 -
Mossop, Dr. A. S.	5 -
Newhaven Harbour Company.	5 - -
Newington and Co., Messrs.	10 -
Pannett, W. & Co.	10 6
Parsons Bros., Messrs. -	10 -
Russell & Sons, Messrs.	5 -
St. John, Hunt & Co. -	10 6
Savage, F. W. Esq.	5 -
Sharp, Capt. R.	5 -
Sheffield, Earl of.	2 - -
Shenstone, F. S. Esq. 1 1 -	-
Simmons, H. Esq.	10 6
Simmons, Mrs. T. J. -	10 -
Smith, J. Maxwell, Esq.	1 1 -
Southwood, Rev. E. P.	5 -
Towner, E. Esq.	10 6
Streetfield, R. J. Esq. 1 -	-
Strickland Bros., Messrs.	10 6
Vallance, Catt & Co., Messrs.	1 1 -
Verrall, F.	10 6
Vinall, J. Esq.	5 -
White, Capt. R. G.	5 -
Willett, G. W. Esq. 1 1 -	-
Total.	£35 11 -

Donations.

Collected on Bank Holiday, Newhaven Regatta ...	3 3 6
Contribution Boxes—	
Bay Hotel Box.	7 -
J. H. Bull.	3 5 9
Mrs. Allan Cooper -	18 9
Willy Jacobi, Esq. (Donation)	5 -
Life-boat House.	11 2
Newhaven Pillar Box.	5 9
Seaford Pillar Box -	12 10
Steamboats, &c.	3 12 -
Boxes under 5s.	3 8
Total Dons.	£13 3 8
Total Subs.	£35 11 -
Total.	£48 14 8

RYE AND WINCHELSEA BRANCH.

President—	
T. S. PIX, Esq.	
Local Committee—	
Mr. F. BELLINGHAM. Mr. WALTER DAWES. Mr. WILLIAM DAWES. Mr. JNO. HOLMES. Mr. THOS. JOHNSTONE. Mr. F. MARTYN. Mr. W. G. RUBIE. Mr. T. G. SHARPE. Major STILEMAN.	
Honorary Secretary—	
J. SYMONDS VIDLER, Esq.	
Annual Subscriptions.	
Brocket, Mrs.	1 1 -
Churton, Rev. T. T. -	10 6
Dawes, Mr. Walter.	5 -
Dawes, Mr. Wm.	10 -
Hilder, Mr. G.	1 -
Inderwick, Mr. F. A. 1 1 -	-

ANNUAL SUBSCRIPTIONS AND DONATIONS TO BRANCHES.

Pix, T. S. Esq.	£. s. d.
Stileman, Major	2 - -
Stileman, Miss	1 - -
Stileman, Miss	10 6
Total Subs.	£7 19 -
Donations.	
Contribution Boxes. -	3 8
Total	£8 2 8

SELSEY BRANCH.

Local Committee—
 NEWTON CLAYTON, Esq.,
 Chairman.
 Mr. W. GORMAN (Officer of
 H.M. C.G.)
 Mr. D. HEMBROKE (Officer
 of H.M. C.G.)
 HUGH PENFOLD, Esq.
 Mr. H. A. SMITH.
 Rev. Dr. STORRS.

Hon. Secretary—
 FRANK R. LEITH, Esq.

Annual Subscriptions.

Clayton, N., Esq.	1 1 -
Leith, Frank R., Esq. 1 1 -	
Donations.	
Contribution Boxes. -	6 8
Total	£2 8 8

SHOREHAM BRANCH.

Local Committee—
 HENRY HEAD, Esq., J.P.,
 Chairman.
 J. E. BROWN, Esq.
 Mr. T. DESMOND, Chief Officer
 Coastguard, Southwick.
 Dr. FULLER.
 Mr. C. MURPHY, Chief Officer
 Coastguard, Shoreham.
 Capt. W. SWALES.

Treasurer and Honorary
 Collector—
 ARTHUR R. DAWSON, Esq.,
 Supt. H.M. Customs.

Honorary Secretary—
 HAROLD BROWN, Esq.

Annual Subscriptions.

Ayling, Mr. H.	- 5 -
Banfield, Messrs. and Co.	1 1 -
Beves and Co.	1 1 -
Brighton & Worthing Steam-boat Co., Ltd.	1 1 -
Brooker, Mr. H. W. -	5 -
Brown, J. E. Esq.	10 6
Capital & Counties Bank, Ltd., per Jas. White, Esq.	1 1 -
Dawson, A. R.	- 5 -
Fuller, Thos. Esq.	1 1 -
Harker, W. H. Esq. 1 1 -	
Head, Henry, Esq.	2 2 -
Ingram, Colonel, J. P. 2 2 -	
Kempe, C. M. Esq.	10 6
Michell, Messrs. G. & H.	- 10 -
Penney, R. H. Esq. 1 1 -	
Rubie & Adams, Messrs.	1 1 -

Smith, F. Sundius, Esq.	1 1 -
Stow & Son, Messrs. -	10 -
Tower, Rev. C.	- 5 -
West Street Brewery Co., Ltd.	1 - -
Whitmill, Mr. C. J. -	5 -
Willett, G. W. Esq. 1 1 -	
Wood, F.	- 10 -
Total	£18 19 6

Donations.

Collected by Mr. Dawson at Custom House	1 10 10
Collected by Chief Officer Murphy, Shoreham Coast- guard	4 16 9
Total Dons.	6 7 7
Total Subs.	£25 7 1

WORTHING BRANCH.

President—
 THE RIGHT HON. LORD
 HENRY THYNNE.

Local Committee—
 H. HARGOOD, Esq., J.P.,
 Chairman.
 A. H. COLLET, Esq.
 A. CORTIS, Esq.
 CHIEF OFFICER OF COAST-
 GUARD.
 W. H. B. FLETCHER, Esq.
 Capt. A. B. S. FRASER,
 J.P.
 M. GREEN, Esq.
 G. A. RALLI, Esq.
 A. A. RALLI, Esq.
 Capt. SMITH HERIZ, R.N.
 C. L. M. TRESDALE, Esq.,
 J.P.

Treasurer—
 J. ROBERTS, Esq.

Honorary Secretary—
 GEORGE PIGGOTT, Esq.

Annual Subscriptions.

Adams, T. Esq.	- 5 -
Anon.	1 1 -
Archer, C. Esq.	- 5 -
Archer, T. Esq.	- 5 -
Armitage, W. S. Esq. -	10 6
Attree, A. A. T. Esq. -	5 -
Atwood, Mr.	- 5 -
Atwood, Mrs. J.	- 5 -
Bennett, E. W. Esq. -	10 6
Bentall, Mr. C.	- 5 -
Beynon, Mrs. Crow- ther.	- 5 -
Blaker, Mr. F.	- 5 -
Boyes, W. O. Esq. 1 1 -	
Brunet, Madame	- 5 -
Burnand, L. Esq.	1 1 -
Byrange, P. Esq.	- 5 -
C. B.	- 5 -
Cameron, Pryce N. Esq.	- 10 -
Cass, Rev. F. C., the late	- 10 -
Chapman, H. Esq.	- 5 -
Chartars, Mrs.	1 1 -
Chetwynd, Hon. Mrs. 1 -	
Chretien, F. F. Esq. -	5 -
Clark, H. M. Esq.	- 5 -
Clarke, Mrs. E. B. ...	- 5 -
Collet, A. Esq.	- 5 -
Collet, G. B. Esq.	- 10 -

Coombe, Rev. C. G. ...	- 5 -
Corns, T. Esq.	- 10 -
Cortis, A. Esq.	- 10 -
Coster, C. W. Esq. ...	10 6
Cox, Mr. J.	- 5 -
Crewe, Miss	- 5 -
Crick & Matthews. ...	10 6
Cripps, Mr. F.	- 5 -
Crook, J. Esq.	- 10 -
Dale, Surg-General. -	5 -
Digby, Mrs.	- 5 -
Dixon, Miss.	- 5 -
Drewitt, Miss.	- 5 -
Eckett, Mrs.	- 5 -
Ede, Miss.	- 5 -
Elliott, Rev. E. K. ...	10 -
Etherton, Mr. G. R. ...	- 5 -
F. G. A. T.	- 5 -
Farncombe, Mr. J. ...	- 5 -
Fickus, W. Esq.	1 1 -
Fletcher, W. H. B. Esq.	1 1 -
Fras J., Capt. A. B. S. J.P.	10 6
Fraser, Major C.	- 5 -
G. P. S.	- 5 -
Gaisford, T. Esq.	1 1 -
Gardner, H. H. Esq. ...	- 5 -
Gates, F. C. Esq.	- 5 -
Godman, Gen.	10 6
Gostling, Dr.	- 5 -
Graham, T. G. Esq. ...	- 10 -
Gray, A. Esq.	- 5 -
Green, F. Esq.	- 5 -
Green, M. Esq.	10 6
Grevett, Mr. R.	- 5 -
Hackett, Major Gen. ...	- 10 -
Hagger, J. H. Esq.	10 6
Hall, R. Esq.	- 5 -
Hampson, J. T. Esq. ...	- 5 -
Hargood, H. Esq., J.P.	1 1 -
Harrison, E. Esq.	- 5 -
Harrison, Miss.	- 5 -
Hatherton, Dowager Lady	1 1 -
Haynes, Rev. C. C. ...	- 5 -
Haywood, J. Esq.	- 5 -
Henty, A. Esq., J.P. ...	10 6
Henty, Mrs.	1 1 -
Herepath, H.H. Esq. ...	- 5 -
Herez, Capt. R. N. 1 1 -	
H rez, Mrs. Smith. ...	- 5 -
Herrick, Major H. B. 1 -	
Hinds, Dr.	- 5 -
Hine, Mr. J. H.	- 5 -
Hoare, Miss.	2 - -
Hole, Mrs.	- 5 -
Hole, Rev. C.	- 5 -
Hooft, M. W. Esq.	- 5 -
Hooton, Mrs.	- 5 -
Hooper, F. A. Esq.	- 5 -
Irving, Miss.	- 5 -
Joad, Mrs.	1 1 -
Kenworthy, M. Esq. ...	10 -
Kinsman, J. Esq.	- 5 -
Knowles, Mr. J. B. ...	- 5 -
Lancaster, Mrs.	10 -
Lane, Mrs. H.	- 5 -
Lepherd, E. Esq.	- 5 -
Le Riche, Dr.	- 5 -
Loder, Lady.	1 1 -
London and County Bank.	- 5 -
Longbottom, Mrs. ...	1 1 -
Lorimer, Miss.	- 5 -
Macgregor, Mrs.	- 5 -
Meager, Mr.	- 5 -
Merriman, J. J. Esq. 1 -	
Mitchell, Mrs.	- 5 -
Moore, Com. R.N.	- 5 -
Moss, Mrs.	- 5 -
Mordan, A. Esq.	1 1 -
Murray, Genl.	- 5 -
Nash, J. E. Esq.	1 1 -
Naylor, Miss.	- 5 -
Newsam, S. W. Esq. ...	- 5 -
Nicholls, Mrs.	- 5 -
Nicholls, R. T. Esq. -	10 6
Nisbet, J. Esq.	- 5 -
Nodes, J. W. S. Esq. -	10 6
North, F. Esq.	- 5 -

North, T. E. q.	- 5 -
Norris, J. Esq.	- 10 -
Opie, Dr.	- 5 -
Oriel, Misses.	- 6 -
Paglen, Mrs.	10 6
Page, Mrs.	- 5 -
Parish, F. Esq.	- 5 -
Parr, Rev. J. O.	- 5 -
Patching, E. C. Esq. -	10 6
Patching, W. Esq. ...	10 6
Payne, Mrs.	- 5 -
Perkins, W. M. Esq. ...	- 5 -
Piggott, G. Esq.	10 6
Piper, R. Esq.	10 6
Potter & Bailey, Messrs.	- 5 -
Pretty, R. M. Esq.	- 5 -
Prickett, Mrs.	1 - -
Raffety, J. H. Esq. 1 1 -	
Ralli, A. A. Esq.	1 1 -
Ralli, G. A. Esq. 1 1 -	
Reynolds, Rev. R.H. (the late)	- 5 -
Roberts, J. Esq.	1 1 -
Routledge, Miss.	- 5 -
Rumford, Mrs.	- 5 -
Sandford, E. G. Esq. -	10 -
Sanders, W. Esq.	- 5 -
Saunders, G. T. Esq. -	10 -
Scorrier, Mrs.	- 10 -
Scott, Mrs. H. C.	- 5 -
Shotton, R. Esq.	10 6
Simpson, Com. R.N. 1 1 -	
Simpson, G. B. Esq. ...	- 5 -
Simpson, W. S. Esq. -	10 6
Smart, Mrs.	- 10 6
Smith Bishopp, E. P. Esq.	- 10 -
Smith, Gen. Lucie. ...	- 10 -
Smith, Mr. E. A.	10 6
Smith, Mr. G. E.	- 5 -
Springett, Rev. Dr. ...	- 5 -
Stephens, Mrs.	- 5 -
Stocker, Miss.	- 5 -
Strong, Dr.	1 1 -
Taswell, Mrs.	1 1 -
Teesdale, C. L. Esq. 1 1 -	
Thistleton, C.W. Esq. -	5 -
Thornton, E. Esq.	1 1 -
Thrupp, R. W. Esq. ...	10 6
Tottenham, Mrs.	- 10 -
Treadwell, Mrs.	- 5 -
Tribe, Mrs.	- 5 -
Underwood, Capt., R.N.	- 5 -
Vansittart, Vice-Ad- miral	2 2 -
Verrall, W. Esq.	- 5 -
Verrall, W. F. Esq. ...	- 5 -
Walter Bros.	- 5 -
Warleigh, Command. -	5 -
Way, Colonel.	- 5 -
Wedd, G. Esq.	1 1 -
Widen, Lt.-Colonel. 1 -	
Wood, Major	- 5 -
Worthing Pier Co. ...	1 1 -
Wright, J. Esq.	- 5 -
Wyatt, H. R. P. Esq. -	10 6
Young, A. Esq.	1 1 -
Sums under 5s.	18 2 -
Total	£103 1 -

Donations.

Collection Boxes ...	8 3 7
Cornish, Mrs.	1 16 -
Pier Collection.	1 11 10
Total Dons.	11 11 5
Total Subs.	£114 12 6

Warwickshire.

ACOCKS GREEN, YARDLEY, AND OLTON BRANCH.

(No Local Committee.)

Treasurer and
Honorary Secretary—
Rev. A. BUTLER, LL.D.

Annual Subscriptions.

ACOCKS GREEN.
Per Miss HIRSCH.

	£.	s.	d.
Ash, Mr. A. J.	5	-	-
Ash, Mrs. A. J.	5	-	-
Ash, Mrs. E. J.	5	-	-
Ash, Mrs. T. H.	5	-	-
Barker, Mr. T. B.	5	-	-
Barratt, Mr.	5	-	-
Bentley, Mr.	5	-	-
Bentley, Mr. T. B.	5	-	-
Bradford, Mrs.	5	-	-
Crane, Mrs.	5	-	-
Fordred, Messrs.	7	6	-
Grice, Mrs. H.	5	-	-
Hill, Mrs.	5	-	-
Hirsch, Mr.	5	-	-
Hitchman, Mrs.	5	-	-
Horton, Mr.	5	-	-
Hoskins, Mrs. W.	5	-	-
King, Mrs. James.	5	-	-
King, Mr. S. T.	5	-	-
King, Mrs. S. T.	5	-	-
Louis, Mrs.	5	-	-
McClelland, Mrs.	5	-	-
Mellor, Mr.	10	-	-
Muscott, Mr. H.	5	-	-
Neale, Mrs.	5	-	-
Newey, Mrs.	5	-	-
Onions, Mrs.	5	-	-
Parsons, Mrs. C.	5	-	-
Patterson, Mrs. W. E.	5	-	-
Patison, Mr.	5	-	-
Pinnell, Mrs.	5	-	-
Playfair, Mr. J. P.	5	-	-
Price, Mrs.	5	-	-
Richards, Mr. J. H.	5	-	-
Robinson, Mrs.	5	-	-
Robinson, Mr. W. F.	5	-	-
Ryland, Mrs.	5	-	-
Taylor, Miss.	5	-	-
Taylor, Mr. J.	5	-	-
Vencur, Mr.	5	-	-
Walker, Mr. Z.	5	-	-
Ward, Mrs.	5	-	-
Wheldon, Mrs.	5	-	-
Wright-Wilson, Mrs.	5	-	-
Yardley, The Misses	5	-	-
Sums under 5s.	1	17	6
	£13	10	-

YARDLEY.

Per Mrs. HOSKINS and
Mrs. MELLOR.

Ash, Mrs.	5	-	-
Baxter, Mrs.	5	-	-
Boosey, Mrs.	10	-	-
Dimmock, Mrs.	5	-	-
Dodd, Rev. F. S.	5	-	-
Fisher, Mr.	5	-	-
Fisher, Mrs.	5	-	-
Gilman, Miss	5	-	-
Hackett, Mr.	5	-	-
Hedges, Mrs.	5	-	-
Holloway, Mr.	5	-	-

	£.	s.	d.
Hoskins, Mr. J. E.	5	-	-
Hoskins, Mrs. J. E.	5	-	-
Mellor, The Misses	5	-	-
Mellor, Mr. J. F.	5	-	-
Mellor, Mrs. J. F.	5	-	-
Muscott, Mrs.	5	-	-
Pollock, Mrs.	5	-	-
Rowlands, Mrs.	5	-	-
Shakespeare, Mrs.	5	-	-
Summer, Mrs.	5	-	-
Thornley, Mrs. S.	5	-	-
Twyford, Mrs.	5	-	-
Wade, Mrs.	5	-	-
Wigley, Miss	5	-	-
Sums under 5s.	7	6	-
	£6	17	6

OLTON.

Per Mrs. W. R. MELLOR.

Barker, Mr. Harry	5	-	-
Barker, Mr. J.	10	-	-
Barns, Mr.	5	-	-
Butler, Rev. Dr.	5	-	-
Evans, Mrs.	5	-	-
Heaton, Mrs. J. P.	5	-	-
Huggins, Mrs.	5	-	-
Huggins, Mrs. H.	5	-	-
Jenkins, Mrs.	5	-	-
Mellor, Mr. W. R.	5	-	-
Mellor, Mrs. W. R.	5	-	-
Middleton, Mrs.	5	-	-
Nicholl, Mrs. (2years)	1	-	-
Nicholl, Mrs. (2years)	10	-	-
Payne, Mrs.	5	-	-
Scott, Mr. J. C.	5	-	-
Tommas, Mrs.	5	-	-
Sums under 5s.	1	4	-
	£6	14	-

Donations.

YARDLEY.

Per Mrs. HOSKINS and
Mrs. MELLOR.

Boosey, Mrs., Life-boat			
Box	15	-	-
Hoskins, Mrs.	2	5	-
Mellor, Mrs.	3	6	-
Proceeds Ladies' Cricket Match	16	-	-
	£3	19	6

OLTON.

Scott, Mr., Life-boat
Box

Total Subs. 27 1 6

Total Dons. 4 4 6

£31 6 -

BIRMINGHAM BRANCH.

District Hon. Sec.—
CHARLES C. SMITH.

Annual Subscriptions.

Baldwin, J. and Sons, Messrs.	1	1	-
Barwell, C. J. W. Esq.	1	1	-

	£.	s.	d.
Barwell, James, Esq.	1	1	-
Barwell, Wm. Esq.	1	1	-
J.P.	1	1	-
Bown, Misses	1	1	-
Birch, G. B.	10	6	-
Chamberlain, King, and Jones, Messrs.	1	1	-
Chance, A. M. Esq., J.P.	1	1	-
Chance, J. H. Esq.	5	5	-
Clayton, Alderman F. C., J.P.	1	1	-
Clifford, G. W. Esq.	10	6	-
Colmore, Mrs.	1	1	-
Cutler, the Misses	1	1	-
Dugard, H. A. Esq.	1	1	-
Ellis C. & Sons	2	2	-
Finnemore, J. B. Esq.	1	1	-
Heaton, A. Esq.	1	1	-
Heaton, Mrs. Geo.	1	1	-
Manton, H. Esq. J.P.	1	1	-
Padmore, H. R. Esq.	1	1	-
Simpson, F. R. & Co. Messrs.	1	1	-
Singleton, W.	10	6	-
Stokes, A. Esq.	1	1	-
Tangyes, Limited	2	2	-
Warden, Jas. Esq.	10	6	-
Whitehouse, J. Esq.	1	1	-
Whitfield, A. Esq.	10	-	-
Wilkes, J., Sons & Mapplebeck, Ltd.	1	1	-
Wilkes, John, Esq., Darlaston	10	6	-
Williams, J. Esq.	2	2	-
Wills, Mrs. A. W.	1	1	-
Wood, Miss	1	1	-
Total	£37	15	6

Total £37 15 6

Donations.

Collecting Boxes:—

Heaton, Mrs. G.	1	15	-
Folley, Mrs.	10	-	-
Silk, Mr. E.	5	7	-
Swift, Mr. C. E., Queen's Arms, Easy Row	1	6	10
Total Dons.	3	17	5
Total Subs.	37	15	6
	£41	12	11

LEAMINGTON BRANCH.

(No Local Committee.)

Hon. Secretary and
Treasurer—

Annual Subscriptions.

A. L.	10	-	-
Benison, Mr. H.	10	6	-
Blackwood, Mrs.			
Hans	5	-	-
Broadhurst, Mr. H. (Total, the late)	2	2	-
Chance, Mr. H.	1	-	-
Charlemont, The Countess of	1	-	-
Darvall, Miss.	5	-	-
Dodd, Mrs.	5	-	-
Elrington, Rev. R. (the late)	10	-	-
Galton, Miss.	5	-	-
Hughes, Miss	1	1	-
Isard, Mrs.	5	-	-
Lambart, Miss	5	-	-

	£.	s.	d.
Lyon, Miss	5	-	-
McCoy, Mrs.	10	-	-
Newbould, Mrs.	1	1	-
Pyne, Miss.	5	-	-
Stafford, Miss	5	-	-
Thursfield, Dr. T., Mayor of Leamington	5	-	-
Tibbetts, Mrs.	1	1	-
Whistler, Mrs.	1	-	-
Willes, Mrs.	1	1	-
Sums under 5s.	12	6	-
	£14	9	-

Collected by Miss LLOYD—

Berrow, Miss	5	-	-
Buckerridge, Miss	10	-	-
Dartnel, the Misses	5	-	-
Green, Mr. W.	5	-	-
Grimdick, Mr. W. C.	5	-	-
Lloyd, Mrs. R. and family	7	6	-
Lloyd, Mr. W. Hawley	5	-	-
Matthews, Mrs.	5	-	-
Metcalfe, Mrs. (two years)	10	-	-
Metcalfe, the Misses	15	-	-
Metcalfe, Miss S.	5	-	-
Morris, Mrs.	5	-	-
Paske, M.S.	10	-	-
Small, Mrs.	5	-	-
Smallwood, Mr. J.	1	1	-
Thompson, Miss	5	-	-
Tritton, Col., and Mrs.	10	-	-
Wright, Miss	5	-	-
Sums under 5s.	2	6	-
	£7	1	-

Collected in Boxes.

Franklin, Mr., Crown Hotel	9	-	-
Franklin, Mrs., Clarendon Hotel	1	6	6
G. W. R. Station	9	2	-
Wackrill & Sons, Messrs.	7	-	-
Welsh, Mr., Bath Hotel	4	-	-
Boxes under 5s.	10	6	-

Total Dons. 7 2 2

Total Subs. 21 10 -

£28 12 2

Westmoreland.

LAKES DISTRICT BRANCH.

Treasurer—

Colonel MACDOUGALL.

Hon. Secretary—

Rev. CYRIL A. W. ROBINS.

Annual Subscriptions.

Collected by Miss STELLA HAMILTON.

	£.	s.	d.
Arkwright, Miss	2	-	-
Barnard, Mrs.	1	1	-
Cheetham, Miss	10	-	-

	£.	s.	d.
Coutts, Mrs.	1	-	-
Credwood, Rev. G.	10	-	-
Cropper, J. Esq.	5	-	-
Earle, Miss.	1	-	-
Edmondson, Miss.	5	-	-
Flattely, Mrs.	5	-	-
Fletcher, Mrs.	1	-	-
Hamilton, Mrs.	5	-	-
Howarth, Mrs.	1	-	-
Irving, Mrs.	5	-	-
Jeffray, Mrs.	1	-	-
Johnson, T. W. Esq. 1	-	-	-
Jones, F. M. T. Esq. 10	6	-	-
Logan, Mrs. J.	5	-	-
Macquhae, Miss.	10	-	-
Mason, Dr.	10	-	-
Miller, Mrs. W. P.	10	-	-
Moss, Rev. J. M.	1	-	-
Muir, Miss.	5	-	-
Palmer, The Misses 1	-	-	-
Pedder, Mrs.	10	-	-
Puckle, G. H. Esq.	10	-	-
Reynold, Miss.	5	-	-
Rigg, Mrs. Richard.	5	-	-
Roberts, Mrs. F.	1	-	-
S.	1	-	-
Sladen, A. R. Esq.	5	-	-
Sladen, J. M. Esq.	5	-	-
Smith, Mrs. Telford.	5	-	-
Venn, Mrs.	10	-	-
Wigg, Mrs. Lloyd	5	-	-
Wilson, Miss.	10	-	-
Wilson, Miss J.	10	-	-
Sums under 5s.	5	9	6
£36 18 -			

Donations.

Arnold, Miss.	5	-	-
Bolton, Mrs.	5	-	-
Clay, Mrs.	5	-	-
Collecting Boxes—			
Logan, Mrs. J.	9	-	-
Mason, Miss Enid.	5	1	-
Rigg, Mrs. R.	10	6	-
Marshall, Mrs. Victor	10	-	-
Willink, Mrs.	1	-	-
Withers, Colonel ...	10	-	-
£3 19 7			

Annual Subscriptions.

Collected by Miss SARAH SOMERVILLE.

Armitage, Mrs.	5	-	-
Baddeley, J. B. M. Esq.	5	-	-
Binns, Mrs.	5	-	-
Bowler, Mrs.	5	-	-
Burchardt, Mrs.	10	-	-
Butler, Rev. T.	10	-	-
Byres, Mrs. Moir.	5	-	-
Cairns, Miss.	10	-	-
Cairns, Mrs.	1	-	-
Clowes, Mrs.	1	-	-
Dobson, Mrs.	5	-	-
Fleming, Miss.	10	6	-
Fleming, Miss J.	10	6	-
Geddes, Mrs.	5	-	-
Little, Master O., Cul-			
lected by	2	7	6
Logan, Mrs.	10	6	-
Martin, Mr.	5	-	-
McDuggall, Colonel.	5	-	-
Mitchell, Mrs.	10	-	-
O'Neill, Hon. Ann.	10	-	-
O'Neill, Hon. Robert 1	-	-	-
Pruit, G. Esq.	10	-	-
Somerville, Miss S.	7	6	-
Stock, Mrs.	5	-	-
Ullock, Misses	10	-	-
Sums under 5s.	3	17	6
£17 5 -			

Donations.		£.	s.	d.
Local Contribution				
Boxes	2	15	-	-
Total Dons.	6	14	7	
Total Subs.	54	3	-	
	£60	17	7	

Worcestershire

STECHFORD BRANCH.

Treasurer and Hon. Sec.—
Mr. WILLIAM MORGAN.

Annual Subscriptions.

	£.	s.	d.
Bower, Misses, Knowle—	5	-	-
Christopherson, Mrs.	5	-	-
Clarke, Mr.	10	-	-
"Deborah," Hannibal,			
U.S.	10	6	-
Gittins, Mr.	5	-	-
Hills, Mr. W. G.	10	6	-
King, Mr. W. R.	5	-	-
Morgan, Mr. W.	1	-	-
Tomlinson, Mrs.	10	6	-
Viney, Miss	10	-	-
£4 12 6			

Donations.

"A Friend"	2	-	-
Brown, Mr. H.	5	-	-
£2 5 -			

Collecting Cards.

Brown, Master A.	1	5	6
Gwyther, Mrs.	16	10	-
Gwyther, Miss	16	10	-
Gwyther, Miss P.	16	10	-
Hills, Master Percy G.	10	6	-
Luff, Misses	7	6	-

QUARNDON.

Brasher, Miss (1895-6) 3	9	-	-
Newbold, Miss, and			
Miss Rose.	2	-	-
Robotham, Miss E.	16	-	-
Welby, Miss.	2	-	-
£12 10 9			

Total Subs. ... 4 12 6

Total Dons. ... 2 5 -

Col. Cards ... 12 10 9

£19 8 3

WORCESTER BRANCH.

(No Local Committee.)

Treasurer—

FRAS. SPOONER, Esq.

Honorary Secretary—

F. W. SEAMAN, Esq.

Annual Subscriptions.

	£.	s.	d.
Ames, Fredk. Esq.	1	1	-
Bearcroft, Rev. J.	1	1	-
Carr, Rev. W. R.	5	-	-
Cherry, A. C. Esq.	1	1	-
Cheshire, Rev. J. S.	10	-	-
Clarke, Erlin, Esq.	1	1	-
Dodd, Rev. T.	5	-	-
Dorville, Adm. J. W. 1	1	-	-
Douglas, Canon W.	10	6	-
Evans, E. Wallace,			
Esq.	1	1	-
Holland, Walter, Esq.	10	6	-
Jones, Henry, Esq.	1	1	-
Kane, Rev. B. N.	5	-	-
Kingsford, Rev. H.	5	-	-
Lea, C. Wheeley, Esq. 2	2	-	-
Leonard, G. Esq.	5	-	-
Martin, Miss C. H.	2	-	-
McNaught and Co.			
Messrs.	10	6	-
Piercy & Longbottom 1	1	-	-
Reid, John, Esq.	1	1	-
Rowlands, Rev. W. E.	10	6	-
Seaman, F. W. Esq.	5	-	-
Thomas, Mrs. P.	10	6	-
Thursfield, Rev. R. 1	1	-	-
Walker, Henry, Esq. 1	1	-	-
Walsh, Mrs. T. W.	10	6	-
Westcombe, The			
Misses	2	-	-
Williamson, Messrs.	10	6	-
Total Subs.	£23	6	6

Donations.

Box at Cemetery ...	1	7	10
Box at Bell Hotel.	17	-	-
Box at Hop Market			
Hotel	5	-	-
Total	£25	16	4

Yorkshire.

BRADFORD BRANCH

President—
His Worship the MAYOR OF
BRADFORD
(Alderman W. W. WOOD).

Local Committee—

Ald. FREDERICK PRIESTMAN,			
J.P., Chairman.			
T. H. BEDFORD.			
J. BENTLEY.			
A. R. BYLES.			
F. P. CARTER.			
J. A. CLAPHAM.			
Rev. G. P. CLARKE.			
Councillor T. CROSSLAND.			
A. DUFF.			
A. W. FIELD.			
Dr. C. F. FORSHAW.			
M. H. FRANCK.			
JOHN GILL.			
MISS HAHN.			
H. HULL.			
Rev. C. W. N. HYNNE.			
Councillor W. JENNINGS.			
Rev. J. LEIGHTON.			
Mrs. MCKNIGHT.			
C. H. MILTHORP.			
Dr. I. MOSSOP.			
Mrs. MUFF.			
T. L. RENTON.			
J. SCOTT.			
W. H. SMITH.			
G. A. STEINTHAL.			
Councillor J. S. TOOTBILL.			
R. S. TOWN.			

Honorary Treasurer—
J. H. LINCEY.

Honorary Secretary—
CHARLES E. LIEBREICH.

Honorary Auditor—
W. M. GRAY.

Collector—
WM. FIRTH.

Annual Subscriptions.

	£.	s.	d.
Anderton, S. & Sons 2	2	-	-
Bairstow, T. & M.	1	1	-
Brehrens, H.	1	1	-
Bell, E. & Co.	1	1	-
Bottomley, M. J. P. 1	1	-	-
Bottomley, S. & Bros.			
Ltd.	2	2	-
Bradford Wine and			
Bersellers' Assoc. 1	1	-	-
Further Sub.	1	1	-
Bronner, Dr. H.	10	6	-
Brown, George.	10	6	-
Burnley, James, J. P. 1	1	-	-
Burton, John A.	10	6	-
Calvert, Mrs. Rhodes 1	1	-	-
Chamberlin, Donner,			
and Co.	1	1	-
Cohen, B.	1	1	-
Collins, William	1	1	-
Cordingley, Arm-			
strong and Co.	1	1	-
Craven, Joseph.	2	2	-
Drummond, Jas. and			
Sons	1	1	-
Edeinstein, Moser,			
& Co.	1	1	-
Fawcett, Mrs. Richd. 1	1	-	-
Firth, Wm.	1	1	-
Firth and Renton ...	10	6	-
Firth, T. A. and Co. 1	1	-	-
Foster, John & Son. 5	5	-	-
Gautt, J. E.	5	-	-
Godwin, J. V., J.P. 1	1	-	-
Gray, W. M.	1	1	-
Hablo & Liebreich 1	1	-	-
Harrison & Singleton 1	1	-	-
Heilborn, F. and Co. 1	1	-	-
Henry, A. & S. & Co.			
Ltd.	3	3	-
Heynemann, Edward,			
& Co.	1	1	-
Hirsch, Pinner & Co. 1	1	-	-
Hirst, Col. C.B.	1	1	-
Hoffmann, A. and Co. 1	1	-	-
Ingham, Oates & Son 1	1	-	-
Jacobs, Adolph, and			
Co.	1	1	-
Keenan, J. & Co.	1	1	-
Kessler & Co.	1	1	-
Knowles, Cooke, and			
Co.	1	1	-
Leather, Mrs. G. H. 1	1	-	-
Leather, Mrs.	1	1	-
Liebreich, Chas. Edw. 1	1	-	-
Lincey, J. H.	1	1	-
Lord, W. G.	10	6	-
Lossel, A. C.	1	1	-
Lund, Chas. £1 1s.,			
paid in 1895 for			
1895-6.	-	-	-
Lupton, J. & Son.	1	1	-
Mabler, Sichel & Co. 1	1	-	-
Mason, Henry.	2	2	-
McEwan, J. H.	1	1	-
Mosop, Dr.	10	6	-
Muff, T. P.	10	6	-
Muñ, H.	10	6	-
Mugrave, B.	1	1	-
Paterson, M.	1	1	-
Philipp, J.	1	1	-
Philipp, J. and Co. 2	2	-	-
Popplewell, J. B.	1	1	-
Posselt, E. and Co. 1	1	-	-
Priestley, Briggs, and			
Co.	1	1	-
Priestley, T. & Son 1	1	-	-
Priestman, Ald. F.,			
J.P.	1	1	-

	£.	s.	d.
Priestman, Arnold	2	2	-
Quitzwog & Co.	1	1	-
Rand, John and Son 1	1	1	-
Rée, I.	2	2	-
Reiss Bros.	1	1	-
Renton, T. L.	10	6	-
Richardson, Geo., J.P.	10	6	-
Sachs, H. W. and Co. 1	1	1	-
Samson, H. and Lepoc	2	2	-
Schuster, Fulda, and Co.	1	1	-
Shalders, A. O. & Son 1	1	1	-
Simon, Israel, & Co. 2	2	2	-
Stansfeld, Brown, and Co.	1	1	-
Stavert, Zigomala, and Co.	1	1	-
Steinthal, G. G.	1	1	-
Steinthal, G. A.	1	1	-
Stephenson Bros.	1	1	-
Tankard, H. H.	4	4	-
Thompson, Lady Dowager	2	2	-
Tordoff, John & Son 1	1	1	-
Wales, James	1	1	-
Walker, R. G., 1894	10	6	-
Wehner, G. E. & Co. 1	1	1	-
Total Subs.	£108	8	-

Donation.

C.E.Stansfield, M.A. 5	5	-	-
Total	£113	8	-

BRIDLINGTON AND BARMSTON BRANCH.

Local Committee—
 Capt. ATKIN.
 H. M. JACKSON, Esq.
 L. F. C. JACKSON, R.N.
 Col. LLOYD GRAEME.
 Col. RICKABY.
 W. TODD, Esq.
 A. WEST, Esq.

Honorary Secretary—
 Captain ATKIN.

Annual Subscriptions.

Bank, C. & Co.	5	-	-
Boynton, Sir H. S.	1	-	-
Brett, F. C.	10	-	-
Graeme, Col. Lloyd. 1	1	-	-
Harrison, Mrs.	5	-	-
Hodgson, Mrs.	10	-	-
Hudson, Rev. C.	10	-	-
Hull Trinity House. 5	5	-	-
Jackson, H.	5	-	-
Jameson, J. A.	1	-	-
Jarratt, W. O.	5	-	-
Ouston, D.	5	-	-
Quinton, Mr. H.	1	-	-
Rickaby, Colonel	5	-	-
Roymann, R. D.	5	-	-
Sikes, Miss	5	-	-
Smith, E. G.	5	-	-
Taite, W. A.	5	-	-
Walton, Miss	5	-	-
Sums under 5s.	2	16	6
Total Subs.	£16	3	6

Donations.

Contribution Boxes. 6 2 7	6	2	7
Total	£22	6	1

BRIGHOUSE BRANCH.

President—
 His Worship THE MAYOR.

Local Committee—
 J. ATKINSON, Esq.
 W. J. CHAMBERS, Esq.
 Dr. CARTER.
 G. HEAL, Esq.
 G. JESSOP, Esq.
 J. NAYLOR, Esq.
 J. PARKINSON, Esq.
 H. Y. SUGDEN, Esq., J.P.
 J. SUNDERLAND, Esq.

Treasurer—
 C. FOWLER, Esq.

Hon. Secretary—
 Mr. W. H. FOGG.

Annual Subscriptions.

	£.	s.	d.
Armytage, G. J. Esq. 1	1	-	-
Aspinall, Wm. Esq.	-	-	-
Atkinson, J. Esq.	5	-	-
Bentley & Smith	5	-	-
Blackburn, C. Esq.	1	-	-
Blackburn, S. Esq.	10	-	-
Blakeboro, J. & Sons 1	-	-	-
Blakeboro, W. Esq.	10	-	-
Booth, L. Esq.	5	-	-
Booth, Wm. Esq.	5	-	-
Bottomley, J. C. Esq. (1895-6)	2	2	-
Bottomley, J. Esq.	5	-	-
Byrne, Miss	10	-	-
Carter, Dr.	10	6	-
Chambers, W. J. Esq. 1	1	-	-
Clay, J. W. Esq., J.P. 1	-	-	-
Clayton, Thos. Esq.	5	-	-
Crowther, J. & Co.	10	6	-
Dyson, James, Esq.	5	-	-
Elam, T. Esq.	5	-	-
Ferguson, R. J. Esq.	10	6	-
Field, Chas. Esq.	5	-	-
Fowler, C. Esq.	10	6	-
Freeman, T. Esq.	10	-	-
Goodall, J. T. Esq.	10	-	-
Grandage W., & Co. 1	1	-	-
Helm, G. Esq.	1	-	-
Johnson, C. K. Esq.	5	-	-
Kershaw, B. & Co.	1	1	-
Lawson, J. Esq.	10	6	-
Lister, T. & H.	1	-	-
Naylor, J. Esq.	5	-	-
Oliver, J. Esq.	10	6	-
Ormerod, C. J. Esq. 1	1	-	-
Ormerod, T. Esq.	10	6	-
Ormerod, Miss	10	6	-
Ormerod, Miss M.	10	6	-
Parkinson, J. Esq.	5	-	-
Ramsden, Camm & Co.	1	1	-
Roberts & Lyster	10	-	-
Robinson, A. Esq.	5	-	-
Smith, J., & Sons	1	1	-
Smith, T. Esq.	5	-	-
Smith, Wm., & Sons, Ltd.	10	6	-
Stedman, R. P. Rev.	10	6	-
Sngden, H. & J.	2	2	-
Sunderland, J. Esq.	5	-	-
Thompson, J. W. Esq.	5	-	-
Thornton, Hannam & Marshall	1	1	-
Waddington, Mrs.	10	-	-
Wood, J. Esq.	10	6	-
Woodhouse & Mitchell	1	1	-
Sums under 5s.	10	-	-
Total	£33	2	-

Donations.

Turner, J. W.	5	-	-
Sums under 5s.	5	2	-
Total Dons.	10	2	-
Total Subs.	33	2	-
£33	12	2	-

DEWSBURY BRANCH.

President—
 Alderman G. A. Fox, J.P., Mayor.

Lady President—
 Mrs. G. A. Fox, Mayoress.

Hon. Secretaries Ladies' Committee—
 Miss ELLIS and Miss FAIRBANK.

Chairman of Collection Committee—
 DUKE FOX, Esq.

Committee—
 Councillor BIRKHEAD.
 G. H. BURRAS.
 Councillor BAKER.
 Rev. H. L. CLARKE.
 Major CHADWICK.
 F. DWYER.
 Major FOX, J. P.
 DUKE FOX, J.P.
 Dr. HALLIWELL.
 E. HEMINGWAY.
 G. H. HIRST.
 JOHN HUTCHINSON.
 Alderman E. KILBURN, J.P.
 WILSON KILBURN.
 W. L. POPPLE.
 BERNARD QUINN.
 Councillor REUSS.
 R. SPEDDING, J.P.
 GEORGE STONES.
 W. R. THOMPSON.
 Councillor TOUNSEND.

Treasurer—
 C. P. HOBKIRK, F.L.S.

Secretary—
 WALTER DAWSON, C.A.

Bankers—
 HUDDERSFIELD BANKING COMPANY, Ltd., Dewsbury.

(No List for 1896 excepting that of the "Life-boat Saturday.")

FILEY BRANCH.

Local Committee—
 C. G. WHEELHOUSE, Esq., Chairman.
 Mr. WM. CAPPLEMAN.
 Rev. A. N. COOPER.
 Lieut. F. C. JACKSON, R.N.
 Captain T. SMYSON.
 Rev. JOHN M. WILLIAMS.

Honorary Secretary—
 Mr. J. LEWIS.

Annual Subscriptions.

Beswick, W. B. Esq. 1	1	1	-
Clarke, Miss	1	-	-
Clay, A. T. Esq.	1	-	-

	£.	s.	d.
Cooper, Rev. A. N.	5	-	-
Harrison, Miss	1	-	-
Haley, J. W. Esq.	1	1	-
Haworth, Dr. Thos.	5	-	-
Holden, Angus, Esq. 1	1	1	-
Lawson, A. T.	1	1	-
Martin, Edwin	1	-	-
Martin, John, Esq.	1	-	-
Mitford, W. O. Esq.	2	-	-
Rigg, T. F. Esq.	10	-	-
Southwell, H.G. Esq.	10	-	-
Towse, Samuel, Esq.	10	-	-
Wheelhouse, C. G., M.D.	1	-	-
Williams, Rev. J. M. 1	1	-	-
Total	£15	4	-

Donations.

Contribution Boxes 15 2 2	15	2	2
Donations	12	13	-
Total Dons.	27	15	2
Total Subs.	42	19	2

£42 19 2

FLAMBOROUGH BRANCH.

Local Committee.
 Mr. J. S. BUTLER.
 Mr. H. BAILEY.
 Mr. M. BAILEY.
 Mr. M. HULLLESTON.
 Mr. B. LAMPLUGH.
 Councillor J.V. MAINPRIZE.
 Mr. L. MAINPRIZE.
 Mr. RAWNSLEY.
 Mr. ROBERTS (C.O., H.M. Ct. Gd.)
 Mr. W. STORK.
 Mr. B. TRAVES.
 Rev. J. F. WILKINSON.
 Mr. T. W. WOODCOCK.

Honorary Secretary—
 Mr. JAMES WOODHOUSE.

Annual Subscriptions.

Butler, J. S.	5	-	-
Bailey, H.	5	-	-
Bailey, M.	5	-	-
Dormer, C. Esq.	10	6	-
Harding, Mrs.	5	-	-
Holden, Angus, Esq. 1	1	1	-
Lamplugh, B.	5	-	-
Mainprize, Councillor	5	-	-
Mainprize, L.	5	-	-
Rawnsley, S.	5	-	-
Stork, W.	5	-	-
Traves, B.	5	-	-
Wilkinson, Rev. J.F.	5	-	-
Woodcock, T. W.	5	-	-
Woodhouse, Mr. J.	5	-	-
Total Subs.	£4	16	6

Donations.

Contribution Boxes .10 7 -	10	7	-
Total	£15	3	6

HALIFAX BRANCH.

President—
 G. H. SMITH, Esq., J.P., Mayor.

Vice-Presidents—
 Ven. Archdeacon BROOKE, M.A.
 S. T. MIDDLEY, Esq., J.P.
 Wm. ANBLER, Esq., J.P.
 JAMES BAIRSTOW, Esq., J.P.

Local Committee—
MATTHEW G. DOBSON, Esq.
F. G. FLEMING, Esq.
WILLIAM GAUKROGER, Esq., J.P.
ROBERT KERR, Esq.
FRANK PATCHETT, Esq., J.P.
A. SCOTT, Esq.
Captain THOMPSON.
R. D. WARD, Esq.

Honorary Secretary—
GEORGE SCARBOROUGH, E. Q.

Treasurer and Hon. Collector—
ROYSTON WALKER, Esq.

Annual Subscriptions.

£. s. d.
 Ambler, Wm. Esq., J.P. 1 1 -
 Bainstow, Jas. Esq., J.P. 1 1 -
 Baldwin, John, Esq. 1 1 -
 Baldwin, Wm. Esq. 1 1 -
 Bottomley, A. Esq. - 10 6
 Brear, Wm. Esq. 1 1 -
 Brook & Sons, Messrs. D. 1 1 -
 Brooke, Ven. Archdeacon, M.A. 1 1 -
 Cash Supply Stores, Ltd. - 10 6
 Clayton, Murgatroyd & Co., Messrs. 1 1 -
 Clegg, Mrs. George. 1 1 -
 Collinson, Jos., Esq. 1 1 -
 Collinson, J. W. Esq. - 5 -
 Crossley & Sons, Ltd., Messrs. John 10 -
 Daniels, J. W. Esq. 1 1 -
 England, Thos. Esq. - 10 6
 Farrar & Whiteley, Messrs. - 10 6
 Fleming, F. G. Esq. - 10 6
 Fletcher, B. L. Esq. 1 1 -
 Fletcher, Eli, Esq. 1 1 -
 Gaukroger, Wm. Esq., J.P. 1 1 -
 Greenwood, R. O. Esq. - 10 6
 Haddon, Robt. Esq. - 10 6
 Holdsworth, Clement, Esq., J.P. 1 1 -
 Holt, James, Esq. - 10 6
 Hoyle, Richard, Esq. 1 1 -
 Hoyle, John, Esq. 1 1 -
 Howarth, Greenwood, Esq. - 10 6
 Huntriss, Edwd. Esq. 1 1 -
 Huntriss, Harold, Esq. - 10 -
 Ingham, Mrs. Edwd. 1 1 -
 Ingham, Miss E. - 5 -
 Kerr, J. M. Esq. - 10 6
 Kerr, R. M. Esq. - 10 6
 Kerr, Robert, Esq. 1 1 -
 Leigh, Mrs. ("Summerville") 2 2 -
 Mantle, Dr. - 10 6
 McCrea, A. S. Esq. 1 1 -
 McNaught, Thos. Esq. - 10 6
 Midgley, S. T. Esq., J.P. 1 1 -
 Mortimer, Edw. Esq. - 10 6
 Needham, Robt. Esq. - 10 6
 Osborn, S. Esq. - 10 6
 Patchett, F. Esq., J.P. 1 1 -
 Porter, Miss - 10 -
 Ramsden, J. T. Esq. 1 1 -
 Riley, Mrs. J. T. 1 1 -
 Robinson, G. E. W. Esq. - 10 6
 Rose, C. E. Esq. - 10 6
 Sanders, Mrs. T. R. 1 1 -
 Scott, A. Esq. 1 1 -
 Simpson, J. T. Esq. 1 1 -
 Simpson, Wm. Esq. - 10 6
 Smith & Co., Messrs. Fred. 2 2 -

£. s. d.
 Speak, Alfred, Esq. - 10 6
 Stott, W. M. Esq. - 5 -
 Thompson, Capt. ... 1 1 -
 Thorpe, W. H. Esq. - 10 6
 Turner, Edwd., Esq. 1 1 -
 Utey, Wm. Esq. - 10 6
 Waite, Mrs. - 10 6
 Walker, Mrs. Henry 5 -
 Walker, Royston, Esq. 1 1 -
 Ward, J. Whiteley, Esq., J.P. - 10 6
 Ward, R. D. Esq. 1 1 -
 Wavell, E. M. Esq., J.P. - 10 6
 Webster, G. H. Esq. 1 1 -
 Whiteley, John, Esq., J.P. - 10 6
 Whitaker, Jos. Esq., J.P. 1 1 -
 Whitaker, Thos., Esq., J.P. 1 1 -
 Winks, Alfred, Esq. - 10 -
 Whitley, S. Esq. - 10 -
 Wright, Dr. J. Hodgson, J.P. 2 2 -
 Wright, Mrs. J. Hodgson, J.P. - 10 6
 Total £70 3 6

Donations.
 A Friend 3 -
 A Friend 2 6
 Akroyd, Thos. Esq. 1 -
 "J. C." Halifax 1 -
 Ryley, Geo. Esq. - 10 -
 Shaw, W. Rawson, Esq., M.P. 1 1 -
 Walker, Saml. Esq. 1 1 -
 Windle, Dr. - 5 -
 Young Men's Bible Class (3rd), Park School 1 1 -
 Total £26 3 6

Collecting Boxes.
 Grand Junction Hotel - 10 -
 "Halifax Club" - 10 -
 Old Cook Hotel 2 2 6
 Rose & Crown Inn. 7 6
 Shakespeare Hotel ... - 8 6
 Union Cross Hotel. - 10 -
 Vaults, "S. & Co." - 4 -
 White Swan Hotel. 1 1 -
 Total Boxes. 5 13 6
 Total Subs. 70 3 6
 Total Dons. 6 3 6
 £82 - 6

HORNSEA BRANCH.
 Local Committee—
THOMAS GREGSON, Esq., J.P., Chairman.
Chief G.G. Officer BUTLIMER.
WM. COLLINSON, Esq.
Capt. F. CONSTABLE, J.P.
W. G. GRIFFITHS, Esq.
F. HAIGH, Esq.
D. C. HAWORTH-BOOTH, Esq.
Capt. E. JOHNSON.
Rev. C. E. LITTLE.
T. R. RADCLIFFE, Esq.
C. F. WELLS, Esq.

Honorary Secretary and Treasurer—
WILLIAM COLLINSON, Esq.

Annual Subscriptions.
 Bethell, Com. M.P. 1 -
 Dalton Holmes & Co., Messrs. - 10 6

£. s. d.
 Gregson, T. Esq. - 10 6
 Holmes, T. B. Esq. 2 2 -
 Hudson, The Misses - 10 -
 Loft, Mrs. - 5 -
 Lyon, C. E. A. Esq. - 10 -
 Ringrose-lop, Mrs. 1 -
 Tew, Rev. E. L. H. - 5 -
 Thomas, Rev. G. G. S. - 5 -
 Trinity House 5 -
 Wade, J. E. Esq. 1 -
 Sums under 5s. - 7 -
 Total Subs. £13 5 -

Donations.
 Contribution Boxes - 10 4
 Total £13 15 4

HUDDERSFIELD BRANCH.

President—
HIS WORSHIP THE MAYOR.

Committee—
FREDERICK H. SHAW, Chairman.
MELLOR ADDY.
JOHN CROSSLEY.
W. FELL.
GEORGE GAUNT.
WILLIAM HIRST.
DR IRVING.
J. B. LITTLEWOOD.
T. K. MELLOR.
ROBT. NELSON.
S. D. TIFFANY.
EDWARDS WATKINSON.
F. W. WALKER.

Honorary Treasurer—
W. J. KAYE, J.P.

Honorary Secretary—
W. H. ARMITAGE.

Assistant Secretary—
J. A. FARRAND.

Collector—
ALFRED BRADLEY,
 12, Kirkgate Buildings.

Annual Subscriptions.

Abbey & Hanson ... 1 1 -
 Aitley, Sons & Co. 1 1 -
 Allan, William - 10 6
 Allen, Thomas. - 10 6
 Armitage Bros. 2 2 -
 Armitage & Norton 1 1 -
 Barnicot, Richd. A. 1 1 -
 Beadon, Major. 1 1 -
 Beaumont, Joshua, & Co. 1 1 -
 Bentley & Shaw, Ltd. 1 1 -
 Bentley, F. W. & Co. 1 1 -
 Bottomley, Col. J. R. 1 1 -
 Bradbury, T. H. (Colnebridge) ... 1 1 -
 Brigg, John F., J.P. 1 1 -
 Broadbent, J. C. 1 1 -
 Brook, E. F. - 10 6
 Brook, Freeman, and Batley 1 1 -
 Brook, George S. 1 1 -
 Brook, Jonas, & Bros. 5 -
 Brooke, Edw., J.P. ... 1 1 -
 Brooke, H. (Warrenfield) 1 1 -
 Brookes, John, & Sons 5 -
 Calverley, Titus & Sons 1 1 -
 Chichester, Mrs. 5 5 -
 Child, William - 11 -
 Clarke, T. Kilner, M.D. 1 1 -
 Clayton, Holdroyd & Co. 1 1 -
 Clegg, Jesse. 1 1 -

£. s. d.
 Clough, The Misses. 1 1 -
 Crosland, G. W. ... 1 -
 Crosland, Sir Joseph, 1 1 -
 Cumming, Wm. & Co. 1 1 -
 Cumming, W. Bryce 1 1 -
 Day, John, and Sons 2 2 -
 Denham, Thomas, & Co. - 10 6
 Denham, J. W. - 10 6
 Dyson, Law & Son. 1 1 -
 Eastwood, D. & Sons. 1 1 -
 Eastwood, Fred. & Co. 1 1 -
 Finlison, A. 1 1 -
 Firth & Miller 1 1 -
 Fisher & Co. 2 2 -
 Fisher, John & Sons 1 1 -
 Foster, J. E. 1 1 -
 France, Josiah. 1 1 -
 Gledhill, Luke and Co. - 10 6
 Haigh, Allen. 1 1 -
 Harrop, George and Sons 1 1 -
 Harrop, Wm. 1 1 -
 Henry, A. S. & Co., Ltd. 1 1 -
 Heron, Charles. 1 1 -
 Hirst, Ben., J.P. 1 1 -
 Hirst, Mrs. Charles. 1 -
 Hirst, Thomas & Co. 1 1 -
 Hirst, Mrs. W. Edwards 1 1 -
 Hirst & Mallinson 1 1 -
 Holdroyd, George ... - 10 6
 Holliday, Read & Sons 2 2 -
 Holmes, The Misses 1 1 -
 Hopkinson, J. & Co. - 10 6
 Hudson, Thomas. ... 1 1 -
 Irving, John, M.B.C.M. 1 1 -
 Jennens, Welch & Co. 1 1 -
 Jubb, A., & Son, Ltd. 1 1 -
 Kaye, Alfred 1 1 -
 Kaye & Stewart 1 1 -
 Kaye, W. J., J.P. 1 1 -
 Keighley, C. W., J.P. 1 1 -
 Keighley, T. B. 1 1 -
 Kenyon, Mrs. 1 1 -
 King, W. 1 1 -
 Kirby, Mrs. 1 1 -
 Kirk, John and Sons 1 1 -
 Knight, Geo. T. (New York) 1 1 -
 Leacroft Brothers & Co. 2 2 -
 Leacroft, Edwd. 1 1 -
 Leacroft, Sammel. ... 1 1 -
 Liddell & Briery ... 1 1 -
 Liebrich & Beardsell 1 1 -
 Lockwood, Geo. 1 1 -
 Lowenthal, G. E. - 10 6
 Lumb, J. & Sons, Ltd. 1 1 -
 Mallinson, Mrs. A. 1 1 -
 Mallinson, Rev. Joel - 10 6
 Mallinson, W. 1 1 -
 Marsden, Richard ... - 10 6
 Martin, Sons & Co., Limited 5 5 -
 Mellor & Wimpenny 1 1 -
 Midgley, Mrs. David 1 1 -
 Moxon, G. D. - 10 6
 Nelson & Woolger 1 1 -
 Norton, Thos., J.P. 1 1 -
 Poppleton, Appleby & Richardson ... 1 1 -
 Porritt, R. & Co. 1 1 -
 Priestley, Jas., J.P. 1 1 -
 Ramsden, Sir J. W., Bart. 2 2 -
 Ramsden, Sykes and Ramsden 1 1 -
 Robinson, F. W. ... 1 1 -
 Scott, W. M.D. 1 1 -
 Shaw, J. W. and H. 1 1 -
 Shaw, W. Dale, J.P. 1 1 -
 Starkey Bros. 5 -
 Stothart & Faulder 1 1 -
 Stott, T. H. 1 1 -
 Sykes, Edward & Sons 2 2 -
 Sykes, Fred. W., J.P. (Lindley) 5 -

£.	s.	d.
Sykes, George Dyson	1	1
Sykes, Godfrey & Sons	1	1
Sykes, J. Nield, J.P.	1	1
Sykes, John, J.P.	1	1
(Lindley)	1	1
Sykes, Joseph & Co.	1	1
Sykes, John & Sons	1	1
(Turnbridge)	10	6
Sykes, W. Shaw	1	1
Taylor & Littlewood	1	1
Taylor, H. B. (the late)	1	1
Taylor, John, & Sons	1	1
Taylor, J. Thorpe, J.P.	1	1
Thomson, George	1	1
Thornton, John	1	1
Tinker, C. S.	1	1
Tolson, Legh, Dalton	1	1
Tomlinson, Mrs. G.W.	1	1
Walker, Edwin & Co.	1	1
Watkinson, Edwards	10	6
Watkinson, J. & Sons	2	2
Whitworth, Mr.	10	6
Wilkinson, J. & Son	1	1
Willans, J. E., J.P.	1	1
Woodhead, Edgar T.	10	6
Woodhead, Godfrey	10	6
Woodhead, Mrs. E.B.	1	1
Woodhead, Jos., J.P.	2	2
Wrigley, John, and Sons	1	1
Total	£163	15 6

Donations.

Bradford Road Christian Mission	1	2	9	
Co-operative Society	5	5	-	
Hall Bower Sunday School	1	4	11	
Highfield 2nd Young Men's Bible Class	1	-	-	
Huddersfield Examiner	3	8	-	
Huddersfield Society of Friends	-	16	6	
Huddersfield Weekly News	4	18	6	
Kirkburton Wesleyans	-	10	6	
Lepton Primitive Methodists	-	15	-	
Lockwood Baptists	3	10	6	
Netherton Wesleyans	1	1	-	
Rehoboth Chapel	2	4	1	
Shelley Wesleyans	-	16	2	
South Crosland Church	-	1	16	2
St. John's Church Young Men's Bible Class	1	1	-	
Total	£29	10	1	

Commercial Travellers' Association, Collected by W. Hammond, Esq.

Beardsell, C. W.	-	10	-
Beaumont, John	-	2	6
Brook, A. J.	-	5	-
Crowther, G. H.	-	2	6
Green, T. J.	-	2	6
Hammond, W.	-	10	-
Hirst, F. W.	-	2	6
Hirst, J. H.	-	2	6
Jenkins, Joseph	-	5	-
Moore, T. H.	-	5	-
Mortimer, John J.	-	10	-
Shaw, B. G.	-	2	6
Sykes, Geo. W.	-	2	6
Thackrah, Jonathan	-	2	6
Thomson, James	-	2	6
Thorpe, T. W.	-	5	-
Washington, Geo.	-	2	6

Willingale, T.	-	2	6
Wilson, John	-	2	6
Wrigley, Fred	-	2	6
Total	£4	2	6

Life-boat Saturday Donations.

EMPLOYEES OF—

Ainley, Sons & Co.	3	1	5
Bairstow, Sons & Co.	2	7	3
Parnicot & Kenyon	1	11	6
Clayton, Holdroyd & Co.	1	3	6
Cockroft, A. & Sons, Ltd.	1	10	-
Crosland, Geo., & Sons	1	1	-
Cumming, W. B.	-	10	6
Darwin, Thos.	1	-	-
Eastwood Bros.	-	13	6
Greenwood, J. & Sons	1	18	8
Hillbush Co-operative	1	5	1
Holland, Hy.	2	2	-
Holroyd, W. & P.	-	5	6
Huddersfield Industrial Society	4	16	4
Kaye & Stewart	5	-	-
Kenworthy & Royston	-	11	-
Knight, G. T.	-	16	-
Liebreich & Beardsell	1	-	-
Lunn & Cardno	-	17	-
Peckett, F., & Sons	-	10	-
Robson, J. & Sons	1	16	3
Sykes, Joseph, & Bros., Ltd.	5	14	1
Sykes, Joseph & Co.	-	9	3
Taylor & Littlewood	3	-	-
Taylor, Samuel & Co.	-	18	-
Vickerman, B. & Sons, Ltd.	-	17	3
Whitehead, G.	-	16	-
Total	£45	10	1

Hotels.

Cherry Tree Hotel	-	2	6
George Hotel	1	5	-
Grove Inn	5	5	-
Huddersfield and County Conservative Club	-	7	1
Imperial Hotel	-	1	10
Pack Horse Hotel	-	2	-
Queen Hotel	-	4	8
Wood, J. H., & Sons	1	-	-
Total	£7	9	1
Bank Interest	-	4	10
Grand Total	£250	12	1

HULL BRANCH.

(No Local Committee.)

Honorary Secretary—
WILLIAM DYSON, Esq.

Collector—
MR. J. L. STRAFFORD.

Annual Subscriptions.

Allison Bros. Messrs.	-	10	6
Bach & Co. Messrs. T.	-	10	6
Buckton and Sons, Messrs. Geo.	-	10	6
Burstead and Huffam, Messrs.	-	10	6
Burwell, W.	1	1	-
Chambers, G. W. Esq.	-	10	6

Davis, E. and Co.	2	2	-
Dossor, Capt.	-	10	6
Dyson, W. Esq., Hon. Sec.	-	10	6
Earle, Messrs. G. & T.	-	10	-
Earle's Engineering & Shipbuilding Co.	2	2	-
Fargus, James, Esq.	-	10	6
Firbank, J. T. Esq., M.P.	2	2	-
Gibson and Son	-	10	6
Grotrian, F. B. Esq.	-	10	6
Haller, G. R.	1	1	-
Hammond, Emses, and Co. Messrs.	-	10	6
Harrison - Broadley, H. Esq.	1	1	-
Helmsing and Son	-	10	6
Hewetson, Misses	-	10	6
Hill, J. H. Esq.	-	10	-
Holmes, T. B. Esq.	-	10	6
Horsley, Smith, & Co.	1	1	-
King, Sir H. S., M.P.	2	2	-
King & Co. Messrs.	-	10	6
Kuypers, Ostler, and Scott	-	10	6
Lambert, S. & Co.	-	10	6
Londesborough, Lord, The Right Hon.	10	10	-
Malcolm and Son, Messrs. George	-	10	6
Marillier, R. A. Esq.	-	10	6
Marris, Willows, and Smith, Messrs.	-	10	6
Marshall, W. T.	-	10	6
Mason, Mrs. W. R.	-	10	6
Massey & Co.	-	10	6
Maw, Till, Kirke & Co., Messrs.	1	1	-
Moss-Blundell, J. S. Esq.	-	10	6
Peasegood, W. Esq.	-	10	6
Rayment & Sharpe	-	10	-
Reckitt and Sons, Limited	1	1	-
Ripon, The Most Hon. the Marquis of	2	2	-
Seaton, J. L. Esq.	-	10	-
Shaw, J. H.	-	10	-
Shaw, Son, & Co.	1	1	-
Sissons Brothers and Co. Messrs.	1	1	-
Smith Brothers and Co. Messrs. S.	2	2	-
Storry, Smithson, & Co. Messrs.	1	1	-
Storry, Witty, & Co.	-	10	6
Teally & Co. Messrs.	1	1	-
The Minerva Lodge (No. 250) of Ancient Free and Accepted Masons	2	2	-
The York Union Banking Company	2	2	-
Tholander, Capt. O.	-	10	6
Thorney, J. J. Esq.	-	10	6
Tudor, S. and Sons	-	10	6
Veltmann and Co., Messrs. N.	1	1	-
Wade, Sons, and Co., Messrs. Richard	4	4	-
Wadsley, Mrs. E.	1	1	-
White & Son, Messrs.	1	1	-
Wilson, E. S. Esq.	1	1	-
Wilson, Sons, & Co., Messrs. Thomas	10	10	-
Winkley and Co., Messrs. J.	1	1	-
Sums under 10s.	1	15	-
Total Subs.	£77	4	6

Donations.

Box at Messrs. R. Procter & Sons	1	2	4
Tinley, William, Nelson-st., Hull	100	-	-
Total	£178	6	10

KEIGHLEY BRANCH.

(No Local Committee.)

Treasurer—

JOHN BRIDGE, Esq., M.P., J.P., F.G.S., Aid. C.C.

Honorary Secretary—
ALFRED ADAM, Esq.

CARLTON.

Hon. Collector—
MR. ALFRED ADAM.

£.	s.	d.	
Barker, Rev. T. C.	-	5	-
Slingsby, John, Esq.	-	10	-
Slingsby, John	-	-	-
Arthur, Esq.	-	5	-
Slingsby, Miss	-	5	-
Slingsby, Mrs. W.	-	-	-
Cecil	-	5	-
Slingsby, Wm. Esq.	-	10	-
Total	£2	-	-

GARGRAVE.

Hon. Collector—

MR. THOMAS BROUGHTON.

Bracewell, Mrs.	-	5	-
Bracewell, Mrs. A.	-	10	-
Bracewell, Mrs. W.	-	5	-
Coulthurst, John, Esq.	1	-	-
Davis, The Misses	-	5	-
Greenwood, Mrs.	-	10	-
Marsden, Rev. C. J., M.A.	-	10	6
Mason, Joseph, Esq.	-	10	-
Snell, John, Esq., M.R.C.S.	-	10	6
Stockdale, Mrs.	-	10	-
Wilson, Sir M. W., Bart.	1	-	-
Wilson, Lady	1	-	-
Sums under 5s.	-	6	2
Total	£7	2	2

ILKLEY.

Hon. Collectors—

Mrs. KELLETT and Miss THORPE.

A Friend	-	5	6
Dove, Mrs. C. P.	-	5	-
Kellett, Mrs.	-	10	8
Mallinson, Mrs.	-	5	-
Oddy, Mr.	1	1	-
Parkinson, Mr.	-	5	-
Potter, Mrs.	-	5	-
Robinson, Mrs.	-	10	6
Smith, Mrs. W.	-	5	-
Sums under 5s.	-	7	6
Total	£4	-	-

KEIGHLEY.

Hon. Collector—

MR. ALFRED ADAM.

Balley, J. B. Esq.	-	5	-
Clapham Bros. Ltd., Messrs.	1	1	-
Haggas, J. & Co., Messrs.	1	1	-
Haggas, W. Sons & Co. Ltd. Messrs.	1	1	-
Hall & Skell, Messrs., for 1895	-	5	-
Ikcringill, Messrs. Ira & Co., Limited	1	1	-
Keighley Herald, Proprietors of	-	5	-
Keighley Tradesmen's Association	2	2	-

ANNUAL SUBSCRIPTIONS AND DONATIONS TO BRANCHES.

	£.	s.	d.
Law, Edward, Esq., M.D., London	1	1	-
Lund, James, Esq., D.L.	2	2	-
Murton & Varley, Sellers & Sons, Messrs. W.	10	6	-
Smith, Marks & Co. Smith & Bro., Messrs. Swire	1	1	-
Varley & Co., Messrs. (Ingrow)	1	1	-
Various Collecting Boxes, per Mr. Charles Stanley	1	10	-
	£15	7	-

SKIPTON-IN-CRAVEN.

Hon. Collector—
Mr. W. H. DAWSON.

Ackernley, Miles, Esq.	5	-	-
Anderton, Fred, Esq.	10	-	-
Anderton, Wm. Esq.	10	-	-
Barrett, K. B. Esq.	10	6	-
Birtwhistle, Dr.	10	6	-
Birtwhistle, R. P. Esq.	10	-	-
Brown, T. P. Esq.	1	-	-
Charlesworth, C. P. Esq.	10	6	-
Cook, Rev. H. L.	5	-	-
Davis, Thomas, Esq.	10	-	-
Dawson, J. T. Esq.	5	-	-
Dawson, W. H. Esq.	7	6	-
Devonshire Hotel Collecting Box, per Tom Carlisle, Esq.	18	-	-
Dewhurst, John & Sons, Ltd.	2	2	-
Farey, S. & Son	1	1	-
Fattoriali, T. Esq.	5	-	-
Garnett-Orme, Mrs.	1	-	-
Hall, Miss	10	-	-
Hartley, E. T. Esq.	10	6	-
Jefferson, R. I. Esq.	5	-	-
Kendall, George, Esq.	10	6	-
Kendall, Welbury, Esq.	10	6	-
King, Miss	1	1	-
Lowcock, C. Esq.	5	-	-
Maude, Lieut.-Col.	10	-	-
Robinson, Lieut.-Col.	1	1	-
Robinson, Miss (Newmarket)	10	-	-
Scott, John, Esq.	1	1	-
Ship Hotel, Box collection, per Miles Ackernley, Esq.	1	6	-
Stansfeld, Mrs. A. W.	5	-	-
Towler, Mrs.	5	-	-
Varley, John, Esq.	5	-	-
Walton, Messrs. W. & Co.	10	6	-
Wilkinson, J. R. & Sons, Messrs.	10	6	-
Wilson, Richard, Esq.	5	-	-
Wyble, Dr.	10	-	-
Sums under 5s.	1	2	-
	£22	9	-

STERTON.

Hon. Collector—
Miss MARION FOX.

Adam, Mr. Alfred	2	2	-
Bailey, Miss	10	-	-
Barlow, Miss Mary	10	-	-
Bairton, Miss	10	-	-
Broadley, Mr. E.	10	-	-
Clough, Mrs. Thomas	1	1	-
Clough, Mrs. Wm.	10	-	-
Craven, Miss	10	-	-
Craven, Mrs.	5	-	-
Dixon, Mrs., Harwood House	5	-	-

	£	s.	d.
Dixon, T. & Sons, Ltd.	1	1	-
Dixon, Mrs. T. O.	5	-	-
Stetson Co-operative Society	10	-	-
Sums under 5s.	1	-	6
	£9	9	6

THORNTON-IN-CRAVEN AND MARTON.

Roundell, T. S. Esq.	1	-	-
Roundell, R. F. Esq.	2	10	-
Smith, Mrs. (Fence End)	10	-	-
Sutcliffe, T. Esq.	10	-	-

Total Subs 64 17 8

LEEDS BRANCH.

(No Local Committee.)

President—

E. W. BECKETT, Esq., M.P.
Vice-Presidents—
JOHN BOWLING, Esq.
R. P. BRINDLEY, Esq.
H. OXLEY INGHAM, Esq.
H. J. PALMER, Esq.
FRED R. STARR, Esq., J.P.
Councillor C. H. WILCOX.

Honorary Secretary—

J. W. LUDOLF, Esq.

Collector—

WM. FENTEMAN COATES.

Annual Subscriptions.

Adam, M. & Co.	1	1	-
Albrecht & Albrecht	2	2	-
Albrecht, W. & Co.	1	1	-
Armitage, Thos. Esq.	5	-	-
Ash Bros., S. & L.	10	-	-
Atkinson, D. H., Esq.	10	-	-
Barker, W. S. Esq.	1	1	-
Barran, J. & Sons	2	2	-
Beckett & Co., Messrs.	5	5	-
Bedford, James, Esq.	1	1	-
Bilbrough, A., Esq.	1	1	-
Binks, B. Esq.	10	6	-
Birchall, Edw., Esq.	1	1	-
Bissington, E. Esq.	10	6	-
Boston, Councillor	10	6	-
Bowling John, Esq.	1	1	-
Brigg, Rev. J. E.	10	6	-
Briggs, Riley, Esq.	1	1	-
Brindley, R. P. Esq.	1	1	-
Briscall, Messrs. T. & H.	10	6	-
Broadhead, W. H. Esq.	1	1	-
Brown, W. J. Esq.	2	2	-
Brown, Wm. Wms. & Co., Messrs.	1	1	-
Brown, Hy. Esq.	10	6	-
Buckley and Sons, Messrs.	1	1	-
Buckton, R. & Sons, Messrs.	1	1	-
Carpenter, T. A. Esq.	10	6	-
Chadwick, William, Esq.	10	6	-
Charlesworth, Miss S.	10	6	-
Clift, T. Esq.	10	6	-
Child, W. G. Esq.	-	-	-
Cohen, J. & Josephy, Messrs.	1	1	-
Conyers, J. & Sons	10	6	-
Cooke, Alderman Alf. I.	1	1	-
Cousins, W. J. Esq.	2	9	-
Cowbrough & Co.	10	6	-
Craven, H. Esq.	1	1	-
Dawson, Oswald, Esq.	5	-	-
Dawson, Mrs. Oswald	5	-	-
Dayson, J. O. Esq.	10	6	-

	£.	s.	d.
Demaine, B. & W.	1	1	-
Dixon, J. Esq.	18	6	-
Dodgshun, Isaac, Esq.	10	6	-
Dovenor, Jas. Esq.	1	1	-
Eddison, John, & Sons	1	1	-
Edmondson, T. Esq.	1	1	-
Edwards, J. Viccars, Esq.	1	1	-
Ellina & Sons	10	6	-
Falshaw, Saml., Esq.	5	-	-
Firth, S. Esq.	10	6	-
Fitch, J. J. & Son, Messrs.	1	1	-
Gallsworthy, R. & Son	10	6	-
Garnett, G. & Sons	1	1	-
Gibbs, W. & Co., Messrs.	10	-	-
Gill, Thos. & Sons	1	1	-
Glendinning, T. Esq.	1	1	-
Goodall & Goodick	10	6	-
Goodall, Backhouse & Co.	1	1	-
Green, F. W. Esq.	2	2	-
Greenwood & Batley, Messrs.	1	1	-
Hardy, C. J. Esq.	10	6	-
Hare, J. Esq.	10	6	-
Harper, James, & Sons, Messrs.	1	1	-
Hathorn, Davey & Co., Messrs.	10	6	-
Hebblethwaite Bros.	1	1	-
Hebblethwaite, Rhodes, Esq.	1	1	-
Hepper, John, Esq.	1	1	-
Hird, G. F. Esq.	10	6	-
Hirsch, P. & Josephy, Messrs.	1	1	-
Hollis, Walter, Esq.	10	6	-
Holt & Co.	10	6	-
Horne, Nicholson & Co., Messrs.	10	6	-
Hotham & Whiting, Messrs.	1	1	-
Hudson, Joseph, Esq.	1	1	-
Hudson, Sykes & Bousfield, Messrs.	1	1	-
Hudson, Walt. Esq.	1	1	-
Hudswell, Clark, & Co., Messrs.	10	6	-
Hyam & Co. Messrs.	1	1	-
Illingworth, Ingham & Co., Messrs.	1	1	-
Ingleby, J. Esq.	10	6	-
Jackson, Rt. Hon. W. L., M.P.	2	2	-
Jacksons, Ltd.	10	6	-
Jowitt, R. Benson, Esq.	1	1	-
Kirk, S. and Son, Messrs.	1	1	-
Kitson & Co. Messrs.	2	2	-
Lambert, Miss	10	6	-
Lambert, Wm. Esq.	1	1	-
Lawson, Messrs. S. and Sons	1	-	-
Ledgard, Miss Mary	1	1	-
Leuty, T. K., M.P.	10	6	-
Ludolf, G. A. Esq.	10	6	-
Ludolf, Henry, Esq.	1	1	-
Lupton, A. G. Esq.	10	6	-
Lupton, Henry, Esq.	1	1	-
Mallorie, T. P. & Co., Messrs.	1	1	-
Manning, Wardle & Co., Messrs.	1	1	-
Marcan, M. & Co., Messrs.	10	6	-
March, Geo. Esq.	1	1	-
March, Miss C.	1	1	-
March, Miss	1	1	-
Marsden, H. R. Esq.	1	1	-
Marsh & Co. Messrs.	10	6	-
Marshall & Snelgrove, Messrs.	1	1	-
Marshall, John, Son & Co., Messrs.	1	1	-
McConnell, Messrs. A. and J.	10	6	-
McCorquodale & Co., Ltd.	1	1	-

	£.	s.	d.
McQuat Bros.	-	-	-
Meaby, W. Y. Esq.	1	1	-
Metcalfe, Geo. Esq.	1	1	-
Monteith, Alex. Esq.	-	-	-
Morrell, Geo. & Son, Messrs.	10	6	-
Newby, T. Esq.	10	6	-
Newstead, J. S. Esq.	10	6	-
Nicholson, J. & Sons, Messrs.	1	1	-
Nickols, Harold, Esq.	10	6	-
Nussey, Hargreaves, Esq.	10	6	-
Nussey, T. H. Esq.	1	1	-
Oates, C. G. Esq.	1	1	-
Paterson, H. M. Esq.	1	1	-
Peate, J. J. L. & Co.	-	-	-
Plews, Wm., Esq.	10	6	-
Ragnar, Jno., Esq.	1	1	-
Redmayne, John, Esq.	10	6	-
Reynolds, R. Esq.	1	1	-
Riley, H. W. Esq.	10	6	-
Schofield & Parkinson, Messrs.	1	1	-
Schunck & Co.	1	1	-
Hansbotham, H. R., collected by	1	1	-
Stimpson, Jas. Esq.	10	6	-
Skellon, Miss	1	1	-
Sloan, Wm. Esq.	10	6	-
Smallwood, Mrs.	1	1	-
Smith, Albert, Esq.	1	1	-
Smith & Hutton	10	6	-
Smith, Jno., Wales & Sons, Ltd.	10	6	-
Smithells, Professor	1	1	-
Spark, F. R., Esq.	1	1	-
Stables & Co., Messrs.	1	1	-
Stables, Marshall, Esq.	10	6	-
Stead, Mrs. W.	2	2	-
Stockdale, J. Esq.	10	6	-
Stratten, Rev. Canon	1	1	-
Sutton, Mrs.	1	1	-
Sykes, Wm., Esq.	10	6	-
Tadman, A. Esq.	10	6	-
Tannett, Walker & Co., Messrs.	1	1	-
Taylor, Bro. & Co.	2	2	-
Taylor, Walter, Esq.	2	2	-
Tetley and Sons, Messrs. Joshua	3	3	-
Tetley, Mrs. F. W.	1	1	-
Town and Sons, Messrs. J.	1	1	-
Tweedale, J. Esq.	1	1	-
Upton, T. S. Esq.	10	6	-
Wade, John, Esq.	10	6	-
Wart, Alderman	1	1	-
Walker, Ald.	10	6	-
Watson, J. & Sons, Messrs.	1	1	-
Webb, W. H. Esq.	1	1	-
Wharnciffe, Earl of	1	1	-
Wigram, Ald. R.	10	6	-
Wilkinson, Mrs.	1	1	-
Williamson, Hy.	10	6	-
Wilson, Joshua and Sons, Messrs.	1	1	-
Wilson, Walker, and Co. Messrs.	1	1	-
Wood & Bedford, Messrs.	1	1	-
Wood, T. M. Esq.	10	6	-
Woodhouse, Edw., Esq., J.P.	2	2	-
Yates, W. E. Ltd., Messrs.	2	2	-
Zossenheim, M. Esq.	1	1	-

Total Subs. 153 13 9

Legacy.

Yates, W. E. Esq. (the late) 1000 - -

Total £1153 13 9

MIDDLESBROUGH BRANCH.

President—
Sir JOSEPH W. PEASE, Bart., M.P.

Local Committee—
Sir RAYLON DIXON, J.P., D.L., Chairman.
WILLIAM BULMER, Esq., Collector of H.M. Customs.
JAMES HARRIS, Esq., Capt. F. HOOD.
JOHN M. LENNARD, Esq., J.P.

Honorary Secretary—
JAMES HOGG, Esq.

Annual Subscriptions.

	£.	s.	d.
Bell Bros., Messrs.	2	2	-
Bolckow, Vaughan, & Co.	2	2	-
Constantine, Pickering & Co.	1	1	-
Dixon, Sir R. & Co.	2	2	-
Harris, James, Esq.	1	1	-
Pease, Sir J.W. Bart., M.P.	1	1	-
Samuelson, Sir B. & Co.	2	2	-
Tees Conservancy Commissioners	3	3	-
Walton, Jos.	1	1	-
Wilson, Isaac, Esq.	10	8	-
Total Subs.	£16	5	6

Donations.

Middlesbro' Shipping, per Collector of Customs	65	8	6
Stockton Shipping, per Tees Conservancy Commissioners	13	5	3
Total	£84	19	3

REDCAR BRANCH.

Local Committee—
The MARQUIS OF ZETLAND, President.

THOMAS NELSON, Esq., Chairman.
T. HUGH BELL, Esq., A. O. COCHRANE, Esq., C. J. COLEMAN, Esq., Mr. F. H. COOKE, Lieut.-Col. DAWSON, T. C. DAVISON, Esq., T. HIRST, Esq., DR. MACKINLAY, Capt. TOMLINSON, Mr. WHITE (C.O. Coast-guard).

Honorary Secretary—
J. M. MEER, Esq.

Annual Subscriptions.

Bell Bros. & Co.	2	2	-
Cochrane, A. O. Esq.	-	5	-
Coleman, C. J. Esq.	10	-	-
Cooke, Mr.	-	5	-
Davison, T. C. Esq.	-	5	-
Emerson, E. B. Esq.	10	-	-
Hirst, T.	-	5	-
Jaeger, H. Esq.	-	5	-
Mackinlay, Dr.	-	5	-
Nelson, Thos. Esq.	-	5	-
Tomlinson, Capt.	-	5	-
Total Subs.	£5	2	-

Donations.

	£.	s.	d.
Contribution Boxes	3	17	1
Proceeds of performance on the sands by the Australian Bell-Ringers, and entertainments arranged by the Coxswain and crew on the 21st August	10	-	-
Total	£18	19	1

ROBIN HOOD'S BAY BRANCH.

President—
Sir CHARLES STRICKLAND, Bart.

Local Committee—
J. W. BARRY, Esq., Mr. M. BEDDINGTON, Mr. W. BEDDINGTON, Mr. COOPER, late Coast-guard Officer, Mr. BENJAMIN GRANGER, Capt. GEORGE MEUNELL, Capt. ISAAC MILLS, Capt. JOHN NEWTON, Mr. RANDALL, Coastguard Officer, Capt. KNIGHTLEY SMITH, Capt. STANNYHOP, Capt. JACOB STORM.

Hon. Secretary—
Rev. R. JERMYN COOPER, M.A.

Annual Subscriptions.

	£.	s.	d.
Strickland, Sir Chas. Bart.	3	3	-
Barry, J. W. Esq.	1	1	-
Beddington, Mr. Mal.	1	1	-
Beddington, Mrs.	1	1	-
Blanford, Mrs. R. Jermyn	2	2	-
Cooper, Rev. R.	1	-	-
Granger, Mr. Benj.	2	-	-
Smith, Capt. Knightley	2	-	-
Trebeck, Canon	1	-	-
Total Subs.	£12	8	-

Donations.

Contents of Fish Box	6	19	8
Contents of Life-boat Box	-	1	3
Proceeds of Concert	7	10	3
Total	£26	19	2

RUNSWICK BRANCH.

Patron—
The Most Noble the MARQUIS OF NORMANBY.

President—
Sir C. M. PALMER, Bart., M.P.

Honorary Secretary—
Dr. J. B. LAVERICK.

Annual Subscriptions.

Bruce, Jno. Esq.	-	10	6
Laverick, Dr. J. B.	-	10	6
Palmer, Sir C. M., Bart., M.P.	2	2	-
Total	£3	3	-

SALT BURN BRANCH.

President—
The Most Hon. the MARQUIS OF ZETLAND.

Local Committee—
J. G. SWAN, Esq., J.P., Chairman, A. J. DORMAN, Esq., C.C. EDWARD HARRIS, Esq., Councillor Rev. B. IRVIN, M.A. Mr. W. WILLIAMS, Ex-Chief Officer, Coastguard. Mr. WRATTON, Officer in Charge of Coastguard Station.

Treasurer and Honorary Secretary—
Mr. T. G. PEARSON.

Annual Subscriptions.

	£.	s.	d.
Alexandra Hotel, per Miss Smith	-	10	6
Allison, Mr. W. R.	-	5	-
Anderson, Mr. J. W.	-	10	6
Ayrton, Mrs. Clifford	1	1	-
Bell Bros., Messrs., Middlesbrough	2	2	-
Burnett, Dr. E.	-	10	-
Croft, Mr. F., York	-	10	6
Crothwaite, Mr. D.	1	1	-
Deighton, Mr. T.	-	5	-
Dent, Mr. J. W.	-	5	-
Dorman, Mr. A. J., C.C., Nantborpe	2	2	-
Dorman, Mr. R. P.	1	1	-
Elson, Major T. J. P.	-	10	-
Fleming, Mr. (Interest from Legacy of the late)	6	-	-
Fletcher, Mr. R.	-	5	-
Fleury, Miss	-	10	-
Hamilton, Mr. E. B.	-	10	6
Harris, Mr. Edward	1	1	-
Hayton, Mr. E.	-	5	-
Heslop, Mr. C.	-	5	-
Heslop, Mr. Thomas	-	10	-
Horne, Mr. R., North Skelton	-	10	6
Hornsby, Councillor M.	-	5	-
Hughes, Mr.	-	5	-
P'Anson, Mr. W.	-	5	-
Irvin, Councillor Rev. B., M.A.	1	1	-
Jackson, Mr. G. B.	-	10	-
Jackson, Mr. R. A.	-	5	-
Jones, Councillor J. T.	-	5	-
Jones, Mr. O. C.	-	5	-
Ke nady, Mr. J.	-	5	-
Mackinnon, Mr. T. N.	1	1	-
Melliship, Mrs.	-	5	-
Pearson, Mr. H.	-	10	-
Pearson, T. G.	-	10	6
Pease, Mr. Arthur, M.P.	1	1	-
Pease, the late Mr. H. Fell, M.P.	1	1	-
Pybus, Mrs., Marske	-	10	6
Rapp & Sons, Messrs.	-	10	6
Read, Mr. W.	-	5	-
Rhodes, Dr. G. S., J.P.	-	10	6
Rippon, Mrs.	-	5	-
Simpson, Mr. J. C.	-	5	-
Sisson, Mr. W.	-	5	-
Smith, Mr. W.	-	5	-
Smith, Mr. W. H.	-	5	-
Spink, Captain T.	-	10	6
Spry, Mr. S.	-	5	-
Stackhouse, Mr. H.F.	-	10	6
Stobart, Mrs. Keswick	-	10	6
Swan, Captain J. G., J.P., Upsall Hall	1	1	-
Thubron, Mr. W. A.	-	5	-
Tireman, Col.	-	2	-
Turnbull, Mr. J.	-	5	-

£. s. d.

Turner, His Hon. Judge, J.P.	1	1	-
Walton, Mr. Joseph, J.P.	-	1	-
Westbrook, Mr. W.	-	5	-
Wharton, Mr. W. H. A., J.P., Skelton	5	-	-
Whitwell, Mr. W., J.P.	1	1	-
Wigram, Mr. W. L., Redriff	1	-	-
Wilson, Councillor E. W.	-	10	-
Yeoman, The Ven. Archdeacon, (the late)	1	-	-
Zetland, The Marquis of	5	-	-
Sums under 5s.	2	12	6
Total	£54	19	-

Donations.

Brine Baths Box	-	7	1
Collected at Life-boat Launch by—			
Master Gaunt	-	14	4
Craven	-	14	4
Master George Johnson	-	10	7
Master Claud Robinson	-	7	11
Mr. G. Simpson	1	18	10
Master Albert Spragg	-	5	1
Fines imposed per Mr. T. Tutin, Land Agent, Skelton	-	10	-
Life-boat House Box	1	6	-
Look-out House Pillar Box	-	13	1
Miss Wain's Box	-	9	1
Pillar Box at Tramway	3	0	2
Post Office Box	-	5	4
Proceeds from Entertainment given by Mr. G. Davis and his Troupe of Niggers, June 12th	13	2	6
Zetland Hotel Box	1	7	9
Sums under 5s.	-	7	3
Total Dons.	£25	5	-
Total Subs.	£84	19	-
			£80

SCARBOROUGH BRANCH.

Local Committee—
The Right Hon. The EARL of LONDRESBOROUGH, J. W. EVANS, Esq., BENJAMIN FOWLER, Esq., J.P.

HAWSON HERBERT, Esq., A. E. HICK, Esq., PANTLAND HICK, Esq., J.P., W. S. LISTER, Esq., THOMAS S. POSGATE, Esq., JOSHUA ROWNTREE, Esq., J.P., R. RUDGARD, Esq., W. T. SELLERS, Esq., G. ALDRERSON SMITH, Esq., J.P., Lieut.-Col. STEBLE, J.P., GILBERT WILKINSON, Esq., C. W. WOODALL, Esq., J.P., C. O. COASTGUARD, C.O. CUSTOMS.

Treasurer—
J. W. WOODALL, Esq., J.P.
Honorary Secretaries—
JOHN STEPHENSON, Esq., JAS. H. MACKWOOD, Esq.

Annual Subscriptions.		£.	s.	d.	£.		s.	d.	£.		s.	d.
Allan, Mrs.	5				Sedgwick, Miss.	1			Newton, F. and Sons	1	1	
Austen, Rev. S. G.	5				Stackhouse, Captain	1	1		Osborn, W. F.	10	6	
Barry, W. Esq., J.P.	5				Stackhouse, Mrs.	10			Pickering, K. & Sons	2	2	
Barton, Mrs.	10				Stansfeld, Miss.	1	1		Peace, W. K., J.P.	1	1	
Beeforth, G. L. Esq., J.P.	5				Starkie, Rev. H. A.	1	1		Porter, C. G.	2		
Bentley's Yorkshire Breweries, Ltd.	5				Style, Rev. George.	1	1		Rosell, H. & Co.	1	1	
Bottomley, Miss.	10				Willis, J. J. Esq.	1	1		Stephenson, Sir Hy., J.P.	1	1	
Boyes, Mr. W.	5				Wilson, Mrs.	5			Turton, T. and Sons (Lim.)	1	1	
Bright & Sons, Messrs.	5				Wise, Miss	5			Vickers, Sons, & Co. (Lim.)	2	2	
Brough, Edwin, Esq.	1				Woodall, Chas. W. Esq., J.P.	1	1		Walker and Hall	1	1	
Brough, Mrs.	1				Woodall, J. W. Esq., J.P.	1	1		Watson, John & Sons	1	1	
Burkill, Isaac, Esq.	10				Sums under 5s.	10	5	6	Wightman, Arthur	1	1	
Burkill, J. H. Esq.	5				Total	254	9		Wilks, Mrs. E. J.	1	1	
Burnside, Mrs.	6				Donations.				Wilson, Thomas	1	1	
Chalmers, R. Esq.	10				Collected at a Recltal given by Miss A. Nelson, per W. T. Neighbour, Esq.	1	15		Wood, John, & Sons	1	1	
Clare & Hunt, Messrs.	5				Collected at the North of England Cyclists Meet	16	1	5	Sums under 5s.	5		
Cross, Mrs.	10				Phillips, C. T. Esq.	5			Total	226	12	6
Dale, Jno. Esq.	10				Sums under 5s.	8	5	9	Local Committee—			
Darley, Henry, Esq.	1				Boxes.				President—			
Daniel, Mrs.	1				Balmoral Hotel	15			The Right Hon.			
Demison, G. E. Esq.	10				Blanchard's Hotel	7			The EARL FITZWILLIAM, K.G.			
Dippie, J. Esq., J.P.	5				Cambridge Hotel	5	7		Local Committee—			
Duckworth, Mr. A.	5				George Hotel	1	15	2	B. W. BURGON.			
Duncombe, Hon. Mrs.	1				Life-boat House	17	1	1	THOMAS COLE.			
Fowler, Benj. Esq., J.P.	5				Metropole Hotel	18	8		JAMES DICKSON.			
Godfrey, Dr. F.W.A.	5				Royal Hotel	16	3	4	JAMES DIXON FAWCETT.			
Hebden, Wm. Esq., J.P.	1				South Cliff Pillar Box	2	4	3	G. H. HUNT.			
Herbert, H. Esq.	10				Spa Refreshment				WILLIAM IRONS.			
Hick, A. E. Esq.	5				Rooms	6	7		Sir WILLIAM LENG.			
Hick, M. Esq., J.P.	5				St. Nicholas Cliff Pillar Box	1	5		ROBERT J. NICHOLSON.			
Hick, P. Esq., J.P.	5				Swift's Hotel	3	10		W. F. OSBORN.			
Holroyd, Miss Elizabeth	1				Sums under 5s.	8	8	3	J. NEEDHAM PICKERING.			
Hopper, Mrs. and Misses.	7				SUMMARY.				JOHN SHIPMAN.			
Hugill, Thos. Esq.	1				Total Subs.	54	9		T. E. VICKERS, J.P.			
Irving, Miss	1				Total Dons.	26	7	2	Secretary & Treasurer—			
J. A. C.	10				Total Boxes.	44	15	3	J. B. HALLAM.			
Jackson, Geo. Esq.	1				Total	125	11	5	10, St. James Street.			
Kitson, Mrs.	5				SETTLE BRANCH.				Annual Subscriptions.			
Leigh, Hon. Augusta Mackwood, Jas. H. Esq.	5				(No Local Committee.)				Atkin, E. T.			
Marshall and Snelgrove, Messrs.	10				President—				Beard, Herbert			
Maxwell, Mrs. Eliza	5				WALTER MORRISON, Esq.				Brown, Walter			
Metcalfe, Miss	10				Honorary Secretary—				Burgon, B. W.			
Morgan, Mr. Wm.	5				Captain STACKHOUSE.				Burgon & Co.			
Page, Mrs. H.	5				Annual Subscriptions.				Cadman, T. W.			
Palmer, Mrs.	10				Alcock, Wm. Esq.	1	1		Chadburn Brothers.			
Proctor, Mr. J.	5				Armstrong, W. B. Esq.	10			Chesterman, James and Co. (Lim.)			
Rhodes, Jno. Esq.	1				Batten, Mrs.	1	1		Clegg, J. C.			
Rhodes, J. Esq.	10				Birkbeck, Jos. Esq.	1	1		Cole Brothers.			
Rickaby, Miss.	5				Christie, Hector, Esq.	2	2		Cooke, Wm. & Co. (Lim.)			
Rickett, J. C. Esq., M.P.	3				Clapham, T. R. Esq.	1	1		Corrie, J. B.			
Robinson, Mrs. H.	5				Davis, Mr. T.	5			Creswick, Miss.			
Rowntree, Mr. G.	5				Foster, Miss, Settle	10			Dixon, Jas. and Sons			
Rowntree, Joshua, Esq., J.P.	5				Foster, Miss M. H.	1	1		Earl, H. H.			
Rowntree, J. H. Esq.	5				Grisdale, Miss	5			Elliott, T. C.			
Rowntree, Mr. Councillor J. W.	5				Hammond, J. Esq.	1	1		Firth, Bernard A.			
Rowntree, W. Esq., J.P.	10				Hammond, Miss B.E.	10			Firth, T. and Sons (Lim.)			
Sarony & Co., Messrs. Scarborough Brewery Co. Ltd.	5				Hammond, Mrs.	5			Fisher, R.			
Smirhwaite, Major J. G.	5				Jarry, Misses	5			Fowler, Fredk.			
Smith, Geo. Alderson, Esq., J.P.	10				Morrison, Wm. Esq.	1	1		Fox, S. & Co. (Lim.)			
Stebie, Lieut.-Col. R. F.	1				Pierson, Capt. J. E.	10	6		Gilmour, D. and Co. (Lim.)			
Stephenson, Mr. J.	5				Preston, Mrs. M. H.	1			Hallam, J. B.			
Taylor, W. H. W. Esq.	5				Radcliffe, A. B. St. C. Esq.	5			Hoyland, G. & Son.			
Teale, J. W. Esq., J.P.	5				Sedgwick, Geo. Esq.	10			Hunt, N. H. & Son			
Tugwell, Mr. F.	5								Hutton, W. & Sons (Lim.)			
Thompson, A. and M.	5								Irons, William			
Thompson, Miss	5								Kenyon, John & Co.			
Thompson, Mrs. E.M. Meyssey	5								Kayser, Ellison & Co., Ltd.			
Tindall, Miss Ann.	5								Law, H. B.			
Tindall, Mrs. R. H.	10								Mappin, Sir F. T., Bart., M.P., J.P.			
Tindall, W. S. Esq.	5								Marrian, Thomas & Co. (Lim.)			
Watkins, Miss	5								Marsh Brothers & Co. (Lim.)			
									Martin, Hall, and Co. (Lim.)			
									Merryweather, C. J.			

WAKEFIELD BRANCH.

Honorary Secretary—
ARNOLD S. NICHOLSON, Esq.

Annual Subscriptions.

	£.	s.	d.
Beaumont, H.....	1	1	-
Bolton Major.....	10	6	-
Holdsworth, R.....	2	-	-
Leatham, J. F.....	1	1	-
Leatham, Claude.....	10	-	-
Leatham, S. G.....	1	-	-
Micklethwait, Mrs.	1	-	-
Paintthorp.....	1	-	-
Micklethwaite, Mrs.	1	-	-
S. E.....	5	-	-
Richardson, H.....	10	6	-
Tew, Herbert S.....	2	2	-
Tew, Percy.....	1	-	-
Total.....	£11	-	-

WHITBY AND UP-GANG BRANCHES.

Local Committee—
JNO. WILLIAM BARRY, Esq.
Capt. JNO. FOSTER.
Capt. RICH. FOSTER.
C. HARRISON, Esq.
W. H. MARWOOD, Esq.
Capt. GEO. MILBERN.
Capt. WM. SANDERSON.
Capt. THOS. SMAILES.
Capt. RICH. SMAILES.
Mr. C. STRIK, Chief Officer of Coastguard.
Capt. S. WHARTON.

Honorary Secretary—
Mr. ROBERT GIBSON.

Annual Subscriptions.

Atley, W. H. Esq....	10	-	-
Ansten, Rev. G.....	5	-	-
Barry, Mr. Geo.....	5	-	-
Barry, Mrs. J. H.....	5	-	-
Barry, J. W.....	5	-	-
Baxter, Messrs. H. & Co.....	5	-	-
Beckett, Ernest M.P.....	2	-	-
Booth, Mrs.....	1	-	-
Buchanan and Son.....	10	-	-
Buston, Mrs.....	5	-	-
Chapman, E. W. Esq. 1	-	-	-
Chapman, J. J. Esq. 1	1	-	-
Clarkson, Jas. & Son	5	-	-
Cooke, Miss.....	10	-	-
Corner & Readman, Messrs.....	5	-	-
Corney, Mr.....	5	-	-
Cox, Lady Hawtrey	2	-	-
English, A. Esq.....	5	-	-
Foster, Capt. Jno.....	5	-	-
Foster, Capt. B.....	5	-	-
Frisk, Mr. Jno.....	5	-	-
Gibson, Mr. Robt.....	5	-	-
Graham, Mr. Geo.....	5	-	-
Granger, Dr.....	5	-	-
Gray, W. S. Esq.....	10	-	-
Harrowing, Mr. Robt. 1	1	-	-
Harrowing & Co., Messrs.....	2	2	-
Hayes & Falking-bridge, Messrs.....	5	-	-
Hewson, Miss.....	10	-	-
Horne & Son, Messrs.	5	-	-
Jameson, Miss.....	10	-	-

Jow, John, Esq.....	10	-	-
Langborne, Misses.....	10	-	-
Langdale and Sons.....	5	-	-
Marwood and Sons.....	10	6	-
Maw, Mr. N.....	5	-	-
Milburn, Mr. Geo.....	5	-	-
Moorsom, Miss.....	1	-	-
Nicholson, Mr. J. B.	5	-	-
Pannett, R. E. Esq.....	5	-	-
Pearson, Mr. Thos.....	5	-	-
Proctor, Chas. Esq.....	10	6	-
Rain, Mr. Robt.....	5	-	-
Richardson, C. Esq. 1	1	-	-
Richardson, F. Esq.....	5	-	-
Rowland & Robinson, Messrs.....	1	1	-
Sanderson, Capt. W.....	5	-	-
Sewell, Mr.....	5	-	-
Smailes, Capt. R.....	5	-	-
Smailes, Capt. Thos.....	10	6	-
Smailes Bros., Messrs.	10	-	-
Smailes, G. W.....	10	-	-
Stevenson, Mr. J.....	5	-	-
Stonehouse, Dr.....	5	-	-
Sugden, Miss A.....	10	-	-
Sugden, Miss.....	10	-	-
Tuley, Dr.....	5	-	-
Turnbull and Son.....	10	6	-
Urrahwood, W. Esq.....	5	-	-
Walker, Jno. Chap- man.....	10	6	-
Weighill, S. Esq.....	5	-	-
Wilson, Dr.....	5	-	-
Wilson, Mr. H.....	10	-	-
Wright, Capt. Chas.....	10	-	-
Wright, W. Esq.....	10	-	-
Sums under 5s.....	10	-	-
Total.....	£32	12	6

Donations.

Church and Chapel Collections.....	1	2	10
Collected in Box at new Life-boat House.....	12	5	9
Other Contribution Boxes.....	1	19	7
Other Donations.....	9	3	-
Total Dons.....	24	11	2
Total Subs.....	32	12	6
Total.....	£57	3	8

WITHERNSEA BRANCH.

Local Committee—
W. THORNEY AYRE, Esq.
M. CHEVRETON BROWN, Esq.
PETER ROBSON, Esq.
DR. SPOULLLE.
FRENCH THOMPSON, Esq.

Honorary Secretary—
H. H. AYRE, Esq.

Annual Subscriptions.

Ayre, H. H.....	10	6	-
Ayre, W. T.....	10	-	-
Bailey and Leatham, 1	1	-	-
Bethell, Commander, M.P.....	1	-	-
Bowman, G.....	1	-	-
Broadley, W. H. H. 1	1	-	-
Hawtison, Miss.....	1	-	-
Hutchinson, W.H.H. 1	1	-	-
Jackson, R.....	1	-	-
Sharp, W. S.....	10	-	-
Smith Bros. and Co. 1	1	-	-
Trinity House, Hull 5	5	-	-
Wilson, T., Sons, & Co. 2	2	-	-
York Union Banking Co.....	1	1	-
Total.....	£17	19	6

Donations.

Contribution Boxes.....	1	8	7
Total Dons.....	1	8	7
Total Subs.....	17	19	6
Total.....	£19	8	1

YORK BRANCH.

Local Committee—
The Very Rev. the DEAN OF YORK, Chairman.
JOSEPH AGAR, Esq., J.P.
Miss DIMSDALE.
Miss FAMA MIDDLEWOOD.
Miss ROBINSON.

Treasurer and Honorary Secretary—
DR. DUNHILL.

Annual Subscriptions.

Agar, Joseph, Esq., J.P.....	1	-	-
Backhouse, Mrs.....	10	-	-
Bellerby, John, Esq., P.J.....	10	6	-
Bushell, Henry, Esq.....	10	6	-
Butcher, J. E. Esq., M.P.....	1	1	-
Carr, John P. Esq.....	10	6	-
Carlisle, the Right Hon. the Countess of.....	4	-	-
Carter, Geo. Wm. Esq.....	10	6	-
Carter, Mrs. John.....	10	-	-
Carter, Mrs. E. M. W. P.....	10	6	-
Cattley, Rev. H. T.....	10	-	-
Champney, Mrs.....	10	6	-
Clarkson, Miss Mary.....	10	6	-
Clutton, Wm. J. Esq., J.P.....	1	1	-
Cotton, Mrs. Charlotte.....	5	-	-
Cowling, Henry, Esq.....	5	-	-
Craggs, Miss Helen. 1	1	-	-
Craven, Mrs. M. A. 1	1	-	-
Cressy, Miss.....	10	-	-
Dean of York, The Very Rev.....	1	1	-
Deramore, The Right Hon. Lord.....	5	-	-
Omsdale, Miss Eliz. 1	1	-	-
Dunhill, C. H. Esq., M.D.....	1	1	-
Elleley, Miss.....	1	-	-
Faussett, Rev. Canon A. R. A., D.D.....	1	-	-
Fenwick, Mrs. R. H. 1	1	-	-
Green, F. Lycett, Esq., M.P.H.....	2	10	-
Gutch, Mrs.....	10	-	-
Hill, Edward, Esq.....	1	1	-
Hill, John R. Esq., J.P.....	1	1	-
Hodgson, Jos. Esq. 1	1	-	-
Jalland, W. H. Esq., J.P.....	1	-	-
Jones, Edmund Esq.....	10	6	-
Johnson, Rich. Esq.....	10	-	-
Kitching, Thos. R. Esq.....	1	1	-
Lascelles, the Hon. Mrs. Egremont.....	10	6	-
Leak, Mrs. Wm.....	1	1	6
Leatham, Mrs. Hy. 1	1	-	-
Lindberg, T. H. Esq.....	10	6	-
Lloyd, Mrs. Edward (Lingcroft).....	1	1	-
Lockwood, Sir Frank, Solicitor-General. 1	1	-	-

£. s. d.

MacLagan, The Hon. Mrs.....	1	-	-
Melrose, C. J. Esq.....	1	-	-
Melrose, James, Esq., J.P.....	10	-	-
Middlewood, Miss Emma.....	5	5	-
Monkhouse, T. Esq.....	10	-	-
Morrill, W. W. Esq.....	5	-	-
Nettleton, Mrs.....	10	-	-
Pierson, Mrs. John.....	10	-	-
Pickering, Hy. Ed. Esq.....	10	6	-
Powell, F. F. Esq.....	10	6	-
Procter, J. W. Esq.....	10	6	-
Pronlock, John, Esq., Richardon, Henry Esq., The late, per J. W. Procter.....	1	10	-
Richardson, Mrs. R. 1	1	-	-
Robinson, Jno. P. Esq. 1	1	-	-
Robinson, Miss.....	5	-	-
Rowntree, Jos. Esq. 1	1	-	-
Sellers, Messrs. G. and J. G.....	10	-	-
Shann, Chas. Esq., J.P.....	1	1	-
Shann, Fredk. Esq. 1	1	-	-
Smith, H. H. R. Esq. 1	1	-	-
Spence, Alfred, Esq. 1	1	-	-
Starkey, Capt. Ed. C. 1	1	-	-
Stroughair, Mr. Jam. 10	6	-	-
Taylor, J. F. Esq.....	10	6	-
Tennant, Mrs. Mary 1	1	-	-
Terry, Sir Joseph, J.P.....	10	6	-
Thompson, Geo. S. Esq.....	1	1	-
Thomson, W. T. H. Esq., J.P.....	1	1	-
Thorpe, H. B. Esq. 1	1	-	-
Thorpe, Mrs. Fielden 5	5	-	-
Umpleby, G. W. Esq. 1	1	-	-
Walker, Sir Jas. Bart. 1	1	-	-
Walker, Thos. Esq.....	10	6	-
Walker, Wm. Tomlinson, Esq., J.P.....	1	1	-
Ware, Henry J. Esq.....	10	-	-
Ware, John Tatham, Esq.....	10	6	-
Whitehead, George, Esq., J.P.....	1	1	-
Whythead, T. B. Esq.....	10	6	-
Wilberforce, Mrs. Wm.....	10	6	-
Wood, Mrs. James. 1	1	-	-
Wood, Thos. F. Esq. 1	1	-	-
Wright, Mr. John.....	10	6	-
Wright, Mrs. Sam.....	10	6	-
Yorke, Miss.....	1	-	-
Total.....	£85	1	6

Donations.

Dunhill, Dr.....	5	-	-
Sympathy, by Miss Dimsdale.....	3	3	-
Total Dons.....	8	3	-
Total Subs.....	85	1	6
Total.....	£93	4	6

SCOTLAND.

Aberdeenshire.

ABERDEEN BRANCH.

Patrons—
The Most Noble the MARQUIS OF HUNTLY.
The Right Hon. the EARL OF ABERDEEN.
The Right Hon. the EARL OF KINTORE.
The LORD FORBES.

Local Committee—
The LORD PROVOST OF ABERDEEN, Chairman.
GEORGE ANDERSON, Esq.
THOMAS COCHRANE, Esq.
SIR WILLIAM HENDERSON.
A. P. HOGARTH, Esq.
ALEXANDER WALKER, Esq.
ALEXANDER H. WILSON, Esq.
L. D. DOVE WILSON, Esq., LL.D.
WILLIAM YEATS, Esq.

Treasurer and Hon. Secretary—
ROBERT CUMMING, Esq.

Annual Subscriptions.

	£.	s.	d.
Aberdeen Steam Navigation Company	1	1	-
Aberdeen, New-castle and Hull Steam Company	1	1	-
Adam, Thomas, Esq.	1	1	-
Cochrane, Thos.	10	6	-
Cook, John, & Son	10	6	-
Cook, John, Esq.	5	-	-
Cooper, Patrick	10	-	-
Davidson, George	10	-	-
Hamilton, Miss	5	-	-
Shene House	5	-	-
Henderson, J. & W.	10	6	-
Lestie, W. & Co.	10	6	-
Ludwick, Chas. & Co.	5	-	-
North of Scotland Steam Navigation Company	2	2	-
Rennie, John J. & Sons	10	6	-
Ship Masters' Society	1	-	-
Spence, James, Esq.	5	-	-
Stewart, David, Esq.	1	-	-
Thompson, Geo. & Co.	5	-	-
Walker, Alex. Esq.	10	6	-
Webster, Alex. Esq.	5	-	-
Wilson, A. H. Esq.	1	-	-
Yeats, William, Esq.	1	-	-
Total	£24	15	-

FRASERBURGH BRANCH.

Patron—
The Right Hon. the LORD SALTOUN.

Local Committee—
Rev. H. FYFE.
Rev. M. P. JOHNSTONE.
Captain G. MACKAY.
Wm. MACCONNACHIE.
Lieutenant OSWELL, R.N.
ALEXANDER STEPHEN.
ROBERT TINDALL.
GEORGE WALKER.

Treasurer & Hon. Sec.—
ANDREW TARRAS, Esq.

Annual Subscriptions.

	£.	s.	d.
Fordyce, Mrs.	1	-	-
Fraserburgh Harbour Commissioners	28	15	6
Henderson, W. Esq.	1	1	-
Russel Trust	5	-	-
Saltoun, Rt. Hon. Lord	5	-	-
Trefusis, Hon. Chas. Forbes	2	-	-
Total Subs.	£42	16	6

Donations.

Contribution Boxes.	-	10	6
Total	£43	7	-

NEWBURGH BRANCH.

President—
JOHN H. UDNY, Esq.
Local Committee—
WILLIAM FORBES.
Rev. J. S. LOUTIT.
W. H. LUMSDEN.
General MACKENZIE.
J. G. RAE.
CHARLES RUXTON.
JOHN MUTCH.
Hon. Secretary—
Mr. P. MURRAY.

Annual Subscriptions.

Gordon, H. W.	1	-	-
Lumsden, W. H.	10	-	-
Mackenzie, Gen.	1	-	-
Russel Trust	5	-	-
Turner, Miss	1	-	-
Udny, J. H.	5	-	-
Total Subs.	£13	10	-

Donations.

Cochrane, James E.	1	-	-
Collecting Boxes	-	14	11
Total	£15	4	11

PETERHEAD BRANCH.

Local Committee—
GEORGE BIRNIE.
WILLIAM BIRNIE.
ROBERT CARNEGIE.
ALEXANDER GRAY.
PATRICK JAMIESON.
W. H. LEASK.
JOHN MITCHELL, JUN.
GEORGE OWEN.
J. E. PEARCE.
ALEXANDER SIMPSON.
JAMES WILSON.
THE PROVOST OF THE BURGH.

Honorary Treasurer—
Wm. BAXTER.
Honorary Secretary—
R. GRAY, Esq.

Annual Subscriptions.

Boyd, Wm.	10	6	-
Fraser, David	5	-	-
Gray, R.	10	6	-
J. S.	10	6	-
Martin, David	5	-	-
Morrison, Jas.	5	-	-
Pearce, J. E.	10	6	-
Robertson, Robert	5	-	-
Russels, Misses, Trustees	5	-	-
Sums under 5s.	8	16	-
Total Subs.	£16	18	-

Donations.

	£.	s.	d.
Contribution Boxes.	2	13	3
Peterhead Harbour Trustees, amount collected from Shipping	29	2	-
Total	£48	13	3

PORT ERROLL BRANCH.

Local Committee—

The Right Hon. the Earl of ERROLL, Chairman.
A. BRUCE, Esq., Vice-Chairman.
A. G. DUGUID, Esq., M.D.
JAMES BODDIE.
JOHN SMITH.
FREDERICK DYSON.

Treasurer and Honorary Secretary—
Mr. JOHN COLLINS.

Annual Subscriptions.

Erroll, The Rt. Hon. the Earl of	1	1	-
Brown, Rev. G.	10	-	-
Ross, Rev. Robt.	10	-	-
Russell Trust	5	-	-
Total Subs.	£7	1	-

Donations.

Contribution Boxes.	2	13	-
Total	£9	14	-

WHITELINK BAY BRANCH.

Local Committee—

Rev. DUNCAN MACGREGOR, Chairman.
W. F. CORDNER, Esq.
C. T. GORDON, Esq.

Honorary Secretary—
Rev. DUNCAN MACGREGOR.

Annual Subscriptions.

Carnegie, The Right Hon. Lord	2	-	-
Cordner, W. F. Esq., of Cortea	1	-	-
Russel Trust	5	-	-
Sums under 5s.	1	1	-
Total	£9	1	-

Argyllshire.

CAMPBELLTOWN AND SOUTHDEN (CANTYRE) BRANCH.

Patron—

His Grace the DUKE OF ARGYLL, K.T., V.P.

Local Committee—
Provost MITCHELL, President.
Mr. JAMES BARNES.
Mr. ALEXANDER CAMPBELL.
Mr. JAMES DUNLOP.
C. C. GREENLEES, Esq.
Mr. JAMES LOTHIAN.
Mr. DUNCAN MCCALLUM.
Mr. ANDREW MCCORRINDALE.
Mr. D. W. MACDONALD.
DAVID MCGIBBON, Esq.
Dean of Guild MCKAY.
JOHN MCKERSIE, Esq.
Mr. JAMES MCLEOD.
Ex-Bailie MCQUEEN.
Mr. ALEX. MCSPORRAN.
Bailie MCTAGGART.
DANIEL MCTAGGART, Esq.
Mr. JOHN MUIR.
Ex-Bailie RALSTON.

Joint Hon. Secretaries—
JAMES DONALDSON, Esq.
Rev. C. T. WAKEHAM.

annual Subscriptions.

	£.	s.	d.
Argyll, His Grace the Duke of, K.T., V.P.	5	-	-
Barnes, Mr. James	5	-	-
Campbelltown Harbour Trustees	5	-	-
Colville, David, Esq.	5	-	-
Colville, Duncan, Esq.	1	-	-
Douglas, Mr. Andrew	5	-	-
Dunlop, James, Esq.	5	-	-
Galbraith & Cochrane	5	-	-
Greenlees, C. C. Esq.	10	-	-
Greenlees, Robt. Esq.	10	-	-
Hall, J. M. Esq.	1	-	-
Lothian, Mr. James	5	-	-
Macalister, Major, of Glenbarry	1	-	-
McKinnon, P. Esq., Rosemount	1	-	-
McTaggart, Daniel, Esq.	10	-	-
McTaggart, Bailie	5	-	-
McCallum, Duncan, Esq.	10	-	-
McDonald, Mr. D. W.	5	-	-
McGibbon, David, Esq.	10	-	-
McKay, Dean of Guild	5	-	-
McKersie, John, Esq.	10	-	-
McQueen, Ex-Bailie	5	-	-
McSporran, Mr. Alex.	5	-	-
Mitchell, Provost	7	6	-
Ralston, Ex-Bailie	5	-	-
Stewart, N. B. of Kiel	2	-	-
Wakeham, Rev. C. T.	5	-	-
Total	£22	12	6

Ayrshire

ARDROSSAN BRANCH.

President—
JOHN CRAIG.
Vice-President—
R. L. ALPINE.

Local Committee—
Captain FULLARTON.
E. J. HILL.
THOMAS KIRKHOPE.
D. MCGILL.
JAMES MCISAAC.
JAMES MUTTER.
A. RUSSELL.
THOMAS TAYLOR.
Captain WALTER.
CAPTAIN H. WYLLIE.
CHIEF COASTGUARDSMAN.

Honorary Secretary and
Treasurer—
JOHN EMSLIE.

Annual Subscriptions.

	£.	s.	d.
Eglinton and Winton, The Earl of	15	—	—
Adamson, Rev. R.M.	5	—	—
Allan, Dr.	5	—	—
Allison, John	5	—	—
Alpine, R. L.	5	—	—
Anderson, Bailie	5	—	—
Anderson, William	5	—	—
Ardrossan Ship- building Co.	1	1	—
Arthur & Co.	5	—	—
Arthur, Mrs., of Car- lung & Barchaw.	1	—	—
Bailev, J. L.	5	—	—
Baillie, Mrs.	5	—	—
Baird, Wm and Co.	5	—	—
Ballantine, Mrs., of Ca tiehill & Ash- grove.	1	1	—
Bennett, F. A. P.	5	—	—
Boyd, R. D.	5	—	—
Campbell, Capt., sen.	5	—	—
Campbell, Capt., jun.	15	—	—
Campbell, Jas.	10	—	—
Cochrane, Hon.Thos., M.P.	1	—	—
Cook, James.	5	—	—
Craig, John.	1	—	—
Dunwoodie, R.	5	—	—
Emslie, John.	10	—	—
Finnie, A. and Son.	2	2	—
Fleming, Wm.	5	—	—
Frame, J. J., Anne's Lodge.	10	—	—
Fullarton, Capt.	5	—	—
Guthrie, Alex.	5	—	—
Guthrie, A. & Sons.	5	—	—
Guthrie, Thos.	5	—	—
Harvey, John.	5	—	—
Hay, Mrs., Castlehill.	10	—	—
Hill, E. J.	5	—	—
Hogarth, Hugh.	1	—	—
Hogarth, John, jun.	5	—	—
Hogarth, Miss.	5	—	—
Kirkhope, Thomas.	5	—	—
Knox, R. W., Moor- park.	10	—	—
Laughland, James, jun.	10	—	—
Leask, Thomas.	10	—	—
Logan, John.	5	—	—
Macdonald, Dr.	5	—	—
McCarroll, Peter.	5	—	—
McIsaac, James.	1	—	—
McKenzie, Rev. Wm.	10	—	—
Mutter, James.	1	—	—
Nicol, A.	5	—	—
Nobel's Explosives Company, Limited.	5	5	—
Robertson, John.	5	—	—

	£.	s.	d.
Russell & Fullerton.	1	1	—
Russell, Joseph, of Seafield.	1	—	—
Smith, Provost, Salt- coats.	10	—	—
Tyre, James, & Son.	5	—	—
Vereil, J. B., Kerelaw.	1	—	—
Walter, Capt.	1	—	—
Warner P., of Ardeer.	2	2	—
Wilson, W. M.	5	—	—
Wylie, Captain.	5	—	—
Young, Provost.	5	—	—
Sums under 5s.	1	5	6

Total Subs. £61 3 6

Donations.

Hogarth, John, sen.	5	—	—
Contribution Boxes.	1	4	—

Total. £62 12 6

AYR BRANCH.

Local Committee—
AYR HARBOUR TRUSTEES.
ROBERT DEWAR, Esq., Chair-
man.

Treasurer—
D. J. LOCKHART, Esq.

Joint Honorary Secretaries—
W. POLLOCK, Esq.
W. J. POLLOCK, Esq.

Annual Subscriptions.

Alexander, Maj.-Gen. Sir Claud, Bart.	3	3	—
Arol, Sir Wm., M.P.	1	—	—
Arthur, T. G., Carrick House.	2	—	—
Arthur, James, of Mount Charles.	2	—	—
Baird, J. G. A., M.P.	1	—	—
Baird, W.	2	—	—
Baird, Mrs.	2	—	—
Bell, John.	1	—	—
Coats, George, Belle- isle.	5	—	—
Coats, Jas. Auchen- drane.	5	—	—
Cowan, Hugh.	10	—	—
Dunlop, W. H.	1	—	—
Dykes, Rev. Dr.	10	—	—
Flint & Son, William.	10	—	—
Girdwood, Gavin.	1	—	—
Hamilton, John.	2	—	—
Houldsworth, J. H. Rozelle.	5	—	—
Houldsworth, J. M.	5	—	—
Houldsworth, Wm.	5	—	—
McIlwrath, Cowan & Co.	5	—	—
Neilson, Walter.	1	—	—
Oswald, R. A.	5	—	—
Paton & Sons, James.	1	—	—
Pollok, Mr. & Mrs. of Middleton.	1	—	—
Steele, Ex-Provost.	10	—	—
Templeton and Son, James.	10	—	—
Wyllie, D. & Co.	5	—	—

Total Subs. £54 3 —

Donations.

Contribution Box.	10	7	—
------------------------	----	---	---

Total. £54 13 7

BALLANTRAE BRANCH.

Patron—
JOSEPH CHARLESWORTH,
of Glenapp.

President—
Rev. F. J. WILLIAMSON.

Local Committee—
GEO. McCAIG.
JOHN PHILLIPS.
JAMES WASON.

Honorary Secretary—
H. INGLIS, Esq.

Annual Subscriptions

	£.	s.	d.
Charlesworth Joseph, of Glenapp.	3	3	—
Laggan, Mrs. Oliver.	2	2	—
McConnel, W.	3	3	—
Moore, J. Carrick, Esq.	2	2	—
Stair, The Earl of ...	2	2	—

Total Subs. £12 12 —

Donations.

Contribution Boxes.	18	6	—
--------------------------	----	---	---

Total. £13 10 6

GIRVAN BRANCH.

President—
The Most Hon. the
MARQUIS OF AILSA.

Local Committee—
HUGH H. HUTCHISON, J.P.,
Chairman.
The PROVOST, MAGIST RATES
and BAILIES.
D. ANDREWS.
J. J. M. BLAIR.
M. McCAA.
R. MCGREGOR.
D. McMASTER.
T. G. TAIT.

Treas. and Hon. Sec.—
JAMES SMITH.

Annual Subscriptions.

Ailsa, Marquis of.	5	—	—
Alexander, Sir Claud, Bart.	1	1	—
Andrews, David.	5	—	—
Boyd, Miss.	2	—	—
Hamilton, H.	10	—	—
Hart, Mrs.	5	—	—
Hutchison and McCreath.	5	—	—
McCaa, Matthew.	5	—	—
McConnel, W. Esq.	1	1	—
McKechnie, R. & T.	5	—	—
McMaster, D.	5	—	—
Stair, Lord, K.T.	2	2	—
Tait, T. G.	5	—	—
Young, J. G. K. Esq., of Glendon.	10	—	—
Sums under 5s.	1	13	6

Total Subs. £15 12 6

Donations.

Collected at Exercise 2	12	10	—
-------------------------	----	----	---

Total. £18 5 4

IRVINE BRANCH.

President—
WILLIAM BRECKENRIDGE,
Esq., Provost.

Vice-President—
JOHN PATERSON, Esq., of
Knewhead.

Local Committee—
THE MAGISTRATES OF IRVINE.
MARTIN BOYD, Esq.
ROBERT CAMPBELL.
WM. DOUGALL, Officer of
Customs.

Captain HALL.
MATTHEW JEFFREY, Esq.
ALEX. LONGMUIR, Esq.
R. F. LONGMUIR, Esq.
WILLIAM ORR, Esq.
JAMES PIPE, Esq.
Captain WATSON.
Captain YOUNG.

Honorary Secretary—
JAMES DICKIE, Esq.

Annual Subscriptions.

	£.	s.	d.
Armour, James.	5	—	—
Christie, Wm.	5	—	—
Dickie, James.	10	6	—
Drummond, J.	5	—	—
Finnie, Archd. & Son.	1	—	—
Gas Residual Products Co.	5	—	—
Gilmour, Alexander.	5	—	—
Glasgow, Earl of ...	1	—	—
Hall, Capt.	5	—	—
Harbour Forge Co.	5	—	—
Henderson, Wm. & Co.	1	—	—
Irvine Forge Co.	5	—	—
Laird & Son.	5	—	—
Longmuir, Alex.	10	6	—
Longmuir, J. F. & Co.	5	—	—
Marr, Capt. John.	5	—	—
Mure, Misses.	10	—	—
PATERSON, John, of Knewhead.	10	6	—
Queen's Park U.P. Church Literary Society, Glasgow.	1	1	—
United Alkali Co., Ltd., Irvine Works.	5	—	—
Walker, A. & Co.	5	—	—
Woods, Rev. John.	5	—	—
Wright, M. & Nephew.	5	—	—
Young, Capt.	5	—	—
Sums under 5s.	7	3	—

Total Subs. £17 5 6

Donations.

Contribution Boxes.	10	1	—
--------------------------	----	---	---

Total. £17 15 7

TROON BRANCH.

Local Committee—
ROBERT CARSWELL.
D. COOK.
JAMES GILLIES.
JOHN LOGAN.
ALEX. McCREDIE.
WM. McMILLAN.
JOHN PAIG.
ADAM WOOD.

Honorary Secretary—
JAMES CORRIE, Esq.

Annual Subscriptions

Ailsa Shipbuilding Company.	1	—	—
Alexander, Sir Claud.	1	—	—
Arthur, M.	2	—	—

	£.	s.	d.
Baird, W. & Co.....	2	-	-
Cook, Duncan	10	-	-
Craig, J. & M.	1	-	-
Cunningham, W. S. .	1	-	-
Dickie, Jas.	1	-	-
Finnie, Miss	10	-	-
Fleming, Miss.	5	-	-
Galloway, John	1	-	-
Gillies, James.....	10	-	-
Houldsworth, Sir			
W. H., M.P.	1	-	-
Kirkwood, Rev. J. .	5	-	-
Logan, Jno.	10	-	-
Portland, His Grace			
the Duke of.....	2	2	-
Rowat, J.	5	-	-
Roxburgh, Dr.	5	-	-
Scott, A. C.	5	-	-
Smith, Robt.....	5	-	-
Wood, Adam	1	-	-
Wyllie, Jas.	10	-	-
Total Subs....	£18	3	-

Donations.

Sums under 5s.....	1	10	6
Total	£19	13	6

Banffshire.

BANFF AND MACDUFF BRANCH.

President—
His Grace
THE DUKE OF FIFE, K.T.

Local Committee—
Provost H. MUNRO, Chairman.
JOSEPH BISSET, Esq., Provost of Macduff, Deputy Chairman.

BANFF.
Rev. W. S. BRUCE.
Rev. J. W. GEDDIE.
Capt. Wm. IRONSIDE.
A. F. LESLIE.
JOHN MAHONEY.
ALEX. RAMSAY.
JOHN W. SIMPSON.
THOMAS THOROGOOD

MACDUFF.
ALEX. GEORGE.
Rev. J. GARDNER.
Mr. JEFFREY.
JOHN LESLIE.
P. H. MACPHERSON.
GEORGE MORRISON.
Capt. WILSON.

Treasurer and Hon. Sec.—
ROBERT HARDIE, Esq., National Bank of Scotland, Ltd.

Annual Subscriptions.

	£.	s.	d.
Fife, Duke of.....	10	-	-
Seafield, Dowager			
Countess of	1	-	-
Asher, A. Esq., Q.C., M.P.	1	-	-
Banff Shipping.....	4	7	6
Biset, James, Esq. .	5	-	-
Biset, Provost.....	5	-	-
Campbell, Mrs., Old Cullen	1	-	-
Cumming, Colonel Gordon	1	1	-
Cumming, Geo.	5	-	-
Diggens, Mrs.	5	-	-

	£.	s.	d.
Duff, Thomas Gordon, Esq.	1	-	-
Forbes, Lt.-Col. J. Foster	1	-	-
Garden, F. A. Esq. .	2	2	-
George, Provost ..	5	-	-
Hardie, Robert ..	1	1	-
Harvey, John, Esq.	5	-	-
Ingram, James, Esq.	5	-	-
Leslie, A. F. Esq. .	5	-	-
Lipp, John	5	-	-
Nisbet and Co.....	5	-	-
Robertson, Alex. .	5	-	-
Russell, Trustees of late Misses.....	5	-	-
Strachan, Colonel, Netherwood.....	5	-	-
Watt, Alex. Esq. .	5	-	-
Wedderburn, Sir Wm.	1	-	-
Williamson, Ex-Provost	5	-	-
Sums under 5s.	8	5	-
Total Subs.,	£41	1	6

Donations.

Proceeds of Concert.	1	8	-
Collection Box at Custom House ...	2	8	-
Total.....	£44	17	6

BUCKIE BRANCH.

President—
JOHN P. GORDON, Esq.

Local Committee—
W. R. DUGUID, Esq., M.D., Chairman.
T. J. ANDERSON.
JOHN ANTON.
ROBERT BUCHAN.
The Very Rev. Dean CLAPPERTON.
WM. CLARK.
ALEX. CUPBERT.
JAMES GIBSON.
WM. GEDDES.
MALCOLM GRAY.
W. F. JOHNSTON.
JAMES LOGIE.
JOHN MACDONALD.
Rev. JOHN MACINTOSH.
R. Y. MACKAY.
Capt. MELVILLE.
Rev. ALEX. MILLER.
JAMES MURRAY.
WM. MURRAY, Sea View Rd.
WM. MURRAY, Admiralty St.
Capt. REID.
JOHN SIMPSON.
WM. SIMPSON, M.D.
WM. STEWART.
PETER THAIN.
GEO. THOMSON.
JOHN WEBSTER.
Rev. T. W. H. WHITE.
JOHN WILSON.
Rev. J. B. WOOD.

Honorary Secretary—
JOHN L. McNAUGHTON, Solicitor, Cluny Square.

Donations.

Contribution Boxes. .	2	12	9
Gordon, J. P. Esq. .	2	-	-
Russell's Trust, the Misses.....	5	-	-
Total.....	£9	12	9

Berwickshire.

EYEMOUTH BRANCH.

President—
Colonel MILNE HOME, of Wedderburn.

Local Committee—
GEO. COLLIN (Junior).
GEO. COLLIN (Senior).
THOS. COLLIN (Speedwell).
JAS. DOUGALL (Provost).
JAS. PATERSON (Empress).
ALEX. ROBERTSON (Ballie).
Rt. Hon. LORD TWEEDMOUTH.
JOHN WEATHERHEAD.

Honorary Secretary and Treasurer—
Wm. McDOUGALL, Esq., Commercial Bank.

Annual Subscriptions.

	£.	s.	d.
Balfour, C. B. Esq. .	2	-	-
Haddington, The Earl of	1	-	-
Henderson, Jas. Esq.	5	-	-
Home, Col. Milne .	1	1	-
Home, Earl of	1	-	-
Home, Miss	1	-	-
Hope, Col. Charles..	2	2	-
Hume, J. A. Ross, Esq.	2	-	-
Mack, Jas. S. Esq. .	1	-	-
Tennant, H. J., M.P.	2	2	-
Turnbull, Geo. G. Esq.	1	-	-
Tweedmouth, Rt. Hon. Lord.....	5	-	-
Usher, Andrew, Esq.	1	-	-
Total Subs....	£20	10	-

Donations.

Boat Crews, per Mr. P. Craig— Maggie Jane	5	-	-
Pilgrim	7	-	-
Borders Association in London, The ..	1	1	-
Fogo Church Collection	1	7	7
Total	£23	10	7

Buteshire.

ARRAN BRANCH.

Local Committee—
J. BANNATYNE.
R. LYMPANT, Coastguard Officer.
J. D. MACKINNON.
JOHN McMILLAN.
JOHN B. SWEET.
ALEX. WOOLVY.

Honorary Secretary—
PATRICK MURRAY, Esq.

Annual Subscriptions.

	£.	s.	d.
Murray, Patrick....	10	-	-
Sweet, John B.....	5	-	-
Sums under 5s.....	2	6	-
Total.....	£-17	6	-

Donations.

	£.	s.	d.
Buchanan, Capt.	1	1	-
Buchanan, Mrs.	5	-	-
Burgess, C. T.	5	-	-
Cartwright, W. T. .	5	-	-
Clark, Geo.	10	-	-
Coats, Jas. Jun.	1	-	-
Coats, Miss	10	-	-
Coats, Miss Lily....	10	-	-
Coats, Mrs. M.....	1	-	-
Coats, Sir Thos. Glen Bart	1	-	-
Cochrane, John, U.S.A.	5	-	-
Cooper, Alfred	10	-	-
Corrie Hotel Box....	5	-	-
Cross, Mrs	5	-	-
Dawson, E.	5	-	-
Forster, R. C.	10	-	-
Greenlees, M.	5	-	-
Hamilton, Duchess of	1	-	-
Hamilton, Robert .	5	-	-
"Isle of Arran" Box	10	6	-
J. C.	5	-	-
Jack, Peter	5	-	-
Jamieson, Jas.	5	-	-
Jamieson, Jas. Aduljo	1	-	-
Kennedy, Mrs. D. .	5	-	-
Kildonan Collecting Box	2	10	-
Kildonan Hotel Box	7	4	-
Lamlash Hotel Box.	5	6	-
Lochranza Hotel Box	5	5	-
Macdonald, P.	10	-	-
Macneish, Thos.	5	-	-
McAllister, Dond. .	5	-	-
McBride, A.	5	-	-
McWilliam, Allister	5	-	-
McNeish, D. & Son.	7	6	-
Morrison, Misses .	5	-	-
Naismith	5	-	-
Peat, P. S.	10	-	-
Speirs, G. S.	5	-	-
Steel, J.	5	-	-
Stewart, A.	5	-	-
Wilson, Lady Ida .	10	-	-
Wilson, W.	10	-	-
Woolley, A.	5	-	-
Woolley, Mrs.	5	-	-
Other Boxes and Sums under 5s.....	18	9	6
Total Dons.	£39	6	9
Total Subs.	-17	6	-
Total	£40	4	3

Caithness-shire.

HUNA BRANCH.

President—
Rev. JAMES MACPHERSON.

Local Committee—
Mr. WILLIAM CHEYNE.
Rev. DONALD DAVIDSON.
DR. MACGREGOR.
Mr. JOHN McAULAY.
Mr. ALEXANDER SINGLAIR.
Mr. JAMES TAIT.

Honorary Secretary—
Mr. JOHN SUTHERLAND, Jun.

Annual Subscriptions.

	£.	s.	d.
Davidson, Rev.	5	-	-
Macpherson, Rev. J. .	5	-	-
McAulay, Mr. John .	5	-	-
McGregor, Dr.	5	-	-

Sinclair, Alex.....	5	d.
Tait, Mr. James.....	5	-
Sums under 5s.....	2	6
Contribution Boxes.....	1	4
Total	£1 13	10

THURSO BRANCH.

Local Committee—
 WM. DOHERTY, Esq. (Publisher).
 J. W. GALLOWAY, Esq.
 ALEX. MACDONALD, Esq.
 ALEX. MACKAY, Esq. (Solicitor).
 Surgeon-Colonel MACLEAN.
 Rev. J. S. MILLER.
 JOHN MILLER, Esq., of Scrabster.
 HUGH SINCLAIR, Esq.
 Sir R. C. SINCLAIR, Bart.
 Capt. SINCLAIR, Scrabster.
 WILLIAM SMITH, Esq., Forss.
 Capt. WILLIAMSON.

Honorary Treasurer—
 JAMES BRIMS, Esq.
Honorary Secretary—
 SINCLAIR MACDONALD, Esq.

Annual Subscriptions.

Brims, James, Esq.....	5	-
Brodie, Miss.....	5	-
Docherty, Wm. Esq. (Publisher).....	5	-
Galloway, J. W. Esq.....	5	-
MacDonald, Alex. Esq.....	5	-
Macdonald, Sinclair.....	5	-
Mackay, Alex. Esq. (Solicitor).....	5	-
Maclean, Surg.-Col.....	5	-
McLeod, Wm. Esq.....	1	1
Miller, John, Esq., of Scrabster.....	10	-
Miller, Rev. J. S.....	5	-
Pilkington, Thos. Esq., of Sandside.....	1	-
Portland, His Grace the Duke of.....	5	-
Scott, Lady John, of Spottiswood.....	1	-
Sinclair, Captain D.....	5	-
Sinclair, Hugh, Esq.....	5	-
Sinclair, Sir B. C. Bt.....	1	-
Smith, Wm., Forss.....	5	-
Threipland, J. W. Esq., of Fingask, &c.....	1	-
Williamson, Capt. D.....	5	-
Total	£13	16

Donations.

Contribution Boxes—	
Royal Hotel.....	16 7
Thurso Industrial Co-operative Society, Ltd.....	1 - -
Sums under 5s.....	- 3
Total Dons.....	1 16 10
Total Subs.....	13 16 -
£15 12 10	

WICK & ACKERGILL BRANCH.

President—
 His Grace the DUKE OF PORTLAND.

Local Committee—
 Major HENDERSON, Chairman.
 JAS. FERRIER.
 ALEXANDER GEDDES, Esq.
 S. S. GOUDIE.
 ELLIS HUGHES.
 F. H. MACHUGH.
 Provost NICHOLSON.
 Capt. PATERSON.
 JOHN ROBERTSON.
 ROBERT ROBERTSON.
 GEORGE SINCLAIR.
 HECTOR SUTHERLAND.
 Chief Officer TREELING, R.N.R.
 Provost JOHN WILSON.

Hon. Treasurer—
 GEORGE JAMIESON, Esq.

Hon. Secretary—
 HECTOR SUTHERLAND, Esq.

Annual Subscriptions.

Adam, Mr. Thomas.....	5	-
Anstruther, Sir Ralph.....	1	1
Banks, Dr. G.....	5	-
Barry, F. T. Esq., M.P.....	2	2
Bulk, J. H. & Co.....	5	-
Davidson, Mr. Wm., Grocer.....	5	-
Clyne, Mr. W.....	5	-
Crawford, Mr. A. O.....	5	-
Duncan, Mr. J. G.....	7	6
Farquharson, Mr. W.....	5	-
Friend, A.....	10	-
Geddes, Mr. A.....	10	-
Georgeson, Mr. D. W.....	5	-
Gow, Mrs. H.....	5	-
Henderson, Mr. A. W.....	10	-
Henderson, Mr. J. H. I.....	10	-
Jamieson, Mr. Geo.....	7	6
Mackenzie, Sheriff.....	5	-
Nicolson, Provost.....	10	-
Portland, His Grace the Duke of.....	5	-
Rae, Mr. Alex.....	5	-
Robertson, Mr. Robt.....	5	-
Robertson, Rev. N. C.....	5	-
Rosa, Mr. Daniel.....	5	-
Simpson, Mr. D. B.....	5	-
Sinclair, Mr. A., Auctioneer.....	5	-
Sinclair, Mr. G. Ship-chandler.....	5	-
Smith, Mr. W. Pater-son.....	5	-
Sutherland, Mr. D.....	5	-
Sutherland, H. & Green, Messrs.....	10	-
Thoms, Sheriff.....	1	-
Usher, J. Esq., of Norton.....	1	-
Sums under 5s.....	2	8 6
Total Subs.....	£21	11 6

Donations.

Contribution Boxes.....	5	4	11
Proceeds of Life-boat Demonstration on New Year's Day, 1896.....	24	14	5
Wick and Palleney Harbour Trustees' Net Collection from vessels and boats.....	15	-	-
Total	£66	10	10

Clackmannanshire

ALLOA BRANCH.

Local Committee—
 W. J. HAIG, Esq.
 The Right Hon. the Earl of MAR AND KELLIE.
 ARCHIBALD MOIR, Esq.
 J. THOMSON PATON, Esq.
 Messrs. G. YOUNGER & SON.

Honorary Secretary—
 J. W. MOIR, Esq.

Collector—
 Mr. WILLIAM BROWN.

Annual Subscriptions.

Alloa Coal Company.....	1	1
Alloa Shipping and Towing Co.....	5	-
Archibald, R. and Son.....	1	1
Archibald, J. & R.....	1	1
Balfour of Burleigh, The Rt. Hon. Lord.....	1	1
Balfour, James.....	1	-
Calder, James & Co.....	1	-
Carmichael, R. & Sons.....	2	-
Duncanson, Miss.....	5	-
Dunn, Bros. & Co.....	5	-
Fischer, Morten, & Co.....	5	-
Gentle, Alex. Esq.....	5	-
Gillespie & Nicol.....	5	-
Haig, W. J.....	1	-
Knox, Robert, Esq.....	1	-
Mar and Kellie, The Rt. Hon. the Earl of.....	1	-
Mitchell, Messrs. A. and A.....	2	-
Moir, Archibald, Esq.....	1	-
Moubray, J. J. Esq.....	1	-
Faton, J. Son & Co.....	3	3
Faton, Miss Forrester.....	2	2
Porteous, Jas. & Co.....	10	6
Thomson, Bros.....	1	1
Weir, James A., Ltd.....	1	-
Wingate, Miss.....	1	-
Younger, Geo. and Son, Messrs.....	1	1
Sums under 5s.....	7	6
Total.....	£27	5 -

Edinburgh.

EDINBURGH, LEITH AND GRANTON BRANCH.

Local Committee—
 EDWARD L. I. BLYTH, Esq.
 Sir THOMAS J. BOYD.
 W. F. BUENLEY, Esq.
 Lieut.-Colonel DAVIDSON, H.E.I.C.S.
 Admiral HAY.
 JOHN HOWKINS, Esq.

Honorary Secretary and Treasurer—
 ROBERT SINCLAIR, Esq.

Annual Subscriptions.

Abercrombie, Misses.....	10	-
Agnew, Capt., R.N.....	10	-
Aitchison, Messrs.....	10	-
John and Co.....	10	-

Aitken, Gray, and Co. Messrs.....	10	6
Aitken, Jas. & Co. Messrs.....	5	-
Aitken and Wright, Messrs.....	5	-
Allan, Mrs.....	5	-
Anderson, Mrs.....	5	-
Anderson, Mrs.....	5	-
Anderson & Co., Messrs.....	5	-
Arbuthnot, Mrs.....	5	-
Austin, Mrs.....	5	-
Bain, W. Esq.....	5	-
Baird, Lady.....	1	-
Balfour, Mrs. Alex.....	5	-
Balfour, G. W. Esq.....	1	1
Balfour, Hon. Mrs.....	5	-
Balfour, A. Esq., M.D.....	5	-
Ballantyne, Hanson, and Co., Messrs.....	5	-
Barbour, A. H. F. Esq., M.D.....	1	-
Barclay, Mrs.....	5	-
Barhill, Mrs.....	5	-
Barret, Mrs.....	5	-
Bayley, G. Esq.....	5	-
Beattie and Sons, Messrs. W.....	5	-
Beilby, J. H. Esq.....	1	-
Bell, Kannie, and Co. Messrs.....	10	-
Bell, W. Esq.....	5	-
Bell, Miss A. M.....	5	-
Bell, Mrs. Glassford.....	1	-
Bell, Mrs. Fitzroy.....	10	-
Bernard and Co., Messrs.....	10	6
Bernard, Messrs. T. and J.....	10	-
Berry, Mrs.....	5	-
Bertram & Sons, Messrs. James.....	5	-
Bertram & Co., Messrs. John A.....	10	-
Berwick, Mrs.....	5	-
Beveridge, Misses.....	1	-
Bickerton, George.....	10	-
Black, C. B. Esq.....	1	-
Blackhall Brothers, Messrs.....	10	-
Blackwood, Mrs.....	5	-
Blackwood, The Misses.....	5	-
Blythe, E. L. I. Esq.....	5	-
Bogie, Alex. Esq.....	5	-
Bow, R. H. Esq.....	1	-
Boyd, Sir Thomas J.....	1	1
Bramwell, Byrom, Esq., M.D.....	5	-
Brenner, Mrs.....	5	-
Brodie, Hamilton, and Co., Messrs.....	5	-
Brodie, Mrs.....	5	-
Brotchie, Messrs. K. & Co.....	5	-
Brown, Mrs. Cruz.....	5	-
Brown, Miss, of Lanfine.....	10	-
Brown, Mrs.....	1	-
Bruce, Boyd, and Co., Messrs.....	1	1
Bruce, Miss.....	10	-
Bruce, Miss.....	5	-
Bucher & Co. Messrs.....	5	-
Burgee, Mrs.....	5	-
Caledonian Distillery Callender, David Esq.....	1	1
Campbell, D. Esq.....	10	-
Carstairs & Robertson, Messrs.....	5	-
Cathcart, Mrs.....	10	-
Chambers, Messrs. W. and R.....	2	2
Chapman, Mrs.....	5	-
Chiene, Mrs.....	5	-
Christie and Kilpatrick, Messrs.....	5	-
Christie & Son, J., Messrs.....	5	-
Christie, Miss.....	10	-

£. s. d.	£. s. d.	£. s. d.
Scott, Messrs. John M. & Co. 10 6	Walker, Messrs. G. and J. 10 -	Dunn, Miss Mary, the late, Trustees of 100 - -
Scott, Arch. Esq. 5 -	Walker, James, Esq. of Dalry 1 - -	Paton, Mr. the late, of Crailing, £10 less duty 9 - -
Shand, Mrs. 5 -	Walker, Mrs. 5 -	Total Legs. £197 3 7
Sibbald, Mrs. 5 -	Wardlaw, David, Esq. W.S. 5 -	Total Dons. 32 4 4
Sim, F. R. Esq. 5 -	Warrack, Messrs. John and Co. 1 1	Total Subs. 258 - -
Simpson, Mrs. 1 -	Waterson and Sons, Messrs. 5 -	£487 7 11
Simson, D. J. Esq. 5 -	Watson, Misses 1 -	
Simson, Mrs. 5 -	Watt, A. A. Esq. 5 -	
Sinclair, R. 10 -	Wauchope, Moodie, and Hope, Messrs. 1 1	
Singer Machine Manufacturing Co. 5 -	Webster, Mrs. 5 -	
Slimon, Messrs. R. and D. 5 -	Wenley, Jas. A. Esq. 1 -	
Smith, Messrs. A. and M. 5 -	White, Burns, & Co., Messrs. 10 -	
Smith, Messrs. T. and H. 5 -	White, John, Esq. 5 -	
Smith, Messrs. John & Son 10 6	White, Moir, & Co., Messrs. 5 -	
Smith, Maj.-Gen. T. N. 10 -	Whyte, Messrs. R. & Co. 5 -	
Smith, Miss Ramsay 1 -	Whytt, William, Esq. 10 -	
Smith, Mrs. W. A. 5 -	Wight & Co., Messrs. 5 -	
Somerville, Messrs. John and Co. 10 6	Williams, J. D. Esq. 5 -	
Somerville, Miss 5 -	Wilson, Mrs. 5 -	
Sommerville, Mrs. 5 -	Wilson, Mrs. 1 -	
Sprague, Mrs. 5 -	Wingate, Miss 2 -	
Steel, Coulston, & Co. Messrs. 5 -	Wingate, Wm. E. Fenton, Esq. 1 -	
Stevenson & Co., Messrs. D. M. 3 3	Wisbart, Messrs. D. and Sons 10 6	
Stevenson, Miss 10 -	Wisbart, Messrs. D. F. & Co. 10 6	
Stewart, Chas. Esq. 5 -	W. M., National Bank 5 -	
Stewart, Charles, Esq., W.S. 5 -	Wood, Mrs. 10 6	
Stewart, Mrs. Thornhill 5 -	Wood, Misses 5 -	
Stewart, Sir T. Grainger, M.D. 5 -	Wood, J. P. Esq. 1 -	
Stratton, Messrs. J. and G. 10 -	Wright, Messrs. P. and R. 5 -	
Stuart, R. L. Esq. 1 -	Wright, Miss Guthrie 5 -	
Swan, Messrs. J. & Son f -	Wright, Mrs. 5 -	
Sym, Mrs. 10 -	Young, Mrs. 1 -	
Sym, W. Melvill, Esq. 5 -	Young, J. W. Esq. 1 -	
Symington, Messrs. T. & Co. 10 -	Younger, Robert, Esq. 10 -	
Taylor, M'Leod, and Co., Messrs. 5 -	Younger, Messrs. W. & Co. 2 2	
Thomson, Messrs. D. J. and Co. 10 6	Sums under 5s. 21 4 -	
Thomson, Messrs. J. G. and Co. 10 -	Total £258 - -	
Thomson, Messrs. R. H. and Co. 10 6		
Thomson, Messrs. W. and Co. 10 6		
Thomson, Mrs. 5 -		
Thomson, S. C. Esq. 5 -		
Thomson, Mrs. 5 -		
Tod Broa, Messrs. 5 -		
Tod, Henry, Esq., W.S. 5 -		
Tod, Robert, Esq. 10 6		
Torrie, Mrs. 5 -		
Torry, John, Esq. 5 -		
Trail, A. A. 10 -		
Trinity House, The. 5 5		
Froster, Courts, Esq. 1 -		
Turnbull and Wilson, Messrs. 5 -		
Turnbull, Miss 10 -		
Turnbull, Mr. & Mrs. A. H. 1 -		
Tyler, G. M. Fraser, Esq. 1 -		
Tyler, Jas. W. Esq., of Woodhouse-elee. 10 -		
Underhill, Chas. E. Esq. 10 -		
Ure, Mrs. A. 5 -		
Urmston, Mrs. 1 -		
Usher, Messrs. Andrew & Co. 1 1		
Usher, Messrs. J. and T. 2 2		
Waddell, Mrs. Peddie 5 -		
Waddie & Co. Messrs. 5 -		
Waddielove, Miss 10 -		
Walls, Miss. 5 -		

CLACKMANNANSHIRE.

LOSSIEMOUTH BRANCH.

Local Committee—
 Capt. J. B. DUNBAR BRANDEE,
 of Pitgavenny, Chairman.
 — BRANDER.
 — BURK, R.N.
 ALEX. COWIE.
 CHARLES A. HAY.
 J. C. PETERKIN.
 GEORGE SMITH.

Honorary Secretary—
 Capt. A. COULL.

Annual Subscriptions.

£. s. d.
Adam, A. 5 -
Adam, John 5 -
Allan James 5 -
Bennett, James 5 -
Brander, Dr. 5 -
Brander, Provost 5 -
Christie, James 5 -
Cooper, Miss 10 -
Coull, Capt. 5 -
Cowie, Alex. 5 -
Cumming, Sir W. Gordon, 2 2
Dunbar, of Pitgavenny 2 -
Dunbar, Capt. J. B. 5 -
Dunlop, J. W. 5 -
Fife, Duke of, K.G. 1 1
Gall, Wm. 5 -
Glennie, J. Hay 5 -
Gordon, Mrs. J. L. 5 -
Gordon and McBay 5 -
Grant, Provost 5 -
Grant, Sir G. M'Pherson 1 1
Hay, Charles A. 5 -
Hay, James 5 -
Hutcheon, J. 5 -
Johnston, James 5 -
King, Wm. 5 -
Knuz, Dr. 5 -
Leishman, Rev. M. 5 -
M'Kay, H. M. S. 5 -
McIntyre, John 5 -
Maitland, Miss 1 -
Peterkin, J. C. 5 -
Richardson & Gordon, Duke of 1 1
Smith, George 5 -
Stewart and Forsyth 5 -
Walker, R. 5 -
Webster, James 5 -
Young, W. C. 5 -
Young, John 5 -
Sum- under 5s. 9 10 6
Total Subs. £26 7 6

Donations.

Gordon, J. E., M.P. 4 4 -
 Ships entering Harbour 6 1 -
 Contribution Boxes. 1 1 5
 Total £37 13 11

MUSSELBURGH BRANCH.

Honorary Treasurer and Secretary—
 JOHN RAMSAY, Esq.

Collector—
 MR. GEORGE WISHART.

Annual Subscriptions.

A. B. M. 5 -
Aitchison, Col. 5 -
Alexander, W. L. Esq. 10 -
Almond, Mr. H. H. 10 -
Banks, Miss 5 -
Caird, Mr. Alexander 5 -
Carse, Thos. & Co., Messrs. 5 -
Dalrymple, Sir Charles, Bart., M.P. 5 -
Deans and Moore 5 -
Elphinstone, The Right Hon. Lord. 1 -
Hope, Lady 1 -
Innes, Mr. A. 5 -
Inveresk Paper Co. 1 -
Legat, The Misses. 5 -
Millar, Mrs., Spring Bank 5 -
Mitchell, Mrs. 5 -
Mitchell, Mr. A. 5 -
Mitchell, T. B. Esq. 5 -
Ramsay, Mr. John 10 -
Stuart, Messrs. J. & W. J. 1 -
Whitelaw, Messrs. Wm. and Son 6 -
Wilkie, J. and A. 5 -
Contributions under 5s. 6 15 6
Total £16 1 6

Donations.

A Friend 5 -
 "Anonymous" 10 -
 Broxburn U. P. Church Senior Bible Class, per Mr. Woodrow 1 10 -
 Contribution Box in Messrs. George Gibson & Co's s.s. "Britannia" 13 11 -
 Cran & Co, Messrs. John, The workmen of 3 - -
 Cunningham, John, Esq. 5 - -
 Evans, Miss Mabel. 2 - -
 Evans, Mrs. 3 - -
 H. L. R. A sailor's daughter. 10 -
 Senior Bible Class, U. P. Church, Denny, per Rev. D. C. Mackellar ... 18 3 -
 Usher, Robert, Esq. 10 - -
 Sums under 5s. 2 2 -
 £32 4 4

Legacies.

Beatson, Mrs., the late, balance of legacy by, and interest thereon. 88 3 7

Life Society.

ANSTRUTHER BRANCH.

Local Committee—
Provost ANDERSON, Ex-officio
Chairman.

ALEXANDER BLACK.
WM. S. BONTHRON.
THOMAS CUNNINGHAM.
Baillie GEORGE JARVIS, An-
struther.

Dr. FERGUSON.
MARTIN GARDNER.
WILLIAM LYALL.
Provost MARTIN, Cellar-
dyke.

PETER MUIR.
JAMES PRATT.
WM. ROBERTSON.
J. ROSE.
WILLIAM RUSSELL.
Baillie PETER THOMSON,
Cellardyke.
ROBERT G. THOMSON.
Dr. WILSON.

Honorary Treasurer—
HENRY WATSON, Esq.

Honorary Secretaries—
H. B. MACKINTOSH, Esq.
A. C. MACKINTOSH, Esq.

Annual Subscriptions.

	£.	s.	d.
Anstruther, Sir			
Ralph, Bart.	1	-	-
Anstruther, H. T.			
Esq., M.P.	10	-	-
Darshi, Mrs. G., Senr.	10	-	-
Darshi, J. R. Esq.	1	1	-
Darshi, George, Esq.	10	-	-
Fowler, G. S. Esq.	1	-	-
Irvine, W. D. Esq.	10	-	-
Mackintosh, H. B. Esq.	10	-	-
Olliphant, Wm.	5	-	-
Sea Box Society of			
Anstruther	1	1	-
Williamson, John,			
Esq., Liverpool	1	-	-
Sums under 5s.	1	6	-
Total Subs.	£9	3	-

Donations.

Contribution Boxes	1	-	-
Collection made at			
"Lifeboat Sun-			
day" Service held			
in Town Hall,			
Anstruther, on			
16th February	19	1	1
Total	£29	4	1

CRAIL BRANCH.

Local Committee—
Ex-Provost PEATTIE, Chair-
man.

PHILANDER CAWTHORN.
JOHN CRAWFORD.
JOHN DUNCAN.
HARRY ERSKINE.
DAVID GAY.
JOHN GUTHRIE.
DAVID MATHEWSON.
Rev. JOHN REID.
WILLIAM ROGER.
JOHN SCOTT.
Provost GEORGE SIM.

Honorary Secretary—
DAVID MORTON.

Annual Subscriptions.

	£.	s.	d.
Calrns, D.	1	-	-
Cawthorn, Philander	5	-	-
Duncan, John K.	5	-	-
Erskine, Sir T., Bart.	5	-	-
Gay, David	5	-	-
Peattie, Provost	5	-	-
Reid, Mrs. Woodville	1	-	-
Reid, Rev. J.	5	-	-
Total Subs.	£8	5	-

Donations.

Contribution Boxes	1	19	10
Total	£10	4	10

DUNFERMLINE BRANCH.

President—
EX-PROVOST ALEXANDER.

Local Committee—
ERSKINE BEVERIDGE.
WILLIAM MATHEWSON.
JAMES MCFARLANE.
GEORGE REID.
WILLIAM ROBERTSON.

Honorary Secretary

(No List for 1896.)

ST. ANDREWS BRANCH.

Local Committee—
J. RITCHIE WELCH, Chair-
man.

PROVOST MCGREGOR.
JAMES BROWN.
LIEUT. MAITLAND-DOUGALL.
JAMES MACCOLM.
GEORGE MURRAY.
JOHN PURVIS.
WILLIAM WOODCOCK.

Honorary Treasurer—
JAS. GEO. JOHNSTONE.

Honorary Secretary—
ANDREW BALSILLIE.

Annual Subscriptions.

Aitken, Miss	5	-	-
Aitken, Miss G. G.	5	-	-
Allen, Mrs.	5	-	-
Bennet, J. Lindsay	1	-	-
Blackwell, Mrs.	5	-	-
Boothby, Col.	5	-	-
Brown, Miss	5	-	-
Burn, F. R.	5	-	-
Burn, Mrs.	1	-	-
Bute, The Marquess			
of	2	-	-
Campbell, Mrs. Mac-			
leod	5	-	-
Carnegie, D. Lindsay	1	-	-
Cheape, James	5	-	-
Cook, J. H. W.	5	-	-
Cunningham, A. R.	5	-	-
Donaldson, Principal	5	-	-
Duff, Walter W.	5	-	-
E. B.	5	-	-
Farmer, Mrs.	5	-	-
Friend	5	-	-
Grace, Stuart	10	-	-
Grant, Miss	10	-	-
Gray, Miss	5	-	-
Henderson, A. E.	5	-	-
Honey, Mrs. Murray	5	-	-

How, Major	5	-	-
Hull, R. A.	5	-	-
Inglis, J. T.	5	-	-
Kay, Wm.	5	-	-
Jackson, Capt. E. J.	5	-	-
Jackson, Capt. G. H.	1	-	-
Johnstone, J. G.	5	-	-
L. M. D.	10	-	-
Lang, Andrew	1	-	-
Lewis, Miss	5	-	-
Logan, W.	5	-	-
Luke, Miss	5	-	-
Maitland - Dougall,			
Mrs.	5	-	-
Maitland, H.	10	-	-
Macklanon, D.	3	-	-
McGowan, Capt.	5	-	-
McGregor, Mrs.	5	-	-
McIntosh, Professor.	5	-	-
Meldrum, Miss.	5	-	-
Mitchell, R.	5	-	-
Moir, Dr.	5	-	-
Morr, Dr. John W.	5	-	-
Natorp, Miss de	5	-	-
Norman, G. C.	5	-	-
Olliphant, T. T.	0	-	-
Orr-Ewing, Mrs.	1	-	-
Paterson, Dr.	5	-	-
Playfair, General.	10	-	-
Purdie, Professor.	5	-	-
Purvis, John	10	-	-
Robertson, Thomas.	10	-	-
Rodger, Rev. Dr.	5	-	-
Rusack, Wm.	5	-	-
St. Salvator's school	1	4	6
Sandys, Miss.	5	-	-
Sprot, Major	5	-	-
Stirling, Mrs.	5	-	-
Story, Miss E. P.	5	-	-
Thoms, Miss	5	-	-
Thomson, Colonel.	5	-	-
Thomson, Mrs. Hill.	5	-	-
Welch, J. Ritchie	1	-	-
Wilson, Miss.	5	-	-
Wyld, B. C.	5	-	-
Sums under 5s.	13	11	9
Total	£43	11	3

Life Society.

ARBROATH BRANCH.

Patron—
Rt. Hon. The EARL OF
NORTHESK.

Local Committee—
COLIN GRANT, Esq., J.P.,
Provost of Arbroath, Chair-
man.

Hon. F. J. BRUCE.
JAMES CARLES.
WILLIAM CARROLL.
CHAS. W. CORSAR, J.P.
DAVID CORSAR, J.P.
Capt. JOSEPH FERGUSON.
Col. WM. A. GORDON.
Capt. JAMES HENDERSON.
GEORGE KEITH, J.P.
ANDREW LOWSON, J.P.
JAMES MUIR, J.P.
Capt. DAVID PATTERSON.
Capt. WM. SMITH.
GEO. THORNTON, J.P.
JAMES WILLOCKS.

Honorary Secretary—
NORMAN MCBAIN, Solicitor.

Annual Subscriptions.

	£.	s.	d.
Aitken, Samuel	5	-	-
Alexander, Wm.	5	-	-
Anderson, A. D.	5	-	-
Arbroath Friendly			
Coal Society	1	1	-
Arbroath High Street			
Co-operative Socy.	2	2	-
Arbroath Westport			
Association	2	2	-
Bruce, Hon. F. J.	1	-	-
Carnegie, H. F. Lind-			
sey	10	-	-
Carnegie, Hon. Ian.	10	-	-
Chapel, David	5	-	-
Corsar, Chas. W.	10	-	-
Corsar, David, The			
Elms	10	-	-
Corsar, D. Jun.	5	-	-
Cuthbert, Jas.	5	-	-
Dickson, Jas. A.	10	-	-
Duncan, John	10	-	-
Fairweather, S.	5	-	-
Ferguson, J. A.	5	-	-
Fletcher, F. C.	1	-	-
Gordon, A.	10	-	-
Grant, Colin	10	-	-
Jamieson, J.	5	-	-
Kydd, James	10	-	-
Lowson, Andrew	10	-	-
Macdonald, W. K.	10	-	-
Milu, George	5	-	-
Muir, James	10	-	-
Northesk Earl of	2	-	-
Northesk Countess of	1	1	-
Ogg, Wm. A.	5	-	-
Salmund, Jos.	5	-	-
Webster, F. & Sons	10	-	-
Webster, W. & Co.	10	-	-
Sums under 5s.	7	14	-
Total	£28	-	-

Donations.

A Lady's Work	4	10	6
Anderson, Miss Mary			
Isabel, per Miss			
Anderson	2	6	-
Anonymous	1	-	-
Collected at Shore			
Dues Office	4	13	6
Contribution Boxes	11	1	-
Share Charity Demon-			
stration Fund	18	14	6
Henderson, A. Duff,			
per Miss Anderson	1	-	-
Inverkeilor Parish			
Church	1	15	-
Total Dons.	£32	7	1
Total Subs.	£28	-	-

£60 7 1

DUNDEE BRANCH.

Local Committee—
Sir JOHN GILLY WAGLEISH,
Bart. Chairman.

G. L. ALISON.
DAVID BRUCE.
CAPTAIN JAMES CAPTON.
Baillie KIDD.
JAMES W. KIDD.
JAMES MUIR.
Capt. JOHN P. NEWTON.
Capt. GEORGE ROLLO.
R. V. SCROGGIE.
Capt. ALEXANDER WOOD.
Capt. CHARLES YULE.

Hon. Treasurer—
JAMES NICOLL, Esq.

Honorary Secretary—
JAMES HUNTER, Jun., Esq.

Annual Subscriptions.		£.	s.	d.
Anderson, A.	1	1		
Armitstead, Geo.	5	5		
Barrie, Charles	1			
Bell, Thos. & Sons.	2	2		
Carmichael, James.	1			
Carmichael, Jas. & Co.	2	2		
Couper, John	1			
Cox Brothers, Ltd.	5			
Dalgleish, Sir W. O., Bart.	5	5		
Dalgleish, Lady	1	1		
Don Bros., Buist and Co.	1	1		
Dundee Harbour Trustees	10	10		
Dundee Loch Line Shipping Co.	2	2		
Dundee, Perth, and London Shipping Company.	5	5		
Gibson, Robertson, & Co.	1	1		
Gilroy, Alex.	1			
Gilroy, Sons, and Co.	1	1		
Grimond (Ld.), J. & A. D.	1	1		
Gourlay Bros. & Co.	2	2		
Guthrie, James.	10			
Henderson, Alex.	2	2		
Henderson, H.	1			
Henderson, J.	1			
Leng, Sir John	10	6		
Low, James F.	1	1		
Low, S. M.	1	1		
Maitland, E. F.	1	1		
Maitland, Thos.	1	1		
McGavin, R.	1	1		
Mitchell, James	5			
Moncur, A. H.	1	1		
Mudie, R. A. & Sons.	2	2		
Myles, David	1	1		
Nairn & Co., B. L.	10	6		
Ogilvie, Sir R. (2 years)	1			
Scott, Mrs. William	10			
Thornton, Sir T.	1	1		
Walker, H. & Sons.	2	2		
Weinberg, I. J.	1	1		
Total Subs.	£71	4		

Donations.		£.	s.	d.
London, s.s., collection, per Capt. Speedy	1			
Sharp, John, Esq.	1			
Siebottom, J. N., per Capt. Nairn	5			
Voluntary Toll from Shipping	50		6	
Total Dons.	52	6	6	
Total Sube.	71	4		
£123	10	6		

MONTROSE BRANCH.

Local Committee—
JAMES MITCHELL, Esq.,
 Chairman.
MORTON CAMPBELL, Esq.
A. R. DUNCAN, Esq.
Capt. STANSFELD, Duninald.
Lieut. GROUBE, R.N.
JAMES JOHNSTON, Esq.
ALEXANDER M. MEARNS, Esq.
R. H. MILLAR, Esq.
GEORGE REID, Esq.
Capt. R. WALKER.

Honorary Secretary—
J. BALFOUR ALEXANDER, Esq.

Annual Subscriptions.		£.	s.	d.
Alexander, J. B. Esq.	10	6		
Barclay, Robt. Esq.	5			
Brown, J. & Son	5			
Burrell, Thos. Esq.	5			
Campbell, D. S. Esq.	5			
Carnegy, Miss, of Craigo	5			
Davidson, Alex. Esq.	5			
Dickson, Arthur Esq.	10			
Duncan, A. R. Esq.	5			
Findlay, J. R. Esq.	5			
Gordon, The Misses.	5			
Harbour Trustees & Johnston, Joseph & Sons, Messrs.	5	5		
Key and Murray	5			
Lackie, David, Esq.	5			
Lyell, A. Esq.	5			
McKenzie & Sons	5			
Mearns, Alex. Esq.	10	6		
Millar, R. & Sons, Messrs.	2	2		
Milne, John & Sons, Messrs.	10	6		
Mitchell, Jas. Esq.	10	6		
Moir, W. Esq.	5			
Muir, Son, & Patton	5			
Muir, R. I. Esq.	5			
Reid, George, Esq.	5			
Ross, James M. Esq.	5			
Ross, Wm. Esq.	5			
Samson, J. Esq.	5			
Shepherd, George, Esq., London	1	1		
Stanfeld, Capt.	2			
Thomson, John S. Esq.	5			
Walker, Capt. R.	5			
Whimster, W. S. & Son, Messrs.	5			
Woodward, Rev. J.	5			
A. B.	10			
Sums under 5s.	2	17	6	
Total	£33	2	6	

Donations.		£.	s.	d.
Interest from Harbour Trustees	17	8		
Howden, Dr.	10			
Donations from Capt. Lightoller, "Banklands"	2			
Contribution Boxes	19	5		
Total Dons.	20	17	5	
Total Subs.	33	2	6	
£53	19	11		

Haddingtonshire.

DUNBAR BRANCH.

Local Committee—
 The Right Hon. The EARL OF HADDINGTON, President.
H. T. N. HAMILTON OGILVY, Esq., of Biel, Vice-President.
Baillie BRAND, Chairman.
Dr. G. T. SINCLAIR, Vice-Chairman.

Hon Secretary and Treasurer—
WILLIAM BERTRAM, Esq.

Annual Subscriptions.		£.	s.	d.
Balfour, Right Hon. A. J.	1			
Dingwell, Mrs., Edinburgh	1			
Drysdale, Mrs., of Liverpool	1			
Haddington, Right Hon. the Earl of	1			
Hepburn, Sir Archibald Buchan	2	2		
Marrow, Major	2	2		
McIntyre, John	5			
Ogilvy, Mr. & Mrs. N. Hamilton	3			
Roxburgh, His Grace the Duke of	1			
Sanson, Wm.	5			
Sinclair, Dr. G. T.	5			
Stenhouse, Alex.	5			
Total Subs.	£13	4		

Donations.		£.	s.	d.
A.O.F. Court, "Star of the East"	10			
Hunter, Richard, Esq., of Thurston	1	1		
In memory of Mrs. Margaret Forrest, of Dingwell, per Messrs. Welsh & Forbes, S.S.C.	50			
Proceeds of Concert	21	14	4	
Roman Catholic Chapel	1	5		
Whittinghame Parish Church, per Rev. Dr. Robertson	1	5	6	
Contribution Boxes	10	2		
Sums under 5s.	2			
Total Dons.	76	8		
Total Subs.	13	4		
£89	12			

NORTH BERWICK BRANCH.

President—
Mrs. HAMILTON OGILVY, of Archerfield and Biel.

Chairman—
ROBT. GRANT SUTTIE, Esq. of Rockville.

Local Committee—
Rev. F. L. M. ANDERSON.
G. A. CONNOR, Esq.
GEORGE DALZIEL, Esq.
Sir A. BUCHAN HEPBURN, Bart.
M. HOUSTOUN, Esq.
E. S. MACDOUGALL, Esq.
D. MCCULLOCH, Esq.
ANGUS MATHESON, Esq., M.D.
JOHN R. MENZIES, Esq.
A. GILLIES SMITH, Esq.

Medical Officer—
ANGUS MATHESON, Esq., M.D.

Honorary Secretary—
DAVID MCCULLOCH, Esq.

Annual Subscriptions.

£.	s.	d.
Anderson, Rev. F. L. M.	10	
Balfour, Rt. Hon. J. B.	1	

£.	s.	d.
Boothby, Col. R. T.	10	
Brown, Geo. Esq.	10	
Chambers, Mrs. Robt.	1	1
Connor, G. A. Esq.	1	1
Dalziel, George, Esq.	1	1
Eeson, T. S. Esq.	10	
Grischott, R. O. Esq.	10	6
Hemingway, C.R. Esq.	1	1
Henderson, The Hon. H. H. H. Duncan Mercer	1	1
Hepburn, Sir A. B., Bart.	2	2
Houstoun, M. Esq.	1	1
Hunter, Wm. Esq.	1	1
Macdougall, Dr. J. A.	10	
Macdougall, E.S. Esq.	1	
Maxwell, Mrs.	10	
Menzies, Miss.	10	
Menzies, J. R. Esq.	1	1
Moncrief, Mrs.	10	
Morgan, Miss M.	10	
Napier, Sir Archibald, Bart.	1	
Ogilvy, Hamilton, Mr. and Mrs.	3	
Orphoot, Dr.	1	1
Pullar, J. F. Esq.	1	
Rachburn, Mr.	10	
Ralston, Major-Gen. W. H., C.B.	10	
Smith, A. Gillies, Esq.	1	1
Suttie, Mrs. F. G.	10	
Suttie, R. Grant, Esq.	1	1
Swan, Mrs.	10	
Trayner, Hon. Lord Wade, C. L. Esq.	10	
Wemyss, Earl of	5	
Whitecross, John R. Esq.	1	1
Younger, Geo. Esq.	1	
Zoete, De, W. M. Esq.	10	
Sums under 10s.	15	1
Per J. R. Menzies, Esq.:		
Bloxson, W. G. Esq.	10	
Blyth, B. Hall, Esq.	1	
Campbell, Wm. Esq.	1	1
Craig, Robert, Esq.	1	
D. C.	1	
McEwen, W. C. Esq.	5	
Menzies, C. T. Esq.	1	1
R. H. J.	5	
Stevenson, C. A. Esq.	5	
Stevenson, D. A. Esq.	5	
Tennant, F. J. Esq.	10	
Williamson, A. C. Esq.	1	
Total	£59	17

Donations.		£.	s.	d.
Cathcart, Miss A.	10			
Couper, Mrs.	10			
Davidson, W. S. Esq.	1			
Ebenezer	1			
Horne, Thos. Esq.	10			
Kennedy, John, Esq.	1			
Ker, W. Esq.	1			
Kirkhope, John, Esq.	1			
Langley, Capt.	10			
Macfie, Mrs. Claude	1	1		
Pepys, E. Esq.	1	1		
Ross, J. A. Esq.	10			
Stewart, Mrs. & Miss Wilson, Wm. Esq.	15	16		
Sums under 10s.	15	12	6	
Collected at—				
Gullane and Aberlady	3	15		
Haddington	1	17		
Marine Hotel, per W. Niebecker, Esq.	6	4		
"Life-boat Sunday" Collections—				
Ormiston Parish Church	1	1	6	

£.	s.	d.	
Prestonkirk Parish Church.....	6	6	8
Stenton Church ..	2	11	4
Whitekirk Parish Church.....	5	9	-
Bank Interest.....	1	3	1
Contribution Boxes .	7	11	3
Total Dons...	62	8	10
Total Subs...	59	17	6
	£122	6	4

Island of Helms.

STORNOWAY BRANCH.

Local Committee—
 Mr. J. N. ANDERSON, Coal Merchant.
 Mr. T. DICKENSON, H.M. Coastguard.
 Mr. MORTISHEAD, H.M. Customs.
 Chas. ORBACK, Esq.
 Mr JOHN HARROLD, Steamer Agent.
 Mr. J. B. INGRAM, Fishery Officer.
 Mr. ALEX. MACIVER, H.M. Customs.
 Mr. COLIN G. MACKENZIE, Solicitor.
 DR. MACKENZIE.
 Mr. JOHN MACKENZIE, Fish Curer.
 Mr. JOHN MACKENZIE, Merchant.
 Mr. JOHN MACKENZIE, Shipbroker.
 Mr. PETER MACLEOD, Baker.
 DR. MACRAE.
 Mr. J. M. MORISON, Fish Curer.
 Capt. MURDO MORISON.
 Mr. E. ROSS, Banker.
 Mr. JOHN ROSS, Solicitor.
 Mr. DONALD SMITH, Fish Curer.
 Mr. KENNETH SMITH, Fish Curer.
 THE SHERIFF SUBSTITUTE OF THE DISTRICT.

Treasurer—
 A. FRASER, Esq.
 Honorary Secretary—
 AENEAS M. MACKENZIE, Esq.

Annual Subscriptions.

£.	s.	d.	
Cameron, Mr. Alexander	10	-	10
Fraser, Mr. A.	10	-	10
Kennedy, Mr. A.	10	-	10
Mackenzie, Mr. Duncan	10	-	10
Mackenzie, Mr. Aeneas M.	10	-	10
Total.....	£2	10	10

Donations.

Smith, Provost.....	5	-	-
Hamish, Mrs. C.	1	-	-
Watters, R. Esq....	2	-	-

£.	s.	d.	
Platt, J. A. Esq....	5	5	-
Wood, J. Esq.....	1	-	-
Contribution Boxes .	3	-	8
Total Dons...	12	10	8
Total Subs. ...	2	10	-
	£15	-	8

Wincardineshire.

GOURDON BRANCH.

President—
 JAMES FARQUHAR, Esq., Hallgreen.
 Local Committee—
 PROVOST ALFRED GIBB, Chairman.
 Mr. A. ALLARDYCE RAE.
 Mr. A. LEGG, sen.
 Mr. A. LEGG, Jun.
 Mr. J. MOIR.
 Mr. C. MOWATT.
 Mr. BAXTER, Chief Boatman, H.M. Coastguard.

Honorary Secretary—
 Rev. JOHN BROWN, Bervie.

Annual Subscriptions.

£.	s.	d.	
A Friend	5	-	-
Anderson, Mrs.	5	-	-
Arbuthnot, Hon.W. 1	-	-	-
Aymer, Dr. Jas.	5	-	-
Brown, Rev. J.	5	-	-
Dickson, Pat. Esq. .	10	-	-
Farquhar, James, Esq.	5	5	-
Farquhar, Colonel .	3	3	-
Gibb, Provost.....	2	2	-
Myles, J. B. Esq.	5	-	-
Rae, A. Allardyce, Esq.	5	-	-
Shand, T. L. R. Esq. .	5	-	-
Webster, John, Esq. .	5	-	-
Sums under 5s.	2	4	3
Total Subs....	£16	4	3

Donations.

Collection Boxes, ...	1	5	-
Total.....	£16	5	8

JOHNSHAVEN BRANCH.

Local Committee—
 HERCULES SCOTT, Esq., of Brotherton, President.
 Mr. JOHN BEATTIE, Chairman.
 Mr. JOHN COUPER.
 Mr. JOHN CROALL.
 Mr WILLIAM CUTHBERT.
 Mr. JAS. FORD.
 Mr. ROBERT GRANT.
 Mr. JOHN MCBAY.
 Mr. THOMAS MIDDLETON.
 Mr. JOHN SHRETT.
 Mr. ALEXANDER WALKER.
 Mr. WILLIAM WATSON.

Honorary Secretary—
 Mr. R. STEWART.

Annual Subscriptions.

£.	s.	d.	
Beattie, Mr. John...	5	-	-
Couper, Mr. John...	5	-	-
Eaglesome, Mrs.....	5	-	-
Grant, Mr. R.....	5	-	-
Middleton, Mr. Thos.	5	-	-
Nicoll, Rev. Mr.....	5	-	-
Sheret, Mr. Jno.....	10	-	-
Simpson, Mr. Geo....	5	-	-
Watson, Mr. Wm.	5	-	-
Sums under 5s.....	14	6	-
Total Subs.....	£23	4	6

Donations.

Life-boat crew.....	17	6	-
Collecting Boxes and Donation	6	10	-
Proceeds of Concert..	11	16	1
Total	£16	4	11

STONEHAVEN BRANCH.

Patron—
 Sir ALEXANDER BAIRD of Urie, Bart., Lord Lieut. of the County.

President—
 PROVOST MOWAT.

Local Committee—
 A. B. ANNANDALE.
 ROBERT FALCONER.
 ALEX. GORDON.
 A. W. KINNAR.
 JAS. KNOWLES.
 THOS. MARTIN.
 WILLIAM MOWAT.
 JAS. OGG.
 D. TAYLOR.
 R. TINDAL.

Treasurer & Hon. Secretary—
 DAVID CABR.

Annual Subscriptions.

Annandale, A. B.	5	-	-
Baird, Sir Alex. of Urie, Bart.	2	2	-
Baird, H. R., of Durris.....	1	-	-
Bayly, H. W.	5	-	-
Crombie, J.W., Esq., M.P.	1	-	-
Falconer, Robert ...	5	-	-
Greig, George A.	5	-	-
Kinnear, A. W.	10	-	-
Leslie, Dr.	5	-	-
Martin, Thomas....	5	-	-
Mowat, Wm. & Sons	5	-	-
Ogg, James	5	-	-
Ritchie, Wm.	1	-	-
Tindal, Robert	10	-	-
Sums under 5s.....	3	18	6
Total Subs....	£12	-	6

Donations.

Collection Boxes ...	17	8	-
Total.....	£12	18	2

Wirkcudbright.

BALCALRY (AUCHENCAIRN) BRANCH.

Local Committee—

J. G. MACKIE, Esq., Chairman.
 H. CRAWFORD.
 JOHN CROSSIE.
 W. D. R. DOUGLAS.
 ROBT. GRIERSON.
 WM. GRIERSON.
 HAINING, A.
 L. M. KIRWIN.
 J. G. MACKIE.
 W. H. MAXWELL.
 JOHN McDOWALL.
 JOHN MCTAGGART.
 ANDREW MITCHELL.
 WALTER MUIR.
 WALTER OVENS.
 SLOAN, WM.
 ALEX. WILSON.

Honorary Secretary—
 J. G. BOYES.

Annual Subscriptions.

£.	s.	d.	
Boyes, J. G.	5	-	-
Craig, Jas., Castle Douglas	5	-	-
Crawford, H.....	5	-	-
Crosbie, John.....	5	-	-
Douglas, W. D. Robinson, of Orcharthorn	1	1	-
Grierson, Robt.	5	-	-
Hutchison, John W. Esq., of Edingham 1	-	-	-
Kirwin, L. M. Esq. 1	-	-	-
Lawrence, Mrs. Ernespie.....	1	-	-
Mackie, John G. Esq., of Auchencairn... 2	2	-	-
McDiarmid, J. Esq. -	10	6	-
McDowall, J. Esq. of Girdstingwood ... 1	1	-	-
McKenzie, E. P. Esq. -	1	1	-
Auchenskeoch ... 1	1	-	-
McTaggart, John... -	5	-	-
Maxwell, Wellwood, Esq. Kirkennon... 1	-	-	-
Muir, Walter	5	-	-
Ovens, Walter, Esq., of Torr	1	1	-
Sloan, Wm.....	5	-	-
Threshie, Mrs.....	10	-	-
Wilson, Alex., Dalbeattie	10	-	-
Sums under 5s.....	11	-	-
Total Subs....	£14	7	6

Donations.

Collected at Cricket Match.....	15	-	-
Contribution Boxes .	16	3	-
Total.....	£15	13	9

KIRKCUDBRIGHT BRANCH.

President—
Captain HOPE, R.N

Local Committee—

Provost COWAN.
R. F. DUDGON, Esq.
A. HABBISHAW, Esq.
JAMES McMULDROW, Esq.
The Very Rev. Dean SHREHY.

Treasurer and Hon. Sec.—
JAMES CAVAN, Esq.

Annual Subscriptions.

	£.	s.	d.
Barber, John, Esq., Liverpool.....	10	6	
Burgh of Kirkcudbright.....	5		
Cairns, W. S. Esq., Liverpool.....	10		
Cavan, James, Esq.....	5		
Cavan, Mrs. James.....	10		
Cowan, Provost.....	5		
Gibson, John, Esq.....	5		
Gordon, Sir W. Bart.....	2		
Habbishaw, A. Esq.....	1		
Habbishaw, Miss H.....	10	6	
Halliday, A. Esq., New York.....	1		
Hope, Capt., R.N.....	3	3	
Hutchison, J. W. Esq.....	1		
Johnstone, Misses.....	5		
McClellan, Miss Clara, Castletown, Isle of Man.....	1	1	
McClellan, John, Esq.....	1		
Ealing.....	1	1	
McKie, J. Esq., R.N.....	5		
McLaren, James, Esq., Liverpool.....	10	6	
McMuldrow, James, Esq.....	10		
Maitland, David, Esq., of Cumnostun.....	1		
Maxwell, J. H. Esq., Castle Douglas.....	10		
Maxwell, W. H. Esq., of Munches.....	1		
Morison Allan, Esq., Liverpool.....	5		
Muir, Messrs.....	5		
Paterson, H. E. Esq.....	10	6	
Reid, Sir R. T., Q.C., M.P.....	2	2	
Reid, Dr. Oakley.....	5		
Sheehy, The Very Rev. Dean.....	5		
Skirving, Adam, Esq., of Croys.....	1		
Smith, Sam., Esq., M.P., Liverpool.....	1	1	
Whitewright, Thos. Esq.....	5		
Sums under 5s.....	17		
Total Subs.....	£28	18	

Donations

Davies, John, Esq., Liverpool.....	1	1	
Gordon, William, Esq., of Threave.....	1	1	
Johnstone, Dr.....	5		
Simmonds, Hunt & Montgomery.....	10	6	
Sproat, W. T. Esq. Borgue House.....	10		
Total.....	£32	5	6

Lanarkshire.

GLASGOW BRANCH.

Local Committee—
WM. CAIENRY, Esq., Chair-
man.

Sir JOHN BURNS, Bart.
WM. BURRELL, Esq.
GEORGE KERR, Esq.
JAMES LILBURN, Esq.
J. P. MACLAY, Esq.
DAVID McCOWAN, Esq.
JOHN A. ROXBURGH, Esq.

Treasurer—
LEONARD Gow, Jun., Esq.

Secretary—
WILLIAM MARTIN, Esq.,
116, St. Vincent Street.

Annual Subscriptions

	£.	s.	d.
Aitken & Walker.....	1		
Aitken, Lilburn, & Co. Messrs.....	1		
Aitken, McKenzie & Clapperton.....	1	1	
Alexander, Fergus- son, & Co. Messrs.....	1		
Alexander and Co. Messrs. R. F. & J.....	1	1	
Alexander, James, Esq.....	10	6	
Atlan, Jas. A., Mr. and Mrs.....	3		
Allan, Robert S. Esq.....	2	2	
Allan, Miss Jessie.....	5		
Alston & Tulloch, Messrs.....	10	6	
Alston, J. C.....	1		
Anderson, Messrs. D. and J.....	2	2	
Anderson and Co. Messrs. James.....	10		
Arnott & Co. Messrs.....	1		
Arrol, Sir William.....	1		
Arthur & Co. (Limited) Messrs.....	5	5	
Arthur and Hinshaw, Messrs.....	1	1	
Arthur, A. Esq.....	5		
Austin and McAslan, Messrs.....	10	6	
Ayr Steam Shipping Co.....	1	1	
Bain, Messrs. Wm. and Co.....	5		
Baird and Sons, Ltd. Messrs. Hugh.....	10	6	
Balfour Parish Church Sabbath School.....	3		
Balloch, Robert, and Co.....	10	6	
Bannatyne, Kirk- wood, France & Co.....	2	2	
Barclay, Robert.....	1		
Barclay, Curle & Co., Ltd. Messrs.....	2	2	
Barrowfield Iron- works Employees.....	2	2	
Beith, Stevenson & Co.....	1	1	
Bell, Bro. and McLelland, Messrs.....	1	1	
Bennett, Browne, and Co. Messrs.....	1	1	
Biggart & Faison.....	10	6	
Binnie, Thos. Esq.....	10	6	
Birkhead & Co. Messrs. John.....	2	2	
Black, James, and Co.....	1	1	
Blacketer, A. F.....	10	6	
Blackie and Son, Ltd.....	1	1	

Blackie, Robt., Esq.....	2		
Blyth, Robt.....	2	2	
Blythswood Parish Church Sabbath School.....	1		
Boyd, J. & T.....	1	1	
British and African Steam Navigation Co. (Limited).....	2	2	
Broadfoot & Sons, Messrs. John.....	10		
Brown & Co. Messrs. J. and T.....	1	1	
Brown, John, Esq.....	2	2	
Brown, Sons, & Co. Messrs. Wm.....	2	2	
Browns & Co. Messrs.....	10		
Browne and Watson.....	15		
Brownlee & Co., Messrs.....	1	1	
Bruce & Co., Jun.....	10	6	
Bryce and Ruff.....	1	1	
Buchanan, A. Esq.....	1	1	
Buchanan, G. M. Esq.....	5		
Buchanan, Watson, and Co. Messrs.....	1	1	
Bulloch, Lade, & Co. Messrs.....	1	1	
Burns, Messrs. G. & J.....	2	2	
Burrell and Son, Messrs.....	11	6	
Caldwell, Young, & Co. Messrs.....	10		
Caledonian Tube Co.....	1	1	
Cameron, Hugh, Esq.....	1	1	
Campbell and Co. Messrs. J. and W.....	2	2	
Campbell, Jas. A., LL.D., M.P.....	2		
Campbell, John M., and Son.....	1	1	
Campbell, Mrs.....	10		
Cargill, D. S. Esq.....	10	6	
Caw, Prentice, Clap- perton & Co.....	4	4	
Cayzer, Irvine & Co.....	1	1	
Chrystal, Robert, Esq.....	2	2	
Cleland, Prof., M.D., LL.D.....	1	1	
Clyde Corinthian Yacht Club.....	1	1	
Clyde Shipping Co.....	2	2	
Coatbridge Co- operative Society.....	2		
Coats, J. & P., Ltd., Messrs.....	10		
Cochran, A. and R.....	1	1	
Collins, Sons, and Co., Messrs. William.....	2	2	
Colville, Archd., Esq.....	10		
Colville, John, Esq.....	2		
Connal & Co. Messrs. Limited.....	1	1	
Connell and Co. Messrs. Charles.....	1	1	
Cornfoot & Co., Messrs. James.....	10	6	
Craigsheim and Her- man, Messrs.....	1	1	
Crawford & Son, Ltd., Danl.....	10		
Crawford, R. Esq.....	1	1	
Crawford, Cree, and Co., Messrs.....	1	1	
Crombie, Mrs.....	10	6	
Cruickshank & Co., W.....	10	6	
Cuthbertson & Co., Messrs. James R.....	1	1	
Davidson, W. J. Esq.....	2	2	
Denniston, Peter, and Co.....	1	1	
Denny and Co.....	1	1	
Denny, Wm. Brothers, Messrs.....	2	2	
Dick, G. Handasyde, Esq.....	1	1	
Dick, W. B. and Co., Ltd.....	10	6	
Donaldson Brothers, Messrs.....	5	5	

Douglas, R. & Son, Messrs.....	1	1	
Dow, Archd. Esq.....	1	1	
Dubbs & Co., Messrs., Employees of.....	10	10	8
Dunlop, David, Esq.....	1	1	
Dunlop, Thos. and Sons, Messrs.....	1	1	
Dunn Brothers.....	10	6	
Dunn, Jas. and Sons.....	1	1	
Eadie and Co., Archd.....	2	2	
Eastmans, Limited.....	1	1	
Eastwood Parish Church Sabbath School.....	1	5	
Edmiston and Mit- chella, Messrs.....	1	1	
Edmiston, J. and R.....	10	6	
Eglinton Chemical Co., Employees.....	2		
Ewing & Co. Messrs. A. Orr.....	2	2	
Ewing & Co. Messrs. James.....	1	1	
Ewing & Co., John Orr.....	2	2	
Ewing, Miss Con- stance R. B.....	8		
Fairfield Shipbuilding Co. Limited.....	2	2	
Farquhar & Robertson, Messrs.....	10	6	
Ferguson & Sons, Messrs. James.....	10	6	
Ferguson and Reid, Messrs.....	1	1	
Ferguson and Bros. Messrs. J.....	1	1	
Findlay, R. E. Esq.....	1	1	
Finlay & Co. Messrs. James.....	2	2	
Fleming, M. Tarbett, Esq.....	1	1	
Fleming, P. and R. & Co.....	1	1	
Freme, G. & J., Messrs.....	10	6	
Fraser and Sons, Messrs. John.....	1	1	
Fraser, Kirkpatrick, and Smith.....	2	2	
G. & S. W. Railway, Dumfries per box	7	8	
Gairdner, Chas. Esq., LL.D.....	1	1	
Galbraith, Jas. L.....	1	1	
Gardiner, James & Co.....	1	1	
Garraway, R. & J.....	1	1	
General Shipping Co., per Aitken, Lilburn, and Co.....	1	1	
Gibson & Clark, Messrs.....	1	1	
Gilbert, Mrs. Crerar.....	2		
Gilfillan & Co., Messrs. J. & T.....	10		
Glasgow Shipping Co., per Aitken, Lilburn, and Co.....	1	1	
Glasgow Steam Ship- ping Co., per Messrs. John Black & Co.....	2	2	
Glen, Mrs. Margaret Pollock.....	2	2	
Gordon & Co., Messrs. Geo.....	1	1	
Gourlay, Robert, Esq.....	1	1	
Gow, Harrison & Co., Messrs.....	1	1	
Graham & Co. Messrs. William.....	2		
Graham, Messrs. A. J. and A.....	2	2	
Gray, Alex., per box	11		
Gray, Dunu, and Co. Messrs.....	1	1	
Grischott and Co.....	1	1	
Gumprecht & Stewart Harrington, J. P. Esq.....	10	6	
Hart, Arthur, Esq.....	10	6	
Hay & Sons, Messrs. J.....	1	1	

ANNUAL SUBSCRIPTIONS AND DONATIONS TO BRANCHES. 855

£. s. d.	£. s. d.	£. s. d.	£. s. d.
Hedderwick, James & Sons..... 1 1 -	M'Dowall, Steven, and Co.Ltd. Messrs. 2 2 -	Rankin, James, Esq. of Ardnachaig.... 5 - -	Taylor, Laughtland, and Co. Messrs.... 1 1 -
Henderson and Co., Messrs. D. and W. 2 2 -	M'Gregor, J. C. & Co. Messrs..... 1 - -	Rankine and Son, Messrs. James.... 1 1 -	Teacher, Mrs. Wm.. 2 2 -
Henderson and Co. Messrs. Patrick... 2 2 -	M'Grigor, Donald & Co..... 2 2 -	Reichmann and Co. Successors..... 10 - -	Teacher and Sons, Messrs. William... 2 2 -
Henderson, Bros.... 10 10 -	McKellar, John C. Esq..... 1 - -	Reid and Son, Messrs. Alex..... 10 6 -	Templeton and Co. Messrs. James... 2 2 -
Henderson, Miss... 5 - -	M'Laren, Sons, & Co. Messrs. William... 1 - -	Reid, Dr. W. L.... 1 - -	Thom and Cameron. 1 1 -
Henry, A. and S. Ld. 1 1 -	McCall and Stephen. McClelland, MacKin- non & Co., Messrs. 1 1 -	Reid, Joseph, Esq. 20 - -	Thomson, Dickie & Co..... 1 1 -
Hill, R. and J. M. Brown, and Co.... 2 2 -	McCalland, MacKin- non & Co., Messrs. 1 1 -	Rintoul, Son, and Co. Messrs. Peter.... 1 1 -	Thomson and Gray . 10 - -
Hinshelwood, J. and Co., Messrs..... 10 6 -	McCorquodale & Co., Ld., Messrs..... 1 1 -	Ritchie and Co. Messrs. Jas..... 1 1 -	Thomson, Jas. and Geo. 1 1 -
Holmes, Kerr, and Hedderwick.... 10 6 -	McCracken, S. W., L.D.S..... 1 1 -	Robb, Moore, & Co. Messrs..... 10 6 -	Thornliebank Co., Ltd. 1 1 -
Honeyman, Michael, Esq..... 10 - -	McEwan, Robt. D. Esq..... 10 6 -	Robb, Moore, & Co. Messrs..... 10 6 -	Tillie & Henderson. 1 1 -
Howat, Messrs. D. G. & Co..... 1 1 -	McEwen, Robert, Esq. 1 1 -	Robertson & Baxter, Messrs..... 1 1 -	Train & Co. Messrs. Thomas 10 6 -
Howard, Houlder, Malcolm & Co., Messrs..... 1 1 -	McMillan, Archd. & Sons..... 1 1 -	Robertson, Messrs. L. and R. H..... 1 1 -	Turnbull, Martin, & Co..... 1 1 -
Hurler and Campsie Alum Co..... 1 1 -	McNab, Messrs. John & Co..... 4 4 -	Robertson, Wm. Esq. 1 1 -	United Co-operative Bakers' Society... 7 7 -
Hutcheson, Jas. and Sons..... 10 6 -	McNab & Co., Messrs. John, Workers... 2 2 -	Robertson, W. and Laird, Messrs... 5 - -	Ure, John, Esq.... 2 2 -
Hydepark Foundry Company..... 10 6 -	McSyrton & Potter. 1 1 -	Rodger, Edward, Esq. 10 6 -	Ure, Wm. P. Esq... 1 1 -
Inglis, Messrs. A. and J..... 2 2 -	McTear, Robt. & Co. 10 6 -	Rodger, James, G. Esq. 10 6 -	Walker & Co. Messrs. John 10 6 -
Jameson, Robt. Esq. 1 1 -	Mair, Robt. A., C.A. 10 6 -	Rodger, Mrs. 1 1 -	Watson and Co. Messrs. James... 3 3 -
Johnstone, Jas. Esq. 1 1 -	Malloch, Messrs. G. and J..... 10 6 -	Rose, Murison, and Thomson, Messrs. 1 1 -	Watson Bros. 4 4 -
Kelly & Co. Messrs. 1 1 -	Mann, Byars, and Co. Messrs..... 1 1 -	Ross, John, Esq.... 2 2 -	Watson, Gow, and Co. Messrs..... 1 1 -
Ker, William, Esq... 2 2 -	Matthews, MacIay & Manson 1 1 -	Ross, Mrs. 5 - -	Watson, John E. Esq. 10 6 -
Ker, David S. Esq... 10 6 -	Miller and Co. Messrs. G..... 2 2 -	Rowley & Dick.... 10 6 -	Watt, Hayes & Co., Messrs..... 1 1 -
Kerr, Andersons, Muir and Main, Messrs. 2 2 -	Miller, Son & Co., Messrs. James... 2 2 -	Roxburgh, J. & A. 1 1 -	Waverley Iron and Steel Co..... 2 - -
Kerr, Newton, & Co. Messrs..... 1 1 -	Mirrieles, Watson, & Yaryan Co., Ltd., Messrs..... 2 2 -	Royal Clyde Yacht Club 2 2 -	Weir & Co., Messrs. Andrew 1 1 -
Keyden, James, Esq. 2 - -	Mitchell, A., Jun. and Sons 10 - -	Sandeman, Messrs. D. & Co..... 10 6 -	Wharrie, Colledge & Brand, Messrs... 10 6 -
Kidston & Co. Messrs. A. G..... 2 2 -	Mitchell & Co., Ltd. of Belfast..... 10 6 -	Sandeman, J. Glas. 1 1 -	White, Messrs. John and James..... 3 3 -
King, James Bowie. 10 - -	Mitchell, Johnstone & Co..... 5 - -	Scott & Sons, Messrs. 1 1 -	Wilson and Son, Messrs. Jas..... 1 1 -
Kinning Park Co-operative Society. 5 - -	Mitchells, Johnston & Co..... 1 1 -	Scott, D. M. Esq... 1 1 -	Wilson & Son, Ltd., Messrs. John..... 1 1 -
Kirkpatrick & Co., Andrew J..... 1 1 -	Moncreiff, Barr, Patersons & Co. Messrs. 2 2 -	Semple, McLean, & Reid, Messrs..... 1 1 -	Woodrow, Alexander, & Sons, Messrs... 10 6 -
Kirkwood, Jas., and Son..... 1 1 -	Moore, Taggart, and Co. Messrs..... 10 6 -	Singleton, Dunn, & Co..... 1 1 -	Wordie and Co.... 1 1 -
Laidlaw, R. and Son 1 1 -	Moore, Tassart, and Moore, Carson, & Watson 10 6 -	Skinner's Incorporation..... 2 2 -	Wright, Johnston, McKenzie, and Roxburgh, Messrs. 2 2 -
Laird, Alex. A. & Co. 1 1 -	Morris and Co..... 1 1 -	Skinner and Co. Messrs. Thomas... 2 2 -	Young & Co., J. & R. 1 1 -
Lamont, Henry Esq. 1 1 -	Morrison, David, Esq. 2 2 -	Skinner and Son, Messrs. W..... 1 1 -	
Lander, Mrs. T. Eaton 10 - -	Muir and Houston, Ltd. 1 1 -	Sloan & Co. Messrs. William 2 2 -	
Lang, Dr. Marshall. 5 - -	Muirhead and Guthrie Smith 1 1 -	Smith and Sharp, Messrs..... 1 1 -	
Langlands and Son, Messrs. H..... 1 1 -	Murdoch, Robt. & Co. 1 1 -	Smith and Sons, Messrs. George... 20 - -	
Law, Thos. and Co. 1 1 -	Napier, Jas. S. Esq. 3 3 -	Smith and Wellstood, Messrs. 10 - -	
Leisler, Bock, and Co. Messrs..... 1 1 -	Napier, Shanks & Bell 1 1 -	Snodgrass, Messrs. J. and R..... 1 1 -	
Leisler, Greig and Co..... 1 1 -	National Trades Exhibition 5 12 9	Spencer and Co., Messrs. James... 10 6 -	
Lietke & Co. Messrs. 1 1 -	Neill, Messrs. J. & R. 5 - -	Spencer, John, Esq. 1 1 -	
Little, James, & Co. 1 1 -	Neilson & Co..... 2 2 -	Spicer, Service & Co., Messrs..... 1 1 -	
Lorimer & Moyes, Messrs..... 10 6 -	Neilson & Maxwell, 1 1 -	Steel, Conison, and Co. Messrs..... 1 1 -	
Love & Stewart, Messrs..... 1 1 -	Nimmo, Jas. & Co. 1 1 -	Stephen and Sons, Messrs. Alexander 2 2 -	
MacBrayne, D. Esq. 1 1 -	Ormiston, J. W.... 1 1 -	Stevenson, D. M. and Co..... 5 5 -	
Macfarlane and Co. George Gray..... 1 1 -	Outram & Hamilton 1 1 -	Stevenson, James, Esq. 2 2 -	
Mackay, A. & Co. 1 1 -	Paterson and Son, Messrs. Wm.... 1 1 -	Stevenson, Carlile & Co., Limited..... 2 2 -	
MacKenzie, Robertson & Co..... 1 1 -	Paterson, Jas. & Co. 1 1 -	Stewart, A. & J., and Clydesdale, Limited 1 1 -	
Mackill, Robt. & Co. 1 1 -	Pattison, James M. Esq. 10 - -	Stewart & M'Donald, Messrs..... 1 1 -	
Mackinnon and Co. Messrs. William... 2 2 -	Peattie, Macintyre & Laird 1 1 -	Stewart, D. Y. & Co. 2 2 -	
MacIae, A. Crum, Esq. 1 1 -	Pirrie, Foote, and Co. Messrs..... 1 1 -	Stewart, John, Esq. 5 - -	
MacIay, Murray, and Spens, Messrs.... 2 2 -	Pitkethly, Jas. Esq. 1 1 -	Stewart, R. & Sons. 1 1 -	
MacIay & McIntyre. 5 5 -	Phillips, John, & Co. Messrs..... 10 - -	Stewart, Mrs. W. H. 1 - -	
McLean, Neil, Esq... 10 - -	Raeburn and Verel, Messrs..... 2 2 -	Stirling and Sons, Messrs. Wm.... 2 2 -	
MacLellan, Messrs. P. and W..... 2 2 -	Raiston, Goodwin & Co. Messrs..... 1 1 -	Summerlee and Moss- end Iron and Steel Co. 3 3 -	
Macpherson, H. S. and Co..... 1 1 -	Rankin and Sons, Messrs. W..... 10 6 -	Tatlock, R. R., Read- man & Thomson . 1 1 -	
M'Call and Son, Messrs. James... 1 1 -			
M'Clure, Naismith, Brodie & Co. Messrs. 1 1 -			
M'Gowan, David, Esq. 1 1 -			

Total Subs...£547 3 7

Donations.

Catrine Parish Church. Proceeds of Mr. Martin's lecture 2 12 6
 Sir Michael Connal's Trust 4 10 0

£7 2 6

Legacies.

William Stevenson's Trust 1000 - -

Total Legacies...1000 - -

Total Subscriptions 547 3 7
 Total Donations... 7 2 6

Total£1554 6 1

Inlithgowshire.

BO'NESS BRANCH.

Local Committee—
J. & J. ALLAN.
JOHN DENHOLM & Co.
W. DONALDSON, Esq.

Honorary Secretary—
JAMES JOHN CADELL, Esq.

Annual Subscriptions.

	£.	s.	d.
Allan, J. and J.	10	-	0
Cadell, L. I.	10	6	-
Cadell, J. J.	1	1	-
Cadell, H. M.	1	1	-
Cadell, Miss I. M.	10	-	0
Denholm, Jno., & Co.	10	-	0
Donaldson, Wm.	10	-	0
Hope, Thos. Esq.	5	-	0
Jeffrey, J. S.	5	-	0
Love, Stewart, & Co.	10	-	0
Smith, R., & Co.	5	-	0
Stevenson & Cowie.	5	-	0
Thomson & Balfour	5	-	0
Sums under 5s.	10	-	0

Total Subs.....£6 17 6

Donations.

Contribution Boxes - - 6

Total£6 18 -

Nairnshire.

NAIRN BRANCH.

Local Committee—
General MACDONNELL, Chair-
man.

D. MAIN BAILLIE, Esq.
GEORGE BAIN, Esq.
Colonel CLARKE, of Acha-
reidh.
H. T. DONALDSON, Esq.
J. FINLAYSON, Esq.
J. FRASER, Esq.
H. MACKINTOSH, Esq.
A. MCGILLIVRAY, Esq.
DR. MANN.
W. C. NEWBIGGING, Esq.
J. S. ROBERTSON, Esq.
Major ROSE, of Kilravock.
J. TOLMIE, Esq.

Honorary Secretary—
Mr. JAS. MCINTOSH.

Annual Subscriptions.

	£.	s.	d.
Baillie, D. M. Esq.	5	-	0
Baillie, Mrs., Lochloy	5	-	0
Beith, G. Esq.	1	1	-
Brodie, C., Druim	5	-	0
Brodie, Mrs.	5	-	0
Cawdor, Earl	2	-	0
Clarke, Colonel, of Acharaidh	1	-	0
Cruickshank, Dr.	5	-	0
Donaldson, H. T.	10	-	0
Dunbar, Lady, of Boath	10	-	0
Finlay, Sir E. B., M.P.	1	1	-
Fraser, John, Esq.	5	-	0
Gordon, J. E. Esq., M.P.	1	1	-
Holland, J. G.	1	1	-
Lightbody, Wm.	10	-	0
MacDonnell, General	1	1	-

	£.	s.	d.
MacGillivray, A. Esq.	10	6	-
Mackintosh, H.	10	6	-
Mather, Arres J.	10	-	0
McIntosh, Jas.	5	-	0
Newbigging, W. C. Esq.	1	1	-
Parker, Mrs.	10	6	-
Robertson, J. S. Esq.	10	-	0
Rose, J. Esq.	5	-	0
Rose, Major, of Kil- ravock	1	1	-
Rose, Mrs., of Holme	1	1	-
Sclanders, Dr.	5	-	0
Turnbull, W. Esq.	10	-	0

Total£18 4 6

Donations.

Gordon, A., Esq. 10 -
Inverness Town
Council 3 -
Inverness Harbour
Trustees 5 -
Mackay, Rev. Mr. 1 1 -
Pullar, Mrs. 1 -
Whitelaw, W. Esq. 1 -
Contribution Boxes . 1 2 4

Total Dons.....12 13 4

Total Subs.....18 4 6

£30 17 10

Orkney Islands.

**LONGHOPE
BRANCH.**

Local Committee—
- Capt. JOHN MENZIES.

Honorary Secretary —
EDWARD E. CORRIGALL, Esq.

Annual Subscriptions.

	£.	s.	d.
Corrigall, Edward E., Esq.	5	-	0
Sums under 5s.	2	7	6

Total£2 12 6

**STROMNESS
BRANCH.**

Local Committee—
Mr. ANDREW STEWART,
Chairman.
Capt. G. G. BAILLIE.
Capt. GEORGE BILTON.
Mr. F. A. DALL.
Capt. EWING.
W. D. FIRTH.
Mr. JOHN MACKAY.
Capt. JAMES MILLER.
Mr. J. A. SHERRER.
Mr. B. S. TERRAS.
Mr. W. H. WATT.

Honorary Secretary—
Capt. G. BAILLIE.

Annual Subscriptions.

Baillie, Capt. Geo.	5	-	0
Bilton, Capt. G.	5	-	0
Dall, A. T.	5	-	0

	£.	s.	d.
Ewing, Capt.	5	-	0
Firth, Mr. W. D.	5	-	0
Mackay, John	5	-	0
Stewart, Mr. A.	5	-	0
Zetland, The Most Hon. the Marquis of	5	-	0
Sums under 5s.	10	14	5

Total Subs.. 17 9 5

Donations.

Contribution Box at
Custom House ... 10 -
Boxes at Masons'
Arms and Com-
mercial Hotel .. 1 1 3

Total....£19 - 8

Peeblesshire.

PEEBLES BRANCH.

President—
T. H. ORPHOOD, Esq.,
Sheriff-Substitute.
Local Committee—
Rev. R. BURGESS.
J. RAMSAY SMITH, Esq.
W. BUCHAN, Esq.
Honorary Secretary—
DR. CONNELL.

Annual Subscriptions.

	£.	s.	d.
Ballantine, Rev. R.	5	-	0
Ballantyne, D., & Co.	10	6	-
Beaully, Mrs.	5	-	0
Black, Mrs.	10	-	0
Black, R.	10	-	0
Blackwood, Alexander	5	-	0
Buchan, Mr. W.	5	-	0
Bulmer, Charles	10	-	0
Burgess, Rev. R.	5	-	0
Connell, Dr.	10	-	0
Duncan, A. B., Dun- dees	10	-	0
Employees— Ballantyne, D. & Co.	3	10	-
Thorburn Bros.	3	7	-
Damdale and Tweedside Mills	3	7	-
Gardner, Rev. M.	5	-	0
Graham, Miss	1	-	0
Gray, Matthew	5	-	0
Gray, Thomas	5	-	0
Hay, Miss	5	-	0
Junor, Mrs.	5	-	0
Kidd, Miss	1	-	0
Law, Hugh	5	-	0
Lindsay, Miss	5	-	0
Mackenzie, Mr.	1	1	-
Macrae, J. N.	10	-	0
Mitchell, Mrs.	5	-	0
Murray, Robert A.	10	-	0
Nicol, Miss	5	-	0
Orphood, Sheriff	10	6	-
Paul, Mrs.	10	-	0
Reid, Miss H. B.	5	-	0
Robertson, Mr. R. T.	10	-	0
Simpson, Walter T.	10	-	0
Smith, J. Ramsay	5	-	0
Smith, J. & M.	5	-	0
Somerville, Mrs.	6	-	0
Tennant, Sir Chas.	2	2	-
Thorburn, Mr. M. G.	1	-	0
Thorburn, Mr. R.	10	6	-
Thorburn, Walter, M.P.	10	6	-
Thorburn, William	2	2	-
Wyer, Mrs.	1	-	0
Young, Mr. Wm.	10	-	0
Young, Robert	5	-	0
Young, Thos.	5	-	0
Sums under 5s.	12	15	6

Total Subs.....£41 10 6

Donations.

Proceeds of Lecture
at Lyne School... 14 6
Proceeds of Lecture
to Peebles Band
of Hope..... 18 5

Total....£43 3 5

Perthshire.

PERTH BRANCH.

President—
SIR ROBERT PULLAR.

Local Committee—
Lord Provost DEWAR.
Ex-Lord Provost WHITTET.
Ex-Lord Provost WILSON.
Ex-Dean of Guild PIRRIE.
Ex-Dean of Guild WOTHER-
SPOON.
Baillie WRIGHT.
Ex-Baillie MCGREGOR.
Ex-Baillie MCKNICOLL.
Councillor MCKENDRICK.
MELVILLE JAMESON, Esq.,
Fernhill.

GEORGE GRAY, Esq., Bowers-
well.
PETER CAMPBELL, Esq.,
Lignwood.
Captain GEDDES, Mount Tabor.
Rev. Mr. FLEMING.
" Mr. MAIN.
" P. A. GORDON CLARK.
" Mr. SUTHERLAND.
" Mr. KENNEDY.
" GEO. D. STIBBAED.

Treasurer—Miss GARDNER,
Orchard Bank, Perth.

Secretary—
J. A. GARDNER, Fairmount
View, Perth.

Annual Subscriptions.

	£.	s.	d.
A Friend, per Miss Gardner	1	-	0
Ditto ditto	10	-	0
Ditto ditto	9	6	-
Ditto ditto	5	-	0
Balmain, Jas. Esq.	1	-	0
Campbell, P. Esq.	1	-	0
Costes, Andrew, Esq.	1	-	0
Dewar, Mrs.	10	-	0
Geddes, J. M., New Zealand	10	-	0
Geddes, Mrs.	5	-	0
Geddes, Prof. Patk.	5	-	0
Gloag, Miss	10	-	0
Mackay, W. Esq.	5	-	0
Milne, Mrs.	5	-	0
Newlands, Mrs.	5	-	0
Pullar, Mrs. J. F.	10	-	0
Pullar, R. D. Esq.	10	-	0
Robertson, Misses, New Scene	5	-	0
Ross, Misses	5	-	0
Roy, Mrs.	10	-	0
Thomson, Rev. J. Stanley	10	-	0
Tuke, A. Esq.	10	-	0
Turnbull, Miss	1	-	0
Turnbull, Mrs. W. S.	5	-	0
Sums under 5s.	2	6	-

Total£14 10 6

Renfrewshire.

GREENOCK BRANCH.

Local Committee—
 Provost SHANKLAND, Chair-
 man.
 J. D. CLINK, Esq.
 ROBERT KERR, Esq.
 ALEXANDER P. LYLE, Esq.
 D. MACDOUGALL, Esq.
 EDWARD MAXWELL, Esq.

Honorary Secretary—
 ALEXANDER ANDREW, Esq.,
 Writer.

(No list for 1896.)

Renburghshire.

KELSO BRANCH.

President—
 Rev. J. G. S. NAPIER.

Local Committee—
 P. STORMONTH DARLING, Esq.,
 Edenbank.
 CHARLES DOUGLAS, Esq.,
 M.D., Woodside.
 P. ROBERTSON, Esq.,
 Newarth.
 JAMES SMITH, Esq., J.P.,
 Mount Oswald.

Honorary Secretary—
 Mr. ALEXANDER MUIRHEAD.

Annual Subscriptions.

	£.	s.	d.
Beveridge, J. Esq.	-	10	-
Darling, P. Stormonth, Esq.	-	5	-
Douglas, Dr. Charles	-	10	-
Dunn & Son, Messrs.	-	5	-
A.	-	5	-
Johnston, Messrs. J. & J.	-	5	-
Laing, G. Esq.	-	5	-
Logan, P. Esq.	-	5	-
Main, A. Woodman, Esq.	-	5	-
Muirhead & Purves, Messrs.	-	5	-
Purves, The Messrs.	-	10	-
Robertson, Miss S.	-	5	-
Smith, T. D. Crichton	-	5	-
Tait, James, Esq.	-	10	-
Sums under 5s.	4	6	-
Total	£8	11	-

MELROSE BRANCH.

President—
 Vice-Admiral Sir HENRY
 FAIRFAX, K.C.B.

Local Committee—
 ALEX. CURLE, Esq.
 JAMES CURLE, Esq.
 Rev. J. C. HERMAN, D.D.
 Rev. R. SANDERS, B.D.
 A. M. SMALL, Esq., W.S.
 Rev. HUGH STEVENSON.

Honorary Secretary—
 JOHN BROAD, Esq.

Annual Subscriptions.

	£.	s.	d.
Baillie, Miss	-	5	-
Baillie, Miss M. T.	-	5	-
Balmer, Mr. and Misses	-	5	-
Boswell, Major-Gen.	-	10	-
Broad, John, Esq.	1	-	-
Carre, Col. R.	-	10	-
Curle, Alex. Esq.	1	-	-
Curle, James, Esq.	1	-	-
Dalrymple, Hon. George	1	-	-
Dudgeon, J. S. Esq.	-	5	-
Erskine, Mrs.	-	10	-
Fairfax, Vice-Ad- miral Sir H. K.C.B.	1	-	-
Freer, Mrs.	-	5	-
Gardner, Miss	-	5	-
Home, Colonel	1	-	-
Kidd, Harry, Esq.	-	10	-
King, W. Y. Esq.	-	5	-
Meiklam, Miss	1	-	-
Muir, Thos. T. Esq.	-	5	-
Polwarth, Lord and Lady	2	-	-
Reay, Lady	1	-	-
Rutherford, Mrs.	-	5	-
S. W. E.	1	-	-
Tod, Miss	1	-	-
Sums under 5s.	4	11	6
Total	£20	17	6

Stirlingshire

BANNOCKBURN BRANCH.

(No Local Committee.)

Treasurer—
 ED. L. WILSON, Esq.

Annual Subscriptions.

	£.	s.	d.
Coll. by Miss Currie— Gilliepie, Mrs.	-	5	-
Wilson, Mrs. Col.	-	10	-
Sums under 5s.	2	11	-
Total	3	6	-
Coll. by Miss Wilson— Wilson, W. Esq.	-	5	-
Sums under 5s.	1	4	7
Total	1	9	7
Collected by Miss Ronald— Ronald, Mr.	-	5	-
Wilson, Miss E.	-	5	-
Wilson, W. R.	-	5	-
Wilson, E. L. Jun.	-	5	-
Sums under 5s.	-	15	6
Total	1	15	6
Coll. by Miss Bain— Sums under 5s.	1	13	6
Collected by Miss Durham, Auchen- bowie— Baird, Hugh, Esq.	1	1	-
McLaren, D. Esq.	-	5	-
Sums under 5s.	2	3	6

	£.	s.	d.
Galbraith, Mrs. W. R., London	1	1	-
Wilson, Alex. Esq.	1	1	-
Wilson, Ed. L.	2	2	-
Total	£15	18	1

FALKIRK BRANCH.

Local Committee—
 JAMES WILSON, Esq., Presi-
 dent.
 Major DOBBIE, Vice-Presi-
 dent.

THOMAS BINNIE, Esq.
 S. H. COSH, Esq.
 C. S. GAULD, Esq.
 J. COOKE GRAY, Esq.
 Ex-Provost GRIFFITHS.
 R. H. LOCHHEAD, Esq.

Hon. Sec. and Treasurer—
 THOMAS PAXTON, Esq.

Annual Subscriptions.

	£.	s.	d.
Aitken, James, Esq.	1	-	-
Baillie, Lady	1	-	-
Baird, William, Esq.	1	-	-
Binnie, Thos. Esq.	-	10	-
Buchanan, A.G. Esq.	-	10	-
Burns, James H. Esq.	-	10	-
Calder, J. & Co.	1	1	-
Dawson, A. & J. & Co.	1	-	-
Dobbie, Major	2	2	-
Fairlie, H. C. Esq.	2	2	-
Hamilton, Claude H. Esq.	-	10	-
Hewatson, R. Esq.	-	5	-
Hog, T. A. Esq.	1	-	-
Jones, James, Esq.	-	10	-
Learnmouth, T. Living- stone, Esq.	1	-	-
MacNab, John, Esq.	1	-	-
Nimmo, Colonel	1	-	-
Peebles, D. M. Esq.	-	10	-
Rankine, R. W. Esq.	1	1	-
Scott, James, Esq.	1	-	-
Sutherland, Robt. M. Esq.	-	5	-
Whitelaw, G.A. Esq.	1	1	-
Wilson, James, Esq.	5	-	-
Yellowlees, Rev. J.	-	10	-
Total	£40	2	-

Legacy.

Callander, Captain
 J., the late 1062 17 3

Donations.

Collection at Blair
 Lodge School, Sun-
 day Service 7 10 8
 Contribution Boxes 1 7 5
 Sums under 5s. - 13 6

Total Dons. 9 16 7
 Legacy 1062 17 3
 Total Subs. 40 2 -

£1112 15 10

GRANGEMOUTH BRANCH.

Local Committee—
 J. C. DICK.
 Baillie HENDRIE.
 S. P. JACKSON.
 Provost MACKAY.
 R. PIEDIE.

Honorary Treasurer and
 Secretary—
 FRANCIS QUIN.

Annual Subscriptions.

	£.	s.	d.
Aitken, John	-	10	6
Anderson, W. M.	-	10	6
Ballantyne, L. H.	-	5	-
Ballingoll, Geo.	-	5	-
Black, David	1	1	-
Brownlee & Co. Ltd.	1	1	-
Carron Company	5	5	-
Christensen & Svensen	1	1	-
Cowan, Thomas	1	-	-
Crawford & Company	1	1	-
Dick, James G.	1	1	-
Fischer, H. & Co.	1	1	-
Grangemouth Coal Co. Ltd.	1	1	-
Grangemouth Co- operative Society	2	-	-
Hay, J. & J. Ltd.	1	1	-
Hislop, John	1	1	-
Jacks, William, & Co.	1	1	-
Linton, Dr. (for 1895)	-	5	-
Mackay, A. & A. Y.	1	1	-
Mackay, J. S.	-	10	6
Macpherson & Mc- Laren, Ltd.	1	1	-
McCombe, John	-	5	-
McGregor Bros.	-	5	-
Merry & Cunning- ham, per J. H. Martin	1	1	-
Methven, J.	-	5	-
Nicol, Douglas	-	5	-
O'Hagan, Daniel	1	1	-
Palmer, George	-	5	-
Patterson, Dr.	-	7	6
Rankine, James, & Son	1	1	-
Rodgers, David	-	10	6
Rutherford, David	-	5	-
Salvesen, J. T. & Co.	1	1	-
Stark, James, & Son	-	5	-
Taylor, Wm.	-	10	-
Traill, David	-	5	-
Watson, James, & Co.	1	1	-
Wylie, J. & R.	-	5	-
Sums under 5s.	1	1	-
Total	£33	2	6

Donations.

Collected from—
 S.S. Derwent 14 6
 „ Maillands 2 9 6
 „ Aberforth - 17 -
 Collected at Custom
 House 5 4 6
 Sums under 5s. - 7 -

Total Dons. 9 12 6
 Total Subs. 33 2 6

STIRLING BRANCH.

Local Committee—
 Dr. GEORGE T. GALBRAITH,
 Chairman.
 DAVID BAXTER, Esq.
 Rev. C. L. COLDWELL.
 ALEXANDER CROWE, Esq.
 Rev. W. F. GOLDIE.
 Rev. J. T. GOWANLOCK.
 Rev. J. P. LANG.
 JOHN MCMATH, Esq.
 EX-PROVOST YELLOWLEES.
 ANDREW YOUNG, Esq.

Hon. Treasurer—
 Mr. DANIEL FERGUSON,
 National Bank.

Honorary Secretary—
 Mr. JOHN JENKINS, Solicitor.

Annual Subscriptions.	
£. s. d.	£. s. d.
Walls, Miss, collected by—	
Hodge, Miss..... 5	
Marshall, Robert, Esq..... 1	
Sandeman, Mrs..... 5	
Smith, J. Kemp, Esq..... 5	
Sums under 5s..... 3	17 9
Muirhead, Miss, collected by—	
Chalmers, Rev. J..... 5	
Cowbrough, R., Esq..... 5	
Cuthbertson, Dr..... 5	
Davidson, Miss..... 5	
Faulds, Miss..... 5	
Forrester, Misses..... 1	
Galbraith, Dr..... 5	
Galbraith, Misses..... 5	
Galbraith, T. L., Esq..... 5	
Gray, Mrs..... 5	
Hannay, Jno. Esq..... 5	
Marshall, Mrs..... 5	
McMath, John, Esq..... 5	
Morison, Miss..... 5	
Murray, Miss..... 5	
Rae, Mrs..... 5	
Reid, Mrs. James..... 1	
Stevenson, R. M., Esq..... 1	
Stevenson, Miss..... 10	
Ure, Mrs. J. R..... 5	
Wingate, Miss..... 5	
Sums under 5s..... 1	5 6
MacNab, Miss, collected by—	
Aitken, J. G. Esq..... 1	1
Bell, Mrs..... 5	
Bisset, Mrs..... 5	
Coldwell, Rev. C. L..... 5	
Crowe, Alex. Esq..... 5	
Graham, Wm. Esq..... 5	
Howat, Miss..... 5	
Renwick, W. Esq..... 10	
Richardson, Mrs. J. B..... 10	
Sinclair, Mrs. J. B..... 5	
Walker, Mrs..... 5	
Young, A. Esq..... 5	
Sums under 5s..... 2	3 6
Johnston, Miss Jane, collected by—	
Anderson, Misses..... 5	
Burden, Mrs..... 5	
Christie, Mrs..... 5	
Braehead..... 5	
Frew, Rev. Dr..... 5	
Johnston, Mrs..... 5	
Kidross, Henry, Esq..... 5	
Kirkwood, Miss..... 10	
Morton, Mrs..... 5	
Muir, Mrs..... 5	
Munro & Jamieson, Messrs..... 5	
Reid, Mrs., Wilhamfield..... 5	
Smith, Mrs. J. B..... 3	6 6
Sums under 5s..... 3	6 6
Maitland Bayne, Miss collected by—	
Chrystal & Morris, Messrs..... 5	
Ferguson, Daniel, Esq..... 5	
Gentleman, E. Esq..... 5	
Jenkins, A. & J., Messrs..... 7	6
Kinross & Sons, W., Messrs..... 5	
Macfarlane, John, Esq..... 5	
McLuskie, Robert, Esq..... 5	
Menzies, Ex-Bailie Morrison & Taylor, Messrs..... 7	6

Muir, Thos. Son. & Patton, Messrs..... 5	
Philp, Jas. L. Esq..... 5	
Thomson, Councilor Jas..... 5	
Walls, R. Esq..... 10	
Sums under 5s..... 1	16 6
McKenzie, Miss Agnes, collected by—	
Sums under 5s..... 17	6
Total.....£34 3 3	

Donations.

St. Ninian's Free Church Sabbath School..... 10	
Do. Bible Class for lads and young men..... 5	
Total Dons..... 15	
Total Subs.....34 3 3	
£34 18 3	

Sutherlandshire.

DORNOCH FIRTH AND EMBO BRANCH.

President—
His Grace the DUKE OF SUTHERLAND.

Local Committee—
R. T. HAMILTON - BRUCE, Dornoch, Chairman.
ALEXANDER ANGUS, Teacher, Dornoch.
W. S. FRASER, Dornoch.
JOHN LESLIE, Solicitor, Dornoch.
JOHN MACINTOSH, Farmer, Proncy.
MALCOLM M'DONALD, Chief Constable, Dornoch.
ALEXANDER M'KENZIE, Farmer, Skelbo.
JOHN MOYES, Teacher, Embo.
PROVOST SUTHERLAND, Dornoch.

Treasurer and Hon. Secretary—
DAVID PETERS.

Annual Subscriptions.

£. s. d.	£. s. d.
Sutherland, His Grace the Duke of..... 1	1
Barrow, J. J. (2 yrs.)..... 2	
Barrow, Mrs. ()..... 2	
Hamilton-Bruce, R. T..... 2	
Total Subs.....£7 1	

Donations.

"A Friend"..... 10	
Sums under 5s..... 2	17 6
Total.....£10 8 6	

Highdownshire.
PORT LOGAN AND BAY OF LUCE BRANCH.

Patron—
The Right Hon. the EARL OF STAIR, K.T.

President—
KENNETH A. MCDONALD, Esq.

Local Committee—
Sir MARK J. STEWART, Bart., Chairman.
DAVID FREDERICK, Esq.
Rev. F. J. GUTTRIDGE.
GAVIN H. LOVE, Esq.
JOHN MARSHALL, Esq.
DAVID A. MCGLEW, Esq.
JOSEPH TROUT, Esq.

Honorary Secretary—
WILLIAM COCHRANE, Esq.

Annual Subscriptions.

£. s. d.	£. s. d.
Frederick, David, Esq..... 10	
Haig, John & Co., Ltd..... 10	
Love, Gavin H. Esq..... 10	
Marshall, John, Esq..... 10	
McDonall, Jas., Esq..... 5	
McLeay, Duff & Co..... 10	
McTaggart, Mrs. Ommany..... 1	1
Moore, J. Carrick, Esq..... 2	2
Richardson, T. B. Esq..... 10	
Stair, The Earl of, K.T..... 5	
Stewart, Sir Mark J., Bart..... 1	1
Young, Robt. Esq..... 10	
Younger, George & Son..... 10	
Collector's Book..... 6	13 6
Total Subs.....£24 17 6	

Donations.

Sundry..... 1	12
Contribution Boxes..... 17	8
Total.....£27 7 2	

PORT PATRICK BRANCH.

President and Chairman—
Major BASIL E. SPRAGGE, D.S.O.

Local Committee—
Mr. A. McDONALD.
Dr. A. T. MACKINTOSH.
Major BASIL E. SPRAGGE, D.S.O.
Mr. SAM. VINT.

Hon. Treasurer and Sec.—
Rev. JAMES R. KENNEDY.

Annual Subscriptions.

Donaldson, Rev. S. A. I..... 1	
Dunskey Estate..... 2	
Friend, per Miss Stewart..... 1	
McConnochie, Mrs..... 1	
Minot, Miss..... 10	
Sprague, Major..... 1	
Wason Mrs..... 1	
Sums under 5s..... 2	6
Total Subs.....£7 15 6	

Donations.

Contribution Boxes..... 3	15 2
Total.....£11 10 8	

WHITHORN AND BAY OF WIGTOWN BRANCH.

Patron—
The Right Hon. the EARL OF GALLOWAY, K.T.

President—
R. H. JOHNSTON STEWART, Esq.

Local Committee—
Hon. ALEXANDER STEWART, Honorary Chairman.
F. S. HEAD, Esq., Castlewigg, Chairman.
JAMES ALEXANDER.
JOHN P. ANDERSON.
JAMES D. BROWN.
ALEXANDER DONNAN.
ALEXANDER W. DONNAN.
FRANK FINDLAY.
ALEXANDER FRASER.
ROBERT C. GOURLAY.
PROVOST HAWTHORN.
ROBERT C. LAWRIE.
ALEX. MACFIE, J.P.
JOHN G. MARTIN.
WM. MCGAA.
Geo. MCLLWRAITH.
JOHN PARLANE.
THOMAS SPEDDING.

Honorary Secretary—
WM. BURNS, Esq.

Annual Subscriptions.

£. s. d.	£. s. d.
Bute, The Most Noble the Marquis of, K.T..... 1	
Galloway, Right Hon. the Earl of, K.T..... 5	
Stair, Right Hon. the Earl of, K.T..... 1	1
Allan, Rev. Wm..... 5	
Armitage, A. C..... 1	
Black, John..... 5	
Blair, Mrs. Maxwell..... 1	
Brown, J..... 5	
Brown, James Donnan..... 5	
Callander, Wm..... 5	
Donnan, Alex..... 5	
Gifford, Geo..... 5	
Hamilton, W. M. F. I..... 1	
Head, Francis S. Esq..... 5	
Kennedy, Admiral..... 1	
McEwen, Walter..... 5	
McIlwraith, Ivie..... 5	
McMaster, Hugh..... 5	
McTaggart, Rev. James C., M.A..... 5	
Martin, John G..... 5	
Maxwell, Sir Herbert E., Bart., M.P..... 1	
Maxwell, Lady..... 2	
Nicholson, A. B..... 5	
Nicholson, Jno. Esq..... 5	
Parlane, Mrs. Jas..... 1	
Routledge, C. M..... 5	
Selby, R. B..... 5	
Shaw, D. B..... 5	
Stewart, Alex..... 5	
Stewart, R. H. J. Esq..... 1	
Stocks, Mrs..... 10	
Walker, Henry H..... 5	
Sums under 5s..... 11	18 2
Total Subs.....38 4 2	

Donations.

Contribution box..... 16	10
Total.....£39 1	

IRELAND.

Co. Antrim.

BELFAST AND GROOMSPORT BRANCH.

Presidents—
The MARQUIS OF DUFFERIN AND AYA, K.P.
Major R. PERCEVAL
MAXWELL, J.P.

Local Committee—
W. J. PIRRIE, Esq., J.P.,
Lord Mayor of Belfast,
Chairman.
G. HERBERT BROWN, Esq.,
J.P.
ARTHUR HILL COATES, Esq.
A. NORMAN CHARLEY, Esq.
ARTHUR HERDMAN, Esq.
Rev. S. S. HOLMES, M.A.
Captain MASTERMAN, R.N.
H. H. MCNEILE, Esq., D.L.
S. VANCE, Esq.
R. E. WARD, Esq., D.L.

Hon. Treasurer and Sec.—
R. GRAHAM LINNISAY, Esq.

Annual Subscriptions.

	£.	s.	d.
Adair, Hugh, Esq.	5		
Agnew, Alex. Esq.	5		
Anderson, Messrs.			
D. & Son	1		
Arnott & Co. (Limited)			
Messrs.	10		
Barkley and Sons,			
Messrs. M.	5		
Belfast Harbour Com-			
missioners	10		
"Belfast Newsletter,"			
Proprietors	10		
Belfast Steamship Co.			
(Limited)	2	2	
Blackstaff Spinning			
Company (Limited)	10		
Boag, Robert, Esq.	5		
Braddell, Messrs. & Co.	5		
Bretland, J. C., C.E.	5		
Brown and Sons,			
Messrs. John S.	1		
Brown, G. H. Esq.,			
J.P.	1		
Campbell and Co.			
Messrs. H.	10		
Carson, Wm. Esq.	1		
Carwell & Sons, R.	5		
Clark, Geo. S. Esq.	10		
Coates, A. Hill, Esq.	1		
Coates, Victor & Co.			
(Limited), Messrs. 1			
Coe, Edwd. Esq.	1		
Combe, Barbour, &			
Combe, Messrs.	10		
Corry & Co., Messrs.			
J. P.	1		
Craig, H. C. Esq.	10		
Crawford and Lock-			
hart, Messrs.	1		
Crawford, James and			
Sons, Messrs.	10		
Cunningham, Jas.			
Esq.	1		
Dickey, E. O. R. Esq.	1		
Dixon & Son, Messrs.	1		
Dufferin and Aya,			
The Marquis of	1		
Dunville and Co.,			
Messrs. (Limited)	10		

	£.	s.	d.
Ewart and Son,			
Lim, Messrs. W.	1		
Ewing, Son, and Co.			
Messrs.	5		
Fisher, John, Esq.	5		
Fulton, David, Esq.	10		
Furey, H. Esq.	5		
Gaffikin, Wm. Esq.	5		
Gaffikin, Mrs.	5		
Gamble, James.	1		
Gibson, Andrew, Esq.	10		
Gorman, T. B. Esq.	5		
Grainger, W. A. Esq.	5		
Grattan, Messrs. &			
Co., Limited	10		
Hart and Churchill,			
Messrs.	10		
Haslett, Sir Jas. M.P.	10		
Houston, J. B. Esq.	1		
Jaffé Brothers, Messrs.	1		
Jenkins, Messrs. W.			
J.	1		
Johnston, R. S. & Co.	5		
Johnston and Sons,			
Messrs. W. J.	5		
Kelly, H. C. Esq.	5		
Kingan, Saml. Esq.	1		
Kyle, G. W., Messrs.	5		
Laird, Wm. Esq.	2	6	
Langtry, E.	2	6	
Leahy, Kelly &			
Leahy, Messrs.	5		
Lepper, Frank, Esq.	10		
Lindsay Bros. Messrs.			
(Limited)	10		
Lindsay, R. W. Esq.	5		
Little & Co., Messrs.			
Jas.	10		
Lowry & Co., Messrs.	5		
Lytle and Sons, Messrs.			
John	5		
Macdonald, Eugenie	5		
MacEilheran, W. F.			
Esq.	5		
MacLean, S. T. Esq.	1		
MacNaughten, N.			
Esq.	10		
Mater & Co., Messrs.			
H.	10		
Maxwell, Major	1		
McCausland, Saml.			
Esq.	10		
McConkey, Wm.	5		
McCormick, H. McN.			
Esq.	10		
McCrum, Watson &			
Mercer. M.	1		
McLaughlin, W. H.			
Esq.	1		
McMullan, Thos. Esq.	5		
McNeile, H. H., D.L.	5		
Meenan, Mrs.	5		
Millar, Boyd & Reid,			
Messrs.	10		
Montgomery, S. G.			
Esq.	10		
Moore and Weinberg,			
Messrs.	10		
Moore, James, Esq.	10		
Musgrave, Sir Jas.			
Bart., D.L.	1		
Murphy & Orr, Messrs.	5		
Neill, H. J. Esq.	1		
Neill, Jas. Esq.	5		
Orr, Robert H. Esq.	1		
Patterson, Rich. Esq.	10		
Pim, Messrs. E. & W.	5		
Pim, Messrs. J. & Son	10		
Pim, Joshua, Esq.	5		
Purdon, H. S. Esq.,			
M.D.	5		
Purser, John, Esq.	10		
Rea, W. R. Esq.	5		
Reid, Wm. Esq.	5		
Richardson Brothers			
& Co., Messrs.	1		
Riddel, Saml. Esq.	1		
Ritchie, Francis, &			
Sons	10		
Robertson, Ledlie,			
Ferguson & Co.,			
Limited	10		

	£.	s.	d.
Robinson & Cleaver,			
Messrs.	5		
Robson, John, Esq.	5		
Rodman, Wm. Esq.	5		
Royal Ulster Yacht			
Club	2		
Shaftesbury, Countess			
of	1		
Sharman & Crawford,			
Capt. R. G.	1		
Shaw, Fred, Esq.	5		
Shaw, John G. Esq.	5		
Simms, F. B. Esq.	5		
Smith, Messrs. J.			
and T.	10		
Stelfox, James, Esq.	5		
Springer, John, Esq.	5		
Tate, Alex. Esq.	10		
Tedford, Jas. Esq.	5		
Wallace, Lady the late	5		
Ward, R. E., D.L.	1		
Weir, John, Esq.	5		
Wolfhill Spinning			
Co. (Limited)	10		
Woodside, W. J. Esq.	5		
Workman, Messrs.			
J. and R.	10		
Workman, F. Esq.	5		
Young & Mackenzie,			
Messrs.	10		
Total	£24	13	
Donations.			
"Ned" Box	2	13	4
Royal Avenue Hotel			
Box	5	6	
Pillar Box at Northern			
Counties Railway			
Station	11	1	
do. County Down	6	9	
Sums under 5s.	4		
Total Dona.	4	8	
Total Subs.	£28	13	8

CARRICKFERGUS BRANCH.

President—
ALFRED J. A. LEPPER, Esq.,
J.P.
Chairman—
DANIEL BOWMAN, Esq., J.P.
Local Committee—
JAMES BOYD, Esq.
ROBERT CAMBRIDGE, Esq.
J. C. HOLDEN, Esq.
CHARLES M. LEGG, Esq.
J. B. PIRRIE, Esq.
Captain R. SHAW.
BRUCE SMITH, Esq.
THOMAS VINT, Esq.
JOHN WETHERUP, Esq.

THE DIVISIONAL OFFICER OF COASTGUARD.

Treasurer—
DAVID PASLEY, Esq.
Hon. Sec.—
J. C. HOLDEN, Esq.
Assistant Sec.—
Mr. ROBERT CARNAGHAN.

	£.	s.	d.
Annual Subscriptions.			
Hall, Mrs. Basil, sen.	5		
Shannon, Mrs. S. M.	10		
Total Subs.	15		
Donations.			
Contribution Boxes.	1	5	1
Balance per Demon-			
stration Fund.	1	6	4
Total	£3	6	5

PORTRUSH BRANCH.

President—
Major-General
J. BERESFORD BERESFORD,
J.P.

Local Committee—
U. G. BROWNRIFF, Esq., J.P.
ROBT. CROOKSHANK, Esq.
J. C. MARTIN, Esq., M.D.
Capt. I. M. MONTGOMERY.
Rev. JOHN PIM, B.D.
Rev. JONATHAN SIMPSON, J.P.
Capt. FREDR. H. WATT.

Hon. Secretary & Treasurer—
W. J. MORROW, Esq.

Annual Subscriptions.

	£.	s.	d.
Alexander, J.	10		
B. & N. C. Railway			
Co., per W. R. Gill,			
Esq.	2		
Beresford, Major-Gen.			
John Beresford, J.P.	1		
Bevington, Col. S. B. 1			
Brownrigg, Q. G.			
Esq.	10		
Causton, Commander			
A. M., R.N.	1		
Christie, Daniel, Esq.	5		
Cox, Mrs. S. L.	1		
Cramsie, Capt. J.P.	1		
Crookshank, R. Esq.	10		
Denham, Mrs. Dr.	5		
Finlayson, Mrs. John	5		
Grant, P. Drummond	5		
Huey, John, Esq., J.P.	10		
Hunter, Stewart, Esq.	10		
Leech, H. W. Esq.	5		
Leslie, Col. J.P., D.L.	1		
Macaulay, H. A. Esq.	5		
Macnaughten, Rt. Hon.			
Lord	1		
Martin, J. C. Esq.,			
M.D.	10		
McCleery, J. O.	1		
McCrea & Macfarlan	10		
Montagu, R. A. C.	5		
Montgomery, Capt.			
I. M.	1		
Morrow, W. J.	5		
Murray, Lt.-Col. J.P.	1		
Pim, Rev. John, B.D.	1		
Portrush Harbour Co.	2		
Simpson, Rev.			
Jonathan, J.P.	1		
Taylor, Robt. A. Esq.,			
J.P.	1		
Thompson, J.	5		
Torrens, Major	1		
Troughton, James	10		
Watt, Capt.	1		
Total	£25	7	

Donations.

B. & N. C. R. pillar-			
box	6	5	
Boat-house door-box	8	10	
Collected during			
launches	13		
Donation	10		
Northern Counties'			
Hotel Bar	10	4	
Sums under 5s.	2	6	
Total Dona.	14	18	9
Total Subs.	25	7	

Total	£40	5	9
-------	-----	---	---

Co. Caban.

CAVAN BRANCH.

President—
The Right Hon.
THE EARL OF LANESBOROUGH.

Honorary Secretary—
Mrs. SANDERSON.

Annual Subscriptions.

	£.	s.	d.
Alexander, Miss R. A.	5	—	—
Boland, Mr. Timothy	5	—	—
Clements, Mrs.	1	—	—
Clifford, Mrs. Carn	5	—	—
Fegat, John, Esq.	5	—	—
Fegan, Wm. J. Esq.	5	—	—
Garrett, Mrs. Moore	10	—	—
Kilmore, Bishop of	10	—	—
Lanesborough, the	—	—	—
Earl of	2	2	—
Maxwell, Hon. Mrs.	10	6	—
Nicholson, Miss	5	—	—
Sanderson, Samuel,	—	—	—
Esq.	1	—	—
Sanderson, Mrs.	10	—	—
Saunderson, Colonel,	—	—	—
M.P.	1	—	—
Venables, Mrs. Whyte	5	—	—
Total	£8	17	6

Donations.

Allen, Richard, Esq.	5	—	—
Beresford, G. D.	10	—	—
Burrows, Mrs. (Dornden)	1	—	—
Clements, Colonel.	10	—	—
Clifford, Mrs. (Green-ville)	5	—	—
Fay, John, Esq.	5	—	—
Hartley, James, Esq.	10	—	—
Humphreys, W. Esq.	10	—	—
In Memoriam J. R. 1	—	—	—
Johnstone, B. H. Esq.	10	6	—
Leslie, Cecil, Esq.	1	—	—
Lough, Mrs.	5	—	—
Reynell, The Misses	1	—	—
Roe, Surgeon-Gen.	1	—	—
Sclater, E. Esq.	10	—	—
Smith, Fred, Esq.	10	—	—
Tatlow, J. G. Esq.	10	—	—
Trench, A. Esq.	10	—	—
Vernon, Fane, Esq.	1	—	—
Walker, Robert, Esq.	5	—	—
Walker, W. N. Esq.	1	—	—
Winter, J. S. Esq.	1	—	—
Collection St. John's Church, Cloverhill	10	8	—
Small sums	2	6	—
Total Dons	15	8	8
Total Subs	8	17	6
Total	£24	6	2

Co. Cork.

BALLYCOTTON BRANCH.

Patron—
The Right Rev. the LORD
BISHOP OF CORK, CLOYNE,
AND ROSS.

President—
Capt. MONTFORT J. C.
LONGFIELD.

Local Committee—

Mr. W. H. FORDE.
W. LITCHFIELD, Esq.
J. B. MCKENZIE, Esq.
Mr. MICHAEL O'KEEFE.

Honorary Secretary—

T. W. STRANGMAN, Esq.
Assistant Hon. Secretary—
Rev. AYLMER C. MARTIN.

Annual Subscriptions.

	£.	s.	d.
Beale, Alfred, Esq.	5	—	—
Beale, Henry H. Esq.	10	—	—
Bristol General Steam Navigation Co.	1	—	—
City of Cork Steam Packet Company	5	—	—
Clyde Shipping Comp.	3	3	—
Cork Harbour Com.	5	—	—
Cork, Lord Bishop of	1	—	—
Cork Steamship Co.	2	—	—
Cunard Company	2	2	—
Fitzgerald, J. Pen-rose, Esq.	10	—	—
Forde, Mr. W. H.	7	6	—
Gaggin, Miss.	5	—	—
Houghton, B. & Co., Messrs.	1	—	—
Hearne, T. P. Esq.	1	1	—
H. H. H.	5	—	—
Litchfield, W. Esq.	5	—	—
Littou, E. de l'E. Esq.	1	1	—
Longfield, Captain	—	—	—
Montfort, J. C.	2	—	—
Martin, Rev. Aylmer, C.	10	—	—
Mckenzie's, Limited,	10	—	—
Cork	10	—	—
McKenzie, J. B. Esq.	5	—	—
Newsom, S. H. Esq.	1	—	—
Strangman, T. W. Esq.	1	—	—
Total Subs	£29	19	6

Donations.

Contribution Boxes	1	2	3
Sundry	4	6	—
Total	£31	6	9

CORK AND QUEENS-TOWN BRANCH.

Patron—
The Right Reverend the
LORD BISHOP OF CLOYNE.

President—
The Right Worshipful the
MAYOR OF CORK (P. H.
MEADE, Esq.).

Vice-President—
J. OGLIVIE, Esq., J.P., Chair-
man of the Cork Harbour
Commissioners.

Chairman—
Rear-Admiral BUCKLE,
Admiral Commanding Irish
Station.

Vice-Chairman—
JAMES LONG, Esq., Chairman
of the Queenstown Town
Commissioners.

Local Committee—
Capt. BOARDMAN, R.N., C.B.
W. J. CUMMINS, Esq.
Rev. Wm. DAUNT, M.A.
GEORGE DAWSON, Esq.
E. DEAN, Esq., Manager of
the Cunard Co.
Capt. EDWARDS, Principal
Officer of Board of Trade.
Sir R. U. PENROSE FITZ-
GERALD, Bart., M.P., D.L.
Capt. HALL, Inspecting Com-
mander of H.M. Coast-guard,
Kinsale.
Rev. M. HIGGINS, A.D.M.
Inspecting Commander of
Coastguard, Queenstown.
Capt. LANGDON, R.N.
THOMAS MILLER, Esq.
R. K. MILLS, Esq.
J. W. SCOTT, Esq., J.P.
Capt. SUTTON, Harbour Master.
The Flag-Lieutenant.
The Receiver of Wrecks,
Cork.

Hon. Solicitor—
A. H. ALLEN.

Hon. Engineer—
JAS. PRICE, C.E.

Hon. Secretary & Treasurer—
Capt. USBORNE, R.N.

Annual Subscriptions.

	£.	s.	d.
Beamish & Crawford,	1	—	—
Messrs.	1	—	—
Buckle, Admiral	1	—	—
Carroll, J. Esq.	10	—	—
City of Cork Steam Packet Co.	10	—	—
Clyde Shipping Co.	2	2	—
Cork Harbour Com- missioners	10	—	—
Cork Steam Ship Co.	1	—	—
Fitzgerald, Sir R. U. Penrose	1	1	—
Foley, R. Esq.	1	1	—
Green, W. T. Esq.	1	1	—
Hale, Mrs.	1	1	—
Hale, W. W. Esq.	2	2	—
Hall, R. and H., & Co., Messrs.	2	—	—
MacMullen, J. W. Esq.	1	1	—
Murphy, James, & Co., Messrs.	1	—	—
Newsom, J. C. Esq.	1	—	—
Ogilvie & Moore, Ltd.	1	—	—
O'Reilly, Messrs.	1	—	—
Scott, Sir John	2	2	—
Smith-Barry, A. H. Esq., M.P.	2	—	—
Thompson, F. H., & Son, Messrs.	1	1	—
White Star Co.	5	—	—
Total	£49	1	—

Donations.

Contribution Boxes— Mercantile Marine, Queenstown, ...	12	1	—
Railway Station, Cork	5	2	—
Mercantile Marine, Cork	5	14	6
Boxes under 5s.	9	4	—
Total Dons ..	7	1	1
Total Subs ..	49	1	—
Total	£56	2	1

COURTMACSHERRY BRANCH.

Local Committee—
Rev. W. FORDE.
Mr. W. B. LESLIE.
Mr. M. LONGFIELD.
Rev. T. MACCARTHY.
OFFICE OF COASTGUARD *pro tem*.
The Rt. Hon. THE EARL OF SHANNON.
Col. ALCOCK STAWELL.

Honorary Secretary—
Captain TOWNSHEND.

Annual Subscriptions.

	£.	s.	d.
Cork Steam Ship Co.	2	2	—
Forde, Rev. W.	10	—	—
Leslie, W. B. Esq.	10	—	—
Longfield, M. Esq., J.P.	10	—	—
MacCarthy, Rev. T., P.P.	10	—	—
Shannon, Lord	5	—	—
Stawell, Col. A.	1	—	—
Townshend, Captain	1	—	—
Total Subs	£11	2	—

Donations.

Contribution Boxes	3	—	—
Total	£11	5	—

YOUGHAL BRANCH.

Local Committee—
Mr. R. CAREY, J.P.,
Chairman.

Mr. H. F. ALLIN, J.P.
Mr. J. CONDON.
Lieut. H. B. DILLON, R.N
(Div. Officer Coastguard).
Mr. E. FOLEY.
Mr. E. FOLEY.
Mr. T. W. M. FUGE, J.P.
Mr. M. FLEMING.
Rev. W. S. GREEN (In-
spector of Fisheries).
Mr. W. HODNETT.
Mr. D. KAVENAGH.
Mr. J. G. F. LINEHAN, J.P.
Mr. M. KENNEDY.
Mr. S. J. MERRICK.
Mr. JAMES TARBETT
(Officer of Customs).
Mr. W. J. VERLIN.

Honorary Secretary—
J. H. LONG.

Annual Subscriptions.

Allin, H. F. Esq., J.P.	5	—	—
Devonshire, Duke of	5	—	—
Foley, R. Esq.	1	—	—
Farrel, R. Esq.	5	—	—
Green, Rev. Wm. S.	1	—	—
Hyde, Miss	5	—	—
Lloyd, G. W. Esq.	3	—	—
Merrick, S. J. Esq.	1	—	—
Sums under 5s.	2	6	—
Total Subs	£11	17	6

Donations.

Contribution Boxes	1	9	—
Total	£11	19	3

Co. Donegal.

COUNTY DONEGAL BRANCH.

President—
His Grace the DUKE OF
ABERCOEN, K.G.

Local Committee—
Capt. KNOX, D.L., Chairman.

Hon. Secretary & Treasurer—
Mrs. JOHN HERDMAN.

Annual Subscriptions.

	£.	s.	d.
Herdman, E. T. Esq.	1	-	-
Herdman, F. S. Esq.	10	-	-
Herdman, John, Esq.	1	-	-
Humfrey, Mrs.	5	-	-
Knox, Capt.	1	-	-
Knox, Mrs.	5	-	-
McClintock, R. Esq.	5	-	-
Musgrave, Sir James	1	-	-
Stewart, R. Esq.	5	-	-
Total	26	10	-

Donations.

Gweedore Hotel	13	6
Boyle's Hotel, Dun- gloe	5	-
Proceeds of Con- cert, per Hon. Sec.	11	9 6
Total Dons.	12	8 -
Total Subs.	6	10 -
	£18	18 -

ARANMORE BRANCH.

Local Committee—

JOHN POMEROY, Chairman.
Rev. J. BRENNAN, C.C.
Rev. HUGH GALLAGHER, P.P.
Major GOSSLEIN.
Mr. SAMUEL HANLON.
E. HERDMAN, Esq.
J. HERDMAN, Esq.
Mr. DAN KROWN.
Mr. A. O'DONNELL, J.P.
Mr. JAS. SWENNY, J.P.
Rev. JAS. WALKER, P.P.
Rev. W. J. WALLACE.

Hon. Secretary—
WILLIAM SMYTH, Esq., M.D.,
J.P.

(No List for 1896)

CULDAFF BRANCH.

President and Chairman—
ROBERT G. YOUNG, Esq.

Local Committee—

JAMES G. M. HARVEY, Esq.
Rev. T. C. HOUSTON.
Rev. ARTHUR J. JOHNSTONE.
JOHN C. MCCLINTOCK, Esq.
W. H. McORMICK, Esq., J.P.
JAMES MCGLINCHY, Esq.,
J.P.
Rev. W. MCGLINCHY, P.P.
JAMES MCSHEFFREY, Esq.,
J.P.
ROBERT MOORE, Esq.
ROBERT MOORE, Junr., Esq.
Rev. R. MORRISON.
WALTER PRING, Esq.
Rev. W. SPROULE.
J. N. THOMPSON, Esq., J.P.
GEORGE L. YOUNG, Esq., J.P.
HENRY C. YOUNG, Esq.

Treasurer and Honorary
Secretary—
R. M. FLEMING, Esq., J.P.

Collector—
JAS. MCGLINCHY, Esq., J.P.

Annual Subscriptions.

	£.	s.	d.
Farnan, Rev. M., P.P.	5	-	-
Fleming, R. M., Esq., J.P.	10	-	-
McCauldless Wm., Esq., J.P.	10	-	-
McCormick, W. H., Esq., J.P.	10	-	-
McGlinchy, James, Esq., J.P.	16	-	-
McGlinchy, Rev. Wm., P.P.	10	-	-
Total	£2	15 -	-

Co. Down.

BALLYWALTER BRANCH.

Local Committee—
The Right Hon. Lord DUN-
LEATH.

Mr. ELLIS, Chief Officer of
Coastguard.
Mr. A. GLOVER.
J. B. HOUSTON, Esq., V.L.
Mr. H. MAGILL.

Honorary Secretary—
Rev. Dr. GREER.

Hon. Treas.—
JAS. B. GLOVER, Esq.

Annual Subscriptions.

	£.	s.	d.
Belfast Steam Ship- ping Co., per J. McDowell, Esq.	2	2	-
Cleland, Mrs. (Bally- walter)	5	-	-
Dunbar-Buller, Mrs.	1	-	-
Dunleath, The Right Hon. Lord	2	-	-
Glover, Jas. B.	5	-	-
Greer, Rev. Dr.	5	-	-
Houston, J. B. Esq.	1	-	-
Lyle, Rev. Canon	5	-	-
Sinclair and Boyd, Messrs.	1	-	-
Stewart, H. Hamill, Esq.	2	-	-
Ward, The Hon. S.	10	-	-
Total Subs.	£10	12 -	-

Donations.

Contribution Boxes	12	6
Total	11	4 6

CLOUGHY BRANCH.

Local Committee—
GEORGE E. BOWEN, Esq., J.P.
Chairman.

JAMES B. ATKINSON, Esq.,
J.P.

Mr. WM. CAVAN.
Mr. THOMAS MCMULLAN.
Mr. ROBERT PARK.
Mr. GEORGE WATSON.
Capt. WHITE, R.V.
Rev. A. W. WHITLEY.

Treasurer—
W. E. ROGERS, Esq.

Honorary Secretary—
JOHN MCMULLAN, Esq.

Annual Subscriptions.

	£.	s.	d.
Atkinson, J. B. Esq., J.P.	1	-	-
Blairst, Joseph, Esq.	5	-	-
Balmer & Co. Messrs. John	5	-	-
Bowen, G. E. Esq., J.P.	10	-	-
Brown, Wm.	5	-	-
Clarke & Co. Messrs. John	10	-	-
Donnan, H. Esq. J.P.	10	-	-
Fulton & Co. Messrs. John	10	-	-
Gibson, Samuel, Esq.	10	-	-
McDonnell & Sons, Messrs. James	10	-	-
McKnight, Dickson & Co. Messrs.	10	-	-
McMullan, A.	5	-	-
McMullan, T.	5	-	-
Nugent, Gen.	2	-	-
Park, Robert, Esq.	1	-	-
Rogers, W. E. Esq.	10	-	-
Shaw & McMullan, Messrs.	10	-	-
Simms & Co. Messrs.	5	-	-
Stirling, Richd. Esq.	1	-	-
Thompson, McVea, and Bannister, Messrs.	5	-	-
Watson, Geo. Esq.	5	-	-
Whitley, Rev. A. W.	5	-	-
Workman, Rev. R.	1	-	-
McArthur and Mitchell, Messrs.	10	-	-
Mayne, Thos. Esq.	10	-	-
McBride, Father	5	-	-
Total Subs.	£14	-	-

Donations.

Contribution Boxes	1	3
Total	£14	1 3

**NEWCASTLE (DUN-
DRUM) BRANCH.**

President—
The Right Hon.
THE EARL OF RODEN.

Local Committee—
G. GRAY, Esq., M.D.
(Chairman and Honorary
Secretary.

C. BROWNLOW, Esq.
S. A. CLARENDON, Esq., M.B.
F. W. FORREST, Esq.
A. GALLAGHER, Esq., J.P.
Lieut. H.B. HAWKSHAW, R.N.
The Rt. Hon. the EARL OF
RODEN.
P. TROWSDALE, Esq.
A. A. USSHER, Esq.

Annual Subscriptions.

	£.	s.	d.
Brownlow, C. Esq.	5	-	-
Brush, Geo. Esq.	10	-	-
Cuichester, Mr.	5	-	-
Clarendon, S. Esq., M.B.	1	-	-
Cutbill, Colonel	5	-	-
Davidson, J. Esq.	5	-	-
Eagar, Mrs.	5	-	-
Feilden, Mrs.	5	-	-
Forrest, F. W. Esq.	5	-	-
Gallagher, A. Esq. J.P.	5	-	-
Godfrey, Mr.	5	-	-
Gray, G. Esq., M.D.	5	-	-
Hamilton, W. J., Killishandra (20th collection)	2	2	5
Hawkshaw, Lieut. H. B., R.N.	10	-	-
Hoey, F. Esq.	10	-	-
Kilmorey, Earl of	5	-	-
Knox, Mrs.	5	-	-
Lawrence, J. Esq.	5	-	-
Lindsay, Mrs.	5	-	-
McConnell, Mrs.	1	-	-
McCraith, Miss C.	5	-	-
McKeown, Dr.	5	-	-
Murland, C. W. Esq.	1	-	-
Playfair, C. Esq.	5	-	-
Pollock, H. M. Esq.	5	-	-
Roden, The Earl of	2	-	-
Seymour, Rev. Canon, the late	1	-	-
Smith, W., jun., Esq.	5	-	-
Smythe, Mrs.	5	-	-
Wilson, Miss	10	-	-
Usher, A. A. Esq.	5	-	-
Sums under 5s.	1	17	-
Total	£21	19 5	-

Donations.

Contribution Boxes	1	10	5
Total Dons.	1	10	5
Total Subs.	£21	19	5
	£33	9	10

NEWRY BRANCH.

(No Local Committee.)

Honorary Secretary—

(No List for 1896.)

TYRELLA BRANCH.

Local Committee—
Rev. J. J. DEACON.
E. G. HENESEY, Esq.
W. I. QUINN, Esq.

Honorary Secretary—
Rev. DAVID KENNEDY.

Annual Subscriptions.

The Marquis of Down- shire	5	-	-
Deacon, Rev. J. J.	5	-	-
East Downshire S. S. Co. Dundrum per E.G. Henesey, Esq.	2	2	-
Kennedy, Rev. D.	5	-	-
Martin, Wm. B. Esq.	5	-	-
Montgomery, General	1	-	-

	£.	s.	d.
Reid, Mr.....	10	-	-
Roe, Lord de.....	1	-	-
Woulfe, — Esq.....	1	1	-
Total Subs..	£11	8	-
Donations.			
Contribution Boxes. —	7	-	-
Total	£11	15	-

Co. Dublin.

DUBLIN AND POOL-BEG BRANCH.

Local Committee—
 The Right Hon. LORD ARDILAUN, D.L.
 ALFRED W. EGAN, Esq.
 J. MALCOLM INGLIS, Esq., J.P.
 LORD IVEAGH, K.P.
 Commander WALKER STUART KING, R.N.
 The Right Hon. Sir RICHARD MARTIN, Bart., D.L., J.P.
 THOMAS PIM, Esq.
 Capt. G. COLQUHOUN SCORCE, I.N., F.R.G.S.
 ANDREW TAYLOR, Esq.
 Captain ALEXANDER A. WALKER.

Honorary Secretary—
 THOMAS EDMONDSON, Esq.

Assistant Secretary—
 J. S. MORGAN.

Annual Subscriptions.

	£.	s.	d.
His Excellency, The Earl of Cadogan..	10	-	-
Ardilaun, The Right Hon. Lord	2	-	-
Armstrong & Co., Ltd.	1	-	-
Arnott & Co., Ltd..	3	-	-
Baker & Sons, Messrs. Wm.	5	-	-
Beauchamp, Richard H. Esq.	1	-	-
Bewley, S. Esq.	1	-	-
Boyd, J. B. Esq.	10	-	-
Boyle, Low, Murray, and Co., Messrs.	2	-	-
British & Irish Steam-packet Co., Ltd.	2	2	-
Brooke & Son, Messrs. G. F.	1	-	-
Brown, Thomas, and Co., Messrs.	1	-	-
Burke, E. & J., Ltd.	1	-	-
Burrows, Mrs. Ann.	1	-	-
Cantrell & Cochrane, Messrs.	1	-	-
City of Dublin Steam-packet Company.	2	2	-
Clery & Co., Messrs.	1	-	-
Cook, Thos. & Son, Messrs. (Cook's Tours)	2	2	-
De Vesci, Lord	2	-	-
Dickson, Richard & Co., Messrs.	1	1	-
Dockrell, Messrs. T. Sons & Co., Ltd.	5	-	-
Drummond & Sons, Ltd., Messrs. Wm.	1	-	-

	£.	s.	d.
Dublin and Liverpool Screw Steam-ship Company	2	-	-
Dublin Distillers Co., Ltd. (Messrs. Geo. Roe & Co.)	1	-	-
Eason, Charles, Esq., Jun.	1	-	-
Edmondson, Thomas, Esq.	1	-	-
Edmondson, J. & Co. Limited, Messrs.	1	-	-
Ferrier & Co., Ltd., Messrs.	1	-	-
Figgs, E. J. Esq.	1	-	-
Findlater, J. Esq. J.P.	2	-	-
Gilbey, Messrs. W. and A.	1	1	-
Guinness, A., Son & Co., Ltd., Messrs.	3	3	-
Hall, R. & H., Ltd.	1	-	-
Helton & Co., Messrs. T., Ltd.	1	-	-
Henshaw, Thomas & Co., Messrs.	1	-	-
Hogg, Wm. & Co., Messrs.	1	-	-
Inglis, J. Malcolm, Esq., J.P.	1	1	-
Iveagh, Lord, Rt. Hon. K.P.	2	-	-
Jacob, W. & R. & Co., Ltd., Messrs.	1	-	-
Jameson and Son, Ltd., Messrs. John	2	-	-
Jameson, Pim, & Co., Messrs.	1	-	-
Kenny and Owens, Messrs.	10	-	-
Lambert, Brien, and Co., Messrs.	1	-	-
Lipton, Thomas J. Esq.	1	-	-
Lunell, The Misses.	15	-	-
Martin, Richd. & Co., Messrs.	1	-	-
Martin, T. & C., Messrs.	1	-	-
McBurney & Co., Messrs.	1	-	-
McCullagh, James & Son, Messrs.	1	1	-
Meath, Rt. Hon. Earl of	5	-	-
Millar, A., & Co., Ltd., Messrs.	1	-	-
Mooney, J. G. & Co., Ltd.	1	-	-
Murphy, Michael, Esq.	1	-	-
Murray, Malcolm B., Esq.	1	-	-
Ogilvy, Alex. Esq., J.P.	1	-	-
Ormonde, Dowager Marchioness of.	1	1	-
Palgrave, Murphy, and Co., Messrs.	2	2	-
Pease, Charles, Mrs.	2	-	-
Pembroke and Montgomery, Rt. Hon. Earl of	3	3	-
Pim Bros. and Co. (Limited), Messrs.	3	-	-
Power, John, & Son, Messrs.	2	2	-
Quinan, Mrs.	1	-	-
Reid, Mrs.	1	-	-
Ross and Walpole, Messrs.	1	-	-
Switzer and Co. Ltd., Messrs.	1	-	-
Taylor, Andrew, Esq.	10	-	-
Taylor, Messrs. W. and M.	1	-	-
Tedcastle, R. and Co., Messrs.	1	-	-
Todd, Burns & Co., Ltd., Messrs.	1	1	-
Tuck & Co. Ltd., Messrs.	1	1	-
Watkins & Co., Joseph, Messrs.	2	-	-

	£.	s.	d.
Weir, James and Co., Messrs.	1	-	-
Woods, Webb, & Co., Messrs.	1	-	-
Total	£106	1	-

Donations.

B. & I. S. P. Co.'s (Ltd.) Fleet, Collecting Boxes—			
Lady Martin s.s.	1	16	6
Lady Wolsley s.s.	2	3	6
Lady Olive s.s.	4	10	10
Lady Hudson-Kinahan s.s.	1	3	2
D. & G. S. P. Co.'s Fleet	14	1	-
Darley, Miss M.	10	-	-
Dublin and Mersey s.s. Co.	10	-	-
Clifford's Bequest ..	10	-	-
Figgis, John & Co.	10	-	-
Flavelle, H. E. Esq.	10	-	-
Morgan, M. S. R. C.	5	-	-
Collections—			
Cane, Miss C. F.	2	14	-
Dudgeon, Master George	16	-	-
Hallowes, K. Hamilton, Esq.	2	3	7
Maloney, Master Otho	10	-	-
Morgan, Miss R. C.	12	-	-
Collecting Boxes—			
Carty, W. Esq., X L Cafe	15	10	-
Custom House, Long Room	12	10	-
Edwards, Mrs.	6	-	-
Harrison, Miss	16	3	-
Pillar Boxes—			
D. W. & W. Ry., Bray Station	2	13	5
Kingsbridge Terminus	9	11	-
Sums under 5s.	9	6	-
Total Dons.	35	13	3
Total Subs.	106	1	-
£141	14	3	-

BALBRIGGAN BRANCH.

Local Committee—

EDWARD HAMILTON WOODS, Esq., D.L., Chairman.
 The Very Rev. PATRICK FER. W. WHITE, Esq., J.P.
 W. ST. LEGER WOODS, Esq., J.P.

Honorary Secretaries—
 H. A. HAMILTON, Esq., D.L.
 W. J. CUMISKY, Esq.

Annual Subscriptions.

Cumisky, W. Esq.	1	-	-
Fee, The Very Rev. Patrick	10	-	-
Hamilton, H. A. Esq.	1	-	-
Jameson, R. D. Esq.	1	-	-
Tunstall-Moore, E. Tunstall, Esq., J.P.	1	-	-
Whyte, W. Esq., J.P.	1	-	-
Woods, E. H. Esq., J.P., D.L.	1	-	-
Woods, W. St. L. Esq.	1	-	-
Total	£7	10	-

HOWTH BRANCH.

President—
 Hon. Judge BOYD.

Local Committee—
 S. SMALLBRIDGE, J.P. Chairman.
 RICHARD BARRY, Esq.
 W. HERBERT BOYD, Esq.
 E. COSTELLO, Esq.
 Wm. B. DYER, Esq.
 R. D. GROY, Esq.
 P. J. HUSSEY, Esq.
 R. P. JACOB, Esq.
 R. LEWIS, Esq.
 JAMES MCKENNA, Esq.
 Capt. NEWCOMBE.
 A. W. NEWCOMBE, Esq.
 B. J. NEWCOMBE, Esq.
 T. RAE, Esq.
 R. SMALLEY, Esq.
 Rev. Jas. WILSON.

Hon. Treasurer—
 JOHN STUTTARD, Esq.

Honorary Secretary—
 EDWARD GREER, Esq.

Annual Subscriptions.

	£.	s.	d.
Boyd, Honble. Judge ..	1	-	-
Greer, E. U.	10	-	-
Newcombe, B. J.	5	-	-
Total Subs.	£15	15	-
Donations.			
Contribution Boxes. —	7	9	-
Total	£22	2	9

KINGSTOWN BRANCH.

President—
 The Most Hon. the MARQUIS OF ORMONDE.

Local Committee—
 BRINDLEY HOME, Esq.

Honorary Secretary—
 Capt. the Hon. F. G. CAFFTON, R.N.

Annual Subscriptions.

Alliance Gas Co.	3	3	-
Barton, H. L.	5	-	-
Barton, Miss	3	-	-
Beatty, Maj.-Gen.	10	-	-
Beatty, J. Esq., M.D.	1	1	-
Blythe, Mrs.	1	-	-
Brooke, Mrs. T.	1	-	-
Campbell, Rev. W.	10	-	-
Chatterton, Right Hon. the Vice-Chancellor of Dublin Steam Packet Co.	5	-	-
Close, S. H. Esq.	1	-	-
Coghill, Sir J. J. Bart.	1	-	-
Darwall, Capt., R.N.	1	-	-
Downes, Mr.	5	-	-
Elwood, Miss	1	-	-
Guinness, Howard, Esq.	1	-	-
Heard, R. Lynn, Esq., M.D., and Mrs.	1	-	-
Hogan, J. F. Esq.	10	-	-
Hogan, W. C. Esq.	10	-	-
Hone, Brindley	1	-	-

	£.	s.	d.
Jameson, Andrew, Esq.	2	-	-
Jameson, John, Esq.	5	-	-
Kelly Bros., Messrs.	1	-	-
Magee, Miss	1	-	-
Martin, Sir Richard, Bart.	1	-	-
Moorewood, Miss	1	-	-
O'Hara, Mrs. Hamilton	5	-	-
Ormonde, Marquis of	4	-	-
Reid, J. Hamilton, Esq.	2	-	-
Reid, J. H. Esq.	10	-	-
Royal Alfred Yacht Club	2	2	-
Royal Irish Yacht Club	2	-	-
Royal St. George's Yacht Club	3	-	-
Sinclair, Mrs. J.	5	-	-
Stewart, V. Esq.	5	-	-
Stothard, J. M. Esq., M.D.	5	-	-
Trench, Miss E.	10	-	-
Total	£61	6	-

Donations.

Blow, Mrs.	3	-	-
Ness, Mrs (per Mrs. T. Brooke)	1	-	-
Collecting Boxes—			
Bellahave, Master G.	1	2	-
Corrig School	1	3	-
Dillon, Hon. G.	1	10	-
East Pier, Kingstown	1	6	8
Kingsway Station	6	1	-
Quinn, Master	6	1	-
R.M.S. Connaught	10	-	-
Ireland	1	3	-
Salthill Railway Station	8	5	-
Sums under 5s.	11	11	-
Total Dons.	12	4	5
Total Subs.	61	6	-
	£73	10	5

SKERRIES BRANCH.

Local Committee—			
ALEXANDER BARNETT, C. O.	Coastguard.		
The Right Hon. ION TRANT HAMILTON, J.P., D.L.,	Chairman.		
JOSEPH MAT, Esq.	MATHEW MCGOWAN, Esq.		
Capt. OSBORNE, R.N.	EDWARD H. WOODS, Esq., D.L.		
Honorary Secretaries—			
HENRY A. HAMILTON, Esq., J.P., Balbriggan.	A. MURPHY, Esq., Skerries.		
Annual Subscriptions.			
Cobbe, Mrs.	2	-	-
Hamilton, H.A. Esq.	1	-	-
Hamilton, Rt. Hon.	1	-	-
Ion T.	2	-	-
Hamilton, The Lady Victoria	1	1	-
Palmer, General Sir R. Bart.	2	-	-
Pepper, Chas. Major	1	-	-
Perrin, Mark, Esq.	1	-	-
Scriven, W. B. Esq., M.D.	1	-	-

	£.	s.	d.
Talbot de Malahide, Lord	1	1	-
Taylor, Captain, Esq.	2	-	-
Woods, Edward H. Esq., D.L.	2	-	-
Total	£16	2	-

Donations.

Fowler, Robt. Esq.	10	-	-
Fowler, Capt. R. H.	10	-	-
Total Dons	1	-	-
Total Subs.	16	2	-
	£17	2	-

Co. Fermanagh.

ENNISKILLEN BRANCH.

President—			
The Right Hon. The EARL OF BELMORE.			
Local Committee—			
Rev. Dr. STRELE, Chairman.	Lieut. ARCHDALE, R.N.		
The Right Hon. the Earl of BELMORE.	Lieut.-Colonel The Hon. C. F. CRICHTON.		
J. A. POMEROY, Esq.	Honorary Secretary—		
Mrs. J. POMEROY.	Annual Subscriptions.		
Archdale, Lieut. R.N.	5	-	-
Archdale, Miss	5	-	-
Archdale, Wm. Esq.	10	-	-
Belmore, Earl of	1	-	-
Brooke, Lady	10	6	-
Brooke, Mrs. Butler	1	-	-
Campbell, Mr.	10	-	-
Carson, W. Esq., J.P.	10	-	-
Clogher, the Venerable Archdeacon of	10	-	-
Colley, Miss Pomeroy	10	-	-
Colley, Mrs.	5	-	-
Cooney, Mr.	5	-	-
Crichton, Lt.-Col. the Hon. Charles	1	-	-
Crichton, Col. the Hon. H.	1	-	-
Donnelly, Mr.	7	6	-
Ellis, Mrs.	5	-	-
Erne, Earl of	2	-	-
Fowler, Robt. Esq.	10	-	-
Glen, Mr. Robert	7	-	-
Graham, F. Esq.	1	-	-
Graham, Mrs.	1	-	-
Humfrays, Mrs.	5	-	-
Irvine, Charles, Esq.	1	-	-
King, Sir G. Bart.	5	-	-
Lemon, Mr.	10	-	-
Lunham, J. Esq.	10	-	-
Ormsby, Mrs.	10	-	-
Ovenden, Rev. Canon	10	-	-
Pomeroy, J. A. Esq.	10	-	-
Preston, S. C.	5	-	-
Richardson, Lt.-Col.	1	-	-
Richardson, Mrs.	10	-	-
Sclater, Edward, Esq.	10	-	-
Smyth, E. Esq.	10	-	-
Stirling, Mrs.	10	-	-

	£.	s.	d.
Teel, W. Esq., J.P.	10	-	-
Tippings, Mrs. F. Gartside	2	-	-
Trevar, Surgeon-Major	1	-	-
Vance, J. J. Esq.	5	-	-
Verschoyle, Mrs.	5	-	-
Wigram, Francis, Esq.	1	-	-
Wilson, F. & G.	7	6	-
Woods, Miss	5	-	-
Sums under 5s.	12	6	-
Total Subs.	£27	1	-

Donations.

Collecting Boxes	4	10	-
Total	£27	5	10

Co. Kerry.

FENIT (TRALEE BAY) BRANCH.

President—			
The Hon. Judge NELIGAN.			
Vice-President—			
Lieut.-Col. CROSSIE, D.L.			
Local Committee—			
St. J. H. DONOVAN, J.P.	A. HAMILTON.		
J. J. HARRINGTON.	WM. HILL, J.P.		
J. C. HURLEY, J.P.	R. LATCHFORD, J.P.		
ROBT. MCCARTHY.	W. H. McCOWEN.		
Lt.-Col. NELIGAN, J.P.	Capt. SMITH, R.N.		
Honorary Secretary—			
ROBERT McCOWEN, J.P.			
Lloyd's Agent.			
Annual Subscriptions.			
Donovan, St. John H. Esq., J.P.	1	1	-
Hill, W. Esq., J.P.	1	1	-
McCOWEN, R. Esq., J.P., Hon. Sec.	1	1	-
Total	£3	3	-

Co. Limerick.

LIMERICK BRANCH.

(No Local Committee.)			
Secretary—			
J. S. MORGAN.			
Annual Subscriptions.			
Bannatyne, J. & Sons, Messrs.	1	-	-
Matterson, J. and Sons, Messrs, Ltd.	1	-	-
Murray, Archibald, Esq.	1	-	-
Russell, John Norris, Esq.	1	-	-
Shaw & Sons, Messrs.	2	-	-
J. W.	2	-	-
Total	£6	-	-

Co. Londonderry.

LONDONDERRY AND GREENCASTLE BRANCH.

President—			
H. COOKE, Esq.			
(No Local Committee.)			
Honorary Secretary—			
PIERCE CROSSIE, Esq.			
Annual Subscriptions.			
Cooke, J. & J.	10	-	-
Derry & Raphoe, Lord Bishop of	1	-	-
Hon. Irish Society	5	-	-
Lepper, R. Esq.	5	-	-
Liverpool Steamboat Office	10	-	-
Londonderry Port and Harbour Commissioners	5	-	-
McConnell, J. Esq.	5	-	-
Nolan, Foster, Esq.	5	-	-
Shaftesbury, The Countess of	1	-	-
Stevenson, Col., R.A.	10	-	-
Total	£14	5	-

Cos. Louth and Meath.

GREENORE BRANCH.

Local Committee—			
Mr. T. CHAMBERLAIN.	Dr. F. FINEGAN, J.P.		
Captain GREEN.			
Mr. E. HUMPHREYS.			
Captain T. LIDDICOAT.			
Mr. J. NICHOLSON.			
Mr. J. SOUSTER.			
Mr. R. WOODNEY.			
Honorary Secretary—			
Mr. ROBERT BAKER.			

Donations.

L. & N. W. Ry. Co.	10	10	-
Contribution Boxes	18	2	-
Total	£11	8	2

DROGHEDA BRANCH.

Patron—			
The Most Noble The MARQUIS CONYNGHAM.			
Local Committee—			
B. R. BALFOUR, Esq., D.L.			
MARTIN BUTTERLY, Esq., J.P.			
W. P. CAIRNES, Esq.			
J. CONNOLLY, Esq.			
GEORGE H. DALY, Esq., J.P.			
H. J. DALY, Esq.			
G. GALBRAITH, Esq.			
N. HALLIGAN, Esq.			
The Local Officers of H. M. Coastguard.			

Honorary Secretary at
Baltray—
NICHOLAS HALLIGAN, Esq.

Honorary Secretary for
Mornington—
JOSEPH CONNOLLY, Esq., R.N.

Secretary and Collector—
Mr. E. MCCARTHY.

Annual Subscriptions.

	£.	s.	d.
Balfour, B. T., D.L.	2		
Balfour, Miss	10		
Balfour, Miss Mary	1		
Bank of Ireland	1		
Belfast Banking Co.	1		
Brodigan, Lieut.-Col., 28th Regiment	1		
Butterly, Martin, J.P.	5		
Cairnes Alan	10		
Cairnes, W. P.	1		
Coddington, Colonel, J.P.	1		
Connolly, Joseph	5		
Conyngham, Mar- quis	2	2	
Daly, George H., J.P.	10		
Daly, H. J.	1		
Darnley, Earl of	2		
Davis & Co., Messrs. A.	10		
Galbraith, G., T.C.	5		
Halligan, N.	10		
Hibernian Bank	10		
Hill, R. R., & Sons	5		
Jameson, R. D., J.P.	1		
Kelly, Dr. J. B. J.P.	10		
Lynch, P. (Mayor)	10		
McDonough, Edw.	5		
Mowbray and Stour- ton, Lady	1		
Munster & Leinster Bank	10		
Pepper, Col. Chas.	1		
Pepper, The Misses	1		
Preston Messrs. Brothers	10		
Provincial Bank of Ireland	10		
Saw Mills Company	10		
Smith, R., J.P.	10		
Smyth Family	13		
Smyth, R., J.P.	10		
Steam Packet Co.	5		
Ternan, J. F.	10		
The Harbour Board	5		

Total Subs. £36 15 -

Donations.

Gillespie, Mrs. E.	1		
Boxes	3	2	

Total £37 18 2

**DUNDALK AND
BLACK ROCK
BRANCH.**

Local Committee—
W. J. M. PATTISON, Esq.,
J.P., Chairman.
Rev. — BLUETT.
THOMAS BROWN, Esq.
Rev. Father CLERKE, P.P.
HENRY COOPER, Esq.
JOHN CONNICK, Esq.
J. CUMISKY, Esq.
Rev. — DUKE.
JAMES FERHAN, Esq.
O. J. KELLY, Esq.
Rev. F. KINCH, M.A.
J. H. MCGARDLE.
R. MCCLANAHAN, Esq.
Rev. Father MURPHY, P.P.
Rev. Father O'GORMAN, C.C.

Honorary Secretary—
THOMAS MURPHY, Esq.

Donation.

	£.	s.	d.
Dundalk Harbour Commissioners	15		
Total	15		

**GILES' QUAY
BRANCH.**

Honorary Secretary—
Mr. WILLIAM HAMMETT,
Station Officer H.M. Coast-
guard.

(No List for 1896.)

Co. Waterford.

ARDMORE BRANCH.

Local Committee—
Rev. JOHN WALSH, P.P.,
Chairman.
Capt. DAWSON.

Honorary Secretary—
Mr. HENRY COOPER.

Annual Subscriptions.

	£.	s.	d.
Cooper, Mr. Henry	5		
Dawson, Capt.	5		
Foley, Edmund, Esq.	10		
Foley, Richard, Esq., C.E.	10		
Musgrave, The Misses	1		
Walsh, Rev. John, P.P.	1		
Total	33	10	

**DUNGARVAN
BRANCH.**

Patron—
His Grace the DUKE OF
DEVONSHIRE, K.G.

President—
The Most Noble the MARQUIS
OF WATERFORD.

Local Committee—
J. W. DENROCHE, Chair-
man.
A. CURRAN, Harbour
Master.
R. A. MERRY.
Captain M. MOLONEY.
STEPHEN PILCHER.
THOMAS POWER.
MR. SAMUEL RUDDELL.
Capt. P. SHEEHAN.
Capt. JOHN VEALE.
THOMAS O. B. WILLIAMS.

Honorary Secretary—
FRANCIS CRAIG.

Annual Subscriptions.

	£.	s.	d.
Dee, Mr. Edward	5		
Dungarvan Town Commissioners	2	2	
Lawlor, Mr. William	5		
Merry, Mr. R. A.	1		
Moloney, Capt. M.	10		
Mooney, Mr. John	5		
Power, Mr. Thomas	5		
Ruddell, Mr. Saml.	10		
Sheehan, Capt.	5		
Umble, Charles, Esq.	1		
Veale, Capt. John	5		
Waterford, The Most Noble the Marquis of.	2		
Sums under 5s.	17	6	
Total Subs.	110	9	6

Donations.

Contribution Boxes	5	6	
Total	110	15	

**DUNMORE EAST
BRANCH.**

President—
Sir R. J. PAUL, Bart.

Local Committee—
J. ALLINGHAM, Jun.
Rev. M. FLYNN, P.P.
Hon. D. F. FORTESCUE.
Rev. W. G. GILMOR.
Dr. JACKMAN.
Rev. J. LENNEN, C.C.
F. G. KENT.
ARTHUR N. O'NEIL, Esq.
E. STEPHENSON, Esq., M.D.
Mr. THOMAS SUTCLIFFE,
Harbour Master.

Honorary Secretary—
Mr. P. HARNET.

Annual Subscriptions.

	£.	s.	d.
Fortescue, Hon. D. F., D.L.	1		
Kent, F. G.	10		
Malcomson, Mrs.	4		
Thompson, Rev. R.	10		
Waterford Harbour Commissioners	10		
Total	16		

TRAMORE BRANCH

President—
The Right Hon. Lord
CASTLETOWN.

Vice-Presidents—
Rev. Canon TOPPIN.
Rev. — COFFEY, P.P.

Local Committee—
E. N. POWER, Esq., Chair-
man.
J. ALLINGHAM, Jun., Esq.
H. E. BENNER, Esq.
JAMES BUDD, Esq.
E. CLAMPETT, Esq.
H. J. FORDE, Esq.
H. J. GALLWEY, Esq.
J. P. HANRAHAN, Esq.

ARTHUR KELLY, Esq.
G. W. MORRIS, Esq.
M. J. MURPHY, J.P.
Capt. N. PARLE.
JAMES POWER, Esq.
L. STRANGE, Esq.

Honorary Secretary—
E. O'S. WARDELL.

Annual Subscriptions.

	£.	s.	d.
Allingham, J., Jun.	5		
Ambrose, C., LL.D.	10		
Anderson, T.W., J.P.	1		
Beale, J. H.	5		
Beale, W. E.	10		
Benner, H.	5		
Bennett, B.	5		
Brown, Capt., R.N.	10		
Budd, F. W.	5		
Budd, James (the late)	5		
Carden, Dr.	5		
Christie-Miller, W., J.P.	1		
Clampett, E.	5		
Cox, J.	5		
Denny & Sons, Ltd., Messrs. Henry	2		
Denny, Charles	10		
Doneraile, Viscountess	3		
Dorner, Thomas, (the late), per Commissioners of Charities, Dona- tions and Bequests	10	8	
Dunannon, Lord	1		
Ebrington, Lord	1		
Feeley, J. J.	5		
Fennessy, Thomas	10		
Forde, H. J.	5		
Fortescue, Hon. D.	1		
Gallwey, H.	5		
Goff, W. G. D., J.P.	1		
Grubb, Miss S.	5		
Hall, R. & H., Ltd.	2		
Hanrahan, J. P.	5		
Harbour Commis- sioners	10		
Hayden, R.	5		
Higgins, J. G.	5		
Jacob, Edward	10		
Jacob, W. E.	5		
Kelly, A.	5		
Kenny, P.	5		
Matterson, Messrs.	10		
McGrath, J. H.	5		
Mcyeers, Edward	5		
Morris, R. W.	5		
Murphy, M. J., J.P.	5		
Nelson, Alexander, D.L.	5		
Pearn, Capt. W.	5		
Pearn, Capt. Thomas	5		
Peet, Edward G.	5		
Power, James	5		
Pope, William	10		
Power, E. H.	5		
Power, E. N. (Coroner)	1		
Reddy, P. P.	5		
Redmond, C. P.	5		
Spinks, Charles	5		
Strange, L.	5		
Strange, L. C., Solici- tor	5		
Strangman, John	1		
Strangman, Samuel	1		
Tobin, J. R.	5		
Toppin, Rev. Canon	10		
Walsh, E. A.	5		
Walsh, Rev. Father	5		
Ward, H. (Water- ford Mirror)	10		
Wardell, E. O'S.	6		
Waterford Corpora- tion	3		
Waterford Steam Ship Co.	5		
Waygood, Edward	5		
Whalley, R. (Water- ford Standard)	10		

£.	s.	d.
White, George E.	10	-
White, J. N., J.P.	1	-
White, John N., J.P.	1	-
White, Thomas R.	2	-
White, William	10	-
Wright, J. L.	5	-
Sums under 5s.	4	4
Total Subs.	£60	5 8
Donations.		
Contribution Boxes.	5	4
Total	£60	11 -

Co. Wexford.

CAHORE BRANCH.

President—
Rev. J. W. CHAMBERS, LL.D.

Chairman—
Rev. JOHN FURLONG, P.P.

Committee—
Rev. JOHN MAHER.
Mr. MICHAEL MURPHY.
Mr. ALFRED POPE.
P. C. POUNDEN, Esq., M.B.
Mr. PETER SINNOTT.

Hon. Secretary—
WM. ASTLE RYAN, Esq.

Annual Subscriptions.

£.	s.	d.
Bryan, L. A. Esq.	1	-
Chambers, Rev. J.W., LL.D.	5	-
City of Dublin Steam-packet Company.	1	1
Corcoran, John, Esq.	10	-
Courtown, Earl of.	1	-
Furlong, Rev. J.P.P.	10	-
George, Mrs. R. D. (1895-96)	2	2
Maher, Rev. John C.C.	5	-
Murphy, Michael, Mr.	10	-
Pope, Mr. A.	5	-
Ryan, W. A. Esq.	10	-
Sinnot, Mr. Peter	5	-
Total	£8	13 -

CARNSORE BRANCH.

Local Committee—
Mr. B. FURLONG.
Mr. J. WALL.

Honorary Secretary—
E. A. GIBBON, Esq.

Annual Subscriptions.

Alexander, A.C. (Col R.E.)	10	6
Alexander, Major G.	10	0
Alexander, Rev. J.	5	-
Blacker, Mrs. John R.	1	-

£.	s.	d.
Burne-Thoms, Mrs.	10	-
Edge, Mrs.	10	-
Fitzgerald, Lord	1	-
Maurice	1	-
Furlong, Mr. B.	10	-
Gibbon, E. Acton, Esq.	2	-
Lett, Mrs.	10	-
Lett, William	10	-
Meadows, Henry Esq.	1	-
Morgan-Deane, Hon. Mrs.	1	-
Wall, J.	5	-
Total Subs.	£10	6 -

Donations.

Church and Chapel Collections	3	10
Guilbuc, Francis, J.P.	10	-
Collection Boxes	6	8
Total	£13	18 -

COURTOWN BRANCH.

Patron—
Rt. Hon. Earl of COURTOWN.

Local Committee—
Rev. M. FANNING.
J. H. FINNIMORE, Esq.
J. G. GIBBON, Esq.
Rev. J. W. KENNEDY.
Rev. H. RENNISON.
Rev. THOS. SKIPTON.
VICOUNT STOPFORD.
F. A. B. TURNER, Esq.
Mr. MELLIFONT (Chief boatman H.M. Coastguard).

Treasurer and Hon. Sec.—
HON. GEORGE STOPFORD.

Annual Subscriptions.

Adair, Miss	5	-
Adair, Mr. and Mrs. J. O.	10	-
Bagenal, B., Esq.	1	-
Blacker, E. C., Esq.	10	-
Brews, Rev. W.	5	-
Canfield, Colonel	1	-
Cloze, H. S. Esq.	10	-
Comerford, Mr. & Mrs. Jas.	10	-
Courtown, Earl of	2	-
Dashwood, Mrs.	10	-
Davis, Messrs. S. & A. G.	10	-
Devereux, J. Daly, Esq.	1	-
Doyle, C. M. Esq.	1	-
Doyle, J. W. C. Esq.	1	-
Ellis, E. F. L. Esq.	10	-
Ellis, Mrs.	1	-
Ellis, A. C. L. Esq.	10	-
Fanning, Rev. M., C.C.	10	-
Finnimore, J.H. Esq.	1	-
Fitzmaurice, W., Esq.	5	-
Foster, W. O. Esq.	1	-
Furlong, Very Rev. Canon, P.P.	10	-
Gibbon, J. G. Esq., LL.D.	1	-
Greene, Conyngnam, Esq.	10	-
Greene, Lady Lily	5	-
Guinness, R. D., Esq.	10	-
Guise, Mrs.	1	-
Hamilton, Jas. Esq.	1	-
Hatton, Colonel, the late	1	-
Huggard, M. Esq.	10	-
Jermyn, C. T. Esq., the late	5	-

£.	s.	d.
Kingsley, Rev. Charles	10	-
McCormick, E. H., Esq.	10	-
Milles, Hon. Mar-quieta, the late	1	1
Milles, Hon. Miss	1	1
Mulhall, C. Esq.	5	-
Reynolds, Thos. Esq.	1	-
Nuon, W. B., Esq.	1	-
O'Connor, J. Esq.	10	-
Owen, Cliffe, Esq.	5	-
Palmer, Rev. H. G.	5	-
Power, Sir John	1	-
Talbot, Bart.	1	-
Ram, A. J., Esq.	1	-
Rennison, Rev. H.	5	-
Richards, Captain Arthur W.	1	-
Richards, Mrs. M. and Mrs. Dove	2	-
Ringwood, H. Esq.	5	-
Scott, J. W. Esq.	5	-
Segrave, Mr. and Mrs. C.	1	-
Segrave, Mrs.	10	-
Skipton, Rev. Thos.	10	-
Stopford, Capt. Hon. E. B.	10	-
Stopford, Capt. W.	5	-
Stopford, Commander Hon. Walter	10	-
Stopford, Hon. Mrs. Edward	10	-
Stopford, Hon. Geo.	10	-
Stopford, Hon. Mrs. Geo.	10	-
Stopford, Lady C.	10	-
Stopford, Miss Horatia	5	-
Stopford, Mrs. Robt.	5	-
Stopford, Viscount	10	-
Stopford, Viscountess	10	-
Turnly, F., Esq.	5	-
Turner, F. A. B. Esq.	10	-
Turner, Mrs. F.	5	-
Wordsworth, R. G. Esq.	10	-
Total	£42	2 -

Donations.

Haviland, Miss	1	-
Stopford, Lady Eleanor	2	8 9
Contribution Boxes	18	10
Sums under 5s.	6	7 9
Total Dons.	10	15 4
Total Subs.	42	2 -
Total	£52	17 4

FETHARD BRANCH.

President—
The Most Noble
The MARQUIS OF ELY.

Local Committee—
GODFREY L. TAYLOR, Esq., Chairman.
Rev. J. ASHTON.
Wm. DRACON.
PETER FOLLY.
Wm. HORNICK.
Rev. MICHAEL KINSELLA, C.C.
Wm. ROBINSON.
Dr. W. J. SHER.
THOMAS SMAILCOMBE, Chief Officer Coastguard.

Hon. Secretary—
ALLAN LEIGH, Esq.

Donations.

Contribution Box	2	-
------------------	---	---

KILMORE BRANCH.

Local Committee—
Wm. BOXWELL, Esq., Chairman.
Rev. H. ROWE, Vice-Chairman.
NICHOLAS WHITE, Esq.
Mr. W. J. WARREN, Chief Officer H.M. Coastguard.

Hon. Secretary—
C. F. WALKER, Esq., J.P.

Annual Subscriptions.

£.	s.	d.
Bruen, Right Hon. H.	1	-
Fitzgerald, Lord M.	1	-
Lett, W. H. Esq.	10	-
Morgan, Hon. Mrs. Dean	1	-
Total Subs.	£13	10 -

Donations.

Contribution Boxes	8	6
Total	£13	18 6

WEXFORD AND ROSSLARE BRANCH.

President—
The Rt. Hon. Lord M. FITZGERALD, H.M.L.

Local Committee—
Wm. ARMSTRONG, Chairman.
J. E. BARRY, J.P.
Commander DANIELS, R.N.
General Sir JOHN DORAN.
M. A. ENNIS, J.P.
C. HUGHES, H.M.C.
Captain HUTCHINSON.
B. KEER.
Wm. MURPHY.
Sir JOHN POWER, Bart., D.L.
R. D. WALKER.
F. J. WALSH.

Honorary Secretary—
JOHN F. WALSH, Esq.

Annual Subscriptions.

Armstrong, William	5	-
Armstrong, Mrs.	5	-
Allen, Messrs. R. & R.	10	-
Bacon, John, Limited, Liverpool	1	-
Barry, J. E., Esq., J.P.	1	-
Brown, Wm. & Son	5	-
Davis Bros. Messrs.	1	-
Davis, Messrs. S. & A. G.	10	-
Devereux, Mrs. John Thos.	1	-
Dockyard Company	1	-
Doran, General, Sir John, C.B.	1	-
Ennis, M. A. Esq. J.P.	6	-
Fitzgerald, Lord Maurice L. L.	1	-
Hatton, Colonel, D.L.	1	-
Harman, Mrs and Miss Brown-Clayton	10	10
Hughes, Lady	1	-
Hutchinson, Captain Thos., manager for Sealflower, &c.	10	-
Jeffries, Thos., J.P.	1	-
Leigh, F. A. Esq. J.P.	1	-
Maher, M. A. Esq. J.P.	2	-
McLaren Smith, Mrs.	3	-
Magrath, Mrs.	1	-

	£.	s.	d.
Morgan, Hon. Mrs. D.	1	-	-
Power, Sir John T.	-	-	-
Bart., D.L.	1	-	-
Templemore, Lord	-	-	-
The Right Hon.	3	-	-
Walker, Capt., D.L.	1	-	-
Walker, Colonel	1	-	-
Walker, Miss	1	-	-
Walker, Mrs.	1	-	-
Walker, Robt. D. Esq.	10	-	-
Walsh, J. F. Esq.	1	-	-
Wexford Harbour Commissioners	5	-	-
Total	£36	10	-

Co. Wicklow.

ARKLOW BRANCH.

Local Committee—
The Right Hon. The EARL OF CARYSFORT, Chairman.
Mr. HUGH BYRNE,
T. G. BARLOW, Esq.
Mr. JAMES DOYLE.
Mr. JOB HALL.
Mr. E. KEARON.
Mr. R. KEARON.
R. PHILPOT, Esq.
Mr. JOHN REYNOLDS.
Mr. JOHN STOREY.
ALEXANDER TAILTOUR, Esq.
THOMAS J. TROY.
Mr. FRANK TYRELL.
Mr. JOHN TYRELL.

Honorary Treasurer.
T. G. BARLOW, Esq.
Honorary Secretary—
MR. JAMES TYRELL.

Annual Subscriptions.

	£.	s.	d.
Arklow Clothing Co.	-	5	-
Barlow, T. G. Esq.	10	-	-
Beauman, The Misses	1	-	-
Carysfort, The Right Hon. the Earl of	10	-	-
Hall, Mr. Job	5	-	-
Kearon, Mr. E.	5	-	-
Kearon, Mr. George	5	-	-
Kearon, Mr. Richard	5	-	-
Kynoch & Co., Messrs.	2	2	-
O'Grady, Hon. Mrs.	10	-	-
Philpot, Robt. Esq.	5	-	-
Tyack, E. P., D.I.R.I. Co.	1	1	-
Sums under 5s.	6	1	-
Total Subs.	£22	14	-

Donations.

Contribution Boxes	-	2	4
Total	£22	16	4

WICKLOW BRANCH.

Patron—
The Right Hon. the EARL FITZ WILLIAM, K.G.

Local Committee—
Capt. H. SEGRAVE, J.P., Chairman.
Col. C. G. TOTTENHAM, D.L.
Dr. H. P. TREVELL, D.L.
JULIUS CARMENT, Esq., J.P.
Rev. Canon ROOKE, M.A.
Rev. MICHAEL O'HEA, P.P.

Capt. THOMAS F. THOMAS, R.N.
DR. JAMES H. HALPIN.
T. A. TOMBE, Esq.
C. W. RICHARDS, Esq.
MR. THOMAS DARCY.
MR. JOHN PASSANT.
MR. JOHN NELL.
MR. S. M. KENT.
MR. FRANCIS MCPHAIL.
MR. PETER DOOLITTLE.
MR. CHARLES MCCULLEN, R.N.

Honorary Secretary—
MR. W. H. H. KENNEDY.

Annual Subscriptions.

	£.	s.	d.
Atkinson, Col. E. D.	1	-	-
Byrne, I. J. Esq.	5	-	-
Carroll, Rev. Fredk.	1	1	-
Collins, Mrs. Maria T.	5	-	-
Darcy, Mr. Thomas	10	-	-
Darragh, Mr. Wm.	10	-	-
De Robeck, Colonel, and Officers, Wicklow Militia	2	-	-
Dennis, Capt. M. I. C. R.A.	1	-	-
Desaix, Mr. Wm.	5	-	-
Dobbs, R. C. Esq., J.P.	10	-	-
Drought, R. E. Esq., J.P.	1	-	-
Ellis, R. F. Esq., J.P.	1	-	-
Fitzgerald, Gerald F. Esq.	5	-	-
Fitzwilliam, The Rt. Hon Earl.	2	-	-
Gregg, Mr. F. B.	5	-	-
Halpin, Dr. J. H.	5	-	-
Halpin, Mrs. R. C.	1	1	-
Harding, E. M. Esq.	5	-	-
Haskins, Mr. N.	5	-	-
Herbert, Col. W. H., J.P.	10	6	-
Honner, Major W.J., R.A.	10	-	-
Huband, Rev. H. R. Keene, Alexander, Esq.	10	-	-
Kennedy, Robert C. H. Esq.	5	-	-
Kennedy, Wm. H. H. Kent, Samuel M. Esq.	5	-	-
Lees, Robert, Esq.	5	-	-
Lynard, Dr. Thos. Magill, Col. Napier, and Officers, City of Dublin Artillery	1	-	-
McCarroll, J. H. Esq.	5	-	-
McCullen, Mr. Charles, R.N.	5	-	-
McPhail, Francis	5	-	-
Nolan, The Misses M. & E.	10	-	-
Nolan, The Misses O'Brien, Mr. Peter O'Hea, Rev. Michael, P.P.	5	-	-
Passant, Mr. John	5	-	-
Patterson, B. T. Esq.	10	-	-
Richards, C. W. Esq.	1	1	-
Rooke, The Rev. Canon	5	-	-
Segrave, Capt. Henry, J.P.	1	1	-
Shaw, Mr. John	5	-	-
Smyth, Mr. Joseph	5	-	-
Thomas, Captain Thomas F., R.N.	1	-	-
Tombe, T. A. Esq.	1	-	-
Tottenham, Col. C.G., D.L.	1	1	-
Tottenham, Major C. R. W., J.P.	1	-	-
Truett, Dr. H. P., D.L.	1	1	-
Wellesley, E. H. C., J.P.	10	-	-

	£.	s.	d.
Williamson, W. G., C.I.R.I.C.	5	-	-
Wynne, Edward N., J.P.	10	6	-
Sums under 5s.	13	-	-
Total Subs.	£30	10	-

Donations.

Wicklow Regatta Committee	4	-	-
"Collecting Boats"	15	7	-
Total	£35	5	7

Isle of Man.

CASTLETOWN BRANCH.

President—
SIR JAMES GELL,
Attorney General.

Local Committee—
W. H. CUDD, Esq., Chairman.
R. C. CRETNEY, Esq.
TOM M. DODD.
HUGH S. GELL.
Major MOORE.
JAMES TAGGART.

Honorary Secretary—
G. HARRINGTON QUAYLE, Esq.

Annual Subscriptions.

	£.	s.	d.
The Lieut.-Governor	1	1	-
Caparu, E.	5	-	-
Cary, G. D. L. Esq.	6	-	-
Cary, Lieut.-Colonel.	10	-	-
Clagney, Dr.	5	-	-
Corbyn, Mrs.	5	-	-
Corrin, Tom	5	-	-
Cretney, R. C. Esq.	5	-	-
Cudd, W. H. Esq.	10	-	-
Darkin, G. E.	5	-	-
Dodd, Tom M.	5	-	-
Drinkwater, Sir W. L. Deemster	1	-	-
Ferrier, Rev. E.	5	-	-
Gell, Sir James	10	-	-
Gell, Hugh S.	5	-	-
Hannay, Dr.	5	-	-
Isle of Man Steam- packet Company	2	2	-
Moore, Major	10	-	-
Pleignier, V. Esq.	5	-	-
Quayle, Miss	7	6	-
Stevenson, W. B.	10	-	-
Taggart, Mrs.	10	-	-
Taggart, James	5	-	-
Walters, Rev. F. B.	5	-	-
Sums under 5s.	5	12	6
Total Subs.	£16	14	0

Donations.

Anderton, Mr.	5	0	-
Collecting Boxes	6	1	1
Total	£23	-	1

DOUGLAS BRANCH

Patron—
His Excellency the Lieut.-GOVERNOR.

President—
P. KILLET, Esq., C.P.

Local Committee—
R. ARCHER.
J. BOYDE.
J. A. BROWN.
W. J. BROWN.
F. BROWNE.
C. T. CHESLYN CALLOW.
J. T. CROFTS.
J. S. EVARARD.
M. P. EVARARD.
C. FOX.
Capt. P. GELL.
F. GREENHILL.
A. HEMMING.
H. J. HINDLEY.
A. EARL HUNT.
F. W. JOHNSON.
W. KELLY.
A. H. MARSDEN.
H. P. STEVENSON.
T. WESTON.

Hon. Sec. and Treasurer—
THOMAS BAUDREN.

Annual Subscriptions.

	£.	s.	d.
Lieut.-Governor	2	2	-
His Worship the Mayor	1	1	-
S. Harris, Esq., V.G.	1	-	-
Anderson, Col.	1	-	-
Anderton, Mrs.	1	-	-
Archer, R.	5	-	-
Bawden, Thos.	5	-	-
Bridge, W.	1	-	-
Brown, J. A.	5	-	-
Browne, F.	5	-	-
Cadman, Mrs., senr.	5	-	-
Cannell, Miss	5	-	-
Callow, C. T. C.	5	-	-
Clinch, J. W.	5	-	-
Cookson, G. H.	5	-	-
Cooke, C. W.	5	-	-
Cowin, W. D.	5	-	-
Cubbin, T. & Sons	5	-	-
Cubbin, J. & Son	5	-	-
Dursley, L.	5	-	-
Elliott, J. G.	10	-	-
Evarard, J. S.	5	-	-
Evarard, M. P.	5	-	-
Farrant, R.	10	-	-
Gell, Capt. P.	5	-	-
Gell, Miss	5	-	-
Gelling, R.	10	-	-
Gelling, Mrs.	10	-	-
Greenhill, F.	10	-	-
Hannay, L. G.	1	-	-
Heron, G. C.	5	-	-
Hogg, Mrs.	5	-	-
Jefferson, Mrs.	5	-	-
Kelly, R.	5	-	-
Kermode, W. J.	5	-	-
Kewley, S. and J.	5	-	-
Killey, P.	10	-	-
Lomas, Mrs. S.	10	-	-
Moffatt, Miss	10	-	-
Moffatt, Miss E.	10	-	-
Moore, A. W.	10	-	-
Okell, W. & Son	10	6	-
Quiggin, E. T.	10	6	-
Sherwood and Co.	5	-	-
Steam Packet Co. (I. O. M.)	5	-	-
Talbot, Rev. T.	1	-	-
Torrance and Co.	5	-	-
Torrance, G.	10	-	-
Walsh, Rev. E.	1	1	-
Weir, Mrs.	5	-	-
Weston, T.	5	-	-
Whiteide, R.	5	-	-
Sums under 5s.	3	1	-
Total	£32	1	-

<i>Legacy.</i>	
<i>£. s. d.</i>	
Mrs. A. N. Monk,	
per High Bailiff ..	10 - -
 <i>Donations.</i>	
Collections:—	
After-Dinner Col-	
lections, Sunday,	
August, 1896 ..	121 15 8
Collection after	
Service on	
Douglas Head by	
Lord Bishop ..	20 1 3
Collection Boxes	
at Hotels and	
Boarding Houses	22 7 8
Collection Boxes at	
Life-boat House,	
and Pillar Boxes	28 8 6
Collection Boxes on	
I.O.M. Steamers	37 13 8
Friendly Societies	
Demonstration,	
per Mr. J. Kelly	2 8 9
Proceeds Concert on	
Head, per Mr.	
George Eytton and	
friends	11 6 -
Proceeds Concert on	
Head, per Mr.	
Hughes and friends	7 2 -
Proceeds Pantomime	
Sports, per Mr. A.	
Hemming	17 10 7
Rents	20 - -
Royalty on Life-boat	
Song	1 7 8
Collected at Demon-	
stration, Launch of	
New Life-boat ..	8 12 10
Bank Interest	3 18 2
Total Dons.	302 12 9
Legacy	10 - -
Total Subs.	32 1 -
	<u>£34 13 9</u>

PEEL BRANCH.

President—
His Excellency The
LIEUTENANT-GOVERNOR.

Vice-President—
E. T. CHRISTIAN, Esq.

Local Committee—
E. T. CHRISTIAN, Esq.,
Chairman.

W. J. CANNELL.
W. CASHEN.
ROBERT CORRIN, J.P.
T. C. CORRIN.
DR. FARAKER.
T. J. GRAVES.
J. HODGSON.
J. JOUGHIN, H.K.
W. KERMODE.
A. E. LAMOTH.
A. N. LAUGHTON, H.B.
T. C. S. MOORE, C.P.
J. MURPHY, Collector of
Customs.
W. NEWNHAM, R.N.R.

Hon. Secretary—
JOHN CORRIE, Esq.

Annual Subscriptions.

His Excellency, The
Lieut.-Governor.. 1 1 -
Christian, E. T. - 10 6

Cannell, W. J.	5 - -
Corrin, Robert	1 - -
Davey, W. T.	5 - -
Ensor, Rev. G.	5 - -
Hodgson, J.	5 - -
Joughin, John	5 - -
Moore, T. C.	5 - -
Sums under 5s.	1 3 6
Total	£5 5 -

Donations.

Caine, Mrs. Hall ..	5 - -
Contribution Boxes	5 8 5
Per W. Murphy, Esq.	- 2 6
Total Dons.	5 15 11
Total Subs.	5 5 -
	<u>£11 - 11</u>

PORT ERIN BRANCH.

Local Committee—

THOS. CLAGUE.
THOS. CLAGUE.
JOHN CLAGUE.
THOMAS GALE.
JAMES MYHEA.

Honorary Secretary—
MR. GEORGE L. TRAUTRUM.

(No List for 1896.)

PORT ST. MARY BRANCH.

Local Committee—

Rev. T. KNEALE, President.
T. QUALTROUGH, Chairman

J. WATTERSON.
T. A. MILLER.
E. QUALTROUGH.
D. LACE.

SAM. WATTERSON.
G. R. CRELLIN.
J. MOORE, JUN.
A. GAWNE.
J. FALLOWS.
T. CLAGUE.
J. J. SANSBURY.
T. WATTERSON.
H. J. QUALTROUGH.
T. LACE.
J. QUALTROUGH.
F. STRICKLAND.
J. THIMMIN.
M. GAWNE.
W. LACE
J. J. QUALTROUGH.

Hon. Secretary—
Capt. J. A. KISSACK.

Annual Subscriptions.

Fallows, J.	5 - -
Kissack, J. A.	5 - -
Lace, D.	5 - -
Moore, J. Jun.	5 - -
Qualtrough, E.	1 - -
Qualtrough, M. E. .	5 - -
Thimmin, R. C.	5 - -
Strickland, F.	5 - -
Waterson, S.	5 - -
Total Subs.	3 - -

Donations.

Hall, Mrs. Basil, sen.	- 5 -
Maux Steam Trading	
Co	- 10 -
Qualtrough, T.	- 5 -
Sums under 5s.	- 5 -
Total	£4 5 -

RAMSEY BRANCH.

Local Committee—

Rev. G. PATON, Chairman.
Capt. ROBT. BROWN.
J. B. COWELL, J.P., H.K.
J. M. CRUICKSHANK.
Divisional Officer H.M. C^t
G^d. Peel.

J. R. FERGUSSON.
Capt. HARDIE, J.P.
H.M. Collector of Customs.
J. NORBURY.
WALTER PRIESTLAND.
W. D. ROOSE.
W. H. TAUBMAN.
Colonel THELLUSSON, J.P.
CHARLES WATTLEWORTH.

Honorary Secretary—
E. C. KERR.

Annual Subscriptions.

Allen & Taubman ..	5 - -
Brew, J. & W.	5 - -
Brew, Miss E. A.	5 - -
Brown, Capt. R.	5 - -
Callow, T. "Eclipse" ..	5 - -
Corkill, Thos.	5 - -
Corlett, J. J.	5 - -
Cowell, J. R., J.P.	10 - -
Cowley, R., J.P.	5 - -
Cruickshank, J. M. .	10 - -
Fletcher, Mrs.	5 - -
Forresters, Ramsey. .	1 1 -
Gibb, Mrs.	1 - -
Goold, J. Stuart.	1 - -
Goulden, Misses.	1 - -
Gray, Miss	10 - -
Greaves, Thomas, Seaforth.	10 6 -
Hardie, Capt. J., J.P. .	1 - -
Harrison, Miss Mona .	10 - -
Isle of Man Steam Packet Company. .	2 2 -
Kermode, John.	5 - -
Kermode, Mrs. Hill- side	10 - -
Kerr, E. O.	10 - -
Kerrulah, Mrs. "Clif- ton"	10 - -
Looney, J. C.	10 - -
Nelson, C. B.	5 - -
Newton, Rev. A. S. .	5 - -
Norbury, J.	1 - -
Paton, Rev. G.	1 - -
Purdon, Capt. R.	10 - -
Rimmer, Misses .	5 - -
Warrington	5 - -
Roose, W. D.	10 - -
Scott, Robt.	2 - -
Skillicorn, Wm.	5 - -
Stowell & Kelly	5 - -
Taubman, W. H.	5 - -
Thellussion, Col., J.P.	1 - -
Wilson, Stanley	10 - -
Sums under 5s.	12 - -
Total	£22 16 6

Donations.

"Life-boat Sunday"	
Collections	89 3 4
Contribution Boxes—	
Arkle, John	12 6 -
Christian, Miss, Albert House. .	12 - -
Clarke, Mrs., Mitre Hotel.	1 7 5
Harbour	1 1 -
Life-boat House. .	15 17 1
Life-boat Collected during two prac- tices	5 15 -
Paton, Mrs. G. C. .	12 7 -
Sums under 5s.	10 5 -
Total Dons.	115 11 4
Total Subs.	22 16 6

£138 7 10

CHANNEL ISLANDS.

GUERNSEY BRANCH.

Local Committee—

MR. JOHN HAMLEY.
Capt. JONES.
MR. EDMUND LE CONTEUR.
Capt. MARY.

Honorary Treasurer—
PETER F. CAREY, Esq.

Honorary Secretary—
Capt. CAREY, R.N.

Annual Subscriptions.

States of Guernsey .	30 - -
----------------------	--------

Donations.

Contribution Boxes .	2 - 4
Total	£32 - 4

JERSEY BRANCH.

President—

Major-General E. HOPTON,
C.B.

Local Committee—

Capt. BLAMPED.
Capt. C. DE GRUGHY.
DR. H. LE CRONIER.
General PIPON.

Hon. Secretary—
PHILIP BAUDAINS, Esq.

Annual Subscriptions.

Baudains, Ph.	10 6 -
Hopton, Maj.-Gen. .	10 - -
Le Cronier, Dr. H. .	5 - -
Pipon, General	10 - -
Total	£1 15 6

Donations.

The States of Jersey	30 - -
Ditto	25 - -
Alavoine, Maurice,	
Esq.	10 - -

Total Dons. 55 10 -
Total Subs. 1 15 6

£57 5 6

ROYAL NATIONAL LIFE-BOAT INSTITUTION.

The Right Hon. C. T. Ritchie, M.P., President of the Board of Trade, said in the House of Commons on the 14th February, 1896 :—

“It is not the intention of the Board of Trade to interfere with the excellent work of the Royal National Life-Boat Institution.”

The Right Hon. J. Bryce, M.P., when President of the Board of Trade, said in the House of Commons on the 18th August, 1894 :—

“The National Life-Boat Institution deserves the confidence of the people.”

The Right Hon. the Lord Mayor of London, when presiding at a meeting at the Mansion House on the 13th June, 1894, said :—

“The Royal National Life-Boat Institution is one of the most meritorious and useful voluntary institutions in this the greatest maritime country of the world. Indeed, there is perhaps no society which better deserves the financial support of the citizens of London.”

The Right Hon. the Earl Spencer, K.G., when First Lord of the Admiralty, stated at the Annual Meeting of the Life-Boat Institution on the 21st April, 1894 :—

“A work like this is done entirely voluntarily without assistance from the State, and in this country I think we take a great pride in this. The Institution has a great claim on the country. . . . It does a great and a national work. On this account it has a claim on the generosity and liberality of the people.”

The Right Hon. A. J. Mundella, M.P., when President of the Board of Trade, said at the Annual Meeting on the 18th March, 1893 :—

“No Government department could ever do the work as well as the National Life-Boat Institution. No Government department would ever maintain that alertness and alacrity which the Governors of that Institution always exhibited; and no Government department could ever evoke that generous sympathy with heroism which has characterised the work of the Institution. I trust the time will never come when the English public will abdicate their duty and their highest privilege of supporting such a noble Institution.”

The Right Hon. Sir Michael Hicks-Beach, Bart., M.P., when President of the Board of Trade, stated at the Annual Meeting of the Life-Boat Institution on the 30th April, 1892 :—

“In the work of saving life at sea the Life-Boat Institution takes the larger part, not only as regards the number of lives saved and money spent, but also as regards the efficiency of the work done. I have never had brought before my notice one single case in which the crews of the Life-Boats have failed to do their duty.”

The Right Hon. Sir A. B. Forwood, Bart., M.P., when Secretary to the Admiralty, stated in public at Liverpool :—

“The Admiralty have no machinery whatever for working the Life-Boat Service, and I am decidedly of opinion that the best, and indeed the only way that this work can be carried on is by the existing organisation.”