

THE LIFE-BOAT,

OR

JOURNAL OF THE NATIONAL LIFE-BOAT INSTITUTION.

(ISSUED QUARTERLY.)

VOL. XII.—No. 128.]

MAY 1, 1883.

[PRICE 1s.

At the ANNUAL GENERAL MEETING of the ROYAL NATIONAL LIFE-BOAT INSTITUTION, held at Willis's Rooms, King Street, St. James's Square, on Tuesday, 13th day of March, 1883, His Grace THE DUKE OF NORTHUMBERLAND, P.C., D.C.L., *President of the Institution*, in the Chair, the following Report of the Committee was read by the Chief Inspector of Life-boats, in the absence of the Secretary:—

ANNUAL REPORT.

IN rendering their Annual Account to their supporters and the British Public, the Committee have once more to express their grateful thanks for that continued generous pecuniary aid which has enabled them to prosecute successfully the great national work they have undertaken—a work that will ever be needed, so long as British trade and commerce endure.

It might have been hoped that increased skill in navigation, the substitution of steam-colliers for the sailing craft of former years, and increased sobriety among our merchant seamen, would have greatly diminished the number of wrecks and of lives lost, at least on our own coasts. But, whilst those changes may have occasioned some diminution, the increase of collisions on our crowded sea-thoroughfares, and other causes, have made up the average amount, and the courage and capacity of our Life-boat men have been called into requisition as often, if not more frequently, than in previous years.

The transactions of the year will be found summarised under the usual heads. A speciality of the year has, however, been that, at the suggestion of the Chair-

man—EDWARD BIRKBECK, Esq., M.P.—the Committee have once more made an exception to their general rule to confine their attention exclusively to the work of the Institution, and have made another effort to diminish the loss of life amongst that industrious and invaluable class of the population, our coast fishermen, on whom the Institution is often dependent to man its Life-boats.

Some twelve years ago, the Institution was mainly instrumental in the introduction of decked fishing-boats on the East coast of Scotland, which improvement has undoubtedly been the means of saving many lives. And now again the Committee hope to be indirectly the means of saving many more, by inducing all fishermen whose vocation is prosecuted at long distances from the land, to provide themselves with reliable Aneroid Barometers, which, when far at sea, beyond sight of land, shall forewarn them of the approaching storm, and enable them to run for shelter ere overtaken by it.

Through the liberality of the manufacturers of these valuable instruments, who have undertaken to provide them for this special object at a greatly reduced price, the Institution, by offering them to owners

or masters of fishing vessels at only half that amount, has already—through the kind exertions of its Honorary Secretaries—induced the large number of 1050 to purchase them, so that there is great reason to hope they may in future be looked on as an indispensable article of equipment for every long-distance fishing-boat.

Life-boats.—Since the last Annual Report nine new Life-boats have been placed on the coast; four sent to new stations, and the remainder to replace other boats.

The following are the stations to which those Life-boats have been or are about to be sent:—

ENGLAND AND WALES.

LINCOLNSHIRE . . .	Mablethorpe.
NORFOLK	Mundesley.
SUSSEX	Winchelsea.
CORNWALL	Looe.
“	Porthleven.
SOMERSETSHIRE . . .	Weston-super-Mare.
GLAMORGANSHIRE . .	Swansea.
CARNARVONSHIRE . .	Llanaelhaiarn.

IRELAND.

DONEGAL	Aranmore Island.
-------------------	------------------

Seven of the above boats have been supplied with transporting-carriages, and for four of them new boat-houses have been built.

The Life-boats of the Institution have been the means of saving *seven hundred and forty-one* lives during the past year from wrecked or endangered vessels.

In addition to the Life-boat services, 143 lives were saved from shipwreck by shore-boats and other means, for which services rewards were given by the Institution, making a total of 884 lives rescued last year.

With much regret the Committee have once more to report that the brave services of their Life-boat crews during the past year have not been performed without some loss of life, as if to remind their countrymen of the dangerous character of the Life-boat work.

On the night of the 4th of November, the Winchelsea self-righting Life-boat, when running, under sail, to the lee-shore of the Bay, off Rye Harbour, in reply to signals of distress, was struck by a heavy broadside sea and upset. One of her crew, named EDWARD ROBUS, unable to regain her, swam for the shore, and, unfortunately, being in a bad state of health at the time, succumbed, ere he reached it, to the cold and buffeting of the waves.

On the 26th of January last the New Brighton Tubular Life-boat, when proceeding to aid a wrecked crew off Crosby, near the entrance to the Mersey, also in the night, was struck by a very heavy sea, which swept two of her crew overboard, one of whom their boatmates succeeded in rescuing, but the other, named CHARLES FINLEY, was drowned.

Lastly, on the 27th January, the Swansea Life-boat, stationed at the village of Mumbles, when attempting to rescue the crew of the German barque *Admiral Prinz Adalbert*, from her windward side, was thrown violently against her, and swept over successive ridges of rock by heavy seas. On this melancholy occasion no less than four of her crew lost their lives, and the remainder were all more or less seriously injured, the coxswain, JENKIN JENKINS, losing two out of four of his sons who were in the boat, and a third having his leg broken.

In each of the above cases the poor men left a widow and children unprovided for, but the Committee granted to each widow the sum of 200*l.*, or 1,200*l.* in all, towards the local subscriptions raised in behalf of the widows and orphans.

Shipwrecks.—The loss of life from the numerous shipwrecks and collisions during the past year, and particularly during the fearful and frequent gales of last November and December, is sad to contemplate. It is, however, *satisfactory* to find that on such disastrous occasions the exertions of the Life-boats' crews are ever prompt and unceasing.

The number of Life-boats now under the management of the Institution is *Two hundred and seventy-three*, and their services during each month of the year were as follows:—

1882.	Number of Life-boat Launches.	Vessels Saved.	Lives Saved.
January	13	1	15
February	12	—	15
March	26	3	100
April	26	3	77
May	10	4	33
June			
July	15	1	54
August			
September	9	1	57
October	19	3	75
November	47	3	171
December	54	4	144
Total	231	23	741

As in former years, the launches of the Life-boats unattended with positive results have been very frequent. Nevertheless, it is no time for hesitation when the ship's signal of distress is either seen or heard; but on the contrary, it is a period when judgment and promptitude are of the utmost importance.

The Rocket Apparatus belonging to the BOARD OF TRADE, worked so efficiently by the Coast-guard and the Rocket Volunteer Brigades, also saved hundreds of lives in the same period.

The number of lives saved during the fifty-nine years from the establishment of the Institution, to the end of the year 1882, either by its Life-boats or by special exertions for which it has granted rewards, is 29,608, as shown in the annexed Table.

Every one must feel that the saving of so many thousand lives from drowning shows the absolute necessity of maintaining and extending the benevolent work of the NATIONAL LIFE-BOAT INSTITUTION, which has thus been productive of such noble results.

In the Year	No. of Lives Saved.	In the Year	No. of Lives Saved.
1824	124	1855	406
1825	218	1856	473
1826	175	1857	374
1827	163	1858	427
1828	301	1859	499
1829	463	1860	455
1830	372	1861	424
1831	287	1862	574
1832	310	1863	714
1833	449	1864	698
1834	214	1865	714
1835	364	1866	921
1836	225	1867	1,086
1837	272	1868	862
1838	456	1869	1,231
1839	279	1870	784
1840	353	1871	882
1841	128	1872	739
1842	276	1873	668
1843	236	1874	713
1844	193	1875	921
1845	235	1876	600
1846	134	1877	1,048
1847	157	1878	616
1848	123	1879	855
1849	209	1880	697
1850	470	1881	1,121
1851	230	1882	884
1852	773		
1853	678	Total	29,608
1854	355		

Rewards.—A summary is given in the Appendix of the cases in which honorary and other rewards have been voted last year. In that period 11 Silver Medals and Clasps, 19 Votes of Thanks inscribed on vellum, and 3,134/ were granted for saving the lives of 884 persons by Life-boats, shore and fishing boats, and by other means, on the shores and outlying sandbanks of our coasts.

Much time and careful consideration continue to be devoted by the Committee to the granting of these Rewards. Each case is minutely inquired into, in the first instance, through the valuable co-operation of the Officers of Coastguard and Customs, the local Honorary Secretaries of the several Branches, or other responsible persons; and afterwards they are in succession thoroughly considered by the Preparatory Committee, previous to their being sanctioned by the General Committee at their monthly meetings.

The thanks of the Institution are due, and have been respectfully and cordially

conveyed, by His Grace the President, on behalf of the Committee, to H.R.H. the DUKE of EDINBURGH, K.G., the late Admiral Superintendent of Naval Reserves, for his unceasing and valuable co-operation with this Committee during the period he held that important appointment.

The acknowledgments of the Committee are also due to the officers and men of the Coastguard Service, who are ever ready—often at the peril of their own lives—to save life from shipwreck.

Since its establishment the Institution has spent on Life-boat Stations, and other means for saving life from shipwreck on the coasts of the United Kingdom, upwards of 600,000*l.*, and has voted 96 Gold Medals, 962 Silver Medals, and 74,800*l.* in pecuniary rewards for saving life from shipwreck.

Local Committees.—The Committee have the satisfaction of acknowledging the continued valuable and earnest co-operation afforded them by the Local Branch Committees, and especially the Honorary Secretaries, which constitute so essential a portion of the machinery for the supervision and working of the Institution's numerous Life-boat Establishments, and for the collection of funds for their support.

Finances.—The donations, subscriptions, and dividends during the year 1882 have been 43,117*l.* 15*s.* 1*d.* Of this sum 7,615*l.* were special gifts to defray the cost of the following ten Life-boats, and 5,200*l.* to endow four Life-boats:—

	£.	s.	d.
Flamborough—Geo. Middlewood, Esq.	1,065	0	0
Llanæthaiarn—Mrs. Noble	800	0	0
Looe } "Boy's Own" Life-boat Fund	1,200	0	0
Poole }			
Mablethorpe—A. P. Heywood-Lonsdale, Esq.	1,000	0	0
Mundesley—Mrs. J. H. Elliott	1,000	0	0
Padstow—R. A. B. Preston, Esq.	1,000	0	0
Weston-super-Mare—Mrs. E. S. Symes (in aid)	150	0	0
Whitburn—A Lady	400	0	0
— A Friend (E. M. S.)	1,000	0	0

Endowments.

Bamburgh Castle—Miss Betty Cuttall	1,000	0	0
Tynemouth No. 1—Civil Service Life-boat Fund	1,000	0	0
Whitby No. 1—The late Mrs. M. A. Ellis	1,200	0	0
— Mrs. Joseph Somes	2,000	0	0

The Committee have likewise the satisfaction to acknowledge, in addition, the receipt, since the last Report, of the following special contributions:—

	£.	s.	d.
HER MAJESTY THE QUEEN (annual subscription)	50	0	0
<i>Athenian</i> , Union Steamship, Collected from passengers, per Capt. Warleigh	12	10	9
Berners Dramatic Club, Proceeds of Entertainment, per Mr. H. Finnis	10	0	0
Dublin, Proceeds of Concert at Howth, in aid of the Howth Life-boat, per Wm. Armstrong, Esq.	20	0	0
Glasgow, Collected by the Children of John Street Baptist Church Sabbath School, per R. Coats, Esq.	3	13	6
Hadnall, Salop, Collected after Sermons preached on Sunday, 5th November, per Rev. B. C. Mortimer	20	0	0
Hartlepool Engine Works, contributed by the Sea-going Engineers, per T. Richardson, jun., Esq.	8	0	0
Noden, E. Byron, Esq., appropriated from residue of trust fund	50	0	0
Plow, Rev. H. A., Bradley Rectory, Alresford, on behalf of his late son, Mr. J. C. Plow, R.N.	5	0	0
<i>Potosi</i> , s.s., Proceeds of Concert on board the, per Capt. C. E. Darley.	9	5	0
Royal Artillery at Aden, per Capt. J. J. Congdon, R.A.	10	0	0
S. Michael's, Paddington, amount of coll. per Rev. G. F. Prescott, M.A.	28	6	11
Shepperton, Profits from Penny Readings, per Rev. W. F. J. Hanbury	4	3	0
<i>Triumph</i> , H.M.S., Band Fund of, per Commander W. A. Ackland, R.N.	16	10	0

The Institution has been advised of the following Legacies during the past twelve months:—

	£.	s.	d.
Bates, Brian, Esq., Buxton	1,000	0	0
Bates, Robert, Esq., of Whitburn	50	0	0
Brown, Henry, Esq., Plymouth	100	0	0
Cheesman, George, Esq. Dorking	50	0	0
Churchill, Miss Elizabeth Rebecca, Exeter	100	0	0
Cooke, Christopher, Esq., Lincoln's Inn Fields	10	0	0
Cuff, Miss Alice, Frome	100	0	0
Domett, John, Esq., Camberwell	10	0	0
Duke, Miss Hannah, Hornsea	50	0	0

	£.	s.	d.
Elwes, Miss F. J., Highmoor Hall, Oxford	500	0	0
Eyre, G. J., Esq., Hove	200	0	0
Godwin, Henry Morgan, Esq., Brighton	1,000	0	0
Goodwin, Miss Elizabeth, Yaxley	50	0	0
Hay, David, Esq., Edinburgh	1,000	0	0
Henderson, Miss Elizabeth Frances, Edinburgh	50	0	0
Hewitt, Thomas, Esq., Meole Brace, Shropshire	500	0	0
Jeffrey, Miss Elizabeth, Nottingham	50	0	0
Lockwood, Mrs., Upper Phillimore Place	200	0	0
Marr, Miss Mary, Tufnell Park	19	19	0
Martin, Horace, Esq., Battle	100	0	0
Mayott, W. F., Esq., Camberwell	100	0	0
McGregor, Alexander, Esq., Glasgow	50	0	0
Oldham, James Naish, Esq., Bridlington Quay	500	0	0
Ord, W. G. H., Esq., Bowdon, Chester	250	0	0
Ormston, Robert, Esq., Newcastle-on-Tyne	1,000	0	0
Osborne, Rev. Philip, Leamington	1,000	0	0
Outlaw, Miss E. H., Weymouth	100	0	0
Oxley, C. C., Esq., Ripon	50	0	0
Paddon, Miss Emily, Brighton	100	0	0
Powell, G. E. J., Esq., Cardigan	50	0	0
Price, Mrs. A. T., Peckham	1,000	0	0
Sinclair, Mrs. Mary, Gourrock, N.B.	200	0	0
Stamp, Mrs. A. G., Hull	50	0	0
Stratford, T. N., Esq., Worcester	1,000	0	0
Suter, Henry, Esq., Douglas, Isle of Man	20	0	0
Washbourne, Mrs. Jane, Torquay	100	0	0
Williamson, Mrs. Anne, Manghold, Isle of Man	100	0	0
Wright, Mrs. Eliza, Southport	700	0	0

During the past year the sum of

11,731*l.* 16*s.* 3*d.* was expended on additional Life-boats, Transporting-carriages, Boat-houses, and necessary gear; 13,193*l.* 5*s.* 3*d.* in repairs, painting, refitting, and sundry charges on Life-boat Establishments, and on the Store-yard at Poplar; and 11,821*l.* 3*s.* 7*d.* in rewards for services to shipwrecked crews, coxswain's salaries, quarterly practice of the Life-boats' crews, and other expenses; making altogether a total expenditure of 36,746*l.* 5*s.* 1*d.*

The items of receipt and expenditure are fully detailed in the financial statement, which has been audited as usual by Mr. LOVELOCK, public accountant.

Having thus rendered a faithful account of the great trust the public has for nearly sixty years confided to them, it is a source of satisfaction to the Committee to conclude by stating that the organisation of the Institution was never more complete and active, than at the present time; and thus they are prompted afresh, and with unshaken confidence, to appeal for continued and increasing support to an Institution which, with God's blessing, has been, and is productive of such manifestly gratifying results in the cause of humanity.

P.S.—Since this Report was read to the Annual Meeting on the 13th March, the Committee have had regretfully to record the death of their late Secretary, Mr. Richard Lewis, who had held that important office, to the great advantage of the Institution, for the long period of Thirty-three years.

RESOLUTIONS PASSED AT THE ANNUAL MEETING
FOR 1883.

HIS GRACE THE DUKE OF NORTHUMBERLAND, P.C., D.C.L., IN THE CHAIR.

1.—Moved by the CHAIRMAN :—

1.—That the following Noblemen and Gentlemen be the Officers of the Institution for the current year :—
(*Vide* next page for this list.)

2.—Moved by The Right Hon. the EARL OF COURTOWN.

Seconded by R. M. BALLANTYNE, Esq.

2.—That the Report now read be adopted, printed, and circulated.

3.—Moved by ION T. HAMILTON, Esq., M.P.

Seconded by Capt. the Hon. FRANCIS MAUDE, R.N.

3.—That this Meeting, appreciating the invaluable services of the NATIONAL LIFE-BOAT INSTITUTION in the philanthropic work of saving human lives, congratulates the Managing Committee on the continued prosperity and success which have rewarded their exertions, and which it trusts the Institution may long continue to merit and achieve.

4.—Moved by F. J. ROBINSON, Esq.

Seconded by Colonel IREDELL.

4.—That this Meeting tenders its best thanks to THOMAS CHAPMAN, Esq., F.R.S., V.P., late Chairman; to EDWARD BIRKBECK, Esq., M.P., V.P., Chairman; to the Committee of

Management; and to the Officers of the Institution for their able administration of, and unremitting attention to, its important and extensive affairs.

Also to the Honorary Local Committees and Secretaries of the several Branches, for their earnest and active co-operation with the Parent Institution.

5.—Moved by Vice-Admiral AUGUSTUS PHILLIMORE.

Seconded by Colonel FITZROY CLAYTON.

5.—That this Meeting testifies afresh to the skill and indomitable spirit that continue to distinguish the Coxswains and Crews of the Life-boats, whose noble exertions were the means of saving no less than *seven hundred and forty-one* lives during the past year.

6.—Moved by EDWARD BIRKBECK, Esq., M.P., V.P., *Chairman*.

Seconded by Sir EDWARD G. L. PERROTT, Bart., V.P.

6.—That the best thanks of this Meeting be given to His Grace The DUKE OF NORTHUMBERLAND, P.C., D.C.L., for so ably presiding over this the fifty-ninth Annual Meeting of the ROYAL NATIONAL LIFE-BOAT INSTITUTION, and for the continued kind interest he takes in its welfare.

ROYAL NATIONAL LIFE-BOAT INSTITUTION,

For the Preservation of Life from Shipwreck.

(Incorporated by Royal Charter.)

FOUNDED IN 1824.—SUPPORTED SOLELY BY VOLUNTARY CONTRIBUTIONS.

PATRONESS.

Her Most Gracious Majesty the Queen.

VICE-PATRONS.

HIS ROYAL HIGHNESS THE PRINCE OF WALES, K.G.
Vice-Admiral HIS ROYAL HIGHNESS THE DUKE OF EDINBURGH, K.G.

PRESIDENT.

HIS GRACE THE DUKE OF NORTHUMBERLAND, P.C., D.C.L.

VICE-PRESIDENTS.

His Grace the ARCHBISHOP of CANTERBURY.
His Grace the DUKE of ARGYLL, K.T., F.R.S.
The Most Noble the MARQUIS of CHOLMONDELEY.
The Right Hon. the EARL of LEICESTER, K.G.
Admiral Sir GEORGE BROKE-MIDDLETON, Bart., C.B.
Sir EDWARD G. L. PERROTT, Bart.
THOMAS CHAPMAN, Esq., F.R.S.

EDWARD BIRKBECK, Esq., M.P.
JAMES CHADWICK, Esq.
W. H. HARTON, Esq.
T. B. POTTER, Esq., M.P.
HUGH TAYLOR, Esq.
ROBERT WHITWORTH, Esq.

COMMITTEE OF MANAGEMENT.

EDWARD BIRKBECK, Esq., M.P., V.P., *Chairman.*
Colonel FITZ-ROY CLAYTON, *Deputy-Chairman.*

The MARQUIS of CHOLMONDELEY, V.P.
L. T. CAVE, Esq.
Sir WILLIAM R. CLAYTON, Bart.
Admiral Sir RICHARD COLLINSON, K.C.B., Deputy Master of the Trinity House.
Colonel the Hon. C. F. CRICHTON.
Captain Sir F. J. O. EVANS, E.N., K.C.B., F.R.S., Hydrographer to the Admiralty.
The Right Hon. G. J. GÖSCHEN, M.P.
JOHN GRIFFITH, Esq.
WILLIAM H. HARTON, Esq., V.P.
A. P. HEYWOOD-LONSDALE, Esq.
Rear-Admiral Sir ANTHONY H. HOSKINS, K.C.B., Admiral Superintendent of Naval Reserves.
The Right Hon. JOHN GELLIBRAND HUBBARD, M.P.

WILLIAM HEARLE LYALL, Esq., M.A.
EUGENE F. NOEL, Esq.
Sir FRANCIS BOYD OUTRAM, Bart.
Lord ALFRED H. PAGET.
GEORGE PALMER, Esq.
The Right Hon. EARL PERCY, P.C., M.P.
Vice-Admiral AUGUSTUS PHILLIMORE.
The Right Hon. LORD ROBERTS.
Admiral A. P. RYDER.
Admiral of the Fleet, Sir GEORGE SARTORIUS, G.C.B.
Major-General TULLOH, R.A., C.B.
The Right Hon. the EARL WALDEGRAVE.
Vice-Admiral J. R. WARD.
T. M. WEGUELIN, Esq.

TRUSTEES.

THOMAS CHAPMAN, Esq., F.R.S., V.P. EDWARD BIRKBECK, Esq., M.P., V.P. The Right Hon. EARL PERCY, P.C., M.P.

BANKERS—Messrs. COUTTS and Co., 59 Strand.

TREASURER—HUGH LINDSAY ANTROBUS, Esq.

SECRETARY—CHARLES DIBDIN, Esq., F.R.G.S.

ASSISTANT SECRETARY—W. R. SMITH, Esq.

CHIEF LIFE-BOAT INSPECTOR—Vice-Admiral J. R. WARD.

DISTRICT LIFE-BOAT INSPECTORS.

Captain the Hon. H. W. CHETWYND, R.N.—London.

Commander C. LAPRIMAUDAITE, R.N.—Bristol.

Commander St. VINCENT NEPEAN, R.N.—Hull.

Commander GEORGES C. C. CARTER, R.N.—Edinburgh.

Lieutenant H. T. G. TIPPING, R.N.—Dublin.

ARCHITECT—C. H. COOKE, Esq., F.S.A.

SOLICITORS—Messrs. CLAYTON, SONS, and FARGUS.

AUDITOR—SAMUEL LOVELOCK, Esq., Public Accountant, F.C.A.

The object of this Institution, as declared in its title, and in its Charter of Incorporation, is to afford assistance to every shipwrecked person around the Coasts of the United Kingdom.

The chief means by which the Society endeavours to carry this object into effect are:—

By building, stationing, and maintaining in repair, Life-boats of the most perfect description; furnishing them with all necessary Appurtenances, including Houses to preserve them in, and Carriages for their conveyance to the spots where their Services are called for; and further, providing, through the instrumentality of Local Committees, for their proper Management and the occasional Exercise of their Crews.

By conferring Honorary Rewards in the form of Medals and Votes of Thanks, and also making liberal grants of money to all persons who, at the risk of their own lives, save, or attempt to save, those of others on board vessels wrecked, or in distress, upon any part of the Coasts of the United Kingdom.

The number of lives saved either by the Life-boats of the Institution, or by special exertions for which it has granted rewards, since its formation, is 29,608.

Donations and Annual Subscriptions are thankfully received by the Bankers of the Institution, Messrs. COUTTS and Co., 59 Strand; Messrs. HERRIES, FARQUHAR, and Co., 16 St. James's Street; Messrs. HOARE, 37 Fleet Street, London, by all the other Bankers in the United Kingdom; by all the Life-boat Branches; and by the Secretary at the Institution, 14 JOHN STREET, ADELPHI, LONDON, W.C.

Dr.

INCOME AND EXPENDITURE.—1st Jan. to 31st Dec. 1882.

Cr.

To LIFE-BOATS, viz.:	£.	s.	d.	£.	s.	d.
Aranmore	430	0	0			
Douglas (Repairs)	102	15	9			
Llanaelhaiarn	392	10	0			
Looe	328	18	0			
Mablethorpe	363	0	0			
Mundesley	363	0	0			
Padstow	363	0	0			
Pakefield No. 2 (Repairs)	59	0	0			
Porthleven	363	0	0			
Southwold No. 2 (Repairs)	77	0	0			
Weston-super-Mare	266	10	0			
Winchelsea	363	0	0			
Winterton Nos. 1 & 2 (Repairs)	107	0	0			
Spare Life-boats	726	0	0			
Alterations and repairs of Life-boats and Sundry Expenses on the 273 Life-boat Stations	7,621	10	7			
Salaries, &c., to six Inspectors of Life-boats	2,407	1	0			
Travelling Expenses, &c., of ditto	1,251	18	6			
				15,585	3	10

To LIFE-BOAT HOUSES AND SLIPWAYS, viz.:-	£.	s.	d.	£.	s.	d.
Aranmore	260	0	0			
Bamborough Castle	231	0	0			
Cardigan (Additional)	79	8	0			
Flamborough No. 2 (Repairs)	50	0	0			
Gorleston (Balance)	83	10	0			
Grimsby	576	0	0			
Hartlepool No. 2	320	0	0			
Hastings (Balance)	132	16	0			
Irvine (Repairs)	63	0	0			
Llanaelhaiarn	425	0	0			
Mablethorpe	212	0	0			
Margate (Repairs)	64	0	0			
Penmon	432	5	0			
Poole (Re-building)	165	0	0			
Silloth (Repairs)	61	10	0			
Weston-super-Mare	60	0	0			
Winchelsea	255	0	0			
Alterations and repairs of Life-boat Houses, &c.	606	13	9			
				4,077	2	9

To LIFE-BOAT CARRIAGES, viz.:-	£.	s.	d.	£.	s.	d.
Llanaelhaiarn	132	0	0			
Looe	129	0	0			
Mablethorpe	123	0	0			
Mundesley	129	0	0			
Porthleven	129	0	0			
Winchelsea	129	0	0			
Spare Life-boat Carriages	258	0	0			
Alterations and Repairs of Life-boat Carriages, &c.	254	10	0			
				1,283	10	0

To Life-boat Stores and Life-belts	2,451	9	6			
„ Fishermen's Aneroid Barometers	476	4	0			
„ Life-boat Store Yard at Poplar	1,051	11	5			

Carried forward £24,925 1 6

By Donations.	£.	s.	d.	£.	s.	d.
10,103 9 2						
By Subscriptions	3,671	19	8			
				13,775	8	10

By Special Gifts, amounting altogether to £12,815 0s., for the following Life-boats :-

Bamburgh Castle — Miss Betty Cuttell 1,000 0 0

Flamborough — Geo. Middlewood, Esq. 1,065 0 0

Llanaelhaiarn — Mrs. Noble 800 0 0

Looe } "Boy's Own" Life-Poole } boat Fund 1,200 0 0

Mablethorpe — A. P. Heywood-Lonsdale, Esq. 1,000 0 0

Mundesley — Mrs. J. H. Elliott 1,000 0 0

Padstow — R. A. B. Preston, Esq. 1,000 0 0

Tynemouth No. 1 — Civil Service Life-boat Fund 1,000 0 0

Weston-super-Mare — Mrs. E. S. Symes (in aid) 150 0 0

Whitburn — A Lady 400 0 0

Whitby No. 1 — The late Mrs. M. A. Ellis 1,200 0 0

———— Mrs. Joseph Some 2,000 0 0

———— A Friend (E. M. S.) 1,000 0 0

By Contributions from Branches 5,341 7 11

By Dividends and Interest 11,185 18 4

Carried forward £43,117 15 1

Dr. INCOME AND EXPENDITURE.—1st Jan. to 31st Dec. 1882—continued. Cr.

	£.	s.	d.		£.	s.	d.
Brought forward	£24,925	1	6	Brought forward	£43,117	15	1
To Life-boat Crews for saving Life, and for exercising the Life-boats quarterly . . .	8,587	18	6				
„ Printing <i>Life-boat Journal</i> , Annual Report, Stationery, Books, &c.	472	4	5				
„ Advertisements, Postages, and Parcels . . .	366	5	1				
„ Salaries to Secretary and Clerks	1,789	5	2				
„ Auditors' Fee	31	10	0				
„ Law Expenses on Leases and Bequests. . .	92	18	6				
„ Rent, Taxes, Housekeeper, &c.	247	5	7				
„ Repairs of Institution's House	211	9	6				
„ Annual Meeting, Messengers, &c.	22	6	10				
„ Balance carried to Balance Sheet	6,371	10	0				
	<u>£43,117</u>	<u>15</u>	<u>1</u>		<u>£43,117</u>	<u>15</u>	<u>1</u>

Examined and found correct, 12th January, 1883.

(Signed) SAMUEL LOVELOCK,
Auditor.

No.	STATION.	Length.	Breadth.	No. of Oars.	When Stationed or Named.
ENGLAND.					
		Ft. in.	Ft. in.		
1	NORTHUMBERLAND BERWICK-ON-TWEED - - -	33 0	8 0	10	1864
2	" HOLY ISLAND—No. 1 - - -	32 0	7 4	10	1865
3	" " No. 2 - - -	32 0	7 4	10	1868
4	" BAMBURGH CASTLE - - -	32 0	7 6	10	1882
5	" NORTH SUNDERLAND - - -	33 0	8 0	10	1865
6	" BOULMER - - - - -	33 0	8 0	10	1866
7	" ALNMOUTH - - - - -	32 0	7 5	10	1865
8	" HAUXLEY - - - - -	34 0	8 4	10	1866
9	" CRESSWELL - - - - -	30 0	8 0	8	1875
10	" NEWBIGGIN - - - - -	34 0	8 4	10	1866
11	" BLYTH—No. 1 - - - - -	33 0	8 0	10	1867
12	" " No. 2 - - - - -	30 0	8 0	8	1880
13	" CULLERCOATS - - - - -	33 0	8 0	10	1866
14	" TYNEMOUTH—No. 1 - - - - -	37 0	9 0	12	1875
15	" " No. 2 - - - - -	33 0	8 1	10	1872
16	DURHAM - - - - - WHITBURN - - - - -	34 0	8 0	10	1881
17	" SUNDERLAND—No. 1 - - - - -	30 0	8 0	8	1876
18	" " No. 2 - - - - -	30 3	8 7	10	1882
19	" " No. 3 - - - - -	33 0	8 2	10	1865
20	" " No. 4 - - - - -	36 0	9 0	12	1872
21	" SEAHAM - - - - -	33 0	8 6	10	1870
22	" HARTLEPOOL—No. 1 - - - - -	33 0	8 6	10	1876
23	" " No. 2 - - - - -	35 0	9 0	10	1876
24	" " No. 3 - - - - -	33 0	8 6	10	1878
25	" WEST HARTLEPOOL—No. 1 - - - - -	33 0	8 6	10	1869
26	" " No. 2 - - - - -	34 0	8 9	10	1874
27	" SEATON CAREW - - - - -	33 0	8 6	10	1873
28	YORKSHIRE - - - - - MIDDLESBROUGH - - - - -	33 0	8 0	10	1864
29	" REDCAR - - - - -	36 0	9 6	10	1867
30	" SALTBURN - - - - -	34 0	8 3	10	1880
31	" STAITHES - - - - -	32 0	8 0	10	1875
32	" RUNSWICK - - - - -	34 0	8 0	10	1880
33	" UPGANG - - - - -	32 0	7 6	10	1879
34	" WHITBY—No. 1 - - - - -	34 0	8 0	10	1881
35	" " No. 2 - - - - -	32 0	7 7	10	1879
36	" ROBIN HOOD'S BAY - - - - -	32 0	8 0	10	1881
37	" SCARBOROUGH - - - - -	35 0	9 0	10	1872
38	" FILEY - - - - -	33 0	8 0	10	1863
39	" FLAMBOROUGH—No. 1 - - - - -	33 0	8 6	10	1871
40	" " No. 2 - - - - -	33 0	8 0	10	1882
41	" BRIDLINGTON QUAY - - - - -	34 0	7 7	10	1871
42	" HORNSEA - - - - -	32 0	7 6	10	1875
43	" WITHERNSEA - - - - -	30 0	8 0	8	1878
44	LINCOLNSHIRE - - - - - GRIMSBY - - - - -	33 0	8 6	10	1868
45	" DONNA NOOK - - - - -	34 0	8 0	10	1878
46	" MABLETHORPE - - - - -	34 0	8 3	10	1883
47	" SUTTON - - - - -	30 0	8 0	8	1876
48	" CHAPEL - - - - -	30 0	8 0	8	1876
49	" SKEGNESS - - - - -	33 0	8 0	10	1874
50	NORFOLK - - - - - HUNSTANTON - - - - -	32 0	7 6	10	1867
51	" BRANCASTER - - - - -	33 0	8 0	10	1879
52	" WELLS - - - - -	37 0	9 0	12	1881
53	" BLAKENEY - - - - -	37 0	9 5	12	1873
54	" SHERINGHAM - - - - -	36 0	9 0	12	1867
55	" CROMER - - - - -	34 0	8 8	10	1868
56	" MUNDESLEY - - - - -	34 0	8 3	10	1882
57	" HASBOROUGH - - - - -	32 0	7 6	10	1866
58	" PALLING—No. 1 - - - - -	37 0	9 0	12	1882
59	" " No. 2 - - - - -	40 0	11 6	14	1870
60	" WINTERTON—No. 1 - - - - -	32 0	10 0	12	1878
61	" " No. 2 - - - - -	36 0	10 6	14	1879
62	" CAISTER—No. 1 - - - - -	42 0	11 6	14	1878
63	" " No. 2 - - - - -	33 7	10 0	12	1875

No.	NAME OF BOAT AND DONOR.	NAME AND ADDRESS OF HONORARY SECRETARY.
1	<i>Albert Victor</i> —Manchester Branch	B. G. Sinclair, Esq., Berwick-on-Tweed.
2	<i>Grace Darling</i> —The late Lady Watson	Rev. W. W. F. Keeling, Holy Island, Beal, R.S.O.
3	<i>Bombay</i> —The late Mr. J. G., and Mrs. Frith	R. A. Storrar, Esq., Bamburgh Castle, Belford.
4	<i>John and Betty Cuttell</i> —The late Mr. Cuttell	Capt. A. Marshall, N. Sunderland, Chathill.
5	<i>Joseph Anstice</i> —The late Mrs. Anstice	Rev. L. J. Stephens, M.A., Long Houghton Vicarage, Lesbury, R.S.O.
6	<i>Robin Hood of Nottingham</i> —Nottingham	H. Smith, Esq., Alnmouth, R.S.O., Northumberland. Rev. James Fairbrother, Amble, Acklington.
7	<i>John Atkinson</i> —Miss Wardell	Rev. R. E. Taylor, Cresswell Vicarage, Morpeth.
8	<i>Algernon & Eleanor</i> —Her Grace the Dowager Duchess of Northumberland	Rev. Edward Shortt, M.A., Woodhorn Vicarage, Morpeth.
9	<i>Old Potter</i> —Thos. Hackwood, Esq.	Mr. James Ross, Jun., Blyth, Northumberland.
10	<i>W. Hopkinson, of Brighouse</i> —The late Miss Hopkinson	Major Adamson, Cullercoats, Newcastle-on-Tyne.
11	<i>Salford</i> —Manchester Branch	P. J. Messent, Esq., C.E., Tynemouth, North Shields.
12	<i>Tom and Marion</i> —Mr. & Mrs. T. Jones Gibb	W. H. Williamson, Esq., Whitburn, nr. Sunderland.
13	<i>Palmerston</i> —Peter Reid, Esq.	J. C. Porrett, Esq., 52 West Sunnyside, Sunderland.
14	<i>Charles Dibdin</i> —Civil Service No. 2 Fund	[R.S.O.] William Warham, Esq., Londonderry Offices, Seaham.
15	<i>Forester</i> —A. O. of Foresters	S. Herbert Belk, Esq., Hartlepool.
16	<i>William and Charles</i> —A Lady	Alfred Belk, Esq., Hartlepool.
17	<i>Good Templar</i> —That Life-boat Fund	C. A. Baker, Esq., North Eastern Railway, West Hartlepool.
18	<i>Mary</i> —Miss Beckett's Legacy	Rev. John Lawson, M.A., Seaton Carew, West Hartlepool.
19	<i>Florence Nightingale</i> —Town of Derby	A. O. Cochrane, Esq., Ormesby Iron Works, Middlesbrough-on-Tees.
20	<i>John Foulston</i> —The late Mrs. Foulston	J. M. Meek, Esq., Coatham, Redcar.
21	<i>Sisters Carter, of Harragate</i> —Misses Carter	Mr. T. G. Pearson, Saltburn-by-the-Sea.
22	<i>Charles Mather</i> —Mrs. Annie Mather	Dr. J. V. Laverick, Hinderwell, Staithes.
23	<i>Charles Ingleby</i> —Trust Fund, per G. P. Wragge, Esq.	E. W. Chapman, Esq., Whitby.
24	<i>John Clay Barlow</i> —Miss Barlow	Mr. Robert Gibson, Harbour Master, Whitby.
25	<i>Rochdale</i> —Collected in Rochdale	Rev. R. Jermyn Cooper, Fylingdales Vicarage, Whitby.
26	<i>Foresters' Pride</i> —A. O. of Foresters	John Stephenson, Esq., Scarborough.
27	<i>Job Hindley</i> —The late Mr. Hindley, per Manchester Branch	A. E. Hick, Esq., St. Thomas Street, Scarborough.
28	<i>Crossley</i> —Messrs. J. Crossley and Sons	W. Hanks, Esq., Filey, R.S.O., Yorkshire.
29	<i>Burton-on-Trent</i> —Town of Burton-on-Trent	Rev. J. F. Wilkinson, M.A., Flamborough, Hull.
30	<i>Charles and Ann</i> —Mrs. Townend, per Manchester Branch	Alfred West, Esq., Garrison St., Bridlington Quay.
31	<i>Hannah Somerset</i> —Mrs. Yates' Legacy	Mr. George Milner, Southgate, Hornsea, near Hull.
32	<i>Margaret and Edward</i> —A Lady	Horatio H. Ayre, Esq., Withernsea, near Hull.
33	<i>Joseph Sykes</i> —Mrs. A. E. Sykes' Legacy	F. Dawson, Esq., Victoria Chambers, Grimsby.
34	<i>Robert and Mary Ellis</i> —Mrs. M. A. Ellis	Mr. Gilbert Houlden, North Somercotes, Grimsby.
35	<i>Harriott Forteath</i> —Late Mrs. Forteath	Lieut. E. J. V. Pritchard, R.N., Coastg., Mablethorpe, [Alford].
36	<i>Ephraim and Hannah Fox</i> —Mr. and Mrs. Fox's Children	R. Bradshaw, Esq., Hogsthorpe, Alford.
37	<i>Lady Leigh</i> —Warwickshire Freemasons	C. F. Grantham, Esq., Skegness, R.S.O., Lincolnshire.
38	<i>Hollon</i> —Mr. and Mrs. Hollon	Mr. W. H. Colbeck, Ch. Officer, C. G ^d , Skegness, R.S.O., Lincolnshire.
39	<i>Gertrude</i> —Legacy of John Beckett, Esq.	Capt. G. H. Noel, R.N., Hunstanton, Norfolk. [Lynn].
40	<i>Matthew Middlewood</i> —G. Middlewood, Esq.	Rev. E. K. Kerslake, M.A., Deepdale Rectory, King's Lynn.
41	<i>John Abbott</i> —Mr. Abbott's Legacy	E. Dewing, Esq., Burnham Overy, King's Lynn.
42	<i>Ellen and Margaret of Settle</i> —Settle Fund	John Loynes, Esq., Wells, Norfolk.
43	<i>Admiral Rous</i> —That Life-boat Fund	Rev. R. H. Tillard, M.A., Blakeney, Dereham.
44	<i>Manchester Unity</i> —I. O. of Odd Fels. (M.U.)	Rev. Lethbridge Moore, Sheringham, Cromer.
45	<i>Richard</i> —Miss Dixon	W. G. Sandford, Esq., Cromer.
46	<i>Heywood</i> —A. P. Heywood-Lonsdale, Esq.	Mr. G. Gordon, Mundesley, North Walsham, Norfolk.
47	<i>Caroline</i> —N. R.	Rev. J. Slater, M.A., Hasborough, Norwich.
48	<i>Land-seer</i> —Miss Landseer	Mr. E. French, Chief Officer C. G ^d , Palling, Norwich.
49	<i>Herbert Ingram</i> —Mr. Ingram's Friends	Rev. Wm. Green, M.A., Winterton, Great Yarmouth.
50	<i>Licensed Victualler</i> —Licensed Victuallers	Rev. E. G. H. Murrell, Caister, Great Yarmouth.
51	<i>Lily Bird</i> —Samuel Bird, Esq.	
52	<i>Charlotte Nicholls</i> —Miss Nicholls' Legacy	
53	<i>Hettie</i> —A Friend at Bradford	
54	<i>Duncan</i> —Mrs. Fraser	
55	<i>Benjamin Bond Cabbell</i>	
56	<i>J. H. Elliott</i> —Mrs. J. H. Elliott	
57	<i>Huddersfield</i> —Huddersfield	
58	<i>Heyland</i> —That Memorial Fund	
59	<i>British Workman</i> —That Magazine	
60	<i>Edward Birkbeck</i> —R. N. L. B. Institution	
61	<i>Husband</i> —Late Mrs. Davis	
62	<i>Covent Garden</i> —That Life-boat Fund	
63	<i>Godsend</i> —Lady Bouchier	

[Continued.]

No.	STATION.	Length.		Breadth.		No. of Oars.	When Stationed or Named.
		Ft.	In.	Ft.	In.		
64	NORFOLK - - - YARMOUTH—No. 1 - - - -	42	3	11	9	12	1861
65	" No. 2 - - - -	28	0	9	0	10	1875
66	SUFFOLK - - - GORLESTON - - - -	30	0	10	0	10	1870
67	LOWESTOFT - - - -	44	0	12	3	14	1876
68	PAKEFIELD—No. 1 - - - -	46	3	12	0	14	1872
69	" No. 2 - - - -	30	0	9	0	12	1871
70	KESSINGLAND—No. 1 - - - -	42	0	12	0	14	1870
71	" No. 2 - - - -	32	0	10	0	12	1879
72	SOUTHWOLD—No. 1 - - - -	40	0	11	6	12	1855
73	" No. 2 - - - -	30	0	8	11	12	1882
74	DUNWICH - - - -	30	0	7	8	8	1873
75	THORPENESS - - - -	37	0	9	4	12	1873
76	ALDBOROUGH - - - -	40	0	10	5	12	1870
77	ESSEX - - - - HARWICH - - - -	45	0	11	0	12	1881
78	CLACTON-ON-SEA - - - -	34	0	8	3	10	1878
79	SOUTHEND - - - -	25	0	7	3	8	1879
80	KENT - - - - MARGATE - - - -	34	0	8	3	10	1866
81	KINGSGATE - - - -	28	0	7	3	8	1880
82	BROADSTAIRS - - - -	36	0	9	2	12	1868
83	RAMSGATE - - - -	44	0	11	1	12	1877
84	NORTH DEAL - - - -	40	0	10	0	12	1881
85	WALMER - - - -	36	0	9	4	12	1871
86	KINGSDOWNE - - - -	36	0	9	0	12	1882
87	DOVER - - - -	35	0	9	0	10	1878
88	HYTHE - - - -	35	0	9	0	10	1876
89	NEW ROMNEY - - - -	32	0	7	6	10	1871
90	LYDD, DUNGENESS - - - -	33	0	7	9	10	1874
91	SUSSEX - - - - RYE - - - -	34	0	7	9	10	1881
92	WINCHELSEA - - - -	34	0	7	9	10	1883
93	HASTINGS - - - -	34	0	8	3	10	1880
94	EASTBOURNE - - - -	34	0	8	3	10	1880
95	NEWHAVEN - - - -	37	0	9	0	12	1881
96	BRIGHTON - - - -	32	0	7	8	10	1867-74
97	SHOREHAM - - - -	33	0	8	1	10	1865
98	WORTHING - - - -	32	0	7	6	10	1880
99	SELSEY - - - -	32	0	7	6	10	1865
100	CHICHESTER HARBOUR - - - -	32	0	7	5	10	1873
101	HAMPSHIRE - - - HAYLING ISLAND - - - -	32	0	7	5	10	1865
102	ISLE OF WIGHT - BEMBRIDGE - - - -	32	0	7	7	10	1867
103	BRIGHTSTONE GRANGE - - - -	34	0	8	0	10	1880
104	BROOKE - - - -	32	0	7	6	10	1867
105	ALDERNEY - - - ST. ANNE - - - -	33	0	8	6	10	1869
106	GUERNSEY - - - ST. PETER'S - - - -	32	0	7	8	10	1875
107	DORSET - - - POOLE - - - -	34	0	8	3	10	1880
108	SWANAGE - - - -	35	0	9	0	10	1875
109	KIMERIDGE - - - -	32	0	7	6	10	1881
110	WEYMOUTH - - - -	33	0	8	6	10	1869
111	LYME REGIS - - - -	33	0	8	0	10	1866
112	SOUTH DEVON - SIDMOUTH - - - -	33	0	8	6	10	1869
113	EXMOUTH - - - -	32	0	7	6	10	1867
114	TEIGNMOUTH - - - -	32	0	7	4	10	1880
115	TORQUAY - - - -	33	0	8	6	10	1876
116	BRIXHAM - - - -	34	0	8	6	10	1866
117	DARTMOUTH - - - -	33	0	8	6	10	1878
118	SALCOMBE - - - -	33	0	8	6	10	1869
119	HOPE COVE - - - -	35	0	9	0	10	1878
120	YEALM RIVER - - - -	35	0	9	0	10	1878
121	PLYMOUTH - - - -	34	0	7	9	10	1873

No.	NAME OF BOAT AND DONOR.	NAME AND ADDRESS OF HONORARY SECRETARY.
64	<i>Mark Lane</i> —London Corn Exchange	Walter Diver, Esq., 1 Regent Road, Great Yarmouth.
65	<i>Abraham Thomas</i> —M. B.	
66	<i>Leicester</i> —Town of Leicester	Joseph Tomlinson, Esq., Gorleston, Great Yarmouth. B. Preston, Esq., Lowestoft.
67	<i>Samuel Plimsoll</i> —Plimsoll Life-boat Funds	
68	<i>The Two Sisters, Mary and Hannah</i> —The late Mr. Thomas Parkin.	Rev. L. Price, Pakefield, near Lowestoft.
69	<i>Henry Burford, R.N.</i> —Legacy of J. L.	
70	<i>Bolton</i> —Town of Bolton [Fund	Mr. C. Rashley, Chief Officer of C. G ^d , Kessingland, Lowestoft.
71	<i>St. Michael's, Paddington</i> —That Life-boat	
72	<i>London Coal Exchange</i> —London Coal Exchange	Mr. J. Sinclair, Southwold, Suffolk.
73	<i>Quiver No. 2</i> —Quiver Magazine	
74	<i>John Keble</i> —Rev. T. Keble	Rev. J. F. Noott, Frostenden Hermitage, Wangford.
75	<i>Ipswich</i> —Town of Ipswich	
76	<i>George Hounsfeld</i> —Mrs. Hounsfeld	James Osborne, Esq., Aldborough, Suffolk.
77	<i>Springwell</i> —Miss Burmester	
78	<i>Albert Edward</i> —Freemasons of England	Dr. S. Evans, Harwich. W. Wrench Towse, Esq., Clacton-on-Sea, Colchester.
79	<i>Boys of England and Edwin J. Brett</i> —That Life-boat Fund.	
80	<i>Quiver No. 1</i> —Quiver Magazine	William Crawford, Esq., Margate. Major Webb, Elmwood, St. Peters, Ramsgate.
81	<i>Thomas Chapman</i> —R. N. L. B. Institution.	
82	<i>Samuel Morrison Collins</i> —A Lady	Mr. J. J. Francis, Chief Off. of C. G ^d , Kingsgate, Margate. Mr. Thomas Jackson, H. M. Coastguard, Broadstairs. Capt. E. Jones, Harbour Master, Ramsgate.
83	<i>Bradford</i> —Town of Bradford	
84	<i>Mary Somerville</i> —Miss Somerville's legacy	Rev. T. S. Treanor, Upper Deal.
85	<i>Centurion</i> —A Friend	
86	<i>Charles Hargrave</i> —His Legacy	Mr. W. Bailey, H. M. C. G ^d , Kingsdowne, near Dover. Lieut.-General Bruce, C.B., 1 East Cliff, Dover.
87	<i>Henry William Pickersgill, R.A.</i> —His Legacy.	
88	<i>Mayer de Rothschild</i> —Lady Rosebery	George Wilks, Esq., Hythe, Kent. John Humphery, Esq., New Romney, S.O., Kent.
89	<i>Dr. Hatton</i> —Mrs. Hatton	
90	<i>David Hulett</i> —D. Hulett, Esq.	E. T. Bass, Esq., J.P., Lydd, New Romney, S.O., Kent. J. S. Vidler, Esq., Mountsfield, Rye, S.O., Sussex.
91	<i>Mary Stanford</i> —Legacy of John Stanford, Esq.	
92	<i>Frances Harris</i> —Her Legacy	Mr. R. A. Howes, Chief Off. H. M. C. G ^d , Camber, near Rye. Mr. John Little, H. M. C. G ^d , Winchelsea, near Rye.
93	<i>Charles Arkcoll</i> —Charles Arkcoll, Esq.	
94	<i>William and Mary</i> —Friends at Manchester	Mr. G. Hutchings, 7A Wellington Place, Hastings. Mr. H. M. Emary, 64 Pevensey Road, Eastbourne.
95	<i>Michael Henry</i> —Jewish Scholars' Life-boat Fund.	
96	<i>Robert Raikes</i> —London Sunday Schools	W. R. Wood, Jun., Esq., 53 Norfolk Square, Brighton. Thos. Fuller, Esq. M.D., Longcroft, Shoreham.
97	<i>Ramonet</i> —The late Miss Robertson	
98	<i>Henry Harris</i> —Mr. Harris's Legacy	Melvill Green, Esq., Worthing. Rev. H. Mitchell, M.A., Bosham, near Chichester.
99	<i>Four Sisters</i> —Misses Hallam and Mrs. Birt	
100	<i>Undaunted</i> —The late Richard Thornton West, Esq., and Mrs. West	Rev. H. Foster, Selsey Rectory, Chichester. J. Gorham, Esq., Cackham, Chichester.
101	<i>Olive Leaf</i> —Messrs. Leaf, Sons, and Co.	
102	<i>City of Worcester</i>	Wm. Payne, Esq., National Provincial Bank of England, Portsea, Hants. [I.W. Admiral Wilmshurst, C.B., Bembridge, Brading, R.S.O.,
103	<i>Worcester Cadet</i> —That Life-boat Fund	
104	<i>George and Anne</i> —Mr. and Miss Marten	Rev. W. E. Heygate, M.A., Brightstone, Newport, I.W. Rev. Reginald Broughton, Shorwell, Newport, I.W.
105	<i>Mary and Victoria</i> —The Earl of Strafford	
106	<i>John Lockett</i> —Mrs. and the Misses Lockett	Mr. W. Selby, Brooke Farm, Isle of Wight. Nicholas Barbenson, Esq., Alderney, Guernsey.
107	<i>Boy's Own No. 2</i> —That Life-boat Fund	Capt. Carré, R.N., Valnord, Guernsey.
108	<i>Charlotte Mary</i> —S. J. Wilde, Esq., for late Miss M. R. Wilde.	
109	<i>Mary Heape</i> —Benjamin Heape, Esq.	G. Braxton Aldridge, Esq., Poole. Mr. Henry Hixson, Swanage, Wareham.
110	<i>Agnes Harriet</i> —The Earl of Strafford	
111	<i>Wm. Woodcock</i> —H. W., Manchester Branch	George H. Bond, Esq., Creech Grange, Wareham. G. H. Price, Esq., Collector H.M. Customs, Weymouth. Mr. H. Miller, Marine Parade, Lyme Regis.
112	<i>Rimington</i> —Mrs. Rimington	
113	<i>Victoria</i> —Lady Rolle	W. M. Floyd, Esq., Sidmouth. Capt. Squire, 1 Louisa Terrace, Exmouth.
114	<i>Arnold</i> —Teignmouth Bazaar	
115	<i>Mary Brundret</i> —Mrs. Brundret, per Manchester Branch	J. W. Beater, Esq., Teignmouth, Devon. Mr. R. G. Cove, Clifton Villa, Warren Road, Torquay.
116	<i>City of Exeter</i> —Collected in Exeter	
117	<i>Maud Hargreaves</i> —Mrs. Hargreaves	Rev. R. F. Elrington, M.A., Lower Brixham, Devon. Percy Hockin, Esq., Dartmouth.
118	<i>Rescue</i> —The late Richard Durant, Esq.	
119	<i>Alexandra</i> —Freemasons of England	J. H. Hill, Esq., Salcombe, Kingsbridge.
120	<i>Bowman</i> —"A. B. S."	
121	<i>Clemency</i> —Hon. Mrs. Hubbard	M. Williams, Esq., Gnaton Hall, Yealmpton, Plympton. James Rooney, Esq., Great Western Docks, Plymouth.

[Continued.]

No.	STATION.	Length.		Breadth.		No. of Oars.	When Stationed or Named.
		Ft.	in.	Ft.	in.		
122	CORNWALL - - - LOOE - - - - -	34	0	8	0	10	1882
123	FOWEY - - - - -	32	0	7	5	10	1879
124	MEVAGISSEY - - - - -	33	0	8	1	10	1869
125	PORTLOE - - - - -	33	0	8	1	10	1870
126	FALMOUTH - - - - -	33	0	8	6	10	1867
127	PORTHOUSTOCK - - - - -	33	0	8	0	10	1869
128	CADGWITH - - - - -	33	0	8	1	10	1878
129	LIZARD - - - - -	30	0	7	2	10	1873
130	MULLION - - - - -	33	0	8	6	10	1867
131	PORTHLEVEN - - - - -	34	0	7	9	10	1882
132	PENZANCE - - - - -	32	0	7	4	10	1865
133	SENNEN COVE - - - - -	34	0	8	3	10	1880
134	SCILLY ISLANDS - ST. MARY'S - - - - -	37	0	9	0	12	1874
135	CORNWALL - - - ST. IVES - - - - -	32	0	7	6	10	1878
136	HAYLE - - - - -	32	0	7	6	10	1866
137	NEW QUAY - - - - -	33	0	8	1	10	1873
138	PADSTOW - - - - -	32	0	7	4	10	1883
139	PORT ISAAC - - - - -	32	0	7	7	10	1869
140	BUDE - - - - -	33	0	8	0	10	1863
141	NORTH DEVON - - CLOVELLY - - - - -	33	0	8	1	10	1881
142	APPLEDORE—No. 1 - - - - -	34	0	7	1	12	1862
143	„ No. 2 - - - - -	30	0	6	7	6	1875
144	BRAUNTON - - - - -	34	0	8	1	10	1881
145	MORTE BAY - - - - -	33	0	7	11	10	1871
146	ILFRACOMBE - - - - -	32	0	7	6	10	1866
147	LYNMOUTH - - - - -	30	0	7	7	8	1869
148	SOMERSET - - - WATCHET - - - - -	33	0	8	6	10	1875
149	BURNHAM - - - - -	32	0	7	5	10	1866
150	WESTON SUPER MARE - - - - -	25	0	7	3	8	1882
SOUTH WALES.							
151	GLAMORGANSHIRE PENARTH - - - - -	37	0	8	0	12	1881
152	PORTHCAWL - - - - -	32	0	7	9	10	1872
153	SWANSEA - - - - -	34	0	8	3	10	1883
154	CARMARTHENSHIRE PEMBREY - - - - -	32	0	7	6	10	1871
155	CARMARTHEN BAY - - - - -	32	0	7	6	10	1879
156	PEMBROKESHIRE - TENBY - - - - -	33	0	8	0	10	1877
157	MILFORD - - - - -	33	0	8	6	10	1868
158	LITTLEHAVEN, ST. BRIDE'S - - - - -	33	0	8	2	10	1882
159	SOLVA - - - - -	33	0	8	1	10	1869
160	ST. DAVID'S - - - - -	32	0	7	6	10	1869
161	FISHGUARD—No. 1 - - - - -	30	0	6	8	6	1863
162	„ No. 2 - - - - -	36	0	8	3	12	1878
163	CARDIGANSHIRE - CARDIGAN - - - - -	32	0	7	4	10	1864
164	NEWQUAY - - - - -	35	0	8	0	12	1864
165	ABERYSTWTH - - - - -	35	0	9	0	10	1881
NORTH WALES.							
166	MERIONETHSHIRE - ABERDOVEY - - - - -	32	0	7	4	10	1865
167	BARMOUTH - - - - -	34	0	8	4	10	1867
168	CARNARVONSHIRE - PORTMADOC - - - - -	34	0	8	0	10	1882
169	ABERSOCH - - - - -	33	0	8	1	10	1869
170	PORTHDINLLAEN - - - - -	37	0	9	0	12	1877
171	LLANAELHAIARN - - - - -	37	0	8	0	12	1883
172	ANGLESEY - - - LLANDDWYN - - - - -	32	0	7	6	10	1866
173	RHOSNEIGIE - - - - -	30	0	7	6	10	1872
174	RHOSCOLYN - - - - -	33	0	8	0	10	1878

No.	NAME OF BOAT AND DONOR.	NAME AND ADDRESS OF HONORARY SECRETARY.
122	<i>Boys' Own No. 1</i> —That Life-boat Fund . . .	R. Thomas, Esq., Looe, R.S.O., Cornwall. [Cornwall.
123	<i>Arthur Hill</i> —Arthur Hill, Esq.	W. E. Geach, Esq., Penellick, Par Station, R.S.O.,
124	<i>South Warwickshire</i> —Collected by Sir R. N. Hamilton, Bt.	Capt. J. Ball Farran, Mevagissey, St. Austell.
125	<i>Gorfenkle</i> —Legacy of J. Gorfenkle, Esq. . .	The Honorary Secretary, Veryan, Grampound Road.
126	<i>City of Gloucester</i> —Gloucester City . . .	T. R. Grylls, Esq., Falmouth.
127	<i>Mary Ann Story</i> —Mrs. Story's Legacy . . .	Mr. E. P. Roskrige, St. Keverne, Helston.
128	<i>Joseph Armstrong</i> —That Life-boat Fund . .	The Honorary Secretary, Ruan Minor, R.S.O., Cornwall.
129	<i>Anna Maria</i> —The late Lord Robartes . . .	Rev. F. Vyvyan Robinson, The Lizard, Cornwall.
130	<i>Daniel J. Draper</i> —Wesleyan Methodists . .	Rev. E. G. Harvey, Mullion, Cury Cross Lanes, R.S.O.,
131	<i>Charles Henry Wright</i> —Mrs. Wright's Legacy	J. P. Thomas, Esq., Porthleven, Helston. [Cornwall.
132	<i>Richard Lewis</i> —J. C.	Fredk. C. Mathews, Esq., Dock Office, Penzance.
133	<i>Denzil and Maria Onslow</i> —Miss Onslow . .	
134	<i>Henry Dundas</i> —Mrs. Dundas Drummond's Legacy.	Mr. E. J. Bluett, Scilly, R.S.O., Cornwall.
135	<i>Exeter</i> —Mr. W. Kendall's Legacy	W. T. Tresidder, Esq., St. Ives, R.S.O., Cornwall.
136	<i>Isis</i> —Oxford University	John Poole, Esq., Riviere, Hayle.
137	<i>Pendock Neale</i> —Late Miss Neale and Miss Herring.	Capt. W. Thomas, New Quay, R.S.O., Cornwall.
138	<i>Arab</i> —R. A. B. Preston, Esq.	Capt. Key, Padstow, R.S.O., Cornwall.
139	<i>Richard and Sarah</i> —The late Richard Thornton West, Esq., and Mrs. West.	Rev. J. Lock, Port Isaac, Wadebridge, R.S.O.
140	<i>Elizabeth Moore Garden</i> —Family of the late R. T. Garden, Esq.	Wm. Rowe, Esq., Stratton, "North Devon Mail."
141	<i>Graham Hughes</i> —The late Mrs. Hughes . .	Mr. J. Bumby, Chief Officer Ct. Gd., Clovelly, Bideford.
142	<i>Hope</i> —The late Rev. F. W. Hope	Rev. I. H. Gosset, M.A., The Priory, Westward Ho! Bideford.
143	<i>Mary Ann</i> —The late Mrs. M. A. Walker . .	Mr. W. Nicol, Appledore, R.S.O., Devon.
144	<i>Robert and Catherine</i> —Miss Leicester . . .	Mr. H. C. Guppy, National Provincial Bank, Barnstaple.
145	<i>Grace Woodbury</i> —Mr. Robt. Atton's Legacy	N. Vye, Esq., J.P., Ilfracombe.
146	<i>Broadwater</i> —Late R. Broadwater, Esq. . . .	Mr. John Crook, Valley of Rocks Hotel, Lynton, Barnstaple.
147	<i>Henry</i> —A Lady	
148	<i>Joseph Somes</i> —Mrs. Joseph Somes	R. J. Gimblett, Esq., Williton, Taunton.
149	<i>Cheltenham</i> —Town of Cheltenham	John Compson, Esq., Burnham, near Bridgewater.
150	<i>William James Holt</i> —Late Col. Holt and Mrs. Symes.	W. E. Hillier, Esq., Somersetshire Bank, Weston-super-Mare.
151	<i>Joseph Denman</i> —Hon. Mrs. Joseph Denman	Capt. Pengelley, H.M.I.N., Dock Master, Penarth, Rev. W. Jones, Newton Nottage, Bridgend. [Cardiff.
152	<i>Chafyn Grove</i> —Miss J. E. Chafyn Grove . .	
153	<i>Wolverhampton</i> —Town of Wolverhampton.	
154	<i>Stanton Meyrick, of Pimlico</i> —His Legacy . .	T. W. Islay Young, Esq., Caehir, West Cross, near Swansea.
155	<i>City of Manchester</i> —Manchester Branch . .	Gerard Elkington, Esq., Pembrey, Llanelly.
156	<i>Carolina Morris's Divine Rescue</i> —Mrs. Morris's Legacy.	John Risley, Esq., Brondeg, Ferryside, R.S.O.
157	<i>Katharine</i> —Titus Salt, Esq.	J. R. Rowlands, Esq., Nat. Provincial Bank, Tenby.
158	<i>Friend</i> —Mr. Corker's Legacy	Henry Pattison, Esq., Collector H.M. Customs, Milford.
159	<i>Charles and Margaret Egerton</i> —Widow of Capt. Egerton, R.N.	
160	<i>Augusta</i> —Earl of Dartmouth and Tenantry	Capt. Goldwyer, Walton Ho., Littlehaven, Haverfordwest.
161	<i>Str Edward Perrott</i> —R. N. L. B. Institution	Samson T. Williams, Esq., Solva, R.S.O., Pembrokeshire. [Pembrokeshire.
162	<i>Helen of Foxley</i> —Miss Harrison's Legacy . .	W. Peregrine Probert, Esq., LL.D., St. David's, R.S.O.,
163	<i>John Stuart</i> —Manchester Branch	Mr. W. Vaughan, Fishguard, R.S.O., Pembrokeshire.
164	<i>Nelson</i> —A Lady	John Morgan, Esq., Collector H.M. Customs, Cardigan.
165	<i>Lady Haberfield</i> —Her Legacy	Capt. David James, 2 High Terrace, New Quay, Llandys- Rev. J. Williams, Bridge Street, Aberystwith. [sil.
166	<i>Royal Berkshire</i> —Berkshire	[North Wales.
167	<i>Ellen</i> —"E. P. S."	Dr. F. H. V. Grosholz, Pier House, Aberdovey, R.S.O., Mr. G. Griffiths, 2 St. Ann's Square, Barmouth, R.S.O., D. Homfray, Esq., Portmadoc, R.S.O., Carnarvonshire.
168	Royal National Life-boat Institution . . .	Rev. O. Lloyd Williams, Bodfean, Pwllheli.
169	<i>Mabel Louisa</i> —Late R. Barnes, Esq., per Manchester Branch	
170	<i>George Moore</i> —That Life-Boat Fund	Rev. H. E. Williams, Llanaelhaiarn, Carnarvon.
171	<i>Cyprian</i> —Mrs. Noble	
172	<i>John Gray Bell</i> —H. W., Manchester Branch	John Jackson, Esq., Harbour Office, Carnarvon.
173	<i>Thomas Lingham</i> —Mrs. Lingham	Mr. J. W. Huws, Brynteg, Llanfaelog, Holyhead.
174	<i>Ramon Cabrera</i> —The Countess de Morella . .	Colonel Marshall, Towyn Lodge, Holyhead.

[Continued.

No.	STATION.	Length.	Breadth.	No. of cars.	When Stationed or Named.
175	ANGLESEY - - - HOLYHEAD - - - - -	Ft. in. 37 0	Ft. in. 9 1	12	1875
176	CEMLYN - - - - -	32 0	7 6	10	1877
177	CEMAES - - - - -	32 0	7 6	10	1881
178	BULL BAY - - - - -	32 0	7 7	10	1868
179	MOELFRE - - - - -	32 0	7 5	10	1874
180	PENMON - - - - -	34 0	8 0	10	1880
181	CARNARVONSHIRE ORME'S HEAD - - - - -	33 0	8 7	10	1867
182	DENBIGHSHIRE - LLANDDULAS - - - - -	33 0	8 6	10	1868
183	FLINTSHIRE - - RHYL (TUBULAR) - - - - -	32 0	8 4	12	1856
184	„ No. 2 - - - - -	33 0	8 6	10	1878
185	CHESHIRE - - - NEW BRIGHTON, No. 1 (TUBULAR)	45 0	10 2	14	1876
186	„ No. 2 (Ditto) - - - - -	40 0	8 10	12	1878
187	LANCASHIRE - - SOUTHPORT - - - - -	34 0	8 6	10	1874
188	LYTHAM - - - - -	33 0	8 0	10	1878
189	ST. ANNE'S - - - - -	34 0	8 3	10	1881
190	BLACKPOOL - - - - -	33 0	8 0	10	1864
191	FLEETWOOD - - - - -	34 0	8 6	10	1879
192	PIEL - - - - -	36 0	8 1	12	1878
193	CUMBERLAND - - SEASCALE - - - - -	32 0	7 9	10	1875
194	WHITEHAVEN - - - - -	33 0	8 0	10	1866
195	MARYPORT - - - - -	32 0	7 4	10	1865
196	SILLOTH - - - - -	32 0	7 6	10	1867
197	ISLE OF MAN - - RAMSEY - - - - -	33 0	8 6	10	1868
198	DOUGLAS No. 1 - - - - -	32 0	7 6	10	1868
199	„ No. 2 - - - - -	35 0	9 0	10	1874
200	CASTLETOWN - - - - -	32 0	7 6	10	1865
SCOTLAND.					
201	KIRKCUDBRIGHT - KIRKCUDBRIGHT - - - - -	32 0	7 6	10	1879
202	WIGTOWNSHIRE - WHITHORN - - - - -	33 0	8 6	10	1869
203	PORT LOGAN - - - - -	30 0	7 1	10	1866
204	PORT PATRICK - - - - -	37 0	8 6	12	1877
205	AYRSHIRE - - - BALLANTRAE - - - - -	33 0	8 1	10	1871
206	GIRVAN - - - - -	32 0	7 5	10	1832
207	AYR - - - - -	32 0	7 5	10	1867
208	TROON - - - - -	32 0	7 6	10	1871
209	IRVINE - - - - -	33 0	7 6	10	1874
210	ARDROSSAN - - - - -	34 0	8 3	10	1880
211	ISLE OF ARRAN - KILDONAN - - - - -	32 0	7 6	10	1881
212	ARGYLLSHIRE - - CAMPBELTOWN - - - - -	32 0	7 6	10	1876
213	SOUTHEND - - - - -	32 0	7 6	10	1869
214	ORKNEYS - - - STROMNESS - - - - -	33 0	8 0	10	1867
215	LONGHOPE - - - - -	37 0	9 2	12	1874
216	CAITHNESS-SHIRE - THURSO - - - - -	33 0	8 0	10	1871
217	HUNA - - - - -	34 0	8 3	10	1877
218	ACKERGILL - - - - -	30 0	8 0	8	1878
219	NAIRNSHIRE - - MORAY FIRTH - - - - -	34 0	8 3	10	1878
220	ELGINSHIRE - - LOSSIEMOUTH - - - - -	32 0	7 6	10	1866
221	BANFFSHIRE - - BUCKIE - - - - -	33 0	8 1	10	1871
222	BANFF - - - - -	32 0	7 6	10	1870
223	ABERDEENSHIRE - FRASERBURGH - - - - -	34 0	8 3	10	1880

No.	NAME OF BOAT AND DONOR.	NAME AND ADDRESS OF HONORARY SECRETARY.
75	<i>Thomas Fielden</i> —Samuel, John, and Joshua Fielden, Esqrs.	William P. Elliott, Esq., Holyhead.
76	<i>Good Shepherd</i> —Loyal Order of Ancient Shepherds.	Mr. W. Williams, Fronddu, near Cemaes, Amlwch, R.S.O., Anglesey.
77	<i>Ashtonian</i> —The late George Heginbottom, Esq.	Rev. T. Lloyd Kyffin, Llanbadrig Vicarage, Amlwch, R.S.O., Anglesey.
78	<i>Eleanor</i> —A Lady in Wales	T. F. Evans, Esq., Amlwch, R.S.O., Anglesey.
79	<i>Lady Vivian</i> —Her collection	Rev. J. W. Evans, Llanalgo, Pentraeth, Anglesey.
30	<i>Christopher Brown</i> —Settle fund	William Preston, Esq., Vaynol, Bangor, N. Wales.
31	<i>Sisters' Memorial</i> —Two Sisters	G. F. Felton, Esq., Mostyn Estate Office, Llandudno.
32	<i>Henry Nixson, No. 2</i> —The late Henry Nixson, Esq., per Manchester Branch.	J. Lynch Fletcher, Esq., Bryndulas, Llanddulas, Abergele, R.S.O., Denbighshire.
33	<i>Morgan</i> —Miss Ellen Hodgson	Mr. Robert Hughes, Rhyl, North Wales.
34	<i>Jane Dalton</i> —"D."	
35	<i>Willie and Arthur</i> —Joseph Leather, Esq.	Charles H. Beloe, Esq., 13 Harrington Street, Liverpool.
36	<i>Stuart Hay</i> —Messrs. John Hay & Co.	John L. C. Hamilton, Esq., New Brighton, Birkenhead.
37	<i>Eliza Fernley</i> —Mr. Fernley's Legacy	J. A. Robinson, Esq., Southport.
38	<i>Charles Biggs</i> —Miss Biggs's Legacy	John Edmondson, Esq., Lytham, Preston.
39	<i>Laura Janet</i> —Jas. Chadwick, Esq.	W. A. Lloyd, Esq., St. Anne's-on-the-Sea, Preston.
40	<i>Robert William</i> —Mrs. and Miss Hopkins	A. M. Viener, Esq., Blackpool. [Fleetwood.
41	<i>Child of Hale</i> —Colonel W. B.	John Pickering, Esq., Preston Banking Company,
42	<i>William Birkett</i> —Mr. Birkett's Legacy	Capt. E. P. Stokes, Barrow-in-Furness, Lancashire.
43	<i>William Tomlinson</i> —Misses Tomlinson	Mr. J. Molyneux, Seascale, Cumberland.
44	<i>Elizabeth</i> —Miss Leicester	W. J. Tyson, Esq., 22 Lowther Street, Whitehaven.
45	<i>Henry Nixson, No. 1</i> —The late H. Nixson, Esq., per Manchester Branch.	W. H. Eckersley, Esq., Maryport.
46	<i>Mary Louisa</i> —Miss Browne's Legacy	John Stronach, Esq., Silloth, R.S.O., Cumberland.
47	<i>Two Sisters</i> —J. Ryder, Esq., per Manchester Branch.	E. C. Kerr, Esq., Bank, Ramsey, Isle of Man.
48	<i>Manchester and Salford Sunday Schools</i> —per Manchester Branch	Thos. Bawden, Esq., North Quay, Douglas, Isle of Man.
49	<i>John Turner-Turner</i> —Mrs. Turner-Turner and Family	
0	<i>Commercial Traveller</i>	G. H. Quayle, Esq., Castletown, Isle of Man.
1	<i>Mackie</i> —Dr. Mackie's Bequest	James McMuldrow, Esq., Kirkcudbright.
2	<i>Charlie Peek</i> —A Lady.	Alex. Macfie, Esq., Clydesdale Bank, Whithorn, R.S.O., Wigtownshire.
3	<i>Edinburgh and R. M. Ballantyne</i> —Edinburgh Workpeople, and Edinburgh Ladies' Endowment Fund.	Quintin Cochrane, Esq., Port Logan, R.S.O., Wigtownshire. [Wigtownshire.
4	<i>Civil Service, No. 3</i> —Civil Service Fund	David A. McClew, Esq., Dinvin, Port Patrick, R.S.O.,
5	<i>William and Harriot</i> —Mrs. Richardson's Legacy.	Mr. James Cowper, Kintyre View, Ballantrae, Girvan.
6	<i>Sir Home Popham</i> —Mrs. Popham's Legacy.	Wm. Forsyth, Esq., Girvan.
7	<i>Glasgow Workman</i> —Glasgow Workpeople	John Pollock, Esq., Town Clerk's Office, Ayr.
8	<i>Mary Sinclair</i> —Mrs. Sinclair	Alexander Wyllie, Esq., Troon.
9	<i>Isabella Frew</i> —William Somerville, Esq.	James Dickie, Esq., Council Chambers, Irvine.
9	<i>Fair Maid of Perth</i> —Peter Reid, Esq.	John Craig, Esq., Ardrrossan. R. L. Alpine, Esq., Ardrrossan.
1	<i>Emily Dewar</i> —Mrs. Dewar's Legacy	Patrick Murray, Esq., Brodick, R.S.O., Isle of Arran.
2	<i>Princess Louise</i> —Life-boat Fund	Mr. Alexander Mithell, H.M. Customs, Campbeltown.
3	<i>John R. Ker</i> —Robert Ker, Esq.	
4	<i>Saltaire</i> —The late Sir Titus Salt, Bart.	Capt. G. Bilton, Stromness, S.O., Orkney.
5	<i>Dickinson Edleston</i> —The late D. Edleston, Esq.	Edward E. Corrigan, Esq., Longhope, Kirkwall.
3	<i>Charley Lloyd</i> —Mr. Lloyd's Legacy	J. Coghill, Esq., Thurso.
7	<i>W. M. C.</i> —"X. Y. Z."	Mr. David Dunnett, Quoys, Canisbay-by-Wick.
3	<i>George and Isabella</i> —Miss Bower	G. M. Sutherland, Esq., Bridge Street, Wick.
9	<i>Caulfield and Ann</i> —Mr. Lloyd Williams' Legacy.	H. T. Donaldson, Esq., Nairn.
9	<i>Bristol & Clifton</i> —Bristol Histrionic Club	Mr. John Ferguson, Harbour Master, Lossiemouth, [Elgin.
1	<i>James Sturm</i> —Mr. Sturm's Legacy	John Shearer, Esq., Bank, Buckie, Fochabers.
2	<i>John and Sarah</i> —J. E. Lightfoot, Esq.	James Watt, Esq., National Bank of Scotland, Banff.
3	<i>Coemo & Charles</i> —Capt. Gordon	Andrew Tarras, Esq., Towus House, Fraserburgh.

[Continued.]

STATEMENT OF THE SEVERAL LIFE-BOATS BELONGING TO OR IN CONNECTION

No.	STATION.	Length.		Breadth.		No. of Crews.	When Station or Name	
		Ft.	in.	Ft.	in.			
224	ABERDEENSHIRE - WHITELINK BAY - - - -	33	0	8	6	10	1878	
225		PETERHEAD - - - - -	33	0	8	1	10	1865
226	CRUDEN - - - - -	33	0	8	6	10	1877	
227		NEWBURGH - - - - -	30	0	8	0	8	1877
228	KINCARDINESHIRE STONEHAVEN - - - - -	33	0	8	6	10	1874	
229		GOURDON - - - - -	33	0	8	0	10	1878
230	FORFAR - - - - -	33	0	8	6	10	1869	
231		" No. 2 - - - - -	30	0	8	0	8	1874
232		ARBROATH - - - - -	32	0	7	6	10	1866
233	BUDDON NESS } DUNDEE {	33	0	8	6	10	1870	
234		BROUGHTY FERRY }	33	0	8	6	10	1876
235	FIFESHIRE - - - - -	33	0	8	0	10	1873	
236		ANSTRUTHER - - - - -	32	0	7	4	10	1865
237	HADDINGTONSHIRE NORTH BERWICK - - - - -	30	0	7	7	10	1871	
238	DUNBAR - - - - -	33	0	8	0	10	1865	
239	BERWICKSHIRE - EYEMOUTH - - - - -	30	0	8	0	8	1876	
IRELAND.								
240	Co. LONDONDERRY - GREENCASTLE - - - - -	33	0	8	0	10	1880	
241	ANTRIM - - - - -	32	0	7	6	10	1876	
242	DOWN - - - - -	32	0	7	6	10	1867	
243		BALLYWALTER - - - - -	32	0	7	6	10	1866
244	TYRELLA - - - - -	30	0	8	0	8	1875	
245		NEWCASTLE - - - - -	34	0	8	0	10	1881
246	LOUTH - - - - -	34	0	8	3	10	1880	
247		" No. 2.—BLACKROCK - - - - -	32	0	7	6	10	1867
248		DROGHEDA—No. 1 - - - - -	34	0	7	6	10	1879
249	" No. 2 - - - - -	32	0	7	6	10	1872	
250	DUBLIN - - - - -	32	0	7	6	10	1882	
251	SKERRIES - - - - -	33	0	8	6	10	1873	
252	HOWTH - - - - -	33	0	8	0	10	1872	
253	POOLBEG - - - - -	34	0	8	0	10	1881	
254	KINGSTOWN - - - - -	37	0	8	6	12	1879	
255	GREYSTONES - - - - -	33	0	8	0	10	1872	
256	WICKLOW - - - - -	33	0	8	0	10	1866	
257		ARKLOW - - - - -	37	0	9	0	12	1873
258	WEXFORD - - - - -	36	0	8	4	12	1876	
259		CAHORE - - - - -	34	0	8	0	10	1879
260	WEXFORD—No. 1 - - - - -	40	0	10	6	12	1871	
261		" No. 2 - - - - -	34	0	8	3	10	1878
262	CARNSORE - - - - -	32	0	7	4	10	1874	
263	DUNCANNON - - - - -	33	0	8	6	10	1869	
264	WATERFORD - TRAMORE - - - - -	34	0	8	0	10	1880	
265	DUNGARVAN - - - - -	32	0	7	7	10	1871	
266		ABDMORE - - - - -	34	0	8	0	10	1880
267	CORK - - - - -	32	0	7	6	10	1867	
268		BALLYCOTTON - - - - -	34	0	8	0	10	1880
269		QUEENSTOWN - - - - -	34	0	8	0	10	1866
270		COURTMACHERRY - - - - -	32	0	7	6	10	1867
271	KERRY - - - - -	32	0	7	4	10	1880	
272	TRALEE BAY - - - - -	34	0	8	3	10	1879	
273	DONEGAL - - - - -	37	0	8	0	12	1883	

NOTE.—The Life-boat builders of the Institution

NAME OF BOAT AND DONOR.	NAME AND ADDRESS OF HONORARY SECRETARY.
Robert Adamson—Miss Adamson People's Journal—No. 1—Subscribers to Dundee "People's Journal."	Mr. A. J. Birnie, Cairdenity, Inverallochy, by Lonmay, William Boyd, Esq., F.R.S.E., Peterhead. [Aberdeen.
Peep-o'-day—"A Scot Abroad" Alexander Charles, and William Aird—Miss Birtwhistle's Legacy.	Mr. James Boddie, Pathhead, Cruden, Ellon, N.B. Mr. P. Murray, Newburgh-by-Aberdeen.
Star—Mrs. Henry Hearn Young George Irlam—Mr. Irlam's Legacy .	David Carr, Esq., Stonehaven. Rev. John Brown, Bervie, Fordoun.
Mincing Lane—Merchants of Mincing Lane Roman Governor of Caer Hân People's Journal—No. 2—Subscribers to Dundee "People's Journal."	James Warrack, Esq., Montrose. William Cargill, Esq., Arbroath.
May—"D" English Mechanic—Life-boat Fund	James Hunter, jun., Esq., 69 Reform Street, Dundee.
Ladies' Own—Miss Smithers' Life-boat Fund Admiral FitzRoy—A Lady (H. H.)	Andrew Bennett, Esq., St. Andrew's. H. B. Mackintosh, Esq., Anstruther.
Freemason—Freemasons of England	D. McCulloch, Esq., British Linen Co., North Berwick.
Wallace—The late Lady Cuninghame-Fairlie James and Rachel Grindlay—Mr. T. Grind- lay's Legacy.	G. R. Scott, Esq., Bank, Dunbar. Andrew Whitlie, Esq., Bank, Eyemouth, Ayton.
Mary Beckwith—Mrs. Beckwith's Legacy .	Pierce Crosbie, Esq., Greencastle, Movice.
John Whitaker—Late Mr. Whitaker's Trust Fund, per the late E. Absolom, Esq.	Thomas Lloyd, Esq., Shippquay Street, Londonderry. Rev. J. Simpson,
Florence—A Friend Admiral Henry Meynell—Misses Meynell Ingram.	W. E. Carver, Esq., J.P., Portrush, R.S.O., Co., Antrim. Rev. F. J. Hearne, Groomsport, Belfast. Rev. J. O'Reilly Blackwood, Ballywalter, Newtownards.
Memorial—Misses Frances and Kate Peach Farnley—E. Armitage, Esq., R.A.	D. McCann, Esq., Dundrum, Co. Down. Mr. W. Hayward, Newcastle, S.O., Co. Down.
James Thomas—Miss Thomas's Legacy Stockport Sunday School—Life-boat Fund .	J. F. Farrell, Esq., Harbour Office, Dundalk.
Old George Irlam, of Liverpool—Miss Irlam's Legacy John Rutter Chorley—Mr. H. F. Chorley's Legacy	Mr. N. Halligan, Banktown, Drogheda. Tandy Cannon, Esq., Mornington House, Drogheda. Mr. J. McNamara, Harbour Office, Drogheda.
Maid of Annan—Mrs. Langworthy	H. A. Hamilton, Esq., } Balbriggan, R.S.O., Co. Dublin. W. J. Cumisky, Esq., }
Laura Platt—Mr. Thos. Platt	H. H. Foster, Esq., Skerries, S.O., Co. Dublin.
Clara Baker—A Friend, per Miss Baker	Edward Greer, Esq., Evora, Howth, R.S.O., Co. Dublin.
Auron Stark Symes—Mrs. Elizabeth S. Symes	Mr. S. Carr, C.O.C.G., Ring's End, near Dublin.
Hector—Late Miss Anderson and Niece	Capt. the Hon. F. G. Crofton, R.N., Harbour Master, Kingstown.
Sarah Tancred—Mr. Tancred's Legacy	P. Reid, Esq., Glencarrig, Delgany, Greystones.
Robert T. Garden—Late R. T. Garden, Esq.	S. E. Pim, Esq., Wicklow.
Out-Pensioner—Out-Pensioners	The Earl of Wicklow, Shelton Abbey, Co. Wicklow. Dr. Stopford Halpin, Arklow.
Alfred and Ernest—Manchester Branch	J. S. Scott, Esq., J.P., Levuka, Gorey, Co. Wexford.
John Brooke—The Misses Brooke, per J. J. Richardson, Esq., Q.C.	Capt. R. D'Olier George, Cahore, Gorey, Co. Wexford. Mr. J. S. Sinnott, Cahore, Gorey, Co. Wexford.
Ethel Eveleen—J. M. S.	Wm. Coghlan, Esq., Collector H.M. Customs, Wexford.
Civil Service—No. 1—Civil Service Fund	E. A. Gibbon, Esq., Rosslare House, Tagoat, Wexford.
Iris—Mrs. A. M. Burdon	Mr. J. McGonagil, Duncannon, Waterford.
Richard and Anne—The late Mrs. and Miss Warner.	Edward Jacob, Esq., Ardview, Tramore, Waterford.
Alfred Trower—Henry Trower, Esq., and Friends.	Mr. James W. Shaw, Dungarvan.
Christopher Ludlow—Dr. Ludlow's Trustees Hooper—Miss Hooper	Mr. Henry Cooper, Ardmore, Youghal.
Wm. Beckett of Leeds—A Leeds Gentleman Oliver Goldsmith—That Life-boat Fund	J. W. Pim, Esq., Youghal. T. W. Strangman, Esq., Shanagarry, Midleton.
Quiver—No. 3—"Quiver" Magazine	Capt. Nathaniel Sutton, Harbour Office, Queenstown. Capt. Townshend, Courtmacsherry, Bandon.
City of Dublin—Collected in Dublin	J. A. O'Driscoll, Esq., Valentia, Killarney.
Crosby Leonard—Late Crosby Leonard, Esq.	Robert McCowen, Esq., Lloyd's Agent, Tralee.
Admiral Butcher—R. G. Butcher, Esq. . . .	W. Magee, Esq., Aranmore, viâ Stranorlar R.S.O., Co. Donegal.
Vandeleur—Mr. Vandeleur's Legacy	

Messrs. Woolfe and Son, of Shadwell, London, E.

INDEX TO THE GIFT LIFE-BOATS OF THE ROYAL NATIONAL LIFE-BOAT INSTITUTION.

(The figures refer to the numbers of the Life-boats detailed on the ten preceding Pages.)

- A. B. S., 120.
 A Friend, 242.
 A Friend at Bradford, 53.
 A Friend, per G. H. Aston, 85.
 A Friend, per Miss Baker, 262.
 A Lady, 16.
 A Lady, 32.
 A Lady (H. H.), 236.
 A Lady, per Admiral Fishbourne, C.B., 82.
 A Lady, "in memory of a very dear brother," 147.
 A Lady, 164.
 A Lady in Wales, 178.
 A Lady, per the late N. Griffith, Esq., 292.
 "A Scot abroad," 226.
 A Townsman of Leeds, 267.
 Abbot, the late John, Esq., 41.
 Adamson, Miss, 224.
 Ancient Shepherds, Loyal Order of (A.U.), 176.
 Anderson, Miss, the late, and Niece, 254.
 Anstice, Mrs., the late, 5.
 Arkcoll, Chas., Esq., 93.
 Armitage, E., Esq., R.A., 245.
 Atton, Rob., Esq., the late, 145.
 Barlow, Miss, 24.
 Barnes, R., Esq., the late, 169.
 Beckett, Miss, the late, 18.
 Beckett, the late John, Esq., 39.
 Beckwith, the late Mrs., 240.
 Berkshire, collected in, 166.
 Biggs, Miss, the late, 188.
 Bird, Samuel, Esq., 51.
 Birkett, Wm., the late, 192.
 Birtwhistle, Miss, the late, 227.
 Bolton, collected in, 70.
 Boucher, Lady, 63.
 Bower, Miss, 218.
 Boys of England, 79.
 Boy's Own Life-boat Fund, Bradford, 83. [107, 122.
 Bristol, Collected in, 138.
 Bristol-Histrionic Club, 220.
 "British Workman" Magazine, collected from the readers thereof, 59.
 Broadwater, Robert, Esq., the late, and Friends, 146.
 Brooke, the Misses, 259.
 Browne, Miss, the late, 196.
 Brundret, Mrs., 115.
 Burdon, Mrs. A. M., 262.
 Burmester, Miss, 77.
 Burton-on-Trent, Coll. in, 29.
 Butcher, R. G., Esq., 272.
 Cabbell, B. B., Esq., the late, Carter, Misses, 21. [55.
 Chadwick, Jas., Esq., 189.
 Cheltenham, collected in, 149.
 Chorley, the late H. F., Esq., 249.
 Civil Service, 14, 204, 261.
 Coal Exchange, London, Members of, the, 72.
 Commercial Travellers, 206.
 Corker, C. J. Esq., the late, 158.
 Corn Exchange, Mark Lane, Members of, the, 64.
 Covent Garden Life-boat Fund, 62.
 Crossley & Sons, Messrs., J., 28.
 Cuninghame-Fairlie, Lady, the late, 235.
 Cuttill, J. Esq., the late, 4.
 D., 184, 233.
 Dartmouth, the Earl of, and his Tenantry, 160.
 Davis, Mrs. Geo., the late, 61.
 Denham, Hon. Mrs. Jos., 151.
 Derby, collected in, 19.
 Dewar, the late Mrs., 211.
 Dixon, Miss, 45.
 Draper, Daniel J., Life-boat Fund, 130. [late, 134.
 Drummond, Mrs. Dundas, the Dublin, collected in, 270.
 Dundee, People's Journal, 225, 232. [late, 118.
 Durant, Richard, Esq., the E. P. S., 167. [203.
 Edinburgh Working Men's, Edinburgh Ladies' Endowment Fund, 203. [late, 215.
 Edleston Dickinson, Esq., the "English Mechanic" Life-boat Fund, 234.
 Egerton, Capt. C. R., R.N., widow of, 159.
 Elliott, Mrs., 56.
 Ellis, Mrs., 34.
 Exeter, collected in, 116.
 Fernley, J., Esq., the late, 187.
 Fielden, Samuel, John, and Joshua, Esqs., 175.
 Foresters, Ancient Order of, 15, 26. [late, 35.
 Forteach, Mrs. Harriott, the Poulston, Mrs. Eliza, the late, 20. [36.
 Fox, Children of Mr. and Mrs., Fraser, Mrs., 54.
 Freemasons of England, 78, 119, 237. [37.
 Freemasons of Warwickshire, Friends at Manchester, 94.
 Frith, J. G., Esq., the late, and Mrs. Frith, 3.
 Garden, the late R. T., Esq., 140, 256. [Mrs., 12.
 Gibb, T. Jones, Esq., and Glasgow Workmen's, 207.
 Gloucester, collected in, 126.
 Good Templars, Independent Order of, 17.
 Gordon, Capt., 223.
 Gorfenke, the late Jacob, Esq., 125.
 Grindlay, Thomas, Esq., the late, 239.
 Grove, Miss J. E. Chafyn, 152.
 H. W., 111, 172.
 Haberfield, Lady, the late, 165.
 Hackwood, Thos., Esq., 9.
 Hallam, the Misses and Mrs. Margaret Birt, 99.
 Hargrave, Chas., Esq., the late, 86.
 Hargreaves, Mrs., 117.
 Harris, Mrs. H., the late, 92.
 Harris, H., Esq., the late, 92.
 Harrison, Miss, the late, 162.
 Hatton, Mrs. Jane, 89.
 Hay, John, & Co., 186.
 Heape, Benjamin, Esq., 109.
 Hearn, Mrs. Henry, 223.
 Heginbottom, Geo., Esq., the late, 177.
 Heyland Memorial Life-boat Fund, 58.
 Heywood-Lonsdale, A. P., Esq., 46.
 Hill, Arthur, Esq., 123.
 Hindley, Job, Mr., the late, 27.
 Hodson, Miss Ellen, 183.
 Holton, R. W., Esq., and Mrs. Holton, 38.
 Holt, Col., the late, and Mrs. Symes, 150.
 Hooper, Miss, 265. [142.
 Hope, Rev. F. W., the late Hopkins, Mrs. and Miss, 190.
 Hopkinson, Miss, the late, 10.
 Hounsfeld, Mrs., 76.
 Hubbard, Hon. Mrs., 121.
 Huddersfield, collected in, 57.
 Hughes, Mrs., the late 141.
 Hulcott, David, Esq., 90.
 Ingleby, Rev. Chas., the late, per G. P. Wragge, Esq., 23.
 Ingram, Herbert, Esq., M.P., Friends of the late, 49.
 Ingram, Misses Meynell, 213.
 Ipswich, collected in, 75.
 Iriam, Geo. Esq., the late, 229.
 Iriam, the late Miss, 248.
 J. C., 132.
 J. L., the late, 69.
 J. M. S., 260. [Fund, 95
 Jewish Scholars' Life-boat Joseph Armstrong Life-boat Fund, 128.
 Keble, Rev. T., 74. [135.
 Kendall, W., Esq., the late, Ker, Robert, Esq., 213.
 Ladies' Own Life-boat Fund, Landseer, Miss, 48. [235.
 Langworthy, Mrs., 250.
 Leaf, Sons & Co., Messrs., 101.
 Leather, Jos., Esq., 185.
 Leeds, Town of, presented in the name of, 267.
 Leicester, collected in, 66.
 Leicester, Miss, 144, 194.
 Leonard, C., Esq., the late, 271.
 Licensed Victuallers, collected from, 56.
 Lightfoot, J. E., Esq., 222.
 Lingham, Mrs., 173. [216.
 Lloyd, the late Chas., Esq., Lockett, Mrs. & the Misses, 106.
 London Sunday Schools, 96.
 Louise, the Princess, Life-boat Fund, 212.
 Ludlow, the late Dr., 265.
 Mackie, Dr., the late, 201.
 M. B., 65.
 Manchester Branch, 1, 11, 27, 30, 111, 115, 155, 163, 169, 172, 182, 195, 197, 198, 268.
 Manchester and Salford Sunday Schools, 198.
 Marten, G., Esq., and Miss Marten, 104.
 Mather, Mrs. Annie, 22.
 Meyrick, Stanton, the late, 154.
 Middlewood, Geo., Esq., 40.
 Mining Lane Merchants, 230.
 Moore, the late Geo., Esq., Life-boat Fund, 170.
 Morella, the Countess de, 174.
 Morris, the late Miss, 156.
 N. R., 47.
 Neale, Miss, the late, and Miss Herring, 137.
 Nicholls, Miss, the late, 52.
 Nixon, the late Henry, Esq., 182, 195.
 Nobic, Mrs., 171.
 Northumberland, The Dowager Duchess of, 8.
 Nottingham, collected in, 6.
 Odd Fellows (Manchester Unity), 44.
 Oliver Goldsmith, the, 268.
 Onslow, Miss, 133.
 Out-Pensioners, 267.
 Oxford University, 136. [68.
 Parkin, Thos., Esq., the late, Peach, Misses Frances and Kate, 244.
 Pickersgill, the late H. W., Esq., R. A., 57.
 Platt, Mr. Thomas, 251.
 Pimsoil Life-boat Funda, 67.
 Popburn, Mrs., the late, 206.
 "Quiver" Magazine, collected from the readers thereof, 73, 80, 269.
 Reid, Peter, Esq., 13, 210.
 Richardson, the late Mrs. Harriot, 205.
 Rilmington, Mrs., 112.
 Robarts, Lord, the late, 129.
 Robertson, Miss, the late, 97.
 Rochdale, collected in, 25.
 Rolfe, Lady, 113.
 Roman Governor of Caer Hin, the late, 231.
 Rosebery, Lady, 88.
 Rous, Admiral, Life-boat Fund, 43.
 Ryder, James, Esq., 197.
 St. Michael's, Paddington, Life-boat Fund, 71.
 Sait, Sir Titus, Bart., the late, 214.
 Sait, Titus, Esq., 167.
 Settle, collected in, 42, 180.
 Sinclair, Mrs., 208.
 Sister's Memorial, 181.
 Somes, Mrs., 148.
 Somerville, W. Esq., 209.
 Somerville, Miss, the late, 84.
 South Warwickshire Life-boat Fund, 124. [late, 91.
 Stanford, John, Esq., the Stockport Sunday School, 247.
 The late Mrs. M. A., 127.
 Strafford, the Earl of, P.C., 105, 110.
 Sturm, the late Jas. Esq., 221.
 Sykes, the late Mrs. A. E., 33.
 Symes, Mrs. Elizabeth S., 253.
 Tancred, the late J. J. Esq., 255.
 Teignmouth Bazaar, 114.
 Thomas, Miss, the late, 246.
 Tomlinson, the Misses, 193.
 Townsend, Mrs., 30.
 Trower, Henry, Esq., and friends, 264.
 Turner-Turner, Mrs. and Family, 189.
 Vandeleur, Richard, Esq., the late, 273.
 Vivian, Lady, coll. by, 179.
 Watson, Lady, the late, 2.
 W. R., Colonel, 191.
 Walker, the late Mrs. Mary Wardell, Miss, 7. [Ann, 143.
 Warner, the late Mrs. and Miss, 263.
 Wesleyan Methodists, 130.
 West, E. Thornton, Esq., the late, and Mrs. West, 100, 139.
 Whitaker, the late John, Esq., per the late E. A. Absolom, Esq., 247.
 Wide, S. J., Esq., for the late Miss M. R. Wilde, 108.
 Williams, Mr. Lloyd, the late, 219.
 Wolverhampton, coll. in, 153.
 Worcester Cadets Life-boat Fund, 103.
 Worcester, collected in, 102.
 Wright, Mrs., the late, 131.
 X. Y. Z., 217.
 Yates, Mrs., the late, 31.

THE EXPENSE OF A LIFE-BOAT STATION IS £1,000. ITS COST IS MADE UP AS FOLLOWS:—

Life-boat and her equipment, including Life-belts for the Crew	
and Transporting-carriage for the Life-boat	£650
Boat-house (average cost)	350

Total . . . £1,000

The average annual expense of maintaining a Life-boat Station is £70, and the benefactions and contributions of Donors of Life-boats are earnestly solicited in aid of that fund.

GOD HELP OUR MEN AT SEA

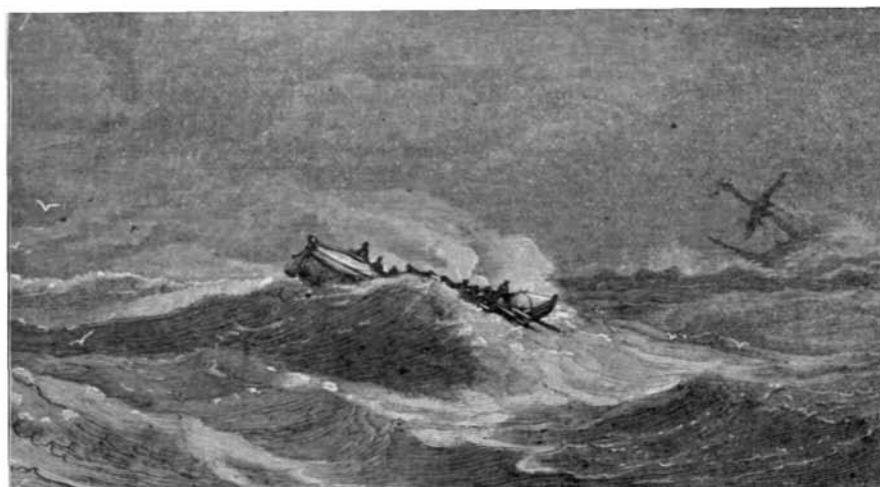

List of the Rewards

FOR SAVING LIFE FROM WRECKS

VOTED BY THE ROYAL NATIONAL LIFE-BOAT INSTITUTION

TO THE CREWS OF ITS LIFE-BOATS, TO SHORE AND FISHING-BOATS' CREWS, AND TO OTHER PERSONS,

FROM THE 1ST JANUARY TO THE 31ST DECEMBER, 1882.

Jan. 1.—The brigantine *Maggie Wood*, of Belfast, bound from that port to Ayr in ballast, stranded on the Barton Rocks, about a mile and a half south of Ayr Harbour, during a gale of wind from the W.N.W. and a heavy sea. As the gale was increasing, it was dangerous for any other than a Life-boat to proceed to the vessel, and the *Glasgow Workman* Life-boat, stationed at Ayr, therefore went off to her with a steam tug from the Harbour. Lines were passed by the Life-boat from the brigantine to the steamer, which was unable to get near her, on account of the shallowness of the water, and the vessel, which had lost her rudder, was towed to Troon, the master's wife being landed by the Life-boat.

Jan. 5.—At about 4 A.M. a rocket was fired from the Wold lightship. The crew of the *Husband* Life-boat, stationed at Winterton, Norfolk, immediately mustered, and the boat was launched. She

went to the lightship, which reported that a light had been seen on the Hasborough Sand. The Life-boat proceeded there, and found the brig *Louisa*, of Stettin, Prussia, bound from Hull to Plymouth with coal, sunk in the sand, her topsail being just out of the water. Fortunately she discovered one of the vessel's boats, having five of the crew and a woman on board; those six persons were taken into the Life-boat and brought safely ashore. The remaining three men of the crew, who had taken to another of the vessel's boats, were picked up by a smack and taken to Great Yarmouth.—Expense of service, 19*l.* 10*s.*

COMMITTEE MEETING, Jan. 5th, 1882.

Voted 84*l.* 14*s.* 1*d.* to pay the expenses of the Whitehaven, Holy Island, Cruden, Milford, Aldborough, and other Life-boats, in assembling their crews or putting

off in reply to signals of distress, with the view of rendering assistance to vessels, which did not ultimately require their services.

Voted also the Silver Medal of the Institution and a copy of the vote inscribed on vellum to Mr. SAMUEL CARR, Chief Officer of H.M. Coastguard at Ring's End, Co. Dublin, and Honorary Secretary of the Poolbeg Branch of the Institution, and to Mr. DANIEL EVANS, coxswain of the Poolbeg Life-boat, in recognition of their general services in the Life-boat, and particularly on the occasion of the wreck of the ship *George H. Oulton*, of St. John's, N.B., during the heavy gale of the 22nd October, 1881.

Also the thanks of the Institution, inscribed on vellum, to Captain JOHN STRANEY, master of the steam-tug *Toiler*, for towing out the Life-boat on the above-mentioned occasion.

Also the Silver Medal and a copy of the vote inscribed on vellum to Mr. JOHN STEELE, in acknowledgment of his brave and valuable services in helping to man the Ayr Life-boat on the occasion of the wreck of the brigantine *J. W. Harris*, of Dublin, during a severe gale on the 22nd November.

Also the thanks of the Institution, inscribed on vellum, to Captain J. BREW, of the *Isle of Man Mail s.s. Mona*, and 5*l.* to his crew, in acknowledgment of their services in towing out the Ramsey Life-boat with the view of assisting another distressed steamer during a gale on the 22nd November.

Jan. 14.—Signals of distress were observed at Cresswell, Northumberland, at 3 A.M., during a S.S.E. wind and a moderate sea, the weather at the time being hazy. The *Old Potter* Life-boat was at once launched, proceeded in the direction in which the signals had been seen, and, after having gone a distance of about three miles, she found the brig *Swift*, of Krageroe, Norway, ashore and labouring heavily. With the assistance of the Life-boat the vessel was got afloat, and on the following day she was towed to Sunderland, to which port she was bound from Krageroe with a cargo of mining timber. She carried a crew of eight men.

Jan. 31.—At 9.30 A.M., during a strong S.E. gale, the galliot *Gateforth*, of Whitehorn, bound from Ayr to Whithorn with coal, was at anchor in Port Logan bay,

and showed a signal for assistance. An open boat, with the coxswain of the Life-boat and three other men, went off to her and got her under way. She, however, missed stays, and went close to the rocks on the north of the harbour. Her anchor was then let go, and as she was in a very dangerous position the Life-boat *Edinburgh and R. M. Ballantyne*, stationed at Port Logan, was launched, under the charge of her second coxswain, proceeded to the vessel, and remained by her until she was taken to a place of safety.

COMMITTEE MEETING, Feb. 2nd, 1882.

Voted 9*2l.* 7*s.* to pay the expenses of the Ballantrae, Harwich, Clacton, Palling No. 2, Castletown, Montrose No. 1, North Berwick, Saltburn, and Rye Life-boats, in putting off to the aid of vessels which did not ultimately need their assistance.

The Ramsgate Life-boat had also been taken out, but her services had not been called into requisition.

Voted also the Silver Medal of the Institution and a copy of the vote, inscribed on vellum, to Major HENRY SCOTT, Chairman of the Dover Branch, in recognition of his gallant and prompt services in volunteering to take an oar in the Dover Life-boat, and afterwards assisting to rescue five of the crew of the barque *Chin Chin*, of Jersey, which was wrecked off the South Foreland, during a S.W. wind and a heavy sea, on the 9th December, 1881.

Also the Second Service Clasp to Mr. ROBERT WILDS, coxswain of the Deal Life-boat, in recognition of his continued brave services in the boat. The Silver Medal was awarded to him in 1877, and since then he had assisted in the Life-boat to save a large number of lives from various shipwrecks.

Also 5*l.* in aid of a local subscription for the relief of the families of three members of the Saltburn Life-boat crew who had been drowned while out fishing on the 12th January.

Feb. 16—18.—At about 3.45 P.M. it was reported at Fleetwood, Lancashire, that a vessel was ashore on Shell Wharf. The wind was then blowing a fresh gale from the W. and a very heavy cross sea was running. The Fleetwood Life-boat *Child of Hale* proceeded in tow of the steam tug

Relief to the vessel, and found she was the barque *Venus*, of Helsingborg, Sweden, bound to Fleetwood with a cargo of sawn fir-deals. The master's wife, a little boy, a female servant, and nine of the crew were taken into the Life-boat, but the captain and mate refused to leave the vessel. The Life-boat remained alongside for a considerable time and then returned ashore.—Expense of service, 13*l.* 5*s.*

On the following morning the Life-boat, in tow of the tug *Relief*, returned to the vessel, taking back the crew to try again to get her into the harbour, but all attempts to do so failed, and the Life-boat came back to the shore, leaving the crew on board and landing the captain, who was much exhausted.

On the succeeding morning the Life-boat and tug once more went out, and their perseverance was rewarded by the vessel being eventually brought to a safe anchorage.

Feb. 27.—At about 8 A.M. a small vessel was seen riding at anchor in comparatively shallow water, with a signal of distress flying, about five miles E. of Dunbar, N.B. The Life-boat *Wallace*, stationed at Dunbar, put off to her assistance, and found that she was the lighter *Sophia*, of Hull, bound from Newcastle to Dunbar with coal. She was being brought up by a tug on the previous day, when the steamer's shaft broke and the vessel had to be cast adrift. She proceeded under her own sail, but the wind changing during the night and becoming stronger, and the sea being heavy, she was in great danger of being lost. Her crew of three men were taken into the Life-boat and safely landed at Skateraw Harbour.—Expense of service, 10*l.* 1*s.*

March 2.—The *David Hulett* Life-boat, stationed at Lydd, Kent, put off at 4.30 A.M. to the assistance of the brigantine *Concordia*, of Guernsey, which had stranded on the sands about half a mile from the boathouse, and was showing signals of distress. Owing to a flood tide, a strong gale of wind from the W.S.W., and a very heavy sea, the boat fell to leeward of the vessel, whereupon a steam tug which was lying in the bay went to her aid and towed her as near to the wreck as she could with safety. The Life-boat's anchor was then dropped, and she veered down to the vessel, and, after one or two attempts, succeeded in getting a line from her. Pre-

viously to this, four of the shipwrecked crew had got into their boat, which was stove in and full of water when the Life-boat reached her, three of the men being engaged in baling her and the other man using the only oar they had in the boat. These men were first rescued, and after a period of long and anxious labour the Life-boat also succeeded in taking off the master and one of the crew who were still on board. Their rescue was effected just in time, for in ten minutes afterwards the vessel sank.—Expense of service, 22*l.* 10*s.*

COMMITTEE MEETING, March 2nd, 1882.

Voted 85*l.* 16*s.* to pay the expenses of the Ardmore, Queenstown, Dunbar, Maryport, Mevagissey, Padstow, Newhaven, Theddlethorpe, and Aldborough Life-boats, in assembling their crews or putting off in reply to signals of distress exhibited by vessels which did not ultimately require the services of the Life-boats.

March 6.—The s.s. *Kittiwake*, of Carlisle, while leaving Whithorn Harbour, at about 11.15 P.M., during a fresh S. breeze, got her steering gear foul, and stranded on the Screens Rocks. The coxswain of the Isle of Whithorn Life-boat, with the sub-coxswain and two other men, went off to her in the harbour boat and brought ashore two lady-passengers. The sea was not very heavy then, but as it was rising it was thought advisable to take out the Life-boat and remain by the vessel. The Life-boat *Charlie Peck* was accordingly launched at midnight; she soon reached the steamer, and, after remaining some time by her, she eventually brought ashore all those left on board, consisting of seven men.—Expense of service, 13*l.*

March 7.—At 1.30 P.M., a barque was seen to go ashore on the Scroby Sand. A strong S.W. wind was blowing at the time, and there was a heavy sea on the sand. The Caister No. 2 Life-boat *Godsend* proceeded to her, and found she was the *Canmore*, of Dundee, bound from Dunkirk to the Tyne in ballast. The master at once engaged the services of the crew to get the vessel off. The wind and sea ultimately increased very much, and as night came on the Life-boatmen were afraid that if the barque broke up they would be unable to save

the crew with the small boat, and they, therefore, signalled for the large Life-boat the *Covent Garden*, which was at once launched, and went to the vessel. Fortunately, however, with the aid of the Life-boats and a steam tug, the vessel was got off the sands, and proceeded to Yarmouth Roads, the large Life-boat accompanying her. The barque had a crew of fifteen men, a woman and a child being also on board.

March 7.—The smack *Alert*, of Lowestoft, with thirty packages of fish on board, was seen at 8 p.m. with a flare burning on deck, on the Newcome Sands. The wind was blowing strongly from the S.W. and the sea was rough. The Pakefield No. 1 Life-boat, *Two Sisters Mary and Hannah* proceeded to her, and found that her crew were about to leave her, having already put their clothes in their boat. It was, however, decided to try to save the vessel, and a rope having been passed from her to the Life-boat, she was ultimately got off the sands and taken safely into harbour. She had a crew of six men.

March 8.—At about 9.50 a.m. a distressed vessel was seen in Bideford Bay, driving towards the North Tail Sand. A strong W.S.W. wind was blowing, accompanied by a heavy ground sea. In reply to her signals of distress the Appledore No. 2 Life-boat *Mary Ann* was launched, and brought ashore the master, pilot, and crew of two men. She proved to be the smack *Mary Stevens*, of Padstow, bound from Barnstaple to Newport in ballast.—Expense of service, 8*l.* 10*s.*

March 8.—A steamer was observed ashore on the Hasborough Sand at 3 p.m. during a fresh S.W. wind. The Winterton No. 2 Life-boat, the *Husband*, went to her assistance, and found that she was the s.s. *Napier*, of Shields, coal laden. The Life-boat remained by her until 7 p.m., when she fortunately floated off the sand with the flood tide.

March 21.—At about 9 a.m., during a gale from the N.W., the flat *Three Brothers*, of Chester, which was riding at anchor in Cemlyn Bay, Anglesey, exhibited a signal of distress. The *Good Shepherd* Life-boat stationed at Cemlyn at once proceeded to her assistance, and brought the crew of two men safely ashore. During the night the vessel broke from her moorings, and be-

came a total wreck.—Expense of service, 7*l.* 7*s.*

March 21.—During a severe gale of wind from the W., veering to N.E., between 7 and 8 o'clock in the evening, the schooners *Volant*, of Wick, and *Queen*, of Inverness, which were both lying far out in the roadstead at Scrabster, N.B., commenced to drag their anchors and showed flare lights. The *Charley Lloyd* Life-boat stationed at Thurso, put off, and brought ashore four men from each of those vessels. As other craft were lying in the roadstead, the Life-boat was kept afloat during the night, but the gale moderated and they all held to their anchors.—Expense of service, 12*l.* 6*s.*

March 22.—As the s.s. *Robert Watson Boyd*, of North Shields, coal laden for Constantinople, was leaving the Tyne at about 7 a.m. her steering gear broke down, she became unmanageable, and drifted on to the Black Middens, where she stranded. As the tide rose, efforts were made by steam tugs to get her off; but all attempts proved unavailing, and, on account of the increasing sea, the tugs were compelled to leave her. At about 2 p.m. signals of distress were shown from the steamer, whereupon the Tynemouth No. 2 Life-boat, the *Forester*, proceeded to her and brought ashore fourteen men and some nautical instruments. There were about sixty persons on board the vessel, consisting of the crew and several men who had boarded her to assist in getting her afloat, the remainder of whom were safely landed by other Life-boats from Shields.—Expense of service, 6*l.* 10*s.*

March 22.—At about 7.30 a.m., a signal of distress was shown from a vessel at anchor in Fishguard Bay, South Wales, where she had been riding with others during the night. The wind was blowing a strong gale from the N.N.E., at the time, accompanied by a high sea. The gun was fired to assemble the Life-boat crew, and immediately afterwards the signal of distress was hauled down. Thinking the vessel did not then require assistance, the Life-boatmen were dispersing, but this being observed on board the vessel, which was lying just off the boat-house, the distress signal was again hoisted. The Fishguard No. 2 Life-boat *Helen of Foxley* then went off at once, and in ten minutes was alongside the vessel, which proved to be the

Thomas and Sons, of Aberystwith, bound from Carnarvon to Llanelly with slates. The captain and crew of two men wished to be brought ashore, fearing that she would part from her chains and drift on the sands. They were accordingly taken on board the Life-boat and landed at Goodwick Quay.

Just then another vessel was seen to run up a signal for assistance, and the Life-boat without delay proceeded to her. She was the smack *Martha Jane*, of Aberystwith, bound from Bangor to Swansea with slates. The captain and crew of two men also wished to leave their vessel, and were therefore taken into the Life-boat.

On the way back to the shore the schooner *Glanmanai*, of Beaumaris, bound from Portmadoc to Cardiff with slates, also hoisted a signal of distress. The Life-boat went alongside and took off her crew of three men. Both crews were then landed at Goodwick Quay.

As soon as these men had been landed, a fourth vessel—the three-masted schooner *Perseverance*, of Belfast, bound from Larne to Newport with iron ore—hoisted a signal for assistance, and the Life-boat went out a third time and brought the crew, consisting of six men, safely ashore.

As the sea was then too heavy to get the Life-boat up the slipway, and as it was possible that her services might be again required, it was decided to keep her afloat during the ebb tide, and she was anchored off the boat-house with a crew on board. In the evening the gale moderated, and she was taken into Goodwick Quay.—Expense of services, 15*l.* 10*s.*

March 24.—Signals of distress were observed at 7.45 P.M. at Kessingland, Suffolk, from the schooner *J. W. T.*, of Truro, bound from Runcorn to Newcastle with a cargo of rock salt. The Kessingland No. 2, *St. Michael's Paddington*, Life-boat at once proceeded to her assistance, and found that she had stranded on the inner part of the Barnard Sand. She floated again but was in a leaky condition, and the Life-boat therefore remained by her and assisted to take her to North Yarmouth.

March 26.—The ketch *Blue Bell*, of Padstow, lying at anchor off Clovelly, North Devon, showed a signal of distress. A fresh gale from the N. was blowing at the time, and there was a heavy sea.

The Clovelly Life-boat was immediately launched, and on reaching the vessel found that she had lost some of her sails and was riding heavily at her anchors. The crew of three men were anxious to be rescued from their perilous situation, and they were therefore brought ashore in the Life-boat.—Expense of service, 7*l.* 6*s.*

March 26.—At about 1 P.M., the schooner *British Queen*, of Wexford, bound from that port to Porthcawl in ballast, was observed to be in distress off Port Isaac, Cornwall. The wind was blowing a strong gale from the N.N.W., and there was a heavy sea running. The crew of four men were seen to leave the ship about a mile off the shore in their own boat. The *Richard and Sarah* Life-boat was at once launched, and after about an hour's pull rescued the crew when they were within a hundred yards of the cliff, where escape would have been impossible.—Expense of service, 26*l.* 18*s.*

March 26.—At about 2 o'clock in the afternoon, a signal of distress was shown, in Ramsey Bay, Isle of Man, by the schooner *Countess of Caithness*, of Gloucester, bound from Limerick to Port William, N.B., with a cargo of bones. A fresh gale from N. by W. was blowing then, and the sea was rough. The Ramsey Life-boat, *Two Sisters*, at once went to her, and the master asked for help to get his vessel out of her perilous position, as she was then close to the rocks near Manghold Head. Four of the Life-boatmen went on board, and as it was impossible to make Ramsey Harbour she was taken to Douglas, which was reached about 5 P.M. The crew, consisting of three men, were quite exhausted, and the master had had no rest for eight days.

March 29.—At about 7 A.M. a boat containing the captain and three of the crew of the steamer *Liban*, of Nantes, landed at Porthcawl, South Wales, and reported that their vessel had stranded on the Tuskar rocks, during a very thick fog, at 11.30 on the previous night. They also stated that there were eight men still on board in great danger, as she was likely to become a total wreck. The Porthcawl Life-boat *Chafyn Grove* immediately proceeded to the stranded steamer, and brought the eight men safely ashore.—Expense of service, 8*l.* 12*s.* 6*d.*

March 29.—At about 5.15 p.m., during a fresh W. gale and a heavy sea, the coxswain of the Howth, Dublin Bay, Life-boat, being on watch at the Coast-guard Station, observed a small vessel drag her anchors and go ashore on Ireland's Eye Island. She then hoisted a signal of distress, the sea making clean breaches over her. The *Clara Baker* Life-boat was at once launched, and proceeded to her assistance. The Life-boatmen laid out an anchor and tried to heave her off, but failed to do so, and two of the crew were then taken into the Life-boat and brought ashore. She was the lugger *Emerald Isle*, of Howth, laden with gravel.—Expense of service, 7*l.* 15*s.*

April 2.—At 5 a.m. a brig was observed on shore on Baldoyle Bank. The Howth Life-boat was launched, and, with great difficulty, owing to the strong gale which was then blowing from the E. and the heavy sea, reached the vessel, which was then on her beam ends, her crew having taken refuge in the main-topmast rigging, where the sea was washing over them. As the Life-boat was prevented from going alongside by the wreckage which was lying near, and by the heavy sea, she dropped anchor, veered down on the wreck, and ultimately effected a communication by means of the heaving line. A life-buoy was then hauled out, and the crew, consisting of five men, were taken into the Life-boat and brought safely ashore. The wrecked vessel proved to be the *Elizabeth*, of Whitehaven, bound from Liverpool to Dundalk with a cargo of coals.—Expense of service, 8*l.* 3*s.* 6*d.*

April 2.—At half-past seven o'clock in the morning, a galliot was observed to go ashore on the outer ledge of Seaton Sea Rocks off Blyth, Northumberland, during a strong E. wind and a rough sea. As she was in a perilous position, the Blyth Life-boat *Salford* was immediately launched and proceeded to the vessel, which proved to be the *Ebenezer*, of Stavanger, Norway, bound from Hernösand to Blyth in ballast. The Life-boat's anchor was let go, and she veered alongside as near as she could get and then threw a line on board, by means of which five of the crew were hauled into the Life-boat with a life-buoy through the surf, and were brought safely ashore. One of the crew had previously succeeded in reaching the land with the help of a

life-buoy. The vessel's masts fell overboard, and she soon became a total wreck.—Expense of service, 6*l.*

April 3.—At 10 a.m., during a strong wind from the E. and a heavy sea, a vessel was seen stranded at Waxham, Norfolk, and showing signals of distress. The Palling No. 1 Life-boat was promptly launched and went to her aid, and found that she was the brig *Danmark*, of Dragör, bound from Rönne to Rotterdam, with china clay. Her crew of ten men were taken into the Life-boat and safely landed at Palling at about 1 p.m. The brig became a total wreck.—Expense of service, 17*l.* 10*s.*

April 3.—At 11 a.m., the *Bradford* Life-boat, stationed at Ramsgate, proceeded to the East Goodwin Light vessel, which was firing signal guns. The wind was blowing a strong breeze from the E., and there was a thick fog. On arriving at the Lightship, it was found that the master, and crew of five men, of the barque *Europe*, of Bordeaux, had taken refuge there, their vessel having stranded on the North Sand Head. These men were taken into the Life-boat, which then proceeded in search of the barque, and found her in charge of a lugger's crew. The services of the Life-boatmen were engaged to assist in getting the vessel off, but all efforts to do so failed, and she had to be abandoned. She was bound from Gothenburg to Bordeaux with a cargo of boards.

April 4.—One of the beach punts belonging to Southwold was engaged in shipping pilots during a strong breeze, and at 1.30 a.m., the wind having freshened to a gale, and a heavy sea breaking on the shoals, signals of distress were shown by the boat. The Southwold Life-boat *London Coal Exchange* was thereupon launched, and brought the three men who were in the punt safely ashore.—Expense of service, 10*l.* 10*s.*

COMMITTEE MEETING, April 6th, 1882.

Voted 22*l.* 17*s.* 11*d.* to pay the expenses of the Life-boats at Fishguard, Harwich, Berwick-on-Tweed, Winterton, Braunton, Lytham, Cardigan, Hastings, Southwold, Margate, Kingsgate, Seaton Carew, Tynemouth, Port Isaac, and Ilfracombe, in assembling their crews or going out to the aid of vessels in distress.

Voted the Silver Medal of the Institution, and a copy of the vote, to Mr. RICHARD HEADON, Coxswain of the Clovelly Life-boat, who had been out in the Life-boat on all occasions when she had been afloat on service, and had assisted to save thirty-four lives, during the past twelve years.

Also 10*l.* in aid of the family of EDWARD GULLEY, late Coxswain of the Courtown Life-boat, who had died suddenly, leaving a widow and a family of young children. He had been connected with the Life-boat as first and second coxswain for fifteen years, and during that period he had assisted in the boat to save many lives.

Also 10*l.* in aid of the widows and families of two men—members of the crew of the Hope Cove Life-boat—who had been drowned by the capsizing of their fishing-boat on the 17th February.

April 13.—A flag of distress was seen flying from the fishing smack *Belle*, of Blyth, in the Coquet Roads, Northumberland, at 3.30 P.M., during stormy weather, the wind blowing very strong from the E.S.E., and a high sea running at the time. The Life-boat *Algernon and Eleanor*, stationed at Hauxley, went to her assistance, and brought ashore her crew of six men. The vessel was bound from North Shields for the fishing grounds, in ballast.—Expense of service, 9*l.* 15*s.*

April 15.—At 7.30 A.M. the s.s. *Consent*, of Sunderland, coal laden from South Shields to Genoa, stranded on the Cross Sand off the coast of Norfolk. A yawl was launched, and on arriving at the steamer the master engaged her services to assist to get the vessel off. A larger yawl afterwards went to the steamer at about 9 o'clock, when the wind began to freshen and the sea was becoming heavy. The first yawl then returned ashore, in tow of a steam-tug, for the Caister Life-boat *Covent Garden*, which was launched and towed to the vessel, reaching her at about noon. The wind and sea still increasing, at 4.45 the sea broke over the ship, when most of the crew and several of the beachmen left her and got into the Life-boat, expecting every minute that the steamer would become a total wreck. Eventually, however, with the aid of two steam-tugs, and anchors and hawsers, which had been laid out by the beachmen, the vessel was got off the Sand and

taken to Yarmouth Harbour, the Life-boat accompanying her.

April 15.—At about 8.30 A.M. a brigantine was seen approaching Arbroath, N.B. As she was showing a signal of distress the *People's Journal* No. 2 Life-boat was launched and proceeded to her aid. She proved to be the *Expedit*, of Porsgrund, Norway, laden with small coal. The Master reported that she had four feet of water in her hold, had lost her main rigging, and was quite unmanageable. The crew, who had been constantly at the pumps four days without food, were quite exhausted, and refused further duty. The men, numbering six in all, were taken into the Life-boat and safely landed. The vessel afterwards drove ashore about a mile and a half westward of the harbour.—Expense of service, 7*l.* 8*s.*

April 25.—At 6 P.M. it was reported at Harwich that a schooner was ashore on the Cork Sand. The Life-boat *Springwell* was immediately launched, and arrived at the Sand at about 8 P.M. The stranded vessel proved to be the *Henrietta*, of London, bound from that port to Newcastle with a cargo of gunpowder and burnt ore. As she was not leaking, her crew did not wish to leave her, and the Life-boat therefore remained near her during the night. Ultimately the schooner showed signal lights, as she was rapidly filling with water, and the Life-boat therefore went alongside her as soon as there was sufficient water on the Sand to permit her to do so, took off the crew, consisting of four men, and landed them at Harwich at about 6.30 on the following morning.—Expense of service, 15*l.* 2*s.* 6*d.*

April 29.—A terrible gale was experienced this day at St. Ives, Cornwall. The wind, which was from N.W., blew from about 11 A.M. until 3 o'clock in the afternoon with tremendous fury, lashing the sea into foam, and causing the spray to form a fog so dense that nothing could be distinguished beyond a quarter of a mile from the shore. A large proportion of the St. Ives fleet of over one hundred mackerel boats was out, and had been absent for some days. One steamer broke from her moorings and went ashore at Gwythian, under the Black Cliff; another and a schooner—the *Ellen Vere*—rode out the storm, but they appeared to be in such imminent danger that the Life-boat *Exeter*, stationed at St. Ives, was taken down to

the water's edge, so as to be in readiness should her services be called into requisition. Some of the absent fishing luggers returned home, but two others arrived late, at nearly low water, and had to anchor outside the ridge, on which the sea was breaking with such fury that none of the gigs could venture outside. The Life-boat therefore proceeded to the aid of the luggers, the *Quick* and the *Gyles*—taking off fresh crews to them, and bringing ashore the fourteen men who were on board the boats. The men were in a very exhausted and benumbed condition when the Life-boat reached them.

April 29.—During the same severe gale the s.s. *Drumhendry*, of Glasgow, bound from Ballydonegan Bay, Co. Cork, to Hayle, with dynamite and other explosives, in attempting to come into Hayle at about 2 P.M., was driven on the beach east of the bar. As soon as it was seen that the lives of her crew were in danger, the Life-boat *Isis* proceeded through a very heavy sea to her assistance, and brought ashore two of the men, the remainder being helped to land by means of a rope.—Expense of service, 11*l.* 10*s.*

April 29.—At 3 P.M., just before high water, the yacht *Formosa*, of Carmarthen, started with four men on board to try to save some drowning cattle, which had strayed on to the Cefn Sidan Sand in Carmarthen Bay, and had been carried away by the rising tide. A light N.N.W. wind was blowing at the time, and the sea was smooth. At 3.30, when the boat was off the mouth of Lougharne River, a storm suddenly rose from the N.W. All sail was lowered, and she came to anchor, but in a few minutes the cable parted and she drifted towards the opposite shore, which she struck soon afterwards. Meanwhile, she had been watched from the Ferryside Life-boat Station, and the Life-boat *City of Manchester* put off to her, and found that she had been stove in and was full of water, a heavy sea breaking over her. Two of the men on board her were taken into the Life-boat, and the other two men came ashore when the tide had receded.—Expense of service, 8*l.* 13*s.*

April 29.—During a very strong gale of wind from the S.S.W., accompanied by a heavy sea, at about 4 P.M. a sloop made for Clacton-on-Sea, and sought shelter under the pier, but the water being shallow she grounded, and showed a signal

of distress. The Life-boat *Albert Edward* was manned, and promptly went to the aid of the vessel, being veered down by means of a rope from the pier. The sea broke heavily over the boat, constantly filling her; but at length, after a hard struggle, she reached the wreck and saved the crew of five men. The Life-boat was several times in danger of being upset, and much bravery and skill were shown by the coxswain and crew. Two of the Life-boat men were washed overboard while reshipping the boat's rudder, which had been damaged, but they were happily rescued. The service was witnessed by a large number of persons, and on the Life-boat reaching the pier with the shipwrecked men, she was received with much cheering. The stranded sloop proved to be the *Nordstiernen*, of Haugesund, bound from that port to London, with herrings.—Expense of service, 13*l.* 13*s.*

April 29.—At 8 P.M. three oyster skiffs—the *Gertrude*, *Gladstone*, and *Shah*—were observed from the shore to be in distress off the Mumbles Head, near Swansea. The force of the gale had carried away their spars and canvas; the anchors were let go, but would not hold, and the boats were being rapidly driven in the direction of the Scarweather Sands, which are situated in the Bristol Channel, about seven and a half miles S.S.E. from the Mumbles Head. The Swansea Life-boat *Wolverhampton* proceeded to the assistance of the boats; put a number of men on each, and with the aid of jury-masts and rigging, one of them was brought into harbour. In the other two cases additional anchors were taken out and the boats were securely moored. Each of the skiffs carried a crew of three men, who would no doubt have perished had the boats been allowed to drift on to the sands.

May 2.—The smack *Boconnoc*, of Padstow, in attempting to proceed to sea, from Bude, Cornwall, the wind being very light and there being a considerable ground sea, drifted to the north side of the entrance to the harbour. The master, seeing his danger, let go the anchor to prevent the vessel drifting on the rocks, but it would not hold. As the sea was continually breaking around the smack, no ordinary boat could have reached her, and the Bude Life-boat *Elizabeth Moore Garden* therefore proceeded to her assist-

ance, and succeeded in getting her safely back into the harbour. She carried a crew of three men.

COMMITTEE MEETING, May 4th, 1882.

Voted 64*l.* 8*s.* to pay the expenses of the Broadstairs, Chapel, Montrose No. 1, Tynemouth No. 1, Thorpe, Swanage, and Padstow Life-boats in assembling their crews or putting off to the aid of vessels which did not eventually need their assistance.

The Ramsgate and Winterton No. 2 Life-boats had also been taken out, in readiness to render service to ships which were seen to be in distress.

May 15.—The Newbiggin Life-boat *William Hopkinson of Brighouse*, towed safely ashore a fishing coble which had been upset by a sudden squall. Her crew had happily been rescued by another fishing boat.

COMMITTEE MEETING, June 1st, 1882.

Voted 46*l.* 16*s.* to pay the expenses of the Rye, Winchelsea, Weymouth, Palling No. 2, New Quay (Cornwall), Ardmore, and Kingsdowne Life-boats, in assembling their crews, or putting off to the aid of vessels which did not ultimately require their assistance.

June 1.—The brigantine *Otto*, of Hoganas, Sweden, from Gefle to Poole with a cargo of timber, was taken in tow by a steam-tug about 9 A.M., and while crossing Poole Bar, the wind blowing from the E., accompanied by a heavy sea, the tow-rope parted, and before another rope could be got out, she drove to leeward, and struck on the Milkmaid Bank Shoal in Studland Bay, and lost her rudder. Two tugs endeavoured to get her off, but were unsuccessful, and she continued to drive further on the shoal, the sea at times breaking over her. The crew remained on board her, without danger, until about 10 P.M., when the wind, veering to the E.S.E., and blowing a heavy gale, it was thought that the vessel would go to pieces, in which case her crew would be lost. The *Boys' Own* No. 2 Life-boat stationed at Poole, accordingly went out to her assistance, and reached her about midnight, when it was found that the sea was breaking over the ship, and that the crew were crying for assistance. With great difficulty

the master and crew of eight men were taken into the Life-boat and brought safely ashore. In jumping from the wreck one man fell between the ship and the boat, but he was happily rescued by the Life-boat men.—Expense of service, 13*l.* 10*s.*

June 1.—At 10 P.M. a vessel was seen to get on the Middle Cross Sand and make signals of distress. The Caister No. 1 Life-boat *Covent Garden* was at once launched and proceeded to the Sand. On arriving there the boat's anchor was let go, and she veered down towards the vessel, but there was not sufficient water to enable the boat to reach her; she then shifted to other positions, but with the same result, the high seas breaking heavily over the boat, which struck the ground at each trial. She then anchored as close as possible until the flood tide made, when she wore down to the vessel and took off the crew of six men, hauling them through the water with a line. The master declined to leave the vessel. The Life-boat then got clear of the breaking sea but remained near at hand. At about 4 A.M. the Winterton No. 2 Life-boat *Husband* arrived at the scene of the wreck, having been summoned by signals from the Cockle Lightship. On account of the heavy sea then running, she dared not haul close to the brig, but made springs fast to her cable and sheered abreast of the vessel's jibboom. The heaving-line was then thrown to the master, who made it fast to his waist, dropped into the sea, and was hauled on board the Life-boat. The vessel proved to be the *Aglæe*, of St. Servan, with a cargo of timber.—Expense of services, 44*l.* 10*s.*

June 2.—The yacht *Spider*, of Ramsgate, brought up at 11.30 P.M. on the 2nd June, about a mile off Camber, Sussex. The wind was blowing strongly from the E.N.E., and the vessel was lying too near the shore, so that on the tide ebbing, she struck the ground, parted her chain, and drove ashore, where she almost dried at low water. On the tide flowing, the *Mary Stanford* Life-boat went to her assistance, some of the Life-boatmen went on board the yacht to assist at the pumps, as she was leaking badly, and the vessel and nine persons on board were taken into the harbour.

June 14.—At 1 A.M., during a moderate W.S.W. wind and overcast weather,

signal guns and rockets were observed from the Gull Lightship, and a flare was also seen in the direction of the Goodwin Sands. The Ramsgate Harbour Life-boat *Bradford* and the *Vulcan* steam-tug were got ready and went out with all despatch. They proceeded round the South Sand Head, and found a brigantine on the sand. The Life-boat sailed alongside the vessel, and the master at once engaged the services of the Life-boatmen to get her off. They then clewed up and stowed her sails, and took out an anchor and chain over the sands for about thirty fathoms. On the tide flowing, the chain was hove taut, sail was made, and the vessel floated off. She proved to be the *Swift*, of Rye, bound from Caen to Seaham, in ballast, with a crew of five hands.

COMMITTEE MEETING, July 6th, 1882.

Voted 17*l.* 5*s.* to pay the expenses of the Lydd (Dungeness) Life-boat in putting off with the view of rendering assistance to a stranded vessel, at midnight on the 30th May. After remaining out some hours her services were not after all required, and she then put into West Bay for shelter, the wind and sea having very much increased.

Aug. 2.—The barque *Erminia* was driven past Workington in a W.N.W. gale. The master was ashore, and was unable to get back to the vessel. She ultimately struck upon the banks and carried away her rudder, whereupon the mate made signals for assistance. The master then went off to her in a steam-tug, but could not get on board his vessel. He then returned to the shore, and asked that the Maryport Life-boat might be allowed to put him and eight men on board the barque, which request was acceded to, as no other boat could have lived in the heavy sea then running.

COMMITTEE MEETING, Aug. 3rd, 1882.

Voted the Silver Medal of the Institution to Mr. RICHARD ROBERTS, assistant-coxswain of the North Deal Life-boat, in acknowledgment of his general gallant services in the Life-boat, in assisting to save a large number of lives during the past seventeen years.

Aug. 9.—A rocket from the Lizard signal station was heard about 8 A.M., a screw

steamer having gone on shore there. For some time the fog hid her, but when she was seen clearly, and found to be full of people, the Life-boat *Anna Maria* proceeded to her assistance and took off twenty-seven persons. The remainder of those on board were saved by other boats and a steam-tug. The vessel was the North German Lloyd's mail s.s. *Mosel*, of Bremen, bound from that port to New York, with seven hundred passengers, a crew of one hundred persons, and a cargo of railway iron, specie, and general cargo. She ultimately became a total wreck.—Expense of service, 9*l.* 18*s.* 6*d.*

Aug. 15.—At 7.30 P.M. a signal of distress was seen flying from a vessel about three miles S.E. of the Ballinacourty Lighthouse, and signals were also shown by the coastguard at Helwick, to attract attention to her. The Life-boat *Christopher Ludlow*, stationed at Dungarvan, was promptly manned, and proceeded to the vessel, which proved to be the brigantine *Ariel*, of Youghal, bound from Cardiff to Youghal with coal. She was dragging her anchors, and had lost part of her sails. The Life-boat brought ashore the master and crew of six men, leaving the vessel in a sinking condition.—Expense of service, 15*l.* 10*s.*

Aug. 21.—The schooner *Ocean Child*, of Belfast, which had anchored in Skerries Roads, off Portrush, Co. Antrim, through stress of weather, was overtaken by a gale from the W.N.W., accompanied by a heavy sea, and as she was dragging her anchor she hoisted signals of distress. The *John Whitaker* Life-boat went to her assistance, and took off her crew, consisting of three men. The Life-boat also proceeded to the ketch *Happy Return*, of Padstow, bound from Teignmouth to Ballyshannon with clay. This vessel was also dragging her anchors, and showing a signal of distress. The master, his wife—who was in a very weak, in fact almost dying, condition—and the crew of two men were also taken into the Life-boat and brought safely ashore.—Expense of service, 7*l.* 19*s.* 6*d.*

Aug. 21.—At 5.30 A.M. it was reported at Blackpool, Lancashire, that a vessel was drifting shorewards before a stiff gale from the W. The coxswain of the *Robert William* Life-boat lost no time in assembling his crew and taking the boat two miles along the shore opposite to

where the vessel struck. The Life-boat was then launched and proceeded to her aid. On the way she passed a capsized boat, and it was feared that some of the crew had endeavoured to reach the shore in her and had been lost; but such, happily, proved not to have been the case, as it was afterwards found that the boat had capsized as soon as she had been lowered into the water. The shipwrecked men were very eager to be taken off the vessel, and they were soon brought safely ashore in the Life-boat. The vessel proved to be the barque *Arethusa*, of Liverpool, bound from Liverpool to Quebec, with a cargo of coal. She carried a crew of ten men.—Expense of service, 11l. 11s.

Aug. 23.—Early in the morning the dandy *Hope*, of St. Ives, bound from Run-corn to Penryn with coal, having dragged her anchor and parted her chain, struck on the Dutchman Sandbank, opposite to Penmon, Anglesey, and hoisted a signal of distress. The Penmon Life-boat *Christopher Brown* at once went to her assistance, and after remaining by her for some time, put five men on board, and, with great difficulty, owing to the state of the tide and the quantity of water in her hold, brought her safely into Friars Roads, the men having to work at the pumps all the way. She carried a crew of three men.

Aug. 29.—At about 9 A.M. a telegram was received at Newhaven from Brighton stating that a vessel with her foremast gone and flying a signal of distress had passed that town and was drifting towards Newhaven. The *Michael Henry* Life-boat stationed at Newhaven proceeded to her, in tow of a steam-tug, and found she was the schooner *Catherine and Alice*, of Nevin, from Dieppe with flint stones. She had a crew of five men, and the master's wife was also on board. The tug took her in tow to Eastbourne; the Life-boat, at the master's request, accompanying her, as she was in a very leaky condition.—Expense of service, 29l. 4s.

Sept. 1.—About 11 o'clock in the morning the Peterhead Life-boat *People's Journal*, No. 1 proceeded a short distance from the mouth of the North Harbour, and remained there to render assistance if necessary to several fishing-boats which had proceeded to sea on the previous day and were running for the harbour, having been overtaken by a strong N.E. wind and a heavy sea. At

about half-past twelve the fishing-boat *Bon Accord*, of Portknockie, with six men on board, was making for the North Harbour, and was about forty yards from its mouth, when a sea struck her on the starboard quarter and drove her on the rocks at the back of Port Henry Pier. The Life-boat immediately proceeded to her assistance, and took a hawser ashore to endeavour to pull her off. Shortly afterwards a signal was made by some of the crew, and the Life-boat again went to her and took three of them ashore. When the tide rose the fishing-boat floated, and was hauled round the pier into the harbour.—Expense of service, 7l. 4s.

Sept. 1.—A ship's life-boat full of people came ashore at Wicklow, Ireland, at 9 A.M., and the officer in charge reported that she was from the s.s. *Lake Nepigon*, of Montreal, which had stranded on Arklow Bank, and that five other boats full of people had left the ship and were at sea. The Wicklow Life-boat *Robert T. Garden* was launched, and went in search of the boats; the wind was then blowing a gale from the S.S.W., the weather was very thick, and there was a heavy sea running. After about an hour the Life-boat fell in with the five boats, took on board the crews—consisting of thirty-two persons—of two of them, and took a third boat—with twenty people in her—in tow. A vessel was then sighted to windward, and the Life-boat signalled her; whereupon she bore down upon them, took the people out of the remaining two boats, and made for Kingstown. The Life-boat steered for Greystones, where the fifty-two persons were safely landed. The steamer was on a voyage from Liverpool to Montreal, with pig-iron and a general cargo, and had one hundred and fifty-four persons on board.—Expense of service, 16l. 6s. 10d.

COMMITTEE MEETING, Sept. 7th, 1882.

Voted 110l. 5s. to pay the expenses of the Walmer, Lizard, Ballywalter, Caister No. 1, Swansea, Fleetwood, New Brighton No. 2, and Arklow Life-boats in putting off in reply to signals of distress shown by vessels which did not ultimately require the aid of the Life-boats.

Also the Silver Medal of the Institution to Mr. RICHARD STOKES, in acknowledg-

ment of his long and gallant services while serving as coxswain of the Poole Life-boat, during which period he had assisted in saving a large number of lives from shipwrecks.

Also the thanks of the Institution, inscribed on vellum, to Captain W. E. CARVER, 4th Battalion Royal Inniskilling Fusiliers, and to Captain FREDERICK WATT, in acknowledgment of their valuable services in each taking an oar in the Portrush Life-boat, and assisting to save seven persons from the schooner *Ocean Child*, of Belfast, and ketch *Happy Return*, of Padstow, during a gale of wind from the W.N.W. on the 21st August.

Sept. 13.—At 4 A.M. flares were seen in the direction of the Middle Cross Sand. The Caister Life-boat *Covent Garden* was launched, and proceeded over the sands through the breakers, in the direction in which the lights had been last seen; but no vessel could be found. After searching in various directions, during which time a quantity of wreckage and some fishermen's bowls were found, a steamer, about a mile distant, was seen to ease steam and proceed to the westward. It was presumed that she had seen some men in the water and was going to their rescue. The Life-boat thereupon made sail and steered for the steamer. On arriving it was found that she had a large boat out picking up some men off a long spar, with a quantity of bowls attached. By the time the Life-boat got quite close they had picked all of the men up but one, and he was speedily saved.

The rescued men—two of whom were in a very exhausted condition—were taken on board the steamer, which then took the Life-boat in tow as far as Yarmouth Harbour, when the men were transferred to the boat and safely landed. Eight of the shipwrecked crew were rescued, but unfortunately ten others were drowned before help could reach them. The wrecked vessel proved to be the dandy *Reine des Anges*, of Boulogne, bound from the North Sea to Boulogne with fish.—Expense of service, 27l. 5s. 3d.

Sept. 20.—At about 8.30 A.M., during a strong wind from the E.N.E. and a heavy sea, the Danish schooner *William* was observed to be making for Whitby Harbour, when she became embayed, and was obliged to anchor in a very dangerous position. At about 11 A.M. she showed

signals of distress, in response to which the Life-boat, *Robert and Mary Ellis*, proceeded to her aid, and remained by her about two hours, when the master decided to send a telegram for the services of a steam-tug, which message the Life-boat brought ashore.—Expense of service, 9l.

Sept. 30.—A small sloop, which proved to be the *Fanny*, of Fishguard, was observed at 1 P.M. to be showing a signal of distress while at anchor, about a mile to the N.W. of Dinas Head. The wind was blowing a moderate gale from the S.S.W. at the time, with a moderate sea. The Fishguard No. 1 Life-boat, *Helen of Foxley* proceeded to her assistance, and found that she was quite disabled, having lost her mainsail and foresail. Eight of the Life-boatmen went on board the vessel, and, after some difficulty, they succeeded in beaching her. She carried a crew of two men, and had a cargo of culm.—Expense of service, 7l. 15s.

Oct. 1.—At 5.30 P.M. the schooner *Centenary*, of Liverpool, showed signals of distress as she was driving very near to the rocks in Skerries Roads off Portrush. The wind was then blowing a strong gale from the S.S.W. with heavy squalls. The *John Whitaker* Life-boat stationed at Portrush was launched with all despatch, and brought the master, his wife, and the crew of two men, safely ashore.—Expense of service, 14l. 17s. 6d.

Oct. 1.—At about one o'clock in the afternoon, the brigantine *Eugenie Auguste*, of Castletown, was labouring heavily and dragging her anchors in Derby Haven Bay, during a heavy gale of wind from the S.W. She was carefully watched from Castletown, in case she should require any assistance, and after a short time was seen to hoist a flag of distress. The Life-boat was at once taken on her transporting carriage to Derby Haven Bay, where she was launched, and proceeded to the vessel. It was found that the crew, consisting of five men, were desirous to be extricated from their perilous situation, and accordingly they were brought ashore in the Life-boat. Before leaving the vessel the master, on the recommendation of the coxswain of the Life-boat, ran out more chain, and secured it round the mast. Happily the vessel rode out the gale, and the crew having been placed on board again, she was brought safely into harbour.—Expense of service, 9l. 9s.

COMMITTEE MEETING, Oct. 5th, 1882.

Voted 52*l.* 2*s.* to pay the expenses of the Caister, Brighton, and Mullion Life-boats in putting off in reply to signals from vessels in distress, when their services were not ultimately needed.

Oct. 13.—At 9.30 p.m. signals of distress were seen on Goswick Sands, Northumberland. The *Grace Darling* Life-boat, stationed at Holy Island, was launched, and found the *Preston*, a large screw steamer, of West Hartlepool, ashore there. At the master's request the Life-boat remained by her for a considerable time, and also rendered assistance in laying out an anchor.

Oct. 15.—In the afternoon, during a S.S.E. wind and a heavy sea, a barque—which proved to be the *Fortuna*, of Arendal, Norway—came in sight off Buchanness, and as she was showing a flag of distress the Peterhead Life-boat *People's Journal* No. 1 was launched and proceeded to her assistance. There was some difficulty in getting alongside, as the vessel, which had lost her sails, was rolling very heavily; but eventually the whole of the crew, consisting of ten men, were taken on board the Life-boat and brought safely into Peterhead Harbour. During the night the barque's cables parted, and she drove ashore about five miles north of Peterhead and became a wreck.—Expense of service, 10*l.* 13*s.*

Oct. 19.—Intelligence was received at Ballywalter, Co. Down, at 1.30 a.m., that a vessel was ashore in the vicinity of Table Rock. A fierce gale was then blowing from the S.E., with much rain, and the sea was very heavy, with tremendous surf breaking on the rocks. The crew of the *Admiral Henry Meynell* Life-boat assembled, and the boat was taken along the beach on her carriage until she arrived opposite the vessel's lights, when she was launched, and was fortunately successful in rescuing the shipwrecked crew, consisting of nine men. The vessel was found to be the brig *St. George*, of and from Maryport, bound to Doboï, Turkey, in ballast.—Expense of service, 20*l.* 17*s.*

Oct. 24.—The schooner *Rambler*, of Folkestone, was seen to be running for the shore at Aldborough with a flag of distress in her rigging, during a heavy gale of wind from S.S.W., and a very rough sea. She struck on the shoal and began

to break up, which compelled the crew to take to the rigging. The Life-boat *George Hounsfeld* put off, and with great difficulty saved four men. One of the crew—a boy—had unfortunately been drowned before the Life-boat arrived. Shortly after the men had been rescued the vessel's masts went by the board.—Expense of service, 15*l.* 5*s.*

Oct. 24.—During a strong gale of wind from the S.W., and a heavy sea, at 11.30 a.m., the brig *August*, of Griefswold, Prussia, signalled for assistance, off Southend, Essex, having lost her masts and anchors. The *Boys of England* Life-boat put off to her aid, and assisted to bring her into a safe position. She was bound from London to Newcastle in ballast, and had a crew of seven men.

Oct. 24.—In the afternoon the fishing-smack *Sisters*, of Gorleston, was making for the harbour on the ebb tide, the wind at the time blowing a very heavy gale from the S.S.W., right out of the river. A rope was thrown from the vessel to some men on the pier, but it broke, and she drifted to the north side of the harbour, when nine of her crew climbed on the north pier, leaving one hand—a lad—on board. The boat was then blown out to sea, but was brought up by the anchor, which had fortunately been let go after the boy had paid out all the chain.

The Gorleston Life-boat *Leicester* took out a rope to the vessel, by means of which she was towed into safety, the boy being brought ashore in the Life-boat.

Oct. 24.—At 3.15 p.m., during a gale of wind from the W.S.W. and a heavy sea, signals of distress were shown by the *Gull Light* vessel. The *Ramsgate* Life-boat *Bradford* was manned, and went out in tow of the harbour steam-tug *Aid*. They spoke the *Gull Light* ship, and having ascertained that there was a vessel ashore on the S.E. part of the Goodwin Sands, they at once steered in that direction. On arriving at the sand the Life-boat was slipped from the tug, and having let go her anchor, she was veered down to the vessel, which was found to be the yacht *Arab*, of Poole. She had nine persons on board, all of whom were taken into the Life-boat, which then made for the steamer, and was towed back to Ramsgate Harbour, arriving at 7 p.m. The yacht became a total wreck.

Oct. 28.—At 1 a.m., during a gale

from the E.N.E. and a very heavy sea, it was reported that the barge *John*, of Faversham, was ashore opposite Birchington, and that men could be seen in the rigging. The *Quiver* Life-boat, stationed at Margate, was launched, proceeded to the vessel, and rescued her crew of two men, who were in a very weak condition, having been in the rigging since 1 o'clock on the previous day. Their vessel became a total wreck.—Expense of service, 16l. 9s. 6d.

Oct. 28.—In the evening, a flare was seen in the direction of the Brake Sand, off Ramsgate. A fresh gale of wind was then blowing from the N.N.E. with rain, and there was a heavy sea on the sand. The Life-boat *Bradford* was at once got ready, left the harbour under sail, and proceeded direct to the vessel, which proved to be the schooner *Beachill*, of Shoreham. The Life-boat saved the four men on board, three men, who had taken to their boat before the Life-boat arrived, having unfortunately been drowned.

Oct 28—29.—During a heavy gale from the N.E., several shipwrecks, with loss of life, took place off Lowestoft. At about 11 p.m. the *Samuel Plimsoll* Life-boat, after much regrettable delay and difficulty, was launched and proceeded to three vessels which were ashore at the back of the south pier, and succeeded in rescuing seventeen men, viz., eight men from the brig *Mornington*, of Colchester; eight from the brig *Susannah Dixon*, of Whitby; and one man from the brig *Iris*, of Whitby.—Expense of service, 24l.

At about 7 o'clock on the following morning flares were shown by a vessel in distress in Corton Roads. The wind was blowing from the N.E., and the sea was rough at the time. The Lowestoft Life-boat proceeded to her assistance, and found she was the ketch *Evening Star*, of Hull. With the aid of a tug, the vessel, which had been partly dismasted, was brought into Lowestoft Harbour. She had a crew of three men.

Nov. 1.—About 2 p.m. it was reported at Cardigan, that the smack *Ellen*, of Milford, which had during the day come up from the westward, and had brought up outside the bar, had hoisted a flag for assistance, and that she was riding very heavily, and, in fact, going right under the heavy seas. The crew of the Cardigan Life-boat *John Stuart* were sum-

moned, and proceeded to the Station, but by the time they reached the boat-house the wind had veered round to the W., and as the vessel then had a little shelter, the flag was hauled down. The Life-boat crew, however, remained and watched the ship, as the weather was still very threatening. Soon afterwards the wind changed, and blew a strong gale from the N.N.W., and the sea rose exceedingly high. The ship was then on a lee shore. She commenced to drag her anchors and drift towards the bar, and her crew then hoisted the flag again for assistance. As darkness was coming on, the Life-boat was launched, and, after a heavy pull of nearly an hour's duration, she reached the smack, took off her crew of three men, and brought them safely to land.—Expense of service, 10l. 8s.

COMMITTEE MEETING, Nov. 2nd, 1882.

Voted 367l. 3s. to pay the expenses of the Lowestoft, Upgang, Palling, Exmouth, Dover, Padstow, Caister, Kirkcudbright, Rhyl, Pakefield, Torquay, St. Ives, Littlehaven, Ilfracombe, Hayle, Deal, Margate, Harwich, Hayling Island, and Clacton Life-boats, in assembling their crews, or putting off in reply to signals of distress shown by vessels not eventually requiring the services of the Life-boats.

Also a binocular glass, bearing a suitable inscription, and 10l. 10s., to Mr. JOSHUA HEATH, who had been compelled by ill-health to resign the post of Coxswain of the Fowey Life-boat, which office he had held for more than twenty years.

Decided that the thanks of the Institution be conveyed to the Rev. J. O'REILLY BLACKWOOD, Honorary Secretary of the Ballywalter Branch, for his continued valuable co-operation, and especially for assisting to rescue the crew of nine men of the stranded brig *St George*, of Maryport, on the 19th October.

Nov. 4.—During a strong gale from the W.S.W. and a heavy sea, the s.s. *Matin*, of Sunderland, was driven ashore off Camber. The Rye Life-boat *Mary Stanford* went to her assistance, and, after great exertions, succeeded in getting alongside, and rescued fourteen men. After landing, it was found that some men still remained on board, and the Life-boat again went off to her, and

brought two men safely ashore.—Expense of service, 29*l.* 12*s.*

Nov. 5.—About 9 P.M. during a W.N.W. gale, it was reported at Torquay that signals of distress were being shown by a barque in the offing. The *Mary Brundret* Life-boat was launched, and on coming up to the vessel, about eleven miles from the shore, she was found to be the barque *Eden*, of Liverpool. She was in a leaky condition, part of the cargo and provisions had been thrown overboard, and her crew were in a most exhausted condition. The captain and crew expressed themselves much relieved by the presence of the Life-boat, and as the gale had somewhat abated, the master requested the Life-boatmen to assist to get the vessel into port. Some of the crew then went on board to help in working the ship, the pumps having to be kept going during the night and the following day. Eventually the ship, which carried a crew of seventeen men, was taken safely into Dartmouth Harbour, about 4 o'clock in the afternoon.

Nov. 5.—At about 9.40 P.M., signals of distress were shown by the s.s. *Rydal Hall*, of Liverpool, which had stranded on the Cliperæ Rocks during a gale of wind and a heavy sea. The Holyhead Life-boat *Thomas Fielden* put two pilots on board, who took charge of the vessel; the Life-boat then remained by her, and, with the assistance of four steam-tugs, she was got afloat.

Nov. 9.—At 6 A.M., it was reported that the fishing lugger *Steamboat*, of Arklow, which had proceeded to sea on the previous evening, had been overtaken by a heavy N.N.W. gale, which had sprung up at midnight; when she was about six miles E. of Arklow, and that she had lost her mast. She had been taken in tow by a larger boat, and brought in shore as far as the other boat was able to take her, and had then dropped anchor. The *Out Pensioner* Life-boat stationed at Arklow, proceeded to her assistance, placed six men in her, and took her crew of four men, who were much exhausted, into the Life-boat. A jury-mast was then fitted, and the boat was brought safely ashore. Expense of service, 5*l.*

Nov. 10.—In the evening a mounted messenger arrived at Cardigan, and reported that a vessel was riding at anchor outside the bar, and making signals for the Life-boat. The wind was blowing

a gale from the N.N.W. The crew of the Cardigan Life-boat *John Stuart* were mustered, and the boat at once proceeded to the vessel, which proved to be the brig *Wellington*, of Aberystwyth. She was labouring very heavily, and as there was no sign of the storm abating, it was feared that she would founder or part her cables, and drive on the bar, where there would be no chance of saving life. Her crew of ten men and a pilot were accordingly taken into the Life-boat, and brought safely ashore. Expense of service, 14*l.* 8*s.*

Nov. 12.—At midnight it was reported that a vessel had gone on the Long Rock. The Ballywalter Life-boat's crew were summoned, and the boat proceeded to the vessel and brought ashore her crew of three men. She proved to be the schooner *John and Ann*, of Runcorn, from Port Dinorwic to Belfast, with slates. The night was at times very dark, with most violent and thick hail and rain, a strong wind from the S.E. was blowing, and it was bitterly cold.—Expense of service, 13*l.* 11*s.*

Nov. 13.—The Ramsgate Life-boat and steam-tug proceeded out at 6.15 A.M. to the aid of the barque *Mina*, of Kalmar, Sweden, which had gone ashore on the Brake Sand during a fresh E.S.E. wind and a somewhat heavy sea. On arriving near the vessel the Life-boat was slipped, and proceeded alongside. Four of her crew went on board to try to save the vessel, but they were unable to do so as she was striking heavily on the sand, and was filling with water. The crew of ten men were then taken into the Life-boat and brought safely to Ramsgate.

Nov. 13.—The *Four Sisters* Life-boat stationed at Selsey, Sussex, was launched about 5 P.M. to the aid of the barque *Saraca*, of Glasgow, which had stranded on the Outer Owers during a moderate gale of wind from the E. and a very heavy sea. The vessel was ultimately got afloat, and the Life-boat accompanied her to Portsmouth.

Nov. 14.—At 9 A.M. the Lowestoft Life-boat proceeded, in tow of a steam-tug, to the assistance of the Norwegian barque *Burthon*, which had gone on the Holme Sand. On reaching the vessel she was found to be breaking up. The Life-boat boarded her, and, with much difficulty, succeeded in saving the crew, consisting of eight men, and brought them safely to Lowestoft, in a very exhausted state. The wind was blowing a

gale from the E.N.E., and there was a very heavy sea. Very soon after the men were rescued, the vessel became a total wreck.—Expense of service, 16*l*.

Nov. 14.—At 2.30 P.M., the Lowestoft Life-boat proceeded to the brig *Harkaway*, of Shoreham, which was riding to the southward of the harbour with a flag for assistance. The Life-boat helped to get a rope from her to a tug, and slipped her anchors, and she was then towed safely into Lowestoft Harbour. The boat then went to the brigantine *Wilhelmina*, of Exeter, and assisted in slipping her anchors, after which she also was towed into the harbour. The wind was blowing a strong gale from the E.N.E., accompanied by a very heavy sea.

Nov. 15.—The Lowestoft Life-boat went out before daybreak, during a strong E.N.E. wind and a heavy sea, to the schooner *Jane*, of Faversham, which was showing flares in the South Roads, and brought ashore the master's son and one of the crew.—Expense of service, 25*l*. 10*s*.

Nov. 16.—At about 5 o'clock this morning, during a fresh gale from the N.N.E., the look-out man at the Coast-guard Station observed that two out of fifteen vessels which were at anchor in Fishguard Bay were burning blue lights, as signals of distress. He immediately informed the coxswain of the Life-boat *Helen of Fowley*; the crew were summoned, and the boat was launched, proceeded to the schooner *Iona*, of Padstow, and as the master and crew—five in all—wished to leave the vessel, they were taken into the Life-boat. The Life-boat then went to the schooner *Mary*, of St. Ives, and took off her crew of five men; then to the schooner *Rose*, of Carnarvon, and rescued her crew of three men, and afterwards to the smack *Gander*, of Cardigan, and took off her crew of three men. These sixteen men were landed at Goodwick Quay. Signals were then shown from some of the other vessels, which were in exposed and dangerous positions, and the Life-boat went out four times and took off the crews, numbering in all thirty men, from the schooners *Elizabeth*, of Aberystwyth; *Victoria*, of Beaumaris; *Charles*, and *Jane Anwyl*, of Carnarvon, and smack *Mary Ann Jane*, of Carnarvon; schooners *Istwyth*, of Carnarvon, and *Korkinour*, of Beaumaris; and smacks *Commerce*, *Ocean*, *Rapid*, and *Margaret*, of Cardigan. Forty-

six men were thus brought ashore by the Life-boat, all being safely landed by 11 A.M.—Expense of services, 30*l*. 16*s*.

Nov. 18.—The brigantine *Jean Anderson*, of Dundalk, bound from Ardrossan to Dundalk with coal, was seen ashore on the east side of Dundalk Bar with a signal for assistance flying. The wind was blowing from the S., the weather was stormy, and the sea was running high. The Giles' Quay Life-boat *James Thomas* put off to her assistance, and remained by her for about four hours, when, at the request of the crew, they were taken into the Life-boat and landed at Dundalk Quay. They numbered six men.—Expense of service, 12*l*. 7*s*. 6*d*.

Nov. 18.—At 8 A.M., while a strong wind was blowing from the S., signals of distress were observed flying from a vessel which had grounded on the south side of Wexford Bar. The Wexford No. 1 Life-boat *Ethel Eveleen* immediately put off, in tow of the steam-tug *Ruby*, and, after proceeding for about two hours through a very heavy sea, the tug's hawser was slipped and the boat ran in under oars. On arriving alongside, the ship was found to be full of water, the sea sweeping right across her. She proved to be the *America*, of Quebec, bound from that port to Wexford. Her crew, consisting of eight hands, after much difficulty, succeeded in getting on board the Life-boat, and were safely landed at Wexford.—Expense of service, 16*l*. 10*s*.

Nov. 18.—The barque *Nimrod*, of Liverpool, was seen to be burning flares on the Holm Sand at 7.30 P.M., during a gale of wind from the S. and a high sea. The Pakefield No. 1 Life-boat *Two Sisters*, *Mary* and *Hannah*, was launched, proceeded to the vessel, and rescued her crew, consisting of seventeen men and a pilot. The barque, which was bound from Grimsby to Valparaiso with coal, became a total wreck.—Expense of service, 24*l*.

November 20.—At about 7 P.M., during a strong gale from the N.W., signals of distress were seen in the direction of Wexford Bar. The Wexford No. 1 Life-boat *Ethel Eveleen* was promptly manned, and proceeded to the spot, and found that the fishing yawl *Dazzler*, of Wexford, had stranded while returning to the harbour from the fishing-ground; the sea was beating heavily over her, and she was filling with water. Her crew, consisting of six men, were taken into the Life-boat,

which was then towed back to her station by the steam-tug *Ruby*.—Expense of service, 16s. 10s.

Nov. 25.—The smack *Conqueror*, of Newburgh, in attempting to enter that port at midnight on the 24th November, went ashore at the south side of the entrance. A small steam-tug went to her assistance, but could not reach her, owing to the heavy sea, until after she had stranded. She then succeeded in getting a rope from the smack, but had to throw it off to save herself from also being driven ashore. The crew of the Newburgh Life-boat *Alexander Charles and William Aird* were then summoned, the boat was launched, and succeeded in rescuing the vessel's crew, consisting of two men. The smack became a total wreck.—Expense of service, 12l.

Nov. 28.—During a strong N.W. wind and a very heavy sea, a brig was seen riding in broken water near the Goodwin Light vessel, with a flag flying at her main gaff. The Ramsgate Life-boat *Bradford* was manned, and left the harbour at 8 A.M. under sail, proceeded towards the vessel, and when about six cables distant saw her list to starboard and sink. The Life-boat made for the wreck, and ultimately succeeded in rescuing three of the crew from the maintop. Four men had unfortunately been drowned. The Life-boat was then towed back to Ramsgate. The wrecked vessel proved to be the brig *Percy*, of Riga, from Sunderland to Southampton with coal.

Nov. 28.—At about 7.35 P.M. signals from the North Sand Head and Gull Lightships were seen, and the Ramsgate Life-boat and steam-tug proceeded through the Cudd Channel to the North Sand Head. They saw a flare from a vessel on the sand, and on the Life-boat getting alongside she found it was the ketch *Harriet*, of Goole, bound from Hartlepool to Poole with coal. The Life-boatmen having been requested to assist to get the vessel off, some of them went on board, let go her anchor, and made sail. The boat then remained by her until the rising tide caused the sea to break over the vessel and boat, when it was thought prudent to take off those on board the former. The master, his wife and three children, and the crew of three men were therefore taken into the Life-boat and put on board the tug.

During this time the schooner *Venus*, of Exeter, bound from Shields to Teignmouth with coal, also ran on the sand. The crew took to their boat and boarded the steamer. With some of the Life-boat crew they afterwards returned to their vessel, and with the assistance of the steamer she was taken into Ramsgate Harbour.

The Life-boat again proceeded to the ketch, which fortunately floated with the rising tide, and some of the Life-boatmen then boarded her, made sail, and stood in towards the land. The steamer came out again, and, taking her in tow, got her safely into Ramsgate Harbour at 4.15 A.M.

Nov. 30.—A vessel, which proved to be the billiboy *Amity*, of Goole, missed stays and went ashore at Eccles, during squally weather and a heavy swell, at 2 o'clock in the morning. She burnt flares for assistance, in response to which the Palling No. 1 Life-boat, the *Heyland*, was promptly launched, and proceeded to her. With the assistance of the Life-boat the vessel was got out of her dangerous position, and proceeded on her voyage apparently without having received any material damage.

Dec. 1.—The *Godsend* Life-boat, stationed at Caister, Norfolk, was launched at 6.30 P.M., and rendered some assistance to the schooner *Brothers*, of Harwich, which had stranded on the Middle Barber Sand. The vessel ultimately floated, and was accompanied by a yawl to Yarmouth Harbour.

Dec. 3.—At 7 A.M. intelligence was received that a large vessel was ashore in Druridge Bay, Northumberland. The crew of the *Algernon and Eleanor* Life-boat, of Hauxley, were at once called together, horses were sent for, and the Life-boat with great difficulty, as the tide was at nearly high water and the sands were very soft, was taken by land to the scene of the wreck. She was then launched, and proceeded to the vessel, which was found to be the s.s. *Amulet*, of and from Rotterdam to Leith, with a general cargo. The boat remained for some time by the steamer, and landed the stewardess and a passenger. The captain and crew (nineteen men in all) remained on board for a time; but as the wind and sea increased, they were ultimately taken off by the Life-boat.—Expense of service, 17l.

Dec. 4.—On the morning of the 4th December, the Holy Island Life-boat, *Grace Darling*, brought safely to land

a fishing coble and her crew of four men, who had been caught in a gale from the E.S.E., and were in much peril.

Dec. 4.—A sudden gale from the E.N.E. sprang up this morning, just as the fishing-boats belonging to Newbiggin, Northumberland, had reached the fishing-ground. As the sea rose very high, only one boat attempted to shoot any lines; all the others ran for the bay. At about 8 o'clock the sea was breaking off Newbiggin Point, and seeing the danger to which the boats were exposed in making the bay, the Life-boat *William Hopkinson of Brighouse* was launched. All the boats were safely landed by 11.30, with the exception of the one which shot her lines; she did not reach the bay until 1.30 P.M., when all hopes of her safety had been given up. Amid great excitement she was safely run ashore, attended by the Life-boat, which had been out five and a half hours, her crew being drenched and exhausted by their long exertions.—Expense of service, 8*l.* 10*s.*

Dec. 4.—During a severe gale from the E.S.E. and a heavy sea, at 1.20 P.M., the barque *Rheinland*, of Hamburg, was being towed into Tyne Harbour by the steam-tug *Skylark*. On arriving within the piers the tow-line broke, and the barque stranded off the Battery Point, the seas breaking over her. The alarm guns were fired, and the Tynemouth No. 2 Life-boat, the *Forester*, was launched, with some difficulty. After being several times filled, she reached the wreck and took off two of the crew, the remainder being rescued by a Shields Life-boat.—Expense of service, 12*l.* 10*s.*

At about 11 P.M. the alarm guns were fired, on account of the danger to another vessel, which, however, disappeared before any assistance could reach her. The *Forester* Life-boat went to the supposed position of the wrecked vessel, and fell in with the schooner *Argo*, of Copenhagen, which was in great danger of being wrecked on the south pier. The Life-boatmen warned the captain of his perilous position, and piloted him safely into harbour.—Expense of service, 14*l.*

Dec. 5.—The brigantine *Hoppet*, of Hel-singborg, Sweden, was observed from Seaton Carew to be making for the land, during a terrific gale of wind from the E., with snow showers and a very heavy sea. The vessel ultimately stranded opposite

Seaton low lighthouse, whereupon the Life-boat *Job Hindley* was launched, proceeded to the wreck, and took her crew of seven men safely ashore.—Expense of service, 14*l.* 4*s.* 6*d.*

Dec 5.—The schooner *Anapira*, of Newburgh, was observed about seven miles E.N.E. of Hartlepool, while a most severe gale was raging, accompanied by sleet showers and a heavy sea. At 2.30 she was seen to put before the wind and run for the port. The Hartlepool No. 3 Life-boat, *John Clay Barlow*, was manned and held in readiness, as it was considered very doubtful, owing to the extreme violence of the gale, whether she would get safely in. She reached the Bay at about 3.40 P.M., and being struck by a heavy wave, broached to and struck the ground on the Beacon Shoal. The Life-boat immediately proceeded to her, and brought her crew, consisting of five men, to shore. After the crew had left the ship, she, contrary to expectation, drove into deeper water, and as there appeared a chance of saving her, the Hartlepool No. 2 Life-boat *Charles Ingleby*, proceeded to her and put four men on board; the No. 3 Life-boat also put four men on her. Sail was then made, and, with the assistance of two steamers, she was got into harbour.

Dec. 5.—Shortly after 4 o'clock in the afternoon a signal of distress was seen flying from a schooner at anchor in Fish-guard Bay. The No. 2 Life-boat, *Helen of Foxley*, was launched, and proceeded to the vessel, which proved to be the *Llaethliw*, of Newquay. She was riding heavily, and as the gale had been steadily increasing all day, with a heavy sea, and there was every prospect of a stormy night, the crew of four men wished to be brought ashore, and they were therefore taken into the Life-boat. There were also another schooner, the *John Stoward*, and the brigantine *Xanthus*, both belonging to Aberystwyth, at anchor in the bay, and they also signalled for the Life-boat. The boat therefore proceeded to them, took off the crews of four men from the schooner and six men from the brigantine, and landed them all at Goodwick Quay.—Expense of service, 8*l.* 5*s.*

Dec. 6.—At daylight the Norwegian barque *Carolina* was seen at anchor about two miles from the shore, at Sheringham, Norfolk, with spars hanging overboard. She showed signals, in response to which

the *Duncan* Life-boat, and the Beachmen's Life-boat *Augusta*, put off, and assisted her, and eventually accompanied her to Grimsby.

Dec. 6.—At 11.45 A.M., during a strong gale from the E.N.E. and a heavy sea, with snow, the brig *Star of Hope* of Newcastle, became embayed between Whitby and Uppang Rocks. She then ran for the beach, and stranded about two hundred and fifty yards north of the West Pier. The Whitby No. 1 Life-boat, *Robert and Mary Ellis*, was at once launched, gallantly pulled through the heavy sea, and in about twenty minutes from the time of the vessel stranding, her crew, consisting of six men, were safely landed.—Expense of service, 14*l*.

Dec. 6.—At about 2.30 P.M., the lugger *Ecuveuil*, of Gravelines, in ballast, which had lost her mainmast, was driven ashore on the North Sands, Hartlepool, during a storm from the E.N.E. and a very high sea. The Hartlepool No. 1 Life-boat *Charles Mather*, proceeded to her assistance, and brought ashore the crew, consisting of five men.—Expense of service, 10*l*. 5*s*.

Dec. 6.—The schooner *Laura Ann*, of Faversham, was in a dangerous position at the entrance to the Humber. The Grimsby Life-boat, *Manchester Unity*, proceeded to her assistance, and helped the crew to get up her anchors, after which she was towed into port by a steam-tug.

COMMITTEE MEETING, Dec. 7th, 1882.

Voted 44*l*. 16*s*. to pay the expenses of the Winchelsea, Irvine, Gorleston, Lowestoft, Drogheda, Harwich, Bridlington, Hornsea, St. David's, Porthoustock, Cemaes, Clacton, Cresswell, Cullercoats, Donna Nook, Fishguard, Holy Island, and Broadstairs Life-boats, in assembling their crews, or putting off in reply to signals of distress shown by vessels which did not ultimately require the assistance of the boats.

Also the thanks of the Institution to Captain GOLDWYER, Honorary Secretary of the Littlehaven (St. Bride's) Branch, for going out in the Life-boat stationed there and steering the boat, with the view of rendering assistance to two vessels which were apparently in dangerous positions, during a N.W. wind and a rough sea, on the 16th November.

Also the thanks of the Institution, in-

scribed on vellum, and a framed photograph of the Life-boat, to Captain R. W. MASSINGHAM, Harbour Master for the Great Eastern Railway Company at Lowestoft, in acknowledgment of his long and valuable co-operation on behalf of the Life-boat service in rendering the assistance of the harbour steam-tugs in towing the Life-boats, and frequently proceeding himself in the steamers, whereby he had contributed to the rescue of several shipwrecked crews.

Also 5*l*. to the crew of a small steamer named the *Imperial*, used for harbour work at Lowestoft, for going out in a heavy sea on the 14th November, under the instructions of Captain MASSINGHAM, the Harbour Master, and calling in one of the larger steamers belonging to the port. The Life-boat was then enabled to be towed to the wreck of the Norwegian barque *Burthon*, which had gone ashore on the Holme Sand, and saved the shipwrecked crew of eight men about a quarter of an hour before the vessel became a total wreck.

Dec. 7.—At about 3 o'clock this morning the coxswain of the Hartlepool No. 3 Life-boat the *John Clay Barlow*, noticed a sail some short distance from the shore, which he took to be a ship with her side lights washed away. While he was trying to make it out a flare was set up from the vessel, which enabled him to see that it was a ship with torn sails driving ashore. A violent gale was blowing from the E.N.E. at the time, and the sea was very high indeed. He at once got the crew of the Life-boat together, and the boat was launched. Before reaching her a rocket had been thrown over her from the Middleton shore, where she had struck. The Life-boat went alongside and took off the crew, consisting of seven men. The vessel sank, but, being timber laden, she afterwards got off the sands, and on the following morning at daylight, the sea having gone down very much, the Life-boat, at the request of the master, put the crew on board again. She was the *Edmund*, a Danish three-mast schooner, bound for London with a cargo of poles and battens.—Expense of service, 13*l*.

Dec. 7.—About 10 P.M. the coxswain of the Hartlepool No. 3 Life-boat observed a signal light from a vessel in the bay, apparently making for West

Hartlepool. The ship suddenly altered her course, and ran straight on to Middleton Sands. The crew of the Life-boat were assembled and the boat put off, and with much difficulty reached her. Some steam-tugs attempted to effect communication with her, but failed. The crew of the vessel—the brig *John*, of and for Hartlepool from London in ballast—called out that they wished to leave her, and they were therefore taken into the Life-boat. They were in a very exhausted condition. The vessel sank immediately afterwards, and became a total wreck. She had a crew of seven men.—Expense of service, 13*l*.

Dec. 7.—The brig *Catherina Regina*, of Riga, went ashore in Druridge Bay, Northumberland, during very stormy weather. On information of the occurrence being received at the Hauxley Life-boat Station, the Life-boat *Algernon and Eleanor* was conveyed on her carriage to the scene of the wreck. She was then launched, through a very heavy surf, and with great difficulty and danger proceeded to the vessel, which was found to have lost both her masts, and took off her crew of eight men. She then remained by her half an hour, waiting for the master and his wife, but they positively refused to quit the ship. They were subsequently taken off by the rocket apparatus. The brig became a total wreck. Expense of service, 18*l*.

Dec. 8. At 10 o'clock in the morning the schooner *Etoile du Marin*, of and for Dunkirk from Leith, with coal, was approaching Scarborough harbour during a strong gale from the E., and a very heavy sea, and as it was feared that she might not succeed in making it in safety, the Life-boat *Lady Leigh* was launched, and put a pilot on board. Several fishing-vessels were also making for the harbour, and the Life-boat therefore remained afloat until 4 P.M., when all the craft had got in safely.—Expense of service, 9*l*. 2*s*.

Dec. 8.—A vessel was observed in the offing making direct for Saltburn, while a tremendous sea was running, and the wind was blowing a gale from the E.N.E. The Saltburn Life-boat *Charles and Ann* was launched, and proceeded to the vessel, which by that time had struck opposite old Saltburn, and brought ashore her crew, consisting of five men, all of

them being Germans. The wrecked vessel proved to be the *Libra*, of Bockzetelerfehn, bound to Hamburg, with guano.—Expense of service, 12*l*.

Dec. 8.—The schooner *Star*, of St. Agnes, in attempting to come into Hayle, during a strong wind from the N.E. and a heavy sea, struck and grounded west of the bar. The Hayle Life-boat *Isis* quickly proceeded to her, and took off her crew of three men, whom she safely landed.—Expense of service, 10*l*. 10*s*.

Dec. 9.—The barque *Ross*, of Arendal, Norway, having encountered the full fury of a gale in the North Sea for a whole week, during which period her crew had suffered great privations, determined to seek a place of refuge, so as to give them rest. The lights were, however, mistaken, and instead of anchoring in the Firth of Forth, as intended, she was, at daybreak on the 9th December, near Amble, with breakers all round her. Signals of distress were shown, in response to which the Hauxley Life-boat *Algernon and Eleanor*, went to her assistance, and brought ashore her crew of ten men.

Dec. 15.—The Danish brigantine *Andreas*, on her passage from Dunkirk to the Tyne, in ballast, ran ashore on Roker Rocks, North Blyth, during thick weather, at 5 o'clock in the morning. The Blyth No. 2 Life-boat, *Tom and Marion*, put off to her assistance and rescued her crew, consisting of eight men. The vessel became a total wreck.—Expense of service, 12*l*. 2*s*.

Dec. 13.—At 4.30 A.M. rockets and large flares were seen in the direction of the Cross Sand, off the Norfolk coast; the Cockle Lightship was also firing guns and rockets. As the wind was blowing from the S.E., and it was ebb tide, it was impossible for the Caister Life-boat to sail to the sand, and a message was therefore sent to Great Yarmouth for a steam-tug, which arrived and towed the No. 2 Life-boat, the *Godsend*, to the sand, where a steamer and a schooner were found stranded. The steam-tug went to the schooner and towed her off, and the Life-boat proceeded to the aid of the steamer. The No. 1 Life-boat, the *Covent Garden*, afterwards came up, and with the assistance of the two Life-boats the steamer was got afloat. She proved to be the *Bradley*, of Liverpool, from Bilbao to

Sunderland with iron ore. She had a crew of fifteen men.

Dec. 18.—A vessel was seen in distress at the south end of Ramsey Island, Pembroke-shire, at 8 A.M. The *Augusta* Life-boat, stationed at St. David's, put off to her, and pulled across the sound through a heavy sea. The vessel had then floated to the northward. The surrounding rocks were examined, but none of the crew could be found. A shore boat, with a crew of five men, also put off to the vessel, boarded her, and found her to be a derelict. The Life-boat shortly afterwards came up, and both crews, with the aid of a steam-tug, took the vessel into Milford Haven, where she arrived at about noon on the following day. She was the Norwegian barque *Storjohann*, bound from Bordeaux to Cardiff with timber.

Dec. 18.—At 12.30 A.M. the smack *Alicia* brought news to Ramsgate, of a vessel having gone ashore on the Kentish Knock Sand. The Life-boat *Bradford* at once proceeded, in tow of the harbour steamer *Vulcan*, through the Cudd Channel, and steered straight for the Kentish Knock Sands, which are about twenty-five miles distant from Ramsgate. On nearing the Lightship, signals were shown from her, and a vessel was seen showing a flare abreast of the middle buoy. The Life-boat was got into a good position, slipped from the tug, sailed towards the wreck through a very heavy sea, and with some difficulty succeeded in taking off her crew, numbering thirteen men. The sea was breaking right over the vessel, which proved to be the barque *Egmont*, of South Shields, and her

foremast, mainmast, and mizen topmast were lying alongside.

Dec. 19.—At about 8.30 A.M. the schooner *Vigilant*, of Dundee, was seen approaching Arbroath, N.B., in a heavy sea. At about 11 o'clock she was getting close to the rocks, apparently making for the harbour. The tide at the time being half ebb, and there being little water on the bar, it was thought impossible for her to clear the land on either tack, and the Life-boat *People's Journal No. 2* put off to her assistance. On getting alongside, the Life-boatmen advised the master to let go both anchors, the vessel being within three hundred yards of the rocks eastward of the harbour. Two of the Life-boat's crew were put on board, at the request of the master, and the boat kept in attendance until the following tide, when the anchors were recovered, and the vessel was towed into harbour.

Dec. 20.—The tug *Irvine*, of Irvine, was proceeding to Ayr to tow a vessel to Irvine Harbour, during a strong S.W. gale and a heavy sea. She grounded on the centre of the bar, and showed signals of distress, in response to which the *Isabella Frew* Life-boat stationed at Irvine, promptly went off, and brought ashore her crew of four men.

Dec. 31.—Voted 274l. 6s. 6d. to pay the expenses of the Life-boats at Rye, Winchelsea, Grimsby, West Hartlepool, Fraserburgh, Hornsea, Holy Island, Hartlepool, Saltburn, Lowestoft, Whitby, Robin Hood's Bay, Tynemouth, Berwick, Salcombe, Douglas, Broughty Ferry, Harwich, Newcastle, (Dundrum) Montrose, Mundesley, and St. David's, in going out to the aid of vessels in distress.

SHORE-BOAT SERVICES REWARDED BY THE ROYAL NATIONAL LIFE-BOAT INSTITUTION IN 1882.

Jan. 3.—Five men put off in a boat at great risk and rescued eight men whose boat had been driven away from Island Crone, Co. Donegal, by a sudden gale of wind from the S.W., on the 2nd January, leaving them on the island—which is uninhabitable—where they had to remain without any shelter during the night, until rescued at about 10 o'clock on the following morning.—Reward, 10l.

Jan. 3.—The chief boatman and five Coast-guard men put off in a boat from Dymchurch, Kent, Coastguard Station, and saved the crew of four men of the sloop *Theodor*, of Copen-

hagen. That vessel had parted from her anchors and had stranded off Dymchurch, during a gale of wind from the S.W. and her crew had taken to their boat and were drifting out to sea.—Reward, 5l.

Jan. 5.—Voted the thanks of the Institution to Mr. GEORGE BROWN, of Portaferry, Co. Down, together with 5l. to himself and four men, for putting off in a boat and, at some risk, saving the crew of three men from the schooner *Jane*, of Carrickfergus, which was wrecked near Portaferry, during a strong gale from the E.S.E., on the 20th October.

Also 6*l.* to six men for putting off in a coble from Boulmer, Northumberland, and rescuing the crew of seven men from the fishing lugger *Useful*, of Cellardyke, which, while returning to Anstruther from fishing off Great Yarmouth, had become unmanageable and had partly sunk on Boulmer South Steel, during very rough weather on the 19th November.

Also 5*l.* 10*s.* to eleven men for assisting to save two of the crew of the wrecked barque *Admiral P. Lordenskjold*, of Krageroe, Norway, which was wrecked on Saunton Sands, Devon, during a strong N.W. gale, on the 20th December.

Also 5*l.* to five men for putting off in a fishing boat, and, at some risk, saving the crew of four men of the schooner *Fire Winner*, of Christiansand, which had been run ashore at Burntisland, as she was leaking very badly and was gradually sinking, her pumps having become choked, during a strong gale from the E., on the 23rd October.

Also 5*l.* to five men for putting off in the Coastguard boat at Leestone, Co. Down, with the view of rendering assistance to a steam dredger belonging to Dublin, which was in distress off Ballymartin during a gale of wind from the S.W. and a heavy sea, on the 1st November.

Also 4*l.* to four men for saving two men from a canoe which had sunk off Portlaoisy, Co. Mayo, while out fishing, during a strong gale of wind from the S.W., on the evening of the 21st Nov.

Also 4*l.* to seven men for putting off in a fishing yawl from Methil, Fife, at some risk, and saving one of the crew of the brig *Scio*, of South Shields, which was wrecked near Methil Harbour, during a fresh gale from the S.W., with a heavy sea, on the 27th November.

Jan 6.—Eight men put off in a boat, at risk of life, and rescued the crew of two men of the schooner *Scotia*, of Carnarvon, bound to that port from Belfast, which had parted from her cables and had stranded in Port Erin Bay, Isle of Man, during a strong W. gale and a heavy sea.—Reward, 8*l.*

Jan. 10.—The crew of a yawl belonging to Mundesley, Norfolk, took off from the Hasborough lightship the crew of six men of the brig *Princess*, of Whitby, which, while on a voyage from Seaham to Rochester, with a cargo of coal, had been totally wrecked on the Hasborough Sands, and afterwards landed them at Great Yarmouth.—Reward, 5*l.*

Feb. 2.—Voted the Silver Medal of the Institution, a copy of the vote inscribed on vellum, and 1*l.* each to Mr. WILLIAM NOSWORTHY, chief officer of H.M. Coastguard at Carnarvon, and to police constable HENRY EVANS, of Carnarvon, for putting off in an open boat, and, at great risk, saving five of the crew of the brigantine *Fritz von Gadon*, of Barth, Germany, which had capsized off Carnarvon during a whole gale from the W.S.W. on the 28th November.

Also 1*l.* to the owner of the boat used on this occasion in consideration of injury which it had sustained.

Also the Silver Medal and a copy of the vote inscribed on vellum to Mr. PETER MURDOCK, of Glendrishaig, Ayrshire, and 3*l.* to three of his men, for saving, at considerable risk of life, by

means of ropes, two of the crew of the schooner *Cirrasian*, of Dundalk, which had become unmanageable and was totally wrecked at Glendrishaig during a N.W. gale on the 21st December.

Also 1*l.* 10*s.* to three men for putting off in a boat from Sennen Cove, Cornwall, and bringing safely to land a boat containing the crew of fourteen men of the Austrian barque *Malaleel*, which, while on a voyage from Bordeaux to Cardiff with a cargo of pit wood, had been totally wrecked on the Shark's Fin, near Longships, Cornwall, on the night of the 8th December.

Also 5*l.* to three men for putting off in a boat, and, at some risk, saving the crew of five men of the smack *Espeigle*, of St. Mulo, which had lost her sails, had her rudder damaged, and had been driven ashore at Breen Down, Burnham Bay, during a fresh gale from the N.W. on the 18th December.

Also thanks to Mr. CHAPMAN, farmer, of Breen Down, who rendered good service on the last-named occasion in lending horses to transport the boat, and who afterwards took the rescued men into his house, gave them refreshment, and dried their clothes.

Feb. 18.—Three men put off in a boat from Whitton, Lincolnshire, and at some risk saved the crew of two men from the rigging of the keel *Henry*, of Doncaster, which had sunk on Whitton Sand, in the River Humber, during a fresh gale from the W.N.W.—Reward, 3*l.*

March 1.—The Life-boat *Refuge*, of Gorleston, Suffolk, rescued, at very great risk, one man from the s.s. *Livadia*, of Shields, which, while on a voyage from Shields to Alexandria with a cargo of coal, had been totally wrecked on the Cross Sand during a strong E. gale and thick weather. The steamer had a crew of twenty-three men, twenty-two of whom were unfortunately drowned before the arrival of the Life-boat.—Reward, 20*l.*

March 9.—A boat's crew saved four men from another fishing-boat, from Annagassan, Co. Louth, which had been struck by a squall and had capsized in Dundalk Bay.—Reward, 2*l.*

March 25.—Four men belonging to Deal rescued the crew, consisting of five men, of the fishing-boat *Alice*, of Dover, which had been swamped by a heavy sea and was in a sinking condition during a sudden gale from the N.N.W.—Reward, 2*l.*

April 6.—Voted 3*l.* to six men for putting off in a boat at some risk, and endeavouring to save the crew of six men of a fishing-lugger of North Yell, which was seen to capsize near that place during a severe gale from the N.N.W. on the 21st July. The men, however, were unfortunately drowned before help could reach them.

April 18.—Two fishermen of Arbroath put off in a boat and rescued a man from a small fishing trawler—the *Welcome Home*, of Montrose—which had gone on the rocks at the harbour bar, Arbroath, and was breaking up, during a fresh S.E. breeze and a strong swell on the 18th April.—Reward, 1*l.*

April 2.—Five men residing at Seaford, Sussex, put off in a boat and saved three men from the boat *Little Dick*, of Newhaven, which had been capsized off Seaford, during squally weather.—Reward, 2*l.*

April 29.—Ten men belonging to Stennis, Shetland, put off in a boat, at some risk, and rescued the crew of the sloop *Haabet*, of Mandal, Norway, which was leaking badly and had her pumps choked during very unsettled weather. The vessel ultimately struck on the rocks and became a total wreck.—Reward, 5*l*.

May 4.—Voted the thanks of the Institution to Mr. ROBERT THOS. DUNSEATH, of Belfast, and 1*l*. to two boys for putting off in a small boat from Holywood, co. Down, and rescuing two men and a boy from a boat which had been struck by a heavy sea, and had capsized during a gale of wind from the W.S.W. on the 19th March.

May 20.—Two men saved two persons from a boat which had been capsized off Port Isaac, Cornwall, during a moderate breeze from the S.E. by E. The salvors were in a boat in the harbour when the accident occurred, and immediately pulled towards the two men, who were swimming towards the shore, and took them into their boat.—Reward, 10*s*.

June 7.—Two men belonging to Greencastle, Co. Londonderry, put off in a boat and rescued a man from a small boat which was drifting out to sea off Greencastle during squally weather.—Reward, 10*s*.

June 9.—Four men put off in a small sailing-boat and saved four other men from a vessel which had been dismasted off Orme's Head during a strong breeze from the N.W.—Reward, 1*l*.

June 16.—Nine men put off in two boats and saved four persons whose boat had sunk in Achill Sound, Co. Mayo, during a fresh S.W. breeze.—Reward, 2*l*. 5*s*.

June 27.—A lad saved another boy, who had fallen overboard from a boat belonging to a small yacht off Youghal, Co. Cork, during a gentle N. breeze. On observing the accident the salvor, who was on board the yacht, hauled the boat up to the vessel; got into it, sculled towards the sinking lad, and at some risk fortunately succeeded in rescuing him.—Reward, 10*s*.

July 8.—Two men put off in a boat, and saved three children who, while wandering under the cliffs between Ramsgate and Broadstairs, had been overtaken by the tide.—Reward, 1*l*.

July 12.—Seven men put off in a fishing-boat, and saved the crew of three men of the ketch *Foam*, of Leith, who had taken to their boat, their vessel having been totally wrecked at Bounds Cliff, in Port Isaac Bay, during a moderate gale from the N.N.W.—Reward, 3*l*. 10*s*.

July 14.—Four men rescued the crew of two men from the rigging of the smack *Tartar*, of Watchet, which had sprung a leak and had been run ashore on Minehead Ridge during a strong S.W. breeze at midnight.—Reward, 1*l*.

July 21.—Two men put off in a boat and saved another man whose boat had sunk at Rhyd, North Wales, during squally weather.—Reward, 10*s*.

Aug. 29.—Twelve men put off in a yawl from Scratby, and, with much difficulty, saved the crew, consisting of seven men, of the brigantine *Jane and Jessie*, of Whitehaven, bound for Shetland, with bricks and building materials, which had stranded on the Outer Barber Sand during a strong N.W. by W. wind.—Reward, 12*l*.

Sept. 12.—Three men put off in a boat and

saved two other men from a small pleasure-boat named the *Hawk*, of Port Stewart, Co. Londonderry, which had been struck by a squall, and capsized in Port Stewart Bay on the 12th September. The boat sank at once; but the two men fortunately got hold of three oars, by which they were enabled to keep themselves afloat until they were rescued.—Reward, 1*l*.

Oct. 15.—Four men promptly rescued four other men, whose boat had capsized and sunk in Rosmuck Bay, Co. Galway, whilst they were cruising about, waiting to take part in a regatta, during a fresh N.W. wind.—Reward, 1*l*.

Oct. 16.—The Chief Boatman in charge of H.M. Coastguard, at Burntisland, and eight other men forming the crews of the *Coastguard* Life-whale-boat and the steam-tug *Alliance*, of Burntisland, went out, at some risk, with the view of rescuing five men who had been reported to have been left on board the s.s. *Vulcan*, of Middlesbrough, which had been wrecked on Seafield Vows Rocks, near Kirkcaldy, during a fresh gale of wind from the S.E. On reaching the vessel it was found that only her mast was out of water, and nothing could be seen of those who had been left on board her.—Reward, 9*l*.

Oct. 24.—Seven men put off in a boat, which was hauled off by the rocket apparatus whip, and saved the crew, numbering seven men, from the lugger *Meridian*, of Peterhead, which had stranded on Yarmouth beach during a whole gale of wind from the S.E., at about eleven o'clock in the morning.—Reward, 3*l*. 10*s*.

Oct. 28.—The crew, consisting of twenty men, of the *Refuge* Life-boat, of Gorleston, Suffolk, saved the crew of five men of the schooner *Sceptre*, of Sunderland, which was totally wrecked on the Corton Sands, during a heavy E.N.E. gale.—Reward, 20*l*.

Oct. 30.—Some Coastguardmen at Jury's Gap Station, Sussex, and others, saved, at much risk, three of the crew of the ketch *St. Marie Joseph*, of St. Valery, which was totally wrecked off Jury's Gap, in a fresh gale of wind from the W.S.W. and a heavy sea.—Reward, 12*l*. 5*s*.

Nov. 2.—Three men saved the crew of three men of the sloop *Alliance*, which had sprung a leak, and had foundered off Sheringham, Norfolk, during a gale of wind from the S.S.W., compelling her crew to take to their boat.—Reward, 1*l*.

Nov. 13.—Six men put off in a boat and rescued the crew, consisting of two men, from the rigging of the smack *Charles Phillips*, of Watchet, bound from Newport to Lynmouth with coal, which was totally wrecked in Porlock Bay, Somersetshire, during a fresh gale of wind from the E.S.E.—Reward, 6*l*.

Dec. 7.—Voted the Silver Medal of the Institution and 2*l*. to Mr. GEO. EDWARD HALL, Master of the fishing-boat *Trial*, of Lowestoft, for going along a hawser from the shore, at great risk, and bringing safely to land one of the crew of the schooner *Prosper*, of Carnarvon, which had stranded off Lowestoft, during a heavy N.E. gale, on the night of the 28th October. The master and two of the crew had managed to reach the land by means of the hawser, but the other man was unable to do so, being totally incapacitated by illness.

THE
MEDAL OF THE ROYAL NATIONAL LIFE-BOAT INSTITUTION,
 FOR THE PRESERVATION OF LIFE FROM SHIPWRECK.

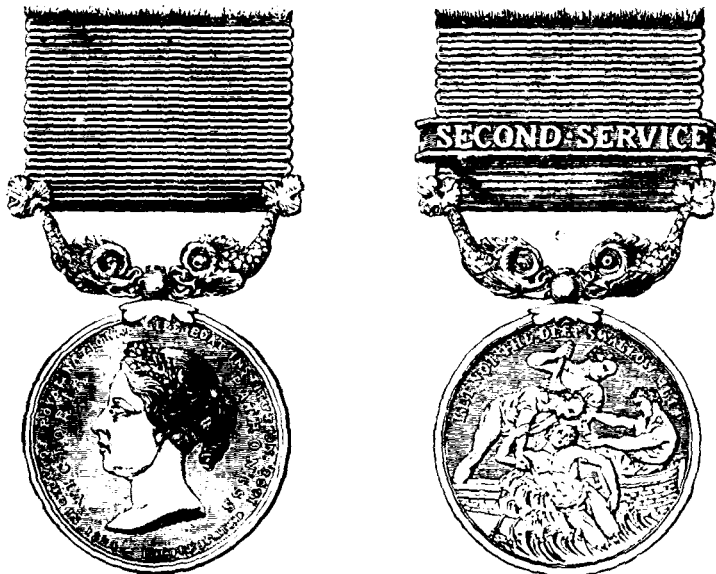

Obverse.—Bust of Her Majesty Queen Victoria; beneath, in minute letters, "L. C. Wyon." Double legend, "Royal National Life-boat Institution. Founded in 1824. Incorporated 1860. Victoria, Patroness."
Reverse.—Three sailors in a Life-boat,—one of whom is in the act of rescuing an exhausted mariner from the waves on a fragment of the wreck. "W. Wyon, Mint." Inscription, "Let not the deep swallow me up."

THE beautiful obverse of this medal, executed by L. C. WYON, Esq., represents the bust of QUEEN VICTORIA, Her Majesty's locks gracefully waving and gathered in a knot behind, from which issues a wreath of oak clustering over the forehead. This life-like portrait of the QUEEN, in high relief, conveys a truly pleasing and faithful likeness of HER MAJESTY at that period (1862), combining the dignity of aspect and benevolence which have always characterised the Queen throughout her long and prosperous reign.

The reverse, representing the Life-boat, in which there are three Seamen, rescuing a fourth from the sea, is a work of great merit. Two of the men are steadying the boat, while the other, stooping, draws in the Shipwrecked Sailor, whose figure is given so as to show the form in the most natural manner; and the expression thrown into his countenance looking up to his preserver is supplicating in the extreme, while the easy flowing lines of this sailor are finely contrasted by those of his companions: the whole displaying a perfect knowledge of the human frame, and a command of the graver to embody what he had shadowed out to himself.

But there is another pleasing motive for admiration of this beautiful Medal, as the figure who is so humanely extending his relief to the drowning Mariner is a portrait of the Artist, the late WILLIAM WYON, Esq., R.A., himself.

The following is a LIST of the GOLD and SILVER MEDALS that have been voted by the Committee of the Institution, since its establishment in 1824, to persons whose humane and intrepid exertions in saving Life from Shipwreck on our Coasts have been deemed sufficiently conspicuous to merit that honourable distinction. The Cases will be found recorded in detail in the several Annual Reports of the Institution.

The total number of Medals granted by the Institution up to the present time is 1,058, 96 of which were in Gold, and 962 in Silver.

Note.—The asterisk (*) after the name denotes the reception of a Gold Medal. The figure after the name signifies the number of honorary distinctions received from the Institution. Abbreviations.—C. Gd.—Coast Guard. R. C.—Revenue Cruiser. M. M.—Master Mariner.

Acraman, Mr. J., Fishguard.	Alexander, W., Coxswain of the Thorpeness Life-boat.	Armstrong, R., Newbiggin.	Bacon, Henry, Harwich.
Adair, Mr. W., C. Gd., Dundrum.	Allan, Jas., Holy Island.	Armstrong, Mr. W., Blyth.	Bacon, Mr. James, M. M.
Adam, Mr. J., C. Gd., Newcastle. (2)	Allen, Mr. Luke Jas., M. M., Wivenhoe.	Armstrong, W., Newbiggin.	Balley, Jas., Boatman, Deal.
Adams, Mr. Thomas, M. M.	Amis, Edward, late Coxswain of the Palling Life-boat.	Askin, J., C. Gd., Ballywalter.	Baillie, Lieut. Henry, R.N.
Agar, J., C. Gd., Morris Castle.	Anderson, Mr. John G., R.N.	Atkins, T., C. Gd., Wainfleet.	Baillie, Lieut. H., R.N.
Agnes, Samuel, Wivenhoe.	Annis, Mr. M., C. Gd. (2)	Austen, Wm., Seaman, Rams-gate Steamer <i>Vulcan</i> .	Bain, Alex., Seaman, Skerries.
Ahern, John, C. Gd., Kilmore.	Anthony, Mr. Owen, M.M., Holyhead.	Autridge, Lieut., R.N., Doonbeg.	Bake, Lieut., R.N., C. Gd.
Aikin, J., C. Gd., Cushendall.		Avise, Mr. J. N., M. M., Boulogne.	Baker, Lt. G. S., R.N., C. Gd.
			Baker, Lt. W. H., R.N., C. Gd.
			Baker, Mr. T., C. Gd., Brooke.
			Banyard, Mr. John, C. Gd.

- Barlach, Mr. Henry, M. M. Barnard, A., C. G.^d. (2)
 Barnes, George, Christchurch.
 Barrett, Mr. J., C. G.^d.
 Carnsore, (2)
 Barrett, W., C. G.^d
 Barrett, W., Jun., ditto
 Barron, R. N., Esq.
 Barry, Lt. G., R.N., Kinsale.
 Bartholomew, R. J., Esq.,
 Rothesay, N.B.
 Bate, Samuel, Second Coxswain of Padstow Life-boat.
 Bate, Thomas, Coxswain of the Bude Life-boat.
 Bates, Mr. Thos., C. G.^d
 Batist, J., C. G.^d. Dymchurch.
 Beaton, G. B. M., Esq., C. G.^d. (2)
 Beanclerk, The late Lord Charles.
 Beck, Robert, Point of Ayr.
 Beddoe, D., Fishguard.
 Bedwell, Mr. Wm., M. M.
 Begg, Mr., M. M.
 Belsey, Hy., Life-boatman, Ramsgate.
 Bennett, Capt. C. C., R.N.*
 Berriman, Mr. James, M.M.
 Berry, David, Life-boatman, Ramsgate.
 Bevan, Mr. John, M. M.
 Bickerstaffe, Mr. R., Coxswain Blackpool Lifeboat.
 Billett, Mr. R., C. G.^d, Coxswain of Lydd Life-boat.
 Bingham, Mr. Wm. [ter. Bishop, Mr. S., C. G.^d, Cais-Black, A., C. G.^d, Strangford.
 Blackmore, Mr. Wm., Chief Officer C. G.^d, Penzance. (2)
 Blackwood, Rev. J. O'Reilly, Ballywalter. (2)
 Blair, Lt. Horatio, R.N., C. G.^d.
 Blamped, Mr. C., Jersey.
 Blanc, John, Shetland.
 Blissendon, William M.
 Blois, Capt. J. R., R.N.*
 Bolitho, Simon, C. G.^d, Bude.
 Bongouru, H., Pilot, Guernsey.
 Bonner, G., C. G.^d, Collieston.
 Bouchard, John, St. Martin's.
 Bowen, Lieut. C. H., R.N.*
 Boyd, Henry, C. G.^d
 Boyd, Mrs. Captain, R.N.
 Boyle, Marcus, Coxswain of Wexford Life-boat.
 Boyle, Lieut. Hon. R. F., R.N. Brice, W., C. G.^d, Greenfaic.
 Bridle, Mr. W. M. M., Lyme.
 Brine, Thos., Esq., Douglas.
 Brinkmead, Mr. W., M. M.
 Brittain, Lieut. G. S., R.N., C. G.^d. (2)*
 Britton, Mr. J., Master of the American Ship *Rockester*.
 Britton, Mr. Wm., Coxswain of the Harwich Life-boat.
 Broad, W., Esq., Falmouth.*
 Brooks, A., C. G.^d, Dungeness.
 Brown, Henry, Newbiggin.
 Brown, James, Dunbar.
 Brown, Mr. John, Coxswain of Newbiggin Life-boat.
 Brown, Thos. Cresswell.
 Browne, Mr. P. R. M. (2)*
 Brune, Miss B. M. Prideaux.
 Brune, Miss E. F. Prideaux.
 Brune, Miss G. R. Prideaux.
 Brune, Miss M. K. Prideaux.
 Brunton, Lt. J., R.N. (2)*
 Buck, W. C., Esq., R.N., C. G.^d.
 Buckett, J., Coxswain Brighstone Grange Life-boat.
 Budd, James, Esq., Tramore.
 Bulkeley, J. B., Coxswain of Teignmouth Life-boat.
 Bulley, Lieut. J., R.N. (4)*
 Bumbly, Mr. J., C. G.^d, Clovelly.
 Bunt, Mr. John, C. G.^d.
 Burnard, Mr. T., Bideford. (2)
 Burne, J., C. G.^d, Penzance.
 Burne, John, Sen., Shields.
 Burney, Mr. R., C. G.^d, Banff.
 Bury, Lt. Viscount, P.C., M.F.
 Butcher, James, Lowestoft.
 Butcher, Rich., Lowestoft.
 Byrne, Mr. Lawrence, C. G.^d.
 Cahill, D. F. S., Esq., M.D.
 Cain, Wm., 1ste of Man.
 Callaway, W., Seaman, Lyme.
 Campbell, James, Leestone.
 Campbell, Miss J., Drogheda.
 Campbell, Mr. Angus, Cutter *Princess Royal*.
 Cameron, Capt. Orford S., R.N., C. G.^d.
 Candlish, J., Coxswain of the Lytham Life-boat.
 Canpell, T., Isle of Man.
 Carberry, Patrick, Wexford.
 Carbis, Thos., Coxswain of the Penzance Life-boat. (2)
 Carey, H., Esq., Shrove Head.
 Carr, C.S., Gunner R.C. *Sylvia*.
 Carr, Mr. Henry, H.M. Customs Wexford.
 Carr, John, C. G.^d, Dunmanus.
 Carr, Mr. Samuel, C.O. C. G.^d, Ring's End.
 Carrington, Mr. J., Master of Steam-tug *Liverpool*, of Harwich.
 Carrington, Lieut. R.N.
 Carrington, W. H., Esq.
 Carter, Mr. J., C. G.^d.
 Casey, M., Newcastle, Ireland.
 Castel, G., Broadstairs.
 Cay, Capt. R. B., R.N. C. G.^d.
 Chadock, J., C. G.^d.
 Chapman, Thomas, Esq., F.R.S., V.P.*
 Chaplin, Mr., M. M.
 Chappell, Mr. T., Bideford.
 Chappell, Capt. W., Bideford.
 Chard, J., Boatman, Thorpe.
 Chesnutt, George, Skegness.
 Chittenden, E., Broadstairs.
 Clark, George, Seaman.
 Clark, Lieut. Joseph, R.N.*
 Clayburn, T., Scarborough. (2)
 Clavel, Lt. R.N., C. G.^d.
 Cleave, Mr. R., M.M., Wivenhoe.
 Cloke, W., Pilot, Mevagissey.
 Cobb, Rev. C., M.A., Dymchurch.*
 Cockrom, W., H.M.S. *Eagle*.
 Coffey, P., Tramore, Waterford.
 Colby, Nathaniel, Coxswain of the Pakefield Life-boat.
 Cole, J., Seaman, Wivenhoe.
 Collard, Mr. S., Pilot.
 Collins, Mr. J., Master of the American Ship *Roscius*.
 Collison, Mr. R., M. M.
 Collopy, J., C. G.^d, Portbcawl.
 Combe, Lt. M., R.N.
 Conneys, Mr. Anthony, Clifden.
 Connick, Mr. J., Dundalk.
 Cooper, Mr. Hugh, C. G.^d, Cromaine Point.
 Cooper, Thomas, Sen., Life-boatman, Ramsgate.
 Cooper, Thomas, Jun., Life-boatman, Ramsgate.
 Coppin, Lt. F., R.N., C. G.^d.
 Corbett, W., Coxswain of the Ardmore Life-boat.
 Corbet, P., Pilot, Guernsey.
 Corbett, W., Esq., Isle of Man.
 Cork, W., C. G.^d, Fort George.
 Corkhill, W., Coxswain of the Padstow Life-boat. (2)
 Cornish, Lt. J., R.N., Bovis.
 Costello, M., Esq., Rosslare.
 Coul, Alexander, Montrose.
 Coul, Charles, Montrose.
 Cowin, J., Isle of Man.
 Cox, H. L., Esq., Surgeon, Army Medical Department.
 Cox, Lt. H., R.N., C. G.^d. (2)*
 Cox, Joseph, Coxswain of the Appledore Life-boat. (3)
 Cox, J., Jun., Second Coxswain, Appledore Life-boat.
 Cox, W., Kimlore.
 Craggs, J., C. G.^d, Devonport.
 Cragie, J., Coxswain of the Southwold Life-boat.
 Cronne, Dennis, Ballycotton.
 Cropper, Peter, Liverpool.
 Crosby, Nicholas, Dundalk.
 Crosswell, Mr. T., Fowey.
 Crouch, J., Broadstairs.
 Crouch, R., Broadstairs.
 Crowden, Mr. J., Chief-Officer of C. G.^d, at Muchals, N.B.
 Cubitt, Mr. W., Bacton. (2)
 Cubitt, Mr. W. Jun., Bacton.*
 Culmer, Mr., C. G.^d, Leigh.
 Cumisky, W. J., Esq., Balbriggan.
 Cummins, Mr. J., Coxswain of the Arklow Life-boat.
 Cunningham, Mr. J., New-castle.
 Curnow, Mr. Paul, Coxswain of the St. Ives Life-boat.
 Curteis, Mr. W., C. G.^d.
 Curtis, Steph., Christchurch.
 Dabine, Lieut., R.N., C. G.^d.
 Dand, M. H., Esq., Hauxley. (2)
 Dark, Mr. William, M. M.
 Darling, Wm., Light-house keeper, Fern Islands.
 Darling, Grace, his daughter.
 Darragh, H., C. G.^d, Innis Bofin.
 Davies, the late Vice-Admiral George. (4)*
 Davies, Capt. Thomas, R.N.
 Davies, George, Hoylake.
 Davison, W., Sunderland.
 Dawson, Mr. T., Hartlepool.
 Day, Chr., Middleborough.
 Day, Mr. Thomas, Bideford.
 Deane, Mr. Henry, C. G.^d.
 Delpierre, Jean A., Boulogne.
 Dent, J., Newbiggin.
 Desmond, John, Limerick.
 De St. Croix, Mr. F., Jersey.*
 De St. Croix, Mr. J., Jersey.*
 De St. Croix, Mr. P., Jersey.*
 Devereux, M., Master Pilot, Rosslare. (3)
 Dillon, Jas., C. G.^d, Arklow.
 Dobson, T., Coxswain of the Donna Nook Life-boat.
 Donkin, A., Cullercoats. (2)
 Donovan, Dennis, C. G.^d. (2)
 Donovan J., C. G.^d, Boatman.
 Dooley, Lt. D., R.N., C. G.^d.
 Douglas, Alexander, C. G.^d.
 Dower, Capt. A., Dungarvan.
 Downing, Nicholas B., Esq.
 Drayson, D., C. G.^d.
 Duffy, M., Mullaghmore.
 Dunmore, The Right Hon. The Earl of.
 Dunn, Mr. William, M. M.
 Durban, John, Walmer.
 Dyer, B., Seaman, Wivenhoe.
 Dyer, B., Seaman, Wivenhoe.
 Dyer, Lt. H. McNeill, R.N.
 Dyer, Mr. John, Stratton.
 Earle, Lt. E. C., R.N., Rye.*
 Eastaway, R., Boatman, C. G.^d.
 Eddy, R., Pilot, Plymouth. (3)
 Edington, Mr. Chas., C. G.^d.
 Edwards, Mr. D., Montrose.
 Ellis, Henry, C. G.^d, Bude.
 Elphinstone, Geo., Dundalk.
 Else, Lieut., R.N., Fowey.*
 Elton, Lt. W. H., R.N., C. G.^d.
 Elwin, Lt., R.N., Lymington.
 Elyard, Lt. Col. J. (2)*
 Erridge, E., Boatman, Deal.
 Essell, Lieut. Wm. F., R.N.*
 Evans, Mr. D., C. G.^d, Coxswain, Poolbeg Life-boat.
 Evans, Police Constable Henry, Carnarvon.
 Evans, Capt. Thomas.
 Evans, Mr. J., Fishguard.
 Evans, Lieut. Thomas, R.N.
 Evans, T., sen., New Brighton. (2)
 Evans, T., Jun., New Brighton.
 Evans, Wm., New Brighton.
 Evans, Wm., Pilot, Neath.
 Evison, Lt. J. C., R.N., C. G.^d.
 Farmer, David, Hayling.
 Farrin, Mr. G., H.M.S. *Ajaz*.
 Fell, Mr. Robert, Coxswain of Ramsey Life-boat.
 Fellows, Capt. T. H. B., R.N.
 Festing, Lieut., R.N.
 Festing, Colonel Sir F. W., C.B., K.C.M.G., R.M.A.
 Field, Lieut. Wm. Geo., R.N.
 Field, Mr. W., Milford Haven.
 Finlay, G., C. G.^d, Lambay.
 Finlay, William, Montrose.
 Fish, Chas. E., Coxswain of the Ramsgate Life-boat (2)*
 Fish, John, Southwold.
 Fisher, Mr. S., Horseferry-rd.
 Fisher, Mrs., North Feroe Islands.
 Fitzjames, Mr., R.N., Euphrates Expedition.
 Fitzpatrick, J., C. G.^d, Malin Head.
 Flann, Wm., Portland.
 Fleming, George, Gort-ston.
 Fletcher, T., C. G.^d, Rosslare.
 Flynn, P., C. G.^d, Killybegs.
 Foley, Mr., M. M.
 Foley, Mr. J., Port Talbot.
 Forbes, Mr. A., Peterhead.
 Formy, Joseph, Formy.
 Forward, Mr. T. R., Commander R. C. *Sylvia*.
 Foster, J., C. G.^d, Aldboro'.
 Found, Mr. W. M. M.
 Fowell, John, Seaman.
 Fowler, Mr. James, M. M.
 Fox, Mr. John, Fleetwood.
 Foy, Thomas, Rosglass.
 Franklin, T. H., Bridlington.
 Franklin, Lt. E., R.N., Hove.
 Franklin, Mr. J. H., Seaton Carew.
 Franklin, Mr. M., Sator Carew.
 Franklyn, Lieut. G., R.N.
 Freeman, Mr. Henry, Coxswain of the Whutby Life-boat. (2)
 Freeman, John, Seaman.
 Freeman, James, Helston.
 Freemaile, Capt. C. W., R.N.*
 Freney, John, Killiney.
 French, Mr. Charles, C. G.^d
 Friend, Thos., Life-boatman, Ramsgate.
 Fulton, Mr. Robert, R.N.
 Furlong, A., Fishguard.
 Galbrath, Mrs. E., Whitney.
 Gale, Mr. W., M.M., Barking.
 Gallagher, P., Co. Down.
 George, Philip, Coxswain of Caister Life-boat.
 Gerrard, Mr. R., Pilot, Fleetwood.
 Giles, Mr. W. M. M., Padstow.
 Gillespie, Andrew, Gunner.
 Gilmer, Mr. Wm., Dundalk.
 Gilson, Lt. T. A., R.N., C. G.^d.
 Gimar, Mr. E., Master of the French brig *Le Normans*.
 Gin, N. François, Boulogne.
 Gleeson, R. F., Wexford.
 Glover, Mr. J., M.M. Gun-fleet Sand.

- Goldring, Mr. W., M.M., Hayling.
- Goldsmith, John, Life-boatman, Ramsgate.
- Goldsmith, Richard, Life-boatman, Ramsgate.
- Goldsmith, Stephen, Life-boatman, Ramsgate.
- Gordon, Mr. John, Second Coxswain of the Tyrella Life-boat.
- Goss, Capt. T., R.N., Ct. Gd. (2)*
- Gough, J., Fisherman, Waterford.
- Gould, Lt. Wm., R.N., Ct. Gd.
- Graham, G., Lt. R.N., Ct. Gd.
- Graham, Capt. Philip, R.N.*
- Granby, Mr. Charles, M.M.
- Grandy, Mr., of the R. C. *Harpy*.
- Grandy, Lieut. S., R.N. (2)*
- Grant, Mr. W., Coxswain of the Margate Life-boat. (2)
- Graves, Mr. J., M. M., Carlisle.
- Gray, A., Ct. Gd., Fort George.
- Gray, D., Ct. Gd., Kilmore.
- Gray, Mr. Geo. Bridlington.
- Gray, Mr. J., M. M., Peterhead.
- Gray, E. W. D., Esq., Dublin.
- Gregory, J., Ct. Gd., St. Andrew's.
- Grey, George, Hartlepool.
- Griffith, David, Beaumaris.
- Griffith, Robert, Anglesey.
- Griffiths, Mr. B., M. M., Portmadoc.
- Griffiths, G., Pilot, Anglesey.
- Griffiths, T., Ct. Gd., Mulbay.
- Gruer, Wm., Ct. Gd.
- Guy, Mr. Philip, Bidetford.
- Hall, Mr. G. E., Lowestoft.
- Halse, Mr. K., Ct. Gd.
- Hamilton, Mr. Geo. Ct. Gd.
- Hamilton, H. A., Esq. (3)*
- Hamono, Mr. A., M. M.
- Hanning, N., Ct. Gd., Dingle.
- Hansell, P. S., Broadstairs.
- Hansford, John, Weymouth.
- Harrington, Mr. Dennis, Beré Island, Cork.
- Harrington, Mr. Jas., Bridlington Quay.
- Harrington, T., Ct. Gd.
- Harris, F., Esq., Inspecting Officer, Ct. Gd., Seaheld.
- Harrison, Jacob, Sudfels.
- Hatch, Mr. N. G., 1st Mate Ship *Berkshire*.
- Hayden, Mr. F., Sandown.
- Headon, Mr. Richard, Coxswain Clovelly Life-boat.
- Heal, J., Fisherman, Atherfield.
- Heard, Rich., Esq., Ct. Gd.
- Heath, Mr. Joshua, Coxswain of the Fowey Life-boat.
- Heavy, P., Constable, Knock.
- Hein, Mr. F. J., M. M.
- Henin, P., Bouloque-sur-Mer.
- Hennessy, J., Ct. Gd.
- Henry, Lieut., R.N., Ct. Gd.
- Hen-low, Lt., R.N., Ct. Gd.
- Henwood, T., Ct. Gd., Fowey.
- Herbert, The Hon. Auberon.
- Herrington, B., Southbold (2)
- Hick, Mr. M., Scarborough.
- Hicks, Bernard, Scilly.
- Hicks, Geo., Ct. Gd., Tyrella.
- Hicks, Samuel, Seaman.
- Higgs, S., Jun., Esq., the late. (2)
- Higgins, W., Second Coxswain Penzance Life-boat.
- Highland, Owen, Anglesey.
- Hildebrand, H., Esq. Clilden. (2)
- Hill, Mr. J., Coxswain, Newcastle, Dunderm, Life-boat.
- Hill, Mr. W., Mate.
- Hillary, Sir A. Wm., Bart.
- Hillary, Sir Wm., Bt. (4)*
- Hills, W., late Coxswain of the Padstow Life-boat. (2)
- Hipplewhite, Mr. T., M. M., Warkworth.
- Hodgson, J., Carver, Sunderland.
- Hoed, Mr. F. P., M. M., ship *Phénomène*.*
- Hogben, J., late Coxswain of Ramsgate Life-boat.
- Hogg, Mr. William, Ct. Gd.
- Holborn, S., Broadstairs.
- Holland, Lieut. John, R.N.
- Holman, Lieut. T., R.N.
- Hood, Hy., late Coxswain of the Seaton Carew Lifeboat.
- Hood, Mr. W., Seaton Carew.
- Hook, R., Coxswain of Lowestoft Lifeboat. (2)
- Houghton, H., Hartlepool.
- Howard, Francis, Private, 57th Regiment.
- Howe, R., Ct. Gd., Ballygerig.
- Howell, Mr. J., Port Talbot.
- Howorth, Capt. Wm., R.N.
- Hughes, E., Sen., Cwmerran.
- Hughes, G., Pilot, Guernsey.
- Hughes, Mr. John, Liverpool.
- Hughes, T., Pilot, Holyhead.
- Hughes, Mr. W., Fisherman, Pittenween, N.B.
- Humphreys, Mr. D., Liverpool.
- Hurry, Mr. Stephen, M. M.
- Huss, Mr. T., H.M.S. *Koner*.
- Hutchinson, Mr. H., Ct. Gd.
- Hutchinson, Lt., Kingstown.
- Hutchinson, Wm., R.N.*
- Hyde, James, Scilly.
- Hynys, Mr. John Dundalk.
- Hynes, B., Ct. Gd., Galway.
- Iles, The late Mr. John, Scarborough.
- Inkster, Mr. Peter, M. M., Shetland.
- James, Lieut. Horatio, R.N.*
- James, Lieut. Wm., R.N.*
- Japp, Robert, Montrose.
- Jarman, Isaac, late Coxswain of Ramsgate Life-boat. (2)
- Jeffers, Rich., Ct. Gd., Dingle.
- Jefferson, P., Newbiggin. (2)
- Jellard, Mr. John, M. M.*
- Jenkins, Mr. J., Coxswain of the Swansea Life-boat.
- Jenkins, Lt. Pilot, Port Talbot.
- Jenkins, Mr. W., Fishguard.
- Jennings, Mr. Wm., M. M., Harwich.
- Jennings, W., Ct. Gd., Looe.
- Jesse, Commander R., R.N.
- Jinks, Mr. R., Chief Officer of *Coast Guard, Cardigan*.
- Joachim, Capt., R.N. (4)
- Jobson, Lt. C., R.N. (2)**
- John, Mr. W., Breaksea.
- Johns, Mr. Rich., Mevagissey.
- Johns, Rich., Seaman, Fowey.
- Johns, R. O., Coxswain of the Tramore Life-boat. (3)
- Johns, Mr. W., M. M.
- Johnson, Admiral W. W. P., the late.*
- Johnson, Wm., Yarmouth.
- Johnston, Mr. B., M. M.
- Jones, Capt. C. Gray, R.N., the late. (2)
- Jones, Mr., Ct. Gd., Wicklow.
- Jones, Mr., Ct. Gd., Swords.
- Jones, Mr. E., M. M.,
- Jones, Henry, Penzance.
- Jones, J., Pilot, Portcawl.
- Jones, Owen, Anglesey.
- Jones, Lt. E., R.N., Ct. Gd. (3)**
- Jones, Mr. T., M. M., Port Talbot.
- Jones, Mr. T., M. M., Cardiff.
- Jones, Mr. Thos., Holyhead.
- Joy, Mr. George, M. M.*
- Juniper, Wm., Mundesley.
- Kavanagh, Peter, Coxswain of the Arklow Life-boat.
- Kearon, Capt. Edw., Arklow.
- Kelly, Lieut. E., R.N.
- Kelly, J. M., Appledore.
- Kendall, W., Ct. Gd.
- Kennedy, Inspecting-Lt. A., R.N., Ct. Gd. Ballyheige. (2)
- Kennedy, E., Ct. Gd.
- Kennedy, Mr. H., Belfast.
- Kennedy, Master J., Belfast.
- Kerley, T., Ct. Gd., Penzance.
- Kerrish, Mr. John, Ct. Gd.
- Kidd, D., Fisherman, Dundee.
- Kinch, H., Newcastle.
- King, Mr. T., M.M., Harwich.
- King, Lt. S., R.N., Southend.
- Kisbee, Com. Thos., R.N.
- Knight, Mr. Charles, Mate, Ramsgate Steamer *Vulcan*.
- Knight, J. T., Ct. Gd., Sunderland.
- Kyle, Geo., Assist. Coxswain Holy Island Life-boat.
- Kyle, Matthew, Coxswain Holy Island Life-boat.
- Lake, Mr. A., Chief Officer of Ct. Gd., Wick, N.B.
- Lambert, John, Harwich.
- Lambeth, Benj., Harwich.
- Landells, Mr. Thos., Milford.
- Lane, Lt., R.N., Dartmouth.
- Langan, Mr. Michael, First Officer of Steamer *Princess Alexandra*.
- Langton, Lieut. T. W., R.N., Ct. Gd.
- Large, Mr. J., Master Gunner, R.A.
- Larkin, Thomas, Seaman.
- Lavington, Lt. Thos., R.N.
- Lazoix, Lieut. of the French Marine at Dieppe.
- Leask, Mr. Robert, Jun., Ireland, near Stromness.
- Leese, Charles, Gunner, R.A.
- Legerton, Mr. Robert, Coxswain of Clacton Life-boat.
- Le Geyt, Miss A. B., Bath.
- Leggett, Edw., Gunner.
- Leigh, Lt. T., R.N., Ct. Gd. (3)
- Leslie, Mr. J., M. M., Stonehaven, N.B.
- Lett, Lt. S. J., R.N., Ct. Gd.*
- Levett, Mr. N., late Coxswain of the St. Ives Life-boat.
- Lewis, E., Seaman, Barmouth.
- Lewis, Mr. G., Ct. Gd., Newport, Pembroke.
- Lewis, J., Seaman, Harwich.
- Lewis, Mr. Thos., Dunfalk.
- Lewis, W., Seaman. (2)
- Lewis, W., Aberystwyth.
- Levy, J., Pilot, Mevagissey.
- Liffen, Thomas, Lowestoft.
- Likely, Henry, Limerick.
- Linaker, Mr. Hiram, New Brighton.
- Lindsay, Lieut. A. J., R.A.
- Lindsay, Lieut. Jas., R.N.*
- Lingard, Lieut. J., R.N., Whitby.*
- Lithaby, P., Ct. Gd. Boatman.
- Llewellyn, Mr. David, Ct. Gd.
- Llewellyn, M., Fishguard.
- Llewellyn, Martha, ditto.
- Lloyd, O., Ct. Gd., Lulworth.
- Lloyd, Lt. S., R.N., Ct. Gd.*
- Lose, Mr. John, C. O., Ct. Gd., Swanage.
- Louchet, L. P. A. B., Anthie.
- Loughor, Rees, Monkknash.
- Love, Private Robert, 63rd Regiment.
- Lovell, Patrick, Belmullett.
- Ludlow, Mr. I., Master of the American ship, *Monmouth*.*
- Lusk, Mr. A., Raeberry, N.B.
- Lyons, Lieut. Wm., R.N. (2)
- Macalister, Mr. Robt., Wick.
- Macdonald, George, Ct. Gd.
- Mackay, Mr. James.
- Mackell, Mr. Patrick, Ct. Gd.
- Mackintosh, Mr. Alex., M.M.
- MacMahon, Capt. H., M. M., East Clare Militia.
- Macnamara, Lt. T., R.N., Ct. Gd.*
- McArdle, Thomas, Dundalk.
- McCarthy, J., Ct. Gd., Dunderm.
- McCarthy, Jas., Ct. Gd., Kilrush.
- McCombie, Mr. Thomas, Second Officer of Steamer *Princess Alexandra*.
- McCulloch, K., Ct. Gd., Elie. (2)
- McDonald, Mr. Wm., Irvine.
- McGlen, G., barque *Albany*.
- McGladery, Lt. J., R.N., Ct. Gd.
- McKenzie, J., Ct. Gd., Galway.
- McKinnon, Mr. J., M. M., Greenock.
- McMillan, J., Kanytre.
- McNamee, P., Ct. Gd., Dunmanus.
- McNaughten, Neil, Ct. Gd.
- McQueen, Alex., Seaman.
- Maudick, Mr. H., M. M.
- Manby, Capt. G. W.*
- Manifold, Mr. William, Assist. Coxswain of the Arklow Life-boat.
- Mann, Lieut., R.N., Ct. Gd.
- Mariote, J. B., French Pilot.
- Mart, Wm., Ct. Gd., Dingle.
- Markwell, George, Holy Island.
- Marsh, Capt. D., R.N., Ct. Gd.*
- Marshall, Capt. J., Bideford.
- Marshall, Mr. John, Jun., Second Coxswain of the Seaham Life-boat.
- Martin, Mr. Cha., Ct. Gd., St. Ives, Cornwall.
- Mason, J., Ct. Gd., Elie.
- Matthews, Lt. R. B., R.N.*
- May, Mr. A. C., H.M.S. *Koner*.
- May, W. R., Ct. Gd., Boscastle.
- McAder, Henry, Life-boatman, Ramsgate.
- McEams, Wm., Coxswain of Montrose No. 1 Life-boat.
- McEams, Wm. Jun., Coxswain Montrose No. 2 Life-boat.
- McEams, Mr. R., Jun., M. M., Montrose.
- McEneff, Lt. R. R., R.N., Ct. Gd.*
- McEwe, A., Boatman, Lowestoft.
- Middleton, John, Deal.
- Milburn, John, Shields.
- Milburn, Wm., Isle of Man.
- Miller, J., Ct. Gd., Devonport.
- Miller, W., Ramsgate.
- Milligan, Mr. G., Yarmouth.
- Mills, C., Ct. Gd., Clifften.
- Minter, O., Boatman, Deal.
- Mitchel, J., Pilot, Guernsey.
- Mitchell, C., Port Isaac. (2)
- Mittin, Philip, Westford.
- Moar, Mrs., Burra Ness.
- Monker, Mr. Thomas, Coxswain of Tenby Life-boat.
- Moody, Samuel, Skegness.
- Moody, Samuel, Coxswain of Skegness Life-boat. (2)
- Moore, Gunner Jas., Coast Brigade, Royal Artillery.

- Moreno, Mr., Master of the Austrian Barque *Eva*.
 Morgan, John, Thurso, N.B.
 Morgan, Lt. E., R.N., C. G.
 Morgan, Mr. T., R.C., *Stork*.
 Morris, Capt. J. Row, R.N.*
 Morris, R., Seaman, Holyhead.
 Morris, Mr. W. E., Port Madoc.
 Morrison, Lt. R.N., C. G.
 Morrison, W., Ballywalter.
 Morrison, Mr. Silvester, C. G., Sennen Cove.
 Morley, Mr., C. G., Padstow.
 Moss, J., Boatman, Walmer.
 Mudd, Wm., Harwich.
 Mulligan, James, Sligo.
 Murdoch, Mr. Peter, Glendriahaig, Ayrshire.
 Murphy, James, C. G., St. Ives, Cornwall (2).
 Murphy, Mr. Adam, Coxswain of Tyrella Life-boat.
 Murphy, Mr. Michael, C. G., Coxswain of New Romney Life-boat.
 Murray, A., C. G., Eile.
 Nelson, Mr. W., R.N., C. G.
 Nepean, Capt. St. Vincent, R.N.
 Newnham, Lt. N., R.N., C. G.
 Newsom, Mr. W., M. M., Harwich.
 Nichol, Mr. J., M. M., Montrose.
 Nicholas, Matt., Coxswain of the Sennen Cove Life-boat.
 Nicholson, M., Knock.
 Nicolle, Mr. Philip, Jersey.
 Norcock, Capt. G. L., R.N.
 Norris, Benj., Boatman, Deal.
 Norris, Mr. James, M. M.
 Norris, Martin, R.N.R.
 Norworthy, Mr. William, C.O. C. G., Carnarvon (2).
 Nott, Capt. E. B., R.N. (2).
 O'Neil, Patrick, Scilly.
 Orr, Mr. Robt., Irvine, N.B.
 O'Shaughnessy, Miss Nora.
 O'Sullivan, M. M., Bere.
 O'Sullivan, D., C. G.
 Owen, Capt. Wm., Holyhead.
 Owen, Mr. William, M. M.*
 Owen, Richard, Anglesey.
 Oswin, Mr. John, Coxswain of the Scarborough Life-boat.
 Page, Mr. Alfred, Master, Ramsgate Steamer *Vulcan*.
 Palmer, G., Esq., M.P. (2)*
 Parker, Mr. Edwin, C. G., Methercombe.
 Parker, Mr. J., Flamboro'.
 Parker, Mr. Wm., M. M.
 Parrott, Mr. R., C. G., Tenby (2).
 Parry, Lieut., R.N.*
 Parry, Mr. Henry, Anglesey.
 Parry, Mr. R., M. M., Portmadoc.
 Parsons, Lieut. Thos., R.N.
 Parsons, Lieut. Rich., H.M. 35th Regiment.
 Parsons, Lt. W., R.N., C. G.
 Partridge, Capt. W. L., R.N., C. G.
 Pascoe, Peter, Porthleven.
 Paul, Thos., C. G., Bude.
 Payne, Mr. John, C. O., C. G., Skerries.
 Paynter, Capt. Richard.
 Peake, Admiral T. L.*
 Peake, James, Esq., H.M. Dockyard, Devonport.*
 Pearce, Rich., Esq., Penzance.
 Pearce, Jas., Pilot, Porthcawl.
 Pearce, T., Pilot, Porthcawl.
 Peart, John, Montrose.
 Pedder, Lt. W., R.N., C. G.
 Peebles, Mr. John, Irvine.
 Peebles, Mr. T., M.M., Irvine.
 Peirson, S. H., C. G., Ballygerig.
 Penney, Robert, Ramsgate Life-boatman.
 Pepper, J., C. G., Lymington.
 Perkins, Jas., C. G., Bude.
 Perrott, Sir Edward G. L., Bart., V.P.*
 Petrie, Ellen, Shetland.
 Phillips, J., Newcastle, Ireland.
 Picard, Mr. P., French M. M.
 Pilcher, Mr. Stephen, Coxswain Tramore Life-boat.
 Pillar, W., Gunner, H.M.S. *Eagle*.
 Pincomb, T., Pilot, Exmouth.
 Pitt, E., C. G., Atherfield.
 Pomeroy, H., C. G.
 Porter, William, Seaman.
 Powell, Mr. John, M. M.
 Pratt, Lt. Jas., R.N., C. G.
 Prattent, Lieut. John, R.N.*
 Preston, Mr., C. G., Newton.
 Prewel, R., C. G., Kilrush.
 Price, Thos., Beaumaris.
 Pride, C., C. G., Christchurch.
 Prior, Mr. George, C. O., C. G., Ballywalter.
 Prior, Lt. T. H., R.N., C. G.
 Prosser, Mr. H., C. G.
 Purdy, H., C. G., Tyrella.
 Puxley, H., Esq., Dunboy.
 Pym, Lt. R. E., H.N., Whitty.*
 Quadling, Mr. B. E., C. G. (2)*
 Quayle, Capt. E. (2).
 Quigley, Mr. W. T., C. G.
 Quirk, G., Esq., Douglas.
 Rae, Wm., Whitburn.
 Randall, Lt. H., R.N., C. G., (2)*
 Randle, Mr. J., Bristol.
 Rawstone, Lt. R.N., C. G.
 Ray, J., Boatman, Tenby.
 Raye, Lieut. H. R., R. M.
 Read, Lieut. J., R.N., C. G.
 Reade, W. M., Esq., Tramore.
 Reading, Mr. Daniel, Master of Ramsgate Har. sta. tugs.
 Redford, J., Cultercoats.
 Rees, Mr. A., Port Talbot.
 Rees, Mr. T. M., St. David's.
 Rees, Mr. W., Fishguard.
 Reeve, Mr. J., Swansea.
 Reilly, Patrick, Private, A.S.C.
 Regan, D., C. G., Kilmore.
 Renowden, J., C. G., Dingle.
 Revel, Edw., Seaman, Ramsgate Steamer *Vulcan*.
 Richards, Mr. E., M. M.
 Richards, Mr. T., M. M.
 Richards, James, Penzance.
 Richards, Henry, Penzance.
 Richardson, Mr. A., M. M.
 Richardson, W., Esq., Coleraine.
 Ridge, Capt. G. A. E., R.N.
 Ridge, Mr. J., Mate of R.C. *Kite*.
 Ridge, Mr. J., C. G., Cadwith.
 Riach, R., C. G., Colleston.
 Ritchie, Mr., Sanda.
 Rivers, T., C. G., Lydd.
 Roberts, Mr. John, Clogwyn.
 Roberts, Mr. R., Carnarvon.
 Roberts, Mr. Richard, Assistant Coxswain North Deal Life-boat.
 Roberts, O., Pilot, Anglesey.
 Robt. Esq., Mr. T., Coxswain of Holyhead Life-boat.
 Robertson-Macdonald, Vice-Admiral D.
 Robertson, Lieut. R., R.N.*
 Robertson, Lt. J. H. M., R.N.
 Robins, Mr. J. Gunn, C. G.
 Robinson, Mr. J., Aberdeen.
 Robinson, Lieut., R.N.
 Robinson, T., Whitty.
 Rockcliffe, W., Southport.
 Roderick, E., C. G., Dunmanus.
 Roderick, J.S., Esq., Ardmore.
 Rodgers, J., *Royal Charter*.
 Roe, R., Esq., J.P., Lynnmouth.
 Rose, W., Boatman, Lowestoft.
 Ross, Capt. Sir Thos., R.N.*
 Ross, R., C. G., Curracloe.
 Ross, R., C. G., Durnmore.
 Rossiter, T., Wexford.
 Rothery, Lieut. J., R.N.
 Rowe, W., C. G., Dingle.
 Rowe, W., Scilly.
 Rowe, W., Seaman, Helston.
 Rowlands, Mr. T., M. M., Newport, Pembroke.
 Rowlands, Mr. W., Coxswain, Holyhead Life-boat (2).
 Ruddock, J., Boatman, Fley.
 Russell, R., Esq., J.P.
 Rutter, Mr. J., Scarborough.
 Rymer, Lt. D., R.N., C. G.*
 Salmon, C., Fisherman, Grestleton.
 Sanderson, Lieut. J. P., R.N., C. G., Bridge of Don.
 Sallis, Mr. R., M. M., Bahamas.
 Sarony, Mr. O., Scarborough.
 Sauvage, Mr., French Fishing-boat *Isabelle*.
 Sawtell, Mr. Edwin, C. G., Scarlett, R., Harwich.
 Scott, Mr. G. R., *Beethoven*.
 Scott, Mr. J., M. M.
 Scott, Major Henry, Dover.
 Selly, W. H., C. G., Penzance (2).
 Sergeant, Lt. J., R.N., C. G.
 Sewell, Lt. H.F., R.N., C. G.*
 Sewell, Master John, Belfast.
 Shanahan, Mr. Michael, Bere Island, Cork.
 Shankey, R., C. G. (2).
 Shannon, P., C. G., Kilrush.
 Sharrock, J. P., C. G., Boscastle.
 Shaw, Lt. C., R.N., C. G.
 Shea, B., Coxswain of the Padstow Life-boat (3).
 Shea, D., C. G., Porthcawl.
 Sheldon, Robt., Redcar.
 Simpson, Mr. Jas., late Mate of Ramsgate H. Steam tugs.
 Sims, J., C. G., Dungeness.
 Sims, Lt. And., R.N. (2).
 Sinclair, Mr. B., Thurso, N.B.
 Sinnott, R., C. G., Mullaghmore.
 Smallridge, Mr. J. H., Coxswain Braunton Life-boat.
 Smith, F., Boatman, Lowestoft.
 Smith, Hy., Pilot, Gloucester.
 Smith, J., Shields.
 Smith, Mr. J., Thurso.
 Smith, Mr. Owen, Bideford.
 Smith, Peter, C. G., Lydd.
 Smith, T., C. G., Ballina.
 Smith, Wm., Bombardier, R.A.
 Smith, Mr. W., Aldborough.
 Smyth, H., C. G., Kilmore.
 Snell, Lt. G., R.N., C. G.*
 Somerville, Lt. J., R.N., C. G. (2)*
 Southey, Lt., R.N., C. G.
 Spark, Mr. A., M. M.
 Spraggs, J., Seaman, Hayling.
 Stables, R., Holyhead.
 Stanard, Mr. F., M.M., Southwold.
 Stap, Mr. R., C. G., Dunbar.
 Stark, Lt. P., R.N., C. G. (2)*
 Starke, Mr. J., C. G., Queens-town.
 Steane, Lt. J., R.N., Rye.*
 Steel, Mr. C., C. G.*
 Steele, John, Esq., Ayr.
 Stephens, A., Tramore.
 Stephenson, Mr. B., Coxswain of the Boatner Life-boat.
 Stevens, Henry, Gunner R.A.
 Steward, W., C. G., Ardmore.
 Stokes, Mr. R., late Coxswain of Poole Life-boat.
 Storr, J., Whitty.
 Stone, J., C. G., Boscastle.
 Stragnell, Lt., R.N.
 Strahan, Mr. H., Pilot.
 Strains, Mr. W., C. G.
 Streater, Mr. W. T., H.M. Customs, Shoreham.
 Strong, Mr. Fran. F. M.
 Stuart, Lt. J., R.N., C. G.
 Stuart, Lt. T., R.N., C. G. (2).
 Stubbs, C., Seaman.
 Stubbs, H., Atherfield.
 Stuggins, Mr. W., Second Coxswain of Teakmouth Life-boat.
 Sullivan, J., Newbham.
 Sumner, Mr. R., Formby.*
 Superville, Mr., M. M., Bordeaux.
 Surry, W., Penzance.
 Sutherland, D., C. G., Katerline.
 Suter, Mr. J., M. M.
 Sutton, Mr. C., Port Talbot, M. M.
 Swarbrick, Mr. W., M. M.
 Symmes, Lt. H. A. S., R.N., C. G.*
 Syge, The Rev. A., Balbriggan.
 Tait, Grace, Shetland.
 Talbot, C. R. M., Esq., M.P.
 Taylor, J., C. G., Dundrum.
 Taylor, Mr. W. C. O., C. G., Dunny Cove (3).
 Tegg, Mr. T., M. M., Cornwall.
 Terrett, T., Constable, Knock.
 Thomas, J., C. G., Atherfield.
 Thomas, J., C. G., Roeken, Isle of Wight.
 Thomas, R. J., Coxswain of New Brighton Life-boat.
 Thompson, D., Thurso, N.B.
 Thompson, Mr. G., Annalong.
 Thompson, Mr. R., Kirkpatrick, C. O., C. G. (3)*
 Thompson, W., Apprentice, Smack *Ruby* of Hull.
 Thorp, Mr. T., Newcastle.
 Tindall, Mr. Smith, M. M., Scarborough.
 Tindall, The late W., Esq., Scarborough.
 Toole, Capt. W., Curracloe.
 Toomey, J., Kingstown.
 Torrens, Lieut. John A. W. O'N., Royal Scots Greys.*
 Town, J., C. G., Folkestone (2).
 Town, J., C. G., Castle-gregory.
 Tredwin, Mr. R., Padstow.
 Tregiday, Mr. W. H., C. G., Newquay (3).
 Trent, J., Atherfield.
 Trestlian, Mr. R.
 Triphook, Mr. R., R. C. *Hamilton*, Dumworldly.
 Trott, T., Boatman, Deal.
 Tuckfield, Mr. T., Bideford.
 Tudor, Capt. J., R.N., Wick (2).
 Tully, W., Newcastle (bar).
 Turnbull, R., Fisherman, Dunturner, Lt. C., R.N.
 Turner, Mr. Jas., C. O. C. G., Leysdown, Kent.
 Turpin, Mr. J., C. G., Salcombe.
 Tutt, E., C. G., Dunmanus.
 Tuvache, Mr. M. M., French.
 Urell, Mr. Joseph, C. O., C. G., Hope Cove.
 Usher, Mr. J., Bridlington.

Van Houten, Mr. W., Rotterdam. (2)	Warn, W., jun., ditto.	Wheeler, C., Atherfield.	Williamson, Robert, Thurso.
Verion, Chas., Life-boatman, Ramsgate.	Warren, Lt. C. D., R.N.	Wheeler, J., ditto. (2)	Williamson, W., Pilot, Wick.
Vicary, Lt. W., R.N., Atherfield.*	Wascey, Capt. E. F. N. K., R.N. (3)	Wheeler, R., ditto.	Wilson, J., Pilot, St. Andrew's.
Vondy, I., Isle of Man. (3)	Waters, Wm., Southwold.	Wheeler, W., Pilot.	Wilson, Mr. J., M. M.
Waddy, Dr., Churchtown.	Watt, A., Montrose.	White, Jas., Coxswain of the Fishguard Life-boat. (3)	Wilson, Ralph, Holy Island.
Wade, Mr., M. M., Padstow.	Watts, Lieut. W. S., R.N.*	White, John, Coxswain of Howth Life-boat.	Wilson, T., Esq., M.P.*
Wake, Mr. Baldwin Arden, Mid. H.M.S. Forester.	Watts, Mr. Charles, M. M.	White, Joseph, Portland.	Wilson, T., Pilot, Holy Island.
Wales, G., Broadstairs.	Watts, Mr. William, M. M.	White, J. Kearney, Esq., C. G ^d . (2)	Wishart, J., Wick, N.B.
Wales, J., ditto, ditto.	Waugh, E., C. G ^d , Wexford.	Whitley, Mr. Elias, Jersey.	Wood, Mr. T. L., C. G ^d . (2)
Walker, Lieut., R.N.	Webb, Mr. Wm., Coxswain of Padstow Life-boat.	Wilds, Mr. Robert, Coxswain of the Deal Life-boat. (2)	Woodham, Lt., R.N., Banff.
Walker, Mr. J., Brigg.	Webb, Mr. John, Coxswain of Maryport Life-boat.	Wilkie, Mr. C., M. M.	Woodward, Geo., Stoker, Ramsgate Steamer <i>Vulcan</i> .
Walker, Mr. W. Lewis, Beaumaris. (2)	Wedge, W., C. G ^d , Salcombe.	Willcox, J., C. G ^d , Lydd.	Wordley, S., Harwich.
Wallace, Mr. J., M. M.	Weekes, Wm. Wall, Seaman.	Williams, Mr. D., Aberdovey.	Wright, John, Seaman.
Walsh, J., Esq., Lloyd's Agent, Dublin.	Weldrake, E., Spurn Point.	Williams, Mr. H., Coxswain of Kingstown Life-boat.	Wright, Mr. J., M. M.
Walsh, Mr. Martin, M. M.*	Welsb, Mr. M., M. M.	Williams, Mr. J., Swansea.	Wyatt, G., Seaman, Harwich.
Ward, J., R. C. <i>Sylvia</i> .	West, Mr. Wm., C. G ^d , Dymchurch.	Williams, Owen, Cemlyn.	Wylde, Lt. S., R.N., C. G ^d .
Ward, Vice-Admiral J. R.	Westbrook, Lieut., R.N.	Williams, Rev. O. Lloyd. (2)	Wyrill, H., Boat ^h , Scarborough.
Warder, D. T., C. G ^d .	Wharrier, Mr. William, Engineer of Ramsgate Harbour Steam-tug. (2)	Williams, Rev. J., Anglesey.*	Yare, Richd., Stoker, Ramsgate Steamer <i>Vulcan</i> .
Warn, W., sen., Atherfield.		Williams, Mr. J. M., Padstow.	Young, A. H., C. G ^d , Blatchington.
		Williamson, Mr. R., M.M. (2)	Young, Lt. T., R.N., C. G ^d .

THE LIFE-BELT IN USE BY THE CREWS OF THE LIFE-BOATS OF THE NATIONAL LIFE-BOAT INSTITUTION.



The requisite qualities of a life-boatman's life-belt are—

1. Sufficient extra buoyancy to support a man heavily clothed, with his head and shoulders above the water, and to enable him to support another person besides himself.

2. Perfect flexibility, so as to readily conform to the shape of the wearer.

3. A division into two zones, an upper and lower, so that between the two it may be secured tightly round the waist; for in no other manner can it be confined sufficiently close and secure round the body without such pressure over the chest and ribs as to materially affect the free action of the lungs, impede the muscular movement of the chest and arms, and thereby diminish the power of endurance of fatigue, which, in rowing-boats, is a matter of vital importance.

4. Strength, durability, and non-liability to injury.

The cork life-belt of the NATIONAL LIFE-BOAT INSTITUTION possesses the first two qualities in a greater degree than any other life-belt, and the third one exclusively. (*Vide* annexed figure.)

THE LIFE-BOAT STATION.

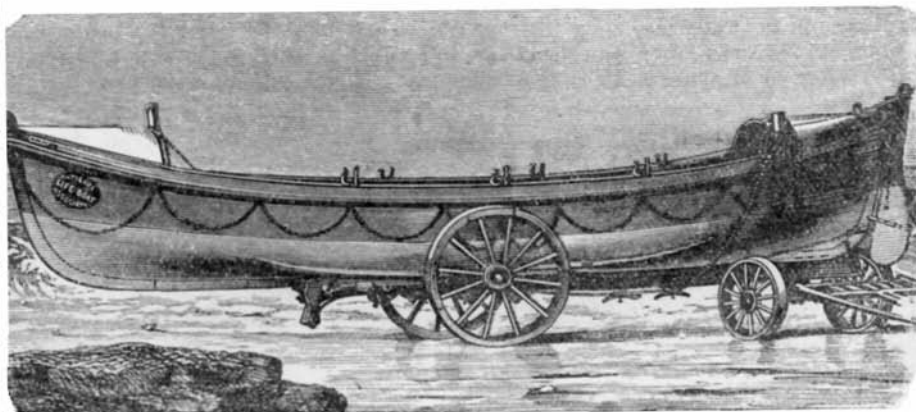

THE following brief description and diagrams illustrative of a complete Life-boat Establishment, including the House for the protection of the boat, will serve to convey an idea of the general character of one of the 273 Life-boat Stations of the NATIONAL LIFE-BOAT INSTITUTION.

It will be seen that it is a work of a costly nature, and that not only in the first instance, but that a large permanent expense is entailed in keeping the whole machinery in an efficient state, in the re-supply of any part of it which may be destroyed or worn out, in the exercise of the boats' crews, in launching and working the boats, and in remunerating them for their services in saving their fellow-creatures. Yet, looking to the vast importance of the result effected, and the responsibility of calling on men to risk their lives in effecting the same, it is felt that few if any persons will be found who will consider that expense to be incurred in vain.

THE LIFE-BOAT.

(See Diagrams on next page.)

The following figures show the general form, the nature of the fittings and air-chambers of one of these boats, 33 feet in length and 8 feet in breadth. In figs. 1 and 2, the elevation and deck plans, the general exterior form of the boat is shown with the sheer of gunwale, length of keel, and rake of stem and stern-posts. The dotted lines of fig. 1 show the position and dimensions of the air-chambers within board, the relieving-tubes, and ballast. In fig 2, A represents the deck, B the relieving-tubes (6 inches in diameter), C the side air-cases, D the end air-chambers, E ballast, F scuttles to admit of a free current of air under the water-tight deck, G scuttle for air, and to receive pump. In fig. 3, the exterior form of transverse sections, at different distances from stem to stern, is shown. Fig. 4 represents a

midship transverse section, A being sections of the side air-cases, B the relieving-tubes, of the same depth as the space between the deck and the boat's floor. c, c, c, c, are spaces beneath the deck, placed longitudinally, at the midship part of the boat, with cases packed with cork, forming a portion of the ballast; *d* scuttle for ventilation, having a pump fixed in it, by which any leakage beneath the deck can be pumped out by one of the crew whilst afloat. The festooned lines in fig. 1 represent exterior life-lines attached round the entire length of the boat, to which persons in the water may cling till they can be got into the boat; the two central lines are festooned lower than the others, to be used as stirrups, so that a person in the water, by stepping on them, may climb into the boat without assistance.

Fig. 1.

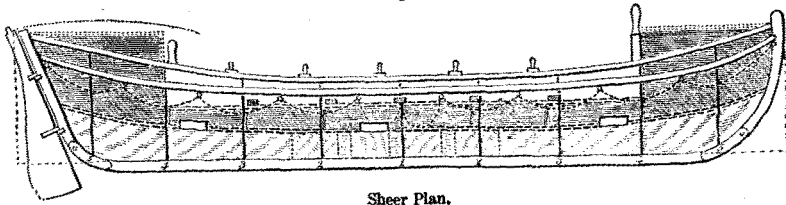

Sheer Plan.

Fig. 2.

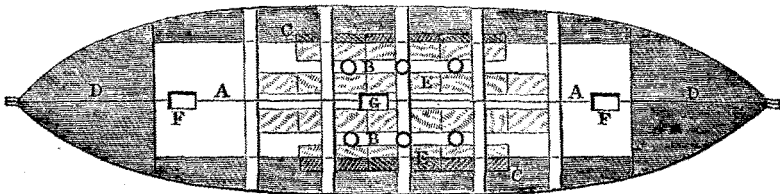

Deck Plan.

Fig. 3.

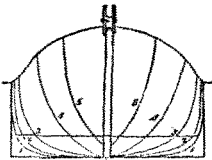

Body Plan.

Fig. 4.



Midship Section.

This Life-boat possesses in the highest degree all the qualities which it is desirable that a Life-boat should possess:—

1. Great lateral stability, or resistance to upsetting.
2. Speed against a heavy sea.
3. Facility for launching and taking the shore.
4. Immediate self-discharge of any water breaking into her.
5. The important advantage of self-righting if upset.
6. Strength.
7. Stowage room for a large number of passengers.

THE LIFE-BOAT TRANSPORTING-CARRIAGE.

The Life-boat transporting-carriage is a very important auxiliary to the boat. Every Life-boat, except a few of the larger size, is provided with a carriage, on which she is kept in the boat-house ready for immediate transportation to the most favourable position for launching to a wreck. A Life-boat is thus made available for a greater extent of coast than she otherwise would be; and even when launched from abreast of the boat-house, can be much quicker conveyed to the water's edge than she could be if not on a carriage. In addition to this ordinary use, a carriage is of immense service in launching a boat from a beach, to that extent, indeed, that one can be readily launched from a carriage through a high surf, when without one she could not be got off the beach.

The carriage consists of a fore and main body. The latter is formed of a keelway, and of side or bilgeways attached to the keelway, and resting on the main axle, the

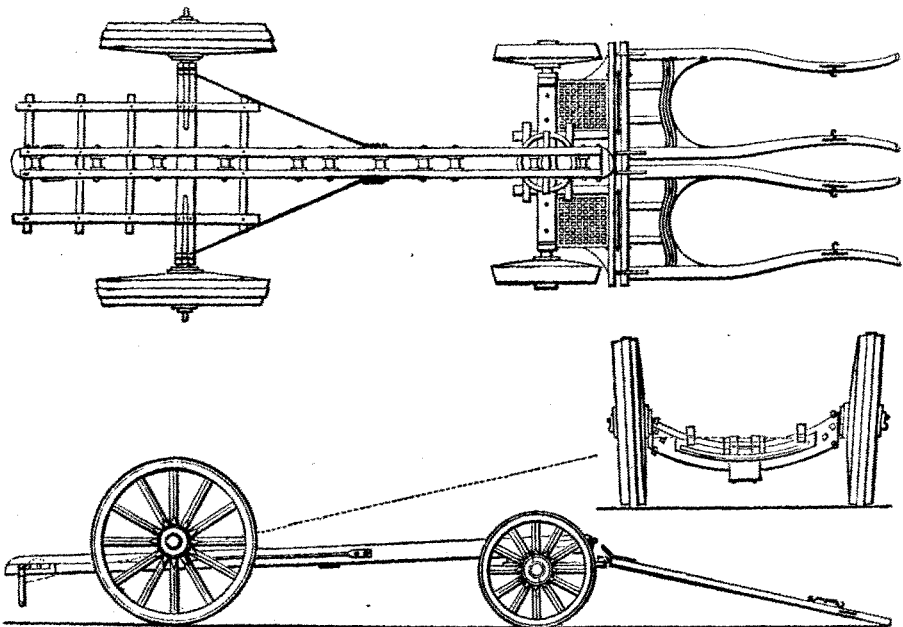

boat's weight being entirely on the rollers of the keelway. Its leading characteristic is that, on the withdrawal of a forelock pin, the fore and main bodies can be detached from each other. The advantages of this arrangement are that, whilst on the one hand the weight of the boat when she is launched from the rear end forms an inclined plane by elevating the keelway and fore-carriage; on the other hand, to replace her on the carriage she can be hauled bow foremost up the fore end or longer incline, by disconnecting the fore-carriage, and letting the end of the keelway rest on the ground, thus forming an inclined plane up which the boat is easily drawn. The bilgeways are needed at the rear end, that the boat may be launched in an upright position, with her crew on board, but they are not required at the fore end of the carriage.

A very full equipment of stores is supplied to the Life-boats of the Institution—such as cork life-belts, anchors and cables, grapnels and lines, life-buoys, lanterns, rockets, and many other articles, together with portable or launching-skids.

THE LIFE-BOAT HOUSE.

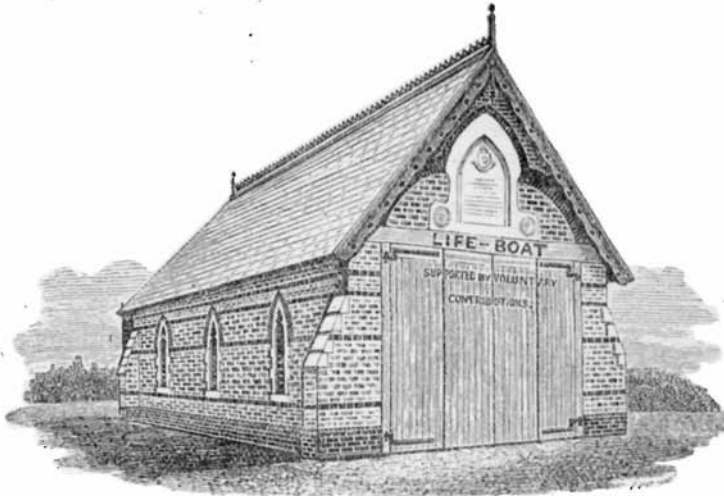

The boats of the NATIONAL LIFE-BOAT INSTITUTION, and all belonging to them, are kept in roomy and substantial boat-houses, under lock and key, in charge of paid coxswains, under the general superintendence of local honorary committees of residents in the several localities. Each boat has its appointed coxswain at a salary of 8*l.*, and an assistant at 2*l.* a year. The crew consists, in addition, of a bowman, and as many boatmen as the boat pulls oars. The members of the volunteer crews are registered, and wherever practicable, at least double the number of men required are entered on the register. Such men are mostly resident boatmen, fishermen, or Coastguardmen. On every occasion of going afloat to save life, the coxswain and each of the crew receive alike from the funds of the Institution (whether successful or not) 10*s.*, if by day, and 1*l.*, if by night; and 4*s.* each for every time of going afloat for exercise.

A reward of 7*s.* is given to the man who first brings intelligence of a wreck at such a distance along the coast as not to be in sight of the Coastguard Station or other look-out.

A flag hoisted by day, and the firing of a carronade (or other alarm signal) by night, are the well-known signals for calling the crew together.

On boarding wrecks, the preservation of life is the sole consideration. Should any goods or merchandise be brought into the Life-boat, contrary to the coxswain's remonstrance, he is authorised to throw them overboard.

The expense of a Life-boat Station averages 1,000*l.*, and is made up as follows:—

Life-boat and her equipment, including Life-belts for the Crew,	
Skids, and Transporting-carriage	£650
Boat-house (average cost)	350
Total	£1,000

The average Annual Expense of maintaining a Life-boat Station is 70*l.*

Such is a brief summary of the chief of the Regulations under which the Life-boats are worked. How faithfully and with what result they are carried out let the journals of each Life-boat Station and the annals of the Institution tell.

The NATIONAL LIFE-BOAT INSTITUTION has now 273 Life-boats under its charge. Every one of these has been specially presented to it, and they save every year from 600 to 700 shipwrecked sailors. Altogether, the Institution has contributed to the saving of 29,608 lives.

Despite, however, this fleet of 273 Life-boats, and of 30 others locally provided and supported, and despite the numerous rocket and mortar stations on our coast, there remains the melancholy fact that an average of 700 lives are lost annually on and around our own shores alone, proclaiming solemnly, though silently, that, for humanity's sake, and for the national credit, no exertions should be spared in providing every possible means for the conveyance of succour to the shipwrecked.

The Institution needs a permanent income of about 40,000*l.* to maintain its great Life-saving Fleet; and the Committee feel assured that it will never lack it so long as it maintains its boats in the state of thorough efficiency that they are in at the present time, and manned as they are on every emergency by as fearless and noble a class of men as ever our Nelsons and Collingwoods led to battle to uphold our country's honour and glory.

LIST OF LEGACIES

PAID TO THE

ROYAL NATIONAL LIFE-BOAT INSTITUTION.

[Legacies of £50 and under are omitted after having been published twice in the Annual Reports.]

	<i>Amount received.</i>
	£ s. d.
1871—ABBOTT, JOHN, Esq., Halifax (Free of Duty)	2,078 13 4
1881—ADAMS, Miss ELIZA, Eltham	406 10 0
1868—ALDRED, Dr. G. E., Richmond (Free of Duty)	100 0 0
1880—ALLAN, ROBERT, Esq., Glenhouse, N.B. (Ditto)	500 0 0
1881—ALLSOP, W. G., Esq., Nottingham	121 9 1
1877—ANDERSON, Miss MARGARET, Leamington	450 0 0
1874—ANNANDALE, ALEX., Esq., Bolton, Lasswade, N.B. (Free of Duty)	199 7 6
1866—ANSTICE, GEORGE, Esq., Chipping Norton	90 0 0
1870—ANSTICE, Mrs. ELEANOR, Tynemouth (Free of Duty)	700 0 0
1865—APPLEYARD, JOHN, Esq., Halifax	1,800 0 0
1878—ARMSTRONG, THOMAS, Esq., Ore, near Hastings (Free of Duty)	200 0 0
1877—ARNOLD, Miss ANN, Tavistock Hotel, Covent Garden	1,118 1 11
1872—ATTON, ROBERT, Esq., Taunton (Free of Duty)	800 0 0
1878—BACK, Admiral Sir GEORGE, F.R.S. Ditto (Special Bequest)	90 0 0 180 0 0
1880—BAGLEY, WILLIAM, Esq., Leicester (Free of Duty)	200 0 0
1872—BAKER, Miss ELIZABETH, Stutton, Suffolk (Ditto)	100 0 0
1872—BAKER, Miss HARRIET, Stutton, Suffolk (Ditto)	100 0 0
1875—BARKER, ALEXANDER, Esq., Piccadilly	1,800 0 0
1880—BARNARD, ROBT., Esq., Painswick, Gloucester	100 0 0
1879—BARNICOT, RICHARD, Esq., Dorking (Free of Duty)	200 0 0
1868—BARROW, ROGER, Esq., Newcastle-on-Tyne	90 0 0
1881—BARTRAM, Miss ANN, Hull	19 10 0
1882—BATES, ROBERT, Esq., Whitburn	46 7 9
1879—BATIO, JOSEPH ALEXANDER, Esq., Brighton	90 0 0
1882—BAX, Mr. EDWARD, Cockspur Street	90 0 0
1867—BEBB, Miss MARTHA, Bootham, York	1,570 16 0
1869—BECKETT, J. S., Esq., Tormoham, Devon	625 10 3
1877—BECKETT, Miss A., Fornham-St.-Martin (Free of Duty)	600 0 0
1879—BECKWITH, Mrs. MARY, Tynemouth (Ditto)	800 0 0
1870—BELL, MATTHEW, Esq., Glasgow (Ditto)	200 0 0
1865—BENNETT, Miss JEMIMA, Sloane Street, Chelsea (Ditto)	90 0 0
1875—BENTINCK, Lady CHARLES CAVENDISH	339 6 0
1875—BERGONZI, Madame, Boulogne (Free of Duty)	200 0 0
1871—BERRY, ARTHUR, Esq., Liverpool (Ditto)	100 0 0
1880—BEST, Mrs. ELEANOR, Kelston Millbrook, Southampton (Ditto)	200 0 0
1874—BEWLEY, JOHN, Esq., Kingsland Road	118 18 4
1880—BIGG, Mrs. ELIZA, Clifton	109 9 7
1859—BIGGS, GEO., Esq., Strand (Free of Duty)	100 0 0
1877—BIGGS, Miss L. M., St. John's Wood (Ditto)	1,000 0 0
1877—BIRKETT, WILLIAM, Esq., Newton-in-Cartmell	720 0 0
1876—BIRTWHISTLE, Miss M. A., Cheltenham	900 0 0
1881—BLACK, Rev. A. P., Bow	19 2 11
1883—BLAYDES, Miss ELIZABETH, Teignmouth	531 17 8
1879—BOETFEFUR, ALEX., Esq., Bayswater	8,020 6 2
1879—BOLT, ROBT., Esq., Poulton, Gloucester (Free of Duty)	100 0 0
1868—BOLTON, Miss ELIZABETH, Chelsea	415 2 6
1883—BONNER, RANDALL, Esq., New Cross	90 0 0
1860—BOWERBANK, Captain, R.N.	90 0 0
1876—BOWLES, Admiral Sir WILLIAM, K.C.B., Hill Street	180 12 0
1877—BOYS, THOMAS, Esq., Hove	5,447 14 9
1879—BRADBERRY, THOS., Esq., Finsbury Park (Free of Duty)	500 0 0
1881—BRADSHAW, Mrs. S. H., Reading	1,356 15 0
1880—BROADHURST, Hon. Mrs. H. M., Richmond (Free of Duty)	300 0 0
1865—BRODIE, Miss, York Place, Portman Square (Ditto)	400 0 0
1869—BRODIE, Mrs. MARY ANN, Harley Street	90 0 0
1868—BROMEHEAD, E. A., Esq., Thornthwaite, Cumberland (Free of Duty)	100 0 0
1879—BROOKES, J. M., Esq., M.D., St. John's Wood	90 0 0
1864—BROWN, Capt. HUGH, Kilmarnock, N.B. (Free of Duty)	99 18 6
1882—BROWN, CHRISTOPHER RUSSELL, Esq., Tredegar Square	900 0 0
1881—BROWN, J. D., Esq., Lynden, Rutland	10 0 0
1881—BROWN, PETER, Esq., Castle Douglas	90 0 0
1869—BROWN, THOMAS, Esq., Ludgate Hill (Free of Duty)	500 0 0
1877—BROWNE, Miss MARY, Liverpool (Ditto)	250 0 0
1867—BROWNRIGG, Dr. THOMAS, Keighley, York	180 0 0

[Continued.]

LIST OF PAID LEGACIES—*continued.*

	<i>Amount received.</i>	
	£	s. d.
1880-1—BRUCE, Miss JANE ISABELLA, Haddington	1,237	8 0
1871—BURD, Mrs. MARY, Wantage (Free of Duty)	1,500	0 0
1882—BURLEY, JOHN, Esq., Halifax	234	0 0
1878—BURRELL, Miss F. A., Durham (Ditto)	100	0 0
1877—BURY, CHARLES, Esq., Nazing (Free of Duty)	500	0 0
1876-8—CAMERON, Miss E.	1,330	8 10
1877—CAMERON, Miss MARGARET	356	19 11
1864—CAMPBELL, DAVID, Esq., Rothesay, N.B.	107	18 11
1877—CARLILE, Miss H. E., Clifton, Bristol	90	0 0
1868—CHAPMAN, Mrs. MARY, Aldborough (Free of Duty)	60	0 c
1882—CHEESMAN, GEO., Esq., Dorking (Free of Duty)	50	5 3
1876—CHELLINGWORTH, Miss A. W., Upton Bishop (Ditto)	103	19 0
1872—CHORLEY, HENRY F., Esq., Eaton Place West (Ditto)	600	0 0
1858—CHURCH, Miss, Berkeley	90	0 0
1869—CLARK, Mrs. M. E., Addison Road, Kensington	450	0 0
1868—CLAYTON, THOMAS, Esq., Wakefield (Free of Duty)	250	0 0
1877—COATES, P. E. Esq., Stanton Court, Somerset	450	0 0
1881—COBB, Mrs. M. A., Jersey	1,621	15 9
1882—COFFIN, ADMIRAL, Caversham, Oxford	90	0 0
1881—COHEN, Miss MATILDA, Inverness Terr., Bayswater (Free of Duty)	100	0 0
1855—COLES, B., Esq., Tunbridge Wells	155	18 0
1881—COLLER, Mrs. CAROLINE, Brompton (Free of Duty)	302	6 0
1882—COOKE, CHRISTOPHER, Esq., Lincoln's Inn Fields (Free of Duty)	10	0 0
1878—CORKER, C. J., Esq., Ramsgate	449	10 0
1872—COSENS, WILLIAM, Esq., Langdon, Dawlish (Free of Duty)	200	0 0
1870—COSTELLO, DUDLEY, Esq., Acacia Road, St. John's Wood	399	17 3
1881—COURTNEY, Miss A. M.	10	0 0
1882—COWLEY, J. C., Esq., Kilsby	9	0 0
1882—CRADDOCK, C. R., Esq., St. John's Wood (Free of Duty)	100	0 0
1876—CRANHAM, CHARLES, Esq., Audlem, Chester	450	0 0
1872—CROYDEN, Mrs. LUCY, Portswood, Southampton	69	10 8
1882—CUFF, Miss ALICE, Frome (Free of Duty)	100	0 0
1863—CURRIE, WILLIAM, Esq., Cornhill	180	0 0
1862—CUTTO, Mrs. ANN, Old Kent Road (Free of Duty)	1,000	0 0
1866—DALTON, RICHARD, Esq., Wigton (Ditto)	100	0 0
1881—DANCE, Miss ANN, Kelso, N.B.	270	0 0
1873—DANFORD, WILLIAM, Esq., Highweek, Devon (Free of Duty)	100	0 0
1868—DANGAR, WILLIAM, Esq., Cheltenham (Ditto)	200	0 0
1882—DANIEL, Miss E. W., Weston-Super-Mare	90	0 0
1872—DAVIDSON, Mrs. ISABELLA, Conway (Ditto)	100	0 0
1857—DAVIES, Miss JANE, Clapham	90	0 0
1872-82—DEAN, W. H., Esq., Stratford	434	11 1
1867—DEANE, Mrs. MARIA, Cheltenham (Free of Duty)	100	0 0
1880—DEIGHTON, Miss SARAH, Peckham	180	0 0
1874—DEWAR, EBENEZER, Esq., Leith, N.B.	89	8 0
1881—DEWAR, Mrs., Edinburgh	88	8 6
1876—DEWAR, Mrs., Vogrie, N.B. (Free of Duty)	500	0 0
1875—DICKMAN, Captain W. H., R.N., Holloway	368	16 1
1875—DOLLING, Miss, Shrewsbury	90	0 0
1883—DOMETT, Capt. JOHN, Camberwell (Free of Duty)	10	0 0
1869—DONCASTER, Mrs. ELIZA, Winthorpe, Nottingham (Ditto)	100	0 0
1882—DODD, HENRY, Esq., Rotherfield (Free of Duty)	500	0 0
1870—DORSET, Miss SARAH, Reading (Ditto)	100	0 0
1873—DOUGLAS, Miss E. HOUSTON, Eaton Place (Ditto)	250	0 0
1878—DOUGLAS, Mr. JOHN, Skirbeck, near Boston	1,343	6 3
1881—DOWNIE, Miss, Appin, N.B. (Free of Duty)	1,000	0 0
1872—DRUMMOND, Mrs. S. J. DUNDAS, Kensington (Ditto)	2,500	0 0
1832—DUPPA, Mrs., Homerton, Middlesex	1,000	0 0
1873—EDISON, Mrs. H. M. ADEL, Leeds (Free of Duty)	200	0 0
1882—EGDELL, Miss ANN, Alnwick	900	0 0
1882—ELWES, Miss F. J., Oxford	450	0 0
1873—ELWOOD, Mrs. A. K., Clayton Priory, Hurstpierpoint	90	0 0
1877—EVERARD, Miss GRACE, Laverstock, Wilts (Free of Duty)	1,000	0 0
1870—EVANS, ALFRED SMITH, Esq., Edgbaston (Ditto)	500	0 0
1877-8—FAIRLIE, Lady CUNNINGHAM	893	6 2
1879-83—FARMER, JOHN, Esq., Darlington	360	0 0
1864—FARNELL, JOHN, Esq., Isleworth (Free of Duty)	1,000	0 0
1877—FARTHING, MICHAEL, Esq., Hartlepool (Ditto)	120	0 0
1882—FAWCETT, Mrs. ANN, Norfolk Terrace, W.	450	0 0
1876—FERGUSON, the Misses, Edinburgh	4,500	0 0
1873—FERNLEY, JOHN, Esq., Southport (Free of Duty)	500	0 0
1874—FINDLATER, ALEXANDER, Esq., Kingstown (Ditto)	200	0 0
1876—FINNIE, JOHN, Esq., Bowden Lodge, near Altrincham	666	13 4
1877—FIRBANK, EDWARD, Esq., Uplyme, Devon (Free of Duty)	1,000	0 0
1880—FIRBANK, Mrs. ANNE, Charlton (3 per Cent. Consols)	908	5 0

[Continued.]

LIST OF PAID LEGACIES—*continued.*

	Amount received.		
	£.	s.	d.
1879—FISHER, EDWARD, Esq., Ashby-de-la-Zouch (Free of Duty)	100	0	0
1872—FITCH, Mrs. FRANCES, Bath	500	0	0
1856—FITZGERALD, Captain HAMILTON, R.N., V.P.	9,551	14	2
1864—FITZROY, The Hon. Mrs., Upper Grosvenor Street (Free of Duty)	400	0	0
1879—FLETCHER, G. H., Esq., Carshalton	450	0	0
1879—FOLEY, Miss MARY, Bramley Road, Notting Hill	233	1	6
1881—FORBES, Mr. & Mrs. PETER, Dunsholt, Fife	550	0	0
1881—FORTUNE, Mrs. A. P., Liverpool (Ditto)	200	0	0
1858—FOSTER, GEO. HOLLGATE, Esq., V.P., Moorgate Street (Free of Duty)	1,000	0	0
1875—FOULSTON, Mrs. ELIZA, South Kensington	83	0	6
1869—FOX, ROBERT, Esq., Falconhurst, Kent (Free of Duty)	100	0	0
1878—FOXTON, Mrs. C. D., Pendlebury, near Manchester (Ditto)	1,000	0	0
1867—FRITH, Mrs. ANNE, Deptford	90	0	0
1868—FYDELL, R. S., Esq., Moreot Hall (Free of Duty)	100	0	0
1873—GARDEN, R. J., Esq., South Kensington	1,193	6	0
1862—GEDGE, Miss ALICE, Great Yarmouth	304	16	0
1876—GIBB, B., Esq., Deptford	90	0	0
1878—GIBBON, L. P., Esq., Pembroke	450	0	0
1875—GIBBONS, Mrs. SILLS, Bath (Free of Duty)	500	0	0
1874—GIBSON, Capt. ROBERT, R.N., C.B., Lancaster (Ditto)	100	0	0
1877—GIBSON, Dr. ALEXANDER, Auchenreoch, N.B.	802	16	0
1866—GILBERT, JOHN GRAHAM, Esq., Yorkhill (Ditto)	100	0	0
1877—GILBERT, Mrs. JANE GRAHAM, Yorkhill, N.B. (Ditto)	250	0	0
1875—GOADSBY, Mrs. M. A., Fallowfield	450	0	0
1875—GODIN, Miss SARAH, Maida Vale (Free of Duty)	100	0	0
1882—GODWIN, HENRY MORGAN, Esq., Brighton	900	0	0
1879—GOOCH, JAMES, Esq., Ipswich (Ditto)	100	0	0
1866—GOODMAN, Miss ELLEN, Eversholt	540	0	0
1877—GORDON, Capt. J. A., R.N., Ittingston, N.B.	271	19	2
1868—GORFENKLE, JACOB, Esq., Liverpool (Free of Duty)	500	0	0
1872—GOVER, Miss ELEANOR, Pimlico (Ditto)	94	9	0
1872—GRAHAM, JOHN, Esq., Ide Hill, Sevenoaks (Ditto)	1,000	0	0
1877—9—GRAHAM, JAMES, Esq., Cornwall Terrace, Regent's Park	2,500	0	0
1877—GRAHAM, Miss ANN MAXWELL, Williamwood (Free of Duty)	500	0	0
1851—GRANTHAM, Mrs. JANE, Altrincham, Cheshire	100	0	0
1871—GREENE, JOHN, Esq., Gateshead (Free of Duty)	200	0	0
1877—GRIFFITH, H. DAVIES, Esq., Caer Hŷn, Carnarvon (Ditto)	2,000	0	0
1875—GRIFFITHS, Miss REBECCA, Dudley	180	0	0
1874—GRINDLAY, THOMAS, Esq., Edinburgh (Free of Duty)	1,000	0	0
1866—GROVE, WILLIAM CHARYN, Esq., Mere, Wiltshire	90	0	0
1875—HABERFIELD, Lady, Clifton (Free of Duty)	640	0	0
1868—HALL, Miss LOUISA, Maida Vale (Ditto)	945	0	0
1880—HALL, THOMAS, Esq., Welbeck St., Cavendish Square	1,742	0	3
1867—HALL, WILLIAM JOHN, Esq., Trinity Square	580	11	10
1873—HAMILTON, Miss MARY ANN, Harrogate (Free of Duty)	200	0	0
1864—HARCOURT, Admiral O. V., Swinton Park (Ditto)	1,000	0	0
1880—HARCOURT, Mrs. A. H. DANBY VERNON, Swinton (Ditto)	500	0	0
1881—HARGRAVE, CHARLES, Esq., Bayswater	3,600	0	0
1873—4—HARRIS, Capt. E. W., Rochester	8,342	8	0
1880—HARRIS, HENRY, Esq., Streatham	900	0	0
1881—HARRIS, Mrs. HENRY, Streatham (Free of Duty)	1,000	0	0
1876—HARRISON, Miss H. M. Bath (Ditto)	500	0	0
1868—HARRISON, Miss SARAH, Edge Hill (Ditto)	100	0	0
1882—HARTNELL, JOHN, Esq., Bloomfield Street, W. (Free of Duty)	100	0	0
1834—HAYMAN, Mrs., Topsham, Devon	88	0	0
1825—HECKER, JOHN HENRY, Esq., Finsbury Square	1,000	0	0
1860—HEMINGTON, THOMAS FISHER, Esq., Uplyme, Devon (Free of Duty)	100	0	0
1877—HENLEY, Mrs. ANN, Plymouth	180	0	0
1881—HENNIKER ALDBOROUGH, J. B., Esq., Catcott, Somerset	90	0	0
1879—HINDLEY, Miss ELIZABETH, Heaton Norris	90	0	0
1882—HINKLEY, JOHN, Esq., Derby	45	0	0
1878—HOLGATE, JOHN, Esq., Burton-in-Lonsdale (Free of Duty)	200	0	0
Ditto, for the widows and families of men lost or injured while engaged in Life-boats (Free of Duty)	200	0	0
1865—HOLLINS, Wm., Esq., Over Wallop, Southampton (Ditto)	511	11	6
1880—HOLME-SUMNER, Mrs. H. K., Swaffham (Ditto)	100	0	0
1872—HOLME, THOMAS, Esq., City Road	4,545	0	0
1881—HOLT, Col. W. J., Gorphwysfa, Bangor	450	0	0
1867—HOOPER, Mrs. MARIANA, Andover (Free of Duty)	100	0	0
1880—HOPE, Mrs. ELLEN, Upper Seymour Street	270	0	0
1869—HORTON, Miss MARY ANN, Highbury (Free of Duty)	100	0	0
1865—HORTON, SAMUEL, Esq., Prior's Lee (Ditto)	100	16	10
1872—HOWARD, THOMAS, Esq., Rotherhithe (Ditto)	100	0	0
1874—HOWELL, JOHN, Esq., Cadogan Place (Ditto)	210	13	9
1879—HOYLE, DUNCAN, Esq., Orme Square, Bayswater (Ditto)	1,000	0	0

[Continued.]

LIST OF PAID LEGACIES—*continued.*

	<i>Amount received.</i>		
	£	s.	d.
1868—HUDSON, JOSEPH, Esq., Barrow-upon-Soar	90	0	0
1879—HUGHES, MISS HANNAH, Budleigh-Salterton	214	5	9
1879—HUNT, Mrs. MARIA, Hornsey	450	0	0
1873—HYDE, Colonel J. C., Timbercombe Lodge, Somerset (Free of Duty)	247	7	6
1873—INGLEBY, Rev. CHARLES, Cheadle, Stafford (Ditto)	100	0	0
1877—IRLAM, GEORGE, Esq., North Row, Park Lane (Ditto)	1,000	0	0
1867—IRLAM, Miss MARIA, Dibbinsdale (Ditto)	1,000	0	0
1876—IRVINE, Mrs. S., Geneva	270	0	0
1878—JACKSON, Miss A. C., Croydon (Free of Duty)	100	0	0
1877—JEFFERSON, EDWARD, Esq., Pontefract (Ditto)	400	0	0
1882—JEFFERY, Miss ELIZABETH, Nottingham (Free of Duty)	50	0	0
1875—JEREMY, Mrs. C. A., Axminster (Ditto)	1,000	0	0
1863—JOLLY, Mr. JOHN, Farmer, Eustone, Oxford	189	0	0
1868—JONES, CHARLES WILLIAM, Esq., Norwich	180	0	0
1879—JONES, EDWARD, Esq., Port Hope, Ontario	(\$3,000)	611	5 11
1882—JONES, Miss MARIA, Waterloo (Free of Duty)	1,000	0	0
1861—JUDKIN, J. R., Esq., Hackney (Free of Duty)	105	0	0
1870—J. L., Esq., Horsham	450	0	0
1864—KEATE, Miss EMMA, Kensington (Free of Duty)	300	0	0
1869—KEMP, Miss E. S., City Road (Ditto)	100	0	0
1878—KENDALL, Wm., Esq., Exeter (Ditto)	1,000	0	0
1877—KENDRICK, Mrs., Philpot Street (Ditto)	100	0	0
1875—KERR, MALCOLM, Esq., Glasgow (Ditto)	250	0	0
1882—KILLINGTON, E., Esq., Inns of Court Hotel (Free of Duty)	100	0	0
1881—KING, Mrs. ARABELLA, Kentish Town (Ditto)	50	0	0
1868—KINGSTON, FRANCIS HOUSE, Esq., Harpenden	431	2	0
1874—KIPLING, Mrs. S. E., Kentish Town	450	0	0
1874—KIRBY, Mrs. F. S., Dublin	180	0	0
1880—KIRKPATRICK, Mrs. HARRIET SUTTON (Free of Duty)	100	0	0
1864—KITCHING, JOHN, Esq., Stamford Hill (Ditto)	100	0	0
1872—KNIGHT, Miss MARIA, Hathern, Leicester	90	0	0
1875—LAMBERT, JAMES, Esq., Alloa, N.B.	502	11	6
1880—LANDSEER, CHARLES, Esq., R.A., St. John's Wood (Free of Duty)	500	0	0
1880—LANDSEER, Miss JESSIE, Kensington Park Gardens (Ditto)	100	0	0
1882—LE CAPPELAIN, J., Esq., Highgate (Ditto)	100	0	0
1877—LEE, Miss MARY, Foleshill, Warwickshire (Ditto)	250	0	0
1872—LEEVES, EDWARD, Esq., Venice (Ditto)	100	0	0
1876—LEWTHWAITE, Miss SARAH, Bowdon, Chester	450	0	0
1877—LEWTHWAITE, Miss F. J., Colton, Lancashire (Free of Duty)	200	0	0
1876—LIDDELL, HENRY, Esq., Kingston-upon-Hull (Ditto)	100	0	0
1870—LLOYD, CHARLES, Esq., Kennington (Free of Duty)	500	0	0
1882—LOCKWOOD, Mrs. M. M., Upper Phillimore Place	180	0	0
1876—LONG, Miss CATHERINE, Chipping Norton	172	16	6
1876—LONSDALE, HENRY, Esq., M.D., Carlisle	90	0	0
1854—LOWE, SAMUEL J., Esq., Shadwell	871	15	0
1882—LUCOMBE, Mrs. MARY, Brighton	1,450	0	0
1880—LUPTON, Miss MARY, Broughton, Lancaster (Free of Duty)	103	16	0
1862—LUPTON, WILLIAM, Esq., Salford (Ditto)	100	0	0
1872—LYON, Mrs. JANE, Knightsbridge (Ditto)	500	0	0
1869—MACKIE, Dr., Greenock	359	12	5
1864—MACNAB, JAMES, Esq., Guildford (Free of Duty)	99	4	6
1879—MACNAMARA, Admiral Sir BURTON, Kingstown	525	3	0
1864—MAGENIS, F. R., Esq., Grosvenor Place (Free of Duty)	1,000	0	0
1881—MAHONY, Dr. MONTAGUE MARTIN, Chelsea	7,646	1	3
1875—MARKLAND, Miss ELLIN, Notting Hill (Free of Duty)	200	0	0
1875—MARSHALL, ROBERT, Esq., Edinburgh	270	0	0
1879—MASON, Miss ELIZABETH, Necton	900	0	0
1877—MAY, Dr. H. S., Exeter	180	0	0
1883—MAYOTT, W. F., Esq., Camberwell (Free of Duty)	100	0	0
1869—MCALLEY, WILLIAM, Esq., Stirling, N.B.	99	1	10
1882—MCGREGOR, ALEXANDER, Esq., Glasgow (Free of Duty)	50	0	0
1874—MCKINNELL, or HANNA, Mrs., Kirkcudbright, N.B.	91	11	0
1881—MCMASTER, E. C., Esq.	12	10	0
1872—MEREDITH, Mr. THOMAS, Edgware Road	52	10	0
1874—METGE, PETER PONSONBY, Esq., Athlumney, Navan	180	0	0
1871—MEYNELL-INGRAM, Miss LOUISA E., Hoar Cross (Free of Duty)	300	0	0
1871—MEYRICK, STANTON, Esq., Brompton	611	7	6
1863—MILLER, JAMES, Esq., Glasgow (Free of Duty)	100	0	0
1878—MILLOTT, Miss EMILY, Pendleton, near Manchester (Ditto)	100	0	0
1877—MITCHELL, JAMES, Esq., Kincairney, N.B. (Ditto)	506	5	0
1881—MONK, Capt. JOHN, R.N., Neston, Cheshire (Ditto)	500	0	0
1864—MONTAGU, Captain M., R.N., Bath (Ditto)	98	13	4
1865—MORGAN, Mrs., Cheltenham (Ditto)	204	11	10
1876—MORRIS, Mrs. C. H., Hammersmith	463	14	4

[Continued.]

LIST OF PAID LEGACIES—*continued.*

	<i>Amount received.</i>	
	£	s. d.
1877—MOSTYN, T. A. B., Esq., St. James's Place (Free of Duty) . . .	100	0 0
1882—MURPHY, JAMES, Esq., Newry, co. Down . . .	900	0 0
1875—MYTTON, Miss C. H. A., Shelton, near Shrewsbury . . .	450	0 0
1868—NAYLOR, WILLIAM, Esq., Twickenham (Free of Duty) . . .	500	0 0
1871—NEALE, Miss, towards "Pendock Neale" Life-boat . £246 16 7		
1872-5—Also donations from Miss HERRING, Newport, for same Life-boat, in memory of departed friends . 353 3 5	600	0 0
1876—NEWEN, GEORGE, Esq., Cambridge Terrace (Free of Duty) . . .	100	0 0
1881—NICHOLLS, Miss CHARLOTTE, Finsbury Park (Ditto) . . .	785	6 0
1882—OLDHAM, JAMES NAISH, Esq., Bridlington . . .	450	0 0
1882—ORD, W. G. H., Esq., Bowdon, Chester (Free of Duty) . . .	250	0 0
1878—OVEY, Miss JANE, Henley-on-Thames (Ditto) . . .	500	0 0
1867—OXENHAM, Miss C. N., Kensington . . .	180	0 0
1882—OXLEY, C. C., Esq., Ripon . . .	45	0 0
1881—PACKER, CHAS., Esq., Regent Street (Free of Duty) . . .	100	0 0
1882—PADDON, Miss E., Brighton (Free of Duty) . . .	100	0 0
1875—PARK, WILLIAM, Esq., Torwoodhill, N.B. (Ditto) . . .	148	18 5
1875—PARK, Mrs. Do. Do. Do. Do.	500	0 0
1877—PARKER, Mrs. M. D., Whippingham, Isle of Wight (Ditto) . . .	300	0 0
1881—PARKIN, WM., Esq., Louth . . .	100	6 8
1880—PECK, Mrs. AMELIA KEZIA, Plymouth (Free of Duty) . . .	250	0 0
1857—PETERSON, Miss MARIA, Bromley . . .	90	0 0
1876—PHELPS, Mrs. MARGARET, Chichester (Free of Duty) . . .	101	18 3
1876—PICKERSGILL, H. W., Esq., R.A., Blandford Square . . .	900	0 0
1881—POLLARD, JOHN, Esq., Holker Cartmel, Lancaster . . .	47	18 0
1879—POPHAM, Mrs. J. E. M., Ardhattan, N.B. . . .	464	8 7
1882—PRATT, Mrs. HESTER, Leamington (Free of Duty) . . .	100	0 0
1880—PRICE, ALLIN FOORD, Esq., M.D., Deptford (Ditto) . . .	100	0 0
1883—PRICE, Mrs. A. T., Peckham (Free of Duty) . . .	1,000	0 0
1830—PRIOR, WILLIAM, Esq., Herne Hill, Camberwell . . .	1,827	14 8
1879—RADCLIFFE, H. J., Esq., Eastbourne . . .	520	14 5
1875-6—RANDELL, JAMES, Esq., Mark Lane . . .	483	15 11
1874—RATTRAY, Miss MARY GRAY, Tavistock Square . . .	200	0 0
1867—RAWSON, Miss MARIA, Sheffield . . .	90	0 0
1876—RAYMENT, Mrs., Dartford (Free of Duty) . . .	100	0 0
1881—REARDON, Miss ELLEN, Islington . . .	5,331	19 5
1874-5—REEVE, JOHN, Esq., Reading (Ditto) . . .	948	15 0
1848—RENNELL, THOMAS THACKERAY, Esq., Enfield . . .	360	0 0
1880—RHODES, W. B. Esq., Hounslow . . .	27,779	2 9
1869—RICHARDSON, Mrs. HARRIETT, Greenwich . . .	4,412	0 6
1874—RICHARDSON, Miss MARY, Edinburgh (Free of Duty) . . .	500	0 0
1877—RIDEOUT, W. J., Esq., Charles Street, Berkeley Square (Ditto) . . .	1,000	0 0
1876—RIGDEN, the Misses, Chestow (Ditto) . . .	100	0 0
1877—ROBERTSON, CHARLES, Esq., Long Acre . . .	450	0 0
1870—ROBERTS, JOHN, Esq., Mornington Road (Free of Duty) . . .	200	0 0
1882—ROBERTS, RICHARD, Esq., Blackley, near Manchester (Ditto) . . .	600	0 0
1873—ROBERTSON, Mrs. M. J., Kelso, N.B. . . .	450	0 0
1863—ROBINSON, Mr. THOS., Cheetham, Manchester . . .	189	0 0
1879—ROE, Mrs. Mary, Nutley, Co. Dublin (Free of Duty) . . .	400	0 0
1870—ROLLESTON, Mrs. HARRIET, Swindon . . .	450	0 0
1874—ROYOU, WILLIAM, Esq., Tottenham . . .	501	11 11
1881—RUDGE, W. N., Esq., South Audley Street (Free of Duty) . . .	1,000	0 0
1874—RUSSELL, Lady FRANKLAND, Thirkleby, Yorkshire . . .	106	19 8
1869—SCOTT, SAMUEL, Esq., Cavendish Square (Free of Duty) . . .	1,000	0 0
1858—SELL, Mr. CHARLES, Hoxton . . .	66	2 11
1867—SHARPE, Miss JANE, Whitburn . . .	89	6 8
1866—SHAW, JAMES DAVIDSON, Esq., Newcastle-on-Tyne . . .	449	1 8
1879—SHAW, JAMES, Esq., Brighton (Free of Duty) . . .	100	0 0
1881—SHEPHERD, ROBT., Esq., Rochdale . . .	900	0 0
1876—SHEPPARD, FREDERICK, Esq., Folkington, Sussex (Free of Duty) . . .	2,000	0 0
1882—SHEW, Mrs. EMMA, South Kensington . . .	43	9 8
1868—SILVER, THOMAS TEMPLE, Esq., Woodbridge (Ditto) . . .	650	0 0
1868—SINCLAIR, DAVID, Esq., Thurso (Ditto) . . .	100	0 0
1869—SINCLAIR, WILLIAM, Esq., Sowerby, York (Ditto) . . .	138	18 3
1874—SKURRAY, W. H., Esq., Leamington . . .	1,155	12 4
1868—SLADE, FELIX, Esq., Lambeth (Free of Duty) . . .	300	0 0
1866—SMALL, Mrs. SARAH, Brighton . . .	76	7 6
1865—SMITH, Miss ANN FRANCES, Greenwich . . .	50	15 0
1875—SMITH, JOHN, Esq., Hull (Free of Duty) . . .	200	0 0
1867—SMITH, Mrs. MARY ANN, Greenwich (Ditto) . . .	1,000	0 0
1875—SMITHEMAN, JOHN, Esq., Hertford . . .	90	0 0
1883—SOARE, W. H., Esq., Chelsea . . .	452	2 10
1880—SOMERVILLE, Miss MARTHA CHARTERS, Genoa (Free of Duty) . . .	2,500	0 0

[Continued.]

LIST OF PAID LEGACIES—*continued.*

	<i>Amount received.</i>		
	£	s.	d.
1864—SPENCER, RICHARD, Esq., Gower Street	180	0	0
1880—SPURRELL, Miss CHARLOTTE, Brampton, Norfolk	90	0	0
1882—STAMP, Mrs. A. G., Kingston upon Hull	45	0	0
1881—STANFORD, J. F., Esq., North Bank, Regent's Park	4,500	0	0
1878—STANTON, J. J., Esq., Meadowcroft, Lewisham	107	8	10
1874—STANNAH SAMYNTAS, Esq., Gower Street	450	0	0
1873—STANTON, WILLIAM, Esq., Bramly Wharf, Surrey	473	17	5
1875—STEAD, Mrs., Helensburgh (Free of Duty)	100	0	0
1876—STONE, RICHARD, Esq., Uleceby, Lincolnshire	101	11	1
1866—STORY, Mrs. MARY ANN, Kensington (Free of Duty)	500	0	0
1870—STUART, CHARLES, Esq., Norfolk Street (Ditto)	200	0	0
1865—STUBBS, THOMAS, Esq., Hulme, Manchester (Ditto)	500	0	0
1869—STURM, JAMES, Esq., High Holborn (Ditto)	500	0	0
1882—SUTHERLAND, Mrs. A., Upper Norwood (Free of Duty)	10	9	2
1865—SYKES, Capt. JOHN, R.N., Bolsover Street (Ditto)	100	0	0
1878—SYKES, Mrs. ANN ELIZABETH, Butharlyp, How Grasmere (Ditto)	600	0	0
1881—"T. J. M." (Ditto)	400	0	0
1871—TANCRED, J. J., Esq., Pearville, Co. Dublin (Ditto)	1,350	0	0
1866—TAYLOR, THOMAS TRAVERS, Esq., Southport (Ditto)	500	0	0
1879—THOMAS, Miss LOUISA, Bowden, Chester	900	0	0
1881—THOMAS, Mrs. FANNY E., Nunney, Somerset	25	19	10
1874—THOMPSON, JOHN, Esq., Nottingham (Free of Duty)	500	0	0
1859—THOMPSON, Mrs. ANN, Greenwich	82	8	1
1865—THORNTON, RICHARD, Esq., Old Swan Wharf (Free of Duty)	2,000	0	0
1875—TOMPKINSON, THOS., Esq., Bath	90	0	0
1882—TORKINGTON, OSGOOD, Esq., Clapham Park (3 per cent. Consols, Free of Duty)	995	0	0
1882—TOWER, Miss JANE, Edinburgh	25	2	1
1881—TRAVIS, Miss ANNE, Moston, Lancaster	31	10	9
1866—TRAVIS, SAMUEL, Esq., Cheltenham (Free of Duty)	100	0	0
1873—TREDWELL, Wm., Esq., Handsworth, Staffordshire (Ditto)	105	0	0
1878—TROWELL, Wm., Esq., Fletton, Hunts (Ditto)	100	0	0
1869—TUCKETT, Miss LUCRETIA, Osnaburgh Street (Ditto)	100	0	0
1880—VANDELEUR, RICH. J. O., Esq., Dublin	448	19	0
1863—VENABLES, THOMAS ARUNDEL, Esq., Worcester	450	0	0
1872—WALDRON, Miss MARIA, Trowbridge (Free of Duty)	100	0	0
1867—WALKER, CHARLES, Esq., Southport (Ditto)	100	0	0
1882—WALKER, GEO., Esq., Southport (Free of Duty)	3,100	0	0
1870—WALKER, Miss MARY, Coates, N.B. (Ditto)	500	0	0
1869—WALKER, Mrs. MARY ANN, Onslow Square (Ditto)	500	0	0
1879—WALLACE, Wm., Esq., Curtain Road, Shoreditch	550	19	4
1872—WALMESLEY, Mrs. C. E., Connaught Square (Free of Duty)	300	0	0
1869—WARNER, Mrs. ANN, Lyncombe, Somerset	224	10	0
1869—WARNER, Miss ELIZABETH SOPHIA (Free of Duty)	350	0	0
1876—WATKINS, Capt. W., R.N., Croydon (Free of Duty)	100	0	0
1882—WATSON, HORACE, Esq., Wimbledon (Free of Duty)	200	0	0
1871—WATSON, Mrs. ELIZA, Loughton, Essex (Ditto)	100	0	0
1861—WATSON, Mrs. WILHELMINA, Berwick-on-Tweed	450	0	0
1864—WEBSDALE, W., Esq., Ipswich (Ditto)	79	16	0
1880—WEDGWOOD, Miss S. E., Down, Kent (Ditto)	100	0	0
1862—WEST, Dr. CHARLES TURNER, Hull	90	0	0
1879—WEST, RICHARD THORNTON, Esq., Streatham Hall, Exeter (Free of Duty)	500	0	0
1864—WHEELHOUSE, G., Esq., Deptford (Ditto)	260	0	0
1880—WHITE, Mrs. ANN, Brockley	90	5	0
1877—WHITTINGHAM, Mrs. J. P., Manchester Street, Manchester Square	303	4	4
1875—WILLIAMS, Mrs. ROBINA, Edinburgh (Free of Duty)	1,000	0	0
1877—WILLIAMS, C. T. LLOYD, Esq., Cheltenham	540	0	0
1882—WILLIAMSON, Mrs. A., Manghold, Isle of Man, (Free of Duty)	100	0	0
1870—WOOD, Miss MARY ANN, Bath (Free of Duty)	100	0	0
1877—WOOD, GEORGE, Esq., Chelsea (Ditto)	1,000	0	0
1875—WOODBURN, Miss MARY FRANCES, Kensington Park Gardens	270	0	0
1875—WOODHOUSE, Mrs. S. D., Upper Grosvenor Street (Free of Duty)	127	13	3
1880—WOODWARD, Miss MARY, Sproughton, Suffolk (Ditto)	1,500	0	0
1879—WOODWARD, Miss SARAH, Oldham Place	1,800	0	0
1879—WRIGHT, Miss M. A., Cottingham, York	2,688	19	0
1882—WRIGHT, Mrs. E., Southport (Free of Duty)	700	0	0
1875—WRIGHTSON, Mrs. C. R., York	180	0	0
1875—YATES, Mrs. HANNAH, Sheffield	900	0	0
1882—YOUNG, Major ROBERT WALKINSHAW, Dunmore, Kirn, N.B.	250	0	0

LIST OF DONATIONS AND ANNUAL SUBSCRIPTIONS.

* * Donations of £5 and under are omitted after having been published *once* in the Report.

HER MOST GRACIOUS MAJESTY THE QUEEN (Annual, £50) (1853) £100 0 0
 HIS ROYAL HIGHNESS THE PRINCE OF WALES, K.G. 135 0 0

	Ann. Subs.		Donations.			Ann. Subs.		Donations.	
	£.	s.	£.	s.		£.	s.	£.	s.
A. A. R., Altnaskiah (1882)			10	0	Addison, Mrs. (New Brighton)	2	2		
A. B., Penryn (1872-81)			10	0	Agar, W. T., Esq. (1870-80)			30	0
A. C., Croydon (1859-82)			130	0	Aldam, William, Esq.	1	0		
A. C., In Memoriam (1871)			20	0	Alexander, Jas., Jun., Esq. (1880)			10	10
A. C. S. (1875)			10	0	Alexander, T. H., Esq. (1873-5)			21	0
A. D. M., Mrs., born Hawkins, in memory of two Officers Indian Army (Madras), Hawkins and Spinks (many years deceased) (1876)			1,000	0	Alexander, The Misses	1	1		
A. F. D. B. (1882)			5	0	Allen Bros. and Co., Messrs.	1	1		
A. H. (1883)			1	1	Allen, C. F. R. Esq. (1869-76)			10	0
A. L., Cheltenham (1863-82).			95	0	Allen, Francis, Esq., Alexandria	5	0		
A. L., Putney	1	1	0		Allen, Hanbury, & Co. Messrs.	1	1		
A. L., A. W., M. W., and A. A., Wimbledon (1877-81)			56	4	Allen, J., Esq., Cornhill	1	1		
A. M. B. (1877)			10	0	Alloa Branch (1883)			54	0
A. S. W. (1875-82)			51	10	Alrutz, & Co., Messrs.	1	1		
A Friend (1872)			15	0	Alston, Hamilton, & Co. Messrs.	1	1		
A Friend (1882)			7	10	Ames, A. M., Esq., Bow (1881-3)			2	0
A Friend (1883)			1	0	Amor, Edward, Esq. (1882)				0
A Friend at Crewkerne (1883)			2	0	Amos, Robt., Esq., Texas, U.S.	1	0		
A Friend at Leeds (1883)			0	11	Amphlett, Rev. J.	1	1		
A Friend at Leominster (1869-78)			37	0	Anderson, C. A., Esq., Waverley Abbey	2	2		
A Friend at Llangollen			1	0	Anderson, Miss E., Woolwich (1882)			0	10
A Friend, per Mr. J. C. Mills (1883)			5	0	Anderson, Mrs. J., Dalhousie	2	0		
A Friend, per Geo. Smith, Esq. (1883)			2	0	Anderson, Robt., Esq., Ar- broath			1	1
A Friend, per Mrs. L. Hayes (1882)			5	0	Andrina, V., Austrian barque, Under- writers of the cargo of the (1879)			26	5
A Friend, per Messrs. Woodhead & Co. (1883)			1	1	Anelay, Mrs. M., The Grove	1	1		
A Friend, per "Punch" newspaper (1883)			5	0	Angle, B. J., Esq.			1	1
A Lady, further in aid of Whitburn Life-boat (1883)			50	0	An old Sailor, Native of Faversham, now of Canada (1875)			40	0
A Lady, per J. B. Parker (1863-73)			135	0	Anonymous	1	1		
A Lady, per W. H. Moore, Esq. (1876)			10	0	Anonymous (1872)			10	0
A Lady (1880)			20	0	Anonymous (1873-4)			10	0
A Mother whose Son was Lost at Sea (1869-74)			12	0	Anonymous (1874-6)			350	0
A Shipowner, Greenock			5	0	Anonymous, per Messrs. Coutts & Co. (1883)			26	5
A Thank-offering for safe return of Sons from long Voyages (1874)			10	0	Anonymous, Taunton (1882)			5	0
A Thank-offering from F. R. A. (1879)			100	0	Anonymous, "W." (1878)			100	0
A Thank-offering from G. A. N. (1882)			10	0	Anson, Miss, Chester (1875-81)			35	0
A Thank-offering from T. H. L. (1867-76)			54	0	Antrobus, Hugh Lindsay, Esq., Treasurer (1878)			10	10
A Thank-offering ("Let not the deep swallow me up") (1871)			25	0	Antrobus, Miss C. H. (1865-79)			17	4
A Well Wisher and Regular Subscriber (1880)			30	0	Ditto	2	0		
Aberdeen Branch (1883)			39	10	Appach, T. H., Esq. (1880)			31	10
Ackers, Mrs., Moreton			5	0	Arbroath Branch (1883)			8	18
Acland, Sir T. Dyke, Bart., M.P. (1875)			10	0	Archer, J., Esq.	1	1		
Acocks Green, Yardley, and Olton Branch (1883)			41	11	Ardrossan Branch (1883)			5	0
Acton, Miss, Teston (1879-82)			6	10	Arkwright, J. C., Esq.	1	1		
Adam, Messrs. John and James and Co.			1	1	Armitage, E., Esq., R.A.	1	1		
Adams, A., Esq., Skelwith			0	10	Armitage, Miss H., Bath	1	1		
Adams, Edgar T., Esq., Hal- stead			1	1	Armourers & Braziers, Wor- shipful Company of (1883)			10	10
Adams, Mr. J., Brecknock Rd.			0	10	Armstrong, Henry, Esq.	1	1		
Adams, R., Esq., St. Ives			1	1	Armstrong, Sir W. G., F.R.S.	1	1		
Adamson & Co., Messrs. D., Blyth			1	0	Artill, J. D., Esq.	0	5		
Addington, Mrs. Henry (1873)			10	0	Ash, Hy., Esq., Weston	0	10		
					Ash, W., Esq., Weston	0	10		
					Ashby, Capt. G. A.	1	1		
					Ashby, James, Esq.	0	10		
					Ashmole, Wm., Esq., Ilford	1	1		
					Ashwood, John, Esq.	1	1		
					Askew, Miss E. (1882)			5	0
					Astell, Mrs. H. D. (1866-73)			13	10
					Astley, Miss, Princes Gardens	2	0		

	Ann. Subs.		Donations.			Ann. Subs.		Donations.	
	£.	s. d.	£.	s. d.		£.	s. d.	£.	s. d.
Atkinson and Co., Messrs.	2	2	0		Barrow, A. M., Esq.	1	1	0	
Atkinson, G. C. W., Esq.	2	2	0		Bartle, W., Esq., Grimsby (1883)	5	0	0	
Atkinson, Lieut.-Col. Ralph (1873)			10	0	0	Barton, Bertram F., Esq. (1873-81)	21	0	0
Atkinson, W., Esq., Becken-					Barton, Daniel, Esq. (1868-73)	20	10	0	
ham	1	1	0		Barton, Mrs. Hope (1881)	15	0	0	
Attwell, T. M., Esq.	1	1	0		Bastard, T. Horlock, Esq.	1	0	0	
Auerbach, Emil, Esq.	1	1	0		Bates, Colonel Robert	1	1	0	
Auldjo, Henry, Esq., Cowes (1851-83)			51	19	0	Batey, Chas., Esq., Haggerston (1883)	1	1	0
Austin, F., Esq., Aubert Park (1880)	10	0	0		Bath Branch (1882)	20	4	0	
Austin, G., Esq., London St.	1	1	0		Batho, W., Esq., Amesbury	1	1	0	
Austin, Mrs.	1	0	0		Batten and Edwards, Messrs.	1	1	0	
Ayacanora (1882)			5	5	0	Batten, Messrs. J. and I. & Co.	1	1	0
"Aye Ready," per "Punch" newspaper					Battersea Chapel Sunday School	1	1	0	
(1883)	10	0	0		Batthyany, Count Edmund	1	0	0	
Ayr Branch (1883)	10	0	0		Bax, H. A., Esq.	1	5	0	
					Baxter, J. G., Esq.	1	1	0	
B. H. C. (1872-82)	110	0	0		Bayley, B. S., Esq., Demerara	1	1	0	
B. S. (1882)	20	0	0		Bayley and Ridley, Messrs.	1	1	0	
B. Y.	1	1	0		Baylis, T. C., Esq.	2	2	0	
Backhouse, James E., Esq.	5	0	0		Bayly, Miss, Plymouth (1875)	10	0	0	
Bacup Co-operative Stores (1868-82)	145	0	0		Bazett, Lieut.-Col. C. G. (1867-79)	12	0	0	
Badley, Mrs. Laura E., Horse-					Beach, Messrs. E. & Co.	1	1	0	
ley House	2	2	0		Beaumont, G., Jun., Esq.	1	1	0	
Badcock, H., Esq.	1	0	0		Beaumont, Mrs., Durham Ter.	0	10	6	
Badcock, H. J., Esq.	0	10	0		Beckett, Rev. W. P., B.A.	0	10	0	
Bagehot, T. W., Esq. (1878)	50	0	0		Beckett, James, Esq., Senr., Rath-				
Bailey, E., Esq., Berners St.	1	1	0		mines (1876-8)	20	0	0	
Bailey, E. H., Esq., ditto	1	1	0		Beddoes, Mrs. C. C.	1	1	0	
Baillie, Mrs. E. F., Leicester	1	1	0		Beddoes, Miss A. F. E.	2	0	0	
Baily, Miss A. L., Sudbury	1	1	0		Bedford, Henry, Esq.	1	1	0	
Baily, Miss E., ditto	1	1	0		Beech, Chas., Esq., Eaton Pl.	1	0	0	
Bainbridge, E. M., Esq.,					Beech, W. T., Esq., Balham	2	2	0	
Eshott Hall	1	1	0		Begbie, T. S., Esq.	0	10	6	
Baines, Charles J., Esq.	1	1	0		Begley, Mrs., Hammersmith (1862-79)	21	0	0	
Baker, John, Esq., Clapham	1	0	0		Belcher, Lady (1864-73)	12	6	0	
Baker, Mrs., ditto	0	10	0		Ditto	2	2	0	
Baker, Mrs. Hy., Cottayam (1881-2)	4	0	0		Belcher, Miss H.	2	2	0	
Baker, Rev. Sir T. H. B., Bart.	1	1	0		Belfast & Groomsport Branch (1883)	49	16	5	
Baldwin, Alfred, Esq. (1877)	10	10	0		Bell, Alex., Esq., Tooting	1	1	0	
Balézeaux, Captain Ed., In-					Bell, Messrs. Alexander, & Co.	1	1	0	
spector, French Lifeboat					Bell, Mrs. L.	1	0	0	
Society	1	1	0		Bell, Mrs. Mary, Maldon	1	1	0	
Balfour, John B. Esq. (1868-75)	10	14	0		Bellamy, Miss	2	2	0	
Balkwill, Robt. Coad, Esq.	1	1	0		Belli, W. H., Esq., The Court-				
Ball, John, Esq., Ilkeston	10	0	0		lands (1861-74)	31	2	0	
Ballard, George, Esq., the late, Resi-					Belper Branch (1883)	13	7	0	
duary Legatees of, per Mrs. Ballard					Belsham, J., Esq., Heybridge	0	10	0	
(1875)	50	0	0		Benecke, Otto A., Esq. (1873)	10	10	0	
Banff and Macduff Branch (1883)	25	0	0		Benetfink, S. A. & Co., Messrs.	0	10	6	
Banfield, R., Esq.	1	1	0		Benham, John, Esq.	1	1	0	
Bannatyne, C., Esq. (1880)	10	10	0		Bennets, Miss Olympia (1864-81)	55	0	0	
Bannatyne, Neil, Esq.	5	0	0		Bentinck, Lady (1874-81)	30	0	0	
Bannockburn Branch (1882)	11	7	3		Ditto	10	0	0	
Barber and Co., Messrs. J.	1	1	0		Bentley, Mrs. S. C., Croydon (1873-83)	45	0	0	
Barclay and Sons, Messrs.	2	2	0		Bentwich, Herbert, Esq.	1	1	0	
Baring Bros. & Co., Messrs.	5	0	0		Beresford, Mrs. L.	1	1	0	
Barker, F. C., Esq., Leigh (1871-83)	11	0	0		Berman's Charity, Trustees (1872-83)	136	10	0	
Barkworth & Spaldin, Messrs.	1	1	0		Berry, George, Esq.	0	10	6	
Barkworth, J. B., Esq., Hull (1873)	50	0	0		"Beta" (1882)	50	0	0	
Barkworth, Miss M., Tun-					Bettell, Wm., Esq., Brixton (1874-83)	31	10	0	
bridge Wells (1880)	50	0	0		Bevan, Geo. J., Esq.	1	1	0	
Barlow, Miss, Kersal	2	2	0		Beveridge, Capt.	1	1	0	
Barnard, Rev. Thomas (1879-80)	20	0	0		Bicknell, Percy, Esq.	1	1	0	
Barnard, Rev. Wm. (1878-9)	10	0	0		Bieber & Co., Messrs. (1882)	1	1	0	
Barnardiston, N. C., Esq.	1	1	0		Bigge, Francis E., Esq., Carl-				
Barnes, Mrs. (1881-3)	1	10	0		ton	1	1	0	
Barnett, Bros., Messrs.	2	2	0		Billingsley, Capt., R.N.	0	10	0	
Barnett, John, Esq. (1867-82)	70	0	0		Birch, Miss Eliza, Cheddar	1	1	0	
Barnett, Mrs., Meopham Court (1874-7)	20	0	0		Birch, Miss J. M. W., Neston	0	5	0	
Barningham, Thos., Esq. (1873-7)	20	0	0		Birch, J. W., Esq.	1	1	0	
Barr, Alex., Esq., Demarara	1	1	0		Birchall, J. Dearman, Esq.	1	1	0	
Barras, Mrs.	2	2	0		Bird, S. G., Esq.	1	1	0	
Barrett, Messrs. R. & Son	1	1	0		Bird, Thomas V., Esq., for the				
Barrington, R., Esq.	10	0	0		barque <i>Umgeni</i>	1	1	0	
Barron, F., Esq.	2	2	0		Birkbeck, Edward, Esq., M.P.,				
Barron, W. T., Esq.	1	1	0		V.P., Chairman (1861-83)	1097	5	0	

LIST OF DONATIONS AND ANNUAL SUBSCRIPTIONS.

85

	Ann. Subs.		Donations.			Ann. Subs.		Donations.	
	£.	s. d.	£.	s. d.		£.	s. d.	£.	s. d.
Birkenhead National Eisteddfod (1879)	50	0 0			Brettell, J. Vaughan, Esq.	1	1 0		
Birmingham Branch (1882)	66	10 6			Brettell, Mrs., Camden Square	1	1 0		
Birt, Messrs., Dock Street	4	4 0			Bridges, Capt. H. E. (1873)			20	0 0
Bischoff and Sons, Messrs.	1	1 0			Bridges, Mrs. H. W.	0	5 0		
Black, Alex., Esq. (1875)	50	0 0			Bridport Branch (1883)			8	15 6
Black, H. M. A., Esq., Demerara	1	1 0			Bridson, Josh., Esq., Winder- mere	2	0 0		
Blackburn Branch (1882)	16	9 7			Briggs, Major-Gen. W. L., C.B. (1879)	26	5 0		
Blackburne, Col. Wm.	1	1 0			Brighton Branch (1883)	18	7 8		
Blackwell, Samuel J., Esq.	2	2 0			Brinckman, Sir Theodore, Bart. (1878)	15	0 0		
Blake, T. N., Esq., Gosport	5	0 0			Bristol Branch (1883)	52	8 6		
Blakiston, John R., Esq.	1	0 0			Bristol Historic Club, in aid of the support of their Life-boat at Lossie- mouth (additional) (1883)	20	0 0		
Blakiston, M., Esq., Maberley	2	0 0			Bristol, The Marquis of	2	2 0		
Bland, Captain, R.N.	5	0 0			British Ship Owners' Com- pany (Limited)	5	5 0		
Blane, Capt. A. Rodney, R.N.	1	1 0			Britton, Mrs., Danby (1882)	50	0 0		
Blane, T. L., Esq., (1875-81)	35	0 0			Broadwood, Mrs., St. Leonards	2	2 0		
Blatch, F., Esq., Theale	2	0 0			Broek, Mrs. Osmond de Beauvoir	2	2 0		
Blathwayt, Rev. C. W., M.A.	1	1 0			Brocklehurst, Chas., Esq.	5	0 0		
Blenkinsop, B., Esq.	1	1 0			Brocklehurst, F. D., Esq. (1868-76)	18	3 0		
Bligh, Harbottle, and Co.	1	1 0			Brocklehurst, Wm. Walter, Esq.	5	0 0		
Blockley Branch (1882)	3	0 6			Broderip, Ed., Esq., Cossington (1883)	5	0 0		
Blow, W. W., Esq., Ryden's Rd.	1	1 0			Brogden, J., Esq., Charing Cross	1	1 0		
Boldero, Major-Genl.	1	0 0			Bromley, H. M., Esq. (1881-3)	3	1 0		
Bolton Branch (1883)	48	19 5			Bromley, Wm., Esq. (1881-3)	3	3 0		
Bonanty, Lieut.-Col.	1	1 0			Brook, Mrs. M.	1	1 0		
Bonner, F., Esq., Leicester (1883)	1	1 0			Brooke, John T., Esq., Haughton	1	1 0		
Bonsner, Mrs. (1873)	10	10 0			Brooke, Sir W. M. de Capell, Bart (1857-83)	225	0 0		
Boord, Mrs. Joseph, Stanley Gardens	1	1 0			Brooke, the Misses, sisters of the late John Brooke, Esq., Q.C., per John Richardson, Esq., Q.C., in addition to special gifts on behalf of Cahore, Giles Quay, Greencastle, Balbriggan, and Skerries Life-boats (1878-81)	290	0 0		
Booker, Mrs., Putney	0	5 0			Ditto in aid of Irish Life-boats (1881)	100	0 0		
Borough, J. C. B., Esq.	2	2 0			Brooks, Thomas, Esq.	1	1 0		
Borradaile, J. H., Esq. (1875-83)	21	0 0			Brooks, G., Esq., Laceby	2	2 0		
Borrer, Mrs.	0	10 0			Broughton, John, Esq., Poole	2	2 0		
Borwick, Alfred, Esq.	1	1 0			Brown, Bateman, Esq., Hunt- ingdon	1	1 0		
Bosanquet, Curtis, and Co. Messrs.	2	2 0			Brown, David, Esq.	1	1 0		
Boston Shipwreck Association (1865-83)	95	0 0			Brown, G. W., Esq., Houghton	1	1 0		
Ditto	5	0 0			Brown, George Gilpin, Esq., Sedbury Park (1874)	10	0 0		
Bouchier, Lady (1863-81)	25	0 0			Brown, James Clifton, Esq. (1868-79)	200	0 0		
Boulton, M. P. W., Esq.	2	2 0			Brown, Miss A. M., Sudbury	0	5 0		
Bourdillon, E. D., Esq.	0	10 0			Brown, Mr. H., Luton	1	0 0		
Bourne, John K., Esq.	1	1 0			Brown, the Misses, Luton	1	0 0		
Bourne, Miss A. S.	5	0 0			Brown, Shipley, & Co., Messrs.	3	3 0		
Bouts, T., Esq., Gracechurch Street	1	1 0			Browne, G. B., Esq., Preston	2	2 0		
Bowden, Mrs. (1883)	2	2 0			Ditto (1878-82)	601	0 0		
Bower, J. A., Esq.	1	1 0			Browne, G. H., Esq., Greenwich	3	3 0		
Bowles, H. C. B., Esq.	2	2 0			Browne, J. W., Esq., Frascati	2	2 0		
Bowling, Henry P., Esq., Sacombe	2	2 0			Browne, Lieut. A. G. F., B.S.C.	10	0 6		
Bowyer, George, Esq.	1	1 0			Browne, Mrs., Avenue Road	1	1 0		
Bowyer, Miss Mary	1	1 0			Browne, W. J., Esq., Kidwelly	1	0 0		
Bowyer, W., Esq., Buckden	1	1 0			Brumell, Mrs. M. E.	1	0 0		
Boyd, W. C., Esq.	1	1 0			Bruce, Henry, Esq.	1	1 0		
Boyd, Alfred, Esq., Barlaston Ditto (1883)	1	0 0	1	0 0	Bruno, Silva, & Son, Messrs. (1867-71)	26	5 0		
Boyd, E. F., Esq.	1	1 0			Brushfield, Mr. Richard	0	10 6		
Boyle, Vice-Adml. A.	2	2 0			Bryant, Arthur C., Esq.	5	5 0		
Boyton, F. R., Esq.	2	2 0			Brydges, Sir Harford Jones, Bart. (1857-78)	25	0 0		
Bracken, William, Esq. (1883)	5	0 0			Brymer, Miss (1877-8)	10	0 0		
Bradford Branch (1883)	155	1 4			Buckle, Capt. C. M., R.N.	1	0 0		
Bradford, Gen. Sir J. F., K.C.B.	1	1 0			Buccleuch, His Grace the Duke of, K.G.	10	10 0		
Bradford, Mrs. H. W.	1	1 0			Buchanan, Mrs., Edinburgh	1	1 0		
Bradford, Mrs. J. E.	1	1 0			Buckingham, Miss S. C. (1868-83)	35	12 0		
Bradshaw, Capt., R. A.	1	1 0			Buckle, Rev. John, M.A.	1	1 0		
Bramly, W. J., Esq.	1	0 0							
Bramwell, John, Esq., Ken- sington	2	2 0							
Brander, Mrs., Leamington (1880)	10	0 0							
Brassey, Albert, Esq. (1873)	100	0 0							
Brassey, H. A., Esq., M.P.	5	0 0							
Brassey, Sir Thos., K.C.B., M.P.	5	5 0							
Bray, T. B., Esq.	3	3 0							
Brayne, Charles Seymour, Esq.	0	10 0							
Brecks, L. C. & W.	1	0 0							
Brett and Co., Messrs.	0	10 6							

	Ann. Subs.		Donations.			Ann. Subs.		Donations.	
	£.	s. d.	£.	s. d.		£.	s. d.	£.	s. d.
Budge, Rev. H. S., B.A.	1	1	0		Carew, Capt. R. Pole	1	0	0	
Budgett, Messrs. J. & Son	2	2	0		Carey, S. W., Esq., New York, \$100 (1876)	18	16	4	
Budgett, James & Branth, Messrs. (1873)				21 0 0	"Caritas" (1883)			1 0 0	
Bulkeley, Miss Louisa, Brighton (1866-83)			195	0 0	Carlingford, the Right Hon. Lord	2	0	0	
Bullard, King, & Co., Messrs.	1	1	0		Carlisle, the Bishop of	1	1	0	
Bullock, Messrs. J. & G., & Co.	3	3	0		Carmarthen Bay Branch (1883)	10	0	0	
Bunbury, Sir Charles, Bart.	3	0	0		Carmichael, Sir W. G., Bart.	2	0	0	
Bunn, Mrs., Sydenham	2	2	0		Carr, W. J., Esq.	1	1	0	
Bunn, Miss, Sydenham	0	10	6		Carrera, C. L., Esq.	1	1	0	
Burbidge, Pritchard, and Bartlett, Messrs.	1	1	0		Carson and Sons, Messrs. W. (1879)	10	10	0	
Burch, E. C., Esq.	2	0	0		Carswell, Morris, Esq., in memory of his wife (1880)	15	0	0	
Burden, Stephen, Esq.	1	0	0		Carter, Fredk., Surgeon-Major (1881-3)	6	0	0	
Burgess, the Misses	0	10	0		Carter, Rev. S. R., B.D. (1875)	10	10	0	
Burgoyne, Montagu, G., Esq.	2	2	0		Cartwright, Col. H.	1	1	0	
Burgoyne, Thos., Esq. (1871)			10 10 0		Cartwright, Capt. K. Norton	1	0	0	
Burkitt, Rev. Jas., M.A.	0	5	0		Cartwright, Miss, Bury St. Edmunds (1862-81)	150	0	0	
Burmester, Miss	1	1	0		Cartwright, Mrs., Norwich	1	1	0	
Ditto (1881)			52 10 0		Cassell, Smith & Co., Messrs.	1	1	0	
Burnell, W. A., Esq., Southwell	1	1	0		Cator, Miss S. H. Bertie (1861-73)	18	13	0	
Burnett, D. W., Esq.	0	5	0		Ditto	1	1	0	
Burnett, E. L., Esq.	1	1	0		Cator, Mrs. Wm. A.	1	1	0	
Burnett, W. H. W., Esq.	1	1	0		Causton, Sir J., & Sons	1	1	0	
Burr, D. Higford D., Esq.	2	0	0		Cave, B., Esq., Wigmore St.	0	10	6	
Burrell, H., Esq., Gravesend	1	1	0		Cave, L. T., Esq.	5	0	0	
Burrell, Hy., Esq., Castle Grey	2	2	0		Cave, Lady (1881)			5 5 0	
Burton-on-Trent Branch (1883)			61 5 9		Cave-Browne-Cave, Mrs. Edward F.	2	2	0	
Burton, W. Hally, Esq.	1	1	0		Cave, W., Esq., Wigmore St.	0	10	6	
Busfield; Major	1	1	0		Chads, Admiral	1	0	0	
Busfield, Mrs., South Cave	1	1	0		Chadwick, Mrs.	1	1	0	
Busk, Mrs. (1869-78)			27 4 0		Chalmers, Guthrie, and Co. (1871)	10	10	0	
Butcher, Mrs. M. A., Islington, towards support of Margate and Yarmouth Life-boats (1873)	200	0	0		Chalmers, Sir David, Demerara	1	1	0	
Butler, C., Esq., Drury Lane	0	10	0		Chamberlain, Herbert, Esq.	2	2	0	
Butler, Paul, Esq. (1873-4)			11 0 0		Chamberlain, Miss C.	1	1	0	
Butler, S., Esq., Fen Court	2	2	0		Chamberlain, Richard, Esq.	1	1	0	
Butlin, C., Esq., Nottingham	1	1	0		Chamberlain, Capt. Tankerville J. (1870-9)			12 2 0	
Butlin, Thomas, Esq.	0	10	0		Ditto	1	0	0	
Butterworth, Edward, Esq. (1878)	20	0	0		Chamberlayne, Walter C. J., Esq. (1883)	2	2	0	
Buxton, Fras. W., Esq. (1874)	10	0	0		Champion, F. C., Esq.	1	1	0	
Byng, Admiral J. L.	1	1	0		Chaplin, E., Esq., Hamburg (1867-74)	26	5	0	
					Chapman, T., Esq., F.R.S.	21	0	0	
					Chardless, H., Esq. (1867-82)	48	19	0	
					Charles, Mrs., Finchley	1	1	0	
					Charlesworth, W. H., Esq. (1881)	10	0	0	
					Charley, E., Esq., Lisburn	0	10	0	
					Charley, Mrs., and Family, Dunmurry	1	0	0	
					Charrington, Miss E., Woodsleigh (1875)	10	0	0	
					Charrington, Miss M., Woodsleigh			2 0 0	
					Charteris, Lady Margaret	2	2	0	
					Chatterton, Mrs., Dublin	0	10	0	
					Chatterton, Miss J., Dublin	1	0	0	
					Chatting, Edwd., Hackney (1883)	1	1	0	
					Chavasse, Mrs. Horace	1	1	0	
					Cheape, G. C., Esq., Wellfield (1864-83)	72	0	0	
					Cheetham, H. J., Esq., Brooklyn	2	2	0	
					Cheltenham Branch (1882-3)			16 17 9	
					Chester, C., Esq.	5	0	0	
					Chetwynd, The Viscount	1	0	0	
					Chetwynd, Major the Hon. C.C.	1	1	0	
					Chichester and Selsey Branch (1883)	50	0	0	
					Child and Co., Messrs.	2	2	0	
					Childers, Rt. Hon. H.C.E., M.P.	1	1	0	
					Childers, Miss L.	1	1	0	
					Cholmondeley, The Marquis of	2	2	0	
					Chorlton, Isaac, Esq., Withington	1	1	0	
					Christy and Co., Messrs., Gracechurch Street	1	1	0	
					Christie, Mrs. (1878)			10 10 0	
					Chudleigh, Mrs.	2	2	0	

C., Mrs. M. L., South Australia, "In grateful remembrance of her merciful preservation from imminent dangers by sea in 1862" (1866-82) . . . 140 0 0
 C. S. and G. S. (1874) . . . 11 0 0
 C. T. (A Seaman's Daughter, produce of her Needlework) (1864-72) . . . 60 0 0
 Cain, Geo., Esq. 0 5 0
 Cain, Miss, Edmonton 0 5 0
 Caldwell, J., Esq., Starcross (1878) . . . 100 0 0
 Campbell, Arthur E., Esq. (1871) 50 0 0
 Campbell, C. M., Esq., Stoke 2 2 0
 Campbell, Mrs. Emma R., Carlisle 1 1 0
 Cambridge Branch, per Capt. Going, R.N. (1883) 12 13 3
 Cameron, Lady Vere (1882) 20 0 0
 Candler, P. W., Esq. 2 0 0
 Ditto (1872-5) 40 0 0
 Cann, James, Esq. 1 1 0
 Capel, Frank C., Esq. 5 5 0
 Capel, J. D., Esq. 1 1 0
 Capel, Messrs. Arthur & Co. 1 1 0
 Carbutt and Co., Messrs. 1 1 0
 Cardale, Rev. E. T. 0 10 0
 Carew, Mrs. G., Mytton Hall 3 3 0
 Carew, Miss Elizabeth Louisa (1881) . . . 100 0 0
 Carew, Mrs. Hallowell (1870-81) 110 0 0

LIST OF DONATIONS AND ANNUAL SUBSCRIPTIONS.

87

	Ann. Subs.		Donations.			Ann. Subs.		Donations.			
	£.	s. d.	£.	s. d.		£.	s. d.	£.	s. d.		
Church and Son, Messrs.	0	10	0	0	Cooper, Cooper, & Co., Messrs.	1	1	0	0		
Church, Rev. G. L.	0	10	6		Cooper, J. E., Esq., Milford	3	3	0	0		
Civil Service Life-boat Fund, <i>vide</i> p. 106.					Coote, Thomas, Esq.	1	1	0	0		
Claris, Sydney, Esq. (1881)			15	15	0	Cordes, T., Esq., Bryn Glas	2	2	0		
Clark, W., Esq., Brompton	2	2	0		Cordwainers, Worshipful Com-						
Clarke and Rowe, Messrs.	1	1	0		pany of (1875)			21	0		
Clarke, H. M., Esq.	2	0	0		Cork and Queenstown Branch (1883)			30	0		
Clarke, Mrs. Cowden	1	1	0		Cornell, Geo., Esq., Oakland	1	1	0	0		
Clarke & Co., Messrs. Ste-					Cornell, R., Esq., Brockley	1	1	0	0		
phenson	2	2	0		Cornell, Samuel, Esq., Chelsea	1	11	6	0		
Clarke, Miss, Carlisle	2	0	0		Cornish-Bowden, Admiral W.	2	2	0	0		
Clayton, Colonel Fitz-Roy,					Corrie, Mackie, & Co., Messrs.	2	2	0	0		
Deputy Chairman	2	0	0		Corrie, Miss (1878-83)			6	6		
Clayton, C. H., Esq.	1	1	0		Corrie, A. J., Esq., Dunrod	2	2	0	0		
Clayton, F. S., Esq.	1	1	0		Corrie, Rev. E. S., in memory			0	10		
Clayton, T. W., Esq., Ryde (1859-73)			15	0	of E. B. C.			0	10		
Clegram, W. B., Esq., J.P.	2	2	0		Corscaden, Mrs., Holland Park	5	5	0	0		
Clerk, Major-Gen. H., R.A.	1	1	0		Corry, Miss, Stamford	1	1	0	0		
Clerke, Chas. L., Esq. (1882-3)			8	0	0	Coster, Capt.	1	1	0		
Clermont, Lord	2	2	0		Cotesworth, W., Esq.	1	1	0	0		
Clermont, Lady	1	1	0		Coupland, J. M., Esq., Tinsley (1859-71)			15	0		
Clifford, Messrs. C. & Son	1	1	0		Courage and Co., Messrs. (1859-80)			50	0		
Clifford, Colonel, and Lady	2	0	0		Court, A., Esq., R.N.	0	5	0	0		
Clifford, Rev. John (1878-82)			3	2	0	Court and Co., Messrs.	0	5	0		
Clinton, Lady Charlotte P.	1	1	0		Courtenay, Messrs. J. & W. J.	2	2	0	0		
Cloid, Routledge, and Co.,					Courtenay, Miss, Brompton (1880)			50	0		
Messrs.	2	2	0		Courthope, G. C., Esq.	1	1	0	0		
Clothier, Mrs., Highgate (1881-3)			2	1	0	Ditto, in aid of Sussex					
Clothworkers, Worshipful					Life-boats			1	0		
Company of (1855-82)			178	0	0	Courtney, Mrs., Exmouth	1	1	0		
Clough, Hugh C.B., Esq. (1880)			10	0	0	Coutts and Co., Messrs.			10		
Clowes, R., Esq., the late, Stockwell			19	19	0	Covent Garden Life-boat Fund, <i>vide</i> p. 106.					
(1861-82)						Cowie, T. S., Esq. (1863-74)			21		
Clutterback, Mrs. C. F.	2	2	0		0	Cowie, Mrs., in remembrance of little					
Coal Factors' Society	5	5	0		Alfred's 16th birthday (1883)			1	1		
Coal Merchants' Society	5	5	0		Ditto, Maister and Miss (1883)			0	10		
Coates, James, Jun., Esq., Paisley (1874)	20	0	0		0	Cowper, Edw. Alfred, Esq., C.E.	1	1	0		
Coates, Jos., Esq., North Bank	1	1	0		0	Cox and Co., Messrs.			5		
Cock, Miss E. A. (1868-83)			80	0	0	Cox, Henry, Esq., Treverreux (1864-77)			50		
Cockey, E., Esq., & Mrs., Frome	0	10	0		0	Cox, Miss, M.A.	1	1	0		
Codd, Admiral	1	1	0		0	Cracklow, General	2	0	0		
Cole, A. C., Esq., Lee	1	1	0		0	Cranfield, Wm., Esq.	1	1	0		
Coleman, Capt. G.	1	1	0		0	Craven, Miss S.	0	10	0		
Coleman, Rev. W. (1868-82)			8	0	0	Crawley, Edmund, Esq.	0	5	0		
Coles, J., Esq., Throgmorton					0	Crawley, Mrs. G., Spratton (1877-82)			4		
Street	1	1	0		0	Crew, N. C., Jun., Esq. (1883)			0		
Coles, Miss A., West Hove	0	10	6		0	Crichton, Alexander, Esq. (1864-71)			10		
Collet, W. W., Esq.	1	1	0		0	Croggon & Co., Messrs. T. J.	1	1	0		
Collie, Dr. G. D. Milne	1	0	0		0	Crosbie, Rev. Howard A.	2	0	0		
Collier, Messrs. F. H. & A.	1	1	0		0	Crosse, Mrs. St. Croix	1	1	0		
Collin, J., Esq., Lewisham	1	1	0		0	Crosse & Blackwell, Messrs.	5	5	0		
Collin, Miss, Store Street	2	2	0		0	Crossley, Messrs. John & Sons					
Colling, Joseph, Esq., Islington (1875)	10	10	0		0	(Limited), Halifax			10		
Ditto	1	1	0		0	0	Crowley, J. S., Esq., Croydon	1	1	0	
Collingwood, Miss M. A.	1	1	0		0	0	Croxall, R. F. T., Esq.	2	2	0	
Collinson, Admiral Sir R.,					0	0	Cruddas, Charles J., Esq.	1	1	0	
K.C.B.	1	1	0		0	0	Cruddas, W. D., Esq.	1	1	0	
Collinson, Miss A. M., Weston (1865-83)	70	12	0		0	0	Crum-Ewing, J. D., Esq.	1	1	0	
Colonial Company (Limited)	2	2	0		0	0	Cuff, Miss (1872-81)			50	
Colthurst, G. E., Esq.	0	10	0		0	0	Cullimore, D., Esq., Monkstown	1	0	0	
Colville, Colonel (1873-82)			2	10	0	0	Cullingford, W. H., Esq.	2	2	0	
Colville, Lord	2	2	0		0	0	Cumberlege, Miss A. T.	1	0	0	
Colvin, Miss E. H.	2	2	0		0	0	Cumming, Mrs., Delamere Terr. (1879-82)	4	4	0	
Commeine, Thomas, Esq.	0	10	0		0	0	Canard Steam Ship Co. Limd.	10	0	0	
Commercial Steamship Co.	5	5	0		0	0	Cannyngame, Hugh, Esq. (1864-81)	67	0	0	
Commercial Union Assurance					0	0	Curling, Miss Martha, Cam-				
Company (1879)			10	10	0	0	berwell (1874-83)			50	
Comptoir d'Escompte de Paris	3	3	0		0	0	Curme, Admiral C. T.	0	10	0	
Conlon, F. P., Esq., Lincoln	1	1	0		0	0	Curteis, Whitworth, and Co.,				
"Continental Daily Parcels					0	0	Messrs.	1	1	0	
Express"	1	1	0		0	0	0	Curtis, R. Mayne, Esq.	1	1	0
Copleston, Rev. W. C., M.A. (1878-82)	1	5	6		0	0	0	Curwen, Mrs. Ewing	1	1	0
Copley, Miss E. M. (1879-82)			5	2	0	0	0	Ditto (1883)			1
Cooch, Mrs.	2	2	0		0	0	0	Cutbill, W. J., Esq.	1	1	0
Coode, Sir John	1	1	0		0	0	0	Cutcliffe, John, Esq. (1882)			20
Cooke, Mrs. Martha (1865-71)			20	0	0	0	0	Cutler, Palmer, & Co., Messrs.	2	2	0

	Ann. Subs.		Donations.			Ann. Subs.		Donations.	
	£.	s. d.	£.	s. d.		£.	s. d.	£.	s. d.
D. E. C. (1883)			2	0 0	Domett, John, Esq., the late.	1	1 0		
Da Costa, Miss, Oxford Ter. (1875-80)	1000	0 0			Ditto (1881-2)			5	5 0
Daggett, Mrs. S. J.	1	1 0			Domville, Mrs. W. T., The	0	10 0		
Dalgety, Du Croz, and Co.,	2	2 0			Palace	1	1 0		
Messrs.					Domville, Sir J. G., Bart.				
Dallas, Sir George (1873-83)			47	0 0	Donaldson, George, Esq., New			23	2 0
Dalton, H., Esq., Tunbridge			27	0 0	Bond Street (1873-78)				
Wells (1874-83)			23	0 0	Donkin, R. S., Esq.	10	10 0		
Dalton, Mrs. H. (1874-83)					Douglas Branch (1883)			50	0 0
Dalton, Miss, Clapham	1	1 0			Dover Branch (1883)			10	0 0
Dalton, Miss Hannah, ditto.	1	1 0			Dowling, D. J., Esq., (1880).			10	0 0
Dalton, R. F. V., Esq.	1	1 0			Dowling, E. S., Esq.	1	0 0		
Daly, Hon. R.	1	0 0			Downes, Edward, Esq.	0	5 0		
Dand, J., Esq., Sutton	1	1 0			Downshire, Marchioness of	1	1 0		
Danson, Dr.	2	2 0			Doxat, Miss C., Furthoe House,				
Darling, Col. A.	1	1 0			Stony Stratford	0	10 6		
Darling, Mrs., Cromwell Rd.	5	5 0			Doyle, P. W., Esq.	2	2 0		
Darney, The Earl of	1	0 0			Draeger, A., Esq., Dulwich	2	2 0		
Dashwood, Charles E., Esq. (1881-2)			2	2 3	Drake, T., Esq. (1867-74)			14	0 0
Davey, Rev. Presbendary	0	10 0			Draper, John, Esq.	0	10 6		
Davies, M., Esq., East Cowes	0	10 0			Drapers, Worshipful Com-			31	10 0
Davies, Mrs.	0	5 0			pany of				
Davies, Miss, Mallow	0	5 0			Ditto (1877)			52	0 0
Davison, A., Esq.	0	10 6			Druce, Mrs. A. D., Streatham (1883)			10	10 0
Davison, Newman, & Co.	1	1 0			Drummond, Capt. Alfred M.	2	0 0		
Davy, F., Esq., Topsham	1	0 0			Drummond, Capt. C. G. A.	2	2 0		
Davy, Yates, and Routledge	1	1 0			Drummond, Lady E. E. F.	2	0 0		
Dawber, Robert, Esq.	1	1 0			Drummond, George F., Esq.	2	2 0		
Dawlish Branch (1883)			28	10 2	Drummond, Messrs.	10	0 0		
Dawson & Son, Messrs.	0	5 0			Drury, H. Dru, Esq.	1	0 0		
Dawson-Scott, Lt.-Col., R.E.	1	1 0			Drysdale, R.P., Esq., Demerara	1	1 0		
Day, John, Esq.	1	1 0			Duarte, Miss	5	0 0		
Day, Mrs. F.	1	1 0			Duberly, Mrs.	1	1 0		
Dayman, C. O., Esq.	3	0 0			Dublin Port and Docks Board	75	0 0		
Deacon, Messrs. E. and A.	1	1 0			Du Croz, F. A., Esq. (1882).			20	0 0
Deacon, W. M., Esq.	0	10 6			Dugdale, J. B., Esq.	2	2 0		
Dean, Albert A. & Co., Messrs.	1	1 0			Dugmore, Lieut.-Col.	1	1 0		
Dean, Rosser S., Esq.	1	0 0			Duncan, G., Esq., East India			5	5 0
Deane, Mrs., Chelsea (1879-82)			4	0 0	Avenue				
Deane and Co., Messrs., King					Duncan, John, Esq., Finchley	1	1 0		
William Street	1	1 0			Duncombe, G. T., Esq.	3	3 0		
Deans, Mrs., Stockwell	1	1 0			Dundee Branch (1882-83)			130	0 0
Debenham, T. N., Esq. (1879-82)			8	8 0	Dunman, Thos., Esq., Clovelly	1	1 0		
De Bruyn, Miss (1877-83)			9	7 0	Dunn and Co., Messrs. W.	1	1 0		
De Kantzow, Rear-Admiral					Dunn, Ernest H., Esq.	1	1 0		
H.P.	1	11 6			"Dunsappie" (1874)			10	0 0
De la Granja, The Marquis	1	0 0			Durham Branch (1883)			39	5 6
Dell, L., Esq., Felham Cres-					Durnford, Rev. Edmund	1	1 0		
cent	1	1 0			Durrant, Capt. F., R.N.	2	0 0		
Delme-Radcliffe, Comr., and					Dyas, Capt. R. H.	3	0 0		
Mrs.	2	0 0			Dyer, John, Esq., Blackheath	2	2 0		
Denison, Alfred, Esq.	2	2 0			Dyer, Wm., Esq.	3	3 0		
Denison, Lady	5	0 0							
Dennistown, A. H., Esq.	1	1 0			E. A. B. (1872-82)			30	0 0
Dent and Co., Messrs. E.	3	3 0			E. C., Lancaster Gate	1	0 0		
Dent, George, Esq. (1872-4)			10	10 0	E. C. (1872-5)			20	0 0
Ditto	1	0 0			Ditto, a Thank-offering (1876)			10	0 0
Dent, W., Esq., Streatham (1880)	100	0 0			E. C. W. (1869-82)			9	0 0
Deo Gratia (1882-83)	45	0 0			E. G. (1876-81)			21	0 0
Derby, Chas., Esq., Brighton (1881-83)	4	0 0			E. H. (1873)			10	0 0
Derby Branch (1883)	26	15 6			E. M. C.	5	0 0		
Desborough, C. J., Esq.	1	1 0			E. V. A. (1875-7)			45	0 0
Devall, Miss	0	10 0			Earle's Shipbuilding and En-				
Devey, The Misses	5	0 0			gineering Co., Limited	1	1 0		
Devitt and Hett, Messrs.	1	1 0			East, Sir Gilbert A. C., Bart.	5	0 0		
Devon Central Branch (1883)			34	8 9	Easton, John, Esq., M.D.	1	1 0		
Devon, H. C., Esq.	1	1 0			Eastwood, John F., Esq.	1	1 0		
Devon, The Earl of	2	0 0			Echalaz, Rev. Theophilus S.	1	1 0		
Dew, Rev. E. Parker, M.A.	1	1 0			Ecroyd and Sons, Messrs.	3	3 0		
Deykin, Mrs., Edgbaston	1	1 0			Eden, Mrs. Henry	2	0 0		
Dickson, Mrs.	2	2 0			Edinburgh, Leith, and Gran-			488	18 10
Dickson, Rev. W. R.	1	0 0			ton Branch (1882-83)				
Digby Commr. H. A., R.N. (1882-83)	10	0 0			Edwardes, T. D., Esq.	1	0 0		
Dixon, Mrs. R. R., Shilling-					Edwardes, J., Esq., Record Office	1	1 0		
thorpe	1	0 0			Edwardes, Miss L. E., Clifton	1	1 0		
Domecq and Co., Messrs. P.	1	1 0							

LIST OF DONATIONS AND ANNUAL SUBSCRIPTIONS.

89

	Ann. Subs.		Donations.			Ann. Subs.		Donations.	
	£.	s. d.	£.	s. d.		£.	s. d.	£.	s. d.
Edwards, Miss M. (1871)			50	0 0	Fanning and Co., Messrs. W.	1	1 0		
Edwards, S., Esq., Fenchurch Street	1	1 0			Fanshawe, Mrs. F., Uckfield	0	10 0		
Egan, T. Selby, Esq.	1	1 0			Fanshawe, Rev. Arthur A. (1872)	20	0 0		
Egerton, Mrs. M. A. F.	5	0 0			Fanshawe, Adm. Sir Edward G., K.C.B.	1	1 0		
Egerton, Miss G. C.	2	0 0			Farmer, Capt. Wm. R. G.	1	1 0		
Egerton, Rev. J. C., in aid of Sussex Life-boats	0	10 6			Farnell, Mrs., Colchester	1	1 0		
Ekins, Mrs. P. J.	5	5 0			Farquhar, Captain H.R., 24th Regt. (1865-74)			70	0 0
Elam, Miss	2	10 0			Fetherstonhaugh, C., Esq.	1	0 0		
Elder, L. L., Esq.	1	1 0			Feeny, John, Esq.	1	1 0		
Eldridge, J., Esq. (1883)			1	0 0	Fellows, C. F., Esq.	5	0 0		
Elias and Co., Messrs.	1	1 0			Felton, W. V., Esq. (1873)			10	0 0
Elias, Miss E., per "Punch" newspaper (1883)			1	1 0	Fenwick, Capt. John	1	1 0		
Ellen and Co., Messrs.	0	10 6			Fenwick, Mrs. S. C.		1 0 0		
Elliott, Geo., Esq., Croydon (1873-81)	15	0 0			Fenwick & Sons, Messrs. John	5	5 0		
Elliott, Sir Walter	1	0 0			Few, Rev. Charles E., M.A.	2	2 0		
Ellis, Mrs., Worksop (1877-83)	10	0 0			Field, Capt. E., R.N.	1	0 0		
Elliott, Mrs., Brighton	2	2 0			Field, Rev. Dr., Norwich (1883)			100	0 0
Elliott, Wm., Esq.	1	1 0			Field, J. P., Esq.	2	2 0		
Ellis and Sons, Messrs. H.	1	1 0			Figgis, Samuel, Esq.	2	2 0		
Ellis, Alderman Sir W., Bart.	1	1 0			Filliter, Freeland, Esq.	1	1 0		
Ellis, Capt., Lymington	2	0 0			Fincham, Miss		0 10 6		
Ellis, Mrs., Hampstead	1	1 0			Findlater, Mackie, and Co.	2	2 0		
Ellis, Miss, Hampstead	1	0 0			Findlay, Mrs. James, in aid of Scotch Life-boats	1	1 0		
Ellis, Mrs., Bognor	0	10 6			Finnis, Fisher, & Co., Messrs.	1	1 0		
Elwes, J. H., Esq.	2	0 0			Fisher, G. A., Esq.	2	2 0		
Ely, The Most Noble the Marquis of	20	0 0			Fishmongers, Worshipful Company of (1873)			105	0 0
Emery, William, Esq.	0	10 6			Fishwick, J. H., Esq. (1871-83)	13	12 0		
Emmerson, Mrs. Susan (1873-83)			9	7 0	Fishwick, S. E., Esq. (1875-83)			9	8 0
Engelhardt, L. A., Esq.	1	1 0			Fisk, Rev. G. H. R., Capetown	1	1 0		
English, Bros., Messrs.	1	1 0			Fisk, Rev. J. H. (1857-71)			45	0 0
English, Major, R.E.	1	0 0			Fitz-George, Major G.	1	1 0		
Engström, George, Esq.	1	1 0			Fitzgerald, E., Esq. (1883)			10	0 0
Entwistle, Mrs., Leamington (1881-82)	10	10 0			Fladgate, Mrs., Staines	1	1 0		
Enniskillen Branch (1883)			41	0 0	Fleetwood Branch (1883)			50	0 0
Epps, Jas., Esq., Norwood	1	1 0			Fleming, B. R., Esq., Down St.	5	5 0		
Erne, The Earl of, K.P.	1	0 0			Fletcher, W., Esq., Cheltenham		2 0 0		
Erne, The Countess of	1	0 0			Flood, Frederick, Esq.	5	5 0		
Ernsthausen and Oesterley, Messrs.	1	1 0			Ford, Miss (1880-2)			1	0 0
Esdaile, Mrs., Penge (1881-83)		1 5 6			Ford, Mrs., Croydon (1872-9)			12	5 0
Esse, F., Esq. (1877-82)		6 6 0			Foreman, Mr. Owen		0 5 0		
Essex & Colchester Branch (1882)	15	15 6			Foresters, Ancient Order of, vide p. 106.				
Estridge, Edward, Esq.	1	1 0			Forrester, Major-General	1	1 0		
Evans, Capt. Sir Fredk. J. O., R.N., K.C.B.	2	2 0			Forrester, Miss A. (1870-82)			55	0 0
Evans, E. P., Esq.	1	1 0			Forrow, B. A., Esq., and Edwin Taffs, Esq., Poplar (1874)			10	10 0
Evans, Mrs., Seymour Street	2	0 0			"For those in peril on the Sea" (1872-82)			51	10 0
Eversfield, C. G., Esq.	1	1 0			Fortnum, Mason, and Co., Messrs.	2	2 0		
Ewart, Macaughy, and Co., Messrs.	2	2 0			Foster, James L., Esq. (1875-81)			40	0 0
Ewart, Miss Mary A.	3	3 0			Foster, Rev. A. M.	0	10 0		
Ewart, William Lee, Esq.	10	0 0			Foster, Rev. Sir C., Bart.	2	2 0		
Ewing, W. Orr, Esq.	5	0 0			Foster, Richard, Esq.		5 0 0		
Exeter Branch (1883)			32	3 7	Foster, W. H., Esq., Northampton (1883)	10	0 0		
Exmouth Branch (1883)			20	0 0	Fothergill, The late Mr., per Mrs. Fothergill (1881)			50	0 0
Eyre, Rev. H. S.	1	0 0			Fowler, John, Esq., Sheffield (1874-7)	11	6 0		
Eyre, Mrs. Robert	0	10 6			Fox, Rev. G. T.	1	1 0		
F. G. R. (1878)			10	0 0	France, Thos., Esq. (1882)			5	0 0
F. P. H. (1871)			10	0 0	France-Hayhurst, Rev. T.	1	0 0		
Faber and Co., Messrs. A.	2	2 0			Francis, Mrs. A., Colchester	0	10 0		
Fair, J., Esq.	2	2 0			Francis, Mrs. Sarah, Quay Hall	1	1 0		
Fairbank, H., Esq., Willenhall	1	1 0			Franklyn, H. W., Esq.	2	2 0		
Fairthorne, E., Esq.	2	2 0			Fraser, E., Esq., Inch (1872-8)			35	0 0
Fairthorne, Miss A.	5	0 0			Fraser, Mrs., Manchester	2	2 0		
Fairthorne, Miss E.	1	1 0			Fraserburgh Branch (1883)			20	0 0
Fairthorne, Mrs., Slade End	0	10 6			Frazer, Miss Florence M.	1	1 0		
Falcon, Mrs. (1867-71)			15	0 0	Frazer, John, Esq., Cornhill	1	1 0		
Falcon-Steward, Rev. R. S.	2	2 0			Freeland, Messrs. J. and A. B.	1	1 0		
Falmonth, The Viscount	5	0 0			Freeling, Mrs. (1869-82)			46	4 0
Fane, W. D., Esq.	2	2 0			Freeman, C., Esq., Leamington (1874)	10	0 0		

	Ann. Subs.		Donations.			Ann. Subs.		Donations.	
	£.	s. d.	£.	s. d.		£.	s. d.	£.	s. d.
Freeman, Miss, Canterbury (1872-82)			55	0 0	Gomonde, Mrs. Anne, Pau (1864-82)			380	0 0
Freer, Rev. T. H., M.A.	1	1 0			Gonne, Edward, Esq.	1	1 0		
Freer, Leacroft, Esq.	1	1 0			Goode, Miss M. H. (1877-83)			3	10 0
French, B. F., Esq. (1880)			10	0 0	Goodenough, S. R., Esq.	1	0 0		
French, David, Esq. (1881)			10	10 0	Goodman, Miss M. (1869-83)			52	0 0
Freshfield, Miss	1	1 0			Goolden, Dr. Francis	1	1 0		
Fribourg and Trever, Messrs.	0	10 0			Gopsill, Brown & Sons, Messrs.	0	10 0		
Frith, Rev. Wm. A., M.A. (1871-82)			11	9 0	Gore, Miss E. E.	1	0 0		
Ditto	1	1 0			Gore, Rev. G. (1876)			10	0 0
Frost, Brothers, Messrs.	1	1 0			Gorell, Miss, Norwich (1881-82)			10	0 0
Fry, The Hon. Justice	2	0 0			Gorringe, Frederick, Esq.	3	3 0		
Fryer, Captain, Worthy Park	1	1 0			Gosling, Francis, Esq.	1	1 0		
Ditto (1880)			10	0 0	Gosling, General W. C. F., R.A.	1	1 0		
Fuller, Mrs. Trayton	2	0 0			Gosling, Mrs. Mary, Wyesham	1	1 0		
					Gotobed, Miss	2	2 0		
					Ditto (1873-6)			10	0 0
G., Thurloe Square	1	4 0			Goyeneche, J. V., Esq.	1	1 0		
G. B. (1872)			25	0 0	Graham, Col. Sir L., Bart.	2	0 0		
G. H. (1880-83)			10	0 0	Graham, Cyril C., Esq.	1	0 0		
G. J. A. (1872)			20	0 0	Grant, Miss Alice (1883)			10	0 0
G. L. (1877-83)			3	0 0	Grant, Messrs. J. and R. (1874)			21	0 0
G. R. B. (1877-83)			25	15 0	Grant, Henry, Esq., Fen- church Street (1882)			2	2 0
Gadsby, John T., Esq.	1	1 0			Grant, R., Esq., Leadenhall St. (1881)			21	0 0
Gairdner, Mrs., Ivy Lodge	1	1 0			Grant, Ed., Esq., Weedon	1	1 0		
Gale and Co., Messrs.	2	2 0			Grant, W. D., Esq., Leam- ington	1	0 0		
Galloway, Joseph, Esq.	1	0 0			Gray, Dawes, & Co., Messrs.	1	1 0		
Gambier, Admiral R. F.	1	0 0			Gray, Rev. C.	0	5 0		
Garden, Miss Emma (1858-82)			52	10 0	Green, Frederick, Esq.	1	1 0		
Garden, Mrs. (1863-72)			34	10 0	Green, J., Esq., Dover St.	1	1 0		
Gardner, Miss	1	1 0			Green, Joseph E., Esq.	1	1 0		
Gardner, F. G., Esq.	1	1 0			Greenock Branch (1883)			52	0 0
Gardner, Rev. T. J. C.	1	1 0			Greenway, Mrs., Myton	2	2 0		
Garrett, W. H., Esq.	1	1 0			Greenwood, John, Esq.	1	1 0		
Garrett, Mrs. W. H.	1	1 0			Gregory and Co., Messrs. F.	1	1 0		
Gas Light and Coke Company	10	0 0			Grey, Lady (1872-82)			55	15 0
Gatty, Mrs. Buckden	1	0 0			Ditto	1	0 0		
Gay & Co., York Road (1882)			3	3 0	Grice & Co., Messrs. W. (1862-83)			205	0 0
Gee, Mrs. Isabella, Aberdeen (1879)			17	10 0	Griffin, E., Esq., Oakley Square (1867-81)			62	11 0
George Hugh, Esq., Horncastle (1877-83)			6	2 0	Griffith, C. W. Darby, Esq.	1	0 0		
Gibb, B. D., Esq., Royal Exchange (1874)			10	10 0	Griffith, Sir G. Waldie, Bart.	3	0 0		
Gibb, Chas. J., Esq., M.D. (1871)			10	10 0	Griffith, J., Esq., Regent's Park			52	10 0
Gibb, Col. W. E. (1873-83)			11	11 0	Griffith, Mrs. (1881-83)			1	10 0
Gibb, T. Jones, Esq.	2	2 0			Griffiths, Tate, and Selby	2	2 0		
Gibbes, W., Esq.	1	0 0			Grindall, Mrs. Sturt (the late)	1	0 0		
Gibbs, A. E., Esq.	1	1 0			Gripper, John E., Esq.	1	1 0		
Gibbs, Geo., Esq., Junr. (1877-83)			7	7 0	Grocers, Worshipful Com- pany of (1877)			100	0 0
Gibbs, H. H., Esq.	2	2 0			Grosvenor, Capt. the Hon. Norman de l'A., M.P.	1	0 0		
Gibson, Dr. (1882)			5	5 0	Grosvenor, Chater, and Co., Messrs.	1	0 0		
Gibson, Mrs. (1873-82)			9	0 0	Grove, Chs. B., Esq., Callender	1	1 0		
Giesler and Co., Messrs.	3	3 0			Grove, Mrs., Bolton Row	1	1 0		
Gifford, J. B., Esq., Chard (1883)	1	0 0			Grove, Miss Chafyn	5	0 0		
Gilbert, J. A., Esq.	1	1 0			Gabbins, Mrs.	2	2 0		
Gill, John, Esq., Battersea	1	1 0			Gun Makers, Worshipful Com- pany of (1882)			20	0 0
Gillespies, Moffatt, and Co.	2	2 0			Gunning, Rev. Sir Henry, Bart.	0	10 0		
Gillett, W. S., Esq.	2	2 0			Gurdon, W., Esq. (1864-82)			30	0 0
Gilmour, Rankin, & Co., Messrs.	1	1 0			Guthrie, Mrs., in memory of the late Major C. O. James	5	0 0		
Girdlestone, Mrs. R. B., Ox- ford	1	0 0			Gwilt, Alfred, Esq.	1	1 0		
Gladstone, John E., Esq.	2	0 0			Gwilt, Mrs.	1	1 0		
Glasgow Branch (1883)			454	11 0	Gwilt, Mrs. Hannah Jackson (1877)			10	10 0
Glen, Joseph, Esq. (1873-9)			52	0 0					
Glennie, W. R., Esq., Wimbledon (1882)			5	0 0					
Glover Brothers, Messrs.	0	10 0							
Goddard, Miss, Addiscombe (1882)			5	5 0					
Godlee, Francis, Esq., Alder- ley Lodge	2	2 0							
Godlee, Mrs. R.	1	1 0							
Godman, General (1883)			2	0 0					
Godsal, P. W., Esq.	2	0 0							
Godwin & Son, Messrs., Poole	2	2 0							
Goff, Major R.	1	0 0							
Goldsmith, Admiral, C.B.	1	1 0							
Goldsmiths, Worshipful Co. of (1877)	150	0 0							
Goldsworthy, Col. (for 1881)			10	0 0					
Gollop, G. T., Esq.	2	2 0							
Gollop, Mrs.	1	1 0							
					H. and F. M., in aid of Hummersea, Whitby, or Staitbes Life-Boats (1875-6)	15	0 0		
					H. B., 2241 (1882)			10	0 0
					H. B. T. (1867-81)			12	0 0
					H. E. U., Bitterne (1874)			100	0 0
					H. M. (1877)			25	0 0
					H. R. (1871)			25	0 0

LIST OF DONATIONS AND ANNUAL SUBSCRIPTIONS.

91

		Ann. Subs.		Donations.				Ann. Subs.		Donations.			
		£.	s.	d.	£.	s.	d.	£.	s.	d.	£.	s.	d.
H. R. S. (1875).					10	0	0	Haswell, Vice-Admiral W. H.	1	0	0		
H. S. C. (1859-81)					500	0	0	Hatchett, Mrs. John	1	1	0		
Haarbleicher and Schumann	1	1	0					Hatherton, Lord	1	1	0		
Haberdasbers, Worshipful Company of (1878-80)					15	15	0	Hatton, Miss A.	0	10	6		
Hack, C., Esq., Poplar	5	0	0					Hawes and Hertz, Messrs.	0	10	0		
Hackett, Ausender, and Co. Messrs.	1	1	0					Hawker, Charles F., Esq.	1	1	0		
Hacon, The Misses	1	0	0					Hawkins, Clement, J., Esq.	1	1	0		
Haddington, The Earl of	1	0	0					Hawkins, Rev. Bradford D., the late, in memory of E. B. C.	0	10	0		
Haigh & Son, Messrs. W.	0	10	6					Hay, Adm. J. B. L.	2	2	0		
Halford, Lady	1	1	0					Hay, Adm. J. B. P.	1	0	0		
Hall, Mrs., (Woburn)	1	0	0					Hay, Mrs., Arnhall	0	10	6		
Hall, Mrs. Mary (Wigton)	1	1	0					Haycock, Miss H., Clifton	1	0	0		
Hall, Miss M. S.	0	10	0					Hayes, Mrs. L., New Hampton	2	0	0		
Hall, Miss, Whitechurch	1	1	0					Ditto (1877-80)	11	0	0		
Hall, Richard, C. Esq., Bath	2	0	0					Hayes, Lieut. M. R., R.N., The late, per Vice-Admiral Hayes, C.B. (1881)	10	0	0		
Ditto (1881-3)					3	0	0	Hayle Branch (1883)	10	0	0		
Hall, The Misses, Penge (1881-3)					0	15	0	Hayne, Chas. Seale, Esq., Eaton Square	1	0	0		
Hallam, C. T., Esq.	0	10	0					Haynes, Edmund C., Esq.	1	1	0		
Halsey, Mrs. (1881-3)					1	10	0	Hay's Wharf, Proprietors of	1	1	0		
Hambro & Son, Messrs. C. J.	1	0	0					Hayter and Hayter, Messrs.	1	1	0		
Hamilton, F. A., Esq.	10	10	0					Hayward, J. Fred., Esq. (1873-82)	51	15	0		
Hamilton, Rear-Admiral, C.B.	1	0	0					Head and Co., Messrs. H.	2	2	0		
Hamilton, Major T. B.	1	1	0					Headfort, The Marquis of	2	0	0		
Hamnick, W. M. Esq.	1	1	0					Hearne, T. P., Esq. (1869-81)	21	0	0		
Hand, Vice-Adm. G. S., C.B.	1	1	0					Heathorn, W., Esq., and Lady Priun	2	2	0		
Hankey, Capt. F. T. B., R.N.	1	0	0					Heath, Robert, Esq., St. George's Place	1	1	0		
Hankey, George, Esq.	1	1	0					Heatley and Son, Messrs.	1	1	0		
Hankey, Capt. Walter A. (1879)					10	10	0	Heaven, Mrs., Boconnoc (1883)	1	0	0		
Hankey, E. A., Esq., Elmhurst (1882-3)	100	0	0					Hemery, C., Esq.	0	10	6		
Hankey, Wm. Barnard, Esq.	1	0	0					Henckell, Du Buisson, and Co., Messrs.	2	2	0		
Hammer, Capt. J. G. J., R.N.	0	10	0					Henderson, Miss F., in memory of the late J. Henderson, Esq., R.N.	1	1	0		
Hanson, Mrs.	0	10	6					Heneage, Major	5	5	0		
Harcourt, Adm. F. E. Vernon	1	1	0					Henley-on-Thames Branch (1883)	9	14	7		
Hardie, Mrs. Peter, Bayswater (1874-8)	560	5	0					Henry, Lieut.-Col.	1	1	0		
Hardie, Thos. Kincaid, Esq., do. (1874-83)	70	5	0					Henty, C. P., Esq., Chichester	1	1	0		
Hardwick, Mrs. M. L.	1	1	0					Hepburn, Mrs. Emily M.	1	1	0		
Hardy, Mrs.	1	1	0					Herbert, Dennis, Esq.	1	1	0		
Hardyman, Miss C. J.	1	1	0					Herd, Mrs. J.	1	1	0		
Hare, Miss A. C., Stonehouse (1882)	1	1	0					Hereford, Miss Lucy, Mordiford	4	0	0		
Harker & Co., Messrs. G.	1	1	0					Herring, Messrs. G. & A., & Co.	1	1	0		
Harker, W., Esq., J.P. (1882)	1	1	0					Herring, Miss J. E.	1	0	0		
Harper, E. N., Esq.	1	1	0					Hertford, The Marquis of (1879)	10	10	0		
Harper, Henry L., Esq., Kensington (1882)					5	5	0	Ditto	2	2	0		
Harper, Mrs. Lewis, Kensington (1883)	5	0	0					Hetherington, John M., Esq. (1871)	115	10	0		
Harris, G. S. & P., Messrs.	1	1	0					Hewett & Co., Messrs. J. D.	2	2	0		
Harris, J., Esq., Thames St.	0	10	0					Hewetson, Thos. Esq.	1	1	0		
Harris, Miss, Clapton	1	1	0					Ditto (1873-82)	8	8	0		
Harris & Dixon, Messrs.	2	2	0					Hewitt, The Misses, Lytham (1873-82)	600	0	0		
Harrison, C. A., Esq., Lincoln	2	2	0					Heyland, Lieut.-Col. J. R. (1882)	1	0	0		
Hart, Henry, Esq., Rotherham	0	10	0					Heywood, E. S., Esq.	2	2	0		
Hartley & Co., Messrs. James	2	2	0					Hichens, A. K., Esq.	1	1	0		
Hartley, Jas. Robt., Esq. (1881)					10	10	0	Hickes, Miss C., Bath	1	0	0		
Harton, Samuel, Esq.	1	1	0					Hickes, Mrs. A. J., the late, per Miss Hickes, Bath (1875)	100	0	0		
Harton, W. H., Esq., V.P.	2	2	0		15	10	0	Hickman, Mrs. (1869-80)	12	11	0		
Harvey and Greenacre, Messrs. (1875-8)	15	0	0					Hickman, Miss (1869-79)	15	15	0		
Ditto					5	0	0	Ditto	1	1	0		
Harvey, Charles, Esq.	1	1	0					Higham, W. S., Esq.	1	0	0		
Harvey, H. M., Esq., Hexworthy (1866-83)	100	0	0					Hilhouse, Miss	0	10	6		
Harvey, Miss E. A., Ickwell	1	0	0					Hilhouse, Miss Harriet	0	10	6		
Harvey, the late Mrs. Alicia, Exors. of, Rev. G. M. Gorham and Rev. J. Holmes (1879)					20	0	0	Hill, F., Esq., Hampstead	1	0	0		
Harvey, Wm. Mascall, Esq. (1881)	5	5	0					Hill, Jas. D., Esq.	3	3	0		
Harvie, Miss Hannah (1877)	50	0	0					Hill, Lord Arthur William	5	5	0		
Harwood, Knight, and Allen, Messrs.	1	1	0					Hill, Major	1	1	0		
Haslam, Henry, Esq., Croydon	1	1	0					Hillman, Mrs. Clark	1	0	0		
Hassell, Mrs. C. G., Cheltenham	5	0	0					Hills and Underwood, Messrs.	1	0	0		
Hassell, Mrs. Susan, Stonehaven (1882)	1	1	0					Hills, E. H., Esq., Redleaf	2	2	0		
								Hills, F. C., Esq., Deptford	1	1	0		

		Ann. Subs.	Donations.			Ann. Subs.	Donations.		
		£. s. d.	£. s. d.			£. s. d.	£. s. d.		
Hills, F. Ernest, Esq., Redleaf	2	2	0	Howson, F. J., Esq.	1	1	0		
Ditto (1880)			15	0	0	Hoyland, Rev. J., Brierly	1	1	0
Hilton, Anderson, and Co., Messrs.	0	10	6	Hubbard, Colonel C. J.	1	0	0		
Hilton, Jas., Esq., Shawhall	2	2	0	Huddersfield Branch (1882-3)		106	6	0	
Hindley, W. H., Esq.	1	1	0	Hudson, Frank, Esq., Highbury	1	1	0		
Hinkley, Mrs., Derby	1	1	0	Hudson, Mrs. W.	1	1	0		
Hirsch, J. F. Esq.	0	10	0	Hudson, Thos., Esq.	1	1	0		
Hoblyn, J. B. P., Esq. (1869-82)	12	12	0	Hughes, Fredk., Esq., Reigate (1879-83)	7	0	0		
Hobson, Chas., Esq., Beverley	1	1	0	Hughes, H., Esq., Elm Park	0	10	6		
Hobson, Mrs., Taunton	1	1	0	Hughes, Miss, East Bergholt	1	0	0		
Hodd and Son, Messrs. R.	1	1	0	Hughes, W., Esq., Meole	1	1	0		
Hodgkinson, W. S., and Co., Messrs.	1	1	0	Hull Branch (1883)		100	8	10	
Hodgson, C. H., Esq., Belgrave Road	5	5	0	Hunt, C. Brooke, Esq.	1	0	0		
Hodgson, E. D., Esq., Temple	1	1	0	Hunter, John & Co., Messrs.	2	0	0		
Hodgson, F. C., Esq., Downing Street	1	10	0	Hunter, Mark William, Esq. (1872-82)	45	3	0		
Hodgson, F. W., Esq., Friday Street	1	1	0	Hunter, the Misses Harriet & Isabella, in memory of their mother (1881)	100	0	0		
Hogg, Mrs. Elizabeth, Gloucester Place (1883)	10	10	0	Hunwicke, F. S., Esq.	1	0	0		
Holden, E. T., Esq., Walsall	1	1	0	Hurst, J., Esq., Hull	1	0	0		
Holland, Commander S.C., R.N.	1	1	0	Hurst, T. G., Esq.	0	10	6		
Holland, Edmund, Esq., Hyde Park Square (1872-83)	41	15	0	Husey and Son, Messrs. R. A.	1	1	0		
Holland, Genl. Lumley H. (1882)	5	0	0	Hutchings, J., Esq., Alkincham (1883)	13	10	4		
Holland, Mrs. J. C., Pinner	2	2	0	Hutchins, Mrs., Portland Place	1	0	0		
Holland, The Hon. Mrs. F.	1	1	0	Hutchinson, A., Esq. (1860-82)	250	0	0		
Holdich, Lieut. John P., R.N.R. (1879-82)	3	0	0	Hutchinson, Miss, Longworth (1881-3)	95	0	0		
Holmes, Sancroft, Esq.	1	0	0	Hutchinson, Miss C. (1863-82)	35	0	0		
Home, Mrs., Edinburgh	0	10	0	Hutchinson, Miss Fanny (1871-82)	24	0	0		
Homer, C. G., Esq.	1	1	0	Hutchinson, Miss, Great Malvern (1877-80)	16	1	0		
Homer, Rev. H. (1875-83)	9	8	0	Ditto	1	1	0		
Honychurch, T., Esq., Dartford	0	10	6	Hutchinson, Rev. J. R., B.D.	1	0	0		
Hood, Admiral, C.B.	2	0	0	Huth & Co., Messrs. F. (1864-73)	21	0	0		
Hood, Miss Jacomb (1864-71)	91	0	0	I. W. (1877)	10	0	0		
Hooper, A., Esq., Royal Institution (1863-83)	35	0	0	PAnson, Charles, Esq.	1	1	0		
Ditto	1	1	0	Iliff, John, Esq. (1882)	1	0	0		
Hooper, A. D., Esq., Lloyd's	1	0	0	Image, Mrs., Mildenhall (1879-80)	10	10	0		
Hooper, Miss A. M., Bristol	2	2	0	Image, W. E., Esq.	1	1	0		
Hooper, Miss E., Gloucester	0	10	0	Imlach, R. W., Esq., Demerara	1	1	0		
Hooper, Mrs. H., Blackheath	1	1	0	Ingilby, Sir William	1	1	0		
Hooper, T. W., Esq., Southsea	1	1	0	Inglis, J., Esq., Colchester	1	1	0		
Hope, Charles, Esq.	1	1	0	Ingram, Mrs. Herbert	5	5	0		
Hope, Mrs. W. C., Bath (1873-82)	44	10	0	Ingram, Rev. H. M.	1	0	0		
Hopkins, Mrs., Northleigh	1	0	0	"In Memoriam" (1875-6)	150	0	0		
Hopkins, Miss R. (1873)	10	0	0	"In Memoriam"	25	0	0		
Hopkins, Rev. Canon	0	10	0	"In Memoriam E. C." (1881-2)	3	1	0		
Hopkins, Rev. F.	2	2	0	"In Memoriam S. M. W." (1883)	10	0	0		
Hopkins, The Misses, Nottingham	5	0	0	"In Memory of a Sister who was an Annual Subscriber" (1877)	50	0	0		
Hopkins, Joshua Scales, Esq. (1874)	50	0	0	"InterCruces," per Mrs. Dalton (1876-83)	14	14	0		
Hopkinson, Mrs., Ilchester	2	2	0	Ipswich Branch (1883)	47	9	4		
Hopton Chapel Sick and Funeral Society	3	3	0	Irby, Rev. The Hon. L. C. R.	1	1	0		
Horn, Mr. J. E.	1	1	0	Iredell, Chas., Esq.	1	1	0		
Hornby, Rev. Phipps J.	1	0	0	Iredell, Colonel J. S.	1	0	0		
Horniman, John, Esq.	1	1	0	Ironmongers, Worshipful Company of (1863-73)	21	0	0		
Horschitz and Co., Messrs.	1	1	0	Isle of Whithorn Branch (1882)	10	10	0		
Horton, Rear-Admiral W., C.B., the late	1	0	0	Ivegill Church Temperance Society	0	10	6		
Horton, T. E., Esq.	3	3	0	Iver, Archd., Esq.	1	1	0		
Hotchkis, John, Esq.	1	0	0	J. B. S.	5	0	0		
Hotham, Beaumont, Esq.	1	0	0	J. B. W. (1879)	50	0	0		
Hotham, The Hon. Lady	2	2	0	J. C., Birmingham	2	2	0		
Hothfield, the Right Hon. Lord	3	3	0	J. C. and J. S. C. (1869-82)	25	0	0		
Hovell, J. R., Esq. (1872-83)	10	9	0	J. E. D.	1	1	0		
Hovenden, F. P., Esq. (1872-81)	280	0	0	J. D. (1870-82)	17	10	0		
How, Mrs., Aspley	0	5	0	J. G. (1877)	100	0	0		
Howard, Dr., Sandycroft	1	1	0	J. M. A., Ladybank (1882)	5	0	0		
Howard, Geo., Esq., Palace Green	2	0	0	J. S.	10	0	0		
Howard and Escombe, Messrs. (1879)	10	10	0	J. S. (1878-81)	15	0	0		
				J. S. A. (1872-82)	26	17	0		
				J. T. C. (1862-75)	73	10	0		

LIST OF DONATIONS AND ANNUAL SUBSCRIPTIONS.

		Ann. Subs.		Donations.				Ann. Subs.		Donations.			
		£.	s.	d.	£.	s.	d.	£.	s.	d.	£.	s.	d.
J. W. (1878-82)					90	0	0	Kidd, Miss Pringle (1877-82)					
Jackson and Till, Messrs.		1	1	0				Kidd, Mrs.	1	1	0		45
Jackson, Miss (1881-3)					3	3	0	Ditto (1882-3)					2
Jackson, Miss H. A., Glo'ster		1	1	0				Kiddle, Com. W. W., R.N. (1879-81)					10
Jackson, S., Esq.		1	1	0				Kiddle, Mrs. W. W. (1880-81)					10
Jackson, W., Esq., Tower St.		1	1	0				Kilvert and Sons, Messrs., Manchester	1	1	0		
Jacobs, Alfred M., Esq.		1	1	0				Kimeridge Branch (1883)					10
Jacob, Charles, Esq. (1868-72)					21	0	0	Kinaban and Co., Messrs.	5	5	0		
Jaffray and Co., Messrs.		5	0	0				King, G., Esq., Algiers	2	2	0		
James, F., Esq., Kensington (1877)					50	0	0	King, Mrs., Algiers	2	2	0		
James, Robert, Esq., Store Street		1	1	0				King, Miss Louisa A.	1	0	0		
Jamieson, Hugh, Esq. (1878-80)					12	12	0	King, Miss Sarah, Skipton	1	0	0		
Janson, R., Esq.		1	1	0				King, Messrs. H. S. and Co.	2	2	0		
Jaunsey, G. M., Esq.		2	2	0				Kinglake, Rev. F. C.	1	1	0		
Jeffery, Miss S.		1	0	0				King's Lynn Branch (1883)					31
Jenkin and Phillips, Messrs.		1	1	0				Kingstown Branch (1883)					13
Jenkins, A. H., Esq. (1877)					50	0	0	Kinloch, Miss, Sussex Place	1	0	0		
Jenner and Sons, R. and H.		2	2	0				Kirk, Miss, Guildford	0	10	6		
Jensen, John, Esq.		1	1	0				Kirkhston Branch (1882)					5
Jersey Swimming Club		1	0	0				Knight, Fred., Esq.	0	10	0		
Jobson, W. W., Esq.		1	1	0				Knill and Co., Messrs. J.	2	2	0		
Johnson, Admiral		1	0	0				Knowles, the late Miss M.	5	0	0		
Johnson, F., Esq.		0	5	0				Knox, B. D., Esq., Ardmillan Ditto (1872)	2	0	0		10
Johnson, David, Esq., Chester		1	1	0				Knox, Lady Louisa	1	0	0		
Johnston, T., Esq.		2	2	0									
Johnston and Son, Messrs. Botolph Lane		1	1	0				"L" (1875)					10
Johnston & Sons, Messrs. N., Seething Lane		1	1	0				L. A. R. (1873)					50
Johnston, Sons, & Co., Messrs. E., Great St. Helens		1	1	0				L. E. W., Croydon	0	10	0		
Jones, C. W., Esq., the late, Cheltenham		1	1	0				Laddie, Mr., per Mrs. Dalton (1877-80)					18
Jones, Capt. Thos., Liverpool (1883)					1	0	0	Ladds, Capt. W.	0	10	6		
Jones, H. Cadman, Esq.		1	1	0				Laing, Capt. Jas. (1880-2)					3
Jones, James, Esq., Ramsey		1	1	0				Lambert Bros., Messrs.	2	2	0		
Jones, Miss F. A., Stratford (1883)					1	11	0	Lambert, F. D., Esq.	5	0	0		
Jones, Miss Isabella G. E., Bayshill		1	1	0				Lambert, T., Esq.	2	2	0		
Jones, Miss S., Cheltenham		1	1	0				Lampard & Foster, Messrs.	1	1	0		
Jones, Mrs., Faversham (1878)					25	0	0	Lampson, George C., Esq.	2	2	0		
Jones, Winslow, Esq., Exeter		1	1	0				Lancaster Branch (1883)					139
Joy, Mr., Deal		0	10	6				Lancaster, Mrs. Mary	1	1	0		
Jubb, John, Esq., J.P. (1879-83)					20	0	0	Landon, Mrs., Putney	2	2	0		
Jubb, Samuel, Esq., Batley (1875)					10	0	0	Lane, Rev. T. L.	1	0	0		
								Lanerton, Lady	5	0	0		
K. and E. C. (1873-81)					35	0	0	Langton, Miss Maria	1	1	0		
K. S. (1880-3)					6	0	0	Langton, Rev. Charles	5	0	0		
K. W. (1878)					20	0	0	Langton, W. Gore, Esq. (1865-72)					250
Kaye, Miss E. F.		2	2	0				Langworthy, Mrs. Sarah (1883)	1,000	0	0		C
Keal, Miss, Hereford		1	1	0				Lansdell, Mr. G.	1	1	0		
Keeling, Rev. Wm., B.D.		1	1	0				Lanyon, J. C., Esq.	1	1	0		
Keightley Branch (1883)					30	0	3	Larcom, Mrs. Capt.	1	0	0		
Keiller, William, Esq.		2	0	0				Larden, Rev. G. F., D.C.L.	1	10	0		
Kellock, Messrs. C. W. & Co.		1	1	0				Larking, Alfred J., Esq.	2	2	0		
Kelly, Mrs., Ealing		1	1	0				Laurie, Mrs., St. George's Place, per Rev. Sir Emilius Bayley, Bart, B.D. (1876)					500
Kemble, Mrs. Henry		10	10	0				Law, the Hon. H. S.	1	1	0		
Kemble, William, Esq.		5	0	0				Lawrence, G. H., Esq. (1870-8)					34
Kempster, John, Esq., and Mrs.		1	1	0				Ditto	1	0	0		
Kennard and Co., Messrs. S.		2	2	0				Lawrence, Gen. H.	1	1	0		
Kendal, T. Herbert, Esq., Woodleigh (1871-82)					14	4	0	Lawrence, Miss J., Rosslyn	0	10	0		
Kennaway, Rev. W. B., Weymouth (1881)					25	0	0	Lawrence, Mrs.	1	1	0		
Kennedy, Adm., C.B.		1	1	0				Lawrence, Mrs., City Road (1882)					10
Kent and Co., Messrs. G. B.		0	10	6				Lawrence, Rev. H. Gerald- ton, Western Australia	0	10	0		
Kent, Henry, Esq., Shepherd's Bush		1	1	0				Lawrence, Sydney, Esq., Clapham Park (1882)					50
Kent, Mrs. Henry, Ditto		1	1	0				Lawrence, the Misses, Whitehall (1882)					10
Kent, T. J., Esq. (1871)					10	10	0	Lawson, Miss Elizabeth	10	0	0		
Kent, Rev. Chas., Ludlow		1	0	0				Lay, Mr. M.	0	5	0		
Keppel, Admiral the Hon. Sir Henry, K.C.B.		1	1	0				Laye, Mrs.	1	0	0		
Keppel, W. H. A., Esq.		1	0	0				Le Bailly, H. J., Esq., Edin- burgh.	2	2	0		
								Le Cocq, Capt. W. G., R.N.	5	0	0		
								Le Lacheur, John A., Esq.	2	2	0		

	Ann. Subs.		Donations.			Ann. Subs.		Donations.	
	£.	s. d.	£.	s. d.		£.	s. d.	£.	s. d.
Le Marchant, The Dowager					Longman, C. J., Esq.	1	1	0	
Lady	1	1	0		Longridge, the Misses	1	1	0	
Lea, Charles Wheeley, Esq., Worcester (1881)			100	0	0	"Long Shore Cove," per "Punch" newspaper (1883)			2 2 0
Lea, M., Esq. (1865-83)			19	19	0	Lonsdale, W., Esq. (1872)			20 0 0
Leach, Francis, Esq.	1	1	0			Looe Branch (1883)			20 0 0
Leathersellers, Worshipful Com- pany of (1874)			10	10	0	Love, Mr. William, Paisley (1860-82)			23 0 0
Leckie, Messrs. J. B. & Co.	1	1	0		Loveday, J. T., Esq., Norwood	1	1	0	
Ledger, J. W., Esq.	1	1	0		Low, Alex. F., Esq.	2	2	0	
Ledoux, M. Henri, Demerara	1	1	0		Lowdell, Miss, Baldwyns (1871)			10 10 0	
Ledward, Chas. A., Esq., Fairlawn	2	2	0		Lowdell, Mrs., Bedales (1873)			50 0 0	
Ledward, Miss F. G., Ditto	0	5	0		Lowe, Rev. H. E., M.A.	3	3	0	
Lee, James, Esq., Brixton (1876-83)			4	0	0	Lowndes, Rev. E. S.	1	1	0
Lee, Miss, Kinfare	2	2	0			Lowndes, Rev. W. D.	0	5	0
Lee, Son, and Co., Messrs. Wm. (1873)			21	0	0	Loyd, Mrs. Lewis (1859-82)			50 10 0
Leeds Branch (1883)			105	2	0	Lucas, Mrs. C. H.	1	1	0
Leek Branch (1882)			25	14	6	Luck, F. G., Esq., The Olives	2	0	0
Legge, Gen. the Hon. A. C.	2	0	0		Luscombe, Mrs.	2	0	0	
Legge, Lieut.-Col. the Hon. E.H.	1	1	0		Lushington, Mrs. J. D.	2	0	0	
Leicester Branch (1882)			70	0	0	Lutwidge, C. R. Fletcher, Esq.	1	1	0
Leigh, Mrs. D. H.	1	1	0		Lyall, W. H., Esq., M.A.	1	1	0	
Leiningen, Capt. H.S.H. the Prince, R.N., G.C.B.	1	0	0		Ditto (1881)			5 5 0	
Leishman, Inglis, & Co.	1	1	0		"Lydia," Southampton (1874-82)			4 12 6	
Leith, Alex. Esq., Glenkindie (1883)			2	0	0	Lyell, Miss C., Shielhill (1877-8)			20 0 0
Leman, Henry, Esq. (1876-81)			16	13	0	Ditto	1	0	0
Letchworth, Miss, Woburn	1	1	0		Lyell, The Misses (1871)			10 0 0	
Lethbridge, Mrs. A. G.	3	3	0						
Lethbridge, Rev. J. K., M.A.	0	10	0		M. (1863-83)			21 0 0	
Lewis, Professor Hayter (1872)			10	10	0	M. (1873-4)			150 0 0
Lewis, R. Esq., the late	1	1	0		M., per Messrs. Coutts & Co. (1867-82)			48 0 0	
Lewis, Mrs. Richard, Gloucester Place	1	1	0		M. A. F.	1	1	0	
Lewis, R. E., Esq., Anerley	1	1	0		M. A. L., per W. Arnott, Esq. (1872)	200	0	0	
Lewis, Richd., Esq., Hereford	1	1	0		M. B. T. W. (1869-75)	150	0	0	
Leyland, Mrs. M. A. V.	5	5	0		Ditto (1877)			50 0 0	
Liddell, H. T., Esq., Colwall (1860-79)	106	0	7		M. C. M. (1869-73)			10 0 0	
Liddon, E., Esq., M.D.	1	1	0		M. E. C.	2	2	0	
Liddon, J., Esq., Wimbledon	1	1	0		M. E. I.	1	1	0	
Liddon, W., Esq., Taunton	0	10	0		M. E. W. E. C. (1877-82)			6 0 0	
Lightfoot, Mrs. General	1	10	0		M. M. M., In Memory of	10	0	0	
Lightfoot, Miss	1	10	0		M. R.	5	0	0	
Lightfoot, J. E., Esq., Ac- crington	1	1	0		M. R., "A Thank-offering" (1872)	20	0	0	
Lighton, Sir C. R., Bart.	1	1	0		M. S. S.	1	1	0	
Lindesay, Lieut. A. H., R.N.	1	0	0		M. T. (1865-75)			25 0 0	
Lindley, W., Esq., C.E. (1864-81)			11	10	0	Macan, Lieut.-Gen. H., C.B.	2	0	0
Linford, Mrs. W. T.	1	1	0		MacAndrew & Co., Messrs. R.	2	2	0	
Ling, Miss, and Friends (1883)			0	10	0	Macdonald, D., Esq., Larne (1875-9)			25 0 0
Lingen, Sir Ralph R. W., K.C.B.	2	2	0		Macdonald, The Misses	2	0	0	
Lingham, Mrs.	1	1	0		Mac Farlan, J., Esq.	1	0	0	
Linney, Albert, Esq.	0	10	0		Mackenzie, Colonel J. K.	2	2	0	
Lintott, W., Esq., Horsham	1	1	0		Mackenzie, Mrs. E.	2	2	0	
Lister, Beck, and Co., Messrs.	1	1	0		Mackeson, H. B., Esq.	1	1	0	
Littleboro' Co-operative Soc., Limited	2	2	0		Mackinlay, Mrs., Regents Park			1 1 0	
Littledale, C. R., Esq. (1876-83)			21	15	0	Maclean, Maris & Co., Messrs.	1	1	0
Littledale, Major (1861-9)			250	0	0	Macleod, Capt. R. B. E., R.N.	2	2	0
Ditto			10	10	0	Macmillan and Sons, Messrs.	1	1	0
Littlehales, Capt. E., R.N.	1	0	0		MacWhirter, John, Esq., and Miss MacWhirter (1871-81)			38 19 0	
Little, Mrs., Penge (1881-3)			0	15	0	Mac Whirter, Mrs., Abbey Road (1882)			2 2 0
Living, Miss C.	0	5	0		Magrath, Rev. J. R., M.A.	0	10	0	
Liverpool and New Brighton Branch (1882)			250	0	0	Maingay, Mrs.	2	0	0
Living, Mr. H. (1881-82)			0	10	0	Maidand, Capt. H. L., R.N.	1	1	0
Llanely and Pembrey Branch (1883)			10	0	0	Major and Field, Messrs.	1	1	0
Lloyd, Matheson, & Co., Messrs.	1	0	0		Major, C. M., Esq.	1	1	0	
Lloyd, Mrs. G. J. M.	1	1	0		Malcolm, W. E., Esq.	1	0	0	
Lloyd's, The Committee of	10	10	0		Mallam, Richard, Esq.	1	0	0	
Lockett, Miss, Macclesfield 1871-83)	2	10	0		Maltby, Major E. P.	1	1	0	
Lockwood, Miss	1	1	0		Manchester Branch (1882)			450 0 0	
Long, Captain S., R.N.	5	0	0		Manley, A. E., Esq.	2	0	0	
					Manley, Major, Robt. G., Atherstone, (1882)			5 0 0	
					Mann, Mrs. Dixon	1	1	0	
					Mannock, W. M. S. P., Esq.	1	1	0	
					Mansel, J. C., Esq.	1	1	0	

LIST OF DONATIONS AND ANNUAL SUBSCRIPTIONS.

	Ann. Subs.		Donations.			Ann. Subs.		Donations.	
	£.	s. d.	£.	s. d.		£.	s. d.	£.	s. d.
Marcet, W., Esq., M.D. (1869-81)			18	13 0	Mee, Mrs. J. H.	1	1 0		
March, Lieut., Sautander	0	10 0			Meggesson and Co., Messrs.	1	1 0		
Margate Branch (1883)			25	0 0	Melhuish, Sons, & Co., Messrs.	1	1 0		
Margetts, Mrs. E. G.	1	1 0			Meller, Capt. A., Ipswich (1874-82)			35	0 0
Marine and General Mutual Life Assurance Society	10	0 0			Mellish, Henry, Esq.	1	1 0		
Mark Lane Life-boat Fund, <i>vide</i> p. 107.					Mellish, Mrs. Leigh	1	1 0		
Markby, Alfred, Esq. (1878-81)			20	0 0	Mellor, The Hon. Justice (1878)			50	0 0
Markham, Chas., Esq., Northampton	1	0 0			Melville, Lady F.	1	1 0		
Marks, J. C., Esq., Swansea (1880-3)	10	0 0			Merchant Taylors, Worshipful Company of (1857-76)			147	0 0
Marriott, Capt. Edwd.	1	1 0			Meredith, Miss Emma (1870-82)			26	16 3
Marryat and Sons, Messrs. J.	2	2 0			Merrick, Col.	1	0 0		
Marryat, Charles, Esq.	1	1 0			Metcalfe, Mrs., Jersey	1	1 0		
Marsh, Miss, Gloucester	1	0 0			Methuen, Rev. H. H.	0	10 0		
Marshall, A., Esq., Huntingdon	1	1 0			Meux & Co., Messrs.	5	5 0		
Marshall, C., Esq., Huntingdon	1	1 0			Michael, Albert D., Esq. (1883)			10	10 0
Marshall, Mrs., Tunbridge Wells (1882)			5	0 0	Michell, Rev. T. H.	1	1 0		
Marshall, Rev. E. (1854-77)			33	14 6	Michie, A. S., Esq.	1	0 0		
<i>Ditto</i>	1	1 0			Michie, Mrs. A. S.	1	0 0		
Marshall, J. M., Esq., Walingford	1	1 0			Middlesbrough Branch (1883)			50	0 0
Marter, Miss Mary B.	1	1 0			Middleton, The Misses (1860-76, in addition to 30 <i>l.</i> 5 <i>s.</i> collected			42	12 6
Marter, Wm. Ingram, Esq.	1	1 0			Miland, Mrs., Wimbledon	2	0 0		
Martin, Capt. W. L., R.N.	1	0 0			Milburn, Messrs. William, & Co.	5	5 0		
Martin, E. M., Esq.	5	5 0			Miller, R. M., Esq.	1	1 0		
Martin, J. Stapleton, Esq.	0	10 6			Miller, Mrs. (1880-2)			9	4 0
Martin, J. B., Esq., Lombard Street (1873)	10	10 0			Millington & Co., Messrs. W.	1	1 0		
Martin, Capt. Leslie (1873)			25	0 0	Millington, C., Esq.	1	1 0		
Martin, Mrs., West Buckland	2	2 0			Mills, J. C., Esq., Glastonbury (1878-82)	3	0 0		
Martin, The Misses, Bloomsbury (1869-75)			18	12 6	Mills, J., Esq., Yateley	1	1 0		
Martin, T., Esq., St. Austell	1	1 0			Mills, Mark, Esq. (1864-80)			85	5 0
Martin, Rev. Glanville	1	1 0			Mills, Wm., Esq., Clapham	1	1 0		
Martineau, Miss F., Clapham	2	2 0			Millward, Wm., Esq.	1	1 0		
Martyn, Miss Jane A., Carthew "Mary," Wisley (1882-3)	5	0 0	2	2 0	Milne, Mrs. J. D., Aberdeen (1864-75)	12	0 0		
Mason, Miss, Lillington	0	10 6			Milner, Chas., Esq., Sheffield (1882)	10	0 0		
Mason, Rev. Canon, Langley	1	1 0			Milner, Rev. E. W. (1881)	10	0 0		
Massey, R., Esq., Handforth	2	0 0			Milnes & Chaytor, Messrs.	1	1 0		
Massy-Beresford, Very Rev. John M.	1	0 0			Mitchell, A. C., Esq.	1	1 0		
Mathew, Major E. W., Wern	2	2 0			Mitchell, F. H., Esq. (1857-81)			114	0 0
Mathews, G. H., Esq.	2	2 0			Mitchell, F. J., Esq., Caerleon	1	1 0		
Mathews and Luff, Messrs.	1	1 0			Mitchell, G. W., Esq.	0	10 0		
Matthews, W. E., Esq. (1881)			10	0 0	Mitchell, J. H., Esq.	2	2 0		
Matthie, Miss, Fenge (1881-3)			1	5 0	Mitchell, Jas. Hy., Esq., Bicester (1883)	2	2 0		
Matveieff and Co., Messrs.	1	0 0			Mitchell, W. R., Esq., Wimpole Street	1	1 0		
Maude, Capt. Hon. F., R.N.	1	1 0			Mitchell, Yeames, and Co., Messrs.	5	0 0		
Maude, John, Esq., Clapham	1	1 0			"Modern Lower Remove," The, Harrow (1881-2)			7	0 0
Maudslay, Chas. E., Esq.	1	0 0			Moffat, R. J., Esq., F.R.G.S.	2	2 0		
Maudslay, Henry, Esq.			11	0 0	Moir, Mrs. M. T.	1	1 0		
Maudslay, Son, and Field	2	2 0			Moline and Co., Messrs. (1865-73)			41	10 0
Maxwell, Rev. E.	2	0 0			Molison, Mrs., Errol (1881)			500	0 0
Maxwell, Col. G. Shirley	1	0 0			Molyneux, Lady Georgina (1874-7)			15	0 0
Maxwell, Lieut.-Gen. H. H., R.A.	10	0 0			Molyneux, Mrs.	0	10 0		
Mayer, Rev. J. H., Bath	0	10 0			Moncrieff, Colonel	1	0 0		
Mayne, Adm. R. C., C.B.	1	1 0			Montague, A., Esq., Penton	1	1 0		
Mayor, Mrs. (1882-3)			1	10 0	Montgomery & Workman, Messrs.	1	1 0		
McArthur, Messrs. W. & A.	2	2 0			Montgomery, John, Esq.	5	0 0		
McBayne, Miss Frances	2	0 0			Montgomery, Sir G., Bt., M.P.	2	0 0		
McCance, Henry J., Esq.	0	10 0			Montrose Branch (1882)			22	2 0
McDonogh, Mrs., Molesey	2	2 0			Moon, R., Esq., Coventry	2	2 0		
McDougall, C. A., Esq.	1	0 0			Moore, Rev. G. B., Tunstall (1857-80)			42	0 0
McDougall Bros., Messrs.	1	1 0			Moore, Capt. Richmond, R.N.	1	1 0		
McEwan and Co., Messrs. J.	1	1 0			<i>Ditto</i> for Life-boatmen's Widows and Orphans (1883)			2	10 0
McHwraith M'Eacharn & Co. Messrs.	1	1 0			Moore, The late Lieut.-Gen. R. C., C.B.	2	0 0		
McKerrell, Wm., Esq. (1863-72)			80	0 0	<i>Ditto</i> , and Mrs. Moore (1871-6)			12	0 0
McNeill, Sir J., G.C.B.	1	0 0			Moore, W., Esq., Wierton	1	1 0		
Mead, Joseph B., Esq.	1	1 0			Moore, W. B., Esq., Hampstead (1881-3)	31	0 0		
Meadows, T., and Co., Messrs.	1	1 0			Moore, W. E., Esq., Royal Exchange (1876)			100	0 0
Meares, Thos., Esq.	1	1 0							
Medlycott, Capt. M. B., R.N.	1	1 0							
Medwin, Dr. A. G.	1	1 0							

	Ann. Subs.			Donations.		
	£.	s.	d.	£.	s.	d.
Moorsom, Rev. J. R.	1	1	0			
Morehead, Dr. C.	1	1	0			
Morgan & Co., Messrs. E. W. (1883)	2	2	0			
Morgan & Co., Messrs. J. S.	1	1	0			
Morgan & Medhurst, Messrs.	1	1	0			
Morice, John C., Esq.	1	1	0			
Morland and Sons, Messrs. J.	1	1	0			
Morley, Mrs., Derby	1	1	0			
Morphew, J., Esq., Jermyn St.	1	1	0			
Morrice, R. E., Esq., Eltham (1872-6)	10	10	0			
Morrison, Col. Robert	2	2	0			
Morris, Prevost, & Co., Messrs. (1864-73)	15	10	0			
Morris, Mrs., Lee (1879-82)	2	0	0			
Morrison, Mrs., Reading (1881)	50	0	0			
Morrison, Miss, Reading (1881)	10	0	0			
Morton, Mrs. (1864-82)	37	16	0			
Morton, Rose, & Co., Messrs.	1	1	0			
Mosenthal, Sons, and Co., Messrs. J.	1	1	0			
Moser and Sons, Messrs. (1878)	10	0	0			
Moss and Co., Messrs. C.	2	2	0			
Moss, Mrs. G. W.	2	2	0			
Moules, G., Esq., Sutton (1865-72)	21	0	0			
Mowbray, Lady (1882)	1	0	0			
Moysev, Rev. F. L.	1	1	0			
Muff, F. B., Esq., Ilkley	1	1	0			
Mullard, Thos. S., Handsworth	0	10	6			
Mulens, J. A., Esq., Lombard Street (1880-1)	52	10	0			
Müller, C. J., Esq.	1	1	0			
Munns, Mr., Wrexham	1	1	0			
Mure, Mrs. Geo. Herringwell (1873)	10	0	0			
Murphy, J. J., Esq., Lisburn	1	0	0			
Muspratt, Henry, Esq.	10	0	0			
Musselburgh Branch (1883)	14	12	6			
Myers, W. H., Esq., Swanmore House	2	2	0			
Mytton, Miss, Welshpool	2	2	0			
N., per Messrs. Morris, Prevost, and Co.	5	0	0			
N. B. A. (1875)	30	0	0			
N. F. H.	1	1	0			
N. L., Dublin (1861-79)	80	0	0			
Napier, Rev. J. W.	1	1	0			
Nash, C., Esq., Kensington (1878-82)	5	0	6			
Nash, F., Esq., Ludlow	1	1	0			
Naylor, Benzon, & Co., Messrs.	5	5	0			
Naylor, Joseph Ulysses, Esq.	1	1	0			
Neale, Miss C., Brighton	0	10	6			
Neillson & Sons, Messrs. Claud	2	2	0			
Nelson, Dale, & Co., Messrs.	1	1	0			
"Nemo"	5	0	0			
Nesbitt, Messrs. A. & W.	1	1	0			
Nesbitt, Miss Downing (1877-82)	15	0	0			
Neve, Mrs. R.	0	5	0			
Newark Branch (1883)	24	4	7			
Newbon, Robt. Alger, Esq.	1	1	0			
Newcastle Trinity Board	10	10	0			
Newman, Mrs., Sep.	0	10	0			
Ditto (1872-83)	3	10	0			
New River Company	1	1	0			
Newsom, S. H., Esq., Cork	1	0	0			
Newsom, Mrs. Geo., Clapham	1	1	0			
Newson, Thomas, Esq.	1	1	0			
Newton Abbot Branch (1883)	18	18	2			
Newton, F. W., Esq.	1	0	0			
Newton, Capt. W. H., R.A. (1873-5)	20	0	0			
Ditto	5	0	0			
Newton, Miss	2	3	0			
Newton, Miss, Hampstead	0	5	0			
Nicholl, Henry F., Esq.	5	5	0			
Nicholson, G. P., Esq., Wath	2	2	0			
Nicholson, W. L., Esq.	1	1	0			

	Ann. Subs.			Donations.		
	£.	s.	d.	£.	s.	d.
Nicolson, Admiral Sir F. W., Bart., C.B.	1	0	0			
Nixon, C. J., Esq., Bourne-mouth	1	1	0			
Noble, John, Esq., Park Place (in addition to gift of Life-boat and House)	2	0	0	20	0	0
Noble, R. H., Esq., Caversham Hill	3	0	0			
Noble, Wilson, Esq., Henley	2	2	0			
Noden, E. Byron, Esq., appropriated from residue of Trust Fund (1882)				50	0	0
Norris, Miss A. H.	0	10	0			
Norwich National Fisheries Exhibition Committee of (1881)				25	0	0
Noel, Eugene F., Esq.				10	10	0
Nolloth, Dr. E., R.N.	1	0	0			
Norfolk Branch (1883)				109	0	9
Norsworthy, G., Esq.	1	1	0			
Norsworthy, H., Esq. (1866-77)	100	0	0			
Northampton Branch (1883)	22	0	6			
Northampton, The Marquis of	5	0	0			
Northey, E. K., Esq., Epsom (1878)				10	0	0
North, Hon. Fredk. H. (1882)				5	0	0
Northumberland, Duke of	2	0	0			
Nottingham Branch (1883)				53	14	0
Nottingham, Mrs., in memory of her late uncle, A. Worthington, Esq., Whitchurch (1874)				250	0	0
"Number 99, East Sussex" (1881-3)				15	0	0
Nutter, James, Esq.	0	10	6			
Oakes, Arthur, Esq.	1	1	0			
Oakes, Mrs. (1871-82)				10	10	0
Oakley, Christopher, Esq.	1	1	0			
Odd Fellows, Independent Order of (M. U.) vide p. 107.						
O'Donovan, The	1	1	0			
Offley, Forrester, and Co., Messrs.	2	2	0			
Oliver, George, Esq.	1	1	0			
O'Maley, Michael R., Esq., Demerara	2	2	0			
Onslow, Lady, M.A. (1882-3)				4	4	0
Onslow, Miss M. (1881-3) (in addition to her gift of the Sennen Life-boat)				6	0	0
Oppenheim, Henry, Esq.	5	0	0			
Oram, Jas., Esq. (1863-82)				95	0	0
Orde, Miss A. M. F. (1865-77)				30	0	0
Ditto	1	1	0			
Ormerod, G. W., Esq., Brookbank (1875)	15	15	0			
Osborn, Mrs. C., Down End	1	1	0			
Osborne, Martin, Esq.	1	1	0			
Osborne, The Misses (1881-3)				1	16	6
Otter, Mrs. H. C., Bruntsfield	1	1	0			
Otter, R. H., Esq., Downslands	5	0	0			
Otway, Rear-Adml. R. J.	5	0	0			
Outram, Sir Francis, Bart.	5	0	0			
Outram, The Dowager Lady Overstone, The Rt. Hon. the Lord (1865-82)				271	0	0
Ovey, The Misses (1865-72)				90	0	0
Owen, Mrs. R. K. W.	1	1	0			
Owen & Graham, Messrs. (1866-77)				56	5	0
P. P. (1879)				10	0	0
Pace, Rev. Henry H., Dorchester	1	1	0			
Ditto (1882)				1	1	0
Pacific Steam Navigation Co.	5	5	0			
Painter, T., Esq., Wrexham	1	0	0			
Palmer, Col. G., the late	1	1	0			
Palmer, George, Esq.	1	1	0			
Palmer, Miss, Manton (1860-82)	22	15	0			

LIST OF DONATIONS AND ANNUAL SUBSCRIPTIONS.

	Ann. Subs.		Donations.			Ann. Subs.		Donations.	
	£.	s. d.	£.	s. d.		£.	s. d.	£.	s. d.
Palmer, Rev. H. G. (1880-2)					Phillimore, Capt. W. B. (1859-83)			235	10 0
Pantin, Messrs. W. & C.	1	1 0			Phillimore, Admiral A.	3	0 0		
Parbury, Mrs.	1	1 0			Phillipps and Graves, Messrs.	1	1 0		
Parker, E. L., Shanklin (1882)			0	10 0	Phillips, J. H., Esq., Cromwell Road	1	1 0		
Parker, F., Esq. (1877)			10	0 0	Phillpotts, W. F., Esq.	1	1 0		
Parker, Miss (1875)			10	0 0	Pick, Edgar S., Esq.	1	1 0		
Parker, Miss, St. Clear's (1862-71)	20	0 0			Pickering, Leonard, Esq. (1872)			200	0 0
Parker, Rev. Wm. (1858-77)			41	0 0	Pickernell, Brothers, Messrs. (1882)			1	1 0
Parkes, Col. E. H.	0	10 0			Pickernell, F. C., Esq. (1882)			1	1 0
Parkin, Miss, Leconfield	1	1 0			Pidduck, W. G., Esq. (1883)			1	1 0
Parkin, Miss M. J.	1	1 0			Piel Branch (1883)			20	0 0
Ditto (1881-3)			10	0 0	Pigeon, Henry, Esq. (1864-82)			63	0 0
Parkin, Mrs., Blaithwaite	1	0 0			Pike, Mrs. Justine (1873-8)			20	0 0
Parnell, John, Esq., J.P.	1	0 0			Pilcher, R.A., Esq., Cromwell Houses	1	1 0		
Parnell, Louis, Esq.	2	0 0			Pilgrim, C. H., Esq.	2	2 0		
Parnell, Mrs. Gervas, Fetcham	1	1 0			Pirie and Co., Sir John	2	2 0		
Partington, E., Esq.	1	1 0			Platt, Fredk., Esq., Oldham (1873)			90	0 0
Partidge, C., Esq., Exors. of (1883)			2	0 0	Platt, Owen, Esq., Oldham	2	2 0		
Pasley, Adm. Sir T. S., Bart., K.C.B.	1	0 0			Playne, Peter, Esq. (1860-79)			95	0 0
Paterson, Laing, & Bruce, Messrs.	1	1 0			Plow, Rev. H. A., on behalf of his late son, Mr. J. C. Plow, R.N. (1882)			5	0 0
Pattenden, Philp., Esq., Brixton	1	1 0			Plymouth Branch (1882)			60	0 0
Paul, H. T., Esq.	2	2 0			Poë, Rev. J. Leslie	1	1 0		
Paulet, Lady Henry (1862-72)			32	0 0	Pol, Paris, Esq. (1871)			10	10 0
Paulin, G., Esq., Lloyd's	1	1 0			Pooley, Chas., Esq.	1	1 0		
Pawle, J. D., Esq.	1	1 0			Porteous & Senior, Messrs.	2	2 0		
Payne, Miss H., Glenfield	1	0 0			Porter, Rev. C. F.	0	10 0		
Payne, W. H., Esq., Bolton	0	10 6			Porter, Capt. H. R.	1	1 0		
Peach, The Misses, Langley Hall, further in aid of Memorial Life-boat (1877-81)			60	0 0	Porthcawl Branch (1882)			40	0 0
Peacock & Buchan, Messrs.	2	2 0			Port of Rochester Branch (1883)			16	0 4
Peacock Bros., Messrs., Sunderland, s.s. Larch and Birch	2	2 0			Portrush Branch (1883)			10	0 0
Pearce, Maresco, Esq.	1	1 0			Postans and Sons, Messrs.	0	10 6		
Ditto (1882)			2	2 0	Postlethwaite, J. H., Esq.	1	1 0		
Pearson, Miss Sophia	1	1 0			Postlethwaite, G. F., Esq.	1	1 0		
Peart, H. B., Esq.	1	0 0			Potter, Septimus, Esq.	2	2 0		
Peckover, A., Esq., Wisbeach (1857-81)			50	0 0	Potts, John E., Esq. (1882)			5	5 0
Ditto			1	1 0	Powell, Messrs. T. J. and T.	1	1 0		
Peckover, W., Esq., ditto (1857-74)			80	0 0	Poyer, J. P., Esq.	1	1 0		
Peebles Branch (1883)			20	14 2	Poynder, William, Esq., Hartham Park (1874)			500	0 0
Peek, Winch & Co., Messrs.	5	5 0			Prall, Z. E., Esq.	2	2 0		
Peel, Sir Robert, Bart., G.C.B. (1871)	20	0 0			Pratt, Mrs. H., Leamington (1863-80)	210	10 0		
Peel, Edmund Yates, Esq.	1	0 0			Pratt, T. R., Esq., Daventry (1881)			10	0 0
Peiham, Lord (1876)			10	10 0	Prescott, H. W., Esq.	2	2 0		
Pemberton, E. L., Esq., M.P. (1868-73)	31	0 0			Preston, Miss L. F. M.	5	0 0		
Pembroke and Montgomery, The Earl of (1875)			250	0 0	Price and Pierce, Messrs.	5	5 0		
Penarth Branch (1883)			75	0 0	Price, John, Esq., R.N.	2	0 0		
Penfold, E. H., Esq.	2	2 0			Price, Mrs. Admiral (1858-83)			140	0 0
Peninsular and Oriental Steam Navigation Company	5	5 0			Priestley, Wm., Esq.	1	1 0		
Penn and Sons, Messrs. John	5	0 0			Primrose, The Hon. B.F., C.B.	2	2 0		
Pennington, Mrs., Thickthorn	1	1 0			Prince, John, Esq.	2	2 0		
Penny, Thos., Esq.	0	10 6			Prince, Ogg and Co., Messrs.	1	1 0		
Penny, Thos. S., Esq., Taunton	1	1 0			Pritchard, J., Esq.	1	1 0		
Penson, Miss	0	10 6			Pritchard, Mrs., Astley Abbots	1	1 0		
Penson, Mrs.	3	3 0			Procter, Robt., Esq.	1	1 0		
Pepys, J. A., Esq. (1830-2)			21	0 0	Prowett, N. H. E., Esq. (1862-82)			70	0 0
Percy, Lady Louisa (1870-8)			150	0 0	Prowse, Capt. G. J. W.	1	1 0		
Percy, The Right Hon. the Earl, P.C., M.P.	2	0 0			Ditto (1882)			10	0 0
Perrott, Sir E. G. L., Bart., V.P.	1	1 0			Pryor, Miss, Penge (1881-3)			1	5 6
Perot, W. Y., Esq., Demerara	1	1 0			Psaila, Luigi, Demerara	1	1 0		
Peterborough Branch (1883)			2	10 0	"Psalm 107"			1	0 0
Peterhead Branch (1883)			35	0 0	"Psalm 66, 13-14" (1881)			20	0 0
Peters Brothers, Messrs. (1883)			10	0 0	Pugh, Miss, Leighton			0	10 6
Peters, Miss Nowell	0	10 0			"Queen," per Mrs. Dalton (1883)			5	5 0
Phillips & Co., Messrs. J. & N.	10	10 0			Queensbury, Marquis of	2	2 0		
Phillips, G. M. Esq. (1883)			0	10 0	Quick, Rev. R. H., M.A.	1	1 0		
Phillips, J. W., Esq.	2	2 0			R. B. and Co. (1867-83)			132	7 0
Phillips, Miss, Leamington	1	1 0			R. B. J. (1879-83)			15	0 0
Phillips, Rev. S. J., Tilney	1	1 0							
Phillips, W. W., Esq.	1	1 0							

	Ann. Subs.		Donations.			Ann. Subs.		Donations.	
	£.	s. d.	£.	s. d.		£.	s. d.	£.	s. d.
Rabbetts, Rev. F. D., M.A.	0	5	0		Robins, Miss G., ditto	1	0	0	
Rackham, Willoughby, Esq.	2	2	0		Robinson, F. J., Esq., Chester St.	2	2	0	
Radcliffe, Josiah, Esq., Bryn Dinarth (1881-3)				6 6 0	Robinson, G., Esq., Skipton	1	1	0	
Radcliffe, John, Esq., Furlane	1	1	0		Robinson, Lawson, Esq.	1	1	0	
Rahn and Co., Messrs.	2	2	0		Robinson, Rev. Henry (1874)			10 0 0	
Raincock, Mrs., Waltons (1882)			10 10 0		Robinson, Rev. T. B. B.	1	1	0	
Ralli Brothers, Messrs.	2	2	0		Rochdale Branch (1882)			71 6 6	
Ralph, Rowland W., Esq.	1	0	0		Rochester, Thomas, Esq. (1870)			1000 0 0	
Ramsay, Capt. John, R.E.	2	0	0		Rockley, J., Esq., Boro'	1	1	0	
Randells, Howells, and Co.	1	1	0		Rodocanachi, Sons, and Co.	1	1	0	
Randolph, Admiral G. G.	5	0	0		Rodwell, Mrs. Helen, Win- chester (1863-77)			91 9 8	
Rawlins, Mrs., Tunbridge Wells		1 0 0			Rogers, Mrs., Westbourne Sq.	1	1	0	
Rawlinson, W., Esq.		1 0 0			Roget, Mrs., Maids Hill	1	1	0	
Rawson, Miss, Tilney Street (1879)	100	0	0		Rohrweyer, J. C., Esq.	1	1	0	
Rawson, Miss E., Nydd Hall (1880)	100	0	0		Rolle, The Hon. Mark	10	0	0	
Ray, Brisco, Esq., in memory of the late Richard Glaister, Esq. (1875)		10 0 0			Rolleston, Miss, Bath	1	1	0	
Ray, Capt. H. R. (1873)		10 0 0			Romilly, Cosmo, Esq. (1881)			10 10 0	
Ray, Rev. Henry, B.A.	1	1	0		Ropes, W. H., Esq.	1	1	0	
Raymond and Reid, Messrs. (1873)	50	0	0		Rose, Mrs. A. M., Fulham	1	1	0	
Read, Mrs. "In Memoriam" (1882)	0	10 0			Rosher, W. H. Burch, Esq. (1880)			10 10 0	
Reading Branch (1883)	144	19 10			Ross, Wm. Lewis, Esq.	2	2	0	
Redfern, Alexander, and Co.	5	0	0		Rosse, Dowager Countess of	2	0	0	
Reece, Miss (1869-77)		24 0 0			Rothery, H. C., Esq., M.A. (1880)			25 0 0	
Reeves, A., Esq.	0	5 0			Rothschild, Messrs. N. M., & Sons			10 10 0	
Regent's Canal Company	3	3 0			Routh, Miss A.	1	0	0	
Reid, J., Esq.	1	0 0			Routh, W. D., Esq.	5	0 0		
Reid, P., Esq., Stock Exchange (1879)	50	0 0			Rowbotham, Dr. Wm.	0	10 6		
Reinachs, Nephew, and Co.	0	10 6			Rowlandson, Miss Ann	1	1 0		
Reiss Bros., Messrs.	2	2 0			Rowley and Davies, Messrs.	1	1 0		
Remington, Rev. T. M.	2	2 0			Rowley, Col. Sir C., Bart.	2	2 0		
Reneau, Mr. & Mrs. R. P. W.	1	1 0			Ditto (1882)			5 0 0	
Reynardson, Rev. G. B. (1865-72)	15	0 0			Royal Harwich Yacht Club	2	2 0		
Ditto		2 0 0			Royal Mail Steam Packet Co. (annual)			10 0 0	
Reynardson, Rev. J. B.		1 1 0			Royal Yacht Squadron	10	0 0		
Reynolds, Rear-Admiral		0 5 0			Rubie, J. P., Esq., Cowes	1	1 0		
Reynolds, E. M., Esq.		1 1 0			Ruck Bros., Messrs.	1	1 0		
Reynolds, J., Esq.		0 10 6			Ruck, Mrs. Marie, on behalf of the late Josiah Ruck, Esq. (1881)			100 0 0	
Reynolds, J. N., Esq.		0 10 0			Rudge, Miss H. T., Cromer (1882)			2 0 0	
Rich, H. T., Esq., Hounslow		0 6 6			Rufford, F. T., Esq.	1	1 0		
Richards, M., Esq.		1 1 0			Rugg, Mrs. J. S.	1	1 0		
Richardson, Brothers and Co.	1	1 0			Runcorn Branch (1882-3)			20 6 3	
Richardson, James G., Esq.	1	0 0			Ruskin, Professor, M.A.	5	0 0		
Richardson, Jonathan, Esq.	1	0 0			Rust, George J., Esq.	1	1 0		
Richardson, Miss (1881-2)		7 2 0			Rutherford Brothers, Messrs.	1	0 0		
Richardson, T., Esq.	1	0 0			Rycroft, Chas. A. W., Esq. (1863-71)			25 0 0	
Rickards, Walter, Esq. (1879)		10 0 0			Ryder, Admiral A. P.	1	0 0		
Rickett, Smith, & Co., Messrs.	1	1 0			S. C. H. (1859-77)	41	11 0		
Ricketts, Miss Frederica L.	1	1 0			Ditto		1 1 0		
Riddell, Miss, Beaufort Grdns.	2	2 0			S. and E. S., Manchester (1882-3)			1 0 0	
Ridge, Henry, Esq., Stock Exchange (1876-82)		18 18 0			S. H. H., "Little Colonial"	1	1 0		
Ridgway & Co., Messrs.	2	2 0			S. M., Kensington (1882)			10 10 0	
Ridpath, E., Esq.	1	1 0			S. S., Tunbridge Wells (1882-3)			4 4 0	
Rigge, H. F., Esq.	1	1 0			S. W., per C. S. W.	1	0 0		
Riley, C., Esq.	1	0 0			S. Y. N. (1872-80)			40 0 0	
Rivaz, Charles, Esq.	1	1 0			Sabel, Max, Esq.	1	1 0		
Roake, J. J., Esq., Anerley	0	10 0			Saddlers, Worshipful Com- pany of (1877-8)			30 10 0	
Robartes, The Rt. Hon. Lord	5	0 0			Sadler, Harrison, and Co.	2	2 0		
Roberts, G. H., Esq., Augustus Square		0 10 6			"Sally-forth," per Mrs. Dalton (1878-81)			14 14 0	
Roberts, Jas., Esq., Ealing	1	1 0			Salmon, Capt. Henry Thomas (1875)			10 0 0	
Roberts, Joseph, Esq., Mina Road (1883)		100 0 0			Salt, John Chas., Esq. (1879)			10 10 0	
Roberts, Miss, Slade End	0	10 6			Salters, Worshipful Company of	5	5 0		
Roberts, W. H., Esq., Brixton (1881)	5	5 0			Samuel, Mrs. J., Nottingham Place (1881-2)			6 4 0	
Robertson, Capt. G. M.	5	0 0			Samuelson, B., Esq., M.P.	5	5 0		
Robertson, Graham, Esq., F.R.G.S., Cleveland Square (1880-2)		30 0 0			Sanders, S., Esq., De Vere Gardens			2 2 0	
Robertson, Henry, Esq., Hull (1873)	100	0 0			Sanders, F., Esq., Cross Keys	1	1 0		
Robertson, Henry, Esq., Glasgow (1880)	20	0 0							
Robertson, Mrs., Girtton (1863-79)	17	0 0							
Robertson, J. C., Esq.	1	0 0							
Robins, Miss, Woburn Place	1	0 0							

LIST OF DONATIONS AND ANNUAL SUBSCRIPTIONS.

99

	Ann. Subs.		Donations.			Ann. Subs.		Donations.	
	£.	s. d.	£.	s. d.		£.	s. d.	£.	s. d.
Sandwich, The Countess of (1872-83)			85	0 0	Shiffner, Miss J. P. (1871-83)			27	6 0
Sandwich, The Earl of	1	1 0			Shiffner, Mrs.	1	1 0		
Sandys-Lumsdaine, Mrs.	1	1 0			Short, F. B., Esq., Buckham (1878)			10	0 0
Santley, Charles, Esq. (1879)			20	0 0	Short, Mrs., Hastings			2	0 0
Sartoris, Alfred, Esq.	5	0 0			Ditto (1869-75)			55	0 0
Sartorius, Sir G. R., Admiral of the Fleet, K.C.B.	1	1 0			Shum, Robert, Esq. (1880)			10	10 0
Sassoon and Co., Messrs. D.	2	2 0			Sibthorp, Colonel	5	0 0		
Saul, G. T., Esq., Bow	1	1 0			Ditto (1874)			10	0 0
Saunders, Mrs., Durham Ter.	2	2 0			Silver, Mr., Maidenhead (1883)			1	1 0
Savage and Hill, Messrs.	2	2 0			Sim, Captain Alexander, the late	1	1 0		
Savory and Moore, Messrs.	3	3 0			Simes, N. P., Esq., Horsham	1	1 0		
Sawrey, J. H., Esq. Ulverston, (1881-83)	1	1 6			Simon and Dale, Messrs.	2	2 0		
Saxe-Weimar, General H.S.H. Prince Edward of, K.C.B.	1	0 0			Simonds, Robt. Henville, Esq.	1	1 0		
Scales and Rogers, Messrs.	0	10 0			Simmons, Henry Thos., Esq., Gensing House	1	0 0		
Scarth, W., Esq., Highbury	1	1 0			Simper, Mrs., Salisbury	1	1 0		
Schilizzi and Co., Messrs. (1867-74)			37	16 0	Simpson, B. W., Esq.	1	1 0		
Schloss Brothers, Messrs.	0	10 0			Simpson, L., Esq., the late	1	1 0		
Scholey, Mrs.	1	1 0			Simpson, The Misses, Hadley	0	10 0		
Schroder & Co., Messrs. J. H.	2	2 0			Sinclair, Mrs., Greenock (1874)			20	0 0
Scorer, A., Esq.	1	1 0			Sismey, Mrs., Hadley Green	2	2 0		
Scott & Dinham, Messrs.	1	1 0			Skinner, Thos., Esq., Downs- wood	2	2 0		
Scott, E., Esq., Colchester (1869-82)			9	7 0	Skinnners, Worshipful Com- pany of (1865-77)			52	10 0
Scott, Harold Spencer, Esq.	1	1 0			Slater, Henry, Esq.	2	2 0		
Scott, Mrs., Scalands Gate (1883)			1	0 0	Slater, John, Esq., "A Thank-offering to Almighty God for his late mer- cies"			10	0 0
Scott, Patrick, Esq.	1	1 0			Ditto	1	1 0		
Scott, Rev. Canon	1	1 0			Slater, Rev. Leonard, Bakewell (1881-3)	9	9 0		
Scott, Rev. M. R., M.A., & Miss	1	1 0			Smith and Co., Messrs. F.	2	2 0		
Scott, R. H., Esq., M.A.	1	1 0			Smith and Sons, Messrs. G.	2	2 0		
Scrimgeour, Mrs., Highgate (1872-82)	67	15 0			Smith, Colonel J. (1866-83)			93	15 0
Scrimgeour, Miss, the late, Dorking (1883)			10	0 0	Smith, Elder, and Co., Messrs. (1882)			6	6 0
Scriveners, Worshipful Com- pany of (1860-82)			42	7 0	Smith, George, Esq., Newcastle	1	0 0		
Seager, Charles H., Esq. (1872-8)			15	15 0	Smith, Geo., Esq., St. John's Wood	1	1 0		
Sebag, Joseph, Esq. (1877-81)			15	0 0	Smith, Heathfield, Esq., Epsom (1864-81)	42	0 0		
Seely, Chas., Esq., M.P. (1872)			20	0 0	Smith, J. B., Esq., Palmers Green	1	1 0		
Selborne, The Lord	2	0 0			Smith, J. MacLaren, Esq.	10	0 0		
Semple, A., Esq., Maida Vale	2	2 0			Smith, J. W., Esq., Oundle	1	1 0		
Senior, J., Esq., Streatham	2	2 0			Smith, Lieut.-Gen. J. W. S., C.B.	1	1 0		
Senior, Julian, Esq. (1877-9)			31	0 0	Smith, Miss Felix, Chester Sq. (1881-3)			5	0 0
Settle Branch (1882-3)			127	16 10	Smith, Miss S., Piperstown (1882)			0	10 0
Severn, J. P., Esq.	3	3 0			Smith, Mr. G., Walsall	0	5 0		
Sewell, Mrs., Brompton	1	1 0			Smith, Mrs., Old Park	1	1 0		
Seyd and Co., Messrs.	1	1 0			Smith, Mrs., Tavistock Square	1	1 0		
Seymour, Lieut.-Gen. W. H., C.B.	1	0 0			Smith, Mrs. Peploe	5	0 0		
Shackleton, Richard, Esq.	3	3 0			Smith, Mrs. W. Wilthew	5	0 0		
Shaffo, Mrs. J. D.	1	0 0			Smith, Samuel, Esq., Bungay	2	2 0		
Ditto in aid of Swanage Lifeboat (1875)			50	0 0	Smith, T. H., Esq., Regina Road	1	1 0		
Ditto (1881-3)			150	0 0	Smith, T. H., Esq., Holloway	1	1 0		
Sharp, A. M., Esq., Epworth	1	1 0			Smith, Thomas Valentine, Esq., Grosvenor Road (1878)			10	0 0
Sharp, Sidney, Esq.	2	0 0			Smith, Thos., Esq., Cirencester	1	1 0		
Sharpe and Co., Messrs. R.	1	1 0			Smith, W. Arthur, Esq., Bir- mingham (1873-31)			21	0 0
Sharpe, Sutton, Esq.	3	0 0			Smith, The Rt. Hon., W. H., M.P.	5	5 0		
Sharps and Wilkins, Messrs.	1	1 0			Smith, Wm., Esq., Woodfield	10	0 0		
Shaw, Miss H. E., and Miss E. S. Boyd (1883)			64	0 1	Smitheman, Mrs. E., Guildford (1879-82)			8	8 6
Shaw, Miss L. C.	0	5 6			Smithers, H. W., Esq., Moor- gate Street	1	1 0		
Shaw, Rev. F.	1	1 0			Ditto (1872)			10	0 0
Shaw, Savill, and Albion Co., Limited	1	1 0			Smythies, G., Esq.	2	2 0		
Sheffield Branch (1883)			53	18 7	Soame, The Misses	2	0 0		
Sheepshanks, W., Esq.	1	1 0			Soames, E., Esq. (1876)			10	10 0
Sheldon, Rev. J. (1881-3)			30	0 0	Soames, Miss L. K., Greenwich	0	5 0		
Sheldon, Thos., Esq., Clevedon (1882)	2	0 0			Soames, W., Esq., Blackheath	2	2 0		
Shelly, John, Esq., Plymouth (1883)	2	2 0							
Shepard & Co., Messrs.	2	2 0							
Shepherd, Arthur, Esq. (1869-74)	41	0 0							
Shepherd, Major Howell (1859-80)	50	0 0							
Shepherd, Mrs., Husberne	0	5 0							
Sherwood, Joseph, Esq. (1862-73)	15	15 0							
Shewell, Rev. Frank, M.A.	1	1 0							

	Ann. Subs.		Donations.			Ann. Subs.		Donations.	
	£.	s. d.	£.	s. d.		£.	s. d.	£.	s. d.
Society for the Discharge and Relief of Persons Imprisoned for Small Debts, additional			125	0 0	Stocken, F., Esq., Pimlico	1	1 0		
Sumner, Chas., Esq., Whitley	1	1 0			Stockport Branch (1882)			12	1 6
Somes, Mrs. Joseph	1	1 0			Stocks, Major, Halifax	2	2 0		
Somes and Co., Messrs.	1	1 0			Stone, E. M., Esq., and Mrs. Stone	5	5 0		
"Son of a Sailor, and one who has so often been exposed to the dangers of the sea" (1881)			15	15 0	Stone, J., Esq., Broad St.	1	1 0		
Soule, Bernard M., Esq.	1	1 0			Stone, Mrs. John, Ashburton	1	0 0		
Souter, Miss, Norwood	1	1 0			Stopford, Mrs. Grosvenor	1	0 0		
South Metropolitan Gas Light and Coke Company (1864-82)			78	15 0	Stowers, Rev. H. M.	1	1 0		
Southampton Branch (1883)			29	7 9	Strahan, W. S., Esq., Buxton	2	2 0		
Southard and Co., Messrs.	2	2 0			Strange, Mrs. Mary Ann	1	1 0		
Southey, Alfred P., Esq. (1883)			10	10 0	Streatfield, R. J., Esq.	5	0 0		
Southouse, H. E., Esq. (1882)			5	0 0	Street, George, Esq.	1	1 0		
Southport Branch (1883)			7	17 3	Strickland, A. E. C., Esq.	1	1 0		
Spaldin, Miss, Hull	1	1 0			Stuart, Colonel, J. F. D. C., M.P.	2	0 0		
Spalding Shipwreck Society	1	0 0			Stuart, Geo., Esq.	3	0 0		
Sparks, Mrs. Wm.	0	10 6			Stucley, Lieut.-Colonel	1	0 0		
Spartali and Co., Messrs.	1	0 0			Sturge, Geo., Esq., Woodthorpe (1882)	21	0 0		
Spawforth, Joseph, Esq.	5	5 0			Sturrock, Archibald, Esq.	2	2 0		
Spawforth, Mrs. E.	2	2 0			Stutfield, W., Esq.	1	1 0		
Spencer, Maitland, Esq., Underleigh (1875-6)			30	0 0	Stutfield, Mrs. (1867-76)			45	0 0
Spencer, W., Esq.	2	2 0			Suart, Mrs. Alfred	1	0 0		
Spencer, Rev. W. M.	1	1 0			Sugden, Richard, Esq.	1	1 0		
Sperling, Arthur, Esq.	1	1 0			Sugg, Henry, Esq., The Firs	1	1 0		
Sperring, Henry John, Esq. (1878)			10	0 0	Sullivan, Capt. T. B. M., R.N.	1	0 0		
Spies Bros. and Co., Messrs. (1879-82)			30	0 0	Summerson, T. R., Esq.	0	7 6		
Spottiswoode, James, Esq., Perth (1859-73)			30	0 0	Surr, Watson, Esq.	1	1 0		
Spreckley, White, and Lewis	2	2 0			Surrey Commercial Dock Co.	5	5 0		
Sprigens, Miss, Clapton	1	1 0			Sutherland, H., Esq., Dulwich	1	1 0		
Squire, D. B., Esq., Thurlow Road	2	2 0			Sutherland, His Grace the Duke of			5	0 0
Staffordshire Potteries Branch (1882-3)			65	12 6	Sutherland, R., Esq., Egham	5	0 0		
Stafford, The Lord (1880)			10	0 0	Swanzy, Messrs. F. and A.	1	1 0		
Stallebrass, Mrs., South Hackney	0	10 6			Swinburne, Sir J., Bart., F.R.S.	5	0 0		
Stalschmidt, E. E., Esq. (1872)			10	10 0	Sx. B.			0	10 0
Standen, Wm., Esq.	0	10 0			Ditto (1883)			2	2 0
Standidge and Co., Messrs.	1	1 0			Sykes, J., Esq.	2	2 0		
Standing, Geo. C., Esq.	0	10 6			Sykes, Miss	1	1 0		
Stanley, W. F., Esq.	1	1 0			Symes, Mrs. Elizabeth S., in addition to Poolbeg Life-boat (1881)			10	0 0
Stannus, T. R., Esq.	0	10 0			Ditto	10	0 0		
Stanton, J. T., Esq.	1	1 0			Symons, Mrs., St. Bede's (1882)			20	0 0
Starkie, Mrs. (1867-75)			21	0 0	Symonds, Wm. Thos., Esq.	2	2 0		
Starky, Mrs., Bromham	1	0 0							
"Stave In" per Mrs. Dalton (1883)			2	2 0	T. J. K. (1871-81)			15	15 0
Stead, J. J., Esq.	0	5 0			T. J. M. (1877-81)			70	0 0
Steains and Co., Messrs. J.	1	1 0			T. J. S.	0	5 0		
Stechford Branch (1883)			31	1 7	Taddy and Co., Messrs.	3	3 0		
Stedman, Miss	1	1 0			Talbot, Lady	1	1 0		
Steel, Mrs., Cockermouth (1877)			10	0 0	Tangye Bros., Messrs.	1	1 0		
Steinmetz, J. H., Esq.	1	1 0			Tanqueray & Co., Messrs. C.	2	2 0		
Stennett, J. H., Esq., Bath (1877-83)			10	10 0	Tapling and Co., Messrs. Thos.	2	2 0		
Stephen, Mrs. Leslie	2	2 0			Tapper, A. A., Esq.	1	1 0		
Stephens, A. M., Esq.	0	5 0			Turner, A. T., Esq., the late	2	0 0		
Stephens, P. S., Esq.	2	2 0			Turner, E. T., Esq.	1	0 0		
Stericker and Co., Messrs.	1	1 0			Turner, G. Edward, Esq.	1	1 0		
Sterling, Miss Julia	5	5 0			Turner, H. T., Esq.	1	0 0		
Stern, Baron Herman De, per M. Lea, Esq. (1878)			10	0 0	Turner, Miss C. T.	0	10 0		
Stern Brothers, Messrs. (1876-7)			47	5 0	Turner, Miss L. T.	0	10 0		
Stevenson, Miss H. B., Iver	3	3 0			Tarratt, Josh., Esq.	2	2 0		
Steward, Rev. C. H.	1	1 0			Tarratt, Mrs., Ashford Hall (1877)	300	0 0		
Stewart, Rev. J.	1	0 0			Tassell, Mr. F.	0	5 0		
St. Aubyn, Miss, Chertsey (1883)			1	1 0	Tate, Miss C. E.	1	1 0		
St. Germans, Earl of	2	0 0			Tatham, C. A., Esq. (1882-3)			3	3 0
Stiebel Brothers, Messrs.	1	1 0			Tattersall, John, Esq., one year's maintenance of a Life-boat station (1877)			70	0 0
Stilwell, Thomas, Esq. (1862-75)			42	0 0	Tatton, Lees W., Esq., Manchester	1	1 0		
Stirling Branch (1883)			53	0 9	Tatton, Mr. Samuel, Chorley	0	10 0		
Stock, Mrs., Bristol (In Memoriam)	2	2 0			Taunton, Miss, in memory of the late Lady Taunton	1	1 0		
					Taunton, Mr. T.	0	5 0		
					Tawke, A., Esq., and Mrs. Tawke, The Lawn, Rochford	0	10 0		

LIST OF DONATIONS AND ANNUAL SUBSCRIPTIONS.

101

	Ann. Subs.		Donations.			Ann. Subs.		Donations.			
	£.	s. d.	£.	s. d.		£.	s. d.	£.	s. d.		
Taylor and Sons, Messrs. J.	1	1	0		Tweddle, Mrs. Thomas (1872-83)			19	19	0	
Taylor, Charles, Esq., Man- ningtree	1	1	0		Twining, H. H., Esq.	1	1	0			
Taylor, J. D., Esq. (1865-82)				105	0	0					
Taylor, Rev. Alfred R.	1	1	0		Two Friends, per Miss Wor- sencroft			1	0	0	
Taylor, W., Esq.	1	1	0		Tylden, Mrs., Oxford	1	1	0			
Taylor, W. R., Esq.	0	10	0		Tyndall, W. H., Esq.	1	1	0			
Teevan, Major G. J.	1	0	0		Tyser, G. D., Esq., Lloyd's	1	1	0			
Teignmouth Branch (1882)				10	0	0					
Temperleys, Carter, & Darke	1	1	0		Tyson, Miss E. (1883)				1	1	0
Templer, R. B., Esq.	1	1	0		Tyson, Miss H. (1881-3)				1	16	0
Terry, John, Esq.	3	3	0		Tyson, Mrs. T., Penge (1881-3)				0	15	0
Tesdorpf & Co., Messrs. A.	2	2	0		Tytler, Genl. J. M. B. Fraser, C.B.	2	0	0			
Tetley and Co., Messrs. J.	0	10	0		Uhthoff & Co., Messrs.	1	1	0			
Tetley, Son, & Layton, Messrs.	1	1	0		Ulph, Messrs. J. B. and Son	1	1	0			
Tetley, The Misses, Oaklands (1869-82)				85	0	0			10	10	0
Thames & Mersey Marine In- surance Co., Royal Exchange	5	5	0		Union Steam Ship Company (1877)						
Thomas, Capt. Montagu, R.N. (1868-83)				72	0	0					
Thomas, Charles, Esq.	0	10	6		Unite, W. O., Esq.	1	1	0			
Thomas, D. C., Esq.	0	10	6		Upton, H., Esq.	3	3	0			
Thomas, G. E., Esq., Swans- wich	1	0	0		Urwick, W. H., Esq.	1	1	0			
Thomas, Mr. W., Caerphilly	0	10	0		Usborne and Sons, Messrs.	1	1	0			
Thompson, Adam, Esq.	1	1	0		Usherwood, Miss	2	2	0			
Thompson, Vice-Adm. T. P.	1	0	0		V. R. N. (1883)				0	10	0
Thompson, Henry, Esq.	1	1	0		Vacher, E. P., Esq. (1871)				10	10	0
Thompson, Messrs. W. J. & H.	2	2	0		Vacher, H. P., Esq. (1871)				10	10	0
Thorley Rectory, Bishop's Stortford	2	2	0		Vanner and Prest, Messrs.	1	1	0			
Thorngate, W., Esq. (the late), Trustees of	80	0	0		Vardon, Miss E.	1	1	0			
Thorpe, Miss	0	5	0		Vardon, Mrs. F. (1868-81)				13	10	0
Threlfall, Chas., Esq.	5	5	0		Vardon, H., Esq.	1	1	0			
Threlfall, Mrs.	1	1	0		Varnam, Miss H., Pailton	0	10	6			
Thresher, Capt. W. (1871-80)				15	15	0			30	10	0
Ditto	2	2	0		Vaughan, Henry, Esq. (1870-3)						
Thurlow, Major Edwd. H.	1	1	0		Vaughan, Mrs., Westbourne				5	5	0
Tidd, Walter R., Esq. (1873)				10	10	0					
Tillard, P. E., Esq., Godman- chester	1	1	0		Terrace				5	5	0
Tindall, Riley, & Co., Messrs.	1	1	0		Teuning, Edgcombe, Esq.	1	1	0			
Tindall, W. H., Esq.	1	1	0		Verney, Capt. E. H., R.N.	1	1	0			
Tinley, Mr. R. R.	0	10	0		Vernon, Miss Emma P.	1	1	0			
Tipplinge, T. Vernon, Esq. (1883)				2	0	0			0	10	0
Tisdall, Mr. Sidney	1	1	0		Vernon, Rev. H. J., B.A.	0	10	0			
Tobin, Lady	1	0	0		Verrall, Miss Laura, Southover (1873)	50	0	0			
Toke, Major	1	1	0		Verulum, The Earl of (1876)				10	0	0
Tollemache, Hon. Algernon Grey (1867-77)				250	0	0					
Tomlinson, Rev. J. P.	1	1	0		Veasey, Mr. and Mrs. H.	0	5	0			
Toms and Co., Messrs.	0	10	0		Veasey, Miss	0	5	0			
Topino, Madame	1	1	0		Veasey, Rev. F.	0	5	0			
Toppin, The Misses, Putney	1	1	0		Veasey, Capt. R.N. (1864-78)				21	0	0
Torquay Branch (1883)				100	0	0					
Towgood, Alfred, Esq.	1	1	0		Vigne, John, Esq.	1	1	0			
Towgood, Edw., Esq.	2	2	0		Vincent, J., Esq.	1	1	0			
Townend and Co., Messrs. T.	1	1	0		Vincent, The Misses, Pyrland Road (1881-3)				4	0	0
Toynbee, Capt. H.	1	1	0		Vivian, Younger, and Bond, Messrs.	1	1	0			
Tramore Branch (1883)				10	0	0					
Trinnell, Miss, The Parade (1883)	1	1	0		W. A. D. (1875-83)				80	0	0
Trinder, Anderson, & Co.	3	3	0		W. B., Barnsbury	1	1	0			
Trotter, William, Esq. (1872-81)				60	0	0			25	0	0
Troyte, Colonel C. A. W.	1	1	0		W. F. S., Lloyd's (1877)						
Tryon, Hon. Mrs.	1	0	0		Waddington, Mrs. J. T. (1869-78)				52	10	0
Tudor, E. O., Esq.	1	1	0		Wagstaff, James, Esq.	1	1	0			
Tudor, Mrs. W. Langley	1	1	0		Wain, R., Esq., Clifford St.	1	1	0			
Tulloch, General, R. A.	1	1	0		Wakefield Branch (1882-3)				14	8	6
Tupp, Mr. J., Tottenham Court Road (1874-83)				8	8	0					
Turle, James, Esq., M.D.	1	1	0		Wakefield, Miss M. R. (1860-73)				76	5	0
Turle, Mrs.	0	10	6		Waldegrave, the Earl				5	5	0
Turnbull, Mrs. (1883)				1	0	0					
Turner, Miss, Holloway	0	10	0		Walker, Geo., Esq.	1	1	0			
Turner, Miss I., Cotton Rectory	1	1	0		Walker Gum Company, Limited	1	0	0			
Turner, Mrs., Liverpool (1877-81)	200	0	0		Walker, John, Esq., Halifax (1876)				20	0	0
					Walker, Lady	1	1	0			
					Walker, Philip A., Esq.	1	1	0			
					Walker, W. N., Esq. (1873-83)				20	0	0
					Ditto				1	1	0
					Wallace, Brothers, Messrs.	3	3	0			
					Walrond, C. T., Esq.	1	1	0			
					Walsh, Mrs., Winchester	0	10	0			
					Walters, Rev. A. V., B.A.	0	5	0			
					Walton, Charles, Esq.	1	0	0			
					Walton, Geo., Skipton (1873)				10	0	0
					Wanklyn, J. B., Esq. (1872)				10	10	0
					Ward, Vice-Admiral J. R.	1	1	0			

			Ann. Subs. Donations.						Ann. Subs. Donations.						
			£.	s.	d.	£.	s.	d.				£.	s.	d.	
Ward, C. B., Esq.			1	1	0				White, J., Esq., Gt. St. Helens	1	1	0			
Ward, Miss, St. Leonards			0	5	0				White, John, Esq., Cowes	1	1	0			
Wardlaw, Gen. R.			1	0	0				White, Miss M. C., Brighton (1868-81)	17	10	0			
Ware, Nathl. Webb, Esq., Cork (1880)	10	0	0						White, Mrs., Brighton	2	0	0			
Warner, F., Esq., Hoddesdon	0	10	0						Whitehead, T. S. & Co., Messrs.	0	10	6			
Warner, J. T., Esq., Chertsey	0	10	6						Whiteley, George, Esq. (1871)				50	0	0
Warner, R., Esq.	2	0	0						Whiteley, Rev. John Henry, Chepstow (1882)				2	0	0
Warner, W. H. Lee, Esq., Tiverton Court (1879-81)	6	6	0						Whiteman, Stephen, Esq.	1	0	0			
Warren and Jones, Messrs.	0	10	6						Whiter, Frederick W., Esq.	1	1	0			
Warren, Mrs., Leamington (1861-83)	26	0	0						Whiting, R. M. & H., Messrs.	0	10	0			
Warton, Capt. R. Gardner	1	1	0						Whitton, John, Esq. (1883)				0	10	0
Waterall, Nathaniel, Esq.	1	1	0						Whyte, Admiral W. H.	1	0	0			
Waterall, Roby, Esq.	1	1	0						Wieting and Richter, Messrs., Demerara	1	1	0			
Waterfield, Mrs.	1	0	0						Wilbe, R. H., Esq., M.D.	1	1	0			
Waterfield, The Misses	2	2	0						Wilde, Spencer C., Esq.	1	1	0			
Waters and Co., Messrs. Jas.	1	1	0						Wilkinson, J. R., Esq.	1	1	0			
Watson, C., Esq., Halifax	2	2	0						Wilkinson, Mr., of Amoy (1882)	\$5	0	18	1		
Watson, J., Esq.	1	1	0						Wilkinson, Mrs. M. D. P., "In remembrance of a dear friend" (1874)	10	0	0			
Watson, Lieut. H. J. (1875)	12	12	0						Wilkinson, O. R., Esq.	1	1	0			
Watson, Col. W. H., R.A., in aid of Holy Island Life-boat	5	0	0						Wilkinson, Robt., Regents Park (1882-3)	20	0	0			
Watson, Mrs., Holland Park (1876-81)	60	0	0						Willans, Mrs. Russell	1	1	0			
Watson, Rev. G. Bowes	1	1	0						Willecox, Robt. M., Esq.	2	2	0			
Watts and Manton, Messrs.	2	2	0						Williams, Admiral W. J. (1871-83)	26	0	0			
Waugh, James, Esq.	1	1	0						Williams, J., Esq., Mark Lane	0	10	0			
Wayet, Rev. W.	2	2	0						Williams, O. J., Esq.	1	1	0			
Webb, Mrs. E. (1882)				0	10	0			Williams, R. B., Esq., (1871-82)	6	0	0			
Webb, R. T., Esq.	2	2	0						Williams, Rev. R., Newbury	1	0	0			
Webb, W. L., Esq.	1	1	0						Williamson, A. D., Esq., Haxby (1861-73)				31	15	6
Weber, Arthur, Esq.	1	1	0						Willimott, Miss E. A.	1	1	0			
Webster, George, Esq., Cannon Street, on account of a Life-boat (1864-83)	225	0	0						Willimott, W., Esq. (1877)	21	0	0			
Webster, Mrs., Ealing	1	0	0						Willink, W. W., Esq.	2	2	0			
Webster, W., Esq.	0	10	0						Willis, Com. G. H. R., R.N.	1	0	0			
Wedge, Fras., Esq. (1866-72)				30	0	0			Willis, H. B., Esq.	1	1	0			
Weekes, F., Esq., Midhurst (1883)				0	10	0			Willis, Henry Esq. (1876)				10	10	0
Welch, Henry, Esq. (1870-7)	31	0	0						Willis, Mrs.	1	1	0			
Welch, Margetson, and Co., Messrs.	1	1	0						Wills, Mrs.	0	10	0			
Weldon, J., Esq. (1880)				10	10	0			Wilmott, E. W., Esq.	1	1	0			
Wells, Wm., Esq., Redleaf	1	0	0						Wilson, Capt. J. E. M., R.N.	1	1	0			
Welsh, A., Esq. (1878-9)				10	0	0			Wilson, John R., Esq.	1	1	0			
Ditto	5	0	0						Wilson, L., Esq., Nurfield (1882)	1	1	0			
Welsh, W. I., Esq., Wells	1	1	0						Wilson, Lieut. William, R.N. (1874-83)				35	0	0
Wentworth, Miss L. M. H. V. (1870-9)	70	0	0						Wilson, Miss, Maidenhead (1878)				10	0	0
Ditto	2	2	0						Wilson, The Misses	4	4	0			
Wentworth, Vernon, Esq. (1876)	10	0	0						Wilson, Rev. Robert (1858-75)				102	10	0
Were, Mrs. Bouville (1860-75)	33	12	0						Wilson, Wm., Esq., Highbury	1	1	0			
Ditto	2	2	0						Wiltshire, John Walter, Esq. (1882)	30	0	0			
Western Counties Central Branch (1883)	49	13	0						Windley and Barwick, Messrs.	2	0	0			
West Hartlepool Branch (1883)	15	0	0						Windsor, Miss E.	0	5	0			
West Midland Branch (1882)	112	4	3						Wing, Thomas, Esq., Bosmore Hall (1875)				10	10	0
West of Scotland Swimming Club (1883)	0	10	0						Winn, W., Esq. (1860-80)				105	0	0
Westley, W., Esq., Regent St.	2	2	0						Winter, The Misses M. E. and E. (1869-83)				31	10	0
Westmore, Rev. H. H., M.A.	1	1	0						Wintle, Thos. D., Esq., Cheltenham (1881)				10	10	0
Weston, Ambrose, Esq. (1872-5)	31	10	0						Wire, Travers, B., Esq.	1	1	0			
Weston and Westall, Messrs.	1	1	0						Wire, Mrs. Travers B.	1	1	0			
Weston, Jas., Esq., Llandudno	1	1	0						Wise, H. C., Esq.	1	1	0			
Weston-super-Mare Branch (1883)	28	13	4						Wolverhampton Branch (1883)				38	0	0
Weston, W., Esq., Bramley (1880)	10	0	0						Wood, Chas., Esq., East Street	1	1	0			
Weymouth Branch (1882)	60	0	0						Wood, F., Esq., Sidcup	1	1	0			
Whalley, F. R., Esq.	2	2	0						Wood, J. Gathorne, Esq.	5	0	0			
Whalley, John, Esq., Blackburn (1881)	10	10	0						Wood, Mrs. B., The Lodge (1854-76)				235	0	0
Whateley, Mrs. George, Sacombe Lodge	1	1	0						Woodcock, Henry, Esq., Bolnore	2	2	0			
Whateley, Rev. C., M.A. (1882)	10	0	0						Woodhead, E. T., Esq., St. John's College (1883)				1	0	0
Wheeler, E., Esq., Stock Exch.	1	1	0						Woodhouse, Rev. J.	0	10	0			
Wheeler, George, Esq.	1	1	0						Woodroffe and Westrope, Messrs.	1	1	0			
Wheeler, H. S., Esq.	1	1	0												
Whish, Admiral (1879-83)	50	0	0												
Whitaker, T. S., Esq., F.R.G.S.1	1	1	0												
Whitaker, W. Ingham, Esq. (1883)	25	0	0												
Whitby, Messrs. W. and G.	1	1	0												
White, Brothers, Messrs.	1	1	0												

	Ann. Subs.		Donations			Ann. Subs.		Donations.	
	£.	s. d.	£.	s. d.		£.	s. d.	£.	s. d.
Woodruff, Rev. Thos., M.A.	1	1	0		X. L. V.	1	0	0	
Woods, Mrs. H. T.	1	1	0		X. Y. (1882)			25	0
Woolcott, Wm., Esq.	1	1	0		X. Y. Z. (1867-75)			215	0
Woolfe and Son, Messrs.	2	2	0		X. Y. Z. (1883)			0	16
Woolley, Miss (1877)			15	0	0	Yates, Capt. R. B.	1	1	0
Worcester Branch (1883)			33	10	10	York Branch (1882-3)			71
Workington Branch (1883)			31	0	9	Youle, F., Esq. (1863-81)			75
Worsley, Rev. P. R., M.A. (1876-82)			7	0	0	Young and Lark, Messrs.	1	1	0
Worsley, S., Esq., Clifton	1	1	0			Young, Capt. Sir A. W.	1	1	0
Worthing Branch (1883)			15	0	0	Zulueta and Co., Messrs.	1	1	0
Wright, Henry E., Esq.	2	2	0						
Wrigley, Miss, Holbeck	1	0	0						
Wrigley, Mrs., Holbeck	2	0	0						
Wyndham, Mrs., Salisbury	1	1	0						
Wynne, W. A. S., Esq., St. Olaves Priory	1	1	0						

LIST OF GENERAL COLLECTIONS, ETC., 1882-83.

	£.	s.	d.		£.	s.	d.
Aberford Alms Box, one month, per Rev. Canon Eden	1	4	0	Fines of a Mutual Improvement Society, per Miss Stolterfoht	0	10	0
Acton, the late Miss, collected in memory of, per Mrs. Gwyn	3	0	0	Finglass, W. N., Esq., Liverpool, collected by, in aid of Ramsey Life-boat	1	2	6
Adeu, Royal Artillery at, per Capt. J. J. Congdon	10	0	0	Freemasons, Leigh Lodge of, in aid of <i>Lady Leigh</i> Life-boat (Annual)	1	1	0
Adderley Church, offertory, per Rev. A. Corbet, M.A.	5	13	3	Ditto, Prosperity Lodge 65	2	2	0
All Saints Church, Tilney, collected, per Rev. S. J. Phillips	3	6	6	Ditto, Temperance Lodge 739 (Ann.)	2	2	0
Arnett, Mrs. M. A., collected by	3	1	6	Ditto, Lodge 809, Wisbeach (Ann.)	2	2	0
Ashford, Alexander Academy, Scholars and Family of Mr. T. H. Vie	1	1	0	Freemasons, "St. John," Greenock Lodge, No. 175 (annual)	2	2	0
Balham Amateur Dramatic Club, profits derived from performance, per Chas. Fenn, Esq.	2	2	0	Ditto "St. John," Contribution Box	0	5	2
Beckford Street School, Hamilton, N.B., Teachers in, per J. C. Christie, Esq.	1	10	0	Glasgow, John Street Baptist Church Sabbath School, collected by the children of, per R. Coats, Esq.	3	13	6
Berners Dramatic Club, proceeds of Entertainment, per Mr. H. Finnis	10	0	0	Goole, per F. T. Boucher, Esq.	4	9	8
Boyd and Laycock Boat Race, collected from spectators on race the s.s. <i>Baywater</i> , per H. G. Reid, Esq.	1	1	0	Gore Division, County of Middlesex, moiety of fines inflicted by the Justices of, per W. A. Tootell, Esq.	0	15	0
Boys' Own Life-boat Fund, per G. A. Hutchison, Esq.	57	13	2	Gregory, Francis, Esq., Yatton, collected by	2	11	0
Bromley, Mrs. W., Penge, collected by	10	10	0	Hadnall Church, near Shrewsbury, per Rev. Brooke C. Mortimer	20	0	0
Buffaloes, R. A. Order of, Grand Surrey Banner, per Mr. F. Gray	5	0	0	Hamilton, Mrs. G., Belfast, collected by	1	6	8
Busk, Master J. L., collected by	2	6	0	Hamilton, Rev. Benj., collected by	3	0	0
Cavell, Fredk. E. A., Esq., New Inn, collected after some Recitals at All Souls Schools, Hampstead	2	0	0	Hampstead, North End Mission Room, offerings from, per Rev. J. G. Kitchen, M.A.	0	15	6
Calcot Church, collected after a Sermon	1	3	1	Harby Church, per Rev. M. O. Norman	1	12	4
Central Finsbury Club Life-boat Fund, per Mr. Shurer	2	0	9	Harris, A. E., Esq., collected by	0	10	6
Chilton Parish Church, portion of Harvest Festival collection, per Rev. Herbert Smith, M.A.	1	1	0	Highgate, Proceeds of Concert at Northfield Hall, per G. D. Atkin, Esq.	31	7	10
<i>Christian</i> , Readers of the	20	0	6	Hotham, F. W., Esq., Buckland Rectory, collected by	2	10	0
Christ's Hospital, collected from the Boys of, per Rev. R. Lee, M.A.	2	2	0	Howell, Mrs. Conrad, coll. from Friends Jarrett, Chas. Esq., contributed by his children	1	12	0
Ditto, per Rev. John T. Bell	2	5	0	Johnson, Adml., col. by (Annual)	14	4	6
Clevedon, collected at, per Mrs. Lavington, additional	9	4	3	Johnson, Miss, Wrexham, collected by	4	2	0
Cordwalles, Maidenhead, pupils at, per Rev. F. J. Nunns	1	1	0	Johnson-Smyth, Miss Lillie, Donnybrook, collected by	1	0	0
Crouch Hill English Presbyterian Church Sunday School, collected at, per W. Brande, Esq.	1	1	0	Liverpool Bank, Water Street, collected from officers, per Mr. James Lahy	2	2	0
Demerara, West Indies, collected by M. R. O'Maley, Esq. (Annual)	11	11	0	Maidstone Prison, Moiety of offertory for the past two years, per Rev. A. H. Harrison	1	1	0
Elvetham Parish Church, collected in, per Rev. W. Gill	6	14	6	Martin, Lieut. Leslie, collected by	2	16	3
				Maude, John, Esq., collected by, in aid of Port Erin Life-boat	7	0	0
				Newton-by-Sudbury, share of harvest thank-offering, per Rev. Reginald Smith	1	5	0

	£.	s.	d.		£.	s.	d.
Odd Fellows, Independent Order of (M.U.), Loyal Hope of Bloomsbury Lodge	1	1	0	St. Clement's Youth's Institute, per G. King, Esq.	1	0	0
Ditto, Loyal Friendly Mechanics Lodge, Bristol District	0	10	6	St. Giles' Christian Mission, collected at, per G. Hutton, Esq.	1	0	8
Ditto, Hope Lodge, Southampton (Annual)	1	1	0	Smith, Master W. Haynes, Clarendon Place, collected by	0	10	0
Ditto, Nelson Lodge, Norwich (Annual)	2	2	0	S. P. Q. P., Surplus after paying expenses of the, per T. C. Hewett, Esq.	1	1	0
Ditto, Prosperity Lodge, Norwich (Annual)	1	1	0	Stubton Church, offertory at, per Rev. P. R. Worsley, M.A.	2	0	0
Oxford Gas Works employes, per J. Eldridge, Esq.	2	16	10	Sunningdale School, collected in school chapel amongst the boys, per Dr. Girdlestone	2	12	2
Park Chapel Boys' Sunday School, per Mr. Ernest Wench	1	7	6	Temple, Mr. M. H., further on account of his Life-boat Fund	3	0	0
Parkhead, U. P. Church Sabbath School, per Wm. Young, Esq.	0	18	7	"Toby," collected by Mrs. Mayor	1	14	8
Parsons, Mrs., Clifton, collected by	2	10	0	Underriver, offertory at St. Margaret's Church, per Rev. C. R. Hardy	2	1	0
Penruddocke, Miss, proceeds of Sale of Work	0	11	10	Veasey, Miss, Woburn	2	3	6
Peterborough, collection at St. Paul's Church on Christmas Day, per Rev. C. R. Ball, M.A.	2	6	5	Webster, George, Esq., further on account of his Life-boat Fund	25	0	0
Railway Clearing House, collected at, per Hy. Turner, Esq.	2	12	6	Willis, J. H., Esq., Swindon, collected by	0	10	6
S. Michael's Life-boat Fund, per Rev. G. F. Prescott, M.A., towards support of Kessingland No. 2 Life-boat	28	6	11	Wroxham, proceeds of Concert at, per A. J. N. Chamberlin, Esq.	4	0	0

CONTENTS OF PILLAR AND OTHER CONTRIBUTION BOXES, 1882-83.

(In addition to those included under "SEAMEN'S COLLECTIONS.")

	£.	s.	d.		£.	s.	d.
Alexandra Palace Pillar Box	0	6	6	Macclesfield, per Mr. T. R. Comberbach	0	11	2
Allen, Ashton C., Esq., Park Crescent	7	18	9	Maitland, J. M., Esq., Downes Place	1	2	10
Allen, Mr. C. B., Kilburn	0	18	6	Manufacturers' Exhibit and Shippers' Sample Room, per J. E. Dawson, Esq.	0	6	1
Argyll House Box, per M. E. W. E. C. Basingstoke Railway Station, per Mr. J. Harvey	0	14	6	"Margaret" Box, per Mrs. Etherington Smith, in aid of Joseph Sykes Life-boat at Uppang	2	14	0
Batson & Sons, Brewer Street	2	4	0	Martin, J. S., Esq., Montague Place	2	3	0
Brickwell, Mrs., Amersham	0	15	6	Milward, Rev. H. C.	1	9	7
Brittain, J., Esq., Ilkeston	0	12	9	Newnham, Miss S., Corsham	0	10	0
Burnley, Thorn Hotel, per Mr. G. C. Ogden	1	1	0	Nixon, Miss M., West Kirby	1	10	0
Chorlton-cum-Hardy, Masonic Hall Billiard Club, per R. Davies, Esq.	1	1	0	Norsworthy, G., Esq., Nettlebed	2	7	0
Clowes, Mrs., Stockwell	0	14	0	Old Bell Hotel, Holborn, per Miss Bunyer	2	10	0
Conlon, F. P., Esq., Lincoln	0	7	7	Ramsgate Pillar Box, per Captain Jones	4	19	9
Cox and Son, Messrs., Chancery Lane	0	13	8	Do. Contribution Boxes at Hotels, &c.	2	5	10
Crystal Palace, per Dr. Price	6	6	11	Robinson, H. P., Esq., Clapham	1	0	9
Dashwood, C. E., Esq., box on board the Griffin	3	0	0	Schloesser, Master W.	0	11	0
Farrar, Miss, Brixton	1	11	6	Scrimgeour, Miss, the late	1	9	0
Fenchurch Street Railway Station	5	3	7	Shuckburgh, Sir Geo., Bart.	19	3	5
Geary, Mr. W. N., Tunbridge	2	0	0	Southampton Pillar Box	1	16	7
Hancocks, Alfred, Esq., Wolverley	3	0	0	Strutt, Miss Susan, Belper	1	0	0
Harris, Master Josh. C., Calne	0	12	6	Tompkins, Mr. F. G., Birmingham	0	10	6
Hayes, Mrs. L., New Hampton	3	2	2	Tupp, Mr. John, Tottenham Court Road	1	10	0
Jeffery, Miss C., Walworth	0	10	6	Victoria Railway Station	1	8	8
Jersey, Pillar Box, per J. Sullivan, Esq.	1	9	0	Willins, Mrs., Romford	0	5	0
Johnson, Mrs., Hoddesdon	10	9	3	Wood, Mrs. A. L., Louth	1	8	6
La Touche, Mrs. Ashley, Parkstone	0	12	0	Woodley & Co., Messrs., Mark Lane	0	9	8
Keswick Hotel, per Messrs. Frank & Coles	2	0	0				
Liverpool Street, Great Eastern Railway Station	2	19	9				

COLLECTIONS FROM SEAMEN AND OTHERS, BY COLLECTORS OF CUSTOMS, BY THE AGENTS OF THE SHIPWRECKED MARINERS' SOCIETY, AND BY OTHERS, IN 1882-83.

	£.	s.	d.		£.	s.	d.
Belfast, per E. Foyster, Esq.	2	17	0	Newport, Monmouth, per Caleb Cox, Esq., and W. Walker, Esq.	6	9	0
Belfast Mercantile Marine Office, per J. B. White, Esq.	5	17	4	<i>Orient</i> , Steam Navigation Co.'s s.s., per Capt. Hewison	16	0	0
Blyth, per Mr. J. Robinson, Jun.	4	10	0	<i>Pegasus</i> , ship, of Liverpool, collected by Capt. O. Owen	1	13	0
Boston, per J. E. Ridlington, Esq.	0	15	6	Perth, per C. N. Buchanan, Esq.	0	12	9
Bristol, per G. C. Whitwill, Esq., and Mr. E. A. Atwood	9	17	0	<i>Phœnician</i> , s.s., collected by Capt. J. Brown	1	8	8
<i>Buenos Ayrean</i> , s.s., collected on board, per Captain McLean	0	16	3	Plymouth Mercantile Marine Office, per H. M. Shapcott, Esq.	3	4	4
<i>Caduceus</i> s.s., collected from the Officers and Crew, per Capt. W. H. Jennison	0	15	0	Port William, per Thos. Whyte, Esq.	0	10	0
<i>City of York</i> , Officers and Crew of the ship, per Capt. W. M. Greive	3	5	0	Portsmouth, per Robert Raggett, Esq.	1	1	0
Cork, per Messrs. P. R. Day & Son	0	6	0	<i>Potosi</i> s.s., proceeds of concert on board, per Capt. C. E. Darby	9	5	0
Galway, per G. W. Carr, Esq.	2	0	0	<i>Prussian</i> , s.s., per Capt. McDougal	6	13	6
Glasgow, per M. O' Holloran, Esq.	128	14	0	<i>Rollo</i> s.s., Offertory on board, on the 16th July, 1882, per Capt. Peppers	2	4	3
Grangemouth, per A. D. Gowing, Esq.	2	3	0	<i>Scandinavian</i> s.s., per Capt. Park	2	17	2
<i>Grecian</i> , s.s., collected on board, per Captain Le Gallais	3	18	4	"Sea-going Engineers," collected from, per T. Richardson, Esq.	8	0	0
Greenock, per A. Gosset, Esq.	1	0	0	<i>Sorata</i> s.s., collected on board, per Capt. G. E. Dixon	6	12	0
Grimsby Mercantile Marine Office, per H. N. Malan, Esq.	0	11	6	Southampton Mercantile Marine Office, per G. S. Coxwell, Esq., and James Lyons, Esq.	12	11	0
Hull, per T. Gray Jones, Esq.	1	13	6	St. Andrew's, per N. McLeod, Esq.	0	13	0
Hull, per J. W. Day, Esq.	10	0	0	Stockton, per J. W. D. Keogh, Esq.	1	18	0
Jersey, per George Clayton, Esq.	0	16	0	Sunderland, per Messrs. R. Hudson and Sons	0	18	0
Kirkcaldy, per Emra Holmes, Esq.	2	9	10	<i>Tenedos</i> , H.M.S., collected on board, per Rev. J. M. Clarkson, R.N.	1	13	5
Leith, per F. Franklin, Esq.	5	5	5	<i>Triumph</i> , H.M.S., Band Fund, per Commander Acland, R.N.	16	10	0
Liverpool, per W. G. Stewart, Esq.	1	13	6	Truro, per R. W. Edrupt, Esq.	2	4	0
London Custom House, per J. W. Douglas, Esq.	1	0	6	<i>Waldensian</i> , steamer, collected on board, per Captain R. P. Moore	4	1	0
Llanelli, per R. V. Innes, Esq.	0	15	5	Waterford, per W. Dear, Esq.	1	3	0
Maldon, per T. Playford, Esq.	0	11	6	Wigtown, per R. Chalmers, Esq.	0	13	6
<i>Manitoba</i> , s.s., collected on board, per Capt. A. Macnicol	6	2	0	Wisbeach, per J. H. Webb, Esq.	3	15	6
Montrose, per H. Petherick, Esq.	2	12	0				
Montrose, per Lawrence S. Smith, Esq.	1	18	6				
Newport Mercantile Marine Office, per Jas. Lyons, Esq., and T. Porteous, Esq.	8	12	8				

FORM OF BEQUEST OF MONEY, STOCK, OR OTHER PERSONAL ESTATE.

I give and bequeath to the ROYAL NATIONAL LIFE-BOAT INSTITUTION for the Preservation of Life from Shipwreck, founded in 1824, London, the sum of £ for the use of the said Institution; and I do hereby direct that the same be paid exclusively out of such part of my Personal Estate as may lawfully be appropriated to such purpose, and that the receipt of the Treasurer for the time being of the said Institution shall be a sufficient discharge to my Executors for the same.

ROYAL NATIONAL LIFE-BOAT INSTITUTION,
14 John Street, Adelphi, London,
1st May, 1883.

SPECIAL LIFE-BOAT CONTRIBUTIONS.

CIVIL SERVICE LIFE-BOAT FUND.

Patron—
His ROYAL HIGHNESS THE DUKE OF
EDINBURGH, K.G., K.T. &c.

Treasurer—
CHARLES G. TURNER, Esq.

Hon. Secretary—
CHARLES DIBDIN, Esq., F.R.G.S.

Annual Subscriptions of 2s. 6d. have
been promised in aid of the above
Fund by 6403 gentlemen in the follow-
ing Government Departments:—

Admiralty.....	287
Board of Trade.....	56
British Museum.....	73
Charity Commission.....	50
Chatham Dockyard.....	18
Civil Service Commission.....	37
Colonial Office.....	29
Copyhold Commission.....	36
Court of Bankruptcy.....	51
Customs.....	728
Devonport Dockyard.....	25
Duchy of Lancaster Office.....	4
Ecclesiastical Commission.....	47
Education Department.....	62
Exchequer and Audit Office.....	124
Foreign Office.....	56
Gazette Office.....	5
General Post Office.....	785
Great Seal Patent Office.....	68
High Court of Justice.....	309
Home Office.....	68
House of Commons.....	32
House of Lords.....	26
India Office.....	110
Inland Revenue.....	1092
Local Government Board.....	123
Miscellaneous Post Offices.....	227
National Debt Office.....	46
Nautical Almanac Office.....	10
Office of Commissioners in Lunacy.....	6
Office of Woods and Forests.....	73
Office of Works.....	55
Paymaster-General's Office.....	37
Pembroke Dockyard.....	11
Portland Prison.....	4
Portsmouth Dockyard.....	61
Privy Council Office.....	19
Public Record Office.....	27
Public Works Loan Office.....	15
Queen Anne's Bounty.....	17
Record Office of Seamen.....	37
Registrar-General's Office.....	118
Registry of Friendly Societies.....	12
Royal Carriage Dept., Woolwich.....	4
Royal Chelsea Hospital.....	9
Royal Clarence Yard, Gosport.....	9
Royal Laboratory, Woolwich.....	9
Royal Mint.....	55
Royal Victoria Yard, Deptford.....	14
Royal William Yard, Portsmouth.....	4
Science and Art Department.....	55
Sheerness Dockyard.....	20
Stationery Office.....	47
Treasury.....	50
War Office.....	156
Miscellaneous.....	22

SCOTLAND.

Auditor of the Court of Session Office.....	2
Bankruptcy, Office of Accountant Board of Lunacy.....	1
Board of Manufactures.....	8
Board of Supervision.....	15
Chancery Office.....	3
Commissary Office.....	2

Court of Session.....	12
Crown Office.....	5
Customs, Greenock.....	9
Exchequer.....	10
Fishery Board.....	3
General Post Office.....	82
Miscellaneous Post Offices.....	186
General Register of Sasines.....	46
General Registry Office.....	7
Horning Office.....	1
Inland Revenue.....	101
Inland Revenue, Glasgow.....	79
Judiciary Office.....	5
Lord Clerk Register's Office.....	6
Northern Lighthouse Board.....	4
Office of Works.....	1
Prison and Judicial Statistics.....	21
Register of Deeds and Probative Writs Office.....	13
Registry of Friendly Societies.....	1
Science and Art Department.....	2

IRELAND.

Constabulary Office, Dublin.....	7
Customs.....	12
General Post Office.....	120
General Survey and Valuation Office.....	26
High Court of Justice.....	8
Inland Revenue.....	34
Miscellaneous Post Offices.....	16
Lunatic Asylums Office.....	1
Office of National Education.....	59
Registry of Deeds Office.....	5
Registry of Friendly Societies.....	1
Total.....	6,403

THE "COVENT GARDEN"
LIFE-BOAT FUND.

Amounts handed to the NATIONAL LIFE-BOAT INSTITUTION by the Stewards of this Fund, being the Contribution for the year 1882, in aid of the support of the Covent Garden Life-boat, now stationed at Caister, near Great Yarmouth.

£.	s.	d.
1850		
1911		
1911		
1941		
1946		
2140		
2206		
2293		
2298		
2357		
2309		
2436		
2436		
2504		
2572		
2572		
2545		
2622		
2634		
2658		
2661		
2707		
2732		
2762		
2772		
2804		
2918		
2932		
2950		
2992		
3044		
3062		
3079		
3132		
3157		
3200		
3427		
3470		
3529		
3597		
3690		

THE "FORESTER" AND
"FORESTERS' PRIDE"
LIFE-BOATS FUND.

List of Voluntary Contributions received for the Fund from the following DISTRICTS, COURTS, &c., of the ANCIENT ORDER OF FORESTERS, from January 31, 1882, to January 31, 1883, per SAMUEL SHAWCROSS, Esq., P.S.

£.	s.	d.
3470		
3470		
3529		
3597		
3690		
3351	7	7

DISTRICTS.

Brighton.....	2	0	7
Bucks, &c.....	-	11	6
Denny.....	1	10	0
Devon, &c.....	2	5	0
Dorking, &c.....	-	10	0
Flintshire.....	1	1	0
Greenwich, &c.....	4	8	2
Hyde, &c.....	-	13	3
London United.....	36	10	6
South London.....	4	3	6
South Western.....	6	15	0
Tunbridge Wells.....	-	19	8
Vale Royal, &c.....	1	0	0
Watford, &c.....	-	9	3
Westmoreland.....	-	10	0

COURTS.

71.....	-	7	6
140.....	-	10	0
144.....	-	5	0
159.....	-	6	0
363.....	-	11	6
663.....	-	10	6
705.....	-	6	5
732.....	-	18	0
757.....	-	9	0
793.....	-	5	4
851.....	-	6	0
957.....	-	10	0
1007.....	-	6	6
1057.....	-	10	0
1131.....	-	5	9
1142.....	1	5	3
1157.....	-	10	0
1193.....	-	12	0
1298.....	-	10	0
1407.....	-	8	3
1469.....	1	1	0
1548.....	1	1	0
1549.....	-	6	9
1556.....	1	0	0
1701.....	-	10	0
1744.....	-	15	8
1758.....	-	10	0
1850.....	-	6	4
1911.....	1	0	8
1941.....	-	11	6
1946.....	-	10	0
2140.....	-	10	0
2206.....	1	0	0
2293.....	1	1	0
2298.....	-	7	9
2357.....	-	10	0
2309.....	1	1	0
2436.....	2	17	11
2436.....	-	8	0
2504.....	-	10	6
2572.....	-	10	0
2572.....	-	10	0
2545.....	-	5	4
2622.....	5	1	6
2634.....	-	6	0
2658.....	-	5	0
2661.....	-	10	0
2707.....	-	6	3
2732.....	-	10	6
2762.....	-	5	0
2772.....	1	1	0
2804.....	-	5	0
2918.....	-	10	6
2932.....	-	10	0
2950.....	-	10	0
2992.....	-	10	0
3044.....	-	11	11
3062.....	-	15	0
3079.....	-	17	6
3132.....	5	5	0
3157.....	-	10	0
3200.....	-	10	0
3427.....	-	5	2
3470.....	1	8	0
3529.....	1	2	6
3597.....	-	7	7
3690.....	-	7	6

	£.	s.	d.
3715	-	10	3
3721	-	10	8
3896	-	5	2
3936	-	5	0
3970	2	0	0
4050	-	5	0
4148	-	10	0
4165	-	10	0
4195	-	5	0
4399	-	5	0
4408	-	5	0
4548	-	10	0
4551	-	8	4
4555	-	5	0
4640	-	10	6
5106	-	7	6
5179	-	15	6
5180	-	15	8
5464	-	5	0
5621	-	7	3
5625	1	0	0
5678	-	11	6
5747	-	6	7
5807	-	5	0
5836	1	17	6
5949	-	8	0
5956	-	5	0
6031	-	7	10
6097	1	1	0
6108	-	5	0
6357	-	11	6
Dividend on £450 New 3 per Cents.	13	10	0
Interest on Mortgage	2	5	0
Sums under 5s.	7	13	7
Total	£3,498	2	11

THE "MANCHESTER UNITY" LIFE-BOAT FUND.

Contribution from The INDEPENDENT ORDER OF OLD FELLOWS (Manchester Unity) FRIENDLY SOCIETY, for the year 1882, per THOMAS COLLINS, Esq., Secretary.

£50 0 0

"MARK LANE" LIFE-BOAT FUND.

Hon. Sec.—H. KAINS-JACKSON, Esq.

Subscriptions at Christmas, 1882-3.

	£.	s.	d.
A. B.	1	0	0
Agerup, Petersen & Co., Messrs.	5	0	0
Anderson and Boyd, Messrs. G. and A.	10	6	0
Aste, Son, and Kerchevall, Messrs.	1	1	0
Baucher, Mr. B. L.	10	0	0
Beane and Newton, Messrs.	10	6	0
Bezbie, Ross, and Gibson, Messrs.	10	0	0
Bell and Co. Messrs. A.	10	0	0
Bellamy, Mr. W. C. B.	10	6	0
Borrowman & Phillips, Messrs.	1	1	0
Bovill and Co., Messrs.	1	1	0
Bovill and Sons, Messrs. Benj.	10	6	0
Bowyer, Messrs. S. and H.	10	0	0
Chatterton, Mr. J. H.	1	1	0
Child, Messrs.	10	0	0
Church, Mr. A. G.	10	0	0
Claudius and Chattaway, Messrs. G. F.	10	0	0
Cole, Mr. R.	10	6	0
Colman, Messrs. J. and J.	10	6	0
Corder, Mr. F. J.	10	6	0
Coventry and Sheppard, Messrs.	10	0	0
Denny, Messrs. C. and J.	10	0	0
Dewar and Webb, Messrs.	1	1	0
Doo, Mr. G.	1	0	0
Doo Brothers, Messrs.	7	6	0
Dornbusch's List	10	0	0
Dunham, Wm. ("The Miller")	10	0	0
Dunkin, John & Co.	10	0	0
Easton, T. & W.	10	0	0
Edwards Brothers, Messrs.	10	6	0
Friend in Distress, A.	10	0	0
Gade and Co., Messrs.	10	0	0
Girdwood and Co., Messrs.	10	0	0
Gregory and Co., Messrs.	10	6	0
Gripper & Sons, E.	10	6	0
Harris Brothers, Messrs.	1	1	0
Hastie, Mr. P.	5	5	0
Hewitson R. and J., Messrs.	10	0	0
Hopkinson, Mr. C.	5	0	0
Horne and Son, Messrs.	1	1	0
Hutchinson, Mr. F.	10	0	0
James and Sons, Messrs.	10	0	0
Jones and Sons, Messrs. R. P.	10	0	0

	£.	s.	d.
Judkins, Connorton, and Son, Messrs.	10	0	0
Kains-Jackson, Mr. H.	10	6	0
Klein & Sons, Messrs.	10	0	0
Ledger, Mr. E. W.	10	0	0
Lenders and Co., Messrs. F.	1	1	0
Maldlow and Sons, Messrs.	10	6	0
Marshall, Mr. J.	10	6	0
Mongredien, Ellerby, and Co., Messrs.	10	0	0
Muggeridge, Mr. T. B.	10	0	0
Muggeridge and Co., Messrs. Wm.	10	0	0
Mumford, Messrs. S. P. & C.	10	0	0
Nixon, Gower, and Co., Messrs.	10	0	0
Patent Granary Company	1	1	0
Peek, Frean, and Co., Messrs.	1	1	0
Perks, Messrs. J. B. and T. H.	10	0	0
Power, C. G.	10	0	0
Rathbone and Son, Edward, Messrs.	10	6	0
Roberts, Chas. & Co., Messrs.	10	0	0
Robinson, Mr.	10	6	0
Roffey and Son, Messrs.	1	1	0
Rumford, Messrs. L. M. and C.	10	0	0
Skelton, Mr. T. W., col. by	2	15	0
Smith, Mr. Walter	10	6	0
Smith & Sons, Messrs. B.	10	6	0
Spartali and Co., Messrs.	1	1	0
Struckenschmidt, Mr.	1	1	0
Taylor, Mr. Seth	10	0	0
Tidy, J.	10	0	0
Tyser and Pechey, Messrs.	10	6	0
Usborne and Son, Messrs.	10	6	0
W. M.	10	0	0
Watney and Keene, Messrs.	10	6	0
Watson, Medill & Co. Messrs.	1	1	0
Webster Brothers, Messrs.	10	6	0
Woodley and Co., Messrs.	10	0	0
Wright and Sons, Messrs. R.	1	1	0
90° in the shade	1	1	0
Sums under 5s.	6	6	0
Total	£57	0	6

INDEX TO THE BRANCHES.

	PAGE		PAGE		PAGE		PAGE
ABFRAYTON	110	DARTMOUTH	117	LIVERPOOL	129	RYE	146
ABERDEEN	153	DAWLISH	117	LIZARD (POLPEAR)	112	SALCOMBE	119
ABERDEEN	134	DREBY	116	LLANDDULAS	116	SALTHERN	151
ABERDEEN	111	DOUGLAS	171	LLANDUDNO	111	SCARBOROUGH	151
ABERSOCH	110	DOVER	127	LLANGLY	111	SCILLY	115
ABERYSTWTH	156	DOWN	127	LLANLIDNO	169	SERAHAM	122
ACKERHILL	142	DROGHEDA	169	LONDONDERRY	163	SEASCALE	112
ACOCK'S GREEN	142	DUBLIN	167	LOOE	112	SEATON CAREW	125
ALDBOROUGH	156	DUNBAR	161	LOSSIEMOUTH	159	S-LEY	143
ALLOA	137	DUNCANNON	170	LOWESTOFT	142	SENNEN	113
ALNMOUTH	109	DUNDALK	169	LYDD	127	SKTLE	151
ANGLSEY	159	DUNDEE	160	LYME REGIS	121	SHEFFIELD	152
ANSTRUTHER	116	DUNGENESS	127, 128	LYNMOUTH	118	SHERINGHAM	136
APPLEDORE	160	DUNFERMLIN	159	LYTHAM	131	SHOREHAM	146
ARBROATH	169	DUNGARVAN	169	MACDUFF	135	SIDMOUTH	119
ARDMORE	154	DUNWICH	142	MANCHESTER	131	SILLOTH	115
ARDROSSAN	270	DURNAM	222	MARGATE	129	SKERRIES	189
ARKAN	156	EASTBOURNE	145	MARYPORT	115	SOLVA	139
ARKH	154	EDINBURGH	156	MELROSE	164	SOUTHAMPTON	126
BALBRIGGAN	168	ENNISKILLEN	164	MEVAGISSEY	113	SOUTHERN (CANTYRE)	154
BALLANTRAE	156	ESSEX	123	MIDDLESBROUGH	150	SOUTHEND (ESSEX)	124
BALLYCOOTON	186	EKETER	117	MILFORD	139	SOUTHPORT	133
BALLYWALTER	187	KXM JUTH	117	MONROE	160	SOUTHWOOD	143
BAMBURGH CASTLE	137	FISHMOUTH	155	MORAY FIRTH	163	STAFFORDSHIRE	141
BANFF	155	FALMOUTH	112	MORTE	118	ST. ANDREW'S	160
BANNOCKBURN	164	FIFE	148	MULLION	113	ST. ANN'S	132
BARMOUTH	134	FISHGUARD	139	MUNDESLEY	136	ST. DAVID'S	139
BARNSTAPLE	116	FLAMBOROUGH	149	MUSSELBURGH	169	ST. IVES	114
BATH	140	FLKETWOOD	129	NEWARK	138	ST. LEONARD'S	145
BELFAST	165	FOWY	112	NEWBIGIN	138	STATHES	152
BELPER	116	FRASERBURGH	154	NEW BRITON	129	STEIFORD	147
BEMBRIDGE	126	GIRVAN	155	NEWBURGH	164	STIRLING	164
BERWICK	137	GLASGOW	161	NEWCASTLE (DUNDEUM)	167	STOCKPORT	112
BIDFORD	116	GOODWIN SANDS	127	NEWCASTLE-ON-TYNE	138	STONEHAVEN	161
BRIMINGHAM	146	GORBLETON	142	NEWHAVEN	145	STRONNESS	163
BLACKBURN	123	GOURDON	161	NEWQUAY (CARDIGAN)	110	SUNDERLAND	123
BLACKPOOL	128	GRANTON	156	NEWQUAY (CORNWALL)	113	SWANAGE	122
BLAKENY	135	GREENOCK	164	NEW ROMNEY	128	SWANSEA	125
BLOCKLEY	147	GREENCASTLE	163	NEWTON ABBOT	118	TRIGNMOUTH	119
BLYTH	137	GRYSTONES	170	NORFOLK	134	TRBY	139
BOLTON	128	GRIMSBY	134	NORTHAMPTON	136	TURBE	142
BOSTON	134	GROOMSPORT	165	NORTH BERWICK	161	TURSO	166
BOULMER	137	GURNESEY	171	NORTH DEAL	127	TORBAY	120
BRADFORD	148	HARTLEPOOL	122	NORTH SUNDERLAND	138	TORQUAY	129
BRANCASTER	135	HARWICH	124	NOTTINGHAM	138	TYNEMOUTH	138
BRAUNTON	116	HASBROUGH	135	ORMSKIRK	132	TRALKE BAY	168
BRIDGWATER	140	HASTINGS	145	PADSTOW	113	TRAMORE	169
BRIDLINGTON	148	HAUXLEY	137	PALING	136	THOON	155
BRIDPORT	121	HAYLE	112	PAKEFIELD	142	TYRELLA	167
BRIGHTON	143	HAYLING	125	PREBLES	163	UPGANG	152
BRISTOL	125	HENLEY	139	PEMBREY	111	VALENTIA	168
BROADSTAIRS	126	HOLYHEAD	109	PENARTE	124	WAKEFIELD	152
BUCKIE	155	HOLY ISLAND	137	PENZANCE	113	WALMER	127
BUDE	112	HOPE COVE	119	PETERBOROUGH	137	WATCHET	140
BURNHAM	140	HORNSEA	149	PETERHEAD	154	WATERFORD	170
BURTON-ON-TRENT	141	HUDDERSFIELD	149	PIEL	132	WELLS	136
CADGWTH	112	HULL	149	PLYMOUTH	118	WESTERN COUNTIES	
CAHORE	169	HUMA	156	POOLE	121	CENTRAL	120
CAISTER	136	HUMFRANTON	135	PORTHCAWL	125	WEST HARTLEPOOL	123
CAMBRIDGE	110	HYTME	127	PORTHDLINLLAEN	111	WEST MIDLAND	140
CAMPBELLTOWN	154	ILFRACOMBE	118	PORTRHUVEN	114	WESTON-SUPPER-MARE	140
CARDIGAN	110	IPSWICH	142	PORTRHOUSTOCK	114	WEXFORD	170
CARDIFF	124	IRVINE	165	PORT ISAAC	114	WYEMOUTH	122
CARLISLE	115	ISLE OF ARRAN	156	PORTLOE	114	WHITBY	123
CARMAISTHEN BAY	111	ISLE OF PURBECK	121	PORT LOGAN	165	WHITBY	152
CARNSORE	170	ISLE OF WHITHORN	165	PORTMADOC	111	WHITEHAVEN	115
CASTLETOWN	170	ISLE OF WIGHT	126	PORT PATRICK	165	WHITELINK BAY	154
CAVAN	166	KIRKLEY	150	PORTRUSH	166	WHITHORN	165
CHELTENHAM	125	KELSO	164	PORTSMOUTH	125	WICK	156
CHESTER	111	KINGSGATE	127	PURBECK	121	WICKLOW	170
CHESTER HARBOUR	143	KING'S LYNN	135	QUEENSTOWN	166	WINCHELSEA	146
CLACTON-ON-SEA	123	KINGSTOWN	167	KAMSEY	171	WINTERTON	136
CLOVELLY	117	KIRKCUDBRIGHT	161	READING	109	WITHERNSA	153
COLCHESTER	123	KIRKJUSTON	163	REDGAR	150	WOLVERHAMPTON	141
CORK	166	LANCASTER	129	RHYL	124	WORCESTER	147
COURTMACHERRY	166	LEKES	150	ROBIN HOOD'S BAY	150	WORKINGTON	116
COURTOWN	170	LEKE	141	ROCHDALE	132	WORKING	146
CRESSWELL	137	LEICESTER	133	ROCHESTER	128	YARMOUTH	136
CROMER	135	LEITH	156	ROSSLARE	170	YEALM RIVER	121
CRUDEN BAY	153	LIMERICK	168	RUNCORN	112	YORK	153
CULLECOATS	138	LINCOLNSHIRE	133	ROGERSTOWN	168	YOUGHAL	166
DALKRITH	166	LITTLEHAVEN	139	RUNSWICK	161		

SPECIAL LIFE-BOAT CONTRIBUTIONS.

CIVIL SERVICE, p. 106; COVENT GARDEN, p. 106; FORESTERS, p. 106; MARK LANE, p. 107; ODD FELLOWS, p. 107.

LISTS OF CONTRIBUTORS TO THE
BRANCHES OF THE ROYAL NATIONAL LIFE-BOAT INSTITUTION.

Amounts acknowledged in these Lists are those chiefly received between 1st April, 1882, and 31st March, 1883. ;
The sign (*) opposite the name of a Contributor indicates that he is on the Local Committee.

ENGLAND AND WALES.

Anglesey.

ANGLESEY BRANCH.

Treasurer and Hon. Sec.—
WILLIAM PRESTON, Esq.

Annual Subscriptions.

£.	s.	d.
Atkinson, John, Esq.	10	0
Bangor, Bishop of...	2	2
Barber, H. Esq.	10	6
Beever, J. F. Esq.	1	1
Boston, The Right Hon. Lord	2	0
Clegg, Henry, Esq.	1	1
Davies, R. Esq. M.P.	2	0
Davies, Robert, Esq.	2	0
Duff, C. G. Esq.	10	0
Duncaft, J. Esq.	10	0
Edwards, Miss E. W.	1	0
Evans, T. F. Esq.	10	0
Eynton, T. Wynne, Esq.	1	0
Fluett, T. Esq.	1	0
Gartside, John H. Esq.	1	1
Gartside, Mrs.	1	1
Griffith, Miss Conway	1	0
Griffith, W. G. Esq.	1	0
Hall, J. Esq.	1	0
Hampdon, Miss	10	0
Herbert, Rev. E.	10	0
Hughes, General.	10	0
Hughes, R. Jones, Esq.	1	0
Hussey, Horace, Esq.	1	0
J. W.	1	7
James, R. L., Lieut. R.N.A.V.	1	1
Jones, Archd. Wynne	10	0
Jones, P. Nicholls, Esq.	1	0
*Lewis, Col. Hampton	1	0
J. W.	1	0
Lewis, Miss.	10	0
Lewis, Wm. P. Esq.	1	0
Lingham, F. H. Esq., per Rhosneigr Life-boat	1	1
Lingham, Mrs., per Rhosneigr Life-boat	1	1
Luck, Richard, Esq.	10	6
Marshal, Col.	1	0
Mason, Rev. Wms.	1	0
Massey, Mrs.	10	0
Massey, W. Esq.	10	0
McCorquodale, Mr.	1	1
McCorquodale, Mrs.	1	1
Meyrick, Sir George, Bart.	2	0
Millington, Jno. Esq.	10	0
*Mitchell, H. B. Esq.	1	0
*Mitchell, Mrs. H. B.	1	0
Neave, The Hon. Lady	10	0
Nunn, J. P. Esq., per Rhosneigr Life-boat	1	1
Nunn, Mrs. for Rhosneigr Life-boat	1	1
Ogle, Admiral	10	6
Owen, John, Esq.	1	0
Owen, Rev. H. D., D.D.	1	0
Trevarth, Rev. H. D., M.A., Penrynnydd	1	1
Owen, Rev. H. D., M.A., Penrynnydd	1	1
*Owen, R. Brisco, Esq.	1	0
*Owen, R. E. Esq.	10	0
Owen, W. H. Esq.	2	2

£.	s.	d.
Facey, J. Esq.	1	1
Penrhy, Lord	5	0
Platt, J. H. Esq.	5	0
Platt, Robert, Esq.	5	0
Poole, Henry R., Esq.	1	1
Preston, N. Francis, Esq. Swainston	10	0
Price, Mrs. Hugh	1	0
Price, J. B. Esq.	10	0
Pritchard, Rev. H.	10	0
Rayner, Captain G. Pritchard	5	0
Roberts, Arthur, Esq.	1	0
Roberts, Mr. J.	10	0
Roberts, J. Esq., Tyddyn Mawr	10	6
Roberts, Mr. David, Rhyd.	10	6
Roberts, Robert, Esq.	2	2
Roscoe, Mrs.	1	1
Scotfield, W. J. Esq., per Rhosneigr Life-boat	1	1
*Slater, Mr. J.	10	0
Smith, Assheton, Esq.	5	0
Smith, Branston, Maj.	1	1
Souter, Miss, per Rhosneigr Life-boat	1	1
Souter, Miss F., per Rhosneigr Life-boat	1	1
Spargo, Nicholas, Esq.	10	0
Sparrow, J. Bodychan, Esq.	1	1
Spode, Josiah, Esq.	2	0
Staples, Mr. E.	10	0
*Thomas, Mr. E. R.	10	0
Thomas, Lieut.-Col. Wm. Beaumaris	10	6
*Trevor, Rev. Warren	0	0
Trevor, Mrs.	10	6
Verney, Captain E., R.N.	1	0
Whitehead, J. D. Esq.	5	5
Williams, Rev. Robt.	1	1
Williams, Rev. W. Wynne, Jun.	10	0
Williams, Miss, Tanygraig	1	0
Williams, Mrs., Troed-y-afon	1	1
Williams, Mrs. H. O.	10	0
Williams, W. Esq.	2	0
Williams, Rev. John	10	0
Williams, Rev. J. Evan	5	0
Wyatt, Mrs. Port Dinorwic	1	0
Wynne, Mrs. Henry	10	0
Sums under 5s.	4	0
Total	£125	2 6

Donations and Collections, 1882-83.

Contribution boxes at Bulkeley Arms Hotel, Beaumaris	8	9
Collected in Llansadwrn Church, per Rev. R. H. Williams	1	5
Evans, Rev. J. W., at Moelfre Church.		

£.	s.	d.
Hall, —, Esq., Liverpool	1	1
Llanfaes & Penmon churches, per Rev. T. W. Trevor	25	0
Mitchell, Mrs. B.	1	1
Ogle, Admiral.	10	6
S.S. Yacht Pandora, per W. M. Preston, Esq., Collecting Box	1	18
Warner, T. Esq.	2	2
Williams, Rev. J. C.	5	0
Total Dons.	33	11
Total Subs.	125	2 6

£158 14 3

HOLYHEAD BRANCH.

President—
The Hon. W. O. STANLEY.

Chairman—
Rev. Chancellor BRISCOE, D.D.

Treasurer and Hon. Sec.—
W. P. ELLIOTT, Esq.

£.	s.	d.
Annual Subscriptions.		
Beaumont, Capt.	10	0
*Briscoe, Rev. Chancellor, D.D.	10	0
*Cay, Capt. R.N.	10	0
City of Dublin Steam Packet Co.	5	0
Davis, Richd., Esq. M.P.	1	1
*Elliott, W. P. Esq.	10	6
Ellis, Mr. John	5	0
*Griffith, J. Lloyd, Esq.	1	0
*Haldane, Capt.	1	0
Hughes, Mr. John	5	0
Hughes, Mr. H. G.	5	0
*Jones, Capt. J. E., R.M.S. Ulster	1	0
Jones, Mr. Jos.	5	0
*Jones, R. R. Capt.	10	6
*Kendall, Captain of R.M.S. Connaught	10	0
Lewis, Capt. Geo.	10	0
Lloyd, Morgan, Esq., Q.C., M.P.	1	1
London and North Western Bally, Co.	10	0
*Mackenzie, Admiral	1	0
Peters, Mr. John	5	0
Pritchard, J. M. Esq., N. P. Bank	1	1
Pritchard, Mr. R.	5	0
Stanley, Hon. W. O.	1	1
Williams, Mr. Hugh	10	0
Williams, Mr.	5	0
Total	£29	0 6

Donations.

Collecting Boxes on L. & N.R. Steamers— Shamrock	1	7
Lily	1	7
Rose	2	17
Violet	1	7
Isabella	6	0
Karl Spencer	6	6

£.	s.	d.
Mr. Stammer's Marine Hotel	6	9
Sums under 5s.	6	4
Total Dons.	8	4
Total Subs.	29	0 6
£37	5	5

Berkshire.

READING BRANCH.

Honorary Secretary—
C. STREPHENS, Esq.

Annual Subscriptions.

Andrews, C. J. Esq.	10	6
Austen, Capt. R.N.	1	0
Bailey, Mr. J.B.	1	1
Barnett, F. C. Esq.	1	1
Beale, Lansdowne, Esq.	1	1
Benyon, R. Esq.	3	3
Birch, Capt. R.N.	1	0
Blackwell, Messrs. E. and F.	10	6
Blagrave, J. H. Esq.	1	1
Blandy, F. J. Esq.	1	1
Blandy, H. B. Esq.	1	1
Blandy, W. F. Esq.	1	1
Blowers and Son, Messrs.	10	6
Bourne, J. Esq.	10	6
Brown, Mr. G. J.	1	1
Brown, Mr. D. L.	10	6
Butler, Mr. G. R.	10	6
Bracher and Sydenham, Messrs.	10	6
Bradley, Mr. R.	10	0
Cantrell, Mr. W. S.	10	0
Catchpool, Mr. R. D.	1	1
Cobham, Capt. A. W.	1	1
Cobham, A. C. Esq.	1	0
Cocks, Messrs. C. & Co.	10	6
Cocks, Mrs. C.	10	0
Collins, Chas. Esq.	10	6
Collins, Henry, Esq.	10	0
Cooper, Messrs. J. O. and Son	10	0
Cooper, Mr. Lewis	10	0
Cowslade, H. H. Esq.	1	1
Cowslade, W. H. Esq.	1	1
Crawshaw, Mrs.	5	0
Creed, H. Esq.	10	6
Davis, Mr. E.	10	6
Dodd, J. T. Esq.	10	6
Edge, Mrs.	1	1
Eisdell, Mr. A. R.	10	0
Elliot, Adml. R.N.	1	1
F. W. A.	2	0
Ferguson and Son, Messrs.	10	6
Flanagan, Mr. W. G.	10	6
Forbes, A. C. Esq.	1	1
Fuller, Mr. Josiah	1	0
Garland, T. B. Esq.	1	1
Garry, Rev. N. T.	1	0
Hilligan, Mr. George	10	6
Gray, Col. W.	1	1
Haukey, Sidney A. Esq.	1	1

PORT OF RUNCORN BRANCH.

Honorary Secretary—
F. SAMONS, Esq.
Collector H.M. Customs.
Annual Subscriptions.
£. s. d.
Anderson, Capt. — 10 6
"Four Brothers" — 1 0
Brundrit, John, Esq. 1 1 0
Clark, Capt. 1 1 0
Findley, E. Esq. 10 6
Hazlehurst & Sons, Messrs. 1 1 0
Higson, J. Esq. 1 1 0
Hayes, W. and Co. 1 1 0
Simpson, Davies, & Sons, Messrs. 1 1 0
Speakman, Philip, Esq. — 10 6
Stock, Samuel, Esq. 1 1 0
Wells, L. B. Esq. 10 6
Contribution Box at Custom House ... 1 5 0
Total.....£10 14 0

STOCKPORT BRANCH.

Chairman—
Mr. JAMES LEIGH,
Mayor of Stockport.
Hon. Secretary—
Mr. WM. LEIGH.
Annual Subscriptions.
Brownsword, Mr. Henry..... 1 1 0
Greg, Mr. Francis. 1 1 0
Leigh, Mr. James. 2 2 0
Leigh, Mr. Joseph. 1 1 0
Leigh, Mr. I. L. 1 1 0
Leigh, Mr. Wm. 1 1 0
Lloyd, Mr. T. H. 10 6
Robinson, Mr. F. R. 1 1 0
Weathered, Mr. T. W. (New York)..... 1 1 0
Wilkinson, Lieut.-Col. S. W. 1 1 0
Wollaston, Mr. E. W. (Manchester).... 1 1 0
Total.....£12 1 6

Cornwall.

BUDE BRANCH.

President—
Sir T. DYKE ACLAND,
Bart., M.P.
Treasurer—
Rev. E. HIGHTON.
Honorary Secretary—
WILLIAM ROWE, Esq.
Annual Subscriptions.
£. s. d.
Acland, Sir T. D. 5 0 0
Bart, M.P. 5 0 0
*Carnsew, Rev. T. S. — 10 0
Carnsew, Mrs. 5 0 0
*Chamier, E. Esq. 1 0 0
Constable, Mrs. 10 0
Cowie, C. M. Esq. 10 0
Hockin, John, Esq. 1 0 0
Hockin, Mrs. Frank — 5 0 0
*Mills, A. Esq. 1 1 0
Thynne, F. J. Esq. 5 0 0
Donations 7 10 6
Total ...£22 11 6

CADGWITH BRANCH.

President—
Captain SYMONS, R.N.
Chairman—
Mr. COX, Cadgwith.
Honorary Secretary—
Annual Subscriptions.
£. s. d.
Beringer, Mr. 2 6
Boaden, Mr. Joseph — 5 0
Davis, Thomas, Esq. 1 1 0
Rogers, Henry, Esq. — 10 6
St. Aubyn, Sir John, M.P. 1 0 0
Clark, Capt. 1 1 0
Tyacke, Walker, Esq. — 10 6
Vivian, Pendarvis, Esq., M.P. 1 1 0
Vyvyan, Sir Vyell. 1 1 0
W. B. L. 1 1 0
Total..... £7 13 6

Donations.

Cadgwith Boxes. 18 6
Haynes, Mr. T. 5 0
Penzance Hotel Boxes 1 7 6
Total Dons.... 2 11 0
Total Subs.... 7 13 6
£10 4 6

FALMOUTH BRANCH.

President—
HOWARD FOX, Esq.
Chairman and Treasurer—
THOMAS WEBBER, Esq., J.P.
Honorary Secretary—
T. R. GRILLS, Esq.
Annual Subscriptions.
Basset, G. L. Esq. 3 0 0
Brett, R. Balliol, M.P. 2 2 0
*Broad and Sons, Messrs. 1 1 0
*Bull, Col. M. V. 10 0
Carne, Messrs. W. and E. C. 1 1 0
*Carter, Mr. R. 5 0
*Chard, Mr. A. 5 0
*Cheesman, Mr. R. G. — 10 6
*Cliff, Mr. C. 5 0
Clinton, Lord. 2 2 0
Corfield, Mr. T. 2 6
Corfield, Mr. W. 5 0
*Cox & Sons, Messrs. — 10 6
*Fox and Co., Messrs. G. C. 2 2 0
Fox, Mrs. Alfred 1 1 0
Freeman, Mrs. John — 10 0
Gann, Mr. W. J. 10 6
Halligey, Mr. J. W. 5 0
Hitchens, Mr. J. O. — 10 6
Hosken, Mrs. S. 1 0 0
Jenkins, Mr. D. J., M.P. 2 2 0
Jenkins, Mr. G. A. — 10 6
Jenkins, Mr. W. 5 0
Kemble, Mrs. 5 0 0
*Kimberley, Earl of. 1 1 0
*Kennerley, Mr. J. C. 1 1 0
*Lean, Mr. W. H. 10 6
*Llewellyn, W. I. 1 1 0
Oliver, Mrs. J. 5 0
*Pollard, Mr. H. 5 0
Selley, Mrs. Wm. 5 0
*Solomon, Mr. W. H. — 5 0
Snow, Mr. R. 5 0

St. Aubyn, Sir John, Bart., M.P. 1 1 0
*Symons, Mr. G. W. H. — 10 0
*Tilly, Mr. H. 5 0
Tremayne, Col. 1 1 0
*Vivian, Mr. A. Pendarvis, M.P. 1 1 0
*Webber, Mr. T. 10 6
Williams and Co., Messrs. 1 1 0
*Willmore, Mr. A. 5 0
Boxes 4 1 6
Total.....£40 10 6

FOWEY BRANCH.

President—
JONATHAN RASHLEIGH, Esq.
Chairman—
EVELYN W. RASHLEIGH, Esq.
Treasurer—
ARTHUR COODE, Esq.
Honorary Secretary—
W. E. GEACH, Esq.
Honorary Collector—
W. LOWRY, Esq.
Annual Subscriptions.
*Bate, Mr. George .. 5 0
Carlyon, E. Esq. 1 1 0
Carnall, R. Esq. 10 0
Cocks, Lieut.-Col. ... 1 1 0
*Coode, Arthur, Esq. 1 1 0
Coode, Edward, Esq. 1 1 0
Coode, John, Esq. 1 1 0
*Davis, A. A., M.D. — 5 0
Fortescue, Capt. 1 0 0
Freeth, George, Esq. 1 1 0
Jenkyns, A. Esq. 10 0
Martyn, W. L. Esq. 1 1 0
Peard, Mrs. 1 0 0
*Purcell, Rev. H. N. — 5 0
*Rashleigh, E. W. Esq. 1 0 0
*Rashleigh, Jonathan, Esq. 2 2 0
Robartes, Lord. 1 1 0
Sartoris, E. J. Esq. 2 12 6
Stopford - Sackville, Mrs. 2 2 0
Treffry, C. E. Esq. 1 1 0
Truscott, Chas. Esq. — 10 6
White, Mrs. S. 10 0
*Wreford, W. Esq. 5 0
Total£22 6 0

HAYLE BRANCH.

Chairman—
Rev. F. HOCKIN, Rector.
Honorary Secretary—
JOHN POOLE, Esq.
Annual Subscriptions.
Bain, D. W. Esq. J.P. — 5 0
Bassett, G. L. Esq. 2 0 0
Bazeley, Mr. Jas. 5 0
Boitho, Sons and Co. Messrs. 1 1 0
Burrall, Mrs. J. H. 1 1 0
Goldsworthy, Mr. T. — 5 0
Harvey and Co. 5 0 0
*Harvey, Frank, Esq. J.P. 1 1 0
Harvey, Wm. Esq. J.P. 1 1 0
Hitchens, M. T. Esq. — 5 0
Hockin, G. C. Esq. 1 1 0
*Hockin, Rev. F. 1 1 0
*Hosken, Wm. Esq. 10 0
*Husband, W. Esq. 1 1 0
Mudge, James, Esq. — 10 0
Millett, R. O. Esq. 1 1 0
Nicholls, Mr. Loam. — 10 0

Olver, Miss 5 0
Pearce, Mr. G. 5 0
Polkinghorne, Mr. T. — 5 0
Pool, Capt. F. H. 10 6
Pool, Mr. Henry 5 0
Pool, Messrs. J. F. 5 0
Praed, C. Esq. 2 2 0
Rawlings, W. J. Esq. — 10 0
Rodd, F. Esq. 1 1 0
Rowe, Mr. John. 5 0
Spray, Capt. P. B. 10 6
St. Aubyn, Sir John, Bart., M.P. 1 1 0
St. Aubyn, Rev. St. Aubyn H. Molesworth 1 1 0
The Trevelthoe Estate 2 2 0
Trevithick and Sons, Messrs. J. H. 1 1 0
*Vivian, John, Esq. — 10 0
West, Nicks. J. Esq. — 10 0
West, William, Esq. — 10 0
Total.....£30 17 0

Donations.

Mills, Miss 1 0 0
Boxes and Sums under 5s. 8 5
£32 5 5

LIZARD (POLPEAR) BRANCH.

President—
Honorary Secretary—
Rev. P. VYVYAN ROBINSON.
Annual Subscriptions.
Jaurin, Misses 1 0 0
Gregory, Mrs. (Madagascar) 2 2 0
Robartes, Lord (the late) 10 10 0
Spencer, Rev. E. 1 1 0
St. Aubyn, Sir John, Bart., M.P. 1 1 0
Western Morning News, Proprietors of 1 1 0
Total.....£16 15 0

Donations.

Pool, Miss, Islington 1 0 0
Tomlin, Miss M., Belvoir Hill. 2 0 0
Collection Boxes:—
Hill's Hotel. 2 3 6
Boat House. 2 8 0
Total Dons... 7 12 6
Total Subs. 16 15 0
£24 6 6

LOOE BRANCH.

President—
W. H. POLE CAREW, Esq.
Chairman—
G. KERSWILL, Esq.
Honorary Secretary—
ROBERT THOMAS, Esq.
Annual Subscriptions.
Allen, Misses 5 0
*Bawden, Mr. E. 5 0
Bewes, Rev. T. A. 1 0 0
Buller, J. F. Esq. 5 0 0
Bush, Rev. Paul 10 0
Campbell, Rev. Ed. 5 0
Campbell, John, Esq. — 10 0

BRANCHES—LIST OF ANNUAL SUBSCRIPTIONS AND DONATIONS. 113

			MEVAGISSEY BRANCH.						PENZANCE AND SENNEN COVE BRANCH.					
	£.	s. d.				£.	s. d.				£.	s. d.		
Campbell, Mrs. T. ...	10	0	MEVAGISSEY BRANCH.			*Morgan, Capt. W., R.N.	5	0				Sawle, Dowager Lady Graves.....	1	0
Campbell, T. Esq. ...	10	0	President—			Oates, Richd.	5	0				Stephens, Mrs.	10	0
*Campbell, Truman, Esq.	10	0	JOHN TREMAYNE, Esq., J.P.			Oliver, Mr. E. S.	5	0				*Tregaskis, Mr. Saml.	5	0
Carew, W. H. P. Esq. ...	0	0	Chairman—			Pearse, Miss.	1	0				*Tyacke, the Rev. R.	10	0
Caunter, Henry, Esq.	10	0	Capt. WILLIAM BALL.			*Prout, Capt. Tho.	5	0				Wilson, Capt.	1	0
*Childs, Borlase, Esq.	10	0	Honorary Secretary—			Reynolds, Mr. Jno.	5	0				Total.....	£31	3 6
Clogg, S. Esq.	10	0	Capt. J. BALL FARRAN.			Billstone, Mr.	5	0						
Clymo, Mrs. James.	10	0	Annual Subscriptions.			Shuckford, Mrs.	1	0						
Coad, J. L. Esq.	5	0	£. s. d.			Stephens, Mr. Sampson	5	0						
Congdon, Mr. J.	10	0	Bailey, Edward, Esq. 2 0 0			*Thomas, Capt. Wm.	5	0						
Courtney, L. Esq., M.P.	1	0	Coode, Arthur, Esq. 10 6			Tonkyn, Capt. Wm.	5	0						
Crichton, M. F. Esq.	10	0	*Farran, Capt. J. B. 5 0			Tredwen, Mr. R.	5	0						
Fisher, Rev. J. F.	10	0	Higman, H. W. Esq. 10 0			Treffry, C. E. Esq.	1	0						
Foster, L. C. Esq.	1	0	Mt. Edgcombe, Lord 3 0 0			Tummon, Mr. Cotton	5	0						
Foster, R. D. Esq.	1	0	*Tremayne, J. Esq. 5 0 0			Wellington, Mr. B.	5	0						
Furneaux, Rev. A.	5	0	Williams, J. C. Esq. 3 0 0			Weston, Mr. Fredk.	5	0						
Garrett, Rev. S.	10	0	Sums under 5s. 2 6			Willyams, A. Esq.	10	0						
Gill, Dr.	5	0	Total.....			Willyams, B. Esq.	1	0						
Glanville, Rev. H. C.	10	0	£14 8 0			Total.....	£15	0 0						
*Glencross, Rev. Ed.	10	0	MULLION BRANCH.											
Glencross, Rev. Jas.	10	0	President—											
*Gooch, Sir Alfred Shirlack.	2	2 0	J. SIDNEY DAVEY, Esq., J.P.											
Grigg, John, Esq.	10	0	Honorary Secretary—											
Hawke, Rd. Esq.	10	0	E. G. HARVEY, Vicar.											
Hicks, Mr. B.	5	0	Annual Subscriptions.											
Hicks, Mrs. J. S.	5	0	Benney, Mrs. R. 1 1 0											
Hicks, Mr. William	5	0	Davey, J. Sydney, Esq. 1 1 0											
Hill, Capt. John	5	0	Davey, Richard, Esq. 1 1 0											
Hooppel, Mrs.	5	0	Head, Mrs. 5 0											
Iago, Mr.	5	0	Jose, Mr. Jer. 5 0											
Jenkins, Rev. D.	5	0	Kempthorne, Mr. J. B. 10 0											
Jenkins, S. W. Esq.	10	0	Robartes, Lord. 5 5 0											
*Jones, Rev. E. D.	10	0	*Shepherd, Mr. T. 5 6											
Kembie, Rev. A.	1	0	*Thomas, Mr. Joseph 5 0											
*Kerswill, Geo. Esq.	10	0	*Thomas, Mr. Fredk. 5 0											
*Kerswill, J. B. Esq.	10	0	Trousoun, Mr. T. 10 0											
King, Rev. Joseph.	10	0	Vyvyan, Rev. Sir Vyell, Bart. 2 0 0											
Kitson, Rev. J. F.	10	0	*Williams, Mr. Peter 10 0											
*Leycester, Charles H. Esq.	1	0	Sums under 5s. 1 8 6											
*Little, Mr. Rd.	5	0	Total.....											
*Marshall, Capt. John Marshall, L. Carrington, Esq.	10	0	£14 11 6											
Marshall, Wm. Esq.	1	0	Donations.											
Martin, Rev. Canon.	1	0	Collection Box 5 4											
Medland, James, Esq.	5	0	£14 16 10											
*Neale, E. Jas. Esq. ...	1	0	NEWQUAY BRANCH.											
Nicholas, Mrs. J.	10	0	Chairman—											
Norris, Mrs.	10	0	Major W. E. MICHELL.											
Oliver, Mr. Thomas.	5	0	Honorary Secretary—											
*Poad, Mr. John	5	0	Capt. W. THOMAS.											
Pole, Henry, Esq.	1	0	Annual Subscriptions.											
*Polkinghorne, Wm. Esq.	10	0	Boyle, Mr. 5 0											
Rendle, C. B. Esq.	5	0	Cardell, T. M. Esq. 5 0											
Roberts, Miss, Tretbill 1 1 0	1	0	Carter, Capt. W. J. 5 0											
Sneyd, George F. Esq. ...	10	0	Carus-Wilson, E. S. Esq. 10 0											
St. Germans, The Earl of.	1	0	Collins, J. B. Esq. 1 1 0											
St. Germans, The Countess of.	10	0	Crockier, Capt. John 5 0											
Tatham, Mrs.	5	0	Edwards, Mr. J. V. 5 0											
*Thomas, Dr.	5	0	Ennor, Mr. J. 5 0											
*Thomas, Robert, Esq. ...	10	0	Hicks, Mr. W. 5 0											
Trelawny, Sir John	1	0	*Hicks, Mr. G. 10 0											
Walters, Mr. James.	5	0	Hooper, Mr. J. 5 0											
Walters, Capt. John.	5	0	Jenkin, Mr. Albert 5 0											
Walters, Capt. Sam.	5	0	Jenkin, Capt. Thomas 5 0											
West, Rev. O.	10	0	Martyn, Mr. S. E. 1 1 0											
White, J. Esq.	10	0	*Michell, Major 1 1 0											
White, Mrs.	10	0	Molesworth, Sir P. Bt. 10 0											
Willcocks, Isaac, Esq. ...	10	0	Total.....											
Willcock, H. D., Esq.	5	0	£45 9 4											
Wynhall, Mr. E.	5	0	Donation.											
			Small sums - 10 4											
			<u>£45 9 4</u>											

£.	s.	d.
Harvey, Mrs. Nichols	10	0
Harvey, Mr. S., St.		
Sennen	5	0
Harvey, Mr. H. H.,		
Trevarian	5	0
Hatherton, The		
Dowager Lady	10	0
*Hedglund, Rev. P.,		
M.A.	10	0
Hill, Mr. W.	5	0
Hodge, Hy. Esq., St.		
Sennen	5	0
*Holman, Fred. Esq.	1	0
Hora, Mr. A. H.	1	0
Humphrys, Mr. R.,		
St. Sennen	5	0
Humphrys, Mr. H. T.		
Escalls	5	0
Jago, the Misses	5	0
James, Mr. F. H.	5	0
James, Mr. John	5	0
*James, Mr. S. H.,		
St. Just	10	0
Jones, J. Winter, Esq.	10	0
King, T. Esq.	10	0
Laity, Mr. Hy., Penrose	5	0
Laity, Mr. Hy., Tre-gurno	5	0
Lanyon, Mr. J. J.	5	0
Lavid, Mr. Chas.	5	0
Le Grice, Chas. D. N. Esq.	10	0
Longhurst, Miss	5	0
Magor, M. Esq.	10	0
*Marrack, Mr. Philip	5	0
Martyn, Rev. R. J.	5	0
*Mathews, Mr. F. C.	5	0
*Mathews, Messrs. W. D. and Sons	10	0
Michell, A. O., Esq.	10	0
Michell, Mr. A. H.	5	0
Michell, Mrs. John	10	0
Millett, J. N. R. Esq.		
Bosavern	5	0
Milton, J. P. Esq.	10	0
Montgomery, Dr.	5	0
Molesworth, Sir P. W. Messrs.	5	0
Olver and Symons,		
Messrs.	5	0
Pascoe, H. and Son	5	0
Pascoe, Mr. Nichols,		
St. Sennen	5	0
Peel, Miss	5	0
Peters, Miss	10	0
Phillips, Mr. Geo. St. Sennen	5	0
Polson and Co.	5	0
Pool and Son	10	0
Preston, Rev. Geo. H.	5	0
Prockter and Buckett	5	0
Quick, J. B. Esq.	5	0
Roberts, Mr. Thos., St. Sennen	5	0
Robinson, Lady	5	0
*Roe, Rev. R. J., St. Sennen	1	0
Rogers, Miss (Tre-varthian)	1	0
Rogers, the Misses	5	0
*Ross, C. C. Esq., M.P.	10	6
Roscorla, J.	5	0
Ross, Mrs.	10	0
Ruck, Mr. John	5	0
Saundry, J. and Son, St. Sennen	5	0
Scobell, Geo. Esq.	1	0
St. Aubyn, Sir John, Bart., M.P.	1	0
Thomas, Henry, Esq.	5	0
Thomas, R., St. Just	5	0
Tonkin, Rev. John, St. Buryan	10	0
Toukin, Rev. F.	5	0
Travers, Major	5	0
Trelawney, Colonel	5	0
Tremewen, Mr. N. T., St. Sennen	5	0
Trevethick, Mrs.	5	0
Trythall, W. Esq.	10	0
*Uren, Mr. J. G.	5	0

£.	s.	d.
Victor, Messrs. R. R. and H.	5	0
Vigurs, Mrs.	10	0
White, W. Todd, Esq.	10	0
Williams, Mrs.	5	0
Wills, Mrs.	5	0
Wingfield, Rev. W. W.	10	0
Wright, T. H.	5	0
Sums under 5s.	13	6
Total	£71	12 6

Donations.		
Botelu, Miss	5	0
Greaves, Mr. J.	1	0
Pillar Box, Promenade, and Box at the Life-boat Station, Penzance	5	0
Box, Union Hotel (the Misses Longhurst)	19	2
Do. Western Hotel (Mr. W. Mitchell)	15	0
Box, Mount's Bay House (Mrs. Lavins)	10	0
Penzance, Post Office	9	0
Porthcown Mess., Eastern Telegraph Co.	4	1
Queen's Hotel	12	3
Wellington Hotel, St. Just	16	0
Small sums	4	0
Total Dons.	14	11 11
Total Subs.	71	12 6
Total	£86	4 5

PORThLEVEN BRANCH.

President—		
Rev. E. PRIDMORE.		
Honorary Secretary—		
J. P. THOMAS, Esq.		
Annual Subscriptions.		
Robartes, Lord	5	0
*Bickford-Smith, W., Esq.	1	0
Boltho, Sons & Co.	1	0
Cade, Mr. R.	5	0
Coode, Ed. Esq.	1	0
Cornish Bank Limited, Helston	1	0
Harvey, Wm. Esq.	2	0
Lanyon, Mrs.	5	0
*Lear, E. W. Esq.	10	0
Martyn, Mr. R.	5	0
Molesworth - St. Aubyn, W. Esq., M.P.	10	0
Roberts, Mr. H.	5	0
Rogers, Capt. J. P., R.A.	1	0
St. Aubyn, Sir J., M.P.	1	0
*Simons, J. Esq.	5	0
Steeaman, Mr. W.	5	0
Vyvyan, Rev. Sir Vyell, Bt.	3	3
Wise, Rev. R. F.	1	0
Young, W. A. Esq.	1	0
Sums under 5s.	15	0
Total	£22	2 0

PORThUSTOCK BRANCH.

President—		
WILLIAM TREVENEN, Esq.		
Chairman—		
EDWD. J. LEBERTON, Esq.		
Honorary Secretary—		
Mr. E. F. ROSKRUGE.		
Annual Subscriptions.		
Robartes, Lord	2	2
Doiman, Jas. Esq.	2	2
Fox, G. C. and Co.	1	0
Glubb, Rev. P. S.	1	0
*Hearle, Mr.	5	0
Howard, Rev. A. W.	10	0
Hunter, Miss.	10	0
*James, Mr. Wm.	10	0
*Leverton, Edw. Esq.	10	0
Lory, C. M. Esq.	5	0
Lory, Lieut. John L.	5	0
Lory, Rev. F. A. P.	5	0
Pengilly, Mr. Alex.	10	0
*Roskruge, E. P.	5	0
*Roskruge, Thos. Jun.	5	0
*Roskruge, Wm.	5	0
Smedley, Miss.	2	0
Smelt, Rev. M. A.	10	0
St. Aubyn, J. Esq., M.P.	1	0
Tremayne, Colonel.	1	0
Trevenen, Wm. Esq.	1	0
Venables, Mrs.	10	0
Vyvyan, Rev. Sir Vyell	2	2
Total	£18	15 0

PORTh ISAAC BRANCH.

Honorary Secretary—		
W. R. GUY, Esq.		
Annual Subscriptions.		
Old Delalote Slate Quarry Company	1	0
East Cornwall Bank	1	0
Fortescue, Earl.	1	0
*Guy, W. R., Esq.	10	0
Guy, Mrs. Mark	10	6
Hambly, Mrs. E.	10	0
Haynes, Jas.	2	6
Hellyar, Miss	1	0
*Johnson, Mr. Thos.	5	0
Magor, E. A., Esq.	1	0
Page, Rev. V.	1	0
Pearse, W. Esq.	10	6
Pearse, Miss	1	0
Stephens, Mrs.	1	0
*Treffry, Rev. R.	1	0
*Trevan, Dr. M.R.N.	10	0
*Trevan, Mr. F.	10	0
Wharnclyffe, Lord	2	2
Total	£14	16 6

PORThLOE BRANCH.

Chairman—		
THE LORD HYLTON.		
Honorary Secretary—		
Rev. Canon CORNISH.		
Annual Subscriptions.		
*Blamey, Mr. J. A.	5	0
Blamey, Mr. T.	5	0
Carlyon, E. T. Esq.	10	6
*Cornish, Rev. J. R.	5	0
Devon and Cornwall Bank	10	0
*Dunstone, Mr. P.	10	0
*Dunstone, Mr. W.	5	0

£.	s.	d.
Fookes, Rev. W.	5	0
Hylton, Lord	3	3
Miners' Bank, Truro	10	0
Peter, Rev. L. M.	1	0
Wise, Rev. Canon	10	0
Young, J. T. Esq.	10	6
Total	£8	10 0

ST. IVES (CORNWALL) BRANCH.

Treasurer and Honorary Secretary—		
W. T. TRESIDDER, Esq.		
Annual Subscriptions.		
Anthony, Mr. M. D.	5	0
Banfield, Mr. R. H.	10	0
Batten, Carne and Carne, Messrs.	10	6
Best, Mr. W. H.	5	0
Bolthos & Co. Messrs.	1	0
Care, Capt. H.	5	0
Care, Capt. W. H.	5	0
Chelwell, Capt. J.	5	0
Coles, Rev. R. E.	10	0
Cowley, Earl. K.G.	2	2
Docton and Sons.	5	0
Erson, Dr. E. G.	5	0
Gyles, Capt. William	5	0
*Hain, Edw., & Son, Messrs.	10	6
Hain, Capt. John	5	0
Hain, Capt. R. P.	5	0
Hamlyn, G. S.	5	0
Harris, Mrs. Henry	10	0
Harry, Capt. T. R.	5	0
*Hodge, Capt. John	5	0
Johns, Mr. W.	5	0
*Jones, Rev. J. B.	10	6
Morton, Capt. R.	5	0
Pennewan, Mr. R.	5	0
Phillips, Capt. J. G.	5	0
Richards, Mrs. G.	5	0
Robartes, Lord	1	0
Rosewall, Mr. G. B.	5	0
Rowe, Mr. James	5	0
St. Aubyn, Sir John, Bart. M.P.	1	0
Staff, Dr.	5	0
Stevens, Mr. D. F.	5	0
Tremearne, Mrs. J. N.	10	0
*Tresidder, Mr. W. T.	10	0
Trewbella, Wm.	5	0
Yacke, Rev. R. F.	10	0
Vivian, A. Pendarves, Esq., M.P.	1	0
Wallis, Capt. S.	5	0
Warren, Wm.	5	0
Wasley, Mr. G.	5	0
Williams, Mr. Geo.	5	0
Yonge, Miss	5	0
Sums under 5s.	4	1
Total	£22	3 6

Donation.		
Messrs. Dillon, Harrowing, and Co.	2	2
Total	£24	5 6

SCILLY ISLANDS BRANCH.

President—
T. ALGERNON SMITH DORRIEN SMITH, Esq.
Chairman—
W. M. HOSKIN, Esq.
Honorary Secretary—
Mr. E. J. BLUETT.

Annual Subscriptions.

Ranfield, F.	£. s. d.
*Bluett, E. J.	5 0
*Bluett, J.	5 0
*Hoskin, Wm.	5 0
Hugh House Hotel	10 0
*Jackson, A.	5 0
Life-boat House and other Boxes, &c.	12 4
*Smith, T. A. Smith	1 1 0
Dorrien, Esq.	1 1 0
*White, A.	5 0
Sums under 5s.	7 6
Total	£4 0 10

Cumberland. CARLISLE AND SILLOTH BRANCH

Chairman—
The MAYOR OF CARLISLE.
Honorary Secretary—
JOHN STONACH, Esq.

Annual Subscriptions.

Blair, Mr. Thomas	£. s. d.
Binning, S. J., Esq.	10 0
*Boyd, Chas. Esq.	10 6
Carr and Co. Messrs.	1 0 0
Committee, The Local Silloth	10 6
Creighton, R. Esq.	10 0
Elliott, R. Esq. M.D.	10 0
Ferguson, J. C. Esq.	10 0
Ferguson, Rt. Esq. M.P.	1 0 0
Harrison, Mrs. W.	1 1 0
Hope, Mrs. Joseph	10 0
Howard, G. Esq., M.P.	1 0 0
James, Isaac, Esq.	10 0
Lawson, Sir W. Bart. M.P.	1 0 0
Little, Miss	10 0
Maxwell, Mr. Wm.	10 0
Page, W. B. Esq.	1 1 0
Redford, Rev. F. M. A.	10 6
Standish, E. R. W. P. Esq.	1 1 0
Sutton, Wm. Esq. (Exors. of)	10 0
Total	£13 15 6

Donations.

Contribution Pillar Box	£ 17 10
Contribution Box, Boat-house and other Boxes	1 17 4
Total Dons.	2 15 2
Total Subs.	13 15 6
Total	£16 10 8

MARYPORT BRANCH.

Chairman—
H. P. SENHOUSE, Esq., J.P.
Honorary Secretary—
W. H. ECKERSLEY, Esq.

Annual Subscriptions.

A Friend, W. P. S.	£ 5 0
Addison, John, Esq.	5 0

Brayton Coal Co.	£. s. d.
Brown, Mrs.	1 1 0
Collin, P. de E. Esq.	10 0
*Eckersley, W. H.	5 0
Graham & Co. Messrs.	10 0
Hewitson, Mrs.	10 0
Hine Bros. Messrs.	10 6
*Mark, Jos. Esq.	10 0
*Melmore, John	5 6
Pearson, Dr.	10 6
Penrice, Jas. Esq.	5 0
Ritson, Messrs. Robt. and Co.	1 1 0
Robinson, Jos. Esq.	10 0
*Senhouse, H. P. Esq.	1 1 0
J. P.	1 1 0
Sewall, Major	5 6
Solway Hematite Iron Co.	1 1 0
Tomlinson, J.	5 0
Tyson and Hobson, Messrs.	1 0 0
Wilson, Robert, Esq.	1 1 0
Wood, Mr. J. H.	5 0
Total	£12 5 6

Donations.

Box in H.M. Customs, Maryport	£ 6 6
Pillar Boxes	19 6
Sums under 5s.	5 0
Total	£23 16 6

SEASCALE BRANCH.

President—
LORD MUNCASTER.
Chairman—
REV. H. BELL.
Hon. Secretary—
MR. J. MOLYNEUX.

Annual Subscriptions.

Atkinson, Mr. Isaac	£ 5 0
Atkinson, Mr. Wm.	10 0
Barker, Mrs. A.	1 0 0
Barratt, Mrs.	2 0 0
*Bell, Rev. H.	10 0
Biomfield, Rev. C.	1 1 0
Brocklebank, T. Esq.	1 0 0
*Colebank, Mr. Isaac	1 0 0
Fisher, Mr. J.	5 0
Gemson, Mr. John	5 0
Hutchinson, Mr. Isaac	5 0
Johnson, The Misses	2 10 0
*Lindon, J. L. B. Esq.	2 10 0
Middleton, Mr. J.	10 0
*Muncaster, Lord	5 0 0
Mashiter, Mr. J.	5 0
Mashiter, Mr. T.	5 0
Matterson, Mr. H.	5 0
Mosseop, Mr. Jas.	5 0
Mosseop, Miss	5 0
Mosseop, Mr. Wm.	5 0
*Parker, C. A. Esq.	1 0 0
Pearson, Mr. W.	5 0
Robley, Mr. Thos.	5 0
Robley, Mr. Wm.	10 0
Senhouse, Miss	10 0
Sherwen, Mrs. M.	1 1 0
Skend, Mary	5 0
Stanley, E. Esq.	2 0 0
Thompson, G. P. Esq.	1 1 0
Townshend, Mr. Wm.	5 0
Walker, Mr. Thos.	5 0
*Wrigley, Mr. John	5 0
Total	£27 6 0

Donations.

A Friend	£ 5 0
A Friend, per Capt. Thompson	5 0
A Friend, per F. C. Coward, Esq.	5 0
A Friend, per Miss Senhouse	2 0 0

*Ainsworth, J.S. Esq.	£. s. d.
Barratt, Mr.	3 0 0
Barratt, Miss	1 0 0
Barratt, Miss S.	1 0 0
Benn, W. S. Esq.	5 0
Benson, Mr. W.	5 0
*Churchill, J. Esq.	1 1 0
Collingwood, Rev. R. G.	1 0 0
*Coward, F. H. Esq.	10 0
Fearon, J. Esq.	10 0
Gabbatt, Mr. Wm.	5 0
Gries, W. C. Esq.	1 0 0
Glashan, Mr. & Mrs.	10 0
Gaitkell, Jas. Esq.	10 0
Hale, Mr. H.	5 0
Hartley, Mr. James	5 0
Hartley, Mr. Jos.	5 0
Irwin, Mrs.	1 0 0
Kennedy, L. Esq.	5 0
Lofie, Rev. A. P.	5 0
Mosseop, Mr. Jno.	5 0
*Molyneux, Mr. J.	5 0
Myers, Mr. Wm.	5 0
Per Rev. H. Belt	13 6 0
Foulton, Miss	5 0
Rapley, D. Esq.	10 0
Richardson, R. Esq.	1 0 0
Robinson, Mr. Robt.	5 0
Ross, John, Esq.	10 6
Sherwen, Mr. J.	6 0
Stevenson, Mr. R.	5 0
Steward, F. Esq.	2 2 0
Taylor, Mr. W.	5 0
Thompson, J. D. Esq.	1 1 0
Walker, H. Esq.	1 0 0
*Walker, Mr. H.	10 0
Walker, Mr. John	5 0
Walker, Mr. J.	5 0
*Walker, W. B. Esq.	5 0
*Watson, H. H. Esq.	1 0 0
Sums under 5s.	2 12 6
Total Dons.	£31 11 0
Total Subs.	£27 6 0
Total	£58 17 0

WHITEHAVEN BRANCH.

Chairman—
CAPT. MANN,
3 HILTON TERRACE.
Honorary Secretary—
W. J. TYSON, Esq.
Collector—
MR. L. BORROWDALE,
16 WOODVILLE TERRACE.

Annual Subscriptions.

Lonsdale, The Right Hon. The Earl of	£ 5 0 6
Adair, Mr. J.	5 0
Ainsworth, Mr. D., M.P.	10 6
Ainsworth, Mr. J. S.	10 6
Atkinson, Mr. H.	5 0
Atter, Mr. E.	10 6
Bentinck, Right Hon. G. A. C., M.P.	1 1 0
Belfast Rope Work Co.	1 1 0
Brackenridge, T. & Co.	5 0
Bramwell, Dr.	2 2 0
Brockbank, Mr. Jas.	10 0
Brown, Mr. T.	10 0
Buckham, Mrs.	10 0
Burnyeat, Mr. W.	10 6
Cameron, Mr. Peter	1 1 0
Collins, Mr. J.	5 0
Collis, Mr. Isaac	10 0
Cousins, Mr. R.	5 0
Crossfield Iron Ore Co.	1 1 0
Dawson, Miss	10 0
Dees, Mr. James G.	10 0
Dickinson, Mr. J. N.	5 0
Dixon, Mr. T. C.	10 0
Feldtman & Co. Messrs. R.	1 1 0
Fisher, Mr. Charles	1 1 0

Fletcher, Mr. H. A.	£. s. d.
Furness Railway Co.	2 2 0
Gibson, Mr. W. B.	5 0
Gordon, Mr. C. D.	5 0
*Heron, Mr. John S.	1 0 0
*Helder, Mr. A.	10 0
Hodgetts, Mr. A.	1 1 0
Hodgson, Capt. Isaac	5 0
Howson, Mr. Thos.	10 6
*Huddart, Captain	2 2 0
Hudson, Mr. T.	1 1 0
*Ineson, Dr.	10 0
Jackson, Mr. George	5 0
Jackson, Mr. James	5 0
Jackson, Messrs. George & Co.	5 0
Jackson, Messrs. J. and W.	10 0
*Jacques, Capt.	1 1 0
Jefferson, Messrs. R. and H.	1 0 0
Jenkins, Mr. John	10 0
Lendonfield, Lord	1 1 0
Lindow, S. & J.	2 2 0
Little, James & Co., Barrow (per Mr. E. Eddie)	1 1 0
Lumb, Mr. W. W.	10 0
Lonsdale, Hematite Iron Comp.	1 1 0
Mackenzie, Mr. H. M.	1 1 0
McCowan, Messrs. J. A. & W.	5 0
Metcalf and Jackson, Messrs.	5 0
Moore & Co. Messrs.	10 0
Mosseop, Mr. J. B.	5 0
Murray, Miss	5 0
Musgrave, Mr. John	1 1 0
Musgrave, Mr. J. R.	10 0
Nelson and Sons, Messrs. G.	5 0
Nicholson, Mr. J.	5 0
Nicholson, Mr. T.	5 0
Pearson, Messrs. John and Son	5 0
Porter, Mr. J.	5 0
Poslethwaite, Mr. J.	10 0
Poslethwaite, Mr. M.	10 0
Rigg & Co. Messrs. C. A.	5 0
Robinson, Mr. J. H.	1 0 0
Robertson, Mr. Jas.	10 6
Robinson, Mr. R. A.	10 0
Russell, Mr. John	5 0
Sparrow, Mr.	5 0
Spencer, Major (Exors. of the late)	1 1 0
Sterling, Mr. John	2 2 0
Thompson, Mr. A.	10 0
Thompson, Miss	1 1 0
Vivian, Mr. John	5 0
Walker, Mrs. R.	1 1 0
Walker, Mr. Wm.	5 0
Whiteside, Mr. H. J.	5 0
Whittle & Son, Messrs.	5 0
Wilkinson, Capt.	10 0
Wilson and kitchen, Messrs.	10 6
Winder Iron Ore Co.	1 1 0
Whitehaven, Trustees of the Port of	10 0 0
Total	£68 5 6

Donations.

Hungerford, Capt. s.s. City of Bristol	£ 10 0
Box, Custom House, Whitehaven	11 9
Scott, Rev. Dean	16 0
Box at Capt. Mann's Office	7 4
Sums under 5s.	3 17 6
Total Dons.	£15 6 7
Total Subs.	£83 5 6
Total	£83 12 1

WORKINGTON BRANCH.

Chairman— CHARLES J. VALENTINE, Esq.

Honorary Secretaries— J. C. THOMPSON, Esq. JAMES BLADON, Esq.

Annual Subscriptions.

Table listing annual subscriptions for Workington Branch, including names like Bouch, the Misses, Broatch, J. A., Clifton, Rev. C. W., Cook, Miss, etc.

Donations.

Table listing donations for Workington Branch, including names like Iredale Brothers, Jackson, John, Jackson, Thos., etc.

£36 7 4

Denbighshire.

LLANDDULAS BRANCH.

Chairman— R. B. HESKETH, Esq.

Honorary Secretary— J. LYNCH FLETCHER, Esq.

Annual Subscriptions.

Table listing annual subscriptions for Llanddulas Branch, including names like Beckitt, Mrs., Blezard, R., Esq., Cayley, G. A., Esq., etc.

Table listing names and amounts for Workington Branch, including Fletcher, J. Lyn h, Esq., Fletcher, Mrs. J., Lynch, etc.

Total£32 17 0

Donations.

Table listing donations for Workington Branch, including Walker, A. O., Esq., Wynne, J. Lloyd, Esq.

£36 17 0

Derbysire.

BELPER BRANCH.

Chairman— H. LOMAS, Esq.

Treasurer— W. WINTERBOURNE, Esq.

Honorary Secretary— W. P. ADSHEAD, Esq.

Annual Subscriptions.

Table listing annual subscriptions for Belper Branch, including names like Adshead, Mr. W. P., Adshead, Mrs. W. P., etc.

Total£13 6 6

DERBY BRANCH.

Treasurer— WILLIAM PRAT, Esq.

Honorary Secretary— T. H. HARRISON, Esq.

Annual Subscriptions.

Table listing annual subscriptions for Derby Branch, including names like Abney, Rev. E. H., Bailey, John, Esq., Bakewell and Wilson, Messrs., etc.

Table listing names and amounts for Workington Branch, including Evans, Walter, Esq., Gascoyne, Geo. Esq., Holden, Rev. J. S., etc.

Total£26 15 6

Devonshire.

BARNSTAPLE AND BRAUNTON BRANCH.

Vice-Patron— The EARL FORTESCUE.

Chairman— Rev. A. E. SEYMOUR.

Honorary Secretary— H. C. GUPPY, Esq.

Annual Subscriptions.

Table listing annual subscriptions for Barnstaple and Braunton Branch, including names like Alford, Mr. Wm., Avery, W. Esq., Basset, C. H. Esq., etc.

Table listing names and amounts for Workington Branch, including Plockney, Mrs., Pinket, E. Esq., Pitowsky, A. Esq., etc.

Total£45 3 6

Donations.

Table listing donations for Barnstaple and Braunton Branch, including Sharland, Mrs., Moiety of Collections divided with Shipwrecked Mariners' Society, per Rev. J. Rutty, etc.

£50 15 9

BIDEFORD AND APPELDRE BRANCH.

Chairman— E. U. VIDAL, Esq.

Honorary Secretary— Rev. I. H. GOSSET, M.A.

Assist. Honorary Secretary— Mr. W. NILOL.

Annual Subscriptions.

Table listing annual subscriptions for Bideford and Appledre Branch, including names like Ball, Mrs., Bazeley, H. M. Esq., Benson, Mrs., Brooke, Mrs., etc.

BRANCHES—LIST OF ANNUAL SUBSCRIPTIONS AND DONATIONS. 117

<i>£. s. d.</i>	<i>£. s. d.</i>
Haverfield, T. W. Esq.	10 0
Heathcote, C. Esq.	5 0
Hinchliff, Major C. H.	5 0
Hole, C. W. Esq.	5 0
Holland, J. Esq.	5 0
How & Co. Messrs.	10 0
Hutchinson, Gen.	10 0
Hutchinson, Lt.-Col.	1 0
Inchledon, Miss.	5 0
James, Boucher, Esq.	10 0
Keir, Mrs.	5 0
Kempe, Rev. J. C.	10 0
Lang, Rev. D.	5 0
Large, Miss.	5 0
Lawrence, Miss.	5 0
Lock, T. Esq.	5 0
Macartney, Miss.	10 0
Macleod, Mrs.	5 0
Mallett, Mr. H. L.	5 0
Narraway, J. Esq.	5 0
Peard, G. Esq.	5 0
Pinkett, T. E. Esq.	5 0
Portsmouth, Countess.	1 0
Price, Cormell, Esq.	10 0
Price, W. E. Esq.	10 0
Pyke, Mrs.	1 0
Pymsent, T. Esq.	10 0
Reynolds, Miss.	5 0
*Reynolds, Rev. E.	5 0
Rickard, Mrs.	5 0
Rogers, Thos. Esq.	10 0
Rooker, J. Esq.	5 0
Rouse, E. Esq.	5 0
Sanders, R. Esq.	1 0
Sawer, F. Esq.	10 0
Smart, Miss.	5 0
Stapledon, W. Esq.	10 0
Stevens, J. C. M. Esq.	1 0
Stucley, Sir G. Bart.	1 0
Sutcliffe, Dr.	5 0
Thompson, Dr.	5 0
*Thrupp, Rear-Adml.	
R. N.	10 0
Thursby, Lieut.-Col.	
R. H.	5 0
Turner, G. Esq.	5 0
*Vidal, E. U. Esq.	10 0
Vidal, Mrs.	10 0
Vincent, Duncan & Co. Messrs.	10 0
Ward, Mr. W.	5 0
Wheeler, Lt.-Col.	5 0
White, Wm. Esq.	5 0
Whyte, Capt. R., R.N.	5 0
Willett, Capt.	10 0
Willett, Rev. C.	5 0
Wilson, Messrs.	5 0
Winterscale, Major.	5 0
*Wren, A. B. Esq.	10 0
Wren, Capt. R. F.	5 0
Sums under 5s.	9 10 3
Total.	£47 11 9
Donations.	
Junior School United Services College, Westward Ho!	10 0
Gardiner, Mrs. J.	10 0
Box at Boat House.	19 3
Box at Post Office, Westward Ho!	15 10
Other Boxes	9 10
Total Dona.	3 4 11
Total Subs.	47 11 9
£50 16 8	

CLOVELLY BRANCH.

Chairman—
N. H. FANE, Esq.
Honorary Secretary—
Mr. JOHN BUMBY.

Annual Subscriptions.

*Berriman, Mr. 5 0
*Bumby, Mr. J. 5 0
Chandler, Rev. Mr. 5 0
*Chichester, Rev. J. J. . . . 5 0

Total Dona. 15 9 7
Total Subs. 12 16 0

£28 5 7

Cooke, G. R. Esq.	1 0 0
*Fane, N. H. Esq.	2 2 0
*Harris, John Mr.	5 0
Stucley, Lieut.-Col.	1 0 0
Tucker, T. Pitts, Esq. . . .	10 6
Vine, Mrs. M. in memory of late Capt. Heard	5 0
*Whitefield, Mr. Ed- ward	5 0
Total.	£6 7 5
Donations.	
Aspill, John	10 0
C. W.	5 0
Fairfair, G. E. Esq.	5 0
Hughes, Theodore, Esq.	5 0 0
J. D. M.	5 0 0
Miller, Vice-Adml.	5 0
Southern, James B. Esq.	1 0 0
Sums under 5s.	0 18 6
Pillar and Contribu- tion Box.	6 1 0
Total Dona.	14 9 6
Total Subs.	6 7 6
£20 17 0	

DARTMOUTH BRANCH.

Chairman—
CHARLES CHALKER, Esq.
Honorary Secretary—
PERCY HOCKIN, Esq.

Annual Subscriptions.

Appleton, Major. 10 6
Arkwright, Captain,
R. N. 1 1 0
Brooking, Capt. A. 10 6
Brooking, Mr. Julian 10 6
*Chalker, Mr. 10 0
Coppinstone, Mr.
(H.M. Coast-
guards) 5 0
*Crauford, Mr. R. 5 0
Ellis, Mr. 5 0
Freake, Mrs. 1 0 0
Gower, Mr. 5 0
*Hockin, Mr. C. L. 5 0
*Hockin, Mr. Percy 5 0
Hockin, Mr. W. L. 5 0
Herrel, Mr. 10 6
Husband, Capt. 5 0
Lewis, Capt. 5 0
Newman, Sir Lyd-
ston, Bart. 1 0 0
Punchard, Capt. (2
years) 5 0
Rea, Mr. 5 0
Seffery, Capt., *Con-
way Castle*. 1 0 0
Square, Mr. H. 5 0
St. Anby, Rev. E. 1 0 0
Teage, Mr. 10 0
Tew, Mrs. 10 6
Tolman, Capt. 5 0
Toms, Major. 10 6
Sums under 5s. 5 0

Total. £12 16 0

Donations.

Collected by Edie and
Cobeldick, Messrs.
H.M. Customs 6 13 0
Collecting Boxes 4 14 7
Regatta Committee. 3 2 0
Seffery, Capt. *Con-
way Castle*. 1 0 0

Total Dona. 15 9 7
Total Subs. 12 16 0

£28 5 7

DAWLISH BRANCH.

Chairman—
SIR J. DUNTZK, BART.
Treasurer—
ALEX. McCASLAND, Esq.
Honorary Secretary—
J. B. PIKE, Esq.
Collector—
Mr. DAVID PHELAN, R.N.

Annual Subscriptions.

<i>£. s. d.</i>	<i>£. s. d.</i>
Adams, Miss.	5 0
Bagslaw, Mrs. F.	5 0
Brett, Capt. R.N.	10 6
Brown, Mr. M. G.	10 6
Collins, Miss.	1 1 0
Craigie, Mrs.	1 1 0
Douglas, Lady.	1 0 0
Dozat, Lieut. R.N.	10 0
*Duntze, Sir J., Bart. . . .	1 0 0
Ermen, Mr. P.	10 6
Ermen, Mr. G.	10 0
Ferrie, Mr. R.	10 6
Ferrie, Mr. W.	5 0
Fortiscue, M. (Judge)	1 1 0
Garland, Mrs. (Don.)	10 0
Grace, Mrs.	10 6
Grace, Miss.	10 6
Hoare, Mr. P. M.	10 0
Holt, Mr.	10 0
Hughes, Col.	10 6
Jackson, Major.	1 1 0
Lea Mr. Thomas	2 2 0
Little, Mr. J. H.	5 0
Maer, Messrs. & Co.	10 0
Manley, Rev. G.	5 0
Marshall, Miss.	10 0
Maye, Mrs.	10 0
Maye, Mr. Thos.	1 0 0
Mayne, Rev. Jas.	10 0
*McCasland, Mr. A.	1 0 0
Moes, Mr.	10 6
Noeworthy, Mrs.	10 6
Nutthall, Mrs.	10 6
Pennell, Mr.	5 0
*Pike, Mr. John B.	10 0
Pike, Mrs. W. J.	10 6
Porter, Mr. H. A.	10 0
Riach, General.	2 2 0
Savill, Lieut.-Col.	5 0
Skilliter, Mr. J.	10 0
Sneyd Mr. Thos.	5 0
Strickland, Miss.	1 1 0
Swee, Colonel	5 0
Tebbit, Mr. W.	1 1 0
Tozer, Mr. Edgar	10 0
Ware, Mrs.	10 0
Welsh, Mr.	10 0
West, Mrs. (Don.)	5 0
Weston, Mrs. P.	10 0
Whidborne, Mr. J. S.	10 6
Wiley, Mr. J. W.	10 6
Williams, Mrs. J.	5 0
Total.	£31 14 0
Sums under 5s.	1 8 0
Pillar and Collecting Boxes	4 7 0
£37 9 6	

EXETER BRANCH.

President—
**The Right Hon. the EARL
of DEVON.**
**Honorary Treasurers and
Secretaries.**
THOMAS B. GIBBS, Esq.
**COURTENAY H. EDMONDS,
Esq.**

Annual Subscriptions.

Acland, Sir T. D. 1 1 0
Arden, Mrs. 1 1 0
Auston, J., Esq. 5 0

<i>£. s. d.</i>	<i>£. s. d.</i>
Barnes, W. Esq. Jun.	1 1 0
Belfield, J. Esq.	1 1 0
Bond, Miss	5 0
Brennridge, Miss.	1 1 0
Bullivant, J. Esq.	1 1 0
Cardew, Mrs.	5 0
Chibbertson, W. Esq., J.P.	5 0
Churchill, Miss.	2 0 0
Dickens, Capt.	10 0
Drake, Dr.	5 0
Drake, Mr.	5 0
Ellis, Rev. R.	5 0
Evans, Miss.	2 0
Follett, J. C. Esq.	1 1 0
Gard, Mrs.	1 1 0
Geare, J. Esq.	5 5 0
Gibbs, T. B. Esq.	10 0
Gray, W. Esq.	5 0
Green, E. Esq.	5 0
Hooper, Smith, Esq.	5 0
Hooks, Rev.	5 0
Huxham, C. Esq.	1 1 0
l'Anson, J. Esq.	10 0
Kenaway, Miss A.	1 1 0
Lee, Canon	10 6
Lloyd, H. Esq.	10 6
Martyn, H. Esq.	10 0
Mason, Browne, Esq.	5 0
Mathews, Miss	5 0
Milford, J. Esq.	1 0 0
Milford, Mrs.	10 0
Milne, Mr.	5 0
Mortimer, Major	5 0
Norman and Pring, Messrs.	1 0 0
Payne, Major	5 0
Pengelly, Mr. J. L.	5 0
Pinder and Tuckwell, Messrs.	5 0
Sanders, R. Esq.	1 1 0
Segan, Mrs.	5 0
Tharpe, Mrs. T. R.	1 0 0
Thomas and Co., Messrs. J. L.	10 6
Tucker, C. Esq.	5 0
Tucker, J. S. Esq.	5 0
Varwell, Mr.	5 0
White, Rear-Admiral C.B.	1 1 0
Wilcocks, Weston, & Dinham	1 1 0
Williams, Mr.	5 0
Wilson, Mrs.	1 0 0
Wilson & Son, Messrs.	5 0
Wippell, Mr. C. J.	10 0
Wippell, J. Esq.	5 0
St. Mary Arches Or- fatory	4 2
Total.	£36 0 8

EXMOUTH BRANCH.

Patroness—
The Right Hon. LADY ROLLE.
Chairman—
CHARLES PRETTLOHN, Esq.
Honorary Secretary—
Capt. C. SQUIRE.
Collector—
Mr. E. GARD.

Annual Subscriptions.

Abbott, Misses 7 6
*Adams, H. C. Esq. 10 0
Allen, G. T. Esq. 5 0
Back, F. D. Esq. R.N. 5 0
*Bartlett, General. 10 0
Bastin, Mrs. 5 0
Baldcock, Mrs. 5 0
Bazalgette, Col. C. J. 10 0
Beaven, The Misses. 5 0
Beison, Mrs. 5 0
Bevans, Mrs. 10 0
*Birch, C. Esq. 10 0
Boase, J., Esq. 10 0

Table listing names and amounts for the Ilfracombe and Morle Branch, including Boles, Rev. J. T., Brent, Miss, and various other contributors.

Summary table for Ilfracombe and Morle Branch showing total amounts of £73 13 6.

ILFRACOMBE AND MORLE BRANCH.

Chairman - P. STONEHAM, Esq. Honorary Secretary - N. VYR, Esq. J.P.

Table listing names and amounts for the Ilfracombe and Morle Branch, including Adams, George Esq., Blandy, Mrs., and various other contributors.

Summary table for Ilfracombe and Morle Branch showing total amounts of £25 18 6.

Table listing names and amounts for the Ilfracombe and Morle Branch, including Acland, Lieut. B. D., Alcock, Miss, and various other contributors.

Table listing names and amounts for the Lynmouth Branch, including Collected by Mrs., Gardener, and various other contributors.

Summary table for Lynmouth Branch showing total amounts of £69 7 3.

LYNMOUTH BRANCH.

Honorary Secretary - Mr. JOHN CROOK.

Table listing names and amounts for the Lynmouth Branch, including Baker, Mr., Berry, F. C., M.D., and various other contributors.

Summary table for Lynmouth Branch showing total amounts of £7 5 6.

Table listing names and amounts for the Lynmouth Branch, including Donations and Contribution Boxes.

Summary table for Lynmouth Branch showing total amounts of £11 18 0.

NEWTON ABBOT BRANCH.

Honorary Secretaries - Major F. D. BEWES, Mr. R. L. LLOYD.

Table listing names and amounts for the Newton Abbot Branch, including Armstrong, Dr. Leonard, Baker, R. H. M. Esq., and various other contributors.

Summary table for Newton Abbot Branch showing total amounts of £19 14 11.

PORT OF PLYMOUTH BRANCH.

Chairman - ADMIRAL H. D. HICKLEY.

Treasurer - JOHN SREYENS.

Honorary Secretary - JAMES ROONEY.

Annual Subscriptions.

Table listing names and amounts for the Port of Plymouth Branch, including Adams, B., Adams, Clark, and Lindon, and various other contributors.

BRANCHES—LIST OF ANNUAL SUBSCRIPTIONS AND DONATIONS. 121

YEALM RIVER BRANCH.

Chairman—**BALDWIN, J.P. BASTARD, Esq.**
Hon. Secretary—**HON. MICHAEL WILLIAMS, Esq.**

<i>Annual Subscriptions.</i>	
<i>£</i>	<i>s. d.</i>
*Archer, Rev. S. H.	1 1 0
*Baring, Edward C.	1 1 0
*Bastard, Baldwin	
J. P. (Chairman)	1 1 0
Collinsplatt, Hawtrey	1 1 0
*Collinsplatt, Henry	1 1 0
*Cory, Richard	1 1 0
*Dawson, Ralph	1 1 0
Dawson, Mrs.	1 1 0
Hicks, Col. C. B.	1 1 0
Hicks, Miss.	1 1 0
Holberton, T. & V.	1 1 0
*Lane, Rev. Richard	1 1 0
Mildmay, H. B.	1 1 0
*Roe, Rev. Henry F.	1 1 0
*Williams, Michael	1 1 0
Yonge, Mrs. Duke	1 1 0
Yonge, J. E. Esq.	1 1 0
Total	£17 17 0
<i>Donations.</i>	
Baring, E. C. Esq.	5 5 0
Williams, Michael, Esq.	5 5 0
Total Dons.	10 10 0
Total Subs.	£27 17 0
	£28 7 0

ISLE OF PURBECK BRANCH.

President—**THE EARL OF ELDON.**
Vice-President—**Lieut.-Col. MANSEL.**
Honorary Secretary—**GEORGE H. BOND, Esq.**

<i>Annual Subscriptions.</i>	
<i>£</i>	<i>s. d.</i>
*Earl of Eldon	15 0 0
Bankes, Albert, Esq.	1 1 0
*Bankes, Rev. Canon	1 0 0
Bennett, S. Esq.	10 0 0
Best, Mr. J. B. C.	5 0 0
Bond, George, H. Esq.	1 0 0
*Bond, Nath. Esq.	1 10 0
Bond, Rev. Canon	1 0 0
Bond, Rev. John	10 6 0
Bond, Thos. Esq.	10 0 0
Browne, Rev. Wm. C.	10 0 0
Cann, Mr. R.	5 0 0
Colson, Miss	5 0 0
Cust, Mr.	5 0 0
Dauidel, Woodruffe, Esq.	10 0 0
Digby, G. Wingfield, Esq.	2 2 0
Drew, Mr. J. S.	5 0 0
Farrer, Mrs.	1 0 0
Filliter, F. Esq.	1 1 0
Fyler, J. Esq.	1 0 0
Hoare, Mrs. C. R.	1 0 0
Hooper, Mr. R.	10 0 0
Hutchings, R. C. Esq.	10 0 0
Jackson, Miss	1 0 0
Johnson, Mr. J.	10 0 0
Kent, Mr. J.	5 0 0
Lester, Rev. Lester	10 0 0
*Mansel, Lieut.-Col.	1 0 0
*Mansel, Rev. O. L.	1 0 0
Marshall, Mr. R. J.	10 0 0
Marshall, Mr. F.	10 0 0
Oakley, Mr.	5 0 0
Onslow, Rev. C.	10 0 0
Panton, Messrs. H. & Co.	10 6 0
Pike, W. J. Esq.	1 0 0
Randall, Mr. F.	5 0 0
Rodgett, Mrs.	2 0 0
Seavill, Rev. T.	5 0 0
Selby, Mr. C.	10 0 0
Serrell, Mrs.	1 0 0
Stilwell, H. Esq.	10 0 0
Trenchard, Mr. James	7 6 0
Willshire, Mr.	5 0 0
Total	£44 2 6
<i>Donations.</i>	
Collected by Miss Yearsley	14 0 0
Collected at Life-boat Meeting at Langton by Mrs. Serrell	1 5 0
Collected by Mrs. H. Robertson, Bingenar Hall	1 0 2
Collected by Mr. Syms, small sums	13 0 0
Total Dons.	3 12 2
Total Subs.	£44 2 6
	£47 14 8

LYME REGIS BRANCH.

Chairman—**WILLIAM HINGESTON, Esq.**
Honorary Secretary—**Mr. H. MILLER.**

<i>Annual Subscriptions.</i>	
<i>£</i>	<i>s. d.</i>
Ames, E. L. Esq.	1 1 0
Andrews, A.	5 0 0
Bangay, Mrs.	10 0 0
Total	£10 12 1
Total	£10 12 1

<i>Annual Subscriptions.</i>	
<i>£</i>	<i>s. d.</i>
*Brandram, Lt.-Col.	1 0 0
Busk, Mrs.	5 0 0
Bullen, Capt. R.N.	10 0 0
Chalmers, A. J. Esq.	5 0 0
Edwards, Z. Esq.	10 0 0
Goldie, C. Esq.	10 0 0
Hayward, Miss	10 0 0
Henley, Miss	10 0 0
Henning, Miss	5 0 0
*Hingeston, Wm. Esq.	1 0 0
Homan, E. Esq.	1 1 0
Hussey, Capt.	5 0 0
Ingram, H. F. Esq.	1 0 0
Landon, Mrs.	5 0 0
Lean, Mrs.	10 0 0
Leathes, Miss Stanger	10 0 0
Lewin, Lieut.-Col.	1 1 0
Lister, Mr.	10 0 0
Loveridge, Mrs.	5 0 0
Manning, Capt. C. F.	
Downes	5 0 0
Marsh, Isaac, Esq.	5 0 0
Matthey, C. Esq.	10 0 0
Munro, Capt.	10 0 0
*Newall, G. F. Esq.	5 0 0
Palgrave, Mrs.	5 0 0
Peel, Rev. Edward	1 0 0
Peel, E. Esq.	3 0 0
Poulson, the Misses	5 0 0
*Preston, I. W. Esq.	10 0 0
Radford and Radford	5 0 0
Rogerson, Mrs.	5 0 0
Rowley, Mrs.	5 0 0
Shore, Mrs.	5 0 0
Skidner, D. S. Esq.	5 0 0
Stewart, Rev. J. S.	5 0 0
Symons, Mrs.	10 0 0
Talbot, J. R. F. G. Esq.	5 0 0
*Tucker, Henry, Esq.	10 0 0
Vicar, The	1 1 0
Vizard, Mrs. H. B.	1 0 0
Wallis, Mrs. W. B.	5 0 0
Waring, Mrs.	5 0 0
Williams, R. & R. and Co.	1 1 0
Wrey, Mrs.	10 0 0
Sums under 5s.	5 0 0
Total	£26 5 0
<i>Donations.</i>	
Pillar Boxes	1 12 5
Total Dons.	1 12 5
Total Subs.	£26 5 0
	£27 17 5

POOLE AND BOURNEMOUTH BRANCH.

Patron—**The Right Hon. the Earl of SHAFTESBURY, K.G.**
President—**The Right Hon. Lord WIMBORNE.**
Chairman—**Rev. J. A. LAWSON.**
Honorary Secretary and Treasurer—**G. BRAXTON ALDRIDGE, Esq.**

<i>Annual Subscriptions.</i>	
<i>£</i>	<i>s. d.</i>
*Aldridge, G. B. Esq.	5 0 0
Alington, Lord	1 1 0
Belben, G. Esq.	10 0 0
Belben, T. Esq.	10 0 0
Bush, Col. A. L.	5 0 0
Brooke, W. Esq.	5 0 0
Budge, P. E. L. Esq.	10 0 0
Cairns, Lady	10 0 0
*Cavell, Rev. H. T.	10 0 0

<i>Annual Subscriptions.</i>	
<i>£</i>	<i>s. d.</i>
Coleman, Rev.	5 0 0
*Colquhoun, Sir Jas.	
Bart.	1 1 0
Copeman, Esq.	5 0 0
Cox, T. Esq.	1 1 0
Crokat, Mrs. C.	5 0 0
Damer, Rev. L. Dawson	1 0 0
Davey, Horace, Esq.	
M.P.	1 1 0
Denison, Hon. Mrs.	10 0 0
Devenish, M. H. Esq.	5 0 0
Digby, G. D. W. Esq.	2 10 0
Dugmore, H. R. Esq.	10 0 0
Dugmore, Rev. E. E.	5 0 0
Elton, Miss	5 0 0
*Everett, G. Esq.	5 0 0
Elwes, Capt.	10 0 0
Fellowes, Gen.	5 0 0
Field, J. Lyon.	5 0 0
Fox, Mrs. C.	5 0 0
Futvoye, Edwd. Esq.	10 0 0
Gill, Rev. W.	5 0 0
Glyn, Sir R. G. Bart.	2 0 0
Glyn, Rev. C. J.	10 0 0
*God, Capt.	5 0 0
*Goodwin, Jas. P. Esq.	1 1 0
Grey, Admiral.	10 0 0
Hankinson, J. T. Esq.	5 0 0
Hill, Mrs.	5 0 0
Hudson, J. S. Esq.	5 0 0
Hyde, J. C. Esq.	5 0 0
Inglis, Mrs.	1 0 0
Jennings, Reginald, Esq.	15 0 0
Johnson, Alfred, Esq.	5 0 0
Kemp, Rev. A.	1 0 0
Kemp, Miss	1 0 0
Kettle, Miss.	10 0 0
King, Hugh, Esq.	1 1 0
Lang, Major	10 0 0
*Lawson, Rev. J. A.	5 0 0
Letchworth, Thos. Esq.	5 0 0
Loring, Rev. H. N.	10 0 0
Lowe, Hon. M. Drury	5 0 0
Mahon, R. H. D.	2 0 0
Mahon, Mrs.	1 0 0
Mann, J. T. Esq.	5 0 0
Mason, J. T. Esq.	5 0 0
*McWilliam, J. Esq.	10 0 0
*Meredith, H. Esq.	5 0 0
Moore, Josiah, Esq.	5 0 0
Moore, W. W.	5 0 0
Myers, Mrs.	5 0 0
Norton, J. J. Esq.	10 0 0
Orred, Miss	5 0 0
Onslow, Rev. C.	10 0 0
Perrie, Dr.	5 0 0
Pearce, W. Esq., J.P.	10 0 0
Penryhn, E. H. Lester	10 0 0
Phelps, Miss	10 0 0
Picard, Miss	5 0 0
Portman, Hon. W. H. B.	1 0 0
Robson, W. Esq.	5 0 0
Schreiber, C. Esq.	
M.P.	2 2 0
Shaftesbury, Earl of, K.G.	5 0 0
Slade, Mrs.	5 0 0
Sladen, Rev. E. H. M.	10 0 0
Stewart, Miss	5 0 0
Stockton, Mrs.	10 0 0
*Sullivan, Admiral Sir B.J., K.C.B.	1 0 0
Tod, David, Esq.	1 0 0
Venner, Col. L. S.	5 0 0
Verner, Lt.-Col.	5 0 0
Waterman, W. Esq.	5 0 0
*Welch, M. Kemp, Esq.	10 0 0
West, Miss	10 0 0
Williamson, J. Esq.	1 1 0
Wimborne, Lord	2 2 0
Wood, M., Esq.	5 0 0
Young, C. E. Baring, Esq.	1 1 0
Young, Edwd. Esq.	5 0 0
Total	£55 10 6

BRANCHES— LIST OF ANNUAL SUBSCRIPTIONS AND DONATIONS. 123

SUNDERLAND AND WHITBURN BRANCH.

Chairman—
ALDERMAN REED.
Treasurer and
Honorary Secretary—
J. C. PORRETT, Esq.
Hon. Sec. at Whitburn,
W. H. WILLIAMSON, Esq.

Annual Subscriptions.	
£.	s. d.
Alderson, C. Esq.	10 0
Allison, J. J. and W. H. Messrs.	1 0
Anderson, T. Esq.	1 0
Armstrong, Addison & Co. Messrs.	1 0
Austin, S. P. & Son, Messrs.	1 1 0
Backhouse and Co., Messrs.	1 1 0
Barnes, T. Esq.	3 0
Bartram & Haswell, Messrs.	1 1 0
*Barwick, I. S. Esq.	3 19 0
Blain, Thomas Esq.	10 6
Blumer & Co. Messrs.	5 0
Booth, George B. Esq.	10 0
Bramwell and Co., Messrs.	1 1 0
Brantingham, P. T. Esq.	1 0
Briggs, Wm. & Sons, Messrs.	10 0
Christal, J. and Sons, Messrs.	10 0
Clarke, George Esq.	1 1 0
Cockin, Rev Canon. Craven and Speeding, Messrs.	1 0
Crosby, Thos. Esq.	10 6
Cross, John, Esq. per N. P. Bank Sunderland Branch.	1 1 0
Culliford, J. H. W. Esq.	10 6
Davison, R. G. Esq.	5 0
Davison, W.	5 0
Dickenson, J. Esq.	10 0
Dixon and Wilson, Messrs.	1 1 0
Durham, Right Hon. Earl of.	2 2 0
Elder, Wm. Esq.	5 0
Elliot, Thomas, and Son, Messrs.	10 0
Fairley, T. W. and C. Messrs.	7 6
Fatman, J. C. Esq.	5 0
Featherstonhaugh, A. W. and E., Messrs.	10 0
Fenwick, Arthur, Esq.	2 1 0
Forster, John, Esq.	5 0
Gayner, R. H. Esq.	1 1 0
Gordon and Stamp, Messrs.	6 10 0
Govland, G. H. Esq.	10 6
Graham and Shepherd, Messrs.	10 0
Graham, Henry, Esq.	5 0
Greives, J. W. Esq.	5 0
Grimshaw and Sons, Messrs.	10 0
Harrison Brothers, Messrs.	5 0
Harrison, T. E. Esq.	1 10 0
Harrison, W. B. Esq.	10 0
Hartley, James, Esq.	1 1 0
Hill, J. G. Esq.	10 0
Hills, James, Esq.	5 0
Hills, W. H. Esq.	5 0
Hodgson, Mrs.	10 0
*Horan, James, Esq.	10 0
Hudson, R. & Sons, Messrs.	10 0
Kish, Thos. Esq.	10 6

£.	s.	d.
Laing, James, Esq.	1	1 0
Lambton and Co., Messrs.	1	1 0
*Liburn, Chas. Esq.	10	6
Lumsdon, Byers, and Co. Messrs.	1	1 0
Meier, C. W. and Co. Messrs.	5	0
Morton, H. T. Esq.	10	6
Newbiggin, E. J. Esq.	5	0
Oliver, R. Esq.	10	0
*Peckett, G. C. Esq.	5	0
Pemberton, R. L. Esq.	1	0
Pinkney, D. G. and Sons, Messrs.	1	1 0
*Porrett, R. B. Esq.	1	1 0
Potts, J. Jun. Esq.	1	1 0
Potts, R. H. Esq.	1	0
Price, Rev. Dr.	1	0
Reay, T. J. Esq.	5	0
*Reed, Alderman.	1	1 0
Richardson, S. Esq.	10	0
Ritson, Henry, Esq.	5	0
Ritson, John & Sons, Messrs.	10	0
Robinson, G. H. Esq.	5	0
Robson, E. C. & Sons, Messrs.	10	0
Robson, W. W. and Sons, Messrs.	5	0
Rutter, R. P. W. Esq.	5	0
Service and Phillips, Messrs.	5	0
Shadforth, Robt. Esq.	1	0
Sheraton, Richd. Esq.	5	0
Smith, Alexander, Esq.	10	0
*St. John, Wm. Esq.	10	6
Steel, Thomas, Esq.	5	0
Stobart, William, Esq.	10	0
*Taylor & Sanderson, Messrs.	10	6
*Thompson, Alderman William	10	0
Thompson, J. and H. H. & Co. Messrs.	10	0
Thompson, John, Esq.	5	0
Thompson & Wrightson, Messrs.	10	6
Tone, William, Esq.	10	0
Tinkler, Wm. Esq.	5	0
Tyzaeck & Branfoot, Messrs.	1	0
Vaux, C. and Sons, Messrs.	5	0
Watson, George, Esq.	10	0
*Wayman, J. W. Esq.	10	6
Weatherley & Cropton, Messrs.	10	0
Wiener, Martin, Esq.	1	1 0
Williamson, Sir H., Bart.	4	0
*Williamson, W. H. Esq.	2	0
Wilson, W. S. Esq.	10	0
Wilson C. Stanley, Esq.	10	6
Wilson, C. Esq.	10	6
Woods & Co. Messrs.	1	1 0
Woodcock, Mrs., Interest on the legacy of the late.	3	8 9
Total	283	19 3

Sundry Donations,
per H.M. Customs 99 13 18
Collecting Boxes ... 2 19 8
£177 12 9

WEST HARTLEPOOL BRANCH.

Chairman—
Thos. LOVE, Esq., H.M.C.
Honorary Secretary—
C. A. BAKER, Esq.
Annual Subscriptions and Donations.

£.	s.	d.
*Appleby, Thos. Esq.	1	1 0
Bunting, Arthur, Esq.	1	1 0
Caspar, E. A. & Co. Messrs.	10	6
Cory, E. & Co. Messrs.	1	1 0
East Coast Insurance Co.	2	2 0
English, Francis, Esq.	10	6
Farmer, A. Esq.	1	1 0
Foster and Yeoman, Messrs.	1	1 0
Fryer, K. Esq.	5	0
Furness, T. & Co. Messrs.	2	2 0
*Gay, W. & Co. Messrs.	2	2 0
Geipel, W. Esq.	10	6
*Groves, Wm. Maclean, & Co. Messrs.	1	1 0
Herskind, F. Esq.	10	6
Horsley, G. & Co. Messrs.	10	6
Hudson, T. S. Esq.	1	1 0
*Irvine, Robert & Co. Messrs.	2	2 0
Lauder, E. & Co. Messrs.	10	6
Lister, Baumann, & Co. Messrs.	5	0
Lohden, J. and Co. Messrs.	1	1 0
May and Hassell, Messrs.	10	6
Merryweather, J. and Co. Messrs.	10	6
Middleton and Co. Messrs.	1	1 0
Nilson & Co.	0	10 6
Pearson, G. T. & Co. Messrs.	1	1 0
Pease, Joseph and Partners, Messrs.	1	1 0
*Pyman, G. and Co. Messrs.	2	2 0
Robinson, Thomas, Esq.	10	0
Roe, William, Esq.	1	1 0
*Ropner, R. and Co. Messrs.	1	1 0
Trechmann, Otto, Esq.	2	2 0
Turbull, Ed. Esq.	1	0
Wate, R. Sons, & Co. Messrs.	1	1 0
Walker, Thos. & Co. Messrs.	2	2 0
Wilkinson, T. H. Esq.	5	0
Withy, E. and Co. Messrs.	10	6
*Young, W. J. Esq.	2	2 0
Total	239	0 0

Essex.
ESSEX AND COLCHESTER BRANCH.

Chairman—
J. BAWTREE HARVEY, Esq.,
Mayor of Colchester.
Vice-President—
Major Bishop.
Treasurer—
JOHN BAWTREE, Esq.

Hon. Secretary—
CHARLES E. BLAND, Esq.,
12 Crouch Street, Colchester.
Annual Subscriptions.
1882.

£.	s.	d.
Balderston, Miss.	2	2 0
Bannatyne, Rev. C., the late.	1	0 0
*Bawtree, John, Esq.	1	1 0
Bishop, Major.	1	1 0
Carlingford, Rt. Hon. Lord.	2	0 0
Causton, R. K. Esq., M.P.	1	1 0
Errington, G. H. Esq., the late.	1	1 0
Froeland, Mrs.	1	1 0
Hanson, Mrs. G.	1	1 0
Harvey, J. Bawtree, Esq., Mayor of Colchester.	1	1 0
Luard, Admiral, C.B.	1	1 0
Round, Mrs. Chas. G.	1	1 0
Round, Mrs. Geo.	1	0 0
Willis, W. Esq., Q.C., M.P.	1	1 0
Total	16	12 0

CLACTON-ON-SEA BRANCH.

President—
Chairman—
JAMES HALMAN, Esq.
Honorary Secretary—
Wm. WARREN TOWSE, Esq.

Annual Subscriptions.	
Agate, Wm. Esq.	10 6
Ager, George, Esq.	10 6
Albans, St. Lord Bishop of.	1 1 0
Allen, W. Esq.	10 6
*Baker, W. Esq.	5 0
Bawtree, O. Esq.	1 1 0
Boys, J. Esq.	2 2 0
Burford & Lewellen	10 6
Chambers, Geo.	5 0
Ellis, James, Esq.	10 6
Fowler, J. T. Esq.	10 0
Furness, T. Esq.	1 1 0
*Harman, J. Esq.	1 1 0
Harman & Matthews	10 6
Harrison, G. Esq.	1 1 0
Hayes, T. D. Esq.	10 6
Hudson, Matthews, and Co.	1 1 0
*Hurrell, R. G.	10 6
Kitching, A. G. Esq.	1 1 0
Law, Rev. Henry.	2 2 0
Law, Mrs.	1 1 0
Lilley, — Esq.	1 1 0
Maine, W. Esq.	10 6
*Mann, J. Esq.	1 1 0
Mitchell, J. Esq.	10 6
*Page, H. J. Esq.	1 1 0
Penfold, A. Esq.	10 6
Philbrick, Miss	10 0
Piggott, Rev.	10 0
Poston, C. Esq.	1 1 0

Table with 3 columns: Name, £, s. d.
Price, Mrs. 1 1 0
Smith and Gale. 1 1 0
Tabrum and Jones. - 10 6
Topp, J. Esq. - 10 6
Towse, W. B. Esq. 1 1 0
*Towse, W. Wrench 1 1 0
*Wallis, Frederick. 1 1 0
Watson, J. Y. Esq. 1 1 0
J.P. 1 1 0
Total £31 18 6

Donations.

Table with 3 columns: Name, £, s. d.
Fishmongers Coy. London. 10 10 0
Foresters, Court No. 2094, per John Howe. 5 5 0
Johnson, Mrs. - 10 0
Page, Mrs. H. J. 1 1 0
Furness, Master. - 2 0
Sanders, E. - 10 0
H. M. - 5 0
Proceeds of Concert. 18 11 6
Boxes. 11 10 0
Total Dons. 48 4 6
Total Subs. 31 18 6
£90 3 0

HARWICH BRANCH

President—
EDGAR WALTER GARLAND,
Esq., High Steward of the
Borough of Harwich.

Chairman—
J. R. FRANKS, Esq.

Honorary Secretary—
S. EVANS, Esq., L.R.C.P.
(Lond.)

Annual Subscriptions.

Table with 3 columns: Name, £, s. d.
Bageshaw, Miss. - 10 0
*Barnes, R. S. Esq. - 10 6
Bevan, Mr. C. F. - 10 6
*Brady, H. Esq. 1 0 0
Bull, Mr. J. - 10 0
Burmester, Rev. G. and Family. 1 10 0
Carlingford, Lord. 2 2 0
Collison, C. F. Esq. 1 1 0
Cottingham, F. Esq. - 10 6
Cox, Mrs. - 10 0
D. 2 0 0
Eley, Chas. Esq. 1 1 0
Evans, Mrs. - 10 0
Evans, S. Esq. 1 1 0
*Franks, J. R. Esq. - 10 6
Fulcher, Mr. J. - 10 6
Garland, E. W. Esq. 10 0 0
Grice, Mr. J. - 10 0
Groom & Son, Messrs. 1 0 0
Hammond, Miss. - 10 0
Hempson, A. Esq. - 10 6
Jackson, G. L. Mr. - 5 0
King, Mr. M. D. - 10 0
Marsden, Canon. 1 1 0
*Murray, Mr. W. - 10 6
Nalborough, W. J. Esq. - 10 0
Nichols, J. M., Esq. 2 0 0
Nunn, T. W. Esq. - 10 6
Patrick and Son, Messrs. 1 1 0
Self, Mr. J. - 10 0
*Shute, H. Esq. 1 1 0
Tyler, Sir Henry 1 0 0
Walker, A. Esq. 1 1 0
*Watts, John, Esq. - 10 6
Worts, Mr. A. - 10 6
Total £39 0 0

Table with 3 columns: Name, £, s. d.
Nichols, F. M. Esq. 2 0 0
Contribution Boxes on board G. E. R. steamers, and at boat-house. 1 11 2
Total Dons. 3 11 2
Total Subs. 38 0 0
£41 11 2

SOUTHEND BRANCH.

Chairman—
Rev. F. THACKERAY.

Honorary Secretary—
JAMES RICHMOND, Esq.

Annual Subscriptions.

Table with 3 columns: Name, £, s. d.
*Beard, Mr. - 10 0
Belt, Miss L. - 10 6
*Bligh, Mr. 1 0 0
*Brightwell, Mr. L. R. 1 0 0
Browne, Rev. R. C. - 5 0
Deeping, Mr. G. D. - 10 6
Detmar, Mr. - 10 0
Detmar, Miss May. - 5 0
*Dowsett, Mr. - 10 0
Draper, Edward H. 1 1 0
*Fache, Mr. Cha. J. - 10 0
*Gregson, Mr. W. - 10 6
Lancaster, Mr. J. L. 1 0 0
Merritt, Mr. W. D. - 10 6
Merritt, Mrs. W. D. - 10 6
*Richmond, Mr. - 10 0
Swaine, Mrs. G. - 10 0
*Thackeray, Rev. F. 1 1 0
*Waters, Samuel. 2 0 0
Webster, Mr. W. - 10 6
Wise, Mr. Loyde - 10 0
Withers, Mr. 1 1 0
Wood, Mr. F. 1 1 0
*Woodsman, Mr. - 10 6
Total £17 4 6

Donations.

Table with 3 columns: Name, £, s. d.
Priory Masonic Lodge 10 0 0
Contribution Boxes. 5 15 9
Southend Mutual Improvement Association, by Mr. Bedwell. - 17 0
£33 17 3

Flintshire.

RHYL BRANCH.

President—
R. BAMFORD HESKETH, Esq.

Chairman—
T. GRIFFIES DIXON, Esq.

Treasurers—
NORTH AND SOUTH WALES BANK.

Honorary Secretary—
Mr. ROBERT HUGHES.

Annual Subscriptions.

Table with 3 columns: Name, £, s. d.
Buddicom, W. B. Esq. 2 0 0
*Butterton, Rev. G. A., D.D. - 10 6
Churton, John, Esq. - 10 0
*Conwy, Major Conwy Rowley (2 years). 10 0 0
*Dixon, T. Griffies, Esq. 2 2 0
Fuller, Mrs. 2 2 0

Table with 3 columns: Name, £, s. d.
George, Oliver, Esq. 1 1 0
Gladstone, Rev. S. E. 1 0 0
*Hesketh, R. Bamford, Esq. 5 0 0
Hughes, H. R. Esq., Kimmel (2 years). 10 0 0
*Johnson, G. Esq. - 5 0
Jones, Mrs. E. Olinda 2 2 0
*Jones, W. Price, Esq. - 10 6
Jones, Mrs. Price, the late. - 10 6
Mainwaring, T. Esq. 5 0 0
*Morgan, Edwin, Esq. - 10 0
Mountfield, W. B. Esq. (3 years). 1 11 6
Penn, Major (3 years) 1 11 6
Pennant, P. P. Esq. 1 0 0
*Richardson, Rev. F. M.A. - 10 0
Roberts, J. Esq. M.P. (2 years). 2 2 0
*Sisson, R. J. Esq. 1 1 0
Sneyd, Miss. 1 0 0
St. Asaph, Dean of. 1 0 0
Wilkin, W. Esq. 1 1 0
Winston, Thos. Esq. 1 1 0
Wynn, Mrs. Wma. 1 1 0
Total £56 2 0

Donations.

Table with 3 columns: Name, £, s. d.
Alexandra Hotel. - 6 1
Barometer Box. - 8 0
Belvoir Hotel. - 10 2
Clift Market Hall. - 9 0
Mona Hotel. - 8 1
Mostyn Hotel. 1 14 7
Parade Pillar Box. 4 15 4
Pier Refreshment Rooms. - 15 8
Queen's Hotel. - 16 6
Railway Refreshment Rooms. - 6 2
Royal Hotel. 1 9 7
Rugby Refreshment Rooms. - 5 0
Sun Inn. - 8 2
Westminster Hotel. 1 3 0
Sums under 5s. - 12 0
Bank Interest. - 9 0
Total Dons. 14 16 4
Total Subs. 56 2 0
£70 18 4

Glamorganshire.

CARDIFF AND PENARTH BRANCH.

Patron—
C. E. M. TALBOT, Esq. M.P.

Chairman—
Colonel E. S. HILL.

Treasurer—
JAS. EDWARDS, Esq. Penarth.

Honorary Secretary—
Commander W. M. PEN-GELLEY, H.M.'s late Indian Navy.

Subscriptions for 1882.

Table with 3 columns: Name, £, s. d.
Aberdare Coal Co. - 10 6
Adams, Mr. G. F. - 10 0
Adams & Wilson. - 5 0
Alexander & Co. 1 1 0
Andrews, Mr. S. - 10 6
Anning, Mr. J. H. - 10 0
Baker, T. and Son. - 10 6

Table with 3 columns: Name, £, s. d.
Barnes, Guthrie & Co. - 10 6
Bewick, Mr. Geo. - 10 0
*Bland & Co., Messrs. J. 1 0 0
*Bovey, John and Co. Messrs. - 10 6
Brown, Mr. Forster. - 5 0
Burness, Jas. & Sons 1 1 0
Bute, Marquis of. 10 0 0
Byers, Dr. - 5 0
Capper, Mr. E. H. - 10 6
Clive, Lady Mary Windsor. 1 1 0
Coedcae Coal Co. - 10 6
Cloack, Capt. H. - 5 0
Coffin and Co. 1 1 0
Cornwell, Mr. D. - 10 6
Cory Bros. and Co. 1 1 0
Cory, J. and Sons. - 10 0
Davies, David, & Co. 1 1 0
Davis, David, & Sons 1 1 0
Duncan, Mr. R. - 5 0
Edwards, Mr. Fk. - 10 0
Ellitt, J. and Son, Messrs. - 10 0
Fothergill, Mr. H. - 5 0
Frazer and Co. - 10 0
Fry, Mr. John. - 10 0
*Fry, Mr. W. J. B. - 10 0
Gaskell, Mr. Joseph. - 10 6
Glamorgan Coal Co. 1 1 0
Greenhill, Mr. F. E. - 10 0
Gueret, L. & H. Messrs. - 10 0
Hacquell Bros. - 10 6
Harrison Bros. and Moore, Messrs. - 10 6
*Hill, C. and Son, Messrs. 1 1 0
Hodge & Hill, Messrs. - 5 0
Hollier, Mr. H. (1818-2) 1 1 0
Hollyer & Co. Messrs. - 10 0
Insole, G. and Sons, Messrs. 1 1 0
Jessen, Mrs. G. N. - 5 0
Johnson, Mr. S. N. - 5 0
Jones, Mr. Edward O. - 5 0
Jones, E. & Co. - 5 0
Jones, Heard, and Ingram, Messrs. - 10 6
Jon's, Mrs. W. G. - 5 0
Jotham, D. and Son, Messrs. - 5 0
Krieger, Mr. M. - 5 0
Lee, Mr. R. - 5 0
Lucovich, Mr. A. T. 1 1 0
Martin & Marquand, Messrs. - 5 0
Marychurch, J. & Co. 1 1 0
Matthews, D. - 6 0
Midland Ry. Co. - 10 6
Morel Bros. & Co. Messrs. - 10 6
Nell, Dr. R. F. - 10 6
Nixon, Taylor, and Cory, Messrs. 1 1 0
Page & Co., Messrs. 1 1 0
Penn, Cooper and Edward, Messrs. - 5 0
Plain, Mr. T. - 10 6
Powell, Duffryn Coal Co. 1 1 0
Price, W. and Sons, Messrs. - 5 0
Pynnan, Watson, and Co. Messrs. - 10 0
Rees, Mr. D. - 5 0
Richards, Mr. D. - 5 0
*Riley, Mr. W. 2 0 0
Ronnefeldt, Mr. W. R. - 5 0
Rous, The Messrs. 1 1 0
Rundie, Mr. C. O. 1 1 0
Short and Dunn, Messrs. - 10 0
Spiller & Co. Messrs. Stallybrass, Bahmer, and Co. - 10 0
Stephens, Mr. T. H. - 10 6
Stowe, Mr. G. S. - 5 0
Strong, W. & R. H., Messrs. 1 1 0
Tapson, Mr. - 5 0
Telford, Wills and Co. Messrs. 1 1 0

BRANCHES—LIST OF ANNUAL SUBSCRIPTIONS AND DONATIONS. 125

	£.	s.	d.
Thomas and Griffiths, Messrs.	5	0	0
Thomas, Mr. A. R.	10	6	
Thomas, Mr. W.	2	0	
Thompson, Mr. T. R.	5	0	
Todd, Mr. R. R.	5	0	
Troedyrhew Coal Co.	10	6	
*Vellacott, Mr. H.	5	0	
Wain, Mr. R.	5	0	
Webb, Mr. G. F.	5	0	
Williams, Mr. T. J.	5	0	
Wilson, Mr. J. H.	10	6	
Windsor, Lord 2	2	0	
Worms and Josse, Messrs.	1	1	0
*Young, C.O. & Christie, Messrs.	1	1	0
Total	£55	9	0

Donations.
Sirina, Mr. M. 5 0
X. Y. Z. 5 0

Boxes:—			
Worms & Josse	4	9	8
Custom House	1	11	7
Williams, T. J.	1	17	3
Penarth Hotel	7	2	
Life-boat House	1	13	2
Boxes under 5s.	12	1	
Harri-on Bros. & Moore, Messrs.	15	0	
Hughes, Captain, s.s. <i>Walden</i>	2	4	1
Total Dons.	14	0	0
Total Subs.	65	9	0
	£79	9	0

PORHCRAWL BRANCH.

Patron—
C. R. M. TALBOT, Esq. M.P.

President—
*J. C. NICHOLL, Esq.

Honorary Secretary—
Rev. W. JONES.

Annual Subscriptions.
Baker, H. L. Esq. 10 6
*Brogden, James, Esq. 1 1 0
Byass & Co., Messrs. 2 2 0
R. B. 1 0 0
Clark, G. T. Esq. 1 0 0
Connop, Harry, Esq. (1882-3) 1 1 0
David, Edward, Esq. 10 6
*David, Evan, Esq. (1882-3) 1 12 6
Davis, Wm. Esq. 1 1 0
Dunraven, Earl (1881-2) 10 0
Dyke, T. J. Esq. 10 6
Edmondson, Rev. Thos. (1882-3) 1 1 0
Fothergill, Miss 2 0 0
Franklin, Col. 1 1 0
Gibbon, J. S. Esq. 1 1 0
Gordon, Rev. R. W. 1 0 0
Gwyn, Howel, Esq. 1 1 0
Hakett, Mrs. 10 6
Hamfray, J. R. Esq. Exors. of 1 1 0
Jenkins, Mrs. Blandy 1 0 0
Jenner Birt, F. A. Esq. 10 6
Jones, J. D. Esq. 5 0
*Knight, Rev. C. R. 1 1 0
Lewis, T. T. Esq. 10 0
Llewellyn, J. T. D. Esq. 1 1 0
*Llewellyn, R. W. Esq. (1882-3) 1 1 0
*Llewellyn, W. Esq. 1 0 0
Morris, G. Hyng, Esq. 1 0 0
*Morse, Lieut.-Col. (1882-3) 2 2 0

	£.	s.	d.
Nicholl, Lieut.-Col. C. R. H.	1	1	0
*Nicholl, J. C. Esq.	2	2	0
Olivant, Mrs.	1	1	0
Pritchard, W. Esq. (1882-3)	1	1	0
Stacey, Rev. C.	1	0	0
Fraherne, Major	1	1	0
*Trumblett, Mrs.	5	0	0
*Turberville, Lt.-Col. (1882-3)	2	2	0
Turberville, Mrs.	10	6	
*Wilson, Thos. Esq.	10	6	
Wimborne, Lord ...	5	5	0
Total	£53	13	0

Donations.
Box at Wyndham, Bridgend 6 0
Total **£53** | **19** | **0** |

SWANSEA BRANCH.

Honorary Secretary—
T. W. ISLAY YOUNG, Esq.

Annual Subscriptions.
Bath, Henry & Son. 5 5 0
*Capper, R. 1 1 0
Cory, T. 1 1 0
Cox, W. 10 6
Davidson, T. R. R. 10 6
Evans, J. M. 10 6
*Ford, Capt. 1 1 0
Forester, Mr. W. H. 10 6
Gilbertson, W. & Co. 1 1 0
*Gold, Mr. Charles. ... 1 1 0
Goodall, Mr. H. G. 10 6
Grenfell and Sons. ... 2 2 0
*Haynes, Mr. G. R. 10 6
*Horman-Fisher, Mr. S. H. 10 6
Hrid, Thomas. 1 1 0
James, Mr. F. 1 1 0
Jones, Jno. 1 1 0
Manger, E. O. 2 6
Mesnier & Co. 1 1 0
Michael, Mr. James. ... 10 6
*Morris, Sir J. A., Bt. ... 10 6
*Nettall, J. T. 10 6
Prevost & Letricheux ... 5 0
Richards, T. P. 1 1 0
Richardson, Mr. J. C. 1 1 0
Richardson and Co. ... 2 2 0
Sailors' Chapel, per Rev. E. J. Wolfe. ... 1 4 2
Thomas, J. D. 10 6
Trustees of Swansea Harbour 50 0 0
Tulloch, L. 10 6
*Vivian, Mr. H. H., M.P. 3 3 0
Vivian, Mr. W. G. 1 1 0
Vivian, Mrs. 1 1 0
Walter, J. 19 6
Williams, Mr. F. E. 10 6
Williams, Wm. 10 6
Wilson, C. T. 1 1 0
Total **£87** | **4** | **2** |

Gloucestershire. BRISTOL BRANCH.

Chairman—
M. WHIRWILL, Esq.

Honorary Secretary—
Mr. M. BRYAN.

Collector—
Mr. Z. JONES, 19 College Green.

Annual Subscriptions.
Bligh, Mrs. R. 1 1 0

Butterworth, McArthur & Co.	1	1	0
Daniel, Thos. & Sons	5	5	0
Edgar, Miss 1	0	0	
Edgar, Miss R.	1	0	0
Gell, Mrs.	2	2	0
Goodwyn, T. W. Esq. ...	1	1	0
Goody, Cripps, & Sons	1	1	0
Grace, J. and H.	10	6	
Hill, C. and Sons 1	1	0	
Hutchins, T. C.	10	6	
Justice, F. W.	10	0	
King, R. P. & W. P. ...	2	2	0
Miles, W. H.	1	1	0
Phillips, A. Esq.	1	1	0
Powell, W. & Sons 2	2	0	
Russell, Miss C. E.	10	6	
Russell, Rev. J. C.	5	0	
Strickland, N.	5	0	
Stroud, Rev. H.	1	0	0
Stackey and Co.	1	1	0
Terrell, W. and Sons ...	1	1	0
Thomas, C. J. & Bros. ...	1	1	0
Wansley, A.	1	1	0
Wedmore, T.	1	1	0
Whitwill, M.	2	2	0
Woodman, C.	10	6	
Wright, W.	1	1	0
Total	£33	7	6

Donations.
Bristol Marine Association 6 6 0
Society of Merchant Venturers 10 10 0
S.S. Juno, Capt. Star 3 2 8
Bristol Steam Navigation 10 6
Rees, Miss Alic 2 9 3
Hall, H. 7 0
Sums under 5s. 1 8 1
Total Dons. 24 13 6
Total Subs. 33 7 6
£58 1 0

CHELTENHAM BRANCH.

Hon. Secretary—
Captain G. E. HOBGSON.

Collector—
Mr. W. WITCHELL.

Annual Subscriptions.
Bell, W. E. Esq. 1 1 0
Rusfield M.s. 2 0 0
*Christian, Admiral ... 10 0
Debenham & Hewett, Messrs. 10 0
Evans, J. Bowle, Esq. ... 10 0
George, F. D. Esq. 10 0
Hawkins, Miss. 0 10 0
Henry, Miss E. 0 10 0
Hodgson, G. E. Esq. 10 0
Lloyd, Mrs. 2 2 0
Lloyd Mrs. Owen. 1 1 0
Martin & Co. Messrs. ... 10 0
Pitman, H. Esq. (the late) 0 10 0
Scarib, Mrs. 0 5 0
Selig, Mr. S. 0 10 0
Sharpe, W. Esq. 5 0
Shirer and Haddon, Messrs. 10 0
*Skillicorne, W. Nash, Esq. 1 0 0
Voile, Thomas, Esq. 1 0 0
Walker, I. Esq. 10 0
Williams, Miss. 1 1 0
Young, Capt. W. F. (the late) for 1881 0 10 0
Young, The Misses 0 10 0
Total **£16** | **5** | **0** |

Donations.
Collected in Box by A. Suffolk, Esq. 8 0
Ditto to Conservative Club, 7 0
Oratory at Severhampton Church, per Rev. H. Herbert ... 1 13 0
Total Dons. 2 8 0
Totals 16 5 0
Total **£18** 13 0

Hampshire.

PORTSMOUTH AND HAYLING ISLAND BRANCH.

Honorary Secretary—
WM. PAYNE, Esq.
Nat. Prov. Bank of England, Portsmouth.

Annual Subscriptions.

Allnut, Mr.	5	0	
Austen, Rev. G.	10	0	
Bacon, Francis, Esq.	1	0	
Bailey, T. Esq.	10	0	
Baker, Ed. Esq.	10	0	
*Baly, A. O. Esq.	10	0	
*Baly, Rev. J. A.	1	1	0
Blake, Rev. J. S.	1	1	0
Bramley, R. J. Esq. ...	1	0	0
Cartier, B. W. Esq. ...	1	0	0
Chads, Adml.	5	0	0
Chambers, W. G. Esq. ...	10	0	0
*Cudlipp, Arthur, Esq.	10	6	
Delma, H. P. Esq.	1	0	0
*Dunlop, Commander R.N.	5	0	
Emanuel, A. L. Esq. ...	5	0	
Emanuel, Alderman, J.P.	10	0	
Ford, R. W.	5	0	
Foster, H. P. Esq.	10	6	
Galt, Col. Edwin	5	0	
Garnett, Wm. Esq.	10	6	
Grant & Co. Messrs. ...	1	1	0
Hackman, L. L. Esq. ...	1	1	0
Hall, Mrs.	1	0	0
*Hail, J. S. Esq.	1	0	0
Hardy, Rev. C.	10	0	
Harrison, Miss H. W. ...	10	0	
Heron, M.L., of Dundee, per Stokes & Co.	1	0	0
Holdsforth, Miss.	10	6	
Key, Capt.	10	6	
Key, Comm. & Mrs. ...	1	0	0
*Knight, J. P. Esq. ...	1	1	0
*Knight, S. P. Esq. ...	10	0	
Knighthon, Sir W. W. Bart.	1	0	0
Jeanes, Mrs.	1	1	0
Johnson, Maj.-Gen.S. ...	10	0	
Lancaster, Capt. H. J. ...	5	0	
Langdale, Rev. O. A. ...	5	0	
Langdale, G. A.	5	0	
*Lethbridge, Admlral ...	5	0	
Lush, J. Esq.	10	0	
Marvin, Mrs. S. A.	5	0	
*Miller Gordon, Esq. ...	10	6	
Moore, Miss M. S.	1	1	0
Murray, Mrs. E. D. ...	10	6	
Pares, John, Esq.	1	1	0
*Payne, W.	5	0	
*Pell, Capt. M. S. L., R.N.	10	6	
Pike, Spicer, & Co., Messrs.	1	1	0
Power, F. Esq.	5	0	

BRANCHES—LIST OF ANNUAL SUBSCRIPTIONS AND DONATIONS. 127

	£.	s.	d.
Jackson, Mrs.....	1	1	0
Latham, Mr.....	5	0	
Marriott, E. T.....	1	1	0
McNally, Mr.....	5	0	
Moyes, John, Esq.....	1	1	0
North, Hon. H. F.....	1	1	0
Poore, E.....	5	0	
Walter, O. C. Esq.....	10	0	
Wyatt, W. Esq.....	1	1	0
Total.....	18	12	0
<i>Donations.</i>			
Miss Hopkins.....	1	0	6
Contribution Boxes &c.....	7	8	9
£27 1 3			

DOVER BRANCH.

<i>Chairman—</i> Major SCOURT.			
<i>Honorary Secretary—</i> Lieut.-Gen. BRUCE, C.B.			
<i>Annual Subscriptions.</i>			
Ayers, Mr.....	5	0	
Back, Mr.....	5	0	
Boodle, W. C. Esq.....	1	0	0
Boyle, the Ladies.....	5	0	
Bradley Brothers.....	10	0	
*Bruce, Capt. Sir T., R.N.....	5	0	
*Bruce, General, C.B.....	10	0	
Causton, Capt.....	10	0	
Court, P. S. Esq.....	10	0	
Cow, Capt.....	5	0	
Crosby, Mrs.....	1	0	0
Dickson, R. Esq.....	1	0	0
Finnis, S. Esq.....	5	0	
Flashman, Mr.....	5	0	
Frith, Major.....	2	2	0
Graves.....	5	0	
Goren, James, Esq.....	1	1	0
Goren, James N. Esq.....	1	1	0
Hayward..... Esq.....	5	0	
Heath, General.....	1	0	0
Hills, Mr.....	5	0	
Hyde, Mrs. (the late).....	5	0	
Igglesden, Mr. B. A.....	5	0	
Joyce, Messrs.....	5	0	
Knocker, W. Esq.....	1	1	0
*Marsh, Cullen.....	5	0	
Maxwell, General.....	1	1	0
Mesham, Mrs.....	1	0	0
Morgan, E. D. Esq.....	1	0	0
Ramsbottom, J. K. Esq.....	1	0	0
Rose, Miss.....	1	1	0
Schuyott, N. Esq.....	5	0	
*Scott, Major.....	1	1	0
Sisco, Mr.....	5	0	
Stilwell, J. Esq.....	5	0	
Stuart, G. Esq.....	1	1	0
Sutton, Dr.....	1	1	0
Worsfold..... Esq.....	5	0	
Weston, Mr. L.....	10	6	
Wilson, Mr.....	5	0	
Wisenden, Miss E. S.....	10	0	
Sums under 5s.....	12	6	
Total.....	£25	19	6
<i>Donations.</i>			
Mitchell, F. H. Esq.....	10	10	0
Watlington, Perry, Esq.....	5	5	0
Collecting Boxes.....	14	17	4
Total Dons.....	30	12	4
Total Subs.....	25	19	6
£56 11 10			

GOODWIN SANDS AND DOWNS BRANCH.

Patrons—
The Right Hon. the EARL GRANVILLE, K.G., P.C.
SIR WALTER JAMES, BART.
Chairman—
Capt. G. DOUGLAS, R.N.
Treasurer and Hon. Sec—
Rev. T. S. TREANOR.
Local Hon. Secretary at Kings-downe—
Mr. W. BAILEY.

NORTH DEAL LIFE-BOAT.
Annual Subscriptions.

	£.	s.	d.
Bernard, Rev.....	-	5	0
Boys, Capt. H., R.N.....	1	1	0
Bray, Miss.....	1	0	0
Chennell, F. A. Esq.....	10	6	
Cinque Ports Pilots, 27 Subs. under 5s.	3	7	6
Cullen & Son, Messrs.....	5	0	
Darby, Mrs.....	5	0	
Edwards, J. B. Esq.....	10	6	
Eilbeck, The Misses.....	1	1	0
Evans, R. P. Esq.....	1	1	0
Frost Bros., Messrs.....	10	0	
Green, General.....	1	1	0
*Griffith, Rev. T. Ll.....	10	6	
Hammond and Co. Messrs G.....	10	6	
Harvey, J. J. Esq.....	10	6	
Henderson, J. Esq.....	10	6	
Hilton, Dr.....	1	1	0
Iggulden, John, Esq.....	1	0	0
James Sir W. C. Bart.....	3	2	0
Johnson, Mrs.....	1	0	0
Lampough, H. Esq.....	10	0	
McGrath, Lady.....	1	0	0
Morris, Mrs.....	1	1	0
*Nethersole, Jno. Esq.....	10	6	
Pittock, Mr. W.....	10	6	
Rooke, T. Esq.....	10	6	
Sydney, Earl.....	1	1	0
Seward, N. Esq.....	10	0	
*Treasor. Rev. T. S.....	10	0	
Watt, Miss.....	5	0	
Weshorpe, Theo- philus.....	1	1	0
Wood, H. D. Esq.....	10	0	
£26 12 6			

Donations.
Bateman, Mrs..... - 5 0
Widow's Mite, per
Mr. Langley..... - 1 0
Deal collecting boxes 9 5 9
Hicks, G. M. Esq..... 10 10 0
Do.(1878-82)£52 10s.

Total Dons.....20 1 9
Total Subs.....26 12 6
£46 14 3

WALMER LIFE-BOAT.
Annual Subscriptions.
Granville, Earl, K.G., P.C.
Boys, Mrs..... 5 0 0
Brassey, H. Esq. M.P. 5 0 0
Brooke, Miss..... 15 0 0
*Bushe, Capt. R.N..... 10 0 0
Cannon, Mrs..... 1 0 0
Cullen & Sons, Messrs..... 5 0 0
*Davey, Dr..... 10 0 0
Douglas, Capt. J..... 10 0 0
*Douglas, Capt. G..... 5 0 0
Ellston, Rev. E..... 1 1 0
Fisher, Miss..... 5 0 0
Green, A. Esq..... 1 0 0
*Griffith, Rev. T. Ll..... 10 0 0
Hales, Miss..... 5 0 0
Harvey, Vice-Adm..... 1 0 0

Harvey, Mrs.....	10	0	
Hilton, Rev. G. S.....	1	0	0
James, Sir W. Bart.....	2	0	0
Kenrick, Mrs.....	1	0	0
*Leith, H. Esq.....	1	0	0
Monins, Mrs.....	5	0	
Nethersole, Mr. W.....	5	0	
Smith, Arthur, Esq.....	1	0	0
Thompson and Sons, Messrs.....	1	0	0
Walmer Collecting Box.....	1	3	8
Watt, Miss.....	5	0	
Woodruffe, Mrs.....	1	0	0
Total.....	29	9	8
North Deal.....	46	13	6
£76 3 2			

HYPHE, SANDGATE, AND FOLKESTONE BRANCH.

President—
The Rt. Hon. Lord PELHAM.
Chairman—
Capt. SARCAUNT, R.N.
Folkestone.
Treasurer—
J. R. DAVY, Esq.,
N. P. Bank, Folkestone.

Honorary Secretary—
GEORGE WILKS, Esq., Hythe.

Annual Subscriptions.
Ashdown, Mr. Ed..... - 5 0
Barton, Mrs..... - 5 0
Brockman, F. Esq..... - 1 1 0
Burden, Mrs..... - 5 0
Cobb, Mr. J. V..... - 5 0
Davy, J. R. Esq..... - 5 0
Dawson, Mrs..... - 10 0
Deedes, Major..... - 5 0
Deedes, William, Esq..... 1 0 0
*Du Boulay, J. Esq..... - 10 6
Evans, Rev..... - 10 6
*Fitness, John, Esq..... - 10 6
Hankey, General..... - 1 0 0
Harrison, W.G.S. Esq..... - 10 6
Hart, Miss..... - 5 0
Holden, Mr..... - 10 0
*Jenkins, Rev. Canon..... - 10 6
*Kingsford, K. Esq..... - 10 6
Kirkpatrick, Major..... - 10 6
Lonsdale, J. Esq..... - 10 6
*Mackeson, H. B. Esq..... - 10 6
Nelson, John, Esq..... - 10 6
Ovenden, Mr. George..... - 5 0
Oxenden, Mrs..... - 1 1 0
*Pledge, W. Esq..... - 10 6
Rigden, Mr. B..... - 10 6
Russell, G. Esq..... - 10 0
Sandilands, E. Esq..... - 10 6
*Sherwood, John, Esq..... - 10 6
Shipwash, Mr. E..... - 5 0
Sidle, Mrs..... - 10 0
Thompson, Robert,
Esq..... - 5 0
*Toiputi, J. B. Esq..... - 10 6
Tournay, Tournay
W. Esq..... - 1 1 0
Walton, Mr. E. C..... - 5 0
Ward, Rev. V..... - 5 0
Watkin, Sir E., M.P..... - 10 6
Wildash, Dr..... - 10 6
Wilks, George, Esq..... - 10 6
Williamson, Rev..... - 10 6
Wilson, Mr. William..... - 5 0
Sums under 5s..... 2 10 0

Total.....£22 17 6

Donations.
Pillar Boxes..... 20 13 3
£43 10 9

KINGSGATE BRANCH.

Honorary Secretary—
Major WEBB.
Assistant Secretary—
Mr. J. J. FRANCIS.

Annual Subscriptions.

Alexander, C. Esq.....	2	2	0
Cotton, Mrs.....	1	0	0
Edmeades, Rev. W.H.....	1	1	0
*Fearon, Capt.....	1	0	0
*Hannam, G. E. Esq.....	10	6	
Harris, T. N. Esq.....	1	1	0
Hodgson, Rev. J. G.....	1	1	0
*Isacke, Capt. H.C.S.....	1	0	0
Levy, Jonas, Esq.....	5	6	0
Metcalfe, Col. C.B.....	1	1	0
Rammell, Mr. G.....	5	6	
*Webb, Major.....	10	0	
Whish, G. T. Esq.....	1	1	0
Whish, Mrs. G. T.....	1	1	0
Whitehead, Rev. A.....	10	0	
Total.....	£18	8	0

Donations.
Pillar & Boat-house
Boxes..... 5 6 3
£23 14 3

LYDD DUNGENSES BRANCH.

Chairman—
ALURED DENNE, Esq., D.L.

Honorary Secretary—
E. T. BASS, Esq., J.P.

Annual Subscriptions.
Bartholomew, Mrs.
William..... 1 1 0
*Bass, C. E. Esq..... - 10 0
*Bass, E. T. Esq..... - 10 0
Bevan, Rd. Esq..... - 10 0
*Blacklocks, Mr. J..... - 5 0
*Blacklocks, Mr. Wm..... - 10 0
Burra, James, Esq..... - 10 0
Burton, Rev. Chau-
cellor..... 2 0 0
Cooper, Mr. R..... - 10 0
*Denne, Alured, Esq..... - 10 0
Denne, Col. R.H.A. - 1 0 0
*Finn, Mr. Arthur..... - 10 0
*Finn, Mr. Edwin..... - 10 0
Finn, Mrs. George..... - 5 0
Finn, Miss Mary..... - 5 0
*Gell, Rev. E..... - 10 6
Howe, Rev. J..... - 10 0
Hutchings, Lewis..... - 10 0
Perks, R. Esq..... - 1 1 0
Prescott, Mr. Wm..... - 5 0
*Procter, J. C. Esq..... - 10 0
Rayner, S..... - 10 0
Samson, Mr. W..... - 10 0
Selmes, Messrs..... - 10 0
White, Mrs. C..... - 5 0
Wingate, Rev. W. G. Ll..... - 10 0
Wood, Field, & Han-
bury, Messrs..... 1 0 0
Young, E. D., Esq..... - 10 0
R.N..... - 2 6
Sums under 5s..... - 2 6

Total.....£16 10 6

MARGATE BRANCH.

Table with columns for names, amounts in £, s., d. Includes Chairmen (J. T. Friend, W. Crawford), Honorary Secretaries, Annual Subscriptions, and Contents of Boxes.

Table titled 'Donations' listing names and amounts for Margate Branch.

NEW ROMNEY BRANCH.

Table for New Romney Branch including Chairmen (Henry Cobb), Honorary Secretary (John Humphrey), and Annual Subscriptions.

PORT OF ROCHESTER BRANCH.

Table for Port of Rochester Branch including President (His Worship the Mayor), Honorary Secretary (Mr. J. H. Crookford), Annual Subscriptions, and Contents of Boxes.

Table titled 'Contents of Boxes' listing items and amounts for Margate Branch.

Lancashire. BLACKBURN BRANCH.

Table for Blackburn Branch including President (His Worship the Mayor), Treasurer (J. S. Pollitt), Honorary Secretary (Joseph Barreley), and Annual Subscriptions.

BLACKPOOL BRANCH.

Table for Blackpool Branch including Chairmen (Henry Hall), Treasurer (R. Handley), Honorary Secretary (A. M. Verner), and Annual Subscriptions.

BOLTON BRANCH.

Table for Bolton Branch including Chairmen (E. G. Harwood), Honorary Secretary (Thomas H. Winder), Annual Subscriptions, and Contents of Boxes.

£. s. d.		£. s. d.		£. s. d.		£. s. d.	
Brierley, Wood, and Co., Messrs.	2 0 0	Gardner, Major	1 1 0	Ihlers & Bell, Messrs.	1 1 0	National S.S. Co.	
*Briggs, Capt. W. S.	1 1 0	Gardner, Henry, Esq.	1 1 0	Inman Steam Ship Co. Limited	1 1 0	Limited Messrs.	1 1 0
Bristow, J. Esq.	1 1 0	Gardner, Joseph, Esq.	5 0 0	Irven, Geo. S. Esq.	1 1 0	Neilson, Mrs.	1 1 0
British and African Steam Ship Co.	2 2 0	Gardner, W. R., Esq.	5 0 0	*Ismay, Imrie, & Co.	2 2 0	Newgass, B. Esq.	1 0 0
British and Eastern Shipping Company, Limited	2 2 0	Gardner, R. C., Esq.	- 10 6	Messrs.	2 2 0	Nicholson, R. & Sons, Messrs.	1 1 0
Brocklehurst, G. W. Esq.	5 0 0	(the late)	- 10 6	Jack & Co. James, Messrs.	2 2 0	Nickels, J. T. & Co., Messrs.	1 1 0
Brocklehurst, H. Esq.	1 1 0	Gardner, Rev. J. C.	1 1 0	Jackson, Jos. Esq.	1 1 0	Nicol, William, Esq.	1 1 0
Brocklehurst, R. Esq.	1 1 0	Garnett, Alex., Esq.	1 1 0	Jackson, R. Esq.	1 1 0	North, Fred., Esq.	1 1 0
Brocklehurst, S. Esq.	1 1 0	Garratt, John, Esq.	- 10 0	Jacob, W. T. Esq.	1 1 0	Pappacalo, D. Esq.	1 1 0
Bromham, W. Esq.	1 1 0	Gaudy, Captain M.	1 1 0	Jardine, D. Esq.	2 2 0	Papayanni and Co. Messrs.	2 2 0
Browne, A. F. Esq.	- 10 0	Geddes, Wm & Sons, Messrs.	1 1 0	Japp & Kirby, Messrs.	1 1 0	Parker, A. T. Esq.	1 1 0
Bulley, S. M. & Sons, Messrs.	1 1 0	(see, Thomas, Esq.)	1 1 0	J. K. C.	1 1 0	Parker, Mrs. Ellen	1 1 0
Butley, S. M., Esq.	1 1 0	Given, John, Esq.	1 0 0	Johnson, F. Esq.	1 1 0	Parrr and Rae, Messrs.	2 2 0
Butterworth, Miss J.	1 1 0	Gllespie & Co. Messrs.	1 1 0	Johnson, R. C. Esq.	1 1 0	Peel, John, & Co. Messrs.	1 1 0
Calvert, Capt.	1 1 0	Gladstone, Robt. Esq.	1 1 0	Johnston, W. and Co. Messrs.	5 0 0	*Peers, James, Esq.	1 1 0
Cameron, John Esq., M.D.	1 1 0	Glynn, Jno. & Sons, Messrs.	1 1 0	Jones, Edw. W. Esq.	1 1 0	Phillips, Son, and Nephew, Messrs.	1 1 0
Cannington, John and Co. Messrs.	1 1 0	Goffey, Thomas, Esq.	1 1 0	Jones, Wm. Esq.	- 5 0	Pooley, Mrs. Henry	1 1 0
Carter, Tyrer, and Parker, Messrs.	1 1 0	Goodlass, Wall, and Co. Messrs.	1 1 0	Jones, Thos. Esq.	- 10 6	Powell, Joseph, Grace and Frank, Messrs.	- 10 0
Cartier, Wm. Esq.	1 1 0	Gordon, John, Esq.	1 1 0	Jones, W. H. Esq.	1 1 0	Porter, Wm. & Co. Messrs.	1 1 0
Chadburn, W. Esq.	1 1 0	Gordon, James, Esq.	1 1 0	Just, Wm. Esq.	- 10 6	Preston, R. P. Esq.	1 1 0
Chamberlain, G. Esq.	1 1 0	Gossage, Fred. H., Esq.	2 2 0	*Kent, Alfred, Esq.	- 10 0	Preston, R. W. & Co. Messrs.	1 1 0
*Chambres, Major Wm. J. P.	2 2 0	Graham, Henry, Mrs.	2 2 0	Kerferd, G. B. Esq.	1 1 0	Quiggin, John M. Esq.	- 10 6
Cliff, Edward, Esq.	1 1 0	Greenshields, T. E. Esq.	1 1 0	Killey, Wm. and Co., Messrs.	1 1 0	Radclyffe, R. Esq.	- 10 0
Cliff, William, Esq.	3 3 0	Grey, Edward, Esq.	1 1 0	King, W. Esq.	1 1 0	Radi, Bros. Messrs.	2 2 0
Coltart, E. Esq.	1 1 0	Groves, Charles, Esq.	1 1 0	Knox, Wm. Esq.	1 1 0	Ralli, C. M. Esq.	2 2 0
Comber, Thos. Esq.	1 1 0	Gruiting & Co. Messrs.	2 2 0	Kurtz, A. G. Esq.	1 1 0	Rathbone, Benson, Esq.	2 2 0
Comberbach, W. S. Esq.	- 10 0	Gunson, Brown & Co. Messrs.	1 1 0	Kurtz, Charles & Sons, Messrs.	2 2 0	Rathbone Brothers and Co. Messrs.	7 7 0
Cookson, Edward H., Esq.	1 1 0	Habershon, E. Esq.	1 1 0	Laird, M'Gregor, Esq.	1 1 0	Rathbone, Martin and Co. Messrs.	1 1 0
Cookson, T. W. Esq.	1 1 0	Hadden and Wainwright, Messrs.	2 2 0	Laird Bros. Messrs.	2 2 0	Rathbone, Wm. Esq. M.P.	2 2 0
Cope, Bros. and Co. Messrs.	1 1 0	*Hamilton, John L. C. Esq.	1 1 0	Lampont and Holt, Messrs.	3 3 0	Ravenscroft, W. Esq.	1 1 0
Cotesworth, Lyne and Co. Messrs.	1 1 0	Hardwick, Alfred, Esq.	- 10 6	Langton, Chas. Esq.	1 1 0	Rawdon, J. F. Esq.	- 10 6
Coubrough, H. Esq.	1 1 0	Harding, Thos. Esq.	2 2 0	Lear, John, Esq.	1 1 0	Rayner, E. W. Esq.	1 1 0
*Coulbourne, E. W. Esq.	1 1 0	Hargreaves, Jno. Esq.	2 2 0	Leitch, Jas. & Co. Messrs.	1 1 0	Rayner, M. Esq.	1 1 0
Cox, G. R. Esq.	2 2 0	Harris, G. Esq.	- 10 0	Lister, Jas. Esq.	1 1 0	Rayner, Mrs. Lloyd	1 1 0
Cox, Henry, Esq.	1 1 0	Harrison, E. H. Esq.	1 1 0	Litherland, W. Esq. (the late)	1 1 0	Rayner, Rod., Esq.	2 2 0
*Cox, James, Esq.	2 2 0	Harrison, Fredk. J. Esq.	1 1 0	Little, James, Esq.	1 1 0	Reade, T. Mellard, Esq.	1 1 0
Crooks, Mrs.	1 1 0	Harrison, Gilbert and Bros. Messrs.	1 1 0	Little, William, Esq.	1 1 0	Rew, John, Mrs.	1 0 0
Crosbie, Lt.-Col. C. E.	1 1 0	Harrison, T. and Co. Messrs.	1 1 0	Littledale, H. Esq.	2 2 0	Richardson, Miss E.	- 10 0
Crosby, R. Esq.	- 10 0	Harrison, Thos., Esq.	2 2 0	Liverpool Steam Tug Co. Messrs. The	2 2 0	Rigby, Alderman T.	1 1 0
Crosfield, C. J. Esq.	1 1 0	Heap, Richard A. Esq.	1 0 0	Lloyd, Mrs. M.	- 10 0	Rigby, Samuel, Esq.	2 2 0
Crosfield, J. D. Esq.	1 1 0	Heap, R. R. Esq.	1 0 0	Lockett, C. H. Esq.	1 1 0	Rigg, Morden, Esq.	1 1 0
Crosfield, Wm. Esq.	1 1 0	Henderson, F., Esq.	1 1 0	Lowndes, R. Esq.	1 1 0	Rimmer, Miss A.	- 10 6
Cunningham, H. Esq.	1 1 0	Henderson, Capt. H.	1 1 0	Lunt, W. J. Esq.	- 5 0	Roberts, J. Esq.	- 5 0
Currey, Major Henry	1 0 0	Henderson, W. G. Esq.	1 1 0	Macalister, Mrs. Annie	3 3 0	Robertson, Alex. Esq.	1 1 0
Currey, John, Esq.	1 1 0	Herschell, Adolph, Esq.	1 1 0	Macalister, Robert, Esq.	2 2 0	Robertson, Alex. Esq. & Co. Messrs.	1 1 0
Davies, Ellis & Co. Messrs.	1 1 0	Heywood Sons and Co. Messrs. A.	1 1 0	Macfie and Sons, Messrs.	2 2 0	Robertson, Crowe & Co. Messrs.	1 1 0
Derby, Right Hon. The Earl of.	2 2 0	Higginbottom, Miss E. A.	1 1 0	Macgregor, A. Esq.	1 1 0	Robinson, Isaac W. Esq.	1 1 0
Dixon, W. T. Esq. (the late)	1 1 0	Higgins, Wm. Esq.	1 1 0	Macgregor, Alex. Esq.	2 2 0	Robinson, Robt. Esq.	1 1 0
Dobell & Co. Messrs. A.	1 1 0	Hind, Miss A.	- 5 0	Macintyre, L. H. & Co. Messrs.	1 1 0	Robinson, W. L. Esq.	1 1 0
Driclisma, Mrs.	1 1 0	Hind, Wm. Esq. (the late)	5 0 0	Macrae, G. G. Esq.	2 2 0	Rodgers, Robert, and Co. Messrs.	2 2 0
Ducker, H. Esq.	- 5 0	Hind, John H., Esq.	1 1 0	Maddock, F. T. Esq.	1 1 0	Rodger, W. Esq.	1 0 0
Duranty, Widow & Son, Messrs.	1 1 0	Holder, Thomas, Esq.	1 1 0	Maddock, Mrs.	1 1 0	Rolls, Thomas C. Esq.	1 1 0
Earles and King, Messrs.	1 1 0	Holland, Mrs.	2 2 0	Mahler, John, Esq.	1 0 0	Rome, Wm. Esq.	1 1 0
Eccles, E. S., Esq.	1 1 0	Holland, W. G. Esq.	- 10 6	Maples, A. Esq.	- 10 6	Ronald Sons & Co. Messrs.	5 5 0
Eden, Dr. Thos.	1 1 0	Hollinshead, Miss	1 1 0	Marquis, Robt. Esq.	1 1 0	Rosenheim, L. and Sons, Messrs.	1 1 0
Elder, Dempster, and Co. Messrs.	1 1 0	Holt, G. A. Esq.	1 1 0	Mariott, Wm. Esq.	1 1 0	Salvago & Ralli, Messrs.	1 1 0
Elkington and Co. Messrs.	1 1 0	Holt, Miss	2 2 0	Marshall, W. B. Esq.	1 1 0	Saunders, Needham, and Co. Messrs.	2 0 0
Ellery, Mrs.	2 2 0	Hope, S. T. Esq.	1 1 0	Martin, Jas. T. Esq.	- 10 6	Scholefield, J. W. Esq.	1 1 0
Elmslie, L. C., Esq.	- 5 0	Hope, William, Esq.	1 1 0	Mason, E. G. Esq.	- 10 6	Schroeder and Co. Messrs.	2 2 0
Esbridge, R. A. Esq.	2 2 0	Hornby, H. B. Esq.	- 10 6	Massey, Fredk. Esq.	1 1 0	Shallcross, T. R. Esq.	1 1 0
Evans, G. Eyre, Esq.	- 1 0	Hornby, Rev. Thos.	1 1 0	Matheson, Thos., Esq.	2 2 0	Silberbach, J. H.	- 10 0
Evans, Miss M.	- 10 0	Horsfall, Charles E., Esq.	1 1 0	Mellor, J. H. Esq.	1 1 0	Slater, J. Esq.	1 1 0
Fairhurst, J. Esq.	1 0 0	Horsfall, H. Douglas, Esq.	2 2 0	Meyer, F. A. Esq.	1 1 0	Smart, David, Esq.	2 2 0
Fallows, John, Esq.	1 1 0	Houghton, E. P. Esq.	- 10 0	Mill, James, Esq.	1 1 0	Smith, A. M. and Co. Messrs.	1 1 0
Fletcher, G. H. & Co. Messrs.	1 1 0	Houghton, No. Esq.	1 1 0	Minoprio, F. C. A. Esq.	1 1 0	Smith, Elisha, Esq.	1 1 0
Fogg, N. B. Esq.	1 1 0	Houghton, Miss E. D.	1 0 0	Moffatt, Bros. Messrs.	1 1 0	Smith, James, Esq.	1 1 0
Fowell, Rev. R. D.	- 10 6	Houghton, Miss Jane	1 1 0	Molyneux, Capt. A. M.	1 1 0	Smith, J. Berkeley, Esq.	1 1 0
Friend, E. C. and Co. Messrs.	1 1 0	Houlder Brothers & Co. Messrs.	2 2 0	Moore, Dr.	1 1 0		
Gamble, D. Esq.	1 0 0	Hughes, John W. Esq.	1 1 0	Morgan, Walter, Esq.	1 1 0		
		Hurworth, R. Esq.	- 5 0	*Moss-Edwards, Sir Thos. Bart.	5 0 0		
		Hutchinson, Miss	- 10 0	Moss, Thomas Esq.	1 1 0		
		Hutchinson, W. H. Esq.	- 10 6	Moss, Rev. J. Miles.	1 1 0		
				Mounsey, E. Esq.	1 1 0		
				Muspratt, E. K. Esq.	1 1 0		

BRANCHES—LIST OF ANNUAL SUBSCRIPTIONS AND DONATIONS. 131

£.	s.	d.	£.	s.	d.		
Smith, Robert, Esq.	2	2	0	Wylie, E. Esq. (the late)	1	0	0
Smith, Samuel, Esq. M.P.	5	0	0	Yates, E. W. & Co. Messrs.	1	1	0
Smith, Samuel, Esq.	2	0	0	Total£494 11 0			
Smith, Ross, T. & Co. Messrs.	2	2	0	<i>Donations.</i>			
Sparrow, A. and Co. Messrs.	1	0	0	Badger, Jos R. Esq.	1	1	0
Spoonley, S. Junr. Esq.	1	1	0	Bates, Edward & Sons, Messrs.	10	0	0
Springmann, E. Esq.	10	6	0	Charlton, Isaac, Esq.	1	1	0
Stanistreet, G. Esq.	1	0	0	Drury, Captain	5	0	0
Steel, James, Esq.	1	1	0	E. P.	1	0	0
Stevenson, Geo. Esq.	2	2	0	Evans, Thos, Esq.	5	0	0
Stevenson, John, Esq.	1	1	0	Gostenhofer, C. T. Esq.	5	0	0
Stuart & Co. D. G. Messrs.	2	2	0	Hadderall, J. Esq.	5	0	0
Swire, John, & Sons, Messrs.	2	2	0	Hamilton, Fraser & Co. Messrs.	2	2	0
Taylor, Cameron, and Co. Messrs.	2	2	0	Jones, E. Stewart, Esq.	2	0	0
Taylor, Chas. Esq.	1	1	0	M. F. B. Miss	1	0	0
Tatley, T. W. Esq.	1	1	0	Maxwell, William, Esq.	5	0	0
Thomas and Cook, Messrs.	1	1	0	Maxwell, Wellwood, Esq.	10	0	0
Thompson, J.W. Esq.	1	1	0	Molyneux, Capt. W. H., R.N.	2	2	0
Thomson, T. Esq.	1	1	0	Paterson, McCully & Co., Messrs.	1	1	0
Thornwall, E. J. Esq.	1	1	0	Shipley, H. D. ship Homeward Whist, Henderson Bros.	3	4	0
Threlfall, the late J. M., Trustees of, Flinnis, T. Sutton, Esq.	2	2	0	Wheatley, R. Esq.	1	0	0
*Tipton, R. S. & Son, Messrs.	1	1	0	<i>Box List.</i>			
Tomlinson, Hodgetts and Co. Messrs.	1	1	0	Alexandra Hotel	1	14	3
Tory, Mrs. E.	1	1	0	Batham, Miss	1	0	0
Travis and Wilde, Messrs.	1	1	0	Birkenhead Railway Station Refreshment Room	2	6	2
Turner, Alfred, Esq.	2	2	0	Hanson, Mr. Thos.	11	1	0
Turner, John, Esq.	1	1	0	Mersey Canoe Club, per W. S. Holden, Esq.	7	2	0
Urmson, Thos. Esq.	1	1	0	New Brighton Landing Stage	2	9	4
Wainwright, Rowland & Co. Messrs.	2	2	0	New Brighton Ferry Hotel	17	6	0
Walker, A. and Co. Messrs.	2	2	0	Promenade Pier	17	0	0
Walker, Horace, Esq.	2	2	0	Union Hotel	16	0	0
Walker, Parker and Co. Messrs.	2	2	0	Williams, Miss	13	8	0
Wall, F. Esq.	10	6	0	Woodside Ferry	1	1	9
Walsh, R. J. Esq.	1	1	0	Sums under 5s.	13	8	0
Waterhouse, Miss M. E.	1	1	0	Total Dons ... 51 3 7			
Watmough, Mrs. (the late)	1	1	0	Total Subs. ...£494 11 0			
Watson, R. B. Esq.	1	1	0	£545 14 7			
Watson, Hy. Esq.	2	2	0	LYTHAM BRANCH.			
Webster, Jas. Esq.	1	1	0	President—			
Weightman, W. H. Esq.	1	1	0	Chairman—			
West, Montague, Esq.	1	1	0	Rev. H. B. HAWKINS—			
West India and Pacific Steam Navigation Co.	2	2	0	Honorary Secretary—			
White, Alex. & Sons, Messrs.	1	1	0	Mr. JOHN EDMONDSON.			
White, Forman and Co. Messrs.	1	1	0	<i>Annual Subscriptions.</i>			
Wilkinson, E. W. Esq.	10	0	0	*Banister, Capt.	10	0	0
Wilkinson, Thomas Esq.	1	1	0	Clifton, Lady E. C.	3	3	0
Williamson, Samuel, Esq.	10	6	0	Cockerft, Miss	10	6	0
Williams & Powell, Messrs.	1	1	0	*Cunliffe, Major	1	1	0
Williams, J. W. and Son, Messrs.	10	6	0	Dannett, Miss, Cheltenham	1	1	0
Williamson, Milligan & Co. Messrs.	1	1	0	Fair, Thomas, Esq.	1	1	0
Willis, M. M. Esq.	1	1	0	Fisher, Dr.	10	6	0
Wood, Henry, & Co. Messrs.	1	1	0	Harrison, Miss	1	0	0
Woods, William, Esq.	1	0	0	*Hawkins, Rev. H. B.	1	0	0
Wrenn, J. & Co. Messrs.	1	1	0	Hewitt, Miss	1	0	0
Woodward, Ernest T., Esq.	1	1	0	Hewitt, Miss E.	1	0	0
Wright, A. T. Esq.	1	1	0	*Hinchman, Major	1	0	0
Wright, Crossley & Co. Messrs.	1	1	0	Howarth, Miss	1	0	0
Wright, Thomas E. Esq.	10	0	0				

£.	s.	d.	£.	s.	d.		
Knowles, Mrs.	10	6		Charlesworth, T. L.	1	1	0
Richardson, John, Esq.	10	6		Clayton, G. E.	2	6	0
Southward, Thomas, Esq.	1	0	0	Clegg, Mrs. Thos. Sale	5	0	0
Threlfall, Mrs.	1	1	0	Cohen, Ferdinand	1	1	0
*Wartenberg, S. Esq.	1	1	0	Coupland St. Junior Mission Society	7	8	0
*Wilding, J.W. Esq.	10	0	0	Crabtree, H. & Sons	3	0	0
Total£18 12 0			Total£18 12 0				
<i>Donations.</i>							
Coll. at Encampment of 3rd Adm. Batt. Lanc. R. V., Col. Dugdale (1881)	7	18	6	Dewhurst, G. and R.	1	1	0
Hewitt, the Misses, 100 Offertory at the Harvest Festival at Lytham Parish Church, by Rev. H. B. Hawkins (1880)	38	16	1	De Trafford Sir H. Bt.	5	0	0
Pillar Boxes	5	15	3	Diggles, Thos.	10	6	0
Total Dons ...152 9 10			Total Subs. ...18 12 0				
£171 1 10							
MANCHESTER BRANCH.							
Honorary Treasurers—							
ROBERT WHITWORTH, Esq. (Messrs. B. WHITWORTH Bros.) S. L. HELM, Esq.							
Honorary Secretaries—							
REV. E. HEWLETT, M.A. J. COBBETT, Esq.							
<i>Annual Subscriptions.</i>							
Adamson, J. & Co.	1	1	0	Haslam, Mrs. Jas.	1	0	0
Agelasto, A. and Co.	1	0	0	Hayes, Henry	1	1	0
Agnew, J. H.	10	6	0	Haworth & Co., R.	1	1	0
Agnew, J. H. & Bros.	10	6	0	Heywood, A. H. J.P.	2	2	0
Andrew, G. and Sons	1	1	0	Heywood, O. J. P.	2	2	0
Armistead, R.	1	1	0	Higgin, Lloyd	2	2	0
Armitage and Son, Sir E., Limited	1	1	0	Hill, John	2	0	0
Ashton, Thomas, J.P.	2	0	0	Holme, J.	10	6	0
Aspell and Son	2	2	0	Holme, Miss E. C.	5	0	0
Barbour, R. & Bros.	3	3	0	Hoyle, Joshua, & Son (Limited)	2	2	0
Barclay, R. and Co.	1	1	0	Hillingworth and Heywood	2	2	0
Barlow and Jones (Limited)	1	1	0	Jennifred and Gariel	1	1	0
Barlow, T. & Bros.	1	1	0	Jones, T. E.	2	2	0
Bayley and Craven	2	2	0	Kirkpatrick, E.	5	0	0
Bealey, Richard J. P.	1	0	0	Kolp and Co.	2	2	0
Beattie, Wilson, Knowles, and Co.	1	0	0	Ledward & Sons, T.	1	1	0
Beatty, Altgeldt, & Co.	1	1	0	Leedham, F. H.	1	1	0
Behrens, Messrs, & Beith, Stevenson, & Co.	2	2	0	Leedham, F. H. Contents of Box	10	0	0
Bell, J. and J.	1	1	0	Leppoc, H. J., J.P.	2	2	0
Bell, Wm.	1	1	0	Lings, J. P.	1	1	0
Binks, Miss	1	1	0	Lodge, M.	10	6	0
Bles, S. D. and Sons	1	1	0	Lomax, Miss Eliza.	1	1	0
Bremner, J.A. and Co.	1	1	0	Lomax, Wm.	1	1	0
Briggs, Thos. Major St.	1	1	0	Lomnitz & Duxbury	1	1	0
British and Foreign Marine Insurance Co.	5	5	0	Luke, Jas.	10	6	0
Broome, J.	1	1	0	Lyon, Lord, and Co.	1	1	0
Brown, A. C. & Co.	1	1	0	Maclaren & Nephews	1	1	0
Bryan, H.	5	0	0	Malby, Jos.	10	6	0
Buchly and Co.	1	1	0	Manchester, Rt. Rev. The Lord Bishop	1	1	0
Buckley, James	1	0	0	Mather and Platt	2	2	0
Buckley, R.	5	0	0	Melland and Coward	1	1	0
Burne, John R.	10	6	0	Merton, A.	10	6	0
Burton, F.	1	1	0	Merttens and Co.	1	1	0
Carnelly, W.	1	0	0	Michaelis, J. & Co.	2	2	0
Carver Bros. and Co.	1	1	0	Micholls, Lucas, & Co.	1	1	0
Chadwick, Jas. J.P. V.P.	5	5	0	Middleton, Thos.	1	1	0
				Mildwood, G. H.	1	1	0
				Miller, Mrs. G. M.	5	0	0
				Mitward and Cryer	1	0	0
				M'Kead, Mrs.	1	1	0

BRANCHES—LIST OF ANNUAL SUBSCRIPTIONS AND DONATIONS. 137

	£.	s.	d.
Phipps, Mr. W.....	10	0	0
Portal, Mr. W. T....	1	1	0
Robinson, Mr. J.....	1	0	0
Rust, Mr. B.....	10	0	0
Sanders, Rev. S. J. W.	1	0	0
Saull & Son, Messrs.	5	0	0
Scriven, Mr. Thos....	5	0	0
Sheffield, Mr. D.....	10	6	
Shipman, Mr. Luke.	2	2	0
Shipman, Mr. W.....	1	1	0
Shoosmith, Mr. W....	10	0	0
Stanton, Mr. J. U....	5	0	0
Turner Bros., Messrs.	10	0	0
Wilson, Mr. John....	5	0	0
Total	£22	13	0

PETERBOROUGH BRANCH.

Honorary Secretary—
Mr. GEO. J. GRAY.
Annual Subscriptions.

Cattel, Mrs.....	1	0	0
*Percival, A. Esq....	10	0	0
*Strong, C. J. Esq....	1	0	0
Thomson, Mrs. A....	10	6	
Walker, Dr.....	1	1	0
Walker, Miss.....	5	0	0
Total	£4	6	6

Northumberland.

ALNMOUTH BRANCH.

Chairman—
Rev. E. L. MARRETT, Vicar.
Honorary Secretary—
Major H. SMITH.
Annual Subscriptions.

	£.	s.	d.
Northumberland, The Duke of.....	2	0	0
Armstrong, Sir W. G. Kt. C.B.....	1	1	0
Blair, Mr. H. Hunter	5	0	0
Browne, A. H. Esq....	1	0	0
Browne, Major.....	1	0	0
Burrell, Major.....	10	0	0
Buston, John, Esq....	10	0	0
*Cadogan, C. H. Esq.	1	0	0
Chriap, L. C. Esq....	1	0	0
Cooke, Miss.....	10	0	0
Crewe, Lord, Trusts. of	1	1	0
*Dickson, W. Esq....	1	1	0
Granville, Lady C....	2	2	0
Grey, Lt.-Col. Alfred	1	0	0
Hindmarsh, W. T. Esq.	1	0	0
Jones, Mrs.....	10	0	0
*Marrett, Rev. E. L.	1	1	0
*Moore, Rev. David	10	0	0
Paynter, H. Esq....	5	0	0
*Pease, J. W. Esq....	2	2	0
Percy, Earl.....	1	0	0
Purvis, Mr. H. T....	10	0	0
Richardson, Mr. G....	5	0	0
Riddell, Sir W. B. Bt.	2	2	0
Robertson, Messrs....	5	0	0
Shilbottle Colliery, Lessees of.....	10	0	0
Simpson, Mrs. Anne	10	0	0
*Smith, Major Henry	1	0	0
*Strother, Wm. Esq....	5	0	0
Tate, G. Esq.....	10	0	0
*Tate, John, Esq....	10	0	0
Tate, T. Esq.....	10	0	0
Thew, Arthur H. Esq.	10	0	0
Total	£27	15	0

BAMBURGH CASTLE BRANCH.

Honorary Secretary—
R. A. STORRAR, Esq.
Annual Subscription.

Antrobus, Rev. E..	1	0	0
<i>Donations.</i>			
Box at Boat House.	2	0	10
Do. Hotel Bamburgh	1	5	1
Total	£4	5	11

BERWICK BRANCH.

Chairman—
Rev. C. BALDWIN, Vicar.
Honorary Secretary—
B. G. SINCLAIR, Esq.
Annual Subscriptions.

*Agent, Shipwrecked Mariners' Society.	1	4	6
Allan Bros. Messrs....	5	0	0
Allan, Thomas, Esq....	5	0	0
Askew, Watson, Esq.	1	0	0
Berwick Salmon Fisheries Company	1	0	0
*Bolam, R. G. Esq....	10	0	0
Border Brewery Co....	10	6	
*Cahill, Dr. F.....	5	0	0
*Crossman & Paulin	1	0	0
Darling, Thomas, Esq.	5	0	0
Dodds, R. Esq.....	5	0	0
Fleming, L. T. & J....	10	0	0
*Forbes, Capt. R.N..	10	0	0
Forster, Col. James	1	1	0
Harbour Commissioners	2	2	0
Innes, J. H. Esq....	10	0	0
Lowrey, A.R. Esq. J.P.	10	0	0
McCreath, H.....	5	0	0
*Norman, Capt.....	10	0	0
Paxton and Purves ..	5	0	0
Purves, James D. Esq.	10	0	0
*Richardson, Dr. R.N.	10	0	0
Riddell, Mrs. W. E....	5	0	0
Robertson, A. Esq. J.P.	5	0	0
*Rutter, Rev. Evan....	5	0	0
*Sanderson, S. Esq....	10	0	0
*Sinclair, B. G. Esq..	5	0	0
Thompson, A. Esq....	5	0	0
King, Rev. Mr.....	5	0	0
Vicar, The.....	5	0	0
Weddell, J. C. & R....	5	0	0
Woods & Co. Bankers	1	1	0
Sums under 5s.....	1	12	6
Total	£18	16	6

BLYTH BRANCH.

Chairman—
JOHN DENT, Esq.
Honorary Secretary—
Mr. JAMES ROSS, Junr.
Donations.

Arkless, Bell, & Co..	10	0	0
Darling, James.....	10	0	0
*Dawson, George R..	10	0	0
Dent & Co.....	10	0	0
*Dent, John.....	10	0	0
Dixon, John.....	5	0	0
Dromgoole, Rev. P. O.	5	0	0
Eccles, Thomas.....	10	0	0
Gray, Robert, & Co..	10	6	
*Hedley, John.....	1	0	0
*Hodgson, Joseph....	10	0	0
*Hodgson, Richard..	10	0	0
Keenlyside, Jacob ..	5	0	0
Lund, John.....	10	0	0
Lund, G. R. D.....	5	0	0
Lynn, J. R. D.....	5	0	0
McAlpine, John....	5	0	0

	£.	s.	d.
Ridley, Sir M. W. Bt.	5	0	0
Robinson, Edw. A....	5	0	0
Robinson, William....	5	0	0
Saunders & Co.....	10	0	0
Sidney & Son.....	10	0	0
*Smith, William R..	10	0	0
Trustees Thoroton & Croft Estates, per			
William Gough.....	2	2	0
*Ward, Dr. G.....	10	0	0
Ward, William M....	5	0	0
Watts, Ward, & Co. (London).....	5	5	0
Whitehead & Son....	5	0	0
*Wood, James.....	5	0	0
Young, William.....	5	0	0
Sums under 5s.....	5	4	6
Total	£28	12	0

BOULMER BRANCH.

Chairman—
JOHN CRASTER, Esq.
Honorary Secretary—
Rev. L. J. STEPHENS, M.A.
Annual Subscriptions.

Allgood, Hunter, Esq.....	1	0	0
Bosanquet, C. B. P. Esq. (Donation).....	1	1	0
Browne, A. H. Esq....	1	1	0
Brown, Rev. Dixon.	1	0	0
*Brown, Robert, Esq.	10	0	0
Burrell, Bryan, Esq.	10	0	0
Collinson, Mr.....	10	0	0
*Craster, John, Esq.	10	0	0
*Dodds, Mr.....	10	0	0
Grey, Mr. James.....	10	0	0
Grey, Sir G. Bart. M.P. (the late) ..	1	0	0
Grey, The Earl.....	2	0	0
Horsley, Mr. John....	5	0	0
Lombard, Mrs.....	3	0	0
Northumberland, The Duke of.....	2	0	0
Percy, Earl, M.P....	1	0	0
Ronaldson, James T. Esq.....	10	0	0
Sanderson, Mr.....	5	0	0
Smith, The Misses....	5	0	0
*Stephens, Rev. L. J.	10	0	0
Tankerville, Earl of	1	0	0
Tate, John, Esq.....	10	0	0
Thorpe, Mrs.....	10	0	0
Total	£19	17	0

GRESSWELL BRANCH.

Chairman—
Major O. C. B. GRESSWELL.
Honorary Secretary—
Rev. R. E. TAYLOR.
Donations.

Adshead, Mr.....	5	0	0
Bell, Mr. Thomas....	5	0	0
Bowman, Messrs....	10	0	0
Chirney, Mr. Joseph	5	0	0
Cresswell, Major O. C. B.....	10	0	0
Crozier, Mrs.....	5	0	0
Crozier, Mrs.....	5	0	0
Hodgson, Mr. Wm....	10	0	0
Matheson, Mr. Thos.	5	0	0
Middlemas, Mr. T. W.	10	0	0
Taylor, Rev. R. E....	1	0	0
Wetheral, Mr.....	5	0	0
Total	£14	5	0

HAUXLEY BRANCH.

Chairman—
S. F. WIDDINGTON, Esq.
Honorary Secretary—
Rev. JAMES FAIRBROTHER.
Annual Subscriptions.

	£.	s.	d.
Northumberland, His Grace the Duke of	2	0	0
Atkinson, G. C. Wilson, Esq.....	1	0	0
Bambridge, E. M. Esq.	2	2	0
Browne, General.....	1	1	0
Carr, Rev. T. W....	1	1	0
*Clutterbuck, T. Esq.	1	1	0
Carrie, Dr.....	10	0	0
*Dand, M. H. Esq....	1	1	0
*Dand, Robert, Esq..	10	6	
*Dand, James, Esq....	10	0	0
*Dand, Rev. J. J....	10	0	0
Davidson, Jas. Esq..	1	1	0
Davidson, J.....	5	0	0
Davidson, John, Esq.	10	6	
*Dunn, Rev. J. W....	10	6	
*Forster, Col.....	1	1	0
Forster, Miss F.....	10	0	0
Huggup, Miss.....	10	0	0
*Hiderton, Rev. Thos.	1	0	0
Lawson-Smith, E. M. Esq.....	2	0	0
Li-dell, John, Esq. (Donation).....	5	0	0
Maling, C. Esq.....	1	1	0
McCabe, C. F. Esq....	1	0	0
Riddell, J. G. Esq....	1	0	0
Shield, Miss.....	10	0	0
Tate, John, Esq....	1	0	0
*Thomson, Rev. G. S.	1	0	0
Warkworth Harbour, Commissioners of.	10	0	0
*Widdington, S. F. Esq.....	2	2	0
Sums under 5s.....	3	0	0
Total	£41	10	6

HOLY ISLAND BRANCH.

Chairman—
ROBERT CROSSMAN, Esq.
Honorary Secretary—
Rev. W. W. F. KEELING.
Annual Subscriptions.

Armstrong, Sir W. G.			
Bart.....	1	1	0
Askew, Watson, Esq.	1	1	0
Border Brewery Co....	10	6	
Crewe's, Lord, Trustees.....	2	2	0
*Crossman, R. Esq....	2	2	0
Cruddas, W. D. Esq.	1	1	0
Douglas, Mrs.....	1	1	0
*Grey, Grey, Jas. Esq.	10	6	
Ridley, Sir M. W., Bart.....	1	0	0
Tankerville, Earl...	1	0	0
Waterford, Louisa, Marchioness of...	2	2	0
Total	£13	11	0

BRANCHES—LIST OF ANNUAL SUBSCRIPTIONS AND DONATIONS. 139

Oxfordshire.
HENLEY-ON-THAMES
BRANCH.

Chairman—
C. LUCY, Esq.
Honorary Secretary—
A. R. AWBERY.
Annual Subscriptions.
£. s. d.
Awbery, A. R. 10 0
Barnett, Mrs. 10 0
Child, Miss. 10 0
Elwes, Miss. 1 1 0
Lockey, Miss. 1 1 0
Do. extra (1881) ... 10 6
Lucey, C. Esq. 1 1 0
Melvin, Miss. 5 0
Morgan, F. Esq. 1 1 0
Noble, J. Esq. 2 0 0
Pinckney, Rev. W. P. 1 1 0
Schwabe, G. C. Esq. 1 0 0
Boxes at Hotels, &c. 1 15 0

Total£12 5 6

Wiltshire.
FISHGUARD
BRANCH.

Patron—
The Rt. Hon. LORD KENSINGTON, M.P.
President—
W. DAVIES, Esq., M.P.
Chairman—
H. LL. HARRIES, Esq.
Honorary Secretary—
MR. WILLIAM VAUGHAN.
Annual Subscriptions.

£. s. d.
Bell, C. F. Esq. 5 0
Blad, Mr. G. J. 5 0
Bown, Capt. C. 5 0
Corbett, Rev. R. 10 0
Davies, W. Esq., M.P. 1 0 0
Eaton, Evans, and Williams, Messrs. 10 0
Edwardes, A. Esq. 5 0
Ellis & Co., Messrs. 5 0
Emment, Mrs. 10 0
Evans, E. H. Esq., R.N. 5 0
Everett, Rev. R. W. 5 0
*George, Capt. D. 5 0
Green and John, Messrs. 10 0
Greenish, Messrs., and Dawkins 5 0
Hamilton, Lady. 1 0 0
*Harries, H. LL. Esq. 10 0
Harvey, Messrs. J. & Sons. 10 0
James, John, Esq. 10 0
Johns, Rev. T. Esq. 10 0
Kensington, Rt. Hon. Lord, M.P. 2 0 0
Laws, Mrs. 9 10 0
Mathias, J. Esq. 0 10 0
*Mathias, Lewis, Esq. 1 0 0
Mortimer, F. W. Esq. 5 0
Mortimer, Rev. T. G. 10 0
Owen, T. Ruiz, Esq. 5 0
Owens, John, Esq. 5 0
Penn, R. P. L. Esq. 10 0
Polak, J. M. Esq. 5 0
Protheroe, Miss Schaw Richardson, Capt. G. 10 0
Shettle, J. Esq. 5 0
Smith, R. Esq. 5 0
Steedman, Mrs. 5 0
Thomas, A. Esq. 5 0
*Vaughan, Mr. W. 5 0

£. s. d.
Wilkins & Co. Messrs. - 10 6
Sums under 5s. 7 1 6
Collecting Boxes ... - 8 3

£24 5 3

LITTLEHAVEN
(ST. BRIDE'S BAY)
BRANCH.

Patron—
The Rt. Hon. LORD KENSINGTON.
Treasurer—
Rev. J. O. HARRIS.
Hon. Sec.—
Captain GOLDWYER.
Annual Subscriptions.
£. s. d.
Armstrong, Elliot, Esq. 10 6
Bowen, Miss. 5 0
Davies, Warren 5 0
*Goldwyer, Captain G. Aese 10 0
Goldwyer, J. E. 10 0
*Harris, The Rev. J. O. 10 0
Harvey, Job. 1 1 0
Harvey, John. 1 1 0
*Kensington, Lord. 5 5 0
Lindsey, Mrs. 5 0
*Mears, Rev. J. 5 0
Marsh, T. E. M. 10 0
*Philpin, Mr. Joseph. 5 0
*Rogers, Mr. R. 5 0
Thomas, Jos. H. Esq. 10 0
Woodman, Mrs. 5 0
Small Sums 14 6

£12 17 0

Donations.

Rowlands, Bowen, Q.C. 10 0
Goldwyer, H. 10 0
Harries, G. 1 0 0
Owen, H. R. T. A. 10 0

Total Dons. 2 10 0
Total Subs. 12 17 0

£15 7 0

MILFORD HAVEN
BRANCH.

Patron—
The Right Hon. THE EARL OF CAWDOOR.
President—
Str J. OWEN MOURFIELD, Bt.
Chairman—
Admiral J. Lort Spokes.
Honorary Secretary—
H. PATRISON, Esq.
Annual Subscriptions.
M.P. 1 1 0
Allen, Lady Catherine 10 0
*Appley, F. Esq. 5 0
*Cawdor, Earl of 2 0 0
*Davies, Wm. Esq. 1 1 0
Dawkins, W. Esq. 5 0
Evans, James Eaton, Esq. 5 0
Greenish & Dawkins, Messrs. 5 0
Griffith, Geo. Esq., J.P. 5 0
*Harries, George, Esq. Rickestone. 2 0 0
*Jackson, T. Esq. 5 0
*Jones, Rev. E. H. 5 0
*Lambton, Colonel. 1 0 0
Lambton, Lady 1 0 0

£. s. d.
Lawton, J. H. S. Esq. - 5 0
Leach, Major. 1 0 0
McMaster, Thos. Esq. - 5 0
Meyrick, Sir T. Bart. 1 0 0
*Mirehouse, R. W. B. Esq. 1 0 0
Morgan, Mrs. E. S. - 10 0
Morgan, Miss Alice. - 10 0
Morrison, Dr. 5 0
Palmer, Mr. T. 5 0
Phillips, John, Esq. Lloyd's Agent. 10 6
Phillips, F. Lort, Esq. - 10 0
Roberts, W. R. Esq. - 5 0
Roch, Nicholas, Esq. 1 0 0
Saurin, M. A. Esq. 1 0 0
*Stokes, Admiral. 1 0 0
*Stokes, Colonel. 10 0
Smedley, Isaac, Esq. - 5 0
Stamper, J. F. Esq. - 5 0
Teasdale, J. H. Esq. - 10 0
Traylor, E. and A. Messrs. 5 0
Woodhouse, Brown, & Co. Messrs. 1 1 0
Life-boat Boxes 8 8
Sums under 5s. 6 12 0

Total£29 10 2

ST. DAVID'S AND SOLVA BRANCH.

Patron—
Right Rev. Lord Bishop of ST. DAVID'S.
President—
Rev. Canon LEWIS.
Chairman—
EBENEZER REES, Esq., J.P.
Vice-Chairman—
SAMSON WILLIAMS, Esq.
Honorary Secretaries—
W. PEREGRINE PROPERT, Esq., LL.D.
SAMSON T. WILLIAMS, Esq.
Annual Subscriptions.
Allen, Veris Rev. Dean 1 1 0
Allen, Miss. 1 1 0
Appleyby, Mr. W. 5 0
Arnold, Mr. W. 5 0
Bevan, Rev. Canon. 1 1 0
Bishop of St. David's 1 1 0
Cawdor, Earl. 2 2 0
Davies, Mrs. J. 5 0
Davies, W. Esq., M.P. 1 1 0
Evans, Rev. J. 5 0
Foley, S. Esq., M.D. - 5 0
Green & John, Messrs. - 5 0
Griffith, Capt. 5 0
Harries, G. Esq. 2 0 0
Harries, Gilbert D. Esq. 10 6
Hicks, Capt. D. 5 0
Hicks, H. Esq., M.D. - 10 0
James, P. Esq., M.D. - 10 0
Lewis, Rev. Canon. 1 1 0
Lewis, Capt. T. 10 0
Lloyd, Capt. 5 0
Morgan, C. Esq. 10 6
Phillips, Rev. J. 10 0
Probert, Dr. 1 1 0
Rees, E. Esq. 10 0
Robinson, E. Esq. 10 0
Roach, Capt. S. 5 0
Thomas, Miss. 1 1 0
Williams, Capt. David - 5 0
Williams, Mr. G. O. - 5 0
Williams, S. T. Esq. - 10 0
Williams, Mr. W. 5 0
Williams, W. W. Esq. - 5 0

Total£20 11 0

Donations.
Bickerstaffe, Col. 1 0 0
Probert, Dr. 6 0
Do. Proceeds of Concert. 7 0 0

£. s. d.
Collecting Boxes at Grove Hotel. 13 8
Do. City Hotel. 6 3
Do. St. Justinian. 4 11
Sums under 5s. 1 9 0

£31 10 10

TENBY BRANCH.

President—
F. D. DYSTER, Esq., M.D.
Chairman—
C. ALLEN, Esq.
Treasurer and Hon. Sec.—
JOHN R. ROWLANDS, Esq.
Annual Subscriptions.
£. s. d.
*Allen, Charles, Esq. 1 0 0
Armitage, Miss. 5 0
Ash, P. J. Esq. 5 0
Andrew, Miss. 5 0
Battye, George, Esq. 5 0
Brook, Mrs. 5 0
Brooks, Misses. 5 0
Brook, T. - - -
Bull, Mrs. - - -
Cox, General. - - -
Clark, H. 5 0
Clatworthy, A. R. 5 0
Craddock, J. D. - - -
Crowther, Mrs. 5 0
Cust, C. 5 0
Davies, H. - - -
Dunn, N. J. Esq. 10 0
*Dyster, Dr. 1 0 0
Elwell, F. Esq. 5 0
*Evans, Capt. 5 0
Ferrior, Mrs. 5 0
Fleet, Mrs. - - -
Frith, W.P., R.A. - - -
Forbes, 5 0
Gardner, W. 5 0
G. G. 5 0
Good, E. 5 0
Graham, Mr. - - -
Gregory, Mr. Joseph Hamilton, General. 5 0
*Harris, P. G. 5 0
*Harris, Miss Lloyd. 5 0
*Hatchets, Esq. - - -
*Hawkesley, J. Esq. 10 0
*Herbert, Rev. H. H. 5 0
*Highmore, Miss. - - -
Holmes, W. - - -
Howell, Miss. - - -
Hutchinson, Lt.-Col. - 5 0
*Huntington, Rev. G. 5 0
*James, Miss. 5 0
*Johnson, Sir E. 5 0
*Jones, Mrs. B. 10 0
*Kemmis, T. 5 0
*Kentley, A. G. - - -
*K. W. E. C. - - -
*Large, C. E. 5 0
*Large, C. F. - - -
*Lee, Mrs. 5 0
*Lee, T. W. 5 0
*Lewes, Colonel. - - -
*Little, J. W. 5 0
*Lloyd, Howard. 10 0
*Lock, Mrs. Wm. 5 0
*London and Provincial Bank. 5 0
*Maddy, Mrs. - - -
*Mar and Kellie, Dowager Countess Mathias, Mr. Thomas. - - -
*Morgan, J. - - -
*Morley and Sons. - - -
*National Provincial Bank. 5 0
*Owen, M. - - -
*Owen, Peter, Esq. - - -
*Paget, F. - - -
*Paget, W. B. - - -
*Parkinson, R. J. H. Esq. - - -
*Power, E. R. Esq. 10 0

BRANCHES—LIST OF ANNUAL SUBSCRIPTIONS AND DONATIONS. 145

EASTBOURNE BRANCH.		£. s. d.		£. s. d.		£. s. d.	
Chairman—							
A. B. WEAUGHAM, Esq.							
Treasurer—							
G. MOLINEUX, Esq.							
Honorary Secretary—							
Mr. H. M. EMARY.							
Annual Subscriptions.							
A Friend	5 0	Podmore, Rev. T.	10 0	Baker, H. M. Esq.	5 0	Jackson, Miss (Ealing)	6 0
Adams, Rev. E. A.	10 0	*Provost, Mr. J. A.	5 0	Bannatore, Mr.	5 0	Kingsbury, Miss	5 0
Adams, J. J. Esq.	10 0	Rivington, F. Esq.	10 0	Barlow, Capt.	10 0	Kortwright, Mrs.	5 0
Alder, the Rev. Dean	10 0	Roberts, Dr.	5 0	Beaumont, Mrs.	1 0	Langdon, A. W. Esq.	10 0
*Allen, Rev. R.	5 0	*Roper, F. C. S. Esq.	1 0	Beeching and Co.,		Lee, Miss	10 0
Allpress, Mr. F.	5 0	Roper, Mr. John	5 0	Messrs.	1 0	Leich, Mrs.	1 0
Angell, Mrs.	5 0	Route ge, W., Esq.	5 0	Birkett, J. Esq.	5 0	Macaulay, Mrs.	5 0
*Bacon, Capt.	10 0	Rudd, Mr.	5 0	Bishop, Miss	1 0	Mackay, Miss	10 0
*Bathurst, Rev. W. A.	5 0	Russell & Bromley	5 0	Boger, G. O. Esq.	5 0	McKeller,	5 0
Bindon, Mr. S.	5 0	Russell, Scott, Esq.	5 0	Bolding, Miss	10 0	Micklethwait, Mrs.	5 0
Blackburn, J. J. Esq.	5 0	Schreiner, Fredk. Esq.	5 0	Bolding, Miss	10 0	Morris, E. R.	10 0
Bradley, Miss	5 0	Scott, Mrs.	5 0	Boning and Small,		Nicholl, Miss	10 0
Brodie, Wm. Esq.	5 0	Scott, Rev. von E.	2 6	Messrs.	5 0	Nichols, D. Esq.	5 0
Brodie, Miss	5 0	*Sharp, Mr. R. Esq.	10 0	Bostock, Mrs.	1 0	Norcott, Sir Wm.	5 0
Brown, G.	5 0	Sherwood, Dr. A. P.	5 0	Braham, Mrs.	10 0	North, Miss.	10 0
Brown, Mr. J.	5 0	Simmons, Mr. A. J.	5 0	Brassey, Sir T., K.C.B.,		Orlebar, Admiral	5 0
Brown, Mr. H. R.	5 0	Soddy, B. Esq.	5 0	M.P.	1 0	Parkin, Rev. John	5 0
Cardwell, Mrs. D. A.	5 0	Sparks, Mr. Jno.	5 0	Brisco, Miss	1 0	Pearch, Mr. J. H.	5 0
Chidell, J. Esq.	5 0	St. Clair, Mrs. Rosetta		Broadwood, Mrs.	10 0	Peyton, J. E. H. Esq.	1 0
C. H.	5 0	Solomons		Brocklebank, R. M.		Plummer, Mr. E.	5 0
*Climpson, Mr. R.	5 0	Stiff, Carlton, Esq.	5 0	Esq.	1 0	Pritchard, Mrs.	10 0
*Coles, J. H. C. Esq.	5 0	Strange, Mr. N.	5 0	Brown, H. A. Esq.	10 0	Revill, W. F., Esq.	5 0
*Colgate, R. Esq.	5 0	Stretton, Mr. J.	5 0	Browne, Miss	5 0	Richards, Mr. J. G.	5 0
Colville, E. Esq.	5 0	Stargis, S. Esq.	1 0	Burfield, Messrs.		Roddia and Gold-	
Crake, Rev. E.	5 0	Sutton, Mr. H.	5 0	J. and C.	5 0	smith, Messrs.	5 0
Crook, Mr. H.	5 0	Sutton, Mr. Thos.	5 0	Burgoyne, T. C. Esq.	10 0	Ross, T. G. Esq.	10 0
Devonshire, His Grace		Swift, John, Esq.	1 0	Burton, A. H. Esq.	1 0	Rubie, Mr. E. W.	5 0
the Duke of	1 0	Swinford, Mrs. A.	2 6	Cameron, J. Esq.	1 0	Sayer, Miss	1 0
Dexter, Mrs.	5 0	Tarbutt, Miss.	5 0	Carter, C. P. Esq.	1 0	Scrivens, S. Esq.	10 0
*Earnshaw, Mr. B. K.	5 0	Tindall, Miss.	5 0	Catt, Mr. Joseph	5 0	Shaw, A. R. Esq.	5 0
Earp, Wm. Esq., the	1 0	*Towner, Mr. J. C.	5 0	Caufield, H. C. Esq.	5 0	Smith, Mrs. Edwin	5 0
late	1 0	Travers, Archd. Esq.	5 0	Chandler, Mr. S.	5 0	Smith, Mrs. Masters	5 0
E. R.	5 0	*Usill, Rev. J.	5 0	Christopherson, Miss	5 0	Stainton, Miss	10 0
Edwards, James, Esq.	5 0	Walker, Edw. Esq.	5 0	Christopherson, Miss	5 0	Stichel, Miss	10 0
Ellis, John, Esq.	10 0	*Wallis, G. A. Esq.	10 0	Cotes, T. Horsman,		Sutton, Rev. R. S.,	
*Evensden, Mr. H.	5 0	*Wallis, W. L. Esq.	10 0	Esq.	1 0	Rype Rectory	1 0
Finlay, Mrs.	5 0	Whelpton, Rev. H. K.	10 0	Combermere, Vis-		Tanner, Mrs.	5 0
Foran, J. C. Esq.	5 0	Winder, Mr. E.	5 0	countess.	5 0	Tolley, Miss	5 0
Frare, J. H. Esq.	5 0	Winder, J. Esq.	5 0	Convent, The	10 0	Tottenham, Rev. J. W.	10 0
Gilbert, C. D. Esq.	1 0	Woodland, Mrs.	5 0	Cooke, Dr.	5 0	Towell, T. N. Esq.	5 0
Gould, Dr. G.	10 0	*Wrangham, A. B.	5 0	Corporation of		Tree, Mr. Alderman	2 0
Green, Rev. G. R.	10 0	Esq.	1 0	Hastings	20 0	Turner, Rev. W. T.	10 0
Gurney, G. Esq.	5 0	£35 7 6		Crake, V. B. Esq.	1 0	VonRoemer, Baroness	1 0
Hagger, Mrs.	5 0	Donations.		Crothers, Dr.	1 0	Vores, S. Esq.	10 0
Hart, Miss.	10 0	Barrington, Lady	5 0	Croucher, Dr.	10 0	Waldgrave, Lady	
Hedley, Capt. G.	5 0	Bell, Mrs.	5 0	C. T. H.	10 0	Mary	5 0
Henderson, R. H.	5 0	Borton, Rev. Canon.	5 0	D'Arley, W. F. Esq.	5 0	Wentworth, F. Ver-	
Esq.	5 0	Clark, Edw. Esq.	5 0	Dawes, Rev. G. D.	5 0	non, Esq.	1 0
*Holman, Capt.	5 0	Gainsborough, Countess		Dickinson, Mrs.	5 0	Wickham, Miss	5 0
Homewood, Mr. J.	5 0	Dowager of	5 0	Dixon, J. Esq.	1 0	Womersley, Mr.	
Hood, W. Esq.	10 0	Grace, Mrs.	5 0	E. A. H.	1 0	A. D.	5 0
Hurst, Mr. Alex. & Co.	1 0	Manby, Mrs.	5 0	Eaton, Mr. Chas.	5 0	Young, W. B. Esq.	1 0
*Insoll, R. Esq.	5 0	Johnson, J. B. Esq.	10 0	Edmed, Mr. Geo.	5 0	Small sums under 5s.	2 8 0
Jackson, Mrs. W. J.	2 6	Routledge, W. Esq.	5 0	Edridge, Mrs.	5 0		
Ladd, Mrs.	2 6	Smith, G. K. Esq.	10 0	Elkin, C. M. Esq.	5 0		
Langham, J. G. Esq.	10 0	Shirbrick, Genl.	5 0	Ellis, Miss.	5 0		
*Lawrence, G. H. Esq.	1 0	Strange, Mr. Nevill.	5 0	Ellis, Wilson & Co.,			
Lippencott, R. C. C.	5 0	Sutton, Mr. T.	5 0	Messrs.	10 0		
Esq.	5 0	Twells, Mrs.	5 0	Evans, A. Esq.	5 0		
London and County		Young, Mrs.	5 0	Eyre, Rev. C. J. P.	10 0		
Bank	1 0	Small sums	12 2 0	Field, Miss	1 0		
Lothian,	5 0	Collecting Boxes	14 12 3	Fisk, Rev. J. H.	5 0		
Low, Rev. T.	5 0	Total Dons.	30 19 3	Fitz-Hugh, Miss	10 0		
Maitland, J. A. Esq.	10 0	Total Subs.	35 7 6	Foyster, Rev. G. A.	5 0		
*Maxse, Admiral.	1 0	£66 6 9		Foyster, Rev. H. B.	10 0		
Michell, Mr. R.	5 0			Ginner and Son,			
*Molineux, Whitfield,				Messrs.	5 0		
& Co. Bankers	10 0			Gottlieb, Mrs.	5 0		
*Morrison, J. G. Esq.	10 0			Gray, Mrs. J. (the			
Morris & Son, Messrs.	5 0			late)	1 0		
Morrison, Mr. W. E.	5 0			Green, Rev. Wm.	10 0		
Mullen, Mr. C.	5 0			Greenhill, Dr.	5 0		
Mures, Miss.	1 0			Grenside, Miss	0 5 0		
Page, Mr. Thomas.	10 0			Griffin, Mrs. N.	1 0		
Palmer, Rev. J. H.	5 0			Guilleband, Rev. H. L.	10 0		
Pennell, Mrs. C.	10 0			Haig, Mrs.	10 0		
Perdval, Mrs.	5 0			Hains, John, Esq.	5 0		
Phippes, Mrs. Jane.	5 0			Hamilton, Miss	10 0		
Pitman, Rev. T.	5 0			Hardy, C.	5 0		
				Haviland, F. G. Esq.	1 0		
				Heath, Dr.	1 0		
				Ditto (Friend)	10 0		
				Heathcote, N. Esq.	5 0		
				Highmore, Miss	10 0		
				Hill, Mrs. Kesteven	5 0		
				Horton, Rev. Sir W.	10 0		
				How, C. T. and Co.			
				Messrs.	5 0		
				Howell, Sir T.	5 0		
				Howell, Mrs.	10 0		
				Hume, Rev. W. W.	1 0		
				Huxtable, Archdeacon	1 0		

NEWHAVEN BRANCH.

Chairman—
J. J. HEAD, Esq.

Honorary Secretary—
J. W. NOEL, Esq.

Collector—
MR. JOHN B. ROBERTS.

Annual Subscriptions.

Blencow, J. Esq.	1 0 0
Brown, T. Esq.	1 1 0
*Bull, J. Esq.	10 6
Burfield & Son	1 1 0
Bushby, G. Esq.	10 0
Catt, Miss	1 0 0
Catt & Son, Messrs.	1 1 0
Chatfield, E. Esq.	10 6
Chichester, Earl of	2 0 0
Cook & Sons, Messrs.	2 2 0
Cowney, James, Esq.	10 6

BRANCHES—LIST OF ANNUAL SUBSCRIPTIONS AND DONATIONS. 147

£.	s.	d.	£.	s.	d.
Gilbert, Mrs.	10	6	Hoskins, Mrs.	10	0
Griffiths & Browett,			Jefferys, Mr.	5	0
Messrs.	1	0	Kimpton, Mrs.	10	0
Heaton, A.	1	0	King, Mrs.	5	0
Heaton and Taylor,			Kiss, Mr.	5	0
Messrs.	1	0	Little Sister	5	0
Heaton, G. Esq.,			Mansell, Mrs.	5	0
J.P.	1	0	Marrinan, Mr.	5	0
Heaton, G. (Solihull)	1	0	Mellor, Mrs.	5	0
Heaton, H. Esq.	1	0	Neale, Mrs.	5	0
Hoerner, M. U. Esq.	1	0	Newey's, Mrs. Chil-		
Huggins, W. Esq.	1	0	dren	5	0
Jones, Miss	1	0	Pattison, Mr.	5	0
Jutson and Sons,			Phillips, Mrs.	5	0
Messrs.	1	0	Truth	5	0
Manton, H. Esq. J.P.	2	0	Venour, Mr.	10	6
Osler, Mrs. C.	1	0	Walker, Mr. A.	10	6
Padmore, J. Esq.	1	0	Ward, Mrs.	5	0
Simpson, F. R. & Co.			Watts, Mr.	5	0
Messrs.	1	0	Whitfield, Mr. A.	5	0
Stevens, James, Esq.	1	0	Whitfield, Mrs. A.	5	0
Stokes, J. Esq.	1	0	Whitfield, Mr. H.	10	0
Tangye, Limited	2	0	Whitfield, Mrs. H.	5	0
Tyndall, E. L. Esq.	1	0	Wilkins, Mrs.	5	0
Walker, S. Esq.	1	0	Yardley, Miss	5	0
Walker, Miss	1	0	Sums under 5s.	1	9
Whitfield, S. Esq.	1	0			
Whitehouse, J. Esq.	1	0			
Wilkes, G. Esq.	1	0			
Wilkes, J. Esq.	1	0			
Wilkes, John, Esq.,					
Darlaston	10	6			
Williams, Clement I.	1	0			
Williams, Francis	1	0			
Williams, Mrs. J.	1	0			
Williams, J. Esq.	1	0			
Wood, Miss	1	0			
	£65	9			

Per Miss CLAYWORTH—

Birtles, J. and Son	5	0
Hickman, Mr. G. W.	5	0
Thornton, Mrs.	5	0
Timmins, Mr. S.	10	0
Tyler, Mr. J. G.	5	0
Sums under 5s.	1	10

YARDLEY,
per Miss WHITAKER—

Alston, Mrs. Elmdon		
Hall	1	0
Barrows, Mr. J.P.	1	0
Barrows, Mr. Jun.	10	6
Biddle, Mr.	5	0
Bullivant, Mr.	5	0
Dalman, Mrs.	5	0
Dodd, Rev. F. S.	5	0
Fenton, Mr.	10	0
Hackett, Mr.	10	0
Hedges, Mrs.	5	0
Madley, Mrs.	10	0
Merritt, Mrs.	5	0
Muscott, Mrs.	5	0
Onions, Mrs.	5	0
Pollack, Mrs.	5	0
Ransome, Mr.	5	0
Rosenberg, Mr.	5	0
Shakespeare, Mr. W.	5	0
Simons, Rev. G. H.	5	0
Tangye, Mr. J.P.	1	0
Whitaker, Mrs.	1	0
Whitaker, Miss	5	0
Whitaker, Miss A.	5	0
Sums under 5s.	4	6

OLTON, per Miss MIDDLETON.

Hunt, Mrs.	5	0
Manley, Mr.	5	0
Sums under 5s.	1	11
Total	£30	0

Donations.

ACOCK'S GREEN,
per Miss BARKER.

Sums under 5s.	8	6
----------------	---	---

YARDLEY,
per Miss WHITAKER—

Chinn, Miss Life-boat		
Box	9	0
Fenton, Mr. Life-boat		
Box	2	7
Harvey, Mrs.	6	0
Whitaker, Miss, Life-boat Box.	15	6

OLTON, per Miss MIDDLETON.

Sums under 5s.	1	8
Total	£5	14

Chairman—
J. BARROWS, Esq., J.P.
Treasurer and
Honorary Secretary—
Rev. A. BUTLER, LL.D.
Annual Subscriptions,
ACOCK'S GREEN,
Per Miss BARKER—

£.	s.	d.
Ash, Mr. A. J.	5	0
Ash, Mrs.	5	0
Atkin, Mrs.	5	0
Barker, Mr. J.	10	6
Barker, Mrs.	10	0
Barker, Mr. C. E.	5	0
Barker, Mr. T. B.	5	0
Barker, Mr. H.	5	0
Barker, Mr. T. B.	5	0
Boston, Mr.	10	0
Bourne, Mrs.	5	0
Butler, Rev. Dr.	5	0
Dixon, Mrs.	5	0
Dudley, Mrs.	5	0
Fletcher, Mrs.	5	0
Handley, Mr. & Mrs.	10	6
Hodgkins, Mr.	1	0
Holroyd, Mr. E. B.	5	0

Collecting Cards.

ACOCK'S GREEN,
per Miss BARKER—

Holroyd, Alec.	5	3
Mander, Lillian	2	1
Middleton, George	14	0
Richards, Walter	12	8

YARDLEY,
per Miss HOSKINS—

Biddle, Miss	3	6
Grice, Miss	8	10
Hoskins, Miss	16	0
Hoskins, Mr. J.	5	0
Rowlands, Miss	4	0
Total	6	11

Total Subs. 30 0 0
Total Dons. 5 14 6
Collecting Cards 6 11 4
£42 5 10

Blockley Branch.

Honorary Secretary—
Rev. ALFRED J. SODEN.

Annual Subscriptions.

Bearcroft, Mrs.	5	0
Clarke, Rev. J. W.	5	0
Clifford, Mr. G. S.	5	0
Grisewood, Rev. A. G.	10	6
Herbert, Mr. Fred.	5	0
Houghton, Rev. E. J.	5	0
Peebles, Mr. C. J.	5	0
Smith, Mr. P.	5	0
Scovell, Mr. J.	5	0
Soden, Rev. A. J.	5	0
Wake, Mr. A.	5	0
Total	£3	0

STECHFORD BRANCH.

Treasurer and Hon. Sec.—
Mr. WILLIAM MORGAN.

Annual Subscriptions.

Baird, Miss, Dover	5	0
Bower, Misses,		
Knowle	2	6
Chirm, Mr. J., Edg-		
baston	5	0
Clarke, Mr.	10	0
Davis, Mrs. Bolton,		
Swereford Park	1	0
Icke, Mrs.	10	6
King, Mr. W. R.		
(2 yrs.)	1	0
Lloyd, Miss, Lea-		
mington, collected		
by:—	£7	0
A. M. D.	4	0
Fretwell, Capt.	5	0
Goode, Mr. W.	10	6
Grimsdick, Mr. W.	5	0
Holy, Miss	5	0
Ingall, Mr. W. G.	1	0
Lloyd, Mr. H. C. H.	6	0
Lloyd, Miss H.	10	0
Lloyd, Mrs.	5	0
Lloyd, Mrs.	3	6
L. W. H.	3	0
Mactavish, Miss	10	0
Matthews, Rev. J. E.	5	0
Metcalfe, the Misses	1	0
M. S.	5	0
M. T. C. and L. M.	3	0
Paske, Miss	10	0
Tritton, Col. & Mrs.	10	0
Wright, Miss	5	0

Maxwell, Miss, Bir-
mingham 5 0 0
Morgan, Miss, Quar-
ndon 10 6 0
Morgan, Mr. W. 10 6 0
Neal, Mr. J. R., 5 0 0
Torquay 5 0 0

Total £14 7 1
Total Subs. 13 2 0
Total Dons. 6 4 10
Col. Cards 14 7 1
£33 13 11

WORCESTER BRANCH.

Chairman—
FRAS. SPOONER, Esq.
Treasurer—
FRAS. SPOONER, Esq.
Honorary Secretary—
F. W. SEAMAN, Esq.

Annual Subscriptions.

Allsopp, Sir Hy. Bart.	1	0
Ames, Fredk. Esq.	1	0
Amphlett, Rev. Jos.	10	0
Bearcroft, Rev. J.	1	0
Clarke, Erlin, Esq.	1	0
Clarke, Geo. Esq.	1	0
Cooper, J. D. Esq.	5	0
Cox & Painter, Messrs.	10	6
Dodd, Rev. Thomas	5	0
Dorville, Capt R.N.	1	0

Table with columns £. s. d. listing names and amounts. Includes: Evans, E. Bickerton, Esq., Evans, E. Wallace, Esq., Gresley, E. A. D. Esq., Hadley, E. Newport Esq., Hall, Joseph, Esq., Heaton, W. H. Esq., Holland, Walter, Esq., Jones, Henry, Esq., Johnstone, Miss., Lea, C. Wheelley, Esq., Lechmere, Sir E. A. H. Bart., Leonard, Geo. Esq., Luard, Rev. F. G., Martin, Miss C. H., McNaught and Smith Messrs., Mellor, Wm. Esq., Nicholas, Mrs., Perrins, J. Dyson, Esq., Pidcock, C. Foley, Esq., Piercy, Longbottom & Co., Reid, John, Esq., Rowlands, Rev. W. E., Rutland, Jos. Esq., Sale, Rev. C. J., Scott & Oram, Messrs., Seaman, F. W. Esq., Spooner, Francis., Stallard, Josiah, Esq., Stallard, Lieut.-Col. Wm., Thursfield, Rev. R., Temple, Mrs. P., Turley & Co. Messrs., Walker, Henry Esq., Walsh, Mrs. T. W., Westcombe, Esq., Williamson, Me-srs., Box at the Hop Market Hotel., Box at Bell Hotel., Sums under 5s.

Total£37 13 10

Yorkshire.

BRADFORD BRANCH

Chairman— FREDK. PRIESTMAN, Esq. Honorary Secretary— J. A. GODWIN, Esq.

Annual Subscriptions.

Table with columns £. s. d. listing names and amounts. Includes: Ackroyd, W. & Co. Messrs., Alexander, E. & Son, Messrs., Ambler, J. and Son, Messrs., Ambler, Thos. & Son, Messrs., Anderton, Swithen & Sons, Messrs., Armitage, J. R. Esq., Aykroyd, Chas. Esq., Aykroyd, Jon. Sen. Esq., Aykroyd, Jon. Jun. Esq., Bairstow, T. & M. Messrs., Beckenbach and Co. Messrs.

Table with columns £. s. d. listing names and amounts. Includes: Bell, E. & Co. Messrs., Berend and Rée, Messrs., Bottomley, M. Jun. and Co. Messrs., Bottomley, S. & Bros. Messrs., Briggs, Arthur, Esq., J.P., Brown, George, Esq., Busfeld, J. A. Esq., Chamberlin, Donner, and Co. Messrs., Cockerham, Ed. Esq., J.P., Cohen, B. Esq., Collins, William, Esq., Cordingley, Armistrong, and Co. Messrs., Craven, Joseph, Esq., Ashfield, Thornton, Drake, N. Esq., Drummond, Jas. Esq., Drummond, Jno. Esq., Fawcett, Richard, Esq., Firth, T. A. Esq., Firth, William & Sons, Messrs., Forster, Rt. Hon. W. E., M.P., Foster, John & Son, Messrs., Fox and Whitley, Messrs., Garnett, Wm. & Co. Messrs., Gillies, Garnett, & Co. Messrs., Godwin, J. V. Esq., J.P., Goulay Bros., Haggas & Sons, Jas. Messrs., Halstead, H. R. & Co. Messrs., Hargreaves, G. & Co. Messrs., Harrison and Singleton, Messrs., Heilborn, Ferdinand, Esq., Henry & Co. Messrs., A. and S., Hertz, M. and Co. Messrs., Hertz, W. D. and Co. Messrs., Heydemann & Co., Heyn, Franc. & Co. Messrs., Heyneman, Edw. Esq., Hirst, H. S. Col., Hodgson, Geo. & Co. Messrs., Hoffman and Co. Messrs., Holden, Angus, Esq., J.P., Holden, Isaac, Esq., J.P., Hyne, Rev. C. W., Bierley, Esq., Illingworth, J. Esq., Jacobs, Adolph & Co. Messrs., Jonas, Simonson, & Co. Messrs., Kell & Co. Messrs., Kessler & Co. Messrs., Knowles, Cooke, and Co. Messrs., *Lassen, A. W. Esq., Lassen, Mrs. (1880-1), Law, Russell, & Co. Messrs., Leather, G. H. & Co. Messrs., Leather, S. Esq. (1880-1), Lee, A. Esq.

Table with columns £. s. d. listing names and amounts. Includes: Leeming, John & Son, Messrs., Lewis & Co. Messrs., Lord, W. G. Esq., Lund, Charles, Esq., *Lupton, G. W. Esq., Mahler, Sichel & Co. Messrs., Mason, Henry, Esq., *McGowen, T. W. Esq., Mitchell Bros. Messrs., Mitchell & Shepherd, Messrs., Muff, T. P. Esq., Müller, George, Esq., *Muller, H. Esq., Oates, Ingham, & Co. Messrs., Oddy, Jas. C. Esq., Ormerod, Theodore, Esq., Pease, Henry & Co., Philipp, J. and Co. Messrs., Pickles, Joseph & Co. Messrs., Popplewell, J. B. Esq., Posselt, E. and Co. Messrs., Povel, L. Esq., Priestley, Briggs, and Co. Messrs., Priestman, A. Esq., *Priestman, John & Co. Messrs., Quizzow and Co. Messrs., Ramsden, Wm. Esq., Rand and Son, J. Messrs., Reiss Bros. Messrs., *Reuton, T. L. Esq., Richardson, Geo. Esq., Ripley, Sir H. W., Bart., Robertshaw & Sons, Messrs., Rothenstein and Co. Messrs., Sachs, H. W. Esq., Salmond, David, Esq., J.P., Salt, Titus, Esq., J.P., Samson and Lepoc, Messrs., Sawdon & Co. G. E. Messrs., Schaub, Wm. & Co. Messrs., Schlesinger & Wechmar, Messrs., Schuster, Fulda, and Co. Messrs., Scott & Son, Messrs., Sharp, Jonas, & Sons, Messrs., Simon, Israel, & Co. Messrs., Smith, John, & Sons, Messrs., Stansfeld, Brown, and Co. Messrs., Stavert, Zigomala, and Co. Messrs., Steintal, C. G. Esq., *Steintal and Co. Messrs., Stephenson Bros. & Co., Sugden and Briggs, Messrs., Sussmann, A. Esq., Tafel & Co. Messrs., Thwaites & Garbutt, Messrs., Thompson, M. W. Esq., J.P., Todd, John, & Sons, Messrs., Turner, Geo. & Co. Messrs., Wade, E. H. Esq., J.P.

Table with columns £. s. d. listing names and amounts. Includes: Wade, J. H., J.P., West, Edw. Esq., Wickham, L. W. Esq., Wood, B. & Co. Messrs.

£176 6 0

BRIDLINGTON BRANCH.

Chairman— E. R. HARDING, Esq. Honorary Secretary— ALFRED WEST, Esq.

Annual Subscriptions.

Table with columns £. s. d. listing names and amounts. Includes: Barnby, Mrs. H., Bedwell, F. A., Blakeney, Rev. R. P., Blundell, H. S., Brett, F. C., Broadley, W. H. H., Broomhead, T., Chapman, Rev. C. J., *Cooper, J. R., Crathorne, J., Beverley, *Creyke, Capt. R. N., Fisher, Rev. R., Fletcher, Mrs., Gladby, A., Graine, Rev. W. L., *Harding, E. R., Harrison, Mrs., Hobson, Geo., Hudson, Rev. C., Hull Trinity House, Hutchinson, C. F., Jameson, J. A., Jarratt, W. O., Marstal, H., Medforth & Hutchin-son, Morris, Miss, Neale, F., Owston, D., Exors of Pease & Co. Beverley, Prickett, Colonel, Richardson, M., *Rickaby, J., Savage, Miss, Smith, John, Stewart, J., Summers, G. B., Thompson, Rev. J., Townsend & Curtis, Messrs., Walker, G., Walton, Rev. N., Wentworth, J., Williamson, J., York Union Bank, York City and County Bank, Sums under 5s.

Donations.

Walker, G.£10 0 0 Collecting Boxes and Visitors' Donations £14 3

Total.....£60 12 9

FILEY BRANCH.

Chairman— HENRY DARLEY, Esq., J.P. Honorary Secretary— W. HANKES, Esq.

Annual Subscriptions.

Table with columns £. s. d. listing names and amounts. Includes: Baker, W., Esq., Beswick, Thos. Esq., Beswick, Wm. J.P., *Birch, Math., Brumel, Chas. Esq., Clarke, Miss, Climenston, Rev. T.

BRANCHES—LIST OF ANNUAL SUBSCRIPTIONS AND DONATIONS. 149

	£.	s.	d.
Colthorpe, L. W.	10	0	
*Cooper, Rev. A. N.	10	6	
Cross-Buchanan, H. Esq.	10	0	
Darrell, Mrs.	10	0	
*Darley, Capt. H. J. P. 2	2	0	
Dawes, Geo. Esq.	1	0	
Dewhurst, R. E.	1	0	
*Green, E. H.	1	0	
Harrison, Miss.	1	0	
Totton, R. W. Esq.	1	0	
Hurt, Miss E.	1	0	
Hurt, Miss F.	2	0	
Hurt, Miss S.	1	0	
Hurt, Rev. A. F.	10	0	
Lane, Esq.	5	0	
Lascelles, G. E.	5	0	
Laycock, Wm. Esq.	10	6	
Lee, Miss.	5	0	
Lowther, Geo. Esq.	1	0	
Mitford, Col. T. P. O. 3	3	0	
Nicholson, Mrs.	1	0	
Quifer, Miss.	10	0	
Kanfarly, Lord.	5	0	
Ripley, E. Esq.	10	0	
Sharp, Talbot, Esq.	5	0	
Taylor, Rev. R. M.	5	0	
Wheelhouse, Dr. C. G. 1	0	0	
Sums under 5s.	4	7	6
Total	£22	15	0

Donations.

Collected Aug. 10, 1882, by young gentlemen under twelve years of age attired as Nigger boys. 3 0 9

Contribution Boxes—

Crescent Hotel Box - 10 6

Railway Station Do. 1 16 3

Pillar Do. 4 7 4

Boathouse Do. 3 1 6

£45 11 4

FLAMBOROUGH BRANCH.

Honorary Secretary—
Rev. J. F. WILKINSON, M.A.

Annual Subscriptions.

Harding, E. R., Esq. - 10 0

Total

HORNSEA BRANCH.

Chairman—
WILLIAM DYSON, Jun., Esq.

Honorary Secretary—
GEORGE MILNER, Esq.

Annual Subscriptions.

Boden, W. H. 10 0

Bethell, Wm. 2 0

Broadley, W. H. Esq. 1 0

M.P. 1 0

Clark, George 1 0

Collett, Mr. (the late) 1 0

Constable, H. S. 1 0

Dutton, Holmes & Co. - 10 0

Dock Company, The Hull 3 3 0

Dyson, W. Jun. 10 6

Earle, G. H. 10 0

*Foster, Heaton 10 6

*Gibson, H. H. 10 6

Haller, G. 10 6

Henson, W. K. 10 0

*Heslop, George 5 0

*Heslop, John 5 0

Holmes, T. B. 2 2 0

Hudson, M. C., 1880-1881

	£.	s.	d.
Jones, J. T.	5	0	
Loft, Mrs.	5	0	
*Maw, A.	10	6	
*Milner, Geo.	2	6	
Montgomery & Son.	10	0	
*Ringrose-Ion, Mrs. . 1	1	0	
Shackles, C. F.	1	0	
Shackles, G. L.	5	0	
*Smithson, C. F.	1	0	
Sollitt, W.	1	0	
Spalding, Miss	10	6	
*Todd, C. J.	10	0	
Trinity House	5	0	
*Wells, B. L.	10	6	
Whateley, Rev. Canon-	10	0	
Total	£29	14	0

Donations.

Collection, Hornsea Parish Church, per Rev. E. L. H. Tew 3 0 11

Proceeds of a Concert—

Per Miss E. M. Dyson son 5 12 5

Payne, J. G. 10 0

Wilson, D. 10 0

A Friend, per Mrs. Loft. 5 0 0

Wade, Ed. 1 0 0

Collecting Boxes Received for old Rope. 2 0 0

Total Dons

Total Subs.

HUDDERSFIELD BRANCH.

Honorary Secretary—
J. A. HARRISON, Esq.

Annual Subscriptions.

Barker, Henry (Sol.) 1 1 0

Barnicoat, John 2 2 0

Bibby, L. R. (Sol.) . 1 1 0

Bottomley, Mrs J. . 1 1 0

Bradbury, T. H. (Bradley) 1 1 0

Brigg, J. F., J.P. . 1 1 0

Brook, Jonas, & Bros. 5 0 0

Brook, Freeman, and Batley. 2 2 0

Brook, George, Jun. (Dundas Street) . 5 0 0

Brook, Hy. (Warrenfield) 1 1 0

Brooke, E., J.P. 1 1 0

Brooke, John, & Sons 5 0 0

Clegg, Jesse. 1 1 0

Cresswell, Miss. 1 1 0

Cresswell, George. . 2 2 0

Crowther, Joseph. . 1 1 0

Day, John, and Sons 2 2 0

Drury, Wm. 1 1 0

Dyson, Geo. (Sol.) . 1 1 0

Dyson, Jos., and Sons 1 1 0

Dyson, Law & Son. 1 1 0

Eastwood, Fredk. . 1 1 0

Foster (Surgeon) . 1 1 0

Gledhill, L., and Co. 1 1 0

Graham, Major . 1 1 0

Haigh, Allen 1 1 0

Haigh, W. R., J.P. . 1 1 0

Hale, T. 1 1 0

Harrop, John 1 1 0

Harrop, Wm. 1 1 0

Heron, Charles 1 1 0

Hirst, Ben. 1 1 0

Hirst, T. E. 1 1 0

Holliday, R. & Sons. 2 2 0

Hughes, Edward, F.R.I.B.A. 1 1 0

Huth and Fischer . 1 1 0

Kaye, John, J.P. . 1 1 0

	£.	s.	d.
Keizhley, C. W.	1	1	0
Keighley, T. B.	1	1	0
King, Wm.	1	1	0
Knight, G. T. (New York).	1	1	0
Laycock, J. C.	1	1	0
Learyod, C. W.	1	1	0
Learyod, S. (Sol.) . 1	1	0	
Leibreich & Beardsell 1	1	0	
Lockwood, B.	1	1	0
Lockwood, Bros.	1	1	0
Lodge, J.	1	1	0
Lowenthal Bros.	1	1	0
Mallinson, W.	1	1	0
Martin, Sons and Co. 2	2	0	
Midgley, D. & Sons. . 2	2	0	
Norton, Thos., J.P. . 1	1	0	
Savery, F. P.	1	1	0
Schofield, B.	1	1	0
Scott, Wm., M.D.	1	1	0
Shaw, J. W. and H. . 1	1	0	
Skilbeck, R., J.P. . 1	1	0	
Starkey, Bros.	5	0	
Sykes, E., & Sons (Gosport). 2	2	0	
Sykes, J. N., J.P. . 1	1	0	
Sykes, John & Sons. 1	1	0	
Taylor, J. & Sons . 2	2	0	
Terry, Henry, & Co. 1	1	0	
Thompson, G.	1	1	0
Tickle, J. B. (Fixby Park) 2	2	0	
Tinker, C. S.	1	1	0
Tinker, Henry	1	1	0
Tomlinson, Mrs. G. W. 1	1	0	
Turner, John	1	1	0
Vickerman, B. and Sons 1	1	0	
Walker, A., J.P.	1	1	0
Watkinson, James, & Sons. 2	2	0	
Wilkinson, John, & Son. 1	1	0	
Willans, J. E.	1	1	0
Wilson and Price.	1	1	0
Woodhead, Mrs. E. B. 1	1	0	
Wrigley, John, and Sons 1	1	0	
Total	£109	5	0

HULL BRANCH.

Chairman—
Dr. LAMB.

Honorary Secretary—
WILLIAM DYSON, Esq.

Annual Subscriptions.

Allison Bros. Messrs. - 10 6

Atkinson, H. J. Esq. - 10 0

Bach & Co. Messrs. T. - 10 6

Bedell, Benj. Esq. 1 1 0

Bitton and Co. Messrs. J. 1 1 0

Boden & Co. Messrs. J. - 10 6

Briggs, Henry, Esq. - 10 6

Broadley, W. H. H., M.P. 1 1 0

Brochner and Co. Messrs. C. C. 2 2 0

Buckton and Sons, Messrs. Geo. 10 6

Bulmer and Field, Messrs. 10 6

Burstall and Huffam, Messrs. 10 6

Burwell, W. 1 1 0

Carrick, Theo. Esq. 10 6

Carver & Co. Messrs. - 10 6

Chambers and Fargus, Messrs. 10 0

Cooke, Miss. 10 0

Coulthard, J. Esq. 10 6

Davis, E. and Co. 2 2 0

Des Forges & Sons, Messrs. 10 6

	£.	s.	d.
Dyson, W. Esq., Hon. Sec.	10	6	
Earle, Messrs. G. & T.	10	0	
Earle and Haller, Messrs.	1	1	0
Easten & Sons, Messrs. John	10	0	
England, Saxelbyes, & Sharpe, Messrs. . 1	1	0	
English, Miss.	10	6	
Foster & Co. Messrs. John	10	6	
Gibson and Son	10	6	
Gleadow and Dibb . 1	1	0	
Good, Flodman, & Co. 1	1	0	
Grottrian, F. B. Esq.	10	6	
Hall and Co. Messrs. J.	1	1	0
Hammond, Emes, and Co. Messrs.	10	6	
Hardy, George, Esq.	10	6	
Harrison Brothers . 1	1	0	
Hart, G. W. Esq.	10	6	
Helmsing and Son . 10	6		
Hewetson, Misses . 10	6		
Hill, J. H. Esq.	10	6	
Hill, Messrs. James T. and N.	1	1	0
Hirst and Cooke	10	6	
Holmes, T. B. Esq.	10	6	
Hornstedt and Garthorne, Messrs.	1	1	0
Horsley, Smith, & Co.	1	1	0
Jameson, Robt. Esq. . 1	1	0	
Joy and Sons, Messrs. Wm.	1	1	0
Keighly, Maxsted, & Co. Messrs.	1	1	0
King & Co. Messrs.	10	6	
King, W. R. Esq.	2	2	0
Knyppers, Ostler, and Scott.	10	6	
Lambert, S. Esq.	10	6	
Lonsborough, Lord, The Right Hon.	10	0	
Malcolm and Son, Messrs. George	10	6	
Marillier, P. A. Esq. - 10	6		
Marris, Willows, and Smith, Messrs.	10	6	
Marshall, W. T.	10	6	
Martin, R. Esq.	10	0	
Mason, B. B. Esq.	10	6	
Mason, Capt. W. S. . 10	6		
Mason, Mr. Wright. - 10	6		
Massey and Sawyer. - 10	6		
Maw, Thil, Kirke & Co., Messrs.	1	1	0
Moss, J. S. Esq.	10	6	
Newton Bros. Messrs. - 10	6		
Norwood, C. M. Esq. M.P.	2	2	0
Pauling, A. Esq.	10	6	
Peasegood, W. Esq. - 10	6		
Pease and Sons, Messrs.	2	2	0
Pope and Pearson . 1	1	0	
Rayment & Sharpe - 10	6		
Rawson, W. and J. Robitson, Messrs. - 10	6		
Reckitt and Sons, Messrs. Isaac.	1	1	0
Ripon, Right Hon. the Marquis of . 2	2	0	
Seaton, J. L. Esq.	10	0	
Shaw and Pearson . 10	6		
Sissons Brothers and Co. Messrs.	1	1	0
Smith Brothers and Co. Messrs. S.	2	2	0
Smith, Hill, and Co. 1	1	0	
Smith, H. Esq.	1	1	0
Smith, Miss.	10	6	
Smith, W. N. Esq. - 10	6		
Storry, Smithson, & Co. Messrs.	1	1	0
Storry, Witty, & Co. - 10	6		
Sutton, W. Fowler - 10	6		
Tealby & Co. Messrs. 1	1	0	
T. W. R. per Rev. H. L. R. Deck.	1	0	0

Table of donors and amounts for the Sheffield Branch, including names like Hunter, Mr. Wm., Ingham, Mr. W., and various amounts in £, s., and d.

Table of donors and amounts for the Wakefield Branch, including names like Dacketts, Mr. E., Edgar Dr., and various amounts in £, s., and d.

Table of donors and amounts for the Staithe's Branch, including names like Gilmour, D. and Co., and various amounts in £, s., and d.

Table of donors and amounts for the Whitby and Up-Gang Branches, including names like Alder, Thos. and Son, and various amounts in £, s., and d.

FRASERBURGH BRANCH.

Patron—
The Right Hon. the Lord Saltoun.

Treasurer & Hon. Sec.—
ANDREW TARRAS, Esq.

Annual Subscriptions.

Table with columns £. s. d. listing names and amounts for Fraserburgh Branch.

Total 36 15 6

Donation.

Table with columns £. s. d. listing donations for Fraserburgh Branch.

£41 15 6

NEWBURGH BRANCH.

President—
JOHN H. DUNN, Esq.

Hon. Secretary—
MR. P. MURRAY.

Annual Subscriptions.

Table with columns £. s. d. listing names and amounts for Newburgh Branch.

Total 12 12 0

Donations.

Table with columns £. s. d. listing donations for Newburgh Branch.

£18 9 4

PETERHEAD BRANCH.

Treasurer—
Wm. Baxxex, Esq.

Honorary Secretary—
WILLIAM BOYD, Esq., F.R.S.E.

Annual Subscriptions.

Table with columns £. s. d. listing names and amounts for Peterhead Branch.

Table with columns £. s. d. listing names and amounts for Fraserburgh Branch (continued).

£66 8 0

WHITELINK BAY BRANCH.

President—
REV. W. WILLIAMSON.

Honorary Secretary—
MR. A. J. BURNS.

Annual Subscriptions.

Table with columns £. s. d. listing names and amounts for Whitelink Bay Branch.

Total 27 16 0

Argyllshire.

CAMPBELTOWN AND SOUTHDEN (CANTYRE) BRANCH.

Patron—
His Grace the DUKE OF ARGYLL, K.T., V.P.

President—
PROVOST COLVILLE.

Honorary Secretary—
MR. A. MITCHELL, H. M. Customs.

Annual Subscriptions.

Table with columns £. s. d. listing names and amounts for Campbeltown and Southden Branch.

Table with columns £. s. d. listing names and amounts for Fraserburgh Branch (continued).

Total 37 15 6

Donations.

Table with columns £. s. d. listing donations for Fraserburgh Branch.

£39 3 1

Ayrshire.

ARDROSSAN BRANCH.

Treasurer and Honorary Secretary—
JOHN CRAIG, Esq.

Assistant-Secretary—
R. L. ALPINE, Esq.

Annual Subscriptions.

Table with columns £. s. d. listing names and amounts for Ardrrossan Branch.

Table with columns £. s. d. listing names and amounts for Fraserburgh Branch (continued).

Sundry Donations ... 2 16 9

Total £42 0 9

AYR BRANCH.

Chairman—

WILLIAM KILPATRICK, Esq. Provost of Ayr.

Treasurer—
J. McHURCHON, Esq.

Honorary Secretary—
JOHN POLLOCK, Esq.

Annual Subscriptions.

Table with columns £. s. d. listing names and amounts for Ayr Branch.

Total £51 3 6

BRANCHES—LIST OF ANNUAL SUBSCRIPTIONS AND DONATIONS. 155

BALLANTRAE BRANCH.

Patron—
JAMES HUNTER, Esq.,
Glenapp.

President—
Rev. F. J. WILLIAMSON.

Honorary Secretary—
Mr. JAMES COWPER.

Annual Subscriptions.

£. s. d.	
Hunter, James, Esq.	2 2 0
McConnell, W. Esq.	1 1 0
Olliver, George, Esq.	2 2 0
Onslow, Arthur	
Hughes, Esq.	2 2 0
Moore, J. Carrick, Esq.	2 0 0
Stair, The Earl of	2 2 0
Total	11 9 0

Donations.

Box contributions	- 10 1
Phillips, Mr. John	- 5 0
Total	£12 4 1

GIRVAN BRANCH.

Patron—
The Right Hon. the EARL OF
STAIR, K.T.

Treasurer—
ALEXANDER MARTIN, Esq.

Honorary Secretary—
WILLIAM FORSYTH, Esq.

Annual Subscriptions.

Alexander, Col., M.P.	2 2 0
McConnell, William	
of Knockdolian	1 1 0
Hamilton, Hugh, of Pinnore	1 0 0
Stair, the Right Hon. Earl of (two years)	2 2 0
Smith, Mrs., Lady- bank	1 0 0
Total	£7 5 0

IRVINE BRANCH.

President—
JOHN WRIGHT, Jun., Esq.,
Provost.

Vice-Presidents—
Capt. DAVID BOYLE, R.N.,
of Shewalton &c.
JOHN PATERSON, Esq., of
Knowhead.

Honorary Secretary—
JAMES DICKIE, Esq.

Annual Subscriptions.

Alexander, Hugh	- 10 0
Alston, Chas. H.	1 1 0
Armour James	- 5 0
Begg, J. S.	- 6 0
*Boyle, Capt, R.N.	2 0 0
Boyd, H. F.	1 1 0
*Brown, Geo.	1 1 0
*Brown, Capt. James	- 5 0
Brown, J. G.	1 1 0
Caldarwood, A.	- 5 0
Christie, Wm.	- 5 0
Clark, Capt.	- 10 0
Conuar and Miller	- 5 0
Drummond, J.	- 6 0
Eglinton, Earl of	3 3 0
Eglinton Chemical Co., Limited	3 2 0

£. s. d.	
Finn, Archibald, Springhill	1 1 0
Friend	- 5 0
Galloway, Andw. C.E.	- 5 0
*Gilmour, Alexander	- 10 0
*Gorman, C. S.	- 10 0
Green, Mrs.	- 5 0
Hamilton, Alexander	- 5 0
Harbour Forge Co.	- 5 0
Henderson and Co. Wm.	3 3 0
Highet, H. M.	- 5 0
Holmes, Miss	- 5 0
Irvine Forge Comp.	- 5 0
Jaffrey, Mrs.	1 1 0
Johnston, John	- 5 0
Lindsay, J. B.	- 5 0
*Longmuir, Alex.	- 10 6
Macredie, Mrs. Mure, of Perceiton	- 10 0
Marr, Capt.	- 5 0
*McGilvray, James	- 5 0
McKinlay, William	- 5 0
*Morris, Capt. A. F.	- 10 0
*Paterson, John, Knowhead	- 10 6
*Pipe, James	- 5 0
Rose, Mrs.	- 5 0
Ross, Z. M. H.	- 10 0
Sommerville, Rev. Jas.	- 5 0
Stewart, A. M.	- 5 0
*Stewart, James	- 10 0
Stewart, T. R.	- 5 0
Walker, Alex.	- 5 0
*Wright, John, Jun.	- 5 0
Young, Capt.	- 5 0
Sums under 5s.	7 13 0
Total	£37 9 0

TROON BRANCH.

Honorary Secretary—
ALEXANDER WYLLIE, Esq.

Annual Subscriptions.

Alexander, Col., M.P.	2 2 0
Alexander, Dr.	- 10 0
Cowan, Rev. A. H.	- 10 0
Craig, J. & M.	1 0 0
Cook, Duncan	- 10 0
Cunningham, W. S.	1 0 0
Eglinton Iron Co.	2 0 0
Finnie, Archd.	2 0 0
Finnie, Miss	- 10 0
Fleming Rev. James	- 10 0
Galloway, John	1 0 0
Gillies, James	- 10 0
Gilmour, Allan	1 0 0
Houldsworth, W. H.	1 1 0
Kirkwood, Rev. J.	- 10 0
Logan, Jno.	- 10 0
Portland, Duke of	2 2 0
Troon Shipbuilding Company	1 0 0
Wood, James	1 0 0
Total	£19 5 0

Donations.

Boxes at Boat-house, &c.	1 0 6
Sums under 5s.	3 13 0
Bank interest	- 6 9
Total	£26 18 3

Banffshire.

**BANFF AND
MACDUFF BRANCH.**

President—
The EARL OF FIFE, K.T.

Chairman—
JAMES WILLIAMSON, Esq.,
Provost of Banff.

Deputy Chairman—
JAMES MARTIN, Esq.,
Provost of Macduff.

Treasurer and Hon. Sec.—
JAMES WATT, Esq.

Annual Subscriptions.

£. s. d.	
Fife, Earl of	10 0 0
Seafield, Earl of	1 0 0
Abercromby Sir R. Bt.	1 0 0
A. Asher, Esq., M.P.	1 0 0
Banff Shipping	3 7 0
Bryson, W. G. Esq.	- 5 0
Campbell, Colonel	1 0 0
Coutts, Ex-Provost	- 5 0
Cumming, Geo. Esq.	- 5 0
Cumming, Colonel Gordon	1 1 0
Diggens, Mrs.	- 5 0
Duff, Hon. G. Skene	1 0 0
Duff, R.W. Esq. M.P.	1 0 0
Duff, Major Gordon	1 0 0
Forbes, Colonel	- 10 4
George, Alex. Esq.	- 5 0
Gordon, C.W. R. Esq.	- 5 0
Hannay, John, Esq.	- 5 0
*Hodge, Capt.	- 5 0
Hunter, Rev. Wm.	- 5 0
McConnachie & Iron- side	- 5 0
Macduff, Cmercl. Co.	- 5 0
Macduff Shipping	5 0 0
*Maclarane, Alex. Esq.	- 5 0
Manson, Dr.	- 5 0
*Martin, Provost	- 5 0
Milne, Dr.	- 5 0
Moncrieff, Sheriff Scott	- 5 0
Morison, Mrs. of Bog- nie	2 0 0
Nisbet and Co.	- 5 0
Russell, Trustees of late Misses	5 0 0
Simpson, J. Esq.	- 5 0
Stronach, Wm. Esq.	- 10 0
Taylor, W. J. Esq.	1 0 0
Walker, Rev. George	- 5 0
Watt, Alex. Esq.	- 5 0
*Watt, Capt. James	- 5 0
*Watt, G. N. Esq.	- 5 0
Wilson, Major	1 0 0

Banffshire.

BUCKIE BRANCH.

President—
The Right Hon. the EARL
OF SEAFIELD.

Chairman—
W. R. DUGUID, Esq., M.D.

Honorary Secretary—
JOHN SHEARER, Esq.

Donations.

£. s. d.	
Box at Boat House	- 5 2
Box at Harbour	
Office	1 8 9
Proceeds of Concert	4 10 0
Russel's Trust, Misses	5 0 0
Sums under 5s.	1 5 0
Total	£12 8 11

Derwickshire.

EYEMOUTH BRANCH.

President—
Lieut.-Col. MILNE HOME, of
Wedderburn, M.P.

Vice-President—
JAMES GIBSON, Esq.
of Gungreen.

Treasurer—
Mr. JOHN DICKSON,
Fish Curer.

Honorary Secretary—
Mr. ANDREW WHILLIE,
Commercial Bank.

Annual Subscriptions.

*Gibson, James, Esq.	- 10 0
Hamilton, The Hon. R. Baillie	5 0 0
*Home, Col. Milne, M.P.	5 5 0
Home, Miss	1 1 0
Mack, J. S., Esq.	1 1 0
Marjoribanks, Hon. E., M.P.	5 0 0
Romanes, Robert, Esq.	1 1 0
Swinton, A. Campbell, Esq.	1 0 0
Total	£19 18 0

Donations.

Clapham, E., Esq.	1 0 0
*Dougall, James, Esq.	0 10 0
Home, D. Milne, Esq.	1 0 0
Hume, J. A. Ross, Esq.	2 0 0
Sandison, M., Esq.	2 2 0
Turnbull, Miss	1 0 0
Boxes, &c.	- 5 3
Total	£27 15 3

Buteshire.

ISLE OF ARRAN BRANCH.

Honorary Secretary— PATRICK MURRAY, Esq.

Annual Subscriptions.

Table with 2 columns: Name, Amount (£. s. d.). Includes McMillan, William (10 0) and Murray, Patrick (10 0).

Total£1 0 0

Donations.

Table with 2 columns: Name, Amount (£. s. d.). Lists numerous donors including A. H. W., Allan, James, and others.

Total Dons.38 5 7
Total Subs. 1 0 0
£39 5 7

Caitness-shire.

HUNA BRANCH.

President— PETER KERR, Esq. Barrogill Castle.

Honorary Secretary— MR. D. DUNNETT.

Annual Subscriptions.

Table with 2 columns: Name, Amount (£. s. d.). Includes Caithness, The Rt. Hon. the Earl of.

Donations. Boxes at Huna Hotel & Life-boat House - 9 0. Total£3 7 4

THURSO BRANCH.

Patron— SIR J. G. T. SINCLAIR, BART., M.P.

Treasurer— JAMES BRIMS, Esq.

Honorary Secretary— JOHN COGHILL, Esq.

Annual Subscriptions.

Table with 2 columns: Name, Amount (£. s. d.). Lists numerous donors including Brims, James, and others.

Total£9 3 0

Donations.

Table with 2 columns: Name, Amount (£. s. d.). Includes Contribution Box in Royal Hotel (6 6).

Total Dons.....13 14 7
Total Subs..... 9 3 0
£22 17 7

WICK AND ACKER-GILL BRANCH.

President— G. DUFF DUNBAR, Esq.

Honorary Secretary— GEORGE M. SUTHERLAND.

Annual Subscriptions.

Table with 2 columns: Name, Amount (£. s. d.). Lists numerous donors including Bremner, Mrs., Har- bour Inn.

Table with 2 columns: Name, Amount (£. s. d.). Includes McLennan, Malcolm (10 6) and Nicol, James (5 0).

Donations. Contribution Box at McEwan's Works (2 1 11). Do. at Commercial Bank and Custom House (6 3). Total£20 9 8

Clackmannanshire

ALLOA BRANCH.

Honorary Secretary— DAVID BARRY, Esq.

Honorary Collector— MR. ALEX. GARDEN.

Annual Subscriptions.

Table with 2 columns: Name, Amount (£. s. d.). Lists numerous donors including Aberdeen, Dowager Countess of.

Table with 2 columns: Name, Amount (£. s. d.). Includes Paton, J. Son & Co. Messrs. (1 1 0) and Porteous, Archd. Esq. (5 0).

Edinburgh.

DALKEITH BRANCH.

President— ALEXANDER MITCHELL.

Vice-President— WILLIAM PORTEOUS.

Treasurer— JOHN CRAIG.

Secretary— ALEX. BALLANTYNE, M.D.

Annual Subscriptions.

Table with 2 columns: Name, Amount (£. s. d.). Lists numerous donors including A Friend, Ballantyne, Alex. M.D. (10 0).

Total.....£ 8 9 0

EDINBURGH, LEITH, AND GRANTON BRANCH.

Chairman— Adm. SIR ALEXANDER MILNE, BART., G.C.B.

Honorary Secretary— ROBERT SINCLAIR, Esq., 16 Waterloo Place.

Annual Subscriptions.

Table with 2 columns: Name, Amount (£. s. d.). Lists numerous donors including A. H., A. P. N.

BRANCHES—LIST OF ANNUAL SUBSCRIPTIONS AND DONATIONS. 157

£.	s.	d.	£.	s.	d.	£.	s.	d.	£.	s.	d.
Addie, G., Esq.	10	0	Bow, R. H. Esq.	10	0	Cornwall, Misses	5	0	Edinburgh and Leith		
Agnew, Capt. R.N.	10	0	Boyd, Sir Thomas J.	1	0	Corrie, Hanson, & Co.			Brewery Co.		5 0
Aikman, Arch., and Co.	5	0	Boyd, Thomas, Esq.	1	0	Messrs.	1	1	Edmonston, Thomas,		
Ainstie, Colonel	5	0	Braidwood & Fowler,			Cousin, Mrs.	5	0	Esq.		10 0
Aitchison and Co. Messrs. John	10	0	Brakenridge, Mrs.	5	0	Cowan and Co. Messrs.	5	0	Edmonstone, Sir Wm.		
Aitken and Wright, Messrs.	1	1	Bramwell, Byrom,			Cowan and Strachan,			Bart., M.P.		1 0 0
Aitken and Co. Messrs. James	5	0	Esq. M.D.	5	0	Messrs.	10	0	Edwards, H. C. Esq.		10 0
Alison, Mrs. A. & Alexander and Son, Messrs.	5	0	Bringloe, Francis A. Esq.	5	0	Cowan, John, Esq.	1	0	Ellis, W. M. Esq.		10 0
Allan, Mrs.	5	0	Brodie, Hamilton, and Co. Messrs.	5	0	Cowan, Miss	5	0	E. M. B.		5 0
Allan, T. C. Esq.	5	0	Brodie, J. Clerk, Esq.	1	0	Cowan, J., Esq., W.S.	5	0	E. M. M.		1 0 0
Anderson, Misses	1	0	Brodie, T. D. Esq.	10	0	Cowper, Mrs.	5	0	E. T.		5 0
Anderson, Mrs.	10	0	Brotchie & Co. Messrs. R.	1	0	Cowper, Mrs. C. M.	5	0	Fairbairn, Mrs.		5 0
Anderson, Mrs.	5	0	Brown, Dr. Crum	5	0	Craig & Rose, Messrs.	5	0	Falconer, Miss		1 0 0
Anderson, Mrs. John	5	0	Brown & Son, Messrs. H.	5	0	Crawford, Messrs. A. and A.	10	6	Farmer, Mr. John		5 0
Anderson and Williamson, Messrs.	5	0	Bruce, Geo. Esq.	5	0	Crudellus, Hirst, and Co. Messrs.	10	0	Fenwick, Bruce, Esq.		5 0
Annamdale, Mrs.	5	0	Bruce, Miss	10	0	Cruikshank and Son, Messrs.	5	0	Fergus, Mr. William		5 0
Anstey, Miss (the late)	10	0	Bruce, Miss	5	0	Cruikshanks & Son, Messrs.	5	0	Ferguson, Davidson, and Co. Messrs.		1 1 0
Austin, Mrs.	5	0	Bryce, Mrs. Moir	5	0	Cunningham and Sons, Messrs.	10	0	Ferguson and Co. Messrs. Thomas		5 0
Baldon, H. B. Esq.	5	0	Bryden and Son, Messrs. W.	5	0	Cunningham, George, Esq.	2	2	Ferguson, W., Esq.		5 0
Baillie & Co. Messrs. T.	5	0	Bryson and Son, Messrs. R.	5	0	Cunningham, Messrs. J. and J.	10	0	Finlay, J. R. Esq.		1 1 0
Bain, G. Esq.	5	0	Burn and Son, Messrs. G.	5	0	Cunyngham, Hon. Lady Dick	5	0	Finlay, William, Esq.		5 0
*Baird, Sir Jas. G.	1	0	*Burnley, W. F. Esq.	1	0	Currie and Co. Messrs. James	1	1	Finlayson, Mrs.		1 0 0
Balfour, A., M.D.	5	0	Burns, Geo. Esq.	5	0	Cuthbert, Miss	5	0	Finnie, Miss		5 0
Balfour, J. H. Esq.	5	0	Byres, Mrs. Genl.	5	0	Dalglish, Mrs.	5	0	Finnie, Mrs.		5 0
Balfour, Dr. A. G. Thomas	5	0	Callander and Sons, Messrs. David	1	0	Dalgety, Misses	5	0	Fleming, J. Esq.		5 0
Balfour, Mrs.	5	0	Callender, Miss	5	0	Dalziel, George, Esq.	10	0	Fletch, Mrs.		5 0
Ballantyne, Hanson, and Co. Messrs.	5	0	Campbell, A. Esq.	10	0	*Davidson, Lieut.-Col. H.E.I.C.S.	10	0	Forrest & Turnbull, Messrs.		5 0
Ballantine and Son, Messrs. Geo.	5	0	Campbell, A. Esq.	1	0	Davidson, Pirrie, and Co. Messrs.	5	0	Forbes, Miss		5 0
Barbour, G. F. Esq.	1	0	Campbell, Mrs.	5	0	Davis and Primrose, Messrs.	5	0	Forbes, Mrs.		5 0
Barclay, Rev. J.	5	0	Capper, J. J. Esq.	1	0	Dempster, Mrs.	5	0	Ford & Co. Messrs. John		5 0
Barclay, Mrs.	5	0	Carron Iron Co.	5	0	Deuchar, David, Esq.	1	0	Ford & Sons, Messrs. W.		1 1 0
Barthill, Mrs.	5	0	Carruthers, P. Esq.	1	0	Dick, John, Esq.	5	0	Forryth, Mrs.		10 0
Barrett, Mrs.	5	0	Carswell, Mr.	5	0	Dick, John, Esq.	5	0	Fraser, Mrs.		10 0
Barrow, Mrs.	5	0	Cathcart, Mrs.	5	0	Dickson, D. S. Esq.	10	6	Fraser, Mrs.		5 0
Barry, Mr. John	5	0	C. E. M.	5	0	Dickson and Co. Messrs. James	10	0	Friend, A.		1 1 0
Barstow, C. M. Esq.	5	0	Chalmers, Mrs.	5	0	Dickson and Walker, Messrs.	5	0	Friends		5 0
Barton, Mrs. D.	10	0	Chambers, Messrs. W. Thomas	5	0	Dickson, Sam. Esq.	1	0	Friends, Two		5 0
Baxter, E. Esq.	1	0	Chapman, Mrs.	5	0	Dickson, Wm. Esq.	5	0	Fulton & Co. Messrs. J.		1 1 0
Bayley, Mrs.	5	0	Cheape, Hon. Mrs.	5	0	Dickson, Wm. Esq.	5	0	Gall, Misses		5 0
Beattie and Sons, Messrs. W.	5	0	Cheape, Misses	5	0	Dickson and Co. Messrs. James	10	0	Gall and Inglis, Messrs.		5 0
Beilby, J. H. Esq.	1	0	Chiene, George Todd, Esq.	5	0	Dickson and Walker, Messrs.	5	0	Galtie, Laird, and Co. Messrs.		5 0
Belcombe, Rev. Mr.	5	0	Chisholm, David, Esq.	5	0	Dickson, Sam. Esq.	1	0	Galloway, Mrs. John		1 0 0
Bell, James & Co., Messrs.	5	0	Chisholm, David, Esq.	5	0	Dickson, Wm. Esq.	5	0	Geddes, Mrs.		5 0
Bell, Miss A. M.	5	0	Chisholm, Mrs. G.	5	0	Dickson and Co. Messrs.	5	0	Geddes, Miss, Col. by		5 0
Bell, Mrs.	5	0	Christall, Mrs.	5	0	Donaldson, A. Esq.	5	0	Cornfute, Miss		5 0
Bell, Mrs. Glassford, & Miss Sandeman	10	0	Christie and Kilpatrick, Messrs.	5	0	Douglas, Francis Brown, Esq.	10	0	Craigie, Mrs.		5 0
Bell, Rannie, and Co. Messrs.	1	1	Christie, W. Esq.	5	0	Douglas, Mrs.	5	0	Friend, A.		5 0
Bell, W. Esq.	1	1	Christie, Mrs. S.	5	0	Douglas, Misses	5	0	Geddes, Mr. R.		1 0 0
Bernard and Co. Messrs.	10	6	Christison, David, Esq. M.D.	1	0	Douglas, Miss	10	0	Geddes, Mrs. A.		5 0
Bernard, Messrs. T and J.	10	0	Christison, John, Esq. W.S.	10	0	Dowden, Mrs.	5	0	Gloag, Miss		5 0
Berry, Barclay, and Co. Messrs.	1	1	Church, Dr.	5	0	Downie and Laird, Messrs.	5	0	Green, Mrs. Col.		5 0
Berry, Mrs.	10	0	*Clapperton, John, Esq.	1	0	Drummond Brothers, Messrs.	5	0	Milne, Mrs. W.		5 0
Bertram, Geo. & Wm. Messrs.	10	0	Clark, Alexander, Esq. Clark, Hon. Lord	1	0	Drummond, Mrs. D. T. K.	10	0	Turnbull, Mrs.		10 0
Bertram & Son, Messrs. James	5	0	Clark, Rutherford, Esq.	2	0	Drybrough, John, Esq.	5	0	Sums under 5s.		1 15 6
Bevan, Mrs.	10	0	Clark and Pinkerton, Messrs.	5	0	Drybrough and Co. Messrs.	5	0	Gibson and Co. Messrs. George		1 1 0
Beveridge, J. A. Esq.	1	0	Cockburn, Alexander, Esq.	10	0	Dudgeon, Mrs.	5	0	Gibson, Messrs. R. and T.		10 6
Beveridge, Miss	10	0	Cockburn and Co. Messrs.	1	1	Duncan, Flochart, and Co. Messrs.	10	0	Gibson and Walker, Messrs.		1 1 0
Black, Messrs. A. & C.	10	0	Collie, Mrs.	5	0	Duncan and Co. Messrs. James	5	0	Gibson's Heirs, H. C.		5 0
Blackhall Brothers, Messrs.	10	0	Colquhoun, John, Esq.	5	0	Duncan, Miss	5	0	Gibson, Thomas, Esq.		10 0
Blackwood, Mrs.	5	0	Cook, Misses	10	0	Duncan, Mrs.	5	0	Gibson, Thomas, Esq.		5 0
Blackwood, Miss	5	0	Constable, Messrs. T. and A.	5	0	Duncan, H. Macduff, Esq.	5	0	Gillespie, Mrs.		5 0
Blair, A. Esq.	5	0			Duncan, Dr. Kirk Dundas, Miss Hamilton	1	0	Gillespie, Dr.		5 0	
*Blyth, E. L. I. Esq.	10	0			Dunn, J. W. Esq.	5	0	Gillespie, Dr. Cathcart, Messrs.		2 2 0	
Bogil, Mrs.	5	0			Dunsinure, Dr.	5	0	Gilton & Co. Messrs. John		10 6	
Bolton, David, Esq.	5	0			Dymock and Guthrie, Messrs.	5	0	Gilmour, Messrs. W. and O.		5 0	
Bonar, Mrs. Thomas	5	0			Dymock, Jas. R. Esq.	10	0	Gilroy, G. Esq.		5 0	
Bonnar and Carfrae, Messrs.	10	0			Edinburgh Roperie Co., Messrs. the	1	1	Gordon, Robert, Esq.		5 0	
								Gordon, Mr.		5 0	
								Gordon, Mrs.		5 0	
								Gow, Alex. Esq.		5 0	
								Gray, Mrs. A.		5 0	
								Gray and Son, Messrs. James		5 0	
								Gray, Robert, Esq.		5 0	

£.	s.	d.	£.	s.	d.	£.	s.	d.	£.	s.	d.
Gronmeyer, Richard, Esq.	5	0	Law, Messrs. W. & G.	10	0	Millar & Co., Messrs.	5	0	Rankin, George	5	0
Hadden and Son, Messrs. R.	5	0	Leadbeater, Mrs.	5	0	Millar Bros., Messrs.	10	0	Redpath, Brown, and Co. Messrs.	10	6
Hagart, T. C. Esq.	5	0	Learmonth, Mrs.	5	0	Millar, Mrs. John	5	0	Reid, William, Esq.	10	0
Haldane, Mrs.	10	0	Learmonth, Mrs. L.	5	0	Miller and Sons, Messrs. James	1	0	Renny, Chas. Esq.	10	0
Haldane, Mrs.	5	0	Leak, J. B. Esq.	10	0	Miller, John, Esq.	1	0	Renton, W. Esq.	5	0
Halkett, Lady	5	0	Lees and Co. Messrs.	5	0	Miller, R. Esq.	1	0	Rhind, D. A. & Co. Messrs.	5	0
Hall, Dunbar, & Co.	5	0	John	10	0	Miller, Mrs. H.	5	0	Richardson and Co. Messrs. Francis	5	0
Hamilton, Claud H., Esq.	10	0	Lennie, E. Esq.	5	0	Milne & Sons, Messrs. J.	10	0	Richardson, Mrs.	5	0
Hamilton, H. Esq.	5	0	Leslie, James, Esq.	5	0	Mitchell, and Co. Messrs. J.	5	0	Richardson, Mrs.	5	0
Handasyde, C. H. Esq.	5	0	Leslie, Miss	10	0	Moir, Mrs.	5	0	Richardson, Robert, Esq.	1	0
Hardie, Messrs. J. & W.	5	0	Lewis, John, Esq.	1	0	Moncrieff, J. Scott, Esq.	5	0	Ritchie, A. Esq.	5	0
Harrison and Co. Messrs.	10	6	Lewis, Mrs.	5	0	Moncrieff, W. Esq.	5	0	Ritchie, George, Esq.	10	0
Harvey, R. E. Esq.	10	6	Lindesay, Colonel	1	0	Montgomery, The Very Rev. J. F.	5	0	Ritchie and Sons, Messrs. James	5	0
Harvey, Mrs. G. M.	5	0	Lindsay and Son, Messrs. James	5	0	Mood, Mrs. J.	5	0	Robertson Brothers, Messrs.	1	0
Hawthornes and Co., Messrs.	1	0	Livingstone & Weir, Messrs.	1	0	Moore Lady/Elizabeth	0	0	Robertson, C. S. Esq.	1	0
*Hay, Admiral	5	0	Lockhart, Mrs.	5	0	Mooreland Lodge	5	0	Robertson, Messrs. J. and D.	5	0
Hay, and Co. Messrs. James	10	0	Lodder, Capt. R.N.	5	0	More, Mrs.	5	0	Robertson, Miss	5	0
Hay, D. Esq.	10	0	London & Edinburgh Shipping Co.	1	0	Morison, Patrick G. Esq.	5	0	Robertson, Sanderson and Co. Messrs.	5	0
Hay, H. S. A. Esq.	10	0	Lothian, Miss	5	0	Morrison, Messrs. J. and G.	10	6	Robertson, Mr.	5	0
Hayward, Robt. Esq.	5	0	Low, Robertson, and Co. Messrs.	5	0	Morrison, Messrs. J. and J.	5	0	Robertson, Mrs.	10	0
Henderson, Miss	5	0	Lyon and Turnbull, Messrs.	10	0	Morrison, R. M. Esq.	5	0	Robinow, Major/banks, and Co. Messrs.	1	0
Henderson, Miss	5	0	Macandrew, Jas. Esq.	5	0	Morton, Mr.	5	0	Rollo, H. J. Esq.	5	0
Henderson, Mrs.	10	0	Macdonald Robertson, Misses	5	0	Muir & Son, Messrs. J.	5	0	Romanes & Paterson, Messrs.	5	0
Henry, Alex. Esq.	5	0	Macduff, Mrs.	5	0	Muir, Lord	5	0	Romanes, Mrs.	5	0
Henry, John, Esq., S.S.C.	1	0	Macfarlane and Co. Messrs. J. F.	10	0	Muir, Miss	5	0	Ross, Mrs. George	5	0
Hewit, Peden, & Co. Messrs.	5	0	Macfarlane, M. Esq.	10	0	Muir, Miss S.	5	0	Ross, Mrs. Ker	10	0
Hewit & Sons, Messrs.	5	0	Macfarlane and Co. Messrs. D.	5	0	Munro, J. Esq.	1	0	Roughead, Mrs., Sen.	5	0
Hill, Miss	5	0	Mackay & Co. Messrs. George	5	0	Murdoch, Dr. Burn	7	6	Russell, Mrs.	5	0
Hill, Thomson, and Co. Messrs.	5	0	Mackenzie, Colin, Esq.	5	0	Murray, George, Esq. C. A.	5	0	Rutherford and Co. Messrs.	10	0
Hill, W. Scott, Esq.	10	0	Mackenzie, John Ord, Esq.	10	0	Murray, Miss	5	0	Rutherford, D. G. Esq.	5	0
Hill, Mrs.	10	0	Mackenzie, Miss	10	6	Murray, R. Esq.	5	0	Salveson, Mrs. T.	5	0
Hodge, Mrs. Charles	5	0	Mackenzie, Miss	5	0	Murray, Str Patrick Keith, Bart.	2	0	Sampson, Miss	5	0
Hodge, Mrs. T.	5	0	Mackie, T. W. and Sons, Messrs.	5	0	Murray, T. G. Esq.	5	0	Sanderson, William, Esq.	5	0
Hog, Mrs.	10	0	Maclagan, Douglas, Esq.	10	0	Mylne, Mrs. J.	5	0	Sanda, Miss	1	0
Honeyman & Wilson, Messrs.	10	0	Maclagan, Mrs. D.	5	0	N. C.	10	0	Sang and Barker, Messrs.	10	0
Hope, James, Esq.	1	0	Maclod, Wm. Bowman, Esq.	10	6	Nelson and Sons, Messrs. Thomas	1	0	Scott and Anderson, Messrs.	10	6
Hope, John, Esq.	1	0	Macnair, John, Esq.	1	0	Newton, James, Esq.	5	0	Scott, A. W. Esq.	5	0
Horn, Mrs. Robert	10	0	M'Candlish, J. M. Esq.	10	0	Nicolson, D. Esq.	10	0	Scott Bros., Messrs.	5	0
Horne, T. E. O. Esq.	5	0	M'Diarmid, W. R. Esq.	5	0	Nicolson, James, Esq.	5	0	Scott, T. Esq.	5	0
Howden, Miss	3	0	M'Ewan, Wm. Esq.	1	0	Nimmo, W. Esq.	10	6	Scott, James, Esq.	5	0
Howden, J. A. Esq.	5	0	M'Farlane & Son, Messrs.	5	0	Norie, H. Henry, Esq.	5	0	Scott, Mrs.	5	0
Howden, Thos. Esq.	5	0	M'Gibbon, Mrs.	5	0	Ogilvie, G. Moncrieff, Esq.	5	0	Scottish Iron S.S. Insurance Association	5	0
Howe, Alex. Esq.	1	0	M'Gregor & Pringle, Messrs.	5	0	Olliphant, Mr. School Oliver and Son, Messrs.	5	0	Seater, White, & Co., Messrs.	1	0
*Howkins, John, Esq.	1	0	M'Intosh, J. B. Esq.	10	6	Oswald, Lady	5	0	Seggie, Alex. Esq.	5	0
Hoyes, John, Esq.	1	0	M'Pherson, Professor	5	0	Padon, Messrs. A & D.	5	0	Shand, Hon. Lord	1	0
Hunter, J. A. Esq.	5	0	M'Laren, D. & Co. Messrs.	10	0	Pagan, Mrs.	10	0	Shand, Mrs.	5	0
Hunter, James, Esq.	1	0	M'Laren, Duncan, Jun. Esq.	10	0	Pairman Brothers, Messrs.	5	0	Shepherd, Mrs.	5	0
Hunter, Robert, Esq.	1	0	M'Laren, Messrs. D. and G.	1	0	Pairman, Mrs.	10	0	Sidey, Charles, Esq.	5	0
Hutchinson Brothers, Messrs.	5	0	M'Laren, Mrs.	5	0	Paterson and Sons, Messrs.	1	0	Sim and Barclay, Messrs.	5	0
Inglis, H. M. Esq.	1	0	M'Laren, D. Esq.	10	0	Paterson, Miss	5	0	Sim, M. R. Esq.	5	0
Inglis, W. Esq.	5	0	Maitland, Miss	5	0	Paterson, J. N., and Miss	10	0	Simpson, Jno. A. Esq.	1	0
Inglis, Mrs. Halket	5	0	Maitland, Rev. W.	1	0	Paterson, Jas. Esq.	5	0	Simon, David, Esq.	5	0
Ivory, Thomas, Esq.	5	0	Marshall and Co. Messrs. W.	10	0	Paterson, Lady	10	0	Simon, Mrs.	10	0
Ivory, Miss	1	0	Marshall, Mrs.	5	0	Pattison, P. Esq.	5	0	Simon, Mrs.	5	0
Jack, J. H. H. Esq.	5	0	Marshall, Miss	5	0	Peddie, A. Esq. M.D.	5	0	*Sinclair, R.	10	6
Jamieson, Mrs.	5	0	Martin, John, Esq.	5	0	Pendrigh, W. Esq.	5	0	Simon, Messrs. R. and D.	5	0
Jamieson and Co. Messrs. Robert	5	0	Mathieson, Mrs.	1	0	Penny, Mrs.	10	0	Smith and Son, Messrs. John	10	6
J. A. S. M'D.	5	0	Melrose and Co. Messrs. A.	1	0	Pentland, Y. Esq.	5	0	Smith, J. Esq.	5	0
Jeffrey, Mrs.	10	0	Melville, Mies.	5	0	Petrie, Philip and Co., Messrs.	5	0	Smith, Messrs. T. and H.	10	0
Jenner and Co. Messrs. Charles	1	0	Melvin, Alex. & Co. Messrs.	5	0	Phillip and Son, Messrs. John	10	0	Smith, Miss C. R.	1	0
J. F.	5	0	Menzies & C. Messrs.	5	0	Pitman, F. Esq.	5	0	Smith, Mrs.	5	0
Johnson, Robt. Esq.	5	0	Menzies, John R. Esq.	10	6	Playfair, Dr.	5	0	Smith, Maj.-General		
Johnstone, Messrs. W. and A. K.	1	0			Pollock, Mrs.	5	0	Smith, W. Esq.	5	0	
Jopp, Mrs. Charles	10	0			Prevost, Colonel	10	0	Sommerville and Co. Messrs. John	10	6	
J. P.	5	0			Pringle, Robert, Esq.	10	0	Sonerville, Miss	5	0	
J. P. B.	5	0			Raeburn, Messrs. W. and J.	10	0	Spence, Mrs.	5	0	
Justice-General, The Lord	1	0			Ramsay, Geo. Esq.	1	0	Sprague, T. B. Esq.	5	0	
Kemp, Hislop, & Co. Messrs.	5	0			Rankin, Miss	5	0	Sprot, Misses	5	0	
Kennedy, John, Esq.	1	0									
Kirkpatrick, Dr.	5	0									
Knoblauch, Hugo, Esq.	5	0									
Laing, W. and Co. Messrs.	1	0									
Lancaster, Mrs.	5	0									
Laurie, Jas. D. Esq.	10	0									

BRANCHES—LIST OF ANNUAL SUBSCRIPTIONS AND DONATIONS. 159

£.	s.	d.	£.	s.	d.
Steel, Coulston, & Co.			Wenley, James A.		
Messrs.....	5	0	Esq.....	1	0
Stevens, Mrs.....	5	0	White, Burns, & Co.		
Stevens, Miss.....	10	0	Messrs.....	20	0
Stevenson, Mrs.....	5	0	White & Co. Messrs.		
Stevenson, Miss.....	10	0	R.....	5	0
Stewart, Clapperton,			White, John, Esq.....	5	0
& Co. Messrs., S.B.....	5	0	White, John, Esq.....	5	0
Stewart, Chas. Esq.....	5	0	White, Moir, & Co.....	5	0
Stewart, Messrs. J.			White, Mrs.....	5	0
and G.....	5	0	Whitten, J. C. Esq.....	5	0
Stewart, James, Esq.....	5	0	Whyte and Son,		
Stewart, John, Esq.....	5	0	Messrs. A.....	5	0
Stewart, Mrs. Grainger-			Wilson, W. S. Esq.....	10	0
Stewart, Mrs. Robert-			Wilson, Miss.....	10	0
son.....	5	0	Wilson, Mrs.....	5	0
Stirling, Mrs.....	5	0	Wilson, Mrs. Geo.....	5	0
Straton, Mrs.....	5	0	Wingate, Miss.....	2	0
Stuart, R. L. Esq.....	1	0	Wishart and Sons,		
Stuart, Miss.....	5	0	Messrs. James.....	1	1
Swan & Son, Messrs.			Wishart, D. F. Esq.....	1	0
J.....	5	0	Wood & Co. Messrs.....	5	0
Syme, Miss.....	10	6	Wood, John A. Esq.....	5	0
Sums under 5s.....	42	2	Wood, J. P. Esq.....	1	0
Tainsh, James, Esq.....	5	0	Wood, Misses.....	5	0
Taylor & Co. Messrs.			Wood, W. Esq.....	1	0
W.....	1	1	Wren, George, Esq.....	5	0
Taylor, McLeod & Co.....	5	0	Wright, Messrs. P.		
Taylor, William, Esq.....	5	0	and R.....	5	0
Taylor, Arch., Esq.....	5	0	Wright, H. Guthrie,		
Teigmouth, Lord.....	10	0	Esq.....	10	0
Tennant, R. Esq.....	10	0	Wright, Mrs.....	5	0
The Singer Machine			Young, James, Esq.....		
Manufacturing Co.....	5	0	M.P.....	5	0
Thomas, Capt. F. W.			Young, J. W. Esq.....	1	0
L., R.N.....	10	0	Young, Mrs.....	10	0
Thomson, A. Esq.....	5	0	Younger, Mrs. R.....	5	0
Thomson, Chas. W.			Younger, Robt. Esq.....	10	0
Esq.....	5	0	Younger and Co.		
Thomson & Co.			Messrs. W.....	1	1
Messrs. R. H.....	10	6	Yule, Mrs.....	5	0
Thomson and Co.					
Messrs. W.....	10	6	Total.....	400	9 10
Thomson, J. G. Esq.....	10	0			
Thomson, Miss.....	5	0			
Thomson, W. T. Esq.....	10	0			
Thomson and Co.					
Messrs. D. J.....	10	6			
Tod Bros., Messrs.....	5	0			
Tod, Henry, Esq. W.S.....	5	0			
Tod, J. H., Esq.....	10	0			
Tod, J. W. Esq.....	5	0			
Tod, Robert, Esq.....	1	1			
Torry, John, Esq.....	5	0			
Trinity House, The.....	2	0			
Trotter, Miss.....	5	0			
Turnbull, Miss.....	5	0			
Turnbull, Mr. & Mrs.					
A. H.....	10	0			
Turnbull and Wilson,					
Messrs.....	0				
Tytler, G. M. Fraser,					
Esq.....	1	0			
Tytler, J. S. Esq.....	10	0			
Usher and Co. Messrs.					
Andrew.....	1	1			
Usher, Messrs. J.					
T.....	2	2			
Urmston, Mrs.....	10	0			
Waddell, Mrs. Peddie					
Waddie & Co. Messrs.....	5	0			
Waddilove, Miss.....	5	0			
Walker, James, Esq.....	1	0			
Walker, Mr.....	5	0			
Walker, Mrs.....	5	0			
Walker, Messrs. G.					
and J.....	10	0			
Warden and Co.					
Messrs. William.....	5	0			
Warrack and Co.					
Messrs. John.....	1	1			
Warrick and Son,					
Messrs.....	10	0			
Waterson and Sons,					
Messrs.....	1	1			
Watson, Mrs. D.....	5	0			
Watson, John, Esq.....	1	1			
Wauchope, Moodie,					
and Hope, Messrs.....	1	1			
Webster, Mrs.....	5	0			
Weir, Mrs. G.....	5	0			
Weir, R. M. Esq.....	5	0			

MUSSELBURGH BRANCH.

Treasurer and Hon. Secretary—
JOHN RAMSAY, Esq.

Collector—
Mr. THOS. HALL.

Annual Subscriptions.

Aitchison, Colonel.....	5	0
Banks, Mrs. Thos.....	5	0
Beveridge, Rev. J. G.....	5	0
Caird, Alexander, Mr.....	5	0
Currie, Mrs. John.....	5	0
Deans and Moore.....	5	0
Home, Mr. A. M.....	10	0
Hope, General.....	10	0
Hope, Sir Archibald,		
Bart.....	10	0
Hunter, Mr. Henry H.....	5	0

Elginshire.

LOSSIEMOUTH BRANCH.

Chairman—
Capt. J. B. DUNBAR BRANDELL of Pitgavenny.

Honorary Secretary—
Mr. JOHN FERGUSON.

Annual Subscriptions.

Adam, Dr.....	5	0
Allan and Co.....	5	0
Allan, James.....	5	0
*Anderson, Capt.....	10	0
Anderson, Wm. Esq.....	1	0
Bennet, James.....	5	0
Black, Provost.....	5	0
*Brander, Robert.....	5	0
Cameron, Alex.....	10	6
*Clark, Charles.....	5	0
Cooper and Wink.....	5	0
Culbard, William.....	5	0
Duff, General.....	5	0
Edgar, James.....	5	0
Etles, James.....	5	0
Forsyth, David.....	5	0
Gatherer, George.....	5	0
Gordon, John.....	5	0
Gordon, W. R.....	5	0
Grigor and Young.....	5	0
Jamieson, James.....	5	0
Johnston, Major.....	5	0
Macdonald, William.....	5	0
Maclean, Hugh, of		
Westfold.....	5	0
Morrison, Alex.....	5	0
Munro, John.....	5	0
Ogilvie, J.....	5	0
Priest & Co. Messrs.....	5	0
Sellars and Co.....	5	0
Smith, Sheriff.....	5	0
Stuart, John P.....	5	0
Webster, Dr.....	5	0
Weir, Rev. James.....	5	0
Sums under 5s.....	18	10 6
Total.....	£28	1 0

Gifeshire.

ANSTRUTHER BRANCH.

President—
His Worship the Provost.

Honorary Secretary—
H. B. MACKINTOSH, Esq.

Annual Subscriptions.

*Adamson John, Esq.....	10	0
Cook, D., Esq.....	5	0
Darsie, Mrs. G.....	10	0
Darsie, J. R. Esq.....	1	0
Forbes, R. Esq.....	7	6
*Fowler, G. S. Esq.....	5	0
Fowler, Miss s.....	5	0
Gray, Mrs.....	10	0
Irvine, W. D. Esq.....	1	0
Jamieson, W. T. Esq.....	7	6
Lloyd, Rev. F. K.....	5	0
*Mackintosh, H.B. Esq.....	10	6
Martin, John & Co.....	5	0
*Murray, W. Esq.....	10	6
*Olyphant, P. Esq.....	10	6
Sea Box Society.....	1	1
Sharp and Murray.....	10	6
*Watson, Provost.....	5	0
Williamson, Milli-		
gan, and Co.....	2	0
Williamson, S. Esq.....		
M.P.....	1	0
Woodcock, Dr. R.N.....	5	0
Contribution Box.....	5	6
Sums under 5s.....	5	15 6
Total.....	£23	0 0

DUNFERMLINE BRANCH.

President—
EX-PROVOST MATHIESON.

Honorary Secretary—
ROBERT STEEDMAN, Esq.

Annual Subscriptions.

A Lady Friend.....	1	0
Alexander, Daniel.....	5	0
Alexander, Thomas.....	1	0
Alexander, Thomas,		
Jun.....	10	0
Barclay, John.....	5	0
Bardner, Henry.....	5	0
*Beveridge, Erskine.....	10	0
*Beveridge, H.....	10	0
*Donald, Robert.....	1	0
Dunbar, Rev. J. W.....	5	0
Hay, James.....	5	0
Hay, Mrs.....	5	0
Hay and Robertson.....	1	0
Inglis, William.....	5	0
Landale, John.....	10	0
*Macfarlane, James.....	1	0
McLaren, John and		
William.....	10	0
Mathieson, K.....	5	0
Mathewson, James.....	10	0
*Mathewson, William.....	1	0
*Morris, Dr.....	5	0
Nicholson, W.....	5	0
Reid, George.....	10	0
Reid, Robert.....	5	0
Reid, William.....	5	0
*Romanes, Archibald.....	5	0
Ross, John.....	5	0
Rutherford, D. G.....	5	0
Sampson, John.....	5	0
Seath, Alexander.....	5	0
Scobie, Andrew.....	5	0
Smith, Adam.....	5	0
*Spewart, Thomas,		
V.P.....	1	0
Stalker, John.....	5	0

Table with 3 columns: Name, £, s, d. Lists names like Steedman, Robert; Stevenson, Robert; Stewart, R. W. etc.

Total £27 15 6

ST. ANDREW'S BRANCH.

Chairman— J. R. WELCH, Esq. Treasurer— ANDREW SYME, Esq. Honorary Secretary— ANDREW BENNETT, Esq. Annual Subscriptions.

Total £7 13 7

Table with 3 columns: Name, £, s, d. Lists names like Brown, Misses; City of St. Andrews; Kirkcaldy, K. E. S. C. etc.

Total £6 16 0

Forfarshire.

ARBROATH BRANCH.

Chairman— ALEX. REID, Esq., Provost of Arbroath. Honorary Secretary— WM. CARGILL, Esq. Annual Subscriptions.

Table with 3 columns: Name, £, s, d. Lists names like Aitken, Mr.; Anderson, Mr. David; Balfour & Cummings, Messrs. etc.

Table with 3 columns: Name, £, s, d. Lists names like Duncan, Mr. John; Ferguson, Messrs. J. and A.; Forbes, Mr. Thos. etc.

Total 21 14 6

Donations.

Erskine Church Mission School - 12 7 Collected at Shore Dues Office - 7 9 11 Rox at Pier - 16 7 Small Sums - 3 5

Total Dons. 9 2 6

Total Subs. 21 14 6

£30 17 0

DUNDEE BRANCH.

Chairman— WM. O. DALGLEISH, Esq. Treasurer— JAS. MUDIE, Esq. Honorary Secretary— JAMES HUNTER, JUN., Esq. Annual Subscriptions.

Table with 3 columns: Name, £, s, d. Lists names like Allison, G. L. L.; Anderson, Alexander; Arnitstead, George; Binks, Alex. M. etc.

Table with 3 columns: Name, £, s, d. Lists names like Dundee Harbour Trustees (2 years); Dundee, Loch Line S.S. Co.; Dundee, Perth, and London Shipping Comp. etc.

Total 208 15 0

Donations.

Broughty Ferry Police Commissioners - 15 10 Dundee Harbour Trustees, sums levied on shipping 36 9 4 Pirie, David 1 1 0 Seamen frequenting the Port, per John Machan 7 19 7 Contribution Boxes: Auld Reekie Steam 2 4 6 Fifeshire Steamer 18 3

Table with 3 columns: Name, £, s, d. Lists names like Dundee Steamer; S.S. Briannia; S.S. Cambria; Sailor's Home; Broughty Ferry, per Capt. Thoms; Collection taken on Sabbath 22nd Oct. etc.

Total Dons. 57 5 5

Total Subs. 208 15 0

£266 0 5

MONTROSE BRANCH.

Chairman— PROVOST MITCHELL. Honorary Secretary— JAS. WARRACK, Esq. Annual Subscriptions.

Table with 3 columns: Name, £, s, d. Lists names like Aberdeen, F. Esq.; Baxter, David; Burrell, Geo.; C. S.; Carnegie, Misses; Davidson, A. Chemist; Dickson, Arthur; Farfor, Capt.; Findlay, J. R.; Gordon, Mrs. W.; Greig, A. Esq. etc.

Total £59 15 1

Donations.

Davidson, Capt. D. C. and crew of s.s. Joseph 2 10 0 Montrose Harmonic Union, proceeds of Concert 7 2 0 £69 7 1

BRANCHES—LIST OF ANNUAL SUBSCRIPTIONS AND DONATIONS. 161

Haddingtonshire.

DUNBAR BRANCH.

President—
The Duke of Roxburgh.
Chairman—
Colonel Purves,
of Edenholm.
Honorary Secretary—
G. R. Scott, Esq.

Annual Subscriptions.

£. s. d.
*Anderson, W. - 10 0
*Brand, Provost - 10 0

Donations.

*Brodie, A. - 10 0
Buchanan, Rev. R. - 10 0
*Scott, G. R. 1 0 0
Total £3 0 0

NORTH BERWICK BRANCH.

President—
The Right Hon. Lady Mary
Hamilton.

Chairman—
Sir Hew Dalrymple, Bart.

Honorary Secretary—
David McCulloch, Esq.

Annual Subscriptions.

Aitken, Thos. Leith 1 1 0
*Cree, James, Esq. ... 1 0 0
Dalrymple, Lady ... - 10
Hamilton, Miss C.
Nisbet 5 0 0
Jeffrey, David 1 0 0
Lauderdale, Earl of. 5 0 0
Laurie, William ... - 12 6
*Malcolm, Walter,
Esq. 1 0 0
*McCulloch, D. Esq. - 10 0
McIntyre, Mrs. 1 0 0
Peploe, R. L. Esq. ... - 10 0
*Suttie, Capt. F. G.
R.N. 1 0 0
Wedderburn, Sir
David 1 0 0
*Woodrow, T. R. Esq. - 10 0
Total 19 13 6

Donations.

Campbell, George ... 5 0 0
Gordon, Lady - 10 0
Honeyman, M. 1 1 0
McIntyre, Miss 1 0 0
Tait, Mrs. (Ednr.) ... 1 0 0
Boxes 2 10 7
Collected at annual
exercise of Life-
boat 37 14 10
Total Dons. 48 16 5
Total Subs. 19 13 6
£68 9 11

Kincardineshire.

GOURDON BRANCH

President—
James Farquhar, Esq.,
Hallgreen.
Chairman—
Hercules Scott, Esq.,
Brotherton.
Honorary Secretary—
Rev. John Brown,
Bervie.

Annual Subscriptions.

£. s. d.
Aymer, Dr. James . - 5 0
Boath, Mr. D. C. - 5 0
*Brown, Rev. J. - 5 0
Collins, Dr. R. N. - 10 0
Dickson, Patrick, Esq. - 10 0
*Farquhar, James, Esq. 5 5 0
Farquhar, Colonel . . 3 3 0
*Gibb, James G. Esq. - 10 0
*Legg, Mr. A. 1 0 0
*Legg, Mr. D. - 5 0
*Scott, Hercules, Esq. 10 10 0
Thom, Mr. John - 5 0
Sums under 5s. 1 15 0
Total 24 8 0

STONEHAVEN BRANCH.

Patron—
Sir Thos. Gladstone, Bart.,
Lord-Lieut. of the County.

President—
James Wood, Esq.,
Treasurer & Hon. Secretary—
David Carr, Esq.

Annual Subscriptions.

Baird, Alex. of Ury. 2 2 0
Davidson, late Mrs.,
interest on legacy. - 18 8
Duff, R. W. Esq. 1 1 0
*Falconer, Robert ... - 5 0
Greig, George A. - 5 0
Innes, Capt. - 10 0
*Jack, James - 5 0
*Kinross, A. W. - 10 0
*Knowles, James, ... - 5 0
*Martin, Thomas ... - 5 0
M'Inroy, Colonel ... 2 0 0
Mowat, Wm. & Sons - 5 0
Reddie, Captain J. G. 1 0 0
Ritchie, Wm. 1 0 0
Scott, James - 10 0
*Tindal, Robert - 10 0
Watt, Rev. John - 5 0
*Wood, Alexander ... - 5 0
Wyllie, George - 5 0
Sums under 5s. 5 0 6
Total 17 7 2

Donations.

Sir George Balfour,
M.P. 2 0 0
Collection Box at
Boat-house - 19 2
£20 6 4

Kirkcudbright.

KIRKCUDBRIGHT BRANCH.

Patron—
The Earl of Selkirk.
President—
Wm. Martin, Esq.

Treasurer and Hon. Sec.—
James McMuldrow, Esq.

Annual Subscriptions.

£. s. d.
Selkirk, Right Hon.
the Earl of 3 3 0
Barbour, William,
Esq. 1 0 0
Charters, John, Esq. - 5 0
Cowan, John, Esq. . 1 0 0
*Gordon, A. J. Esq. - 5 0 0
Hughan, Major Hor-
ton 1 1 0
Johnson, Mrs. - 5 0
Kennedy, J. L. Esq. 1 0 0
Kirkcudbright, Burgh
of 5 0 0
*Martin, Wm. Presi-
dent - 5 0
Maxwell, Sir Wm.,
Bart. 2 0 0
Maxwell, W. H. Esq. 1 0 0
*McLellan, David,
Esq. - 5 0
McMuldrow, James,
Esq. - 5 0
Murray-Stewart, H.
G. Esq. 1 1 0
Oswald, R. A. Esq. . 1 0 0
Skirving, Adam, Esq. 1 0 0
Wigram, Loftus J.,
Esq., Berkeley
Square, London ... 1 1 0
Sums under 5s. - 15 0
Total 21 11 0

Donations.

Bean, Thomas - 5 0
Gordon, William, Esq.
of Threave 1 0 0
H.M. Chinese Lega-
tion 2 2 0
McClellan, Miss Clara - 10 6
McClellan, John, Esq. 1 1 0
*Williamson, Provost - 5 0
£26 14 6

Fife.

GLASGOW BRANCH.

Treasurer—
James A. Small, Esq.
Honorary Secretary—
R. Hope Robertson, Esq.

Annual Subscriptions.

£. s. d.
Addie, Robert, and
Sons 2 2 0
Aitken and Waddell 2 2 0
Aitkin, Lilburn, and
Co. Messrs. 1 1 0
Alexander Brothers. 1 1 0
Alexander, Fergus-
son, & Co. Messrs. 1 1 0
Alexander, E. Len-
nox & Co. - 10 6

£. s. d.

Alexander and Co.
Messrs. R. F. & J. 1 1 0
Alexander, J. - 5 0
Allan, Jas. & Alex. . 2 2 0
Alston, J. Carfrae ... - 10 0
Anderson, Messrs. D.
and J. 2 2 0
Anderson and Co.
Messrs. Geo. 1 1 0
Anderson and Co.
Messrs. James ... - 10 0
Arnott & Co. Messrs. 1 1 0
Arthur & Co. (Limited)
Messrs. 3 3 0
Arthur and Hinshaw,
Messrs. - 10 6
Auld & Guild, Messrs.
Austin and McAulan,
Messrs. 1 1 0
Baird & Brown, Messrs. 1 1 0
Baird and Son, Messrs.
Hugh - 10 6
Baird, Frank 2 2 0
Balloch, Robert, and
Co. - 10 6
Bannatyne, Kirk-
wood, and M'Janet 2 2 0
Barclay & M'Gregor,
Messrs. 1 0 0
Barclay, Curie, and
Co. Messrs. 4 4 0
Barclay, Mrs. 1 0 0
Barr, W. B. 1 1 0
Bell & Sons, Messrs.
John 1 1 0
Bell, Edmund - 10 0
Bennett, Browne, and
Co. Messrs. 1 1 0
Berry, Barclay & Co. 1 1 0
Bisland Brothers 1 1 0
Binnie, Thomas ... - 10 6
Black & Co. Messrs.
James 1 1 0
Black & Co. Messrs.
John 2 2 0
Blackie and Sons,
Messrs. 1 1 0
Blanefield Printing
Company 1 0 0
Bost and Turner 1 1 0
Bowman, Jas. 1 1 0
Boyd, W. and Co. ... - 10 6
Boyle, Miss E. C. ... 1 0 0
Braby, Fred. & Co.
(Limited) - 10 6
British and African
Steam Navigation
Co. 2 2 0
British India Steam
Navigation Com-
pany (Limited) ... 2 2 0
Brown & Co. Messrs.
J. and T. 1 1 0
Brown & Co. Messrs.
W. and A. 1 1 0
Brown, Daniel - 5 0
Brown and Polson ... 2 2 0
Brown, Downs, and
Co. Messrs. 1 1 0
Brown, James, Esq. . 2 2 0
Brown, jun., Davies
& Tait, Messrs. ... - 10 6
Brown, Sons, & Co.
Messrs. Wm. 2 2 0
Browne and Watson 1 1 0
Browne, Easton, &
Co. Messrs. 2 2 0
Brownlie and Co. ... 1 1 0
Browns & Co. 1 1 0
Bryce and Rumpff ... - 10 6
Bryce, J. D. Esq. ... 1 1 0
Buchanan, Watson,
and Co. Messrs. ... 1 1 0
Bulloch, Lade, & Co.
Messrs. 2 0 0
Burnley and Co.
Messrs. W. F. ... 2 2 0
Burns, Messrs. G. and
J. 4 0 0
Burrell and Son,
Messrs. 1 1 0
Caiton Spinning Co. 1 1 0

£. s. d.		£. s. d.		£. s. d.		£. s. d.	
Campbell and Co.		Fraser, Gordon, & Co.	1 1 0	Kettle and Co. Messrs.		Martin, Turner, and	
Messrs. J. and W.	2 2 0	Fraser, Kirkpatrick,		H.	1 1 0	Co. Messrs.	1 1 0
Campbell, Jas. A.		and Smith	2 2 0	Keydens, Strang and		Middleton and Kirk-	
Esq., M.P., L.L.D.	1 1 0	Fyfe and Morton,		Girvin, Messrs.	1 1 0	patrick, Messrs.	1 1 0
Campbell, Rivers, and		Messrs.	- 10 6	Kidston & Co. A. G.	1 1 0	Millar & Son, Messrs.	
Co. Messrs.	4 4 0	Gairdner, James, & Co.	1 1 0	Kidston & Co. Messrs.		John	1 1 0
Cargill, David, Esq.	- 10 6	Gairdner, Chas. Esq.	1 1 0	A. G.	2 2 0	Miller and Co. Messrs.	
Caw, David,	- 10 0	Galbraith, Messrs. A.		Kidston and Sous,		G.	2 2 0
Chaplin and Co.		and A.	2 0 0	Messrs. Wm.	1 0 0	Miller, James, Son,	
Messrs. Alexander	- 10 6	Garroway, Messrs.		Laidlaw, R. and Son	1 0 0	& Co. Messrs.	1 1 0
Chrystal, Robert, Esq.	1 1 0	R. and J.	1 0 0	Laing and Co. Messrs.		Milligen, John, & Co.	- 10 0
Clark and Co.	2 2 0	Gibb, Elias, Esq.	- 10 6	J.	1 1 0	Mirreces, Tait, and	
Clark, Messrs. J. Jun.		Gilbert, Mrs. Crear.	2 0 0	Laird, Alex. A. & Co.	1 1 0	Watson, Messrs.	2 2 0
and Co.	2 2 0	Hillilan, J. and T.	1 1 0	Lamont & Co. Messrs.		Mitchell, A., Jun.	
Clyde Shipping Co.,	2 2 0	Gowlay, Robt.	1 1 0	Henry	1 1 0	and Sons	- 10 6
Coats, Messrs. J. & P.	2 2 0	Gourlie and Son,		Langlands and Sons,		Mitchell, D.	1 1 0
Cochran, A. and R.	1 1 0	Messrs. William ..	1 1 0	Messrs. M.	1 1 0	Mitchell, Watson,	
Cochrane, J. R.	1 0 0	Govan, Wm.	1 0 0	Law, David	1 0 0	and Wink, Messrs.	2 2 0
Collins, Sons, and Co.		Gow & Co. Messrs.		Law, Thos. and Co.	- 10 6	Mitchells, Cowan,	
Messrs. William ..	2 2 0	Allan C.	1 1 0	Lecky, F. B. & Co.	1 1 0	Johnston, Messrs.	1 1 0
Connal & Co. Messrs.	1 1 0	Graham, John, Esq.	1 1 0	Leister, Louis	2 2 0	Moncreiff, Barr, Paterson,	
Connal & Co. Messrs.		Graham & Co. Messrs.		Leister, Bock, and Co.		and Comp.	2 2 0
William	1 1 0	William	2 2 0	Messrs.	2 2 0	Messrs.	2 2 0
Connell and Co.		Gr. Jam, Messrs. A.		Liepmann, Lehmann,		Moore and Browne,	
Messrs. Charles.	1 1 0	J. and A.	2 2 0	and Co. Messrs.	1 1 0	Messrs.	- 10 6
Craig, R. and J.	2 2 0	Grant & Son Messrs.		Lietke & Co. Messrs.	1 1 0	Moore, Taggart, and	
Craatsheim and Her-		G.	1 1 0	Little, James, & Co.	1 1 0	Co. Messrs.	1 1 0
man, Messrs.	1 1 0	Gray, Dunn, and Co.		Lorimer & Moyes.	1 1 0	Morris and Co.	1 1 0
Crawford, Cree, and		Messrs.	1 1 0	Lumsted, Geo. Esq.	2 2 0	Mossend Iron Co.	1 1 0
Co. Messrs.	1 1 0	Gray & Co. Messrs. J.	1 1 0	MacArthur and Farie	- 10 0	Munzie, Geo.	1 1 0
Cruikshank, Jas.	1 1 0	Gray, J. H.	- 10 0	McAnlay and Co.		Murdoch and Co.	
Cruikshank, W. and		Gray, Mrs.	1 1 0	Messrs. James.	- 10 0	Messrs. Robt.	1 1 0
Co.	- 10 6	Gregor, Turnbull &		MacBean and Co.		Napier and Sons, R.	1 0 0
Crum, Alex. M.P.	1 1 0	Co.	1 1 0	Messrs. H.	2 2 0	Napier and M'Intyre,	
Cumming, J. Esq.	2 2 0	Greg, J. and W.	- 10 6	MacBrayne, D.	4 4 0	Messrs.	3 3 0
Davidson, A.	- 5 0	Grischotti, Fleming,		Macdonald, Hood, &		Neilson & Co. Messrs.	2 2 0
Davidson, W. J. Esq.	2 2 0	and Co.	- 10 6	Co. Messrs.	1 1 0	Neilson & Maxwell,	1 1 0
Deeny and Co.	2 2 0	Gumprecht & Stewart	1 1 0	MacGeorge, Cowan,		Nimmo, Jas. & Co.	1 1 0
Denny, Wm. Brothers,		Harrington, J. P.	1 1 0	and Galloway	1 1 0	Nisbet, Messrs. A. &	
Messrs.	2 2 0	Hart, Arthur	- 10 6	MacKenzie & Aitken	1 1 0	J.	1 1 0
Dick, R. and J.	2 2 0	Hart, John	1 1 0	MacKenzie, Gardner,		Nitshill and Lesmah-	
Dick, W. B. and Co.	- 10 6	Harvie, Alex.	2 2 0	and Alexander,		hagow Coal Co.	2 2 0
Dill, Wilson, & Muir-		Hay, Jas. and Sons	1 1 0	Messrs.	1 1 0	Owners of Barque	
head	- 10 6	Hatfield, Cameron,		Mackenzie, Mrs.	- 10 0	<i>Minnie Browne</i> , per	
Donald, Mr. Thos.	- 10 0	and Co.	- 10 0	Mackinnon and Co.		Messrs. Browne &	
Donaldson Brothers,		Hedderwick, James,		Messrs. William ..	2 2 0	Watson	- 5 0
Messrs.	1 1 0	Henderson and Co.		MacLae, A. Crum,		Owners of barque	
Douglas, R. & Son,		Messrs. Patrick.	4 4 0	Esq.	1 1 0	<i>Jane Cre</i> , per	
Messrs.	- 10 6	Henderson, Bros.	3 3 0	MacLaren, Crum and		Messrs. Browne &	
Dow, Archd. Esq.	1 1 0	Henderson, Miss.	- 10 6	Co.	1 1 0	Watson	- 5 0
Dunlop, Thos. Esq.		Henderson and Co.,		MacLay, Murray, and		Owners of barque	
and Sons	- 15 0	Messrs. D. and W.	4 4 0	Spens, Messrs.	2 2 0	<i>Annie</i> , per Messrs.	
Dunn & Son, Messrs.		Henry and Co.		MacLellan, Messrs.		Browne & Watson	- 5 0
D.	1 1 0	Messrs. A. and S.	1 1 0	P. and W.	4 4 0	Do. <i>Bina Campbell</i> ,	
Dunn Brothers.	- 10 6	Hertz, Theodore	1 1 0	Macleod, Rev. D.,		per do.	- 5 0
Dunn, Jas.	- 10 6	Hertz, Theodore (Add.)	1 1 0	D.D.	- 10 6	Do. <i>Dalhousie</i> , per do.	- 5 0
Dunn, Jas. and Sons	1 1 0	Hill, R. and J. M.		Macpherson, H. S. and		Do. <i>Eliza Campbell</i> ,	
Edington and Sons,		Brown, and J.	2 2 0	Co.	1 1 0	per do.	- 5 0
Messrs. T.	2 2 0	Hinshelwood, J. and		M'Call and Son,		Do. <i>Janet Mc-Nicol</i> ,	
Edmiston and Mit-		Co. Messrs.	- 10 6	Messrs. James.	1 1 0	per do.	- 5 0
chells, Messrs.	1 1 0	Holmes, Kerr, and		M'Clure, Naismith,		Do. <i>Maggie Browne</i> ,	
Edmiston, J. and R.	- 10 6	Hidderwick	- 10 6	Brodie & Co. Messrs.	1 1 0	per do.	- 5 0
Elder & Co. Messrs. J.	2 2 0	Houldsworth and Co.		M'Cowan, David,		Do. <i>Martha Reid</i> ,	
Ellis, Thomas	1 1 0	Messrs. J.	2 2 0	Esq.	1 1 0	per do.	- 5 0
Ewing & Co. Messrs.		Howat, Messrs. D. G.		M'Dowall, Steven,		Do. <i>Mary</i> , per do.	- 5 0
A. Orr.	2 2 0	& Co.	1 1 0	and Co. Messrs.	4 4 0	Do. <i>Marg. Mitchell</i> ,	
Ewing & Co. Messrs.		Howat and Sons,		M'Ewan, Stevenson,		per do.	- 5 0
J.	2 2 0	Messrs. Jas.	- 10 6	and Leask, Messrs.	1 1 0	<i>Ada Browne</i>	- 5 0
Ewing & Co. Messrs.		Hurler and Campsie		M'Gregor, Alex. Esq.	1 1 0	Paterson and Son,	
J. Orr.	2 2 0	Alum Co.	2 2 0	M'Grigor, Donald &		Messrs. Wm.	1 1 0
Farguhar & Rox-		Hutcheson, Jas & Son	- 10 6	Co.	2 2 0	Paterson, Andrew,	
burgh, Messrs.	- 10 6	Hydepark Foundry		M'Laren, Sons, & Co.		Esq.	1 1 0
Ferguson and Sons,		Company	- 10 6	Messrs. William.	1 1 0	Pearson, Adam, and	
Messrs. James.	- 10 6	Incorporation of		McCall and Stephen.	- 10 6	Co.	2 2 0
Ferguson and Bros.		Skinners (per Mr.		McClelland, MacKin-		Pirrie, Foote, and Co.	
Messrs. J.	2 2 0	Osborne)	1 1 0	nion, and Blyth,		Messrs.	1 1 0
Ferguson and For-		Inglis, Messrs. A.		Messrs.	1 1 0	Pitkerhly, Jas. Esq.,	1 1 0
rester	- 10 6	and J.	2 2 0	McMillan, Archd. and		Phillips, John, & Co.	
Ferguson and Reid,		Irvine and Co. Messrs.		Son	2 2 0	Messrs.	- 10 6
Messrs.	- 10 6	Samuel	1 1 0	McEwan, Robt. D.		Pollock, Mrs. Margt.	4 4 0
Finlay & Co. Messrs.		Jackson and Co.		Esq.	- 10 6	Raalte, Jacques van	
James.	2 2 0	Messrs. John	- 10 6	MacFarlane and Co.		& Co.	2 2 0
Fisher and Watt,		Jackson, John	- 10 6	George Gray.	1 1 0	Raiston and Veril.	- 10 6
Messrs.	1 1 0	Jameson, R. Esq.	1 1 0	MacIndoe F. H. P.,	1 1 0	Raiston, Goodwin &	
Fleming, P. and R.		Jeffrey, R. and Sons	- 10 6	2 2 0		Co. Messrs.	1 1 0
& Co.	1 1 0	Johnston, James, Mr.	2 2 0	MacLean, Neil	2 2 0	Ramsay, John, Esq.,	- 10 0
Forbes, Peter.	2 2 0	Kelly & Co. Messrs.,	1 1 0	McTear, Robt. & Co.	- 10 6	Rankin and Sons,	
Forsyth, Miller, and		Kerr, Anderson, Muir		Malloch, Messrs. C.		Messrs. W.	- 10 6
Co.	1 1 0	and Main, Messrs.	2 2 0	and J.	- 10 6	Rankine and Son,	
Frame, Thos.	- 10 6	Kerr, Newton, & Co.		Mann, Byars, and		Messrs. James	1 1 0
Fraser and Sons,		Messrs.	1 1 0	Co. Messrs.	1 1 0	Rattray Brothers, &	
Messrs. John.	1 1 0			Martin, John, Esq.,	- 10 6	Smith, Messrs.	- 10 6

BRANCHES—LIST OF ANNUAL SUBSCRIPTIONS AND DONATIONS. 163

£.	s.	d.	£.	s.	d.
Reid and Son, Messrs.			Teacher and Sons,		
Alex.....	1	1	Messrs. William..	2	2
Retchmann and Co.			Templeton and Co.		
Successors.....	1	1	Messrs. James....	2	2
Rintoul, Son, and Co.			Tennant and Co.		
Messrs. Peter.....	1	1	Messrs. Charles....	3	3
Ritchie and Co.			Templeton, James..	10	6
Messrs. Jas.....	1	1	The Ferenze Print-		
Robb, Moore, & Co.			ing Co.	10	6
Messrs.....	10	6	Thom and Cameron.	1	1
Robertson, John, Esq.	1	1	Thomson, Aikman,		
Robertson & Baxter,			and Co.....	10	6
Messrs.....	1	1	Thomson and Gray ..	10	6
Robertson, Messrs.			Thomson, Jas. & Geo.	1	1
L. and R. H.....	1	1	Thomson, John and		
Robertson, Wm. C. E.	10	0	James.....	1	1
Robertson, Hugh, &			Thomson, Neale.....	1	1
Co. Messrs.....	10	6	Thomson, Sir Wm..	2	2
Robinson and Mar-			Tillie & Henderson.	1	1
joribank.....	4	4	Train & Co. Messrs.		
Rodger, James, Esq.	1	1	Thomas.....	10	6
Rodger, Mrs.....	1	1	Turnbull and Co....	1	1
Rose, Murison, and			Turnbull, Martin, &		
Thomson, Messrs.	1	1	Co.....	1	1
Ross and Co. Messrs.			Ure, John, Lord Pro-		
W.....	1	1	vost.....	2	2
Ross, John.....	1	1	Verel, A. R.....	5	0
Ross, Malcolm, and			Wallace, Wm.....	5	0
Co., Messrs.....	10	6	Walker & Co. Messrs.		
Rowley and Dick,			John.....	10	6
Messrs.....	10	6	Walker & Hamilton,		
Royal Clyde Yacht			Messrs.....	10	6
Club.....	2	2	Walker, Wm.....	5	0
Russell, Miss J. G.....	1	1	Watson, John.....	10	6
Sandeman and Co.			Watson, James, Sir.	2	0
Messrs. D.....	10	6	Watson, Gow, and		
Sandeman, J. G.....	1	1	Co. Messrs.....	1	1
Scott J. and John G.	1	1	Watson and Co.		
Selgmann, H. L. and			Messrs. James.....	2	1
Son.....	10	6	Watson Bros.....	1	1
Semple, McLean, &			Wharrie, Colledge &		
Reid, Messrs.....	1	1	Brand, Messrs.....	10	0
Shaughnessy, J.....	5	0	White, Messrs. James		
Simpson, Hunter,			and John.....	3	3
& Young, Messrs..	1	1	Wilkie, Wm. & Co..	1	1
Simons, Jacobs and			Williamson, T.....	1	1
Co. Messrs.....	10	6	Wilson and Son,		
Singleton, Dunn, and			Messrs. Jas.....	1	1
Co.....	2	2	Wilson, Mathison, &		
Skinner and Co.			Co. Messrs.....	10	6
Messrs. Thomas.....	1	1	Woodrow, Alexander,		
Skinner and Sons,			& Sons, Messrs.....	10	6
Messrs. W.....	1	1	Worlie and Co.....	1	1
Sloan & Co. Messrs.			Wotherspoon and Co.		
William.....	2	2	Messrs. R.....	1	1
Smith, Jas.....	2	2	Wright, J. Brooks, Esq.	1	1
Smith, James.....	1	1	Wright, Johnstone,		
Smith & Co. Messrs.			and Mackenzie,		
A. and W.....	10	6	Messrs.....	2	2
Smith and Sharp,					
Messrs.....	2	2	Total.....	478	16 6
Smith and Sons,			<i>Donations.</i>		
Messrs. George.....	4	4	Clark and Co.....	2	2
Smith and Wellstood,			Ewing and Co. John		
Messrs.....	10	6	Orr.....	2	2
Smith, George, & Co.			Laird & Co. Alex. A.	2	2
Messrs.....	1	1	Ilburn & Co. Aitken	2	2
Snodgrass, Messrs. J.			Maclay, Murray, and		
and R.....	1	1	Spens.....	2	2
Steel, Coulson, and			McGrigor, Donald,		
Co. Messrs.....	1	1	& Co.....	2	2
Stephen and Son,			Smith and Sharp....	2	2
Messrs. Alexander	2	2	Smith, Geo. & Sons.	20	0
Stevenson, J. Esq....	2	2	Cash Don.....	1	1
Stewart, Messrs. Andrew			Collected on Board		
and James.....	1	1	Clansman, per Mr.		
Stewart and Co.			Paterson.....	11	1
Messrs. John.....	1	1	Kinning Park F. C.		
Stewart & McDonald,			School, per Mr. R.		
Messrs.....	3	3	McCord, Collected		
Stewart, R.....	2	2	in Box Sabbath		
Stewart, D. Y. & Co.			School.....	2	13
Stonelaw Colliery....	10	6			
Stirling, Wm. & Sons			Total Dons.....	38	19
2 0 0			Total Subs.....	478	16 6
Strang & Kirkwood.	1	1			
Summerlee Iron Co..	2	2			
Symington and Co.					
Andrew.....	5	0			
Tasker, John.....	10	6			
Tatlock, Robert R..	1	1			
Taylor, Laughland,					
and Co. Messrs.....	1	1			

Linlithgowshire.

KIRKLISTON BRANCH.

President—
Rev. J. C. BURNS.

Honorary Secretary—
Mr. JOHN GARDINER.

Annual Subscriptions.

£.	s.	d.
Blair, Miss.....	7	6
Burns, Rev. J. C.....	10	0
Burns, Mrs.....	10	0
Duncan, Miss.....	1	0
Hog, T. A. Esq.....	5	0
McQueen, — Esq.....	10	0
Ogilvie, Miss.....	5	0
Stewart and Co.,		
Messrs.....	10	0
Stewart, R. Esq.....	10	0
Sums under 5s.....	15	6
Total.....	25	3 0

STROMNESS BRANCH.

Honorary Secretary—
Capt. G. BILTON.

Annual Subscriptions.

£.	s.	d.
Bilton, Geo.....	5	0
Copland, J. S.....	5	0
Miller, Capt.....	5	0
Shearer, James.....	5	0
Spence, James, Esq..	10	0
Watt, Wm.....	5	0
Zetland, Lord.....	5	0
Sums under 5s.....	2	12
Total.....	£9	7 0

Peebleshire.

PEEBLES BRANCH.

Nairnshire.

MORAY FIRTH BRANCH.

Chairman—
Provost LESLIE, Nairn.

Treasurer & Hon. Secretary—
H. T. DONALDSON, Esq.,
Solicitor, Nairn.

Annual Subscriptions.

£.	s.	d.
*Dunbar, Sir James		
Alexander.....	10	0
*Mackintosh, Hugh,		
Esq.....	10	6
Forres, Town of....	2	2
Nairn, Town of.....	3	3
<i>Donations.</i>		
Town of Inverness..	5	0
Sundry Donations...	5	1
Total.....	£16	6 6

President—
T. H. ORPHOOT, Esq.,
Sheriff-Substitute.

Honorary Secretary—
DR. CORNELL.

Annual Subscriptions.

£.	s.	d.
Alexander, Miss....	5	0
Ballantine, Rev. W..	5	0
Black, Capt., Kailzie	1	1
Blackwood, Mr.....	5	0
*Buchan, Mr. W.....	5	0
Buchan, Miss.....	5	0
*Burgess, Rev. R....	5	0
*Currie, Rev. D.....	5	0
Hay, Sir R.....	1	1
Hay, Mrs.....	10	0
Hunter, Mrs.....	7	0
Lindsay, Miss.....	5	0
Linton, Mr.....	5	0
Mackenzie, Mr.....	1	1
McIrose, Mr.....	5	0
*Orphoot, Mr.....	10	6
Panton, Mr.....	10	6
Proceeds of Secretary's		
Lecture at		
Stobo.....	14	8
Reid, Miss.....	5	0
Robertson, Miss.....	5	0
Tennant, Mr.....	2	2
Thorburn, Mr. M.....	10	6
Thorburn, Mr. R.....	10	6
Thorburn, Walter.....	10	6
Thorburn, William ..	10	6
*Tod, Mr., St. Mary's		
Mount.....	2	2
Wallace, Mr.....	1	1
Williamson, Mr. R....	5	0
*Wyer, Rev. T.....	10	6
Sums under 5s.....	3	16
Total.....	£20	14 2

Orkney Islands.

LONGHOPE BRANCH.

Chairman—
J. G. MOODIE HEDDIE, Esq.

Honorary Secretary—
EDWARD E. CORRIGALL, Esq.

Annual Subscriptions.

£.	s.	d.
Corrigall, Edward E.		
Esq.....	5	0
Heddie, J. G. Moodie	1	1
Sums under 5s.....	3	4
Total.....	£4	10 10

	£.	s.	d.
Smith, Messrs. J. and T.	10	0	0
Stelfox, James, Esq.	5	0	0
Stewart, Chas. Esq.	5	0	0
Tate, Alex. Esq.	10	0	0
Torrens, Jas. Esq.	1	0	0
Trimble, Mr. Saml.	5	0	0
W. C. F. D., Esq.	10	0	0
Wallace, Sir Richard, Bart., M.P.	5	5	0
Ward, Marcus, & Co. Messrs.	10	0	0
Ward, Robert E. Esq.	1	0	0
Workman, Messrs. J. and R.	10	0	0
Workman, Mrs. R. Sen.	1	0	0
Workman, Mrs. Robt.	1	0	0
Workman, Wm. Esq.	1	0	0
Workman, T. Esq.	1	0	0
Workman, F. Esq.	5	0	0
Workman, Rev. Rbt. Jun.	1	0	0
Young & Mackenzie, Messrs.	10	0	0
Sums under 5s.	7	0	0
Total	84	0	0

Donations.
 Collected by H. W. Warnock, Esq. 11 0
 Pillar Box at Northern Counties Railway Station 2 18 5
£37 9 5

PORTRUSH BRANCH.

President—
 Major-General J. BERESFORD SMYLY.
 Vice-President—
 Rev. H. FFOLIOTT, M.A.
 Treasurer—
 THOMAS BELLAS, Esq.
 Honorary Secretaries—
 Rev. JONATHAN SIMPSON.
 W. E. CARVER, Esq., J.P.
 Assistant Secretary—
 Mr. SAMUEL PATRON.
Annual Subscriptions.
 Adams, J. Esq. J.P. 10 0
 Anderson, James S. 5 0
 Antrim, Rt. Hon. L., Countess of (the late) 3 0 0
 *Bellas, H. and T. 1 0 0
 Bevington, J. B. Esq. 10 6
 Bevington, S. B. Esq. 10 6
 Cameron, W. J. Esq. 5 0
 Carr, John, Esq. 10 0
 *Carver, W. E. Esq., J.P. 1 0 0
 Chainé, Major 1 0 0
 Cox, Mrs. S. L. 1 0 0
 *Crookshank, R. Esq. 10 0
 Denham, Mrs. Dr. 5 0
 *Fall, Daniel 10 0
 Finlayson, Rev. Jno. 5 0
 *Ffoliott, Rev. H., M.A. 10 0
 Gordon, Joseph 5 0
 Grant, P. Drummond 5 0
 Greer, T. M. Esq. 5 0
 Hannay, Lt.-Col. J.P. 10 6
 Hill, Miss 10 0
 Huey, John 10 0
 Hunter, Stewart 10 0
 *Knox, Capt. W. B., J.P. 1 0 0
 Leach, H. W. Esq. 5 0
 Leslie, Col. E. D., J.P., D.L. 1 0 0
 Lusk, John, Esq. 5 0
 Macaulay, H. A. Esq. 5 0
 McCleery, J. O. 10 0
 McElderry, T. 5 0

	£.	s.	d.
Montgomery, Capt. R. J., J.P.	1	0	0
Moore, J. S. Esq. J.P.	1	0	0
Moore, Miss.	5	0	0
Murray, Major, J.P.	1	0	0
O'Neill, Hon. E., D.L.	1	0	0
Orr, Rev. R. Holmes	10	6	0
Patrick, J. Esq. J.P.	10	0	0
Portrush Harbour Commissioners	2	2	0
*Smyly, Major-Gen. John Beresford.	1	0	0
*Simpson, Rev. J.	1	0	0
Stannus, Miss.	10	0	0
Taylor, D. Esq., J.P.	10	0	0
Taylor, Robert	1	0	0
Templetown, General, Rt. Hon. Lt. Visc.	1	0	0
Thompson, J.	5	0	0
Troughton, James.	10	0	0
Turly, J. Esq. J.P.	10	0	0
*Watt, Capt.	1	0	0
Wayne, Lord, Rt. Hon.	1	0	0
Wilson, Chas. Esq.	1	0	0
Young, Mrs. Jas.	10	0	0
Young, Miss	10	0	0
Young, J. Esq. J.P., D.L.	10	0	0
Young, Wm. A. Esq.	10	0	0
Total	36	9	0

Donations.
 Anonymous 15 6
 Antrim Arms Hotel Box 8 6
 Coleman's Hotel Box 4 4
 Forsythe, Chas. Esq., M.D., Coleraine 5 0
 Moore, Miss, Londonderry 1 0 0
 Raphael, George, Esq., Galgorm House 1 0 0
 "S." Belfast Postmark 5 0
 Life-boat House Box 8 11
 The following, per Miss Stannus:
 Fitzgerald, Hon. Miss G. V. 5 0
 Gidlow, Mrs. 5 0
 Wayne, Miss 10 0
 Wayne, Miss A. 10 0
Total Dons. 5 17 3
Total Subs. 42 6 3

Co. Caban.

CAVAN BRANCH.

President—
 The LORD FARNHAM.
 Chairman—
 Major E. J. SAUNDERSON.
 Treasurer—
 JOHN BOYD, Esq.
 Secretary and Collector—
 Mr. T. J. SMYLY.
Annual Subscriptions.
 Farnham, the Lord (Hon.) 2 0 0
 Saunderson, Capt. L. T.B. (Annual Sub.) 2 0 0
 Saunderson, Llewellyn, Esq. 1 0 0
 Stone, Rev. W. H. (Don.) 10 0
£5 10 0

Co. Cork.

BALLYCOTTON BRANCH.

Patron—
 The Right Rev. the LORD BISHOP OF CORK, CLOYNE, AND ROSS.
 President—
 E. F. LITTON, Esq., Q.C.
 Honorary Secretary—
 T. W. STRANGMAN, Esq.
Annual Subscriptions.
 Beale, Alfred, Esq. 5 0
 Beale, Henry H. Esq. 5 0
 Bristol General Steam Navigation Co. 1 0 0
 Clyde Shipping Comp. 3 3 0
 Cork Harbour Com. 5 0 0
 Cork, Lord Bishop of 1 0 0
 City of Cork Steam Packet Company 5 0 0
 Cunard Company per Messrs. MacIver 2 2 0
 Evans, Archdeacon 10 0
 *Gaggin, Geo. Esq. 5 0
 Hatchett, Mrs. J. Goldsmith 1 1 0
 Henderson Brothers, Messrs. "Anchor Line" of Steam Ships 2 2 0
 *Litchfield, W. Esq. 5 0
 Litton, E. F. Esq. Q.C. 1 1 0
 Longfield, Montfort, J. C. Esq. 2 0 0
 Strangman, T. W. Esq. 10 0
Total 25 9 0

Donations.
 Collection Boxes on board Steamers of City of Cork S.S. Co., per W. de Foubert, Esq. 5 2 3
£30 11 3

CORK AND QUEENSTOWN BRANCH.

President—
 Rear-Admiral RICHARD VESEY HAMILTON, C.B., Commanding the Irish Station, Queenstown.
 Treasurer—
 HENRY HARDY, Esq., Knockeven, Queenstown.
 Honorary Secretary—
 Capt. N. SUTTON, Queenstown.
Annual Subscriptions.
 Barry, A. H. Smith, D.L. 2 2 0
 Beamish and Crawford 2 2 0
 Beamish, Capt. J. C. 1 0 0
 Bristol Steam Navigation Co. 2 2 0
 *Byrne, Capt. 1 1 0
 City of Cork Steam Packet Co. 5 0 0
 Clyde Shipping Co. 2 2 0
 Cork Harbour Commissioners 10 0 0
 Currey, P. 1 0 0
 *Dolan, R. J. Collector of Customs 1 1 0
 *Fitzgerald, R. U. P. 1 0 0
 *French, S. 10 0

	£.	s.	d.
Gaion Company	1	1	0
*Hamilton, Rear-Adm.	1	0	0
*Hardy, Henry	1	0	0
*Harvey and Sons, G. N.	1	1	0
Inman, W.	2	2	0
Ismay, Imrie, & Co.	5	0	0
M'Iver, C. and D.	2	2	0
Murphy, James J. & Co.	5	0	0
Newsom, J. C.	1	0	0
National Steam Ship Co.	1	1	0
Queenstown Towing Company	1	0	0
Rushbrook, Miss	5	0	0
*Scott, James, & Co.	1	1	0
*Sharpe, Capt., R.N.	1	0	0
H.M.S. Revenge	1	0	0
Tomkins, V.	1	1	0
Woodford & Bourne	1	0	0
Total	59	9	0

Helberg, J. C. 10 0
 Small Sums collected by R.J. Dolan, Esq. 15 0
 Collected in Life-boat Boxes at Great Southern and Western Railway, Cork 1 14 0
 Mercantile Marine Board, Cork 6 2 0
 Do. do. Queenstown 1 0 0
 Harbour Commissioners, Cork 8 0
 Do. do. Queenstown 11 8
 Sums under 5s. 12 4
Total Dons. 11 13 0
Total Subs. 59 9 0
£71 2 0

COURTMACSHERRY BRANCH.

Chairman—
 The Right Hon. the EARL OF SHANNON.
 Honorary Secretary—
 Captain FOWNSHEND.
Annual Subscriptions.
 Boyle, Ladies 5 0 0
 Cork Steam Ship Co. 5 0 0
 Cunard Company 2 2 0
 *Foster, A. Esq. 10 0
 *Lealie, W. B. Esq. 10 0
 *Shannon, Earl of 5 0 0
 *Stawell, Col. Acock, J.P. 2 0 0
 *Fownshend, Captain 10 0
Total £20 12 0

YOUGHAL BRANCH.

Honorary Secretary—
 J. W. PIM, Esq.
Annual Subscriptions.
 Allan, Mrs. 5 0 0
 Duke of Devonshire 5 0 0
 *Drury & Sons, Messrs. 10 0
 *Farrell, Mr. Richard 5 0
 Fitzgerald, Rev. L. 5 0
 *Gorman, Mr. Patrick 10 0
 Green, Rev. Mr. 10 0
 Lloyde, G. W. Esq. 3 0 0
 Boxes 1 5 6
 Sums under 5s. 5 0
Total £11 15 6

BRANCHES—LIST OF ANNUAL SUBSCRIPTIONS AND DONATIONS. 167

Co. Down.		TYRELLA BRANCH.		£. s. d.		£. s. d.					
BALLYWALTER BRANCH.		Honorary Secretary— D. McCANN, Esq. Annual Subscriptions.		Dublin and Liverpool Screw Steam-ship Company 2 0 0 Dublin Steam Print- ing Co. 1 0 0 Dublin Drapery Co. (Limited) 2 0 0 Egan, A. W. Esq. - 10 0 Ferrier, Pollock, and Co. Messrs. 2 0 0 Findlater, J. Esq. 2 2 0 Fisher, Thomas, Esq. - 10 0 Forster & Co. Messrs. 1 0 0 Garratt, J. Esq. 1 0 0 Gilbey, Messrs. W. and A. 1 1 0 Green Bros. Messrs. 1 0 0 Handcock, W. D. - 10 0 Hazleton Connor and Co. Messrs. 1 1 0 Heiton & Co. Messrs. T. 1 1 0 Hogg & Co. Messrs. W. 1 0 0 Howell, P. Esq. 1 0 0 Jacob, R. S. Esq. - 5 0 Jameson and Son, Messrs. John 2 0 0 Jameson, Pim and Co. Messrs. 1 1 0 Jameson and Co., Messrs. William. 1 0 0 Kenny and Owens, Messrs. - 10 6 Kildare, Lord 5 0 6 Kinahan and Sons, Messrs. 2 0 0 Lambert, Brien, and Co. Messrs. - 10 0 Leitch, Thos. Esq., J. P. - 10 0 McCullagh, Son, & Co. Messrs. James. 2 2 0 McDonnell & Co., Messrs. Thomas. - 10 0 McKee, W. C. Esq. ... MacMullen, Shaw, & Co. Messrs. 1 0 0 Manders, Robt. & Co. 2 0 0 Martin, Messrs. T. and C. 1 0 0 Miller, Adam, and Co. 1 0 0 Moses, M. T. Ogilvy, Alex. Esq. ... 1 0 0 Palgrave, Murphy, and Co. Messrs. 2 2 0 Pease, Mrs. 2 0 0 Perrin, Rd. and Son. 1 0 0 Pim, Bros. and Co. (Limited) Messrs. ... 3 0 0 Powerscourt, Lord ... Roe, Henry, Jun. 2 2 0 Ross and Walpole ... Messrs. 1 0 0 Shackleton and Sons, George 1 0 0 Switzer, Fergusson, and Co. Messrs. 1 0 0 Taylor, Messrs. W. and M. 1 0 0 Tedcastle and Co. Messrs. R. 1 10 0 Todd, Burns, and Co. Messrs. 3 3 0 Turbett, Messrs. Rbt. & Jas. 1 0 0 Watkins & Co. Joseph Messrs. 2 0 0 Webb, J. H. & Co. (Limited) - 10 0 Weir, James and Co. 1 0 0 Westby, Edward Per- cival, Esq., J. P. 5 0 0 White, Joshua, Esq. ... 1 0 0 Woods, Webb, and Phenix, Messrs. 1 6 0 Wynyard, Maj.-Gen. 1 0 0		Collecting Boxes at— Kingsbridge Pillar Box - 5 0 Drogheda Rwy. do. - 6 2 Limerick Juno. do. - 6 1 Reft. Room do. - 14 10 Concert, proceeds of, per Wm. Arm- strong, Esq. in aid of Howth Life-boat 20 0 0 Total Dons. ... 25 2 1 Total Subs. 106 3 6 £131 5 7					
Honorary Secretary— Rev. J. O'REILLY BLACKWOOD Annual Subscriptions.		The Marquis of Down- shire 5 0 0 The Dowager Mar- chioness of Down- shire 1 0 0 The Lady Amelia Montgomery 1 0 0 Viscount Bangor 2 0 0 The Lady Matilda Montgomery 1 1 0 Lord de Ros 1 0 0 Atkinson, J. Brooke, Esq. - 10 0 *Bingham, Rev. J. ... - 5 0 Birney, Mrs., Oakley - 10 0 Deacon, Rev. John J. - 10 0 *Digney, Mr. P. - 5 0 East Downshire S. S. Co. Dundrum, per Mr. E. G. Henesey 2 2 0 Montgomery, Hugh, Esq. 2 10 0 Nugent, Col. Andrew 1 0 0 Poß, William T. Esq. 1 0 0 Reid, J. Esq. - 5 0 *Smyth, Rev. G. Gordon - 10 0 *Stophenson, S. S. Esq. M.D. - 5 0 Total £20 13 0		Dublin. DUBLIN BRANCH Patron— His Excellency EARL SPENCER. Lord-Lieutenant of Ireland. Honorary Secretary— THOMAS EDMONDSON, Esq. Secretary and Collector— MR. J. PIKE Annual Subscriptions.		His Excellency Earl Spencer 10 0 0 Allen, Richard, Esq. 1 0 0 Arditsun, The Lord. 2 0 0 Arnott & Co. Limited, Messrs. 3 3 0 Baker & Sons, Messrs. Wm. - 5 0 Ballantine, Alex. ... & Co. Messrs. S. 1 0 0 Boyle, Low, Murray, and Co. Messrs. ... 2 0 0 British & Irish Steam- packet Company. ... 2 2 0 Brooke & Son, Messrs. G. F. 1 0 0 Brown, Thomas, and Co., Messrs. 1 0 0 Cantrell & Cochrane, 1 0 0 City of Dublin Steam- packet Company. ... 2 2 0 Clibborn, Jas. 1 0 0 Cowan and Co. 1 0 0 Crowe, Wilson, & Co. Messrs. Limited. 1 0 0 D'Arcy and Son, Messrs. John 2 0 0 De Vesli, Lord 2 0 0 Dixon, Jas. Drummond & Sons, Messrs. Wm. 1 0 0 Dublin and Glasgow Steam-packet Co. ... 2 2 0		Kingstown KINGSTOWN BRANCH. President— The Most Noble the MARQUIS OF ORMONDE. Honorary Secretary— Commander the Hon. F. G. CROFTON, R.N. Annual Subscriptions.		Barton, H. L., D.L. ... 5 0 0 Barton, Miss 3 0 0 Browne, Mrs. R. F. 1 0 0 Bruce, Miss - 5 0 Burroughs, Rev. W. E. - 10 0 Chatterton, the Vice- Chancellor 2 0 0 Close, S. H. Esq. 1 0 0 Coghill, Sir J. Bart. 1 0 0 *Dalton, Rev. G. W. - 10 0 *Dalton, G. E. R. Esq. - 5 0 *Daly, Hon. Skeffing- ton 2 0 0 Delap, J. B. 1 0 0 Dillon, Hon. L. G. ... - 10 0 Dudgeon, J. Hume, Esq. 2 2 0 Elliott, Mrs. - 10 0 Gilmore, Mrs. J. S. ... - 5 0 Edwood, Miss - 5 0 Hogan, W. O. Esq. ... - 10 0 *Hone, Brindley ... 1 0 0 Hogan, J. F. Esq. ... - 10 0 Lodge, Miss 1 0 0 Magee, Miss 1 0 0 Moorewood, Misses 1 0 0 O'Hara, Mrs. Hamil- ton 1 0 0 Ormonde, Marquis of, Yacht <i>Mirage</i> of ... 5 0 0 Reid, J. Hamilton, Esq. 1 0 0 Royal Alfred Yacht Club 2 2 0 Royal Irish Yacht Club, per Committee 2 0 0 Royal St. George's Yacht Club 3 0 0 Wolf, Mrs. - 5 0 Total 40 9 0 Donations. A Friend - 5 0 Collecting Boxes on Mail Steamers— Connught - 6 7 Munster - 12 7 Ulster - 18 9 <i>Leinster</i> 1 7 6 Kingstown do. B. Stat. 2 17 9 Seapoint do. - 7 10 Salthill do. 1 3 7 Kingstown do. Pier. 3 8 10 R. Irish Yacht Club do. 3 19 0 Total Dons 15 7 5 Total Subs. 40 9 0 £55 16 5	
Total £12 7 0		Total £20 13 0		Total 106 3 6		Total Dons 15 7 5 Total Subs. 40 9 0 £55 16 5					

**NEWCASTLE (DUN-
DRUM) BRANCH.**

President—
The EARL OF RODEN.
Chairman—
Rev. J. H. SEYMOUR, M.A.
Honorary Secretary—
Mr. WM. HAYWARD.
Annual Subscriptions.

Annesley, The Earl.	1 0 0
Annesley, Countess.	1 0 0
Bristow, Rev. John.	- 5 0
*Brownlow, Claude E. Esq.	1 0 0
Brush, Geo. Esq.	- 10 0
Brush, Richd. Esq.	1 0 0
*Clarendon, S. Esq.	- 10 0
Clermont, Lady	- 10 0
Clermont, Lord	1 0 0
*Creery, C. Esq.	- 5 0
Davidson, J. Esq.	1 0 0
Gray, Dr.	- 5 0
Halliday, W. J.	- 5 0
Hamilton, Mr. E.	- 10 0
Hamilton, Mrs., Kil- leshandra (8th don.)	3 0 0
*Hayward, Mr. W.	- 5 0
Hickman, Major.	- 5 0
Humphrys, Mrs.	1 0 0
Johnson, J. M. Esq.	- 5 0
Kilmorey, The Earl of	5 0 0
Knox, Mrs.	- 5 0
Lindsay, Mrs.	- 5 0
McClelland, A. Esq.	- 5 0
Murland, J. Esq.	1 0 0
*Richardson, Joseph.	- 5 0
*Roden, Earl of	4 0 0
Seymour, Rev. J. H.	1 0 0
Shaw, W. Esq.	- 5 0
Smyth, Rev. S. J.	- 5 0
*Smyth, H. Esq., C.E.I.	1 0 0
Smythe, Lieut.-Gen.	- 5 0
Spankie, Lieut.	- 10 0
Srannus, Miss	- 5 0
Wallace, Mr. E.	- 5 0
*Waring, Wm. Esq.	1 0 0
Wright, J. Esq.	- 10 0
Wynne, Miss	- 5 0
Collection Boxes	1 15 6
Sums under 5s.	2 6 6

Total £34 7 0

BALBRIGGAN BRANCH.

Chairman—
EDWARD HAMILTON WOODS, Esq., J.P.
Honorary Secretaries—
H. A. HAMILTON, Esq., J.P.
W. J. CUMISKY, Esq.
Annual Subscriptions.
£. s. d.
Cumisky, W. Esq. ... 1 0 0
*Filkate, Capt. Townley M. 1 0 0
Grogan, Rev. John. ... 1 0 0
*Hamilton, H. A. Esq. 1 0 0
Jameson, R. D. Esq. 1 0 0
Moore, R. Tunstall, Esq. 1 1 0
Taylor, Col. E. T. M. P. 1 0 0
Woods, K. H. Esq. ... 1 0 0
*Woods, W. St. L. Esq. 1 0 0
*Whyte, Wm. Esq. ... 1 0 0
Boxes - 8 10
Total £10 11 10

ROGERSTOWN BRANCH.

President—
Maj.-Gen. SIR ROGER PALMER, BART.
Chairman—
CHARLES COBBE, Esq., D.L.
Honorary Secretaries—
WM. C. TOWNSEND, Esq. J.P.
R. BUTLER, Esq.
Annual Subscriptions.
*Butler, R. Esq. 1 0 0
*Cobbe, C. Esq. 3 0 0
*Palmer, Major-Gen. Sir Roger, Bart. ... 5 0 0
*Perrin, M. Esq. 1 0 0
Total £10 0 0

SKERRIES BRANCH.

Chairman—
ION TRANT HAMILTON Esq., M.P.
Honorary Secretaries—
HENRY A. HAMILTON, Esq., J.P., Balbriggan.
HENRY H. FOSTER, Esq., Skerries.
Annual Subscriptions.
Cobbe, Charles, Esq. 2 0 0
Foster, H. H. 1 0 0
Gowan, Francis, Esq. 1 0 0
Hamilton, H. A. Esq. 1 0 0
Hamilton, Ion T. Esq. M.P. 2 0 0
Hamilton, Mrs. 1 1 0
Hely-Hutchinson, Hon. Mrs. C. 1 1 0
Palmer, General Sir R. Bart. 2 0 0
Pepper, J. St. George, Esq. 1 0 0
Scriven, Dr. 1 0 0
Talbot de Malahide, Lord 1 1 0
Taylor, Col. Rt. Hon. T. E., M.P. 2 0 0
Woods, Edward H. Esq. 2 0 0
Collection in Box. - - -
Total £18 4 0

Co. Fermanagh.

ENNISKILLEN BRANCH.

President—
The Right Hon. The EARL OF BELMORE.
Chairman—
Rev. Dr. SREELE.
Honorary Secretary—
Hon. Mrs. POMEROY
Annual Subscriptions.
£. s. d.
*Archdale, Col. - 10 0
*Archdale, E. Esq. R.N. - 10 0
Archdale, W. Esq., M.P. 1 0 0
Bagot, Dr., M.D. - 5 0
*Belmore, Earl of ... 1 0 0
Beresford, Mrs. Massey - 10 0
Brooke, Mrs. Butler. 1 0 0
Chapman, Thomas, Esq. 1 0 0
Colley, Miss Pomeroy - 10 0
Crichton, Lady C. ... 1 0 0
Crichton, Viscount. 1 0 0
Erne, Countess of ... 1 0 0
Fowler, Robt. Esq. ... - 10 0
Glen, Robt. Esq. - 5 0
Greer, Rev. S. 1 0 0
Hibert, Miss 1 0 0
Jeffers, Mr. - 5 0
Jones, Mrs. - 10 0
Kilmore, Dean of ... 1 0 0
Knox, Miss Emily ... - 10 0
Knox, Mrs. W. 1 0 0
*Lanesborough, Earl of 0 0
Ormsby, Mrs. - 10 0
Pomeroy, Hon. Mrs. A. 2 10 0
*Pomeroy, John A. Esq. 1 0 0
Pomeroy, Mrs. J. A. - 10 0
Pomeroy, W. K. Esq. 1 0 0
Richardson, Lt.-Col. 1 0 0
Richardson, Mrs. ... - 10 0
Ruchtoff, Fraulein. ... - 5 0
*Saunderson, E. Esq. 1 0 0
Stirling, Mrs. of Gardin. 1 0 0
*Tipping, Gartside, Esq. 1 0 0
Tipping, Miss. 1 0 0
Tipping, Lieut. H. Gartside, R.N. ... 1 0 0
Wigram, Francis, Esq. 1 0 0
Williams, W. Esq. ... - 5 0
Wood, Mrs. - 5 0
£31 0 0

Donations.

*Enniskillen, Earl of 3 0 0
Enniskillen, Countess of. 2 0 0
Members of the Lough Erne Yacht Club. 5 0 0
Sums under 5s. - 17 0
Total Dons. 10 17 0
Total Subs. 31 0 0
£41 17 0

Co. Kerry.

TRALEE BAY BRANCH.

President—
The Rt. Hon. LORD VENTRY.
Vice-President—
Lieut.-Col. CROSBY.
Honorary Secretary—
Mr. ROBERT McCOWEN, Lloyd's Agent.
Annual Subscriptions.
£. s. d.
Listowel, The Right Hon. Lord 2 0 0
Donovan, Sir Henry 2 2 0
Hawkey, Capt. R.N. 1 1 0
M'Cowen, R. Esq. 1 1 0
Total 6 4 0

VALENTIA BRANCH.

Hon. Secretary—
Mr. JOHN O'DRISCOLL.
Annual Subscriptions.
Butler, James, Esq. ... 1 0 0
Crosby, W. T. Esq. (two years) ... 2 0 0
Dunraven, The Earl of. 1 1 0
Fitzgerald, J. F. Esq. - 10 0
Hartopp, E. B. Esq. ... 1 0 0
Kerry, The Knight of Lansdowne, The Marquis of. 4 0 0
Leahy, John White, Esq. 1 0 0
O'Connell, Dan. Esq. Derrynane. 1 0 0
Slaughton, T. A. Esq. 1 0 0
Trinity Col. Dublin. 3 3 0
Total £17 14 0

Co. Limerick.

LIMERICK BRANCH.

Secretary and Collector—
Mr. J. PIKE.
Annual Subscriptions.
£. s. d.
Alexander, Jas. Esq. 1 0 0
Bannatyne, J. & Son. 1 0 0
Boyd, J. and G. 1 0 0
Clarina, Lady 1 0 0
Fitt, Charles H. - 5 0
Fitt, Edward 1 0 0
Harris, Messrs., and Sons 5 0 0
Limerick Harbour Commissioners. 5 0 0
Matterson and Sons, Messrs. 1 0 0
Murray, Archibald. 1 0 0
Russell, Arthur 1 0 0
Russell, Charles. - 5 0
Russell Jno. N. 1 0 0
Shaw & Sons, Messrs. W. J. 1 0 0
Spaight and Sons, Messrs. F. 1 0 0
Todd and Co. Messrs. Wallace, Richard ... - 5 0
Pillar Box - 5 6
Total £17 0 6

Co. Londonderry.

LONDONDERRY AND GREENCASTLE BRANCH.

President—
JOHN COOKE, Esq.
Honorary Secretaries—
PIERCE, CROSSIE, Esq.
THOMAS LLOYD, Esq.
Annual Subscriptions.
£. s. d.
Anderson, Mr. (late Miles and Co.) ... - 5 0
Andrews, William ... - 5 0
Biggar, Mr. W. F. ... - 5 0
Black and Co., A. ... - 10 0
Campbell, Robt. ... - 5 0
Chambers, Thomas ... - 5 0
Christy, John ... - 5 0
Colhoun, Jas. ... - 5 0
Cooke, J. and J. ... - 10 0
Corscaden, James ... - 10 0
Crosbie, Pierce ... - 5 0
*Donnegall, Lord. ... 2 0 0
Donnell & MacCaveith - 5 0
Ferris, Mr. Jos. - 5 0
Gorton, Thomas ... - 5 0
Hastings, Boss ... - 5 0
Hegan, T. M. - 5 0
Irvine and Co. - 5 0
Liverpool Steamboat Office - 10 0
Lloyd, T. W. - 5 0
Londonderry Port and Harbour Commissioners 10 0 0
Mayor & Co. Alex. ... - 10 0
*McClellan, Rev. T. ... - 10 0
M'Corkell, Jas. - 5 0
M'Vicker, Mr. - 5 0
Mulholland & Co. J. - 10 0
Newton, R. W. - 10 0
O'Neill, Mr. Chas. ... - 5 0
Osborn & Patton ... - 5 0
Pollock and Co. J. J. - 5 0
Russell, James ... - 10 0
Sawers and Co. - 5 0
Scotch Steamboat Office (McNeil) ... 1 0 0
Do. (Burns) 1 0 0
*Scott, Rev. T. - 5 0
*Sepper, R. - 5 0
Steel & M'Caskeil ... - 10 0
Talbot and Co. - 5 0
Watson, Thos. - 5 0
Watt and Co., D. - 10 0
Williams, Mr. - 5 0
Wilson & Co., A. - 5 0
*Young, Capt. - 5 0
Box at Gruncarth Hotel (Mr. Leake) - 10 10
Sums under 5s. 2 8 3
£29 9 1

BRANCHES—LIST OF ANNUAL SUBSCRIPTIONS AND DONATIONS. 169

Cos. Louth and Meath.		DUNDALK BRANCH.		Harbour Commissioners, The		Whalley, Robt. Jun.	
DROGHEDA BRANCH.		Chairman—		Holland, Dr.		White Brothers,	
Patron—		MICHAEL KELLY, Esq. J.P.		Hudson, Capt. R. P.		Messrs. 3 0 0	
HONORARY SECRETARY AT BALTRAY—		HONORARY SECRETARY—		Hudson, R. G. Esq.		*White, Edwin, Esq.	
NICHOLAS HALIGAN, Esq.		J. F. FARRELL, Esq.		Humble, Sir J. Nugent, Bart.		White, George, Esq.	
HONORARY SECRETARY FOR MORNINGTON—		ANNUAL SUBSCRIPTIONS.		Hunt, John, Esq.		White, William Esq.	
H. T. CANNON, Esq.		£. s. d.		McGwire, S. E. Esq.		Wilson, John, Esq.	
SECRETARY AND COLLECTOR—		KELLY, MR. 1 0 0		Moloney, Mrs. A.		Coll. by Mrs. Davis	
MR. J. McNAMARA.		ROBSON, WM. 1 0 0		Power, Sir R. Bart.		Ennescorthy 4 0 0	
ANNUAL SUBSCRIPTIONS.		TEMPEST, WM. 1 0 0		Ussher, R. J. Esq.		Total 63 6 0	
£. s. d.		Total 3 0 0		Waterford, Lord.		Donations.	
Balfour, B. T., D.L. 1 0 0		Dundalk Harbour Commissioners ... 15 1 0		Williams, Mr. John.		Bowman, E. - 5 0	
Bank of Ireland. 1 0 0		£18 1 0		Sums under 5s. 3 13 0		£63 11 0	
Belfast Banking Co. 1 0 0		Co. Waterford.		Total £18 3 0		Donations.	
Branigan, Laurence, H.C. - 5 0		ARDMORE BRANCH.		*Armstrong, George, Esq. - 7 6		—	
Brodrigan, Lieut.-Col., 25th Regiment 1 0 0		Chairman—		Hawney, John - 5 0		Co. Wexford.	
Cairnes, T. P., J.P. - 10 0		Rev. THOMAS R. ROTHWELL.		Merriack and Ruddell - 10 0		CAHORE BRANCH.	
Cathcart, Mrs. - 5 0		HONORARY SECRETARY—		Sayers, Mrs. M. - 5 0		Honorary Secretary—	
Chadwick, Messrs. J. and F. - 10 0		MR. HENRY COOPER.		Tottenham, Capt. F.L. - 5 0		Capt. RICHARD D'OLIER GEORGE.	
Clinton, Robert. 5 0		ANNUAL SUBSCRIPTIONS.		Total £19 15 6		Assistant Hon. Secretary—	
Coddington, H. B., J.P. - 10 0		£. s. d.		*Denny and Sons, Messrs. Henry 2 0 0		MR. JOHN SINNOTT.	
Conry, Marquis 1 0 0		Cotton, Charles P. Esq., C.E. 1 0 0		*Denny, Charles, Esq. - 10 0		ANNUAL SUBSCRIPTIONS.	
Corbally, Hon. Mrs. 2 0 0		*Cooper, Mr. Henry. - 5 0		*Digby, Capt. R.N. - 10 0		Bates, Mr. James. 7 6	
Daly, Alderman, J.P. - 10 0		Cotton, Major - 10 0		Doneraile, Lord. 3 0 0		Bolton, Wm. Esq. 1 0 0	
Darnley, Earl of. 2 0 0		Cotton, R. W. Esq. - 10 0		Dormer, Thos. P. Esq. - 10 0		Bond, E. C. Esq. - 10 0	
Davis & Co. Messrs. A. - 10 0		Cotton, Miss - 10 0		Fortescue, Earl. 2 0 0		Bong, R. G. Esq. 1 0 0	
Dean, Joseph. - 10 0		Cotton, Miss Mary. - 10 0		*Fortescue, Hon. D. 2 0 0		Bryan, L. A. Esq. (18-1-52) 4 0 0	
Donagh, Francis, J.P. 1 0 0		Donoughmore, Earl of 1 0 0		Galway, Henry 2 0 0		Burkitt, T. H. Esq. - 5 0	
Greene, Jno. J. F., C.E. 5 0		*Dawson, Capt. - 10 0		Goff, William D. - 10 0		Chambers, Rev. J.W., D.D. - 10 0	
Grendon & Co. Messrs. Thomas - 10 0		*Douglas, Mr. Arthur 5 0		Goff, William D. - 10 0		City of Dublin Steam-packet Company. 1 1 0	
Halligan, Nicholas. - 5 0		*Foley, Thos. Esq. 1 0 0		Graves, J. P. Esq. - 10 0		Collins, Capt. R.N. 1 0 0	
Hibernian Bank - 10 0		J.P. - 10 0		Grubb, Miss H. 1 0 0		Corcoran, John, Esq. - 10 0	
Hill, R. R. - 5 0		*Foley, Richard, Esq. C.E. - 10 0		Grubb, Misses L. & S. 1 0 0		Courtown, Earl of. 1 0 0	
Hughes, John - 5 0		*Foley, Edmund, Esq. - 10 0		*Hanrahan, P. F. Esq. of Harbour Board of Waterford 10 0 0		Day, Rev. A. B. - 10 0	
Jameson, James, J.P. 1 0 0		*Keane, Col. C. B. 1 0 0		Jacob, Edward 1 0 0		Donovan, Rich. Esq. - 5 0	
Kennedy, Richard, H.C. - 5 0		*Musgrave, Sir Richd. Bart. 2 0 0		Jacob, Francis - 10 0		Doyle, C. M. Esq. 1 0 0	
McDonagh, Edward. - 5 0		*McKenna, Sir J. Neale, M.P. 1 0 0		Jacob, Mrs. (London) - 5 0		Eaton, Messrs. M. & S. 10 0	
Moore, John, H.C. - 5 0		Paul, Sir Robert J., Bart. 1 0 0		Kavanagh, Lady Harriet. 1 0 0		Foster, W. O. Esq. 1 0 0	
Montgomery, Richard T., J.P. - 10 0		*Poole, Wm. C. Esq. J.P. - 10 0		Kent, David, Esq. - 5 0		Furlong, Rev. J. L., P.P. 1 0 0	
Morton, Messrs. J. and R. - 10 0		*Rothwell, Rev. Thos. R. - 5 0		Murray, H. Esq. - 10 0		George, Mrs. Mary, Sen. - 10 0	
Munster Bank. - 10 0		Stuart, H. Villiers, Esq., M.P. 5 0 0		O'Shea, Lady G. 1 0 0		*George, Capt. R. D'O. 1 0 0	
Pepper, Charles. 1 0 0		Usher, J. Esq. 1 0 0		*Peet, Edward G. Esq. - 10 0		Godkin, Mr. J. - 10 0	
Pepper, Misses 1 0 0		Total £19 5 0		Power, E. H. Esq. - 10 0		Graves, E. Esq. 1 0 0	
Pepper, Thomas St. George, D.L. 1 0 0		DUNGARVAN BRANCH.		Power, P.W. Esq. J.P. 1 0 0		*Hinds, Rev. C. - 5 0	
Provincial Bank. - 10 0		Patron—		*Power, Rev. R. P.P. - 10 0		Hogan, J. A. Esq. 1 1 0	
Reilly, Patrick, H.C. - 5 0		HIS GRACE THE DUKE OF DEVONSHIRE, K.G.		*Pope, Messrs. H. & W. - 10 0		Hughes, Sir F. Esq. 1 0 0	
Saw Mills Company. - 10 0		President—		Riall, J. Esq. - 10 0		Lee, Lieut. - Colonel W. H. - 10 0	
Smith, R., J.P. - 10 0		LORD STUART DE DECIES.		Riall, Miss. - 10 0		Lloyd, M. Esq. - 10 0	
Smyth, R., J.P. - 10 0		Treasurers—		Ryan, Lawrence, Esq. - 10 0		Murdoch, Rev. J. C. 1 0 0	
Smyth, Miss - 5 0		NATIONAL BANK.		Slattery, Messrs. - 10 0		Murphy, J. Esq. - 10 0	
Smyth, Misses Anna and Ethel. - 2 0 0		Honorary Secretary—		Strangman, S. Esq. 1 0 0		Murphy, Michael, Esq. - 10 0	
Steam Packet Co. 5 0 0		MR. JAMES W. SHAW.		Strangman, Miss C.M. 5 0 0		Murphy, Rev. P., C.C. - 10 0	
The Harbour Board. 10 0 0		ANNUAL SUBSCRIPTIONS.		*Toppin, Rev. R. - 10 0		O'Brien, Rev. J., P.P. - 10 0	
Toker, Capt. Edw., s.s. <i>Norah Creina</i> - 5 0		*Anthony, M. A. Esq. - 5 0		Tottenham, Mrs. W. D. 1 1 0		Pounden, J. C. Esq. - 7 6	
Usher, Robert. - 5 0		Ardagh, W. M. - 5 0		Ward Brothers. - 10 0		Power, Sir Jno. Bart. 1 0 0	
Wetherill and Co. Messrs. - 10 0		*Curran, Capt. R. - 5 0		Wark, Miss. - 10 0		Richards, Mrs. 1 0 0	
Whitworth, Wm., J.P. - 10 0		*Gibbons, Capt. Wm. - 10 0		Waterford Steam Ship Co. 5 0 0		Richards, Mrs. - 10 0	
Whitworth, Nicholas - 10 0		*Hallowes, Rev. R. C. 1 0 0				Roche, Mrs. 1 0 0	
Woolsey, Jameson, & Co. Messrs. - 10 0						Scott, J. S. Esq. 1 0 0	
Bank of Ireland Box 1 1						*Stannott, Mr. John. - 10 0	
Belfast Bank Box 3 4						Symes, Miss. 1 0 0	
Custom House Box 3 2						Warren, G. W. Esq. - 10 0	
Provincial Bank Box 3 7						Whitcroft, Jno. Esq. 1 0 0	
Steam Packet Office Box. - 4 0						Sums under 5s. - 5 0	
Total £42 17 2						Total £32 17 0	

CARNSORE BRANCH.

Chairman— Hon. J. A. KEANE, D.L.
Honorary Secretary— E. A. GIBBON, Esq.

Table with columns for names and amounts. Includes 'Annual Subscriptions' and 'Donations' sections. Total: 14 19 0.

Table with columns for names and amounts. Includes 'Donations' section. Total: £16 11 6.

COURTOWN BRANCH.

Patron— Rt. Hon. Earl of COURTOWN.
Treasurer and Hon. Sec.— JAMES S. SCOTT, Esq., J.P.

Table with columns for names and amounts. Includes 'Annual Subscriptions' section. Total: £17 14 3.

Table with columns for names and amounts. Includes 'Annual Subscriptions' section. Total: 28 6 0.

Table with columns for names and amounts. Includes 'Donations' section. Total: £30 5 11.

DUNCANNON AND WATERFORD HARBOUR BRANCH.

Chairman— Sir ROBERT PAUL, Bart.
Honorary Secretary— Mr. J. MCGONAGIL.

Table with columns for names and amounts. Includes 'Annual Subscriptions' section. Total: £15 18 0.

WEXFORD AND ROSSLARE BRANCH.

Chairman— R. J. DEVEREUX, Esq.
Honorary Secretary— WILLIAM COGHLAN, Esq., J.P.

Table with columns for names and amounts. Includes 'Annual Subscriptions' section. Total: £22 13 6.

Table with columns for names and amounts. Includes 'Annual Subscriptions' section. Total: £32 18 6.

Co. Wicklow. ARKLOW BRANCH.

Chairman— The EARL OF CARYSPORT.
Treasurer— PETER J. BLAKE, Esq.
Honorary Secretary— The EARL OF WICKLOW.

Table with columns for names and amounts. Includes 'Annual Subscriptions' section. Total: £22 13 6.

GREYSTONES BRANCH.

President— THE EARL OF MEATH.

Chairman— WM. R. LA TOUCHE, Esq.
Honorary Secretary— PATRICK REID, Esq.

Table with columns for names and amounts. Includes 'Annual Subscriptions' section. Total: £22 13 6.

Table with columns for names and amounts. Includes 'Annual Subscriptions' section. Total: 21 1 0.

WICKLOW BRANCH.

Patrons— The Right Hon. the EARL FITZWILLIAM and W. W. FITZWILLIAM DICK, Esq., M.P.

Chairman— *Capt. H. SEGRAVE.
Treasurer and Hon. Sec.— S. E. PIM, Esq.

Table with columns for names and amounts. Includes 'Annual Subscriptions' section. Total: £17 14 3.

Isle of Man.

CASTLETOWN BRANCH.

Chairman— J. M. JEFFCOCK, Esq., High Bailiff.

Honorary Secretary— GEORGE H. QUAYLE, Esq.

Table with columns for names and amounts. Includes 'Annual Subscriptions' section. Total: £22 13 6.

BRANCHES—LIST OF ANNUAL SUBSCRIPTIONS AND DONATIONS. 171

	£.	s.	d.
Gill, Fred I.	5	0	0
Gill, Mrs.	5	0	0
Harrison, T. A.	5	0	0
Hughes-Games, Rev. J., D.C.L.	5	0	0
Isle of Man Steam- packet Company..	2	2	0
McClellan, Miss	5	0	0
Moore, Thos. Esq.	5	0	0
Moore, W. F. Esq.	10	0	0
Newton, Miss.	5	0	0
Quayle, Geo. P. Esq.	5	0	0
Quayle, Mrs.	10	0	0
Stevenson, W. B.	10	0	0
The Archdeacon Moore— The Clerk of the Rolls ..	5	0	0
*The High Bailiff.	5	0	0
Trafford, Rev. W.	5	0	0
Woodhouse, Mrs.	5	0	0
Sums under 5s.	3	15	0
Life-boat Boxes	1	0	0
Total.	£19	7	0

DOUGLAS BRANCH.

Patron— His Excellency the LIERT- GOVERNOR.			
President— THE HIGH BAILIFF OF DOUGLAS.			
Treasurer and Hon. Sec.— THOMAS BAWDEN, Esq.			
<i>Annual Subscriptions.</i>			
His Excellency the			
Lieut.-Governor ..	2	2	0
*Archer, R. Esq.	5	0	0
*Bawden, T. Esq.	5	0	0
*Bell, R. T. (1881-82) 1	0	0	0
Bowman, E. Esq.	5	0	0
*Brown, J. Esq.	5	0	0
Callow, T. C. Esq.	5	0	0
Cannell, Mrs.	10	0	0
Cannell, Miss	5	0	0
Clinch, J. W. Esq.	5	0	0
Clucas, Miss	1	0	0
Coole, James, Esq.	5	0	0
*Corlett, Capt. T.	5	0	0
Cowell, J. Esq.	5	0	0
Cubbon, Joseph, Esq.	5	0	0
<i>Donations.</i>			
G. H. W.	1	1	0
Contents of Con- tribution Boxes ..	18	4	5
Thanksgiving from Shareholders of the I. O. M. Steam Packet Company, per Mrs. Hall	13	18	0
Total Dons. .	33	3	5
Total Subs. .	36	11	0
£89 14 5			

RAMSEY BRANCH.

President— His Excellency the LIERT- GOVERNOR.			
Chairman— Rev. G. PATON, Vicar of S. Paul's.			
Honorary Secretary— E. C. KERR, Esq.			
<i>Annual Subscriptions.</i>			
	£.	s.	d.
His Excellency the			
Lieut.-Governor ..	2	2	0
His Honor Deemster			
Dumbell.	2	2	0
Allen and Tauiman.	5	0	0
Archdeacon the Vener- able.	1	1	0
Breton, Gen.	5	0	0
*Brown, Capt. R.	5	0	0
*Brown, Capt. W.	10	0	0
Clarke, Mr. R. R.	5	0	0
*Cleator, Mr. Robt.	5	0	0
Clucas, Dr.	5	0	0
Corkill, Mr. Thos.	5	0	0
Crennell, Mr. W.	5	0	0
*Cruickshank, J. M.	10	0	0
*Farrant, Mr. E. C., H.K., J.P.	1	0	0
Fletcher, Mrs.	5	0	0
Gibb, Mrs.	1	0	0
Gilmour, Mrs.	5	0	0
Goldsmith & Cowley Isle of Man Steam Packet Company.	2	2	0
Kermode, Rev. W.	10	0	0
*Kerr, E. C.	10	0	0
Lamothe, Mr. J. C., H. B.	5	0	0
*Lucas, Mr. K.	1	1	0
Martin, Mr. Thos.	5	0	0
Paterson, Mr. A. C.	5	0	0
*Paton, Rev. G.	1	0	0
Roose, Mr. W. D.	5	0	0
Rudd, Mr. T. B.	5	0	0
Scott, Mrs.	1	1	0
Skillicorn, Wm.	10	0	0
Teare and Co.	5	0	0
Thellusson, Colonel, J.P.	1	0	0
*Thellusson, Mr. E. J.P.	1	0	0

	£.	s.	d.
Walker, G. H.	1	1	0
Williams, Mr. A.	5	0	0
Wood, Dr.	5	0	0
Sums under 5s.	2	14	0
Total.	25	9	0
Lucas's, Mrs. Box ..	15	6	
Life-boat do.	1	12	5
Albert Hotel do.	6	4	
Mitre do. do.	8	2	
Saddler do. do.	1	0	7
Small Sums	16	11	
Total Dons.	4	19	11
Total Subs.	25	9	0
£30 8 11			

CHANNEL ISLANDS.

GUERNSEY BRANCH.

Chairman— Capt. P. DE SAUSMAREZ, R.N.			
Honorary Secretary— Capt. CARRÉ, R.N.			
<i>Annual Subscriptions.</i>			
	£.	s.	d.
States of Guernsey .	30	0	0
Lockett, Mrs. and Misses.	5	0	0
Total.	£35	0	0

The following is a copy of a Handbill circulated on the Coasts of the United Kingdom by the Institution, for the purpose of informing Boatmen and others that it encourages laudable exertions to save Life from Shipwrecks:—

TO BOATMEN AND OTHERS.

To encourage prompt and energetic exertions in time of Danger on the part of Boatmen and Others, by quickly putting off to save Life in CASES of WRECKS on the Coasts of the British Isles, either by

SHORE-BOATS OR OTHER MEANS,

The Royal National Life-boat Institution

GRANTS

Rewards of Money or Medals. In all cases the Rewards are given without further delay than is necessary to obtain proof of the merits of each case, and to ensure their being paid to the right parties.

Application to be made to the Secretary.

By Order of the Committee.

ROYAL NATIONAL LIFE-BOAT INSTITUTION.

SUPPORTED SOLELY BY VOLUNTARY CONTRIBUTIONS.

Patroness—Her Most Gracious Majesty the Queen.

President—His Grace the DUKE OF NORTHUMBERLAND, P.C., D.C.L.

Chairman—EDWARD BIRKBECK, ESQ., M.P., V.P. Deputy Chairman—Colonel FITZ-ROY CLAYTON.

Services of the Life-boats of the Institution in 1882.

<i>Aigle</i> , brig, of St. Servan..... 7	Fishing boats, of Newbiggin— —rendered assistance.	<i>Nordstjernen</i> , sloop, of Hangesimo 5
<i>Alert</i> , smack, of Lowestoft— saved vessel and..... 6	Fishing coble, of Holy Island— saved boat and crew..... 4	<i>Ocean</i> , smack, of Cardigan..... 2
<i>America</i> , brigantine, of Quebec... 8	<i>Formosa</i> , yacht, of Carmarthen... 2	<i>Ocean Child</i> , schooner, of Belfast 3
<i>Amity</i> , billyboy, of Goole—ren- dered assistance.	<i>Fortuna</i> , barque, of Arendal... 10	<i>Otto</i> , brigantine, of Hognas... 9
<i>Amulet</i> , s.s., of Rotterdam..... 21	<i>Gander</i> , smack, of Cardigan.... 3	<i>Percy</i> , brig, of Riga—saved 3 of crew..... 3
<i>Anapira</i> , schooner, of Kirkcaldy saved vessel and crew..... 5	<i>Gateforth</i> , galliot, of Whithorn —remained by vessel:	<i>Perseverance</i> , schooner, of Belfast 6
<i>Andreas</i> , brigantine, of Skjelskes, Denmark..... 8	<i>Gettrude</i> , <i>Gladstone</i> and <i>Shah</i> , fishing boats of the Mumbles— assisted to save vessels and... 9	<i>Queen</i> , schooner, of Inverness... 4
<i>Arab</i> , yacht, of Poole..... 9	<i>Glanmania</i> , schooner, of Beau- maris..... 3	<i>Quick and Gyles</i> , luggers, of St. Ives..... 14
<i>Argo</i> , schooner, of Copenhagen— rendered assistance.	<i>Happy Return</i> , ketch, of Padstow 4	<i>Rambler</i> , schooner, of Polkestone 4
<i>Arzel</i> , brig, of Youghal..... 7	<i>Harkaway</i> , brig, of Shoreham— rendered assistance.	<i>Rapid</i> , smack, of Cardigan..... 3
<i>August</i> , brig, of Grieswald—ass- isted to save vessel and..... 7	<i>Harriet</i> , ketch, of Goole—assisted to save vessel and those on board..... 8	<i>Reine des Anges</i> , dandy, of Bou- logne—rendered assistance.
<i>Belle</i> , smack, of Blyth..... 6	<i>Henrietta</i> , schooner, of London... 4	<i>Rheinland</i> , barque, of Hamburg —saved two of the crew..... 2
<i>Ben & Louisa</i> , boat, of Southold 4	<i>Hope</i> , dandy, of St. Ives—saved vessel and..... 3	<i>Rose</i> , schooner, of Carnarvon... 3
<i>Beatrix</i> , schooner, of Shoreham... 3	<i>Hoppet</i> , schooner, of Helsingborg 5	<i>Ross</i> , barque, of Arendal—saved crew..... 10
<i>Blue Bell</i> , ketch, of Padstow... 3	<i>Iona</i> , schooner, of Padstow..... 7	<i>R. W. Hoyd</i> , s.s., of North Shields 14
<i>Bocannon</i> , smack, of Padstow— assisted to save vessel and... 3	<i>Irvine</i> , steam tug, of Irvine..... 4	<i>Rydal Hall</i> , s.s., of Liverpool— rendered assistance.
<i>Bon Accord</i> , lugger, of Portknockie 3	<i>Isis</i> , brig, of Whitby..... 1	<i>St. George</i> , brig, of Maryport... 9
<i>Bradley</i> , s.s., of Liverpool—ass- isted to save vessel and crew... 15	<i>Istwyth</i> , schooner, of Carnarvon 3	<i>Saraca</i> , barque, of Glasgow—re- mained by vessel.
<i>British Queen</i> , schooner, of Wex- ford..... 4	<i>Jane</i> , schooner, of Faversham... 2	<i>Sisters</i> , fishing smack, of Gories- ton—saved vessel and..... 1
<i>Brothers</i> , schooner, of Harwich— rendered assistance.	<i>Jane Anwyll</i> , schooner, of Carnar- von..... 3	<i>Sophia</i> , lighter, of Hull..... 3
<i>Burthon</i> , Norwegian barque... 8	<i>Jean Anderson</i> , brigantine, of Dundalk..... 6	<i>Spider</i> , yacht, of Ramsgate—ass- isted to save vessel and crew... 9
<i>Cannore</i> , barque, of Dundee— assisted to save vessel and... 17	<i>John</i> , brig, of Hartlepool..... 7	<i>Star</i> , schooner, of St. Agnes... 3
<i>Carolina</i> , barque, of Hernessand —rendered assistance.	<i>John</i> , barge, of Faversham... 2	<i>Star of Hope</i> , brig, of Newcastle <i>Steam Boat</i> , lugger, of Arklow— saved boat and crew..... 4
<i>Catherina Regina</i> , brig, of Riga. 3	<i>John and Ann</i> , schooner, of Run- corn..... 3	<i>Storjohann</i> , Norwegian barque, assisted to save derelict vessel.
<i>Centenary</i> , schooner, of Liverpool 4	<i>John Stenard</i> , schooner, of Aber- ystwith..... 4	<i>Susannah Dixon</i> , brig, of Whitby 8
<i>Charles</i> , schooner, of Carnarvon 3	<i>J. W. T.</i> , schooner, of Truro— rendered assistance.	<i>Swift</i> , brig, of Krageroe—assisted to save vessel and..... 8
<i>Commerce</i> , smack, of Cardigan... 2	<i>Killywake</i> , s.s., of Liverpool... 7	<i>Swift</i> , brigantine, of Rye—assisted to save vessel and..... 5
<i>Concordia</i> , schooner, of Guernsey 6	<i>Korkinour</i> , schooner, of Beau- maris..... 4	<i>Thomas and Sons</i> , dandy, of Aberystwith..... 3
<i>Conqueror</i> , smack, of Newburgh 2	<i>Lake Nepigon</i> , s.s., of Montreal. 52	<i>Three Brothers</i> , schooner, of Chea- ter..... 2
<i>Countess of Caithness</i> , schooner, of Gloucester—saved vessel and 4	<i>Laura Ann</i> , schooner, of Faver- sham—rendered assistance.	<i>Venus</i> , barque, of Helsingborg— rendered assistance..... 12
<i>Danmark</i> , brig, of Dracor..... 10	<i>Liban</i> , s.s., of Nantes..... 8	<i>Venus</i> , schooner, of Exeter—ren- dered assistance.
<i>Dazzler</i> , yawl, of Wexford..... 6	<i>Libra</i> , schooner, of Bockzeteler- fahn..... 5	<i>Victoria</i> , schooner, of Beaumaris 2
<i>Drumhendry</i> , s.s., of Glasgow... 2	<i>Llaciñu</i> , schooner, of Newquay... 4	<i>Vigilant</i> , schooner, of Dundee— rendered assistance.
<i>Ebenezer</i> , galliot, of Stavanger... 5	<i>Louisa</i> , brig, of Stettin..... 6	<i>Volant</i> , schooner, of Wick..... 4
<i>Ecurieuil</i> , lugger, of Gravelines.. 5	<i>Margaret</i> , smack, of Cardigan... 2	<i>Wellington</i> , brig, of Aberystwith 11
<i>Eden</i> , barque, of Liverpool—ass- isted to save vessel and crew... 17	<i>Martha Jane</i> , smack, of Aber- ystwith..... 3	<i>Wilhelmina</i> , brigantine, of Exeter —rendered assistance.
<i>Edmund</i> , Danish schooner..... 7	<i>Mary</i> , schooner, of St. Ives... 6	<i>Xanthus</i> , brigantine, of Aberyst- with..... 8
<i>Elizabeth</i> , brig, of Arklow..... 5	<i>Mary Anne Jane</i> , smack, of Car- narvon..... 3	Total lives saved by Life-boats in 1882, in addition to Twenty- three vessels..... 741
<i>Elizabeth</i> , schooner, of Aberyst- with..... 8	<i>Mary Steens</i> , smack, of Padstow 4	During the same period the Insti- tution granted rewards for saving lives by fishing and other boats 143
<i>Ellen</i> , smack, of Milford..... 3	<i>Mary Wood</i> , brigantine, of Belfast —rendered assistance.	Total of lives saved } 884 in 1882.....
<i>Emerald Isle</i> , lugger, of Howth... 2	<i>Matin</i> , s.s., of Sunderland..... 16	
<i>Erminia</i> , Norwegian barque— rendered assistance.	<i>Mina</i> , barque, of Kalmars, Sweden 10	
<i>Eugenie Auguste</i> , schooner, of Castletown..... 5	<i>Mornington</i> , brig, of Colchester.. 8	
<i>Europe</i> , barque, of Bordeaux... 6	<i>Mosel</i> , s.s., of Bremen..... 27	
<i>Evening Star</i> , ketch, of Hull— assisted to save vessel and crew 3	<i>Napier</i> , s.s., of Shields—remained by vessel.	
<i>Expedis</i> , brigantine, of Porsgrund 6	<i>Newbiggin</i> , fishing coble—saved coble.	
<i>Fanny</i> , sloop, of Fishguard— saved vessel and..... 2	<i>Nisarod</i> , barque, of Liverpool... 18	

The number of lives saved either by the Life-boats of the Institution, or by special exertions for which it has granted rewards, since its formation, is 29,603; for which services 98 Gold Medals, 962 Silver Medals and £72,600 in cash have been granted as rewards.

The average expense of a Life-boat Station is £1,000. Its cost for a 10-oared boat is made up as follows:—
Life-boat and her equipment, including Life-belts for the crew, and Transporting-carriage for the Life-boat... £650
Boat-house (average cost)..... 350
Total..... £1,000

The average annual expense of maintaining a Life-boat Station is £70.

Donations and Annual Subscriptions are thankfully received by the Bankers of the Institution, Messrs. COURTS AND CO., 59 Strand; Messrs. HERRIES, FARQUHAR, AND CO., 16 St. James's Street; Messrs. HOARE, 37 Fleet Street, London; by all the other Bankers in the United Kingdom; by all the Life-boat Branches; and by the Secretary, CHARLES DUNN, Esq., at the Institution, 14 JOHN STREET, ADELPHI, LONDON, W.C.—May 1 1883.