

THE LIFE-BOAT,

OR

JOURNAL OF THE NATIONAL LIFE-BOAT INSTITUTION.

(ISSUED QUARTERLY.)

VOL. XI.—No. 124.]

MAY 1, 1882.

[PRICE 1s.

At the ANNUAL GENERAL MEETING of the ROYAL NATIONAL LIFE-BOAT INSTITUTION, held at the Mansion House on Thursday, the 23rd day of March, 1882, The Right Hon. The LORD MAYOR of LONDON in the Chair, the following Report of the Committee was read by the Secretary:—

ANNUAL REPORT.

BEFORE proceeding to dwell on the transactions of the Institution for the past year, the Committee feel constrained, on this the earliest opportunity presented to them, to tender their heartfelt congratulations to Her Majesty the Queen—who has been the Patroness of the Institution, and a supporter of its funds for forty-four years—on Her Majesty's providential preservation from recent danger.

Another year—a year which, as much or more than any of its predecessors, has exhibited the value, nay the necessity, of our noble Life-boat Fleet—has passed away! Happily, also, another glorious tale of lives saved, of bravery shown, of hardship cheerfully endured has to be added to that perennially lengthened chain which, year by year, link by link, adds to and illustrates the history of the NATIONAL LIFE-BOAT INSTITUTION! Happily, likewise, the Committee are gratefully able to record that their countrymen have shown their appreciation of these continued invaluable Life-boat services by their munificent pecuniary support, which has

enabled them so successfully to prosecute the onerous duty that has been confided to them.

The transactions of the year may be summarised under the usual heads.

Life-boats.—Since the last Annual Report eleven new Life-boats have been placed on the coast, two sent to new stations, and the remainder to replace other boats.

The following are the stations to which those Life-boats have been or are about to be sent:—

ENGLAND AND WALES.

NORTHUMBERLAND	Bamborough Castle.
YORKSHIRE	Robin Hood's Bay.
"	Whitby.
NORFOLK	Palling.
ESSEX	Harwich.
SUSSEX	Newhaven.
GLAMORGANSHIRE . .	Penarth.
PEMBROKESHIRE . . .	Little-Haven, St. Bride's Bay.
CARNARVONSHIRE . .	Portmadoc.
ANGLESEY	Cemaes.

IRELAND.

DUBLIN Poolbeg.

Seven of the above boats have been supplied with transporting-carriages, and for three of them new boat-houses have been built.

During the year 1881 the Life-boats of the Institution saved no less than *nine hundred and sixty-six* lives, being the largest number saved in any one year since its first establishment.

Gladly would the Committee have been able to report that these numerous services had been rendered without loss of life amongst the brave men who performed them; but God willed otherwise, and on four occasions the Life-boats upset, viz., those stationed at Newhaven, Torquay, Skerries (in County Dublin, Ireland), and at Douglas, Isle of Man. From the three first named boats no lives were lost; but it is their painful duty to state that four of the Douglas Life-boat's crew were drowned. The accident occurred in a dark night when the boat was running before a gale of wind and a heavy sea, so that the drowning men could not, through the darkness, be discovered.

It is to be feared that such sad accidents must from time to time occur, and all that the Institution can then do is to liberally contribute towards the maintenance of the bereaved families of the gallant men who have thus sacrificed their own lives in a noble endeavour to save those of their fellow-creatures.

Shipwrecks.—The Committee are much gratified and encouraged by the fact that the Life-boats of the Institution saved last year nearly one thousand lives. Nevertheless it is their painful duty to refer to the distressing Shipwrecks which took place during the same period, particularly to those which occurred in the months of October and November last. Indeed, the gales of those two months were unprecedented in their fury and destruction; and so again, on that account, the services of the Life-boats were most frequent, and, happily, most successful, *four hundred and forty-one* lives having been saved during those storms alone.

These services of the Life-boats continue to elicit not only the gratitude of

the rescued sailors themselves, but also the admiration of the public.

It must also be borne in mind that the Life-boats often contribute to the saving of valuable ships and cargoes from absolute destruction, *thirty-three* vessels having been saved by them last year. They are also occasionally signalled off by a fleet of fishing-boats which have been overtaken by sudden storms, the Life-boat often acting as protector to them, frequently remaining by them for hours together, and ultimately piloting them safely ashore.

The number of Life-boats now under the management of the Institution is *Two hundred and seventy-one*, and their services during each month of the year were as follows:—

1881.	Number of Life-boat Launches.	Vessels Saved.	Lives Saved.
January	67	7	150
February	41	2	93
March	55	3	116
April	12	1	18
May	9	3	29
June	4	—	11
July	2	1	4
August	23	—	35
September	15	1	24
October	71	8	280
November	49	5	161
December	26	2	45
Total	374	33	966

In addition to these services, 155 lives were saved from shipwreck by shore-boats and other means, which had received rewards from the Institution, making a total of 1121 lives rescued last year.

It is also gratifying to announce that upwards of 500 lives were saved last year by means of the Rocket Apparatus belonging to the BOARD OF TRADE, which is worked so efficiently by the Coast-guard and the Rocket Volunteer Brigades.

This branch of the Life-saving Service has received much encouragement from the presence and supervision of H.R.H. the Admiral-Superintendent of Naval Reserves, who also continues to manifest his interest in the success of the Life-boat Service.

The number of lives saved during the fifty-eight years from the establishment of the Institution, to the end of the year 1881, either by its Life-boats or by special exertions for which it has granted rewards, is 28,724, as shown in the following Table:—

In the Year	No. of Lives Saved.	In the Year	No. of Lives Saved.
1824	124	1854	355
1825	218	1855	416
1826	175	1856	473
1827	163	1857	374
1828	301	1858	427
1829	463	1859	499
1830	372	1860	455
1831	287	1861	424
1832	310	1862	574
1833	449	1863	714
1834	214	1864	698
1835	364	1865	714
1836	225	1866	921
1837	272	1867	1,086
1838	456	1868	862
1839	279	1869	1,231
1840	353	1870	784
1841	128	1871	882
1842	276	1872	739
1843	236	1873	668
1844	193	1874	713
1845	235	1875	921
1846	134	1876	600
1847	157	1877	1,048
1848	123	1878	616
1849	209	1879	855
1850	470	1880	697
1851	230	1881	1,121
1852	773	Total	28,724
1853	678		

This is a record of which any community may well be proud, reflecting as it does the greatest credit on those who, by their intrepidity and unceasing exertions, have brought it about; and also on those who, by their pecuniary help to the Institution, have aided in the accomplishment of so great a work.

Rewards.—A summary is given in the Appendix of the cases where honorary and other rewards have been voted last year. In that period 2 Gold Medals, 33 Silver Medals and Clasps, 46 Votes of Thanks inscribed on vellum, and 5,783L. were granted for saving the lives of 1,121 persons by Life-boats, shore and fishing boats, and by other means, on the shores and outlying sandbanks of our coasts.

Much time and consideration are devoted by the Committee to the investigation and granting of these awards; and it is gratifying that their decisions in this respect usually give general satisfaction, and stimulate our coast population to put forth their greatest exertions to save—often at the peril of their own lives—the lives of others.

The Institution continues to receive the cordial and prompt co-operation of the officers and men of the Coastguard service, to whom the Committee tender their best thanks.

Since the establishment of the Institution, it has expended on Life-boat Stations, and other means for saving life from shipwreck, on the coasts of the United Kingdom, upwards of 570,000L., and has voted 95 Gold Medals, 948 Silver Medals, and 70,200L. in pecuniary rewards for saving life from shipwreck.

Local Committees.—The Committee again tender their best acknowledgments for the valuable and earnest co-operation afforded by the Local Branch Committees and their Honorary Secretaries, which constitutes so important and inseparable a part of the work and supervision of the Institution's numerous Life-boat Establishments, and of the collection of funds for their support.

Finances.—During the year 1881 the donations, subscriptions, and dividends amounted to 36,419L. 16s., of which sum 6,022L. 5s. 2d. were special gifts to defray the cost of the following ten Life-boats:—

	£.	s.	d.
Braunton—Miss Leicester, Bayswater	1,000	0	0
Clovelly—The late Mrs. C. G. Hughes, Upper Tooting	1,000	0	0
Newcastle (Dundrum)—E. Armitage, Esq., R.A.	600	0	0
Palling, No. 1—"Heyland" Memorial Fund	418	8	8
Poolbeg—Mrs. E. S. Symes, Ballybrack	600	0	0
Robin Hood's Bay—Mr. and Mrs. Fox's Children, Staincliffe	1,000	0	0
St. Anne's—James Chadwick, Esq. Prestwich (in addition to £1,000 in 1880)	230	0	0
Whitby No. 1—Mrs. A. M. Ellis, York	800	0	0

	£.	s.	d.
Langham Hotel Life-boat Fund (on account)	223	16	6
“Admiral Lutwidge” Memorial Life-boat Fund (on account), per favour of C. R. Fletcher - Lutwidge, Esq.	150	0	0

The Committee have likewise the satisfaction to acknowledge the receipt, since the last Report, of the following other special contributions:—

	£.	s.	d.
HER MAJESTY THE QUEEN (annual subscription)	50	0	0
Ancient Order of Foresters, annual subscription in aid of the support of their two Life-boats, per Samuel Shawcross, Esq.	100	0	0
Browne, G. Buckston, Esq., Halifax (additional)	600	0	0
Felixstowe, proceeds of an Amateur Dramatic Entertainment at, per C. E. Harding, Esq.	5	4	0
Freemasons, Macdonald Lodge of, No. 1,216, per Captain Arthur Styan Hadnall Church, Salop, offertory and collection in, on Sunday, the 6th November, per Rev. Brooke C. Mortimer (additional)	12	15	8
Independent Order of Odd Fellows (M.U.), in aid of the support of the Manchester Unity Life-boat at Cleethorpes (annual subscription) .	50	0	0
Manitoban, collected on board the Allan Line s.s., per Captains McDougall & McNicol (additional)	4	15	10
Orient, collected on board the s.s., per Capt. Hewison	15	0	0

The Institution has been advised of the following Legacies during the past twelve months:—

	£.	s.	d.
Baker, Mrs. J. A., Birmingham	200	0	0
Bax, Mr. Edward, Cockspur Street	100	0	0
Brown, C. R., Esq., Mile End	1,000	0	0
Brown, J. D., Esq., Lyndon, Rutland	10	0	0
Burley, John, Esq., Halifax	260	0	0
Cobb, Mrs. Mary Ann, Jersey	1,621	15	9
Coffin, Admiral H. E., Caversham	100	0	0
Coller, Mrs. C., Montpelier Square	302	6	0
Courtney, Miss A. M., Bournemouth	10	0	0
Cowley, J. C., Esq., Kilsby	10	0	0
Craddock, C. R., Esq., St. John's Wood	100	0	0
Daniel, Miss, Weston-super-Mare	100	0	0
Dewar, Mrs., Edinburgh	88	8	6
Dodd, Henry, Esq., Rotherfield	500	0	0
Downie, Miss, Appin, N.B.	1,000	0	0
Egdell, Miss Ann, Alnwick	1,000	0	0
Forbes, Peter, Esq., and Mrs. Forbes, Dunsholt, Fife	550	0	0
Fortune, Mrs. A. P., Liverpool	200	0	0

	£.	s.	d.
Hartnell, John, Esq., Blomfield St.	100	0	0
Gray, G. M., Esq., Wanganui, N.Z.	500	0	0
Hinkley, John, Esq., Derby	50	0	0
Jay, Mrs. Jane, Great Yarmouth.	19	19	0
Jones, Miss Maria, Waterloo	1,000	0	0
Killington, Mr. E., Great Yarmouth	100	0	0
King, Mrs. Arabella, Kentish Town.	50	0	0
Le Cappelain, J., Esq., Highgate	100	0	0
Luckombe, Mrs. Mary, Brighton	1,500	0	0
McMaster, Mr. E. C.	12	10	0
Meyer, Cecil, Esq., Upper Norwood	2	2	0
Murphy, James, Esq., Newry.	1,000	0	0
Packer, Mr. Charles, Regent Street	100	0	0
Paterson, James N., Esq., Edinburgh	1,000	0	0
Pollard, John, Esq., Holker Cartmel	50	0	0
Pratt, Mrs. Hester, Leamington	100	0	0
Rudge, W. N., Esq., Stock Exchange	1,000	0	0
Slocombe, William, Esq., Holloway	900	0	0
“T. J. M.”	400	0	0
Tobin, Sir Thomas	186	0	0
Torkington, Osgood, Esq., Clapham.	1,000	0	0
Tower, Miss Jane, Edinburgh	25	0	0
Walker, George, Esq., Southport.	3,100	0	0
Watson, Horace, Esq., Wimbledon	200	0	0
Young, Major R.W., Dunmore	250	0	0

During the past year the sum of 9,907*l.* 14*s.* 7*d.* was expended on additional Life-boats, Transporting-carriages, Boat-houses, and necessary gear; 13,039*l.* 19*s.* 7*d.* in repairs, painting, refitting, and sundry charges on Life-boat Establishments, and on the Store-yard at Poplar; and 14,833*l.* 12*s.* 1*d.* in rewards for services to shipwrecked crews, coxswains' salaries, quarterly practice of the Life-boats' crews, and other expenses; making altogether a total of 37,781*l.* 6*s.* 3*d.* against receipts amounting to 36,419*l.* 16*s.*

The items of receipt and expenditure are fully detailed in the financial statement, which has been audited as usual by Mr. LOVELOCK, public accountant.

The managing body of so great and philanthropic a Society as the LIFE-BOAT INSTITUTION fulfils a national public duty, and its Committee are amply rewarded in its administration by the sympathy and liberal support which the community extend to it.

Thus fortified they are determined to leave no effort untried which shall contribute to the efficiency of their life-saving machinery, and fit it to perform the great work the originators of the Institution had in view—“the Preservation of Life from Shipwreck.”

List of the Services of the Life-boats of the Royal National Life boat Institution during the year 1881.

	Lives Saved		Lives Saved		Lives Saved
<i>Agnes</i> , schooner, of Llanely	5	<i>Frances Marie</i> , sch. of Nantes	5	<i>Minnie Coles</i> , sch., of Southamp-	5
<i>Albion</i> , schooner, of Southampton	4	Fraserburgh fishing boats—ren-		ton—assisted to save vessel and	5
<i>Aldebaran</i> , schooner, of Laurvig	5	dered assistance.		<i>Mischief</i> , schooner, of Rye	4
—assisted to save vessel and	5	<i>Ganges</i> , ship, of London	32	<i>Miss Beck</i> , schooner, of Carnarvon	5
<i>Alecto</i> , barque, of Malta—re-		<i>George and Mary</i> , schooner, of		<i>Neath Trader</i> , smack, of Newport	3
mained by vessel.		Barrow	5	<i>Neilly</i> , barquentine, of Bridgwater	
<i>Angostura</i> , barque, of Hamburg		<i>George H. Oulton</i> , ship, of St.		—saved vessel and	6
—saved vessel and	17	John's, N.B.	27	<i>New Eagle</i> , sloop, of Grimsby	2
<i>Annie Marie</i> , schooner, of Krageroe	3	<i>Georgina</i> , brig., of Portmadoc	5	<i>Niels</i> , Swedish schooner	5
<i>Attila</i> , ship, of Newcastle—ren-		<i>Germania</i> , s.s., of Middlesborough		<i>Norma</i> , s.s., of Bergen	11
dered assistance.		—assisted to save vessel & crew	17	<i>Norman</i> , s.s., of London	11
<i>August</i> , barque, of Sundswall,		<i>Gertrude</i> , barque, of Liverpool	13	<i>North Wales</i> , barque, of London	21
Sweden, assisted to save vessel	16	<i>Gervase</i> , s.s., of London—assisted		<i>Northumberland</i> , s.s., of New-	
<i>August</i> , brig, of Barth	7	to save vessel and	19	castle	4
<i>Aurora</i> , sloop, of Boston	3	<i>Gleaner</i> , schooner, of Garston	3	<i>Ocean</i> , schooner, of Goole, assisted	
<i>Ballywalter</i> , fishing boat	2	<i>Glenwilliam</i> , s.s., of Barrow—re-		to save vessel and	4
<i>Baron van Pallandt</i> , barque	11	mained by vessel.		<i>Ocean Monarch</i> , brig, of Guernsey	9
<i>Bell</i> , boat, Ballywalter, saved boat.		<i>Golden Island</i> , sch., of Belfast	4	<i>Olive Branch</i> , barge, of Harwich,	
<i>Bertha</i> , brigantine, of Rye	6	<i>Grasshopper</i> , schooner, of South-		assisted to save vessel and	3
Berwick-on-Tweed fishing boats,		ampton	6	<i>Oscar</i> , schooner, of Leith	7
saved two boats and	9	<i>Gustava</i> , barque, of Laurvig	11	<i>Pampora</i> , barque, of Swansea—	
<i>Beattie Whinery</i> , brigantine, of		<i>Gyda</i> , brig, of Swendsall	4	assisted to save vessel and	14
Maryport—saved vessel and	6	<i>Harmonie</i> , schooner, of Mandel	5	<i>Peace</i> , dandy, of Lowestoft—	
<i>Black Cat</i> , fishing smack—saved		<i>Hasselø</i> , brigantine, of Hagesund	8	saved vessel and	5
vessel and	2	Holy Island fishing cobs—ren-		<i>Queen of the Lark</i> , brigantine, of	
<i>Blue Jacket</i> , schooner, of Beau-		dered assistance.		Whitelaven	5
maris, saved vessel and	3	<i>Houth</i> , pleasure boat—saved boat		<i>Fauce</i> , s.s., of Bristol	5
<i>Branzly</i> , brig., of Whitehaven	4	and	12	<i>Red Wharf</i> , fishing boat, of	3
<i>Brazilian</i> , s.s., of Barrow—ren-		<i>Indian Chief</i> , ship, of Liverpool	4	<i>Remède d'our</i> , schooner, of Nantes	6
dered assistance.		<i>Ingerid</i> , Dutch s.s.	7	<i>Retriever</i> , s.s., of Montrose—ren-	
<i>Brixham</i> pilot gig—remained		<i>Innis Kail</i> , brig, of Dublin—as-		dered assistance.	
alongside.		sisted to save vessel and	8	<i>Rosa Josephs</i> , sch., of St. Vaast	5
<i>Broomhill</i> , s.s., of Dundee	19	<i>Iris</i> , barque, of Getle	12	<i>Rozita</i> , Spanish schooner	5
<i>Brothers</i> , ketch, Teuby	4	<i>Iron Crown</i> , barque, of Liverpool	18	<i>Ruby</i> , sloop, of Goole—assisted	
<i>Butcher</i> , barge, of Rochester	2	<i>James Innes</i> , smack, of St. Mon-		to save vessel and	2
<i>Caduceus</i> , barque, of North Shields	10	ance, Fife	6	Runswick and Staithe fishing	
<i>Cambria</i> , schooner, of Thurso	2	<i>J. M. Harris</i> , brigantine, of Dublin	3	cobs—rendered assistance.	
<i>Castlemaine</i> , ship, of Liverpool	25	<i>John Green</i> , schooner, of Drogheda	5	<i>St. Anne</i> , lugger, of Nantes	7
<i>Catherine</i> , smack, of Ramsgate	5	<i>John Wesley</i> , brigantine, of Seaham	5	<i>Sans Fearg</i> , barque, of Rostock—	
<i>Cavalier</i> , schooner, of Lossiemouth	5	<i>Julie Kasche</i> , brigantine—assisted		to save crew	12
<i>Chin Chin</i> , barque, of Jersey	5	to save vessel.		<i>Scud</i> , smack, of Yarmouth	9
<i>Claremont steamer</i> , of Newcastle	6	<i>Jupiter</i> , barque, of Liverpool	18	<i>Shamrock</i> , dandy, of Hull	5
<i>Constance</i> , schooner, of Swansea	10	<i>Kyanite</i> , schooner, of Guernsey—		<i>Shannon</i> , schooner, of Liverpool—	
Cruden fishing boats—rendered		assisted to save vessel and	7	rendered assistance.	
assistance.		<i>Laura</i> , barque, of Grimstadt	14	<i>Skold</i> , brigantine, of Christiansund	
Cullercoats fishing coble—ren-		<i>Laura Nell</i> , s.s., of London, as-		—rendered assistance.	
dered assistance.		sisted to save vessel and	7	<i>Sophia Holten</i> , dandy, of Plymouth	2
<i>Danube</i> , brigantine, of Guernsey		<i>Lebu</i> , barque, of Liverpool	9	<i>Star of Peace</i> , of Montrose—as-	
—remained by vessel.		<i>Lima</i> , brigantine, of Aland	8	sisted to save vessel and	6
<i>Darragh Beg</i> , s.s., of Douglas, I.M.	3	<i>Lion</i> , ketch, of Exeter	1	<i>Stratheden</i> , barque, of Dundee	12
<i>Dayspring</i> , brig., of Liverpool	1	<i>Lively</i> , fishing coble, of Redcar	2	<i>Tal-y-fan</i> , screwboat, of Liverpool	4
<i>Dorothy & Mary</i> , schooner, of		<i>Lizzie</i> , ketch, of Bridgwater	4	Teignmouth fishing boats—saved	
Newcastle, saved vessel and	4	<i>Lizzie</i> , schooner, of Fowey—ren-		two boats and	2
<i>Eliza Emma</i> , brig, of Shoreham	6	dered assistance.		<i>Thomas</i> , ketch, of Lynn	3
<i>Ellen</i> , smack, Orme's Head—saved		<i>Lom</i> , barque, of Hudiksvall	10	<i>Time</i> , ketch, of Goole	4
vessel.		<i>Louise</i> , sch., of Frederickstadt	5	<i>Trafalgar</i> , s.s., of London	23
<i>Ellen Vair</i> , schooner, assisted to		<i>Ludworth</i> , s.s., of London	8	<i>Triton</i> , dandy, of Yarmouth—as-	
save vessel.		<i>Macbruff</i> , ship, of Glasgow—ren-		sisted to save vessel and	6
<i>Equestrian</i> , schooner, of Banff	4	dered assistance.		<i>Two Brothers</i> , ketch, of Bridg-	
<i>Equity</i> , schooner, of Boston—as-		<i>Madeleine</i> , lugger, of Boulogne	16	water	3
sisted to save vessel and	7	<i>Magdalen</i> , boat, of Montrose	6	<i>Ulea</i> , s.s., of Llanely	10
<i>Eulala</i> , schooner, of Dumfries	4	<i>Manne de Ciel</i> , French ketch	4	<i>Visitor</i> , Brig, of Whitby	6
<i>Ewart</i> , schooner, of Aland, Fin-		<i>Margaret</i> , barque, of Belfast	15	<i>William</i> , schooner, of Dublin	2
land—rendered assistance.		<i>Maria</i> , barge, of Rochester	2	<i>William</i> , schooner, of Liverpool	6
<i>Excelsior</i> , barque, of Laurvig	13	<i>Maria</i> , brig, of Hartlepool	5	<i>Yorkshire Lass</i> , ketch, of Boston	3
<i>Excelsior</i> , German barque—re-		<i>Marmora</i> , barque, of Copenhagen	6	<i>Young Henry</i> , smack, of Yar-	
mained by vessel.		<i>Mary</i> , barquentine, of Gothenburg	1	mouth, remained by vessel.	
<i>Favorite</i> , schooner, of Quilmer	4	<i>Mary Cook</i> , of Campbeltown	2	<i>Zipporah</i> , schooner, of Scarborough	2
<i>Febv</i> , barque, of Genoa—assisted		<i>Mary Stuart</i> , barque—rendered			
to save vessel and	14	assistance.			
<i>Fidèle</i> , brig, of Marstrand, assisted		<i>Matilda</i> , brig, of Gothenberg—			
to save vessel and	6	rendered assistance.			
<i>Fishguard Lass</i> , of Abersoch	3	<i>Matilda Hilyard</i> , barque, of			
<i>Flora</i> , brigantine, of Swansea	5	Greenock—rendered assistance.			
<i>Florence</i> , schooner, of Belfast	5	<i>Menadora</i> , brigantine, of Hartle-			
		pool	6		
		<i>Milka</i> , barque, of Fiume, re-			
		mained by vessel.			

Total lives saved by Life-boats in 1881, in addition to Thirty-three vessels..... 966

During the same period the Institution granted rewards for saving lives by fishing and other boats 155

Total of lives saved } 1121
in 1881..... }

RESOLUTIONS PASSED AT THE ANNUAL MEETING FOR 1882.

THE RIGHT HON. THE LORD MAYOR OF LONDON IN THE CHAIR.

1.—Moved by the CHAIRMAN :—

1.—That the following Noblemen and Gentlemen be the Officers of the Institution for the current year :—
(*Vide* next page for this list.)

2.—Moved by EDWARD BIRKBECK, Esq., M.P., *Deputy Chairman*.

Seconded by Colonel BARNE, M.P.

2.—That the Report now read be adopted, printed, and circulated.

3.—Moved by GEORGE PALMER, Jun., Esq., Master of the Mercers' Company.

Seconded by ION T. HAMILTON, Esq., M.P.

3.—That this Meeting acknowledges with gratitude the unprecedented success which accompanied the Services of the Life-boats during the past year, when they rescued from various Shipwrecks *nine hundred and sixty-six* lives—in addition to *one hundred and fifty-five* lives saved by shore-boats rewarded by the Institution, making a total of *one thousand one hundred and twenty-one* lives saved. The Meeting is deeply sensible of the responsibility that rests on the Committee in the management of so great and national an Institution; and it therefore appeals with renewed assurance for increased sympathy and support.

4.—Moved by The Right Hon. The LORD MAYOR OF LONDON.

Seconded by Capt. The Hon. FRANCIS MAUDE, R.N.

4.—That this Meeting tenders its best thanks to THOMAS CHAPMAN, Esq., F.R.S., *V.P.*, Chairman; to the Committee of Management, and to the Officers, for their continued valuable services in the management of the important affairs of the NATIONAL LIFE-BOAT INSTITUTION.

Also to the Honorary Local Committees and Secretaries of the several Branches, for their earnest and active co-operation with the Parent Institution.

5.—Moved by Vice-Adml. AUGUSTUS PHILLIMORE, late Admiral Superintendent of Naval Reserves.

Seconded by Colonel FITZROY CLAYTON.

Supported by Major - General BURNABY, M.P.

5.—That this Meeting testifies afresh to the brave and persevering spirit that continues to distinguish the Coxswains and Crews of the Life-boats, which was never more conspicuously shown than during the fearful storms of the past year.

6.—Moved by THOMAS CHAPMAN, Esq., F.R.S., *V.P.*

Seconded by Sir EDWARD G. L. PERROTT, Bart., *V.P.*

6.—That the best thanks of this Meeting be given to the Right Hon. The LORD MAYOR, for so ably presiding over this fifty-eighth Annual Meeting of the ROYAL NATIONAL LIFE-BOAT INSTITUTION, and for the continued kind interest he takes in its welfare.

ROYAL NATIONAL LIFE-BOAT INSTITUTION.

For the Preservation of Life from Shipwreck.

(Incorporated by Royal Charter.)

FOUNDED IN 1824.—SUPPORTED SOLELY BY VOLUNTARY CONTRIBUTIONS.

PATRONESS.

Her Most Gracious Majesty the Queen.

VICE-PATRON.

HIS ROYAL HIGHNESS THE PRINCE OF WALES, K.G.

PRESIDENT.

HIS GRACE THE DUKE OF NORTHUMBERLAND, P.C., D.C.L.

VICE-PRESIDENTS.

His Grace the ARCHBISHOP of CANTERBURY, F.R.S.
His Grace the DUKE of ARGYLL, K.T., F.R.S.
The Most Noble the MARQUIS of CHOLMONDELEY.
The Right Hon. the EARL of LEICESTER, K.G.
Admiral Sir GEORGE BROKE-MIDDLETON, Bart., C.B.
Sir EDWARD G. L. PERROTT, Bart.
THOMAS CHAPMAN, Esq., F.R.S.

EDWARD BIRKBECK, Esq., M.P.
JAMES CHADWICK, Esq.
W. H. HARTON, Esq.
T. B. POTTER, Esq., M.P.
HUGH TAYLOR, Esq.
ROBERT WHITWORTH, Esq.

COMMITTEE OF MANAGEMENT.

THOMAS CHAPMAN, Esq., F.R.S., V.P., *Chairman*.
EDWARD BIRKBECK, Esq., M.P., V.P., *Deputy Chairman*.

Rear-Admiral H.R.H. the DUKE of EDINBURGH, K.G.,
Admiral Superintendent of Naval Reserves.
The MARQUIS of CHOLMONDELEY, V.P.
L. T. CAVE, Esq.
Sir WILLIAM R. CLAYTON, Bart.
Colonel FITZ-ROY CLAYTON.
Admiral Sir RICHARD COLLINSON, K.C.B., Deputy Master of
the Trinity House.
Colonel the Hon. C. F. CRICHTON.
Captain Sir F. J. O. EVANS, R.N., F.R.S., Hydrographer
to the Admiralty.
The Right Hon. G. J. GÖSCHEN, M.P.
JOHN GRIFFITH, Esq.
WILLIAM H. HARTON, Esq., V.P.
The Right Hon. JOHN GELLIBRAND HUBBARD, M.P.
WILLIAM HEARLE LYALL, Esq.

Admiral J. B. B. MCHARDY.
EUGENE F. NOEL, Esq.
Sir FRANCIS BOYD OUTRAM, Bart.
Lord ALFRED H. PAGET.
Colonel GEORGE PALMER.
GEORGE PALMER, Jun., Esq.
The Right Hon. EARL PERCY, P.C., M.P.
Sir EDWARD G. L. PERROTT, Bart., V.P.
Vice-Admiral AUGUSTUS PHILLIMORE.
The Right Hon. LORD ROBARTES.
Admiral A. P. RYDER, Commander-in-Chief at Portsmouth.
Admiral of the Fleet, Sir GEORGE SARTORIUS, G.C.B.
Major-General TULLOH, R.A., C.B.
The Right Hon. the EARL WALDEGRAVE.
Vice-Admiral J. R. WARD.
T. M. WEGUELIN, Esq.

TRUSTEES.

THOMAS CHAPMAN, Esq., F.R.S., V.P. EDWARD BIRKBECK, Esq., M.P., V.P. The Right Hon. EARL PERCY, P.C., M.P.

BANKERS—Messrs. COUTTS and Co., 59 Strand.

TREASURER—HUGH LINDSAY ANTROBUS, Esq.

SECRETARY—RICHARD LEWIS, of the Inner Temple, Esq., Barrister-at-Law.

CHIEF LIFE-BOAT INSPECTOR—Vice-Admiral J. R. WARD.

DISTRICT LIFE-BOAT INSPECTORS.

Captain the Hon. H. W. CHETWYND, R.N.—London.
Commander St. VINCENT NEFRAN, R.N.—Hull.

Commander C. LAPRIMAUDAYE, R.N.—Bristol.
Commander GEORGES C. C. CARTER, R.N.—Edinburgh.
Lieutenant H. T. G. TIPPING, R.N.—Dublin.

ARCHITECT—C. H. COOKE, Esq., F.S.A.

SOLICITORS—Messrs. CLAYTON, SONS, and FARGUS.

AUDITOR—SAMUEL LOVELOCK, Esq., Public Accountant, F.C.A.

The object of this Institution, as declared in its title, and in its Charter of Incorporation, is to afford assistance to every shipwrecked person around the Coasts of the United Kingdom.

The chief means by which the Society hopes to carry this object into effect are:—

To build, station, and maintain in repair, Life-boats of the most perfect description; to furnish them with all necessary Appurtenances, including Houses to preserve them in, and Carriages for their conveyance to the spots where their Services are called for; and further, to provide, through the instrumentality of Local Committees, for their proper Management and the occasional Exercise of their Crews.

To confer Honorary Rewards in the form of Medals and Votes of Thanks, and also to make liberal grants of money to all persons who, at the risk of their own lives, save, or attempt to save, those of others on board vessels wrecked, or in distress, upon any part of the Coasts of the United Kingdom.

The number of lives saved either by the Life-boats of the Institution, or by special exertions for which it has granted rewards, since its formation, is

Donations and Annual Subscriptions are thankfully received by the Bankers of the Institution, Messrs. COUTTS and Co., 59 Strand; Messrs. HERRIES, FARQUHAR, and Co., 16 St. James's Street; Messrs. HOARE, 37 Fleet Street, London; by all the other Bankers in the United Kingdom; by all the Life-boat Branches; and by the Secretary at the Institution, 14 JOHN STREET, ADELPHI, LONDON, W.C.—May 1st, 1882.

Dr.

INCOME AND EXPENDITURE.—1st Jan. to 31st Dec. 1881.

Cr.

To LIFE-BOATS, viz.:	£.	s.	d.	£.	s.	d.
Bamburgh Castle	282	0	0			
Caister (Repairs)	151	0	5			
Cemaes	286	15	0			
Gorleston (Repairs)	112	8	1			
Harwich	600	0	0			
Kessingland No. 1 (Repairs)	139	6	2			
Newhaven	430	0	0			
Palling No. 1	430	0	0			
„ No. 2 (Repairs)	123	16	7			
Penarth	392	0	0			
Poolbeg	363	0	0			
Ramsgate (Repairs)	104	11	0			
Robin Hood's Bay	286	15	0			
Southwold (Repairs)	118	13	7			
Wells	430	0	0			
Wexford No. 1 (Repairs)	183	0	0			
Winterton (Repairs)	120	8	8			
Whitby No. 1	363	0	0			
Yarmouth (Repairs)	95	1	10			
Spare Life-boat	363	0	0			
Alterations and repairs of Life-boats and Sundry Expenses on the 271 Life-boat Stations	6,344	8	7			
Salaries, &c., to six Inspectors of Life-boats	2,752	18	9			
Travelling Expenses, &c., of ditto	1,314	4	0			
				15,786	7	8
To LIFE-BOAT HOUSES AND SLIPWAYS, viz.:						
Cardigan (Balance)	90	0	0			
Guernsey	157	9	0			
Hastings	602	0	0			
Redcar	204	0	0			
Robin Hood's Bay	289	9	0			
St. Anne's (Balance)	92	0	0			
Withernsea	412	17	3			
Alterations and repairs of Life-boat Houses, &c.	763	5	9			
				2,611	1	0
To LIFE-BOAT CARRIAGES, viz.:						
Bamburgh Castle	130	0	0			
Palling No. 1	132	0	0			
Penarth (alterations)	75	10	0			
Poolbeg	131	0	0			
Robin Hood's Bay	129	0	0			
Whitby No. 1	129	0	0			
Spare Life-boat Carriage	117	10	0			
Alterations and Repairs of Life-boat Carriages, &c.	452	11	8			
				1,296	11	8
Carried forward	£19,694	0	4			

	£.	s.	d.	£.	s.	d.
By Donations. 11,681 0 4	11,681	0	4			
By Subscriptions.	3,286	15	6			
				14,967	15	10
By Special Gifts, amounting to £6,022 5s. 2d., for the following Life-boats:—						
Braunton—Miss Leicester	1,000	0	0			
Clovelly—The late Mrs. Hughes	1,000	0	0			
Newcastle (Dundrum)—E. Armitage, Esq., R.A.	600	0	0			
Palling, No. 1—“Heyland” Memorial Fund	418	8	8			
Poolbeg—Mrs. Symes	600	0	0			
Robin Hood's Bay—Mr. and Mrs. Fox's Children	1,000	0	0			
St. Anne's—James Chadwick, Esq. (in addition to £1,000 in 1880)	230	0	0			
Whitby No. 1—Mrs. Ellis	800	0	0			
Langham Hotel Life-boat Fund (on account).	223	16	6			
“Admiral Lutwidge” Life-boat Fund (on account)	150	0	0			
By Contributions from Branches	5,309	9	10			
By Dividends and Interest	10,120	5	2			
Carried forward	£36,419	16	0			

No.	STATION.	Length.		Breadth.		No. of Oars.	When Stationed or Named.		
		Ft.	in.	Ft.	in.				
ENGLAND.									
1	NORTHUMBERLAND	BERWICK-ON-TWEED	- - -	33	0	8	0	10	1864
2		HOLY ISLAND—No. 1	- - -	32	0	7	4	10	1865
3		" " No. 2	- - -	32	0	7	4	10	1868
4		BAMBURGH CASTLE	- - -	32	0	7	6	10	1882
5		NORTH SUNDERLAND	- - -	33	0	8	0	10	1865
6		BOULMER	- - -	33	0	8	0	10	1866
7		ALNMOUTH	- - -	32	0	7	5	10	1865
8		HAUXLEY	- - -	34	0	8	4	10	1866
9		CRESSWELL	- - -	30	0	8	0	8	1875
10		NEWBIGGIN	- - -	34	0	8	4	10	1866
11		BLYTH—No. 1	- - -	33	0	8	0	10	1867
12		" No. 2	- - -	30	0	8	0	8	1880
13		CULLERCOATS	- - -	33	0	8	0	10	1866
14		TYNEMOUTH—No. 1	- - -	37	0	9	0	12	1875
15		" No. 2	- - -	33	0	8	1	10	1872
16	DURHAM	WHITBURN	- - -	34	0	8	0	10	1881
17		SUNDERLAND—No. 1	- - -	30	0	8	0	8	1876
18		" No. 2	- - -	30	3	8	7	10	1882
19		" No. 3	- - -	33	0	8	2	10	1865
20		" No. 4	- - -	36	0	9	0	12	1872
21		SEAHAM	- - -	33	0	8	6	10	1870
22		HARTLEPOOL—No. 1	- - -	33	0	8	6	10	1876
23		" No. 2	- - -	35	0	9	0	10	1876
24		" No. 3	- - -	33	0	8	6	10	1878
25		WEST HARTLEPOOL—No. 1	- - -	33	0	8	6	10	1869
26		" No. 2	- - -	34	0	8	9	10	1874
27		SEATON CAREW	- - -	33	0	8	6	10	1873
28	YORKSHIRE	MIDDLESBOROUGH	- - -	33	0	8	0	10	1864
29		REDCAR	- - -	36	0	9	6	10	1867
30		SALTBURN	- - -	34	0	8	3	10	1880
31		STAITHES	- - -	32	0	8	0	10	1875
32		RUNSWICK	- - -	34	0	8	0	10	1880
33		UPGANG	- - -	32	0	7	6	10	1879
34		WHITBY—No. 1	- - -	34	0	8	0	10	1881
35		" No. 2	- - -	32	0	7	7	10	1879
36		ROBIN HOOD'S BAY	- - -	32	0	8	0	10	1881
37		SCARBOROUGH	- - -	35	0	9	0	10	1872
38		FILEY	- - -	33	0	8	0	10	1863
39		FLAMBOROUGH—No. 1	- - -	33	0	8	6	10	1871
40		" No. 2	- - -	33	0	8	0	10	1882
41		BRIDLINGTON	- - -	34	0	7	7	10	1871
42		HORNSEA	- - -	32	0	7	6	10	1875
43		WITHERNSEA	- - -	30	0	8	0	8	1878
44	LINCOLNSHIRE	GRIMSBY	- - -	33	0	8	6	10	1868
45		DONNA NOOK	- - -	34	0	8	0	10	1878
46		THEDDLETHORPE	- - -	30	0	8	11	12	1871
47		SUTTON	- - -	30	0	8	0	8	1876
48		CHAPEL	- - -	30	0	8	0	8	1876
49		SEEGNESS	- - -	33	0	8	0	10	1874
50	NORFOLK	HUNSTANTON	- - -	32	0	7	6	10	1867
51		BRANCASTER	- - -	33	0	8	0	10	1879
52		WELLS	- - -	37	0	9	0	12	1881
53		BLAKENEY	- - -	37	0	9	5	12	1873
54		SHERINGHAM	- - -	36	0	9	0	12	1867
55		CROMER	- - -	34	0	8	8	10	1868
56		MUNDESLEY	- - -	34	0	8	3	10	1882
57		HASBOROUGH	- - -	32	0	7	6	10	1866
58		PALLING—No. 1	- - -	37	0	9	0	12	1882
59		" No. 2	- - -	40	0	11	6	14	1870
60		WINTERTON—No. 1	- - -	32	0	10	0	12	1878
61		" No. 2	- - -	36	0	10	6	14	1879
62		CAISTER—No. 1	- - -	42	0	11	6	14	1878
63		" No. 2	- - -	33	7	10	0	12	1875

No.	NAME OF BOAT AND DONOR.	NAME AND ADDRESS OF HONORARY SECRETARY.
1	<i>Albert Victor</i> —Manchester Branch . . .	B. G. Sinclair, Esq., Berwick-on-Tweed.
2	<i>Grace Darling</i> —The late Lady Watson . .	} Rev. W. W. F. Keeling, Holy Island, Beal, R.S.O.
3	<i>Bombay</i> —The late Mr. J. G., and Mrs. Frith	
4	<i>John and Betty Cuttall</i> —The late Mr. Cuttall	R. A. Storrar, Esq., Bamburg Castle, Belford.
5	<i>Joseph Anstice</i> —The late Mrs. Anstice . .	Capt. A. Marshall, N. Sunderland, Chathill.
6	<i>Robin Hood of Nottingham</i> —Nottingham .	Rev. L. J. Stephens, M.A., Long Houghton Vicarage, Lesbury, R.S.O.
7	<i>John Atkinson</i> —Miss Wardell	H. Smith, Esq., Alnmouth, R.S.O., Northumberland.
8	<i>Algernon & Eleanor</i> —Her Grace the Dowager Duchess of Northumberland.	Rev. A. O. Medd, Amble, Aeklington.
9	<i>Old Potter</i> —Thos. Hackwood, Esq.	Mr. Thomas Bolton, Cresswell, Morpeth.
10	<i>W. Hopkinson, of Brighthouse</i> —The late Miss Hopkinson.	Rev. Edward Shortt, M.A., Woodhorn Vicarage, Morpeth.
11	<i>Salford</i> —Manchester Branch	} Mr. James Darling, Blyth, Northumberland.
12	<i>Tom and Marion</i> —Mr. & Mrs. T. Jones Gibb	
13	<i>Palmerston</i> —Peter Reid, Esq.	Major Adamson, Cullercoats, Newcastle-on-Tyne.
14	<i>Charles Dibdin</i> —Civil Service No. 2 Fund .	P. J. Messent, Esq., C.E., Tynemouth, North Shields.
15	<i>Forester</i> —A. O. of Foresters	} W. H. Williamson, Esq., Whitburn, nr. Sunderland.
16	<i>William and Charles</i> —A Lady	
17	<i>Good Templar</i> —That Life-boat Fund . . .	} J. C. Porrett, Esq., 52 West Sunnyside, Sunderland.
18	<i>Mary</i> —Miss Beckett's Legacy	
19	<i>Florence Nightingale</i> —Town of Derby . .	} [R.S.O.]
20	<i>John Foulston</i> —The late Mrs. Foulston . .	
21	<i>Sisters Carter, of Harrogate</i> —Misses Carter	William Warham, Esq., Londonderry Offices, Seaham.
22	<i>Charles Mather</i> —Mrs. Annie Mather	} S. Herbert Belk, Esq., Hartlepool.
23	<i>Charles Ingleby</i> —Trust Fund, per G. P. Wragge, Esq.	
24	<i>John Clay Barlow</i> —Miss Barlow	} C. A. Baker, Esq., North Eastern Railway, West Hartlepool.
25	<i>Rochdale</i> —Collected in Rochdale.	
26	<i>Foresters' Pride</i> —A. O. of Foresters. . . .	} Rev. John Lawson, M.A., Seaton Carew, West Hartlepool.
27	<i>Job Hindley</i> —The late Mr. Hindley, per Manchester Branch.	
28	<i>Crossley</i> —Messrs. J. Crossley and Sons . . .	A. O. Cochrane, Esq., Newton House, Coatham, Redcar.
29	<i>Burton-on-Trent</i> —Town of Burton-on-Trent	J. M. Meek, Esq., 7 Albert Road, Middlesborough.
30	<i>Charles and Ann</i> —Mrs. Townend, per Manchester Branch.	Mr. T. G. Pearson, Saltburn-by-the-Sea.
31	<i>Hannah Somerset</i> —Mrs. Yates' Legacy . .	} Dr. J. V. Laverick, Hinderwell, Staithes.
32	<i>Margaret and Edward</i> —A Lady	
33	<i>Joseph Sykes</i> —Mrs. A. E. Sykes' Legacy . .	E. W. Chapman, Esq., Whitby.
34	<i>Robert and Mary Ellis</i> —Mrs. Ellis	Mr. Robert Gibson, Harbour Master, Whitby.
35	<i>Harriott Forteath</i> —Late Mrs. Forteath . .	} Rev. R. Jermyn Cooper, Fylingdales Vicarage, Whitby.
36	<i>Ephraim and Hannah Fox</i> —Mr. and Mrs. Fox's Children	
37	<i>Lady Leigh</i> —Warwickshire Freemasons . .	John Stephenson, Esq., Scarborough.
38	<i>Hollon</i> —Mr. and Mrs. Hollon	A. E. Hick, Esq., St. Thomas Street, Scarborough.
39	<i>Gertrude</i> —Legacy of John Beckett, Esq. . .	W. Hanks, Esq., Filey, R.S.O., Yorkshire.
40	<i>Matthew Middlewood</i> —G. Middlewood, Esq.	Rev. J. F. Wilkinson, M.A., Flamborough, Hull.
41	<i>John Abbott</i> —Mr. Abbott's Legacy	Alfred West, Esq., Garrison St., Bridlington Quay.
42	<i>Ellen and Margaret of Settle</i> —Settle Fund .	Mr. George Milner, Southgate, Hornsea, near Hull.
43	<i>Admiral Rous</i> —That Life-boat Fund	Horatio H. Ayre, Esq., Withernsea, near Hull.
44	<i>Manchester Unity</i> —I. O. of Odd Fels. (M.U.)	F. Dawson, Esq., Victoria Chambers, Grimsby.
45	<i>Richard</i> —Miss Dixon	Mr. Gilbert Houlden, North Somercotes, Grimsby.
46	<i>Dorinda and Barbara</i> —Mrs. B. Caslake . .	Rev. L. D. Kennedy, M.A., Theddlethorpe, Louth.
47	<i>Caroline</i> —N. R.	Lieut. E. J. V. Pritchard, R.N., Coastg., Mablethorpe, R. Bradshaw, Esq., Hogsthorpe, Alford. [Alford.]
48	<i>Land-seer</i> —Miss Landseer.	C. F. Grantham, Esq., Skegness, R.S.O., Lincolnshire.
49	<i>Herbert Ingram</i> —Mr. Ingram's Friends . .	Mr. W. H. Colbeck, Ch. Officer, C. G ^d , Skegness, R.S.O., Lincolnshire.
50	<i>Licensed Victualler</i> —Licensed Victuallers . .	Rev. A. Waller, M.A., Hunstanton, Norfolk. [Lynn.]
51	<i>Lily Bird</i> —Samuel Bird, Esq.	Rev. E. K. Kerslake, M.A., Deepdale Rectory, King's Lynn.
52	<i>Charlotte Nicholls</i> —Miss Nicholls' Legacy .	E. Dewing, Esq., Burnham Overy, King's Lynn.
53	<i>Hettie</i> —A Friend at Bradford.	Rev. J. R. Pilling, Wells, Norfolk.
54	<i>Duncan</i> —Mrs. Fraser	Rev. R. H. Tillard, M.A., Blakeney, Dereham.
55	<i>Benjamin Bond Cabbell</i>	Rev. Lethbridge Moore, Sheringham, Cromer.
56	<i>J. H. Elliott</i> —Mrs. Elliott	W. G. Sandford, Esq., Cromer.
57	<i>Huddersfield</i> —Huddersfield	Mr. G. Gordon, Mundesley, North Walsham, Norfolk.
58	<i>Heyland</i> —That Memorial Fund	Rev. J. Slater, M.A., Hasborough, Norwich.
59	<i>British Workman</i> —That Magazine	Mr. E. French, Chief Officer C. G ^d , Palling, Norwich.
60	<i>Edward Birkbeck</i> —R. N. L. B. Institution .	} Rev. Wm. Green, M.A., Winterton, Great Yarmouth.
61	<i>Husband</i> —Late Mrs. Davis	
62	<i>Covent Garden</i> —That Life-boat Fund . . .	} Rev. E. G. H. Murrell, Caister, Great Yarmouth.
63	<i>Godsend</i> —Lady Bouchier	

[Continued.]

No.	STATION.	Length.		Breadth.		No. of Oars.	When Stationed or Named.
		Ft.	in.	Ft.	in.		
64	NORFOLK - - - YARMOUTH—No. 1 - - -	42	3	11	9	12	1861
65	" No. 2 - - -	28	0	9	0	10	1875
66	SUFFOLK - - - GORLESTON - - -	30	0	10	0	10	1870
67	LOWESTOFT - - -	44	0	12	3	14	1876
68	PAKEFIELD—No. 1 - - -	46	3	12	0	14	1872
69	" No. 2 - - -	30	0	9	0	12	1871
70	KESSINGLAND—No. 1 - - -	42	0	12	0	14	1870
71	" No. 2 - - -	32	0	10	0	12	1879
72	SOUTHWOLD—No. 1 - - -	40	0	11	6	12	1855
73	" No. 2 - - -	33	0	8	0	10	1866
74	DUNWICH - - -	30	0	7	8	8	1873
75	THORPENESS - - -	37	0	9	4	12	1873
76	ALDBOROUGH - - -	40	0	10	5	12	1870
77	ESSEX - - - HARWICH - - -	45	0	11	0	10	1876-81
78	CLACTON-ON-SEA - - -	34	0	8	3	10	1878
79	SOUTHEND - - -	25	0	7	3	8	1879
80	KENT - - - MARGATE - - -	34	0	8	3	10	1866
81	KINGSGATE - - -	28	0	7	3	8	1880
82	BROADSTAIRS - - -	36	0	9	2	12	1868
83	RAMSGATE - - -	44	0	11	1	12	1877
84	NORTH DEAL - - -	40	0	10	0	12	1881
85	WALMER - - -	36	0	9	4	12	1871
86	KINGSDOWNE - - -	36	0	9	0	12	1882
87	DOVER - - -	35	0	9	0	10	1878
88	HYTHE - - -	35	0	9	0	10	1876
89	NEW ROMNEY - - -	32	0	7	6	10	1871
90	LYDD, DUNGENESS - - -	33	0	7	9	10	1874
91	SUSSEX - - - RYE - - -	34	0	7	9	10	1881
92	WINCHELSEA - - -	33	0	8	2	10	1882
93	HASTINGS - - -	34	0	8	3	10	1880
94	EASTBOURNE - - -	34	0	8	3	10	1880
95	NEWHAVEN - - -	37	0	9	0	12	1881
96	BRIGHTON - - -	32	0	7	8	10	1867-74
97	SHOREHAM - - -	33	0	8	1	10	1865
98	WORTHING - - -	32	0	7	6	10	1880
99	SELSEY - - -	32	0	7	6	10	1865
100	CHICHESTER HARBOUR - - -	32	0	7	5	10	1873
101	HAMPSHIRE - - HAYLING ISLAND - - -	32	0	7	5	10	1865
102	ISLE OF WIGHT - BEMBRIDGE - - -	32	0	7	7	10	1867
103	BRIGHSTONE GRANGE - - -	34	0	8	0	10	1880
104	BROOKE - - -	32	0	7	6	10	1867
105	ALDERNEY - - - ST. ANNE - - -	33	0	8	6	10	1869
106	GUERNSEY - - - ST. PETER'S - - -	32	0	7	8	10	1875
107	DORSET - - - POOLE - - -	34	0	8	3	10	1880
108	SWANAGE - - -	35	0	9	0	10	1875
109	KIMERIDGE - - -	32	0	7	6	10	1881
110	WEYMOUTH - - -	33	0	8	6	10	1869
111	LYME REGIS - - -	33	0	8	0	10	1866
112	SOUTH DEVON - - SIDMOUTH - - -	33	0	8	6	10	1869
113	EXMOUTH - - -	32	0	7	6	10	1867
114	TEIGNMOUTH - - -	32	0	7	4	10	1880
115	TORQUAY - - -	33	0	8	6	10	1876
116	BRIXHAM - - -	34	0	8	6	10	1866
117	DARTMOUTH - - -	33	0	8	6	10	1878
118	SALCOMBE - - -	33	0	8	6	10	1869
119	HOPE COVE - - -	35	0	9	0	10	1878
120	YEALM RIVER - - -	35	0	9	0	10	1878
121	PLYMOUTH - - -	34	0	7	9	10	1873

No.	NAME OF BOAT AND DONOR.	NAME AND ADDRESS OF HONORARY SECRETARY.
64	<i>Mark Lane</i> —London Corn Exchange	} Mr. J. Petts, 23 Queen's Road, Great Yarmouth.
65	<i>Abraham Thomas</i> —M. B.	
66	<i>Leicester</i> —Town of Leicester	} J. P. Baumgartner, Esq., Gorleston, Great Yarmouth.
67	<i>Samuel Plimsoll</i> —Plimsoll Life-boat Funds	
68	<i>The Two Sisters, Mary and Hannah</i> —The late Mr. Thomas Parkin.	} Frederick Morse, Esq., Lowestoft.
69	<i>Henry Burford, R.N.</i> —Legacy of J. L.	} Mr. J. Henderson, Lowestoft.
70	<i>Bolton</i> —Town of Bolton [Fund	} W. F. Larkins, Esq., Holm View, near Lowestoft. [toft.
71	<i>St. Michael's, Paddington</i> —That Life-boat	} Wm. Warman, Esq., Marine Villa, Kirkley, near Lowest-
72	<i>London Coal Exchange</i> —London Coal Exchange	} Mr. C. Rashley, Chief Officer of C. G ^d , Kessingland, Wangford.
73	<i>Quiver No. 2</i> —Quiver Magazine	} Mr. J. Sinclair, East Cliff, Southwold, Wangford.
74	<i>John Keble</i> —Rev. T. Keble	
75	<i>Ipswich</i> —Town of Ipswich.	
76	<i>George Hounsfield</i> —Mrs. Hounsfield	
77	<i>Springwell</i> —Miss Burmester	Dr. S. Evans, Harwich.
78	<i>Albert Edward</i> —Freemasons of England	W. Wrench Towse, Esq., Clacton-on-Sea, Colchester.
79	<i>Boys of England and Edwin J. Brett</i> —That Life-boat Fund.	James Richmond, Esq., 7 Royal Terr., Southend, Essex.
80	<i>Quiver No. 1</i> —Quiver Magazine	William Crawford, Esq., Margate.
81	<i>Thomas Chapman</i> —R. N. L. B. Institution.	(Capt. Isacke, North Foreland Lodge, Broadstairs.
82	<i>Samuel Morrison Collins</i> —A Lady	} Mr. J. J. Francis, Chief Off. of C. G ^d , Kingsgate, Margate.
83	<i>Bradford</i> —Town of Bradford.	} Mr. Thomas Jackson, H.M. Coastguard, Broadstairs.
84	<i>Mary Somerville</i> —Miss Somerville's legacy	} Capt. E. Jones, Harbour Master, Ramsgate.
85	<i>Centurion</i> —A Friend	} Rev. T. S. Treanor, Upper Deal.
86	<i>Charles Hargrave</i> —His Legacy	} Mr. W. Bailey, H.M. C. G ^d , Kingsdowne, near Dover.
87	<i>Henry William Pickersgill, R.A.</i> —His Legacy.	} Lieut.-General Bruce, C.B., 1 East Cliff, Dover.
88	<i>Mayer de Rothschild</i> —Lady Rosebery	George Wilks, Esq., Hythe, Kent.
89	<i>Dr. Hatton</i> —Mrs. Hatton	H. Cobb, Esq., New Romney, S.O., Kent.
90	<i>David Hulett</i> —D. Hulett, Esq. [Esq.	E. T. Bass, Esq., J.P., Lydd, New Romney, S.O., Kent.
91	<i>Mary Stanford</i> —Legacy of John Stanford.	} J. S. Vidler, Esq., Mountsfield, Rye, S.O., Sussex.
92	<i>Frances Harris</i> —Her Legacy	
93	<i>Charles Arkcoll</i> —Charles Arkcoll, Esq.	
94	<i>William and Mary</i> —Friends at Manchester	
95	<i>Michael Henry</i> —Jewish Scholars' Life-boat Fund.	
96	<i>Robert Raikes</i> —London Sunday Schools	W. R. Wood, Jun., Esq., 53 Norfolk Square, Brighton.
97	<i>Ramonet</i> —The late Miss Robertson	Thos. Fuller, Esq. M.D., Longcroft, Shoreham.
98	<i>Henry Harris</i> —Mr. Harris's Legacy	Melvill Green, Esq., Worthing.
99	<i>Four Sisters</i> —Misses Hallam and Mrs. Birt	Rev. H. Mitchell, M.A., Bosham, near Chichester.
100	<i>Undaunted</i> —The late Richard Thornton West, Esq., and Mrs. West	Rev. H. Foster, Selsey Rectory, Chichester.
101	<i>Olive Leaf</i> —Messrs. Leaf, Sons, and Co.	J. Gorham, Esq., Cackham, Chichester.
102	<i>City of Worcester</i>	Wm. Payne, Esq., National Provincial Bank of England, Portsea, Hants. [I.W.
103	<i>Worcester Cadet</i> —That Life-boat Fund	Admiral Wilmshurst, C.B., Bembridge, Brading, R.S.O., (Rev. W. E. Heygate, M.A., Brightstone, Newport, I.W.
104	<i>George and Anne</i> —Mr. and Miss Marten	Rev. Reginald Broughton, Shorwell, Newport, I.W.
105	<i>Mary and Victoria</i> —The Earl of Strafford	Mr. W. Selby, Brooke Farm, Isle of Wight.
106	<i>John Lockett</i> —Mrs. and the Misses Lockett	Nicholas Barbenson, Esq., Alderney, Guernsey.
107	<i>Boy's Own No. 2</i> —That Life-boat Fund	Capt. Carré, R.N., Valnord, Guernsey.
108	<i>Charlotte Mary</i> —S. J. Wilde, Esq., for late Miss M. R. Wilde.	G. Braxton Aldridge, Esq., Poole.
109	<i>Mary Heape</i> —Benjamin Heape, Esq.	Mr. Henry Hixson, Swanage, Wareham.
110	<i>Agnes Harriet</i> —The Earl of Strafford	George H. Bond, Esq., Creech Grange, Wareham.
111	<i>Wm. Woodcock</i> —H. W., Manchester Branch	G. H. Price, Esq., Collector H.M. Customs, Weymouth.
112	<i>Rimington</i> —Mrs. Rimington	Mr. H. Miller, Marine Parade, Lyme Regis.
113	<i>Victoria</i> —Lady Rolle	W. M. Floyd, Esq., Sidmouth.
114	<i>Arnold</i> —Teignmouth Bazaar	Capt. Squire, 1 Louisa Terrace, Exmouth.
115	<i>Mary Brundret</i> —Mrs. Brundret, per Manchester Branch.	J. W. Beater, Esq., Teignmouth, Devon.
116	<i>City of Exeter</i> —Collected in Exeter	Mr. R. G. Cove, Clifton Villa, Warren Road, Torquay.
117	<i>Maud Hargreaves</i> —Mrs. Hargreaves	Rev. R. F. Elrington, M.A., Lower Brixham, Devon.
118	<i>Rescue</i> —The late Richard Durant, Esq.	Percy Hockin, Esq., Dartmouth.
119	<i>Alexandra</i> —Freemasons of England.	W. H. Webb, Esq., Salcombe, Kingsbridge.
120	<i>Bowman</i> —"A. B. S."	M. Williams, Esq., Gnaton Hall, Yealmspton, Plympton.
121	<i>Clemency</i> —Hon. Mrs. Hubbard	James Rooney, Esq., Great Western Docks, Plymouth.

[Continued.]

No.	STATION.	Length.		Breadth.		No. of Crew.	When Stationed or Named.
		Ft.	in.	Ft.	in.		
122	CORNWALL - - - LOOE - - - - -	34	0	8	0	10	1882
123	FOWEY - - - - -	32	0	7	5	10	1879
124	MEVAGISSEY - - - - -	33	0	8	1	10	1869
125	PORTLOE - - - - -	33	0	8	1	10	1870
126	FALMOUTH - - - - -	33	0	8	6	10	1867
127	PORThOUSTOCK - - - - -	33	0	8	0	10	1869
128	CADGWITH - - - - -	33	0	8	1	10	1878
129	LIZARD - - - - -	30	0	7	2	10	1873
130	MULLION - - - - -	33	0	8	6	10	1867
131	PORThLEVEN - - - - -	34	0	8	0	10	1882
132	PENZANCE - - - - -	32	0	7	4	10	1865
133	SENNEN COVE - - - - -	34	0	8	3	10	1880
134	SCILLY ISLANDS - ST. MARY'S - - - - -	37	0	9	0	12	1874
135	CORNWALL - - - ST. IVES - - - - -	32	0	7	6	10	1878
136	HAYLE - - - - -	32	0	7	6	10	1866
137	NEW QUAY - - - - -	33	0	8	1	10	1873
138	PADSTOW - - - - -	32	0	7	4	10	1864
139	PORT ISAAC - - - - -	32	0	7	7	10	1869
140	BUDE - - - - -	33	0	8	0	10	1863
141	NORTH DEVON - - CLOVELLY - - - - -	33	0	8	1	10	1881
142	APPLEDORE—No. 1 - - - - -	34	0	7	1	12	1862
143	„ No. 2 - - - - -	30	0	6	7	6	1875
144	BRAUNTON - - - - -	34	0	8	1	10	1881
145	MORTE BAY - - - - -	33	0	7	11	10	1871
146	ILFRACOMBE - - - - -	32	0	7	6	10	1866
147	LYMOUTH - - - - -	30	0	7	7	8	1869
148	SOMERSET - - - WATCHET - - - - -	33	0	8	6	10	1875
149	BURNHAM - - - - -	32	0	7	5	10	1866
SOUTH WALES.							
150	GLAMORGANSHIRE PENARTH - - - - -	37	0	8	0	12	1881
151	PORThCAWL - - - - -	32	0	7	9	10	1872
152	SWANSEA - - - - -	33	0	8	1	10	1866
153	CARMARTHENSHIRE PEMBREY - - - - -	32	0	7	6	10	1871
154	CARMARTHEN BAY - - - - -	32	0	7	6	10	1879
155	PEMBROKESHIRE - TENBY - - - - -	33	0	8	0	10	1877
156	MILFORD - - - - -	33	0	8	6	10	1868
157	LITTLEHAVEN, ST. BRIDE'S - - - - -	33	0	8	2	10	1882
158	SOLVA - - - - -	33	0	8	1	10	1869
159	ST. DAVID'S - - - - -	32	0	7	6	10	1869
160	FISHGUARD—No. 1 - - - - -	30	0	6	8	6	1863
161	„ No. 2 - - - - -	36	0	8	3	12	1878
162	CARDIGANSHIRE - CARDIGAN - - - - -	32	0	7	4	10	1864
163	NEWQUAY - - - - -	35	0	8	0	12	1864
164	ABERYSTWITH - - - - -	35	0	9	0	10	1881
NORTH WALES.							
165	MERIONETHSHIRE- ABERDOVEY - - - - -	32	0	7	4	10	1865
166	BARMOUTH - - - - -	34	0	8	4	10	1867
167	CARNARVONSHIRE- PORTMADOC - - - - -	34	0	8	0	10	1882
168	ABERSOCH - - - - -	33	0	8	1	10	1869
169	PORThDINLLAEN - - - - -	37	0	9	0	12	1877
170	ANGLESEY - - - LLANDDWYN - - - - -	32	0	7	6	10	1866
171	REOSNEIGIR - - - - -	30	0	7	6	10	1872
172	REOSCOLYN - - - - -	33	0	8	0	10	1878
173	HOLYHEAD - - - - -	37	0	9	1	12	1875

No.	NAME OF BOAT AND DONOR.	NAME AND ADDRESS OF HONORARY SECRETARY.
122	<i>Boys' Own No. 1</i> —That Life-boat Fund . . .	R. Thomas, Esq., Looe, R.S.O., Cornwall. [Cornwall.
123	<i>Arthur Hill</i> —Arthur Hill, Esq.	W. E. Geach, Esq., Penellick, Par Station, R.S.O.,
124	<i>South Warwickshire</i> —Collected by Sir R. N. Hamilton, Bt.	Capt. J. Ball Farran, Mevagissey, St. Austell.
125	<i>Gorfenkle</i> —Legacy of J. Gorfenkle, Esq.	Rev. Canon Cornish, M.A., Veryan Vicarage, Grampond
126	<i>City of Gloucester</i> —Gloucester City	Charles Clift, Esq., Falmouth. [Road.
127	<i>Mary Ann Story</i> —Mrs. Story's Legacy	Mr. E. P. Roskrugs, St. Keverne, Helston.
128	<i>Joseph Armstrong</i> —That Life-boat Fund	Rev. F. C. Jackson, Ruan Minor, R.S.O., Cornwall.
129	<i>Anna Maria</i> —The late Lord Robartes	Rev. P. Vyvyan Robinson, The Lizard, Cornwall.
130	<i>Daniel J. Draper</i> —Wesleyan Methodists	Rev. E. G. Harvey, Mullion, Cury, Cross Lanes, R.S.O.,
131		J. P. Thomas, Esq., Porthleven, Helston. [Cornwall.
132	<i>Richard Lewis</i> —J. C.	} Fredk. C. Mathews, Esq., Dock Office, Penzance.
133	<i>Denzil and Maria Onslow</i> —Miss Onslow	
134	<i>Henry Dundas</i> —Mrs. Dundas Drummond's Legacy.	Mr. E. J. Bluett, Scilly, R.S.O., Cornwall.
135	<i>Exeter</i> —Mr. W. Kendall's Legacy	W. T. Tresidder, Esq., St. Ives, R.S.O., Cornwall.
136	<i>Isis</i> —Oxford University	John Poole, Esq., Riviere, Hayle.
137	<i>Pendock Neale</i> —Late Miss Neale and Miss Herring.	Capt. W. Thomas, New Quay, R.S.O., Cornwall.
138	<i>Albert Edward</i> —City of Bristol	Capt. Key, Padstow, R.S.O., Cornwall.
139	<i>Richard and Sarah</i> —The late Richard Thornton West, Esq., and Mrs. West.	W. Guy, Esq., Port Isaac, Wadebridge, R.S.O.
140	<i>Elizabeth Moore Garden</i> —Family of the late R. T. Garden, Esq.	Wm. Rowe, Esq., Stratton, "North Devon Mail."
141	<i>Graham Hughes</i> —The late Mrs. Hughes	Mr. J. Bumby, Chief Officer Ct. G ^d , Clovelly, Bideford.
142	<i>Hope</i> —The late Rev. F. W. Hope	} Rev. I. H. Gosset, M.A., The Priory, Westward Ho! Bideford.
143	<i>Mary Ann</i> —The late Mrs. M. A. Walker	
144	<i>Robert and Catherine</i> —Miss Leicester	Mr. W. Nicol, Appledore, R.S.O., Devon.
145	<i>Grace Woodbury</i> —Mr. Robt. Atton's Legacy	Mr. H. C. Guppy, National Provincial Bank, Barnstaple.
146	<i>Broadwater</i> —Late R. Broadwater, Esq.	N. Vye, Esq., J.P., Ilfracombe.
147	<i>Henry</i> —A Lady	Mr. John Crook, Valley of Rocks Hotel, Lynton, Barnstaple.
148	<i>Joseph Somes</i> —Mrs. Somes	R. J. Gimblett, Esq., Williton, Taunton. [water.
149	<i>Cheltenham</i> —Town of Cheltenham	Beverley R. Morris, Esq., M.D., Burnham, near Bridge-
150	<i>Joseph Denman</i> —Hon. Mrs. Joseph Denman	Capt. Pengelley, H.M.I.N., Dock Master, Penarth,
151	<i>Chafyn Grove</i> —Miss J. E. Chafyn Grove	Rev. W. Jones, Newton Nottage, Bridgend. [Cardiff.
152	<i>Wolverhampton</i> —Town of Wolverhampton.	T. W. Islay Young, Esq., West Cross, Oystermouth, near Swansea.
153	<i>Stanton Meyrick, of Pimlico</i> —His Legacy	Gerard Elkington, Esq., Pembrey, Llanelly.
154	<i>City of Manchester</i> —Manchester Branch	John Risley, Esq., Brondeg, Ferryside, R.S.O.
155	<i>Carolina Morris's Divine Rescue</i> —Mrs. Morris's Legacy.	J. R. Rowlands, Esq., Nat. Provincial Bank, Tenby.
156	<i>Katharine</i> —Titus Salt, Esq.	Henry Pattison, Esq., Collector H.M. Customs, Milford.
157	<i>Friend</i> —Mr. Corker's Legacy	Capt. Goldwyer, Walton Ho., Littlehaven, Haverfordwest.
158	<i>Charles and Margaret Egerton</i> —Widow of Capt. Egerton, R.N.	Samson T. Williams, Esq., Solva, R.S.O., Pembrokeshire. [Pembrokeshire.
159	<i>Augusta</i> —Earl of Dartmouth and Tenantry	W. Peregrine Propert, Esq., LL.D., St. David's, R.S.O.,
160	<i>Sir Edward Perrott</i> —R. N. L. B. Institution	} Mr. W. Vaughan, Fishguard, R.S.O., Pembrokeshire.
161	<i>Helen of Foxley</i> —Miss Harrison's Legacy	
162	<i>John Stuart</i> —Manchester Branch	John Morgan, Esq., Collector H.M. Customs, Cardigan.
163	<i>Nelson</i> —A Lady	Capt. David James, 2 High Terrace, New Quay, Llandys-
164	<i>Lady Haberfeld</i> —Her Legacy	Rev. J. Williams, Bridge Street, Aberystwith. [sil.
165	<i>Royal Berkshire</i> —Berkshire	[North Wales.
166	<i>Ellen</i> —"E. P. S."	Dr. F. H. V. Grosholz, Pier House, Aberdovey, R.S.O.,
167	Royal National Life-boat Institution	Mr. J. Jenkins, H.M. Customs, Barmouth, R.S.O.,
168	<i>Mabel Louisa</i> —Late R. Barnes, Esq., per Manchester Branch	[North Wales.
169	<i>George Moore</i> —That Life-Boat Fund	D. Homfray, Esq., Portmadoc, R.S.O., Carnarvonshire.
170	<i>John Gray Bell</i> —H. W., Manchester Branch	} Rev. O. Lloyd Williams, Bodfean, Pwllheli.
171	<i>Thomas Lingham</i> —Mrs. Lingham	
172	<i>Ramon Cabrera</i> —The Countess de Morella	
173	<i>Thomas Fielden</i> —Samuel, John, and Joshua Fielden, Esqrs.	
		John Jackson, Esq., Harbour Office, Carnarvon.
		Mr. J. W. Huws, Brynteg, Llanfaelog, Holyhead.
		J. H. Platt, Esq., Bodior, Holyhead.
		William P. Elliott, Esq., Holyhead.

No.	STATION.	Length.		Breadth.		No. of oars.	When Stationed or Named.
		Ft.	in.	Ft.	in.		
174	ANGLESEY - - - CEMLYN - - - - -	32	0	7	6	10	1877
175	CEMAES - - - - -	32	0	7	6	10	1881
176	BULL BAY - - - - -	32	0	7	7	10	1868
177	MOELFRE - - - - -	32	0	7	5	10	1874
178	PENMON - - - - -	34	0	8	0	10	1880
179	CARNARVONSHIRE ORME'S HEAD - - - - -	33	0	8	7	10	1867
180	DENBIGHSHIRE - LLANDDULAS - - - - -	33	0	8	6	10	1868
181	FLINTSHIRE - - - RHYL (TUBULAR) - - - - -	32	0	8	4	12	1856
182	„ No. 2 - - - - -	33	0	8	6	10	1878
183	CHESHIRE - - - NEW BRIGHTON, No. 1 (TUBULAR)	45	0	10	2	14	1876
184	„ No. 2 (Ditto) - - - - -	40	0	8	10	12	1878
185	LANCASHIRE - - - SOUTHPORT - - - - -	34	0	8	6	10	1874
186	LYTHAM - - - - -	33	0	8	0	10	1878
187	ST. ANNE'S - - - - -	34	0	8	3	10	1881
188	BLACKPOOL - - - - -	33	0	8	0	10	1864
189	FLEETWOOD - - - - -	34	0	8	6	10	1879
190	PIEL - - - - -	36	0	8	1	12	1878
191	CUMBERLAND - - - SEASCALE - - - - -	32	0	7	9	10	1875
192	WHITEHAVEN - - - - -	33	0	8	0	10	1866
193	MARYPORT - - - - -	32	0	7	4	10	1865
194	SILLOTH - - - - -	32	0	7	6	10	1867
195	ISLE OF MAN - - - RAMSEY - - - - -	33	0	8	6	10	1868
196	DOUGLAS No. 1 - - - - -	32	0	7	6	10	1868
197	„ No. 2 - - - - -	35	0	9	0	10	1874
198	CASTLETOWN - - - - -	32	0	7	6	10	1865
SCOTLAND.							
199	KIRKCUDBRIGHT - KIRKCUDBRIGHT - - - - -	32	0	7	6	10	1879
200	WIGTOWNSHIRE - WHITHORN - - - - -	33	0	8	6	10	1869
201	PORT LOGAN - - - - -	30	0	7	1	10	1866
202	PORT PATRICK - - - - -	37	0	8	6	12	1877
203	AYRSHIRE - - - BALLANTRAE - - - - -	33	0	8	1	10	1871
204	GIRVAN - - - - -	32	0	7	5	10	1882
205	AYE - - - - -	32	0	7	5	10	1867
206	TROON - - - - -	32	0	7	6	10	1871
207	IRVINE - - - - -	33	0	7	6	10	1874
208	ARDROSSAN - - - - -	34	0	8	3	10	1880
209	ISLE OF ARRAN - KILDONAN - - - - -	32	0	7	6	10	1881
210	ARGYLLSHIRE - - - CAMPBELTOWN - - - - -	32	0	7	6	10	1876
211	SOUTHEND - - - - -	32	0	7	6	10	1869
212	ORKNEYS - - - STROMNESS - - - - -	33	0	8	0	10	1867
213	LONGHOPE - - - - -	37	0	9	2	12	1874
214	CAITHNESS-SHIRE - THURSO - - - - -	33	0	8	0	10	1871
215	HUNA - - - - -	34	0	8	3	10	1877
216	ACKERGILL - - - - -	30	0	8	0	8	1878
217	NAIRNSHIRE - - - MORAY FIRTH - - - - -	34	0	8	3	10	1878
218	ELGINSHIRE - - - LOSSIEMOUTH - - - - -	32	0	7	6	10	1866
219	BANFFSHIRE - - - BUCKIE - - - - -	33	0	8	1	10	1871
220	BANFF - - - - -	32	0	7	6	10	1870
221	ABERDEENSHIRE - FRASERBURGH - - - - -	34	0	8	3	10	1880
222	WHITELINK BAY - - - - -	33	0	8	6	10	1878
223	PETERHEAD - - - - -	33	0	8	1	10	1865

No.	NAME OF BOAT AND DONOR.	NAME AND ADDRESS OF HONORARY SECRETARY.
174	<i>Good Shepherd</i> —Loyal Order of Ancient Shepherds.	Mr. W. Williams, Fronddu, near Cemaes, Amlwch, R.S.O., Anglesey.
175	<i>Ashionian</i> —The late George Heginbottom, Esq.	Rev. T. Lloyd Kyffin, Llanbadrig Vicarage, Amlwch, R.S.O., Anglesey.
176	<i>Eleanor</i> —A Lady in Wales	T. F. Evans, Esq., Amlwch, R.S.O., Anglesey.
177	<i>Lady Vivian</i> —Her collection	Rev. J. W. Evans, Llanallgo, Pentraeth, Anglesey.
178	<i>Christopher Brown</i> —Settle fund	William Preston, Esq., Vaynol, Bangor, N. Wales.
179	<i>Sisters' Memorial</i> —Two Sisters	G. F. Felton, Esq., Mostyn Estate Office, Llandudno.
180	<i>Henry Nixson, No. 2</i> —The late Henry Nixson, Esq., per Manchester Branch.	Rev. John Davies, M.A., Llanddulas Rectory, Abergel, R.S.O., Denbighshire.
181	<i>Morgan</i> —Miss Ellen Hodgson	} Mr. Robert Hughes, Rhyl, North Wales.
182	<i>Jane Dalton</i> —"D."	
183	<i>Willie and Arthur</i> —Joseph Leather, Esq.	} Charles H. Beloe, Esq., 13 Harrington Street, Liverpool.
184	<i>Stuart Hay</i> —Messrs. John Hay & Co.	
185	<i>Eliza Fernley</i> —Mr. Fernley's Legacy	J. A. Robinson, Esq., Southport.
186	<i>Charles Biggs</i> —Miss Biggs's Legacy	John Edmondson, Esq., Lytham, Preston.
187	<i>Laura Janet</i> —Jas. Chadwick, Esq.	W. A. Lloyd, Esq., St. Anne's-on-the-Sea, Preston.
188	<i>Robert William</i> —Mrs. and Miss Hopkins	A. M. Viner, Esq., Blackpool. [Fleetwood.
189	<i>Child of Hale</i> —Colonel W. B.	John Pickering, Esq., Preston Banking Company,
190	<i>William Birkett</i> —Mr. Birkett's Legacy	Capt. E. P. Stokes, Barrow-in-Furness, Lancashire.
191	<i>William Tomlinson</i> —Misses Tomlinson	Mr. J. Molyneux, Seascale, Cumberland.
192	<i>Elizabeth</i> —Miss Leicester	W. J. Tyson, Esq., 22 Lowther Street, Whitehaven.
193	<i>Henry Nixson, No. 1</i> —The late H. Nixson, Esq., per Manchester Branch.	W. H. Eckersley, Esq., Maryport.
194	<i>Mary Louisa</i> —Miss Browne's Legacy	} John Stronach, Esq., Silloth, R.S.O., Cumberland.
195	<i>Two Sisters</i> —J. Ryder, Esq., per Manchester Branch.	
196	<i>Manchester and Salford Sunday Schools</i> —per Manchester Branch	} Thos. Bawden, Esq., North Quay, Douglas, Isle of Man.
197	<i>John Turner-Turner</i> —Mrs. Turner-Turner and Family	
198	<i>Commercial Traveller</i>	G. H. Quayle, Esq., Castletown, Isle of Man.
199	<i>Mackie</i> —Dr. Mackie's Bequest	James M ^c Muldrov, Esq., Kirkcudbright.
200	<i>Charlie Peck</i> —A Lady.	Alex. Macfie, Esq., Clydesdale Bank, Whithorn, R.S.O., Wigtownshire.
201	<i>Edinburgh and R. M. Ballantyne</i> —Edinburgh Workpeople, and Edinburgh Ladies' Endowment Fund.	Quintin Cochrane, Esq., Port Logan, R.S.O., Wigtownshire.
202	<i>Civil Service, No. 3</i> —Civil Service Fund	[Wigtownshire.
203	<i>William and Harriot</i> —Mrs. Richardson's Legacy.	David A. Mc ^c Clew, Esq., Dinvin, Port Patrick, R.S.O.,
204	<i>Sir Home Popham</i> —Mrs. Popham's Legacy.	Mr. Jas. Wason, Postmaster, Ballantrae, Girvan.
205	<i>Glasgow Workman</i> —Glasgow Workpeople	Wm. Forsyth, Esq., Girvan.
206	<i>Mary Sinclair</i> —Mrs. Sinclair	John Pollock, Esq., Town Clerk's Office, Ayr.
207	<i>Isabella Frew</i> —William Somerville, Esq.	Alexander Wyllie, Esq., Troon.
208	<i>Fair Maid of Perth</i> —Peter Reid, Esq.	James Dickie, Esq., Council Chambers, Irvine.
209	<i>Emily Dewar</i> —Mrs. Dewar's Legacy	John Craig, Esq., Ardrossan.
210	<i>Princess Louise</i> —Life-boat Fund	Patrick Murray, Esq., Brodick, R.S.O., Isle of Arran.
211	<i>John R. Ker</i> —Robert Ker, Esq.	} Mr. Alexander Mitchell, H.M. Customs, Campbeltown.
212	<i>Saltaire</i> —The late Sir Titus Salt, Bart.	
213	<i>Dickinson Edleston</i> —The late D. Edleston, Esq.	Capt. G. Bilton, Stromness, S.O., Orkney.
214	<i>Charley Lloyd</i> —Mr. Lloyd's Legacy	Edward E. Corrigan, Esq., Longhope, Kirkwall.
215	<i>W. M. C.</i> —"X. Y. Z."	J. Coghill, Esq., Thurso.
216	<i>George and Isabella</i> —Miss Bower	Mr. David Dunnett, Quoys, Canisbay-by-Wick.
217	<i>Caulfield and Ann</i> —Mr. Lloyd Williams' Legacy.	G. M. Sutherland, Esq., Bridge Street, Wick.
218	<i>Bristol & Clifton</i> —Bristol Histrionic Club	H. T. Donaldson, Esq., Nairn.
219	<i>James Sturm</i> —Mr. Sturm's Legacy	[Elgin.
220	<i>John and Sarah</i> —J. E. Lightfoot, Esq.	Mr. John Ferguson, Harbour Master, Lossiemouth,
221	<i>Cosmo & Charles</i> —Capt. Gordon	John Shearer, Esq., Bank, Buckie, Fochabers.
222	<i>Robert Adamson</i> —Miss Adamson	James Watt, Esq., National Bank of Scotland, Banff.
223	<i>People's Journal</i> —No. 1—Subscribers to Dundee "People's Journal."	Andrew Tarras, Esq., Towns House, Fraserburgh.
		Mr. A. J. Birnie, Cairdenity, Inverallochy, by Lonmay,
		William Boyd, Esq., F.R.S.E., Peterhead. [Aberdeen.

[Continued.

No.	NAME OF BOAT AND DONOR.	NAME AND ADDRESS OF HONORARY SECRETARY.
224	<i>Peep-o'-day</i> —"A Scot Abroad"	Mr. James Boddie, Porthhead, Cruden, Ellon, N.B.
225	<i>Alexander Charles, and William Aird</i> —Miss Birtwhistle's Legacy.	Mr. P. Murray, Newburgh-by-Aberdeen.
226	<i>Star</i> —Mrs. Henry Hearn	David Carr, Esq., Stonehaven.
227	<i>Young George Irlam</i> —Mr. Irlam's Legacy	Rev. John Brown, Bervie, Fordoun.
228	<i>Mincing Lane</i> —Merchants of Mincing Lane	} James Warrack, Esq., Montrose.
229	<i>Roman Governor of Caer Hîn</i>	
230	<i>People's Journal</i> —No. 2—Subscribers to Dundee "People's Journal."	
231	<i>May</i> —"D."	} James Hunter, jun., Esq., 69 Reform Street, Dundee.
232	<i>English Mechanic</i> —Life-boat Fund	
233	<i>Ladies' Own</i> —Miss Smithers' Life-boat Fund	The Hon. Sec., St. Andrew's.
234	<i>Admiral FitzRoy</i> —A Lady (H. H.)	H. B. Mackintosh, Esq., Anstruther.
235	<i>Freemason</i> —Freemasons of England	D. McCulloch, Esq., British Linen Co., North Berwick.
236	<i>Wallace</i> —The late Lady Cuninghame—Fairlie	G. R. Scott, Esq., Bank, Dunbar.
237	<i>James and Rachel Grindlay</i> —Mr. T. Grindlay's Legacy.	Andrew Whittle, Esq., Bank, Eyemouth, Ayton.
238	<i>Mary Beckwith</i> —Mrs. Beckwith's Legacy	{ Pierce Crosbie, Esq., Greencastle, Moville.
239	<i>John Whitaker</i> —Late Mr. Whitaker's Trust Fund, per the late E. Absalom, Esq.	{ Thomas Lloyd, Esq., Greencastle, Moville.
240	<i>Florence</i> —A Friend	{ Rev. J. Simpson, } Portrush, R.S.O., Co., Antrim.
241	<i>Admiral Henry Meynell</i> —Misses Meynell Ingram.	{ W. E. Carver, Esq., J.P. }
242	<i>Memorial</i> —Misses Frances and Kate Peach	Rev. F. J. Hearne, Groomsport, Belfast.
243	<i>Farnley</i> —E. Armitage, Esq., R.A.	Rev. J. O'Reilly Blackwood, Ballywalter, Newtownards.
244	<i>James Thomas</i> —Miss Thomas's Legacy	D. McCann, Esq., Dundrum, Co. Down.
245	<i>Stockport Sunday School</i> —Life-boat Fund	Mr. W. Hayward, Newcastle, S.O., Co. Down.
246	<i>Old George Irlam, of Liverpool</i> —Miss Irlam's Legacy	J. F. Farrell, Esq., Harbour Office, Dundalk.
247	<i>John Rutter Chorley</i> —Mr. H. F. Chorley's Legacy	Mr. N. Halligan, Banktown, Drogheda.
248	<i>Maid of Annan</i> —Mrs. Langworthy	Tandy Cannon, Esq., Mornington House, Drogheda.
249	<i>Laura Platt</i> —Mr. Thos. Platt	Mr. J. McNamara, Harbour Office, Drogheda.
250	<i>Tilerias, Tunstall</i> —Thos. Peake, Esq.	{ H. A. Hamilton, Esq., } Balbriggan, R.S.O., Co. Dublin.
251	<i>Clara Baker</i> —A Friend, per Miss Baker	{ W. J. Cumisky, Esq., }
252	<i>Aaron Stark Symes</i> —Mrs. Elizabeth S. Symes	H. H. Foster, Esq., Skerries, S.O., Co. Dublin. [Dublin.
253	<i>Hector</i> —Late Miss Anderson and Niece	W. C. Townshend, Esq., Rogerstown, Rush, R.S.O., Co.
254	<i>Sarah Tancred</i> —Mr. Tancred's Legacy	Edward Greer, Esq., Evora, Howth, R.S.O., Co. Dublin.
255	<i>Robert T. Garden</i> —Late R. T. Garden, Esq.	Mr. S. Carr, C.O.C.G. ^d , King's End, near Dublin.
256	<i>Out-Pensioner</i> —Out-Pensioners	Capt. the Hon. F. G. Crofton, R.N., Harbour Master, Kingstown.
257	<i>Alfred and Ernest</i> —Manchester Branch	P. Reid, Esq., Glencarrig, Delgany, Greystones.
258	<i>John Brooke</i> —The Misses Brooke, per J. Richardson, Esq., Q.C.	S. E. Pim, Esq., Wicklow.
259	<i>Ethel Eveleen</i> —J. M. S.	{ The Earl of Wicklow, Shelton Abbey, Co. Wicklow.
260	<i>Civil Service</i> —No. 1—Civil Service Fund	Dr. Stopford Halpin, Arklow.
261	<i>Iris</i> —Mrs. A. M. Burdon	J. S. Scott, Esq., J.P., Levuka, Gorey, Co. Wexford.
262	<i>Richard and Anne</i> —The late Mrs. and Miss Warner.	Capt. R. D'Olier George, Cahore, Gorey, Co. Wexford.
263	<i>Alfred Trower</i> —Henry Trower, Esq., and Friends.	Mr. J. S. Sinnott, Cahore, Gorey, Co. Wexford.
264	<i>Christopher Ludlow</i> —Dr. Ludlow's Trustees	Wm. Coghlan, Esq., Collector H.M. Customs, Wexford.
265	<i>Hooper</i> —Miss Hooper	E. A. Gibbon, Esq., Skerlare House, Tagoat, Wexford.
266	<i>Wm. Beckett of Leeds</i> —A Leeds Gentleman	Mr. J. McGonagil, Duncannon, Waterford.
267	<i>Oliver Goldsmith</i> —That Life-boat Fund	Edward Jacob, Esq., Ardview, Tramore, Waterford.
268	<i>Quiver</i> —No. 3—"Quiver" Magazine	Mr. James W. Shaw, Dungarvan.
269	<i>City of Dublin</i> —Collected in Dublin	William C. Poole, Esq., M.D., J.P., Ardmore, Youghal.
270	<i>Crosby Leonard</i> —Late Crosby Leonard, Esq.	J. W. Pim, Esq., Youghal.
271	<i>Admiral Butcher</i> —R. G. Butcher, Esq.	T. W. Strangman, Esq., Shanagarry, Midleton.
		Capt. Nathaniel Sutton, Harbour Office, Queenstown.
		Capt. Townshend, Courtmacsherry, Bandon.
		J. A. O'Driscoll, Esq., Valentia, Killarney.
		Robert McCowen, Esq., Lloyd's Agent, Tralee.

are Messrs. Woolfe and Son, of Shadwell, London, E.

INDEX TO THE GIFT LIFE-BOATS OF THE ROYAL NATIONAL LIFE-BOAT INSTITUTION.

(The figures refer to the numbers of the Life-boats detailed on the ten preceding Pages.)

- A. B. S., 120.
 A Friend, 240.
 A Friend at Bradford, 53.
 A Friend, per G. H. Aston, 85.
 A Friend, per Miss Baker, 251.
 A Lady, 16.
 A Lady, 32.
 A Lady (H. H.), 234.
 A Lady, per Capt. Fish-bourie, R. N., C.B., 82.
 A Lady, "in memory of a very dear brother," 147.
 A Lady, 163.
 A Lady in Wales, 176.
 A Lady, per the late N. Griffith, Esq., 200.
 "A Scot abroad," 224.
 A Townsman of Leeds, 266.
 Abbott, the late John, Esq., 41.
 Adamson, Miss, 222.
 Ancient Shepherds, Loyal Order of (A.U.), 174.
 Anderson, Miss, the late, and Niece, 253.
 Anstice, Mrs., the late, 5.
 Arkcoll, Chas., Esq., 93.
 Armitage, E., Esq., R.A., 243
 Atton, R.W., Esq., the late, 145.
 Barlow, Miss, 24.
 Barnes, R., Esq., the late, 168.
 Beckett, Miss, the late, 18.
 Beckett, the late John, Esq., 39.
 Beckwith, the late Mrs., 238.
 Berkshire, collected in, 165.
 Biggs, Miss, the late, 186.
 Bird, Samuel, Esq., 51.
 Birkett, Wm., the late, 190.
 Birtwhistle, Miss, the late, 225.
 Bolton, collected in, 70.
 Bouchier, Lady, 63.
 Bower, Miss, 216.
 Boys of England, 79. [122.
 Boy's Own Life-boat Fund, Bradford, 83.
 Bristol, Collected in, 138.
 Bristol Historic Club, 218.
 "British Workman" Magazine, collected from the readers thereof, 59.
 Broadwater, Robert, Esq., the late, and Friends, 146.
 Brooke, the Misses, 258.
 Browne, Miss, the late, 194.
 Brundret, Mrs., 115.
 Burdon, Mrs. A. M., 261.
 Burmester, Miss, 77.
 Burton-on-Trent, Coll. in, 29.
 Butcher, R. G., Esq., 271.
 Cabbell, B. B., Esq., the late, Carter, Misses, 21. [55.
 Caslake, Mrs. B., 46.
 Chadwick, Jas., Esq., 187.
 Cheltenham, collected in, 149.
 Chorley, the late H. F., Esq., 247.
 Civil Service, 14, 202, 260.
 Coal Exchange, London. Members of, the 72.
 Commercial Travellers, 198.
 Corker, C. J. Esq, the late, 157.
 Corn Exchange, Mark Lane. Members of, the 64.
 Covent Garden Life-boat Fund, 62.
 Crossley & Sons, Messrs., J., 28.
 Cunningham-Fairlie, Lady, the late, 236.
 Cuttell, Esq., the late, 4.
 D. 182, 231.
 Dartmouth, the Earl of, and his Tenantry, 159.
 Davis, Mrs. Geo., the late, 61.
 Denman, Hon. Mrs. Jos., 150.
 Derby, collected in, 19.
 Dewar, the late Mrs., 209.
 Dixon, Miss, 45.
 Draper, Daniel J., Life-boat Fund, 130.
 Drummond, Mrs. Dundas, the late, 134.
 Dublin, collected in, 269.
 Dundee People's Journal, 223, 230. [late, 118.
 Durant, Richard, Esq., the E. P. S., 166. [201.
 Edinburgh Working Men's, Edinburgh Ladies' Endowment, 201. [late, 213.
 Edleston Dickinson, Esq., the "English Mechanic" Life-boat Fund, 232.
 Egerton, Capt. C. R., R.N., widow of, 153.
 Elliott, Mrs., 56.
 Ellis, Mrs., 34.
 Exeter, collected in, 116.
 Fernley, J., Esq., the late, 185.
 Fielden, Samuel, John, and Joshua, Esqs., 173.
 Foresters, Ancient Order of, 15, 26. [late, 35.
 Forkeath, Mrs. Harriott, the Foulston, Mrs. Eliz., the late, 20. [36.
 Fox, Children of Mr. and Mrs. Fraser, Mrs., 54.
 Freemasons of England, 78, 119, 235. [37.
 Freemasons of Warwickshire, Friends at Manchester, 94.
 Frith, J. G., Esq., the late, and Mrs. Frith, 3.
 Garden, the late R. T., Esq., 140, 255. [Mrs., 12.
 Gibb, T. Jones, Esq., and Glasgow Workmen's, 205.
 Gloucester, collected in, 126.
 Good Templars, Independent Order of, 17.
 Gordon, Capt., 221.
 Gorfenkie, the late Jacob, Esq., 125.
 Grindlay, Thomas, Esq., the late, 237.
 Grove, Miss J.E. Chafyn, 151. H. W., 111, 170.
 Haberfield, Lady, the late, 164.
 Hackwood, Thos., Esq., 9.
 Hallam, the Misses and Mrs. Margaret Birt, 99.
 Hargrave, Chas., Esq., the late, 86.
 Hargreaves, Mrs., 117.
 Harris, Mrs. H., the late, 92.
 Harris, H., Esq., the late, 98.
 Harrison, Miss, the late, 161.
 Hatton, Mrs. Jane, 89.
 Hay, John, & Co., 184.
 Heape, Benjamin, Esq., 109.
 Hearn, Mrs. Henry, 226.
 Heginbottom, Geo., Esq., the late, 175.
 Heyland Memorial Life-boat Fund, 58.
 Hill, Arthur, Esq., 123.
 Hindley, Job, Mr., the late, 27.
 Hodgson, Miss Ellen, 151.
 Hollon, R. W., Esq., and Mrs. Hollon, 38.
 Hooper, Miss, 265. [142.
 Hope, Rev. F. W., the late
 Hopkins, Mrs. W., Miss, 188.
 Hopkinson, Miss, the late, 10.
 Hounsfield, Mrs., 76.
 Hubbard, Hon. Mrs., 121.
 Huddersfield, collected in, 57.
 Hughes, Mrs., 141.
 Hulett, David, Esq., 90.
 Ingleby, Rev. Chas., the late, per G. P. Wragge, Esq., 23.
 Ingram, Herbert, Esq., M.P., Friends of the late, 49.
 Ingram, Misses Meynell, 241.
 Ipswich, collected in, 75.
 Iram, Geo. Esq., the late, 227.
 Iram, the late Miss, 246.
 J. C., 132.
 J. L., the late, 69.
 J. M. S., 259. [Fund, 95
 Jewish Scholars' Life-boat
 Joseph Armstrong Life-boat Fund, 128.
 Keble, Rev. T., 74. [135.
 Kendall, W., Esq., the late,
 Ker, Robert, Esq., 211.
 Ladies' Own Life-boat Fund,
 Landseer, Miss, 48. [233.
 Langworthy, Mrs., 248.
 Leaf, Sons & Co., Messrs., 101.
 Leather, Joe., Esq., 183.
 Leeds, Town of, presented in the name of, 266.
 Leicester, collected in, 66.
 Leicester, Miss, 144, 192.
 Leonard, C., Esq., the late, 270.
 Licensed Victuallers, collected from, 50.
 Lightfoot, J. E., Esq., 220.
 Lingham, Mrs., 171. [214.
 Lloyd, the late Chas., Esq.,
 Lockett, Mrs. & the Misses, 196.
 London Sunday Schools, 96.
 Louise, the Princess, Life-boat Fund, 210.
 Ludlow, the late Dr., 264.
 Mackie, Dr. the late, 199.
 M. B., 65.
 Manchester Branch, 1, 11, 27, 30, 111, 115, 154, 162, 168, 170, 180, 193, 195, 196, 257.
 Manchester and Salford Sunday Schools, 196.
 Marten, G., Esq., and Miss Marten, 104.
 Mather, Mrs. Annie, 22.
 Meyrick, Stanton, the late, 153.
 Middlewood, Geo., Esq., 40.
 Mincing Lane Merchants, 228.
 Moore, the late Geo., Esq., Life-boat Fund, 169.
 Morella, the Countess de, 172.
 Morris, the late Mrs., 155.
 N. R., 47.
 Neale, Miss, the late, and Miss Herring, 137.
 Nicholl, Mrs., the late, 52.
 Nixon, the late Henry, Esq., 180, 193.
 Northumberland, The Dowerager Duchess of, 8.
 Nottingham, collected in, 6.
 Odd Fellows (Manchester Unity), 44.
 Oliver Goldsmith, the, 267.
 Unslow, Miss, 133.
 Out-Pensioners, 256.
 Oxford University, 136. [68.
 Parkin, Thos., Esq., the late,
 Peach, Misses Frances and Kate, 242.
 Peake, Thomas, Esq., 250
 Pickersgill, the late H. W., Esq., R.A., 87.
 Platt, Mr. Thomas, 249.
 Plimssoll Life-boat Funds, 67.
 Popham, Mrs., the late, 204.
 "Quiver" Magazine, collected from the readers thereof, 73, 80, 264.
 Reid, Peter, Esq., 13, 208.
 Richardson, the late Mrs. Harriot, 203.
 Rimington, Mrs., 112.
 Roberts, Lord, the late, 129.
 Robertson, Miss, the late, 97.
 Rochdale, collected in, 25.
 Rolfe, Lady, 115.
 Roman Governor of Caer Ebn, the late, 229.
 Rosebery, Lady, 88.
 Rous, Admiral, Life-boat Fund, 43.
 Ryder, James, Esq., 195.
 St. Michael's, Paddington, Life-boat Fund, 71.
 Salt, Sir Titus, Bart., the late, 212.
 Salt, Titus, Esq., 156.
 Settle, collected in, 42, 178.
 Sinclair, Mrs., 206.
 Sister's Memorial, 179.
 Somes, Mrs., 148.
 Somerville, W. Esq., 207.
 Somerville, Miss, the late, 84.
 South Warwickshire Life-boat Fund, 124. [late, 91.
 Stanford, John, Esq., the Stockport Sunday Schools, 245.
 Story, the late Mrs. M. A., 127.
 Strafford, the Earl of, P.C., 105, 110.
 Sturm, the late Jas. Esq., 219.
 Sykes, the late Mrs. A. E., 33.
 Symes, Mrs. Elizabeth S., 252.
 Tancred, the late J. Esq., 254.
 Teignmouth Bazaar, 114.
 Thomas, Miss, the late, 244.
 Tomlinson, the Misses, 191.
 Townend, Mrs., 30.
 Trower, Henry, Esq., and friends, 263.
 Turner-Turner, Mrs. and Family, 197.
 Vivian, Lady, coll. by, 177.
 Watson, Lady, the late, 2.
 W. B., Colonel, 189.
 Walker, the late Mrs. Mary Wardell, Miss, 7. [Ann, 143.
 Warner, the late Mrs. and Miss, 262.
 Wesleyan Methodists, 130.
 West, R. Thornton, Esq., the late, and Mrs. West, 100, 139.
 Whitaker, the late John, Esq., per the late E. Absalom, Esq., 239.
 Wilde, S. J., Esq., for the late Miss M. R. Wilde, 108.
 Williams, Mr. Lloyd, the late, 217.
 Wolverhampton, coll. in, 152.
 Worcester Cadets Life-boat Fund, 103.
 Worcester, collected in, 102.
 X. Y. Z., 215.
 Yates, Mrs., the late, 31.

THE EXPENSE OF A LIFE-BOAT STATION IS £1,000. ITS COST IS MADE UP AS FOLLOWS:—

Life-boat and her equipment, including Life-belts for the Crew	
and Transporting-carriage for the Life-boat	£650
Boat-house (average cost)	350
Total	£1,000

The average annual expense of maintaining a Life-boat Station is £70, and the benefactions and contributions of Donors of Life-boats are earnestly solicited in aid of that fund.

GOD HELP OUR MEN AT SEA.

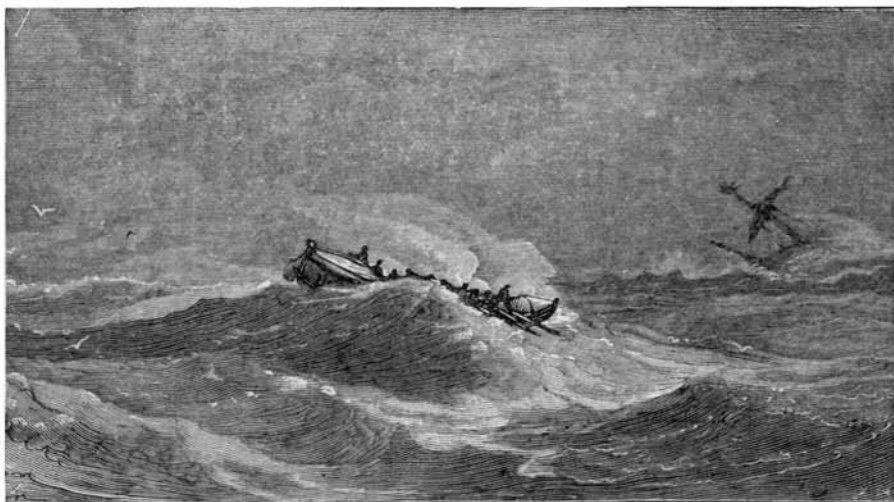

List of the Rewards

FOR SAVING LIFE FROM WRECKS

VOTED BY THE ROYAL NATIONAL LIFE-BOAT INSTITUTION

TO THE CREWS OF ITS LIFE-BOATS, TO SHORE AND FISHING-BOATS' CREWS, AND TO OTHER PERSONS,
FROM THE 1ST JANUARY TO THE 31ST DECEMBER, 1881.

Jan. 4.—At 3.45 A.M., in reply to signals of distress, the New Brighton Life-boat *Willie and Arthur* proceeded to the Asque Spit and found the s.s. *Brazilian*, of Barrow, ashore there. After the boat's arrival the steamer broke in two and filled with water, and her crew were then taken off by the Life-boat and put on board the Dock Board tender *Vigilant*. The steamer was bound from Boston to Liverpool, and had on board between seven hundred and eight hundred head of cattle.

Jan. 4.—At about midnight it was reported that two of the large fishing-boats were ashore on the Annat Bank, off Montrose, N.B. The *Mincing Lane* Life-boat on that Station was at once manned by a crew of fishermen, and proceeded to their aid. The fishing-boat *Magdalen* was found full of water, with the sea breaking over her, and the crew had taken refuge on board the other boat, the *Star of Peace*, which was farther up

on the bank, and partly sheltered by the *Magdalen*, but would have been in considerable danger as the tide flowed. Both the crews, numbering in all twelve men, were taken into the Life-boat and safely landed. The Life-boat afterwards assisted to save the boat *Star of Peace*.

Jan. 4.—The Teignmouth Life-boat *Arnold* saved two distressed fishing-boats and two men during an E.N.E. wind and heavy sea.

COMMITTEE MEETING, Jan. 6, 1881.

Voted 156*l.* 2*s.* 3*d.* to pay the expenses of the Brighstone Grange, Lizard, Donna Nook, Holy Island, Bude, Greencastle, Saltburn, and other Life-boats, in assembling their crews or putting off to the aid of vessels which did not ultimately require their assistance.

The Whitby, Greencastle, Ramsgate, Bude, and Winterton Life-boats had also

been taken out, but their services had not been eventually needed.

Voted the Gold Medal of the Institution to Lieut. J. A. W. O'NEILL TORRENS, 2nd Dragoons (Royal Scots Greys) in acknowledgment of his very intrepid services in skilfully taking command of the Poolbeg Life-boat, and assisting, at the peril of his life, to save two of the crew of the schooner *Robert Brown*, of Warrenpoint, which was wrecked near Pigeon House Fort, Dublin Bay, on the 28th October.

Also the Silver Medal of the Institution to Dr. HENRY LAWRENCE COX, A.M.D., in acknowledgment of his prompt and gallant services in assisting, at considerable peril, to launch the Life-boat on the above-named occasion.

Silver Medals of the Institution, accompanied by copies of the vote inscribed on vellum, were also voted to Bombadier WILLIAM SMITH, R.A.; Private PATRICK REILLY, A.S.C.; and Private FRANCIS HOWARD, 57th Regiment, in acknowledgment of their gallant services in going out in the Poolbeg Life-boat on the occasion in question.

The thanks of the Institution, inscribed on vellum, were also voted to Mr. B. W. JACKSON, Chief Engineer War Department s.s. *Stanley*, in acknowledgment of his valuable and skilful assistance in launching the Life-boat.

The thanks of the Institution were also voted to Lieut. ARTHUR M. MAUNSEL, and Lieut. RICHARD FFENNEL, of the 104th Fusiliers, for their services in helping to launch and haul up the Boat; and thanks and pecuniary rewards were also voted to Sergeants EASTON and BEECH, of the Royal Scots Greys, to Sergeant SHARP, Coast Brigade R.A., to Lance Corporal TODDS, 57th Regiment, and to ten private soldiers who had helped to launch and haul up the Life-boat.

Also the thanks of the Institution to the Rev. J. O'REILLY BLACKWOOD, in acknowledgment of his services in the Ballywalter Life-boat, in assisting to save a distressed boat belonging to Donaghadee, and her crew of three men, on the 9th December.

Also the thanks of the Institution to Captain McCLELLAND and to PROVOST STEELE, in acknowledgment of their valuable services in assisting to launch the Ayr Life-boat on the occasion of the

wreck of the brig *William Hill*, of Dundalk, during a S.W. gale and rough sea on the 19th December, when the Life-boat, after two unsuccessful attempts, was instrumental in rescuing the shipwrecked crew, consisting of three men.

Also the thanks of the Institution, inscribed on vellum, to the Rev. T. W. MANNING, Honorary Secretary of the Carnsore Branch, in acknowledgment of his zealous co-operation on the occasion of the wreck of the barque *John A. Harvie*, of Windsor, N.S., at Ballyhealy, co. Wexford, on the 27th November, when he proceeded out in the Carnsore Life-boat, and assisted to rescue the shipwrecked crew, consisting of nineteen men.

Jan. 6.—At about 7.30 a.m., a brigantine was seen ashore on the Halliday Sands off the coast of Essex, with a flag of distress flying. In a short time she drifted on to Pye Sand, where the masts were cut away. The Harwich Life-boat *Springwell* proceeded to her and found she was in a sinking state. Seven of the crew and a woman were taken into the Life-boat, but the master, mate, and boatswain, refused to leave. These eight persons were landed at midday, and as the weather continued exceedingly rough the boat returned for the others. The sea was then making clean breaches over the vessel, and the three men therefore left her and were brought safely ashore by the Life-boat. The vessel proved to be the Spanish schooner *Rosita*, bound from Hamburg to Porto Rico, with a general cargo.

Jan. 6.—On the occasion of the terrible wreck of the ill-fated ship *Indian Chief*, on the Long Sands, at the Mouth of the Thames, it will be remembered that she struck on the Sands at 2.30 a.m. on the 5th of January, but that nothing was known on shore of the wreck until nearly noon that day. In a quarter of an hour after the intelligence had reached Ramsgate, the harbour steamer *Vulcan* and the Life-boat *Bradford* were on their way to the Sands, notwithstanding that they were nearly thirty miles away from the port. Having such a long distance to traverse, in a fresh gale from the E.N.E., and a very heavy sea, they did not reach the Kentish Knock Lightship until 5 p.m. on that day, by which time it was nearly dark, and although they were given the bearings of the wreck, they were unable

to find it in the darkness. With great courage and determination, the Life-boat men then resolved to stay by the Sands until daybreak, involving their further exposure for fourteen hours in an open boat in a tremendous sea, the weather at the time being extremely cold. The steamer and Life-boat, therefore, cruised about between the Sands throughout the night, exposed to the whole fury of the storm. The steamer had her sponsons washed away, and one of the deck-houses damaged by the heavy seas, but happily no further casualty occurred. The suffering the Life-boat men endured during that bitter night was, if anything, in excess of what was experienced by those on the ill-fated ship; but with the dawn of day their reward came, for they then caught sight of the wreck. There was only the foremast standing, the main and mizenmasts having given way and gone overboard during the night, carrying with them the master and sixteen of the crew, all of whom were lost. With infinite risk and difficulty the Life-boat was then taken as near as possible to the wreck, and the survivors of the ship's crew, twelve in number, were got into the boat, one by one making their way along the rail of the vessel between the seas which were continually breaking over her. The Life-boat's cable was then slipped, sail was made, and she sailed across the Sands, through the heavy broken water, to the steamer, which took her in tow and proceeded for the harbour, which was safely reached soon after 2 p.m., after an absence of twenty-six hours. Three other Life-boats, stationed respectively at Harwich and Clacton (Essex), and Aldborough (Suffolk), also proceeded to the succour of the shipwrecked crew, but they were unable to render any service, notwithstanding that some of them remained out many hours, in the hope that they might be able to help the unfortunate seamen. The ship *Indian Chief* belonged to Liverpool, and was outward bound from Middlesbrough to Japan, with a general cargo.

Captain Braine, Harbour-master of Ramsgate, in reporting this noble service added: "Of all the meritorious services performed by the Ramsgate tug and Life-boat, I consider this is one of the best. The decision the coxswain and crew arrived at to remain till daylight, which

was in effect to continue for fourteen hours cruising about, with the sea continually breaking over them, in a heavy gale and tremendous sea, proves, I consider, their gallantry and determination to do their duty. The coxswain and crew of the Life-boat speak in the highest terms of her good qualities. They state that when sailing across the Long Sand, after leaving the wreck, the seas were tremendous, and the boat behaved most admirably. Some of the shipwrecked crew have since stated that they were fearful, on seeing the frightful-looking seas they were passing through, that they were in more danger in the Life-boat than when lashed to the mast of their sunken ship, as they thought it impossible for any boat to live through such a sea."

Jan. 6.—The Life-boat *Albert Edward* stationed at Clacton-on-Sea put off at about 5.30 p.m., in reply to signals of distress from the Swin Middle Lightship. The wind was blowing a gale from the E., and the sea was very heavy. On reaching the Lightship they learnt that a barque was ashore on the Maplin Sands. The Life-boat sighted her at 8 p.m., but she could not get alongside until the flood tide made, when she boarded her, and brought the master ashore to telegraph for instructions, arriving at Clacton at 11 a.m. The Life-boat afterwards, at the request of the captain, took him back to the vessel, which was the barque *Hertha*, of Christiansund in ballast.—Expense of service, 15*l.* 13*s.* 6*d.*

Jan. 8.—At about 2.15 p.m., the *Albert Victor* Life-boat stationed at Berwick-on-Tweed, was launched to render assistance to several distressed fishing-boats. The boat went over the bar four times, and accompanied the boats in, taking two of them, having nine men on board, in tow. But for the assistance rendered by the Life-boat the boats would in all probability have been swamped in crossing the bar.—Expense of service, 3*l.* 18*s.*

Jan. 10.—The *Palmerston* Life-boat at Cullercoats, Northumberland, put off to the aid of a fishing-coble which had been caught in a very high sea, rendering it dangerous for her to cross the bar. With the assistance of the Life-boat the coble safely reached the land.

Jan. 10.—The Redcar Life-boat *Burton-on-Trent*, rescued two men from the fishing-coble *Lively*, of Redcar, which was in

danger about a quarter of a mile off Redcar Beach, and unable to land on account of the very heavy surf, the wind blowing strongly from the N.E.

Jan. 11.—The Runswick Life-boat *Margaret and Edward* was launched, and rendered good service in assisting some Staithes fishing-cobles safely to land.

Jan. 11.—About fifty of the Staithes cobles were out, when a gale from the N. suddenly sprang up, accompanied by a heavy sea. The Staithes Life-boat *Hannah Somerset* went off to their aid, and accompanied most of them to the shore. The sea, however, increased, and as it was considered dangerous for the remaining seven cobles to attempt to land at Staithes they were advised to run for Runswick, and they therefore made for that place.

Jan. 13.—The Life-boat *Bolton* stationed at Kessingland, Suffolk, proceeded to the aid of the sloop *Ruby*, of Goole, which had been overtaken by a snow squall, and had been dismasted while passing through Pakefield Gap. Seeing that her position was one of much peril, on account of the proximity of dangerous sandbanks, the Life-boat *Bolton* was quickly launched, and, with the help of a steam-tug, took the vessel safely into Lowestoft Harbour. She was bound from Goole to St. Helens, with coal, and carried a crew of two men.

Jan. 14.—At 5.30 A.M., during a moderate breeze from the N.N.E., with snow squalls, the Ramsgate Life-boat *Bradford* and harbour steam-tug *Vulcan*, went out in response to signals of distress, and brought the schooner *Minnie Coles*, of Southampton, safely into Ramsgate harbour, that vessel having gone ashore on the N.E. part of the Goodwin Sands. She was on a voyage from London to Belfast, with a cargo of superphosphate and two and a half tons of gunpowder, and had a crew of five men. In going out to the vessel, the snow squalls were so thick that it was occasionally necessary to stop the tug's engines.

Jan. 15.—During a moderate gale from the W.N.W., accompanied by heavy snow showers, the *British Workman* Life-boat at Palling, Norfolk, was launched in reply to signals of distress, and found the s.s. *Trafalgar*, of London, ashore on the Hasborough Sand. The Life-boat remained by her for some hours, and finally rescued the crew, twenty-three in number, all of

whom were safely landed at Palling, though in a very benumbed condition. The steamer was on a voyage from Shields to Bombay, with a cargo of coal.—Expense of service, 37*l*.

Jan. 16.—On the evening of Sunday, 16th January, a letter was received by a messenger from Palling, stating that two ships were on the Hasborough Sand. A steam-tug was obtained from Great Yarmouth, and the Caister No. 2 Life-boat, *Godsend*, started at about four o'clock on the following morning. On arriving at the Sand the barque *North Wales*, of London, bound from Newcastle to Java with coal, was found ashore there. The steam-tug endeavoured to tow her off at the flood tide, but could not succeed. At ebb tide the vessel filled, and, as the sea was increasing, her crew of twenty men and a pilot were taken off by the Life-boat and put on board the steamer.—Expense of service, 33*l*.

Jan. 18.—At 10.45 A.M., on the urgent solicitation of a number of experienced master mariners, sailors and seamen at Brixham, Devon, the *City of Exeter* Life-boat was launched to render assistance to a pilot gig proceeding to put crews on board their vessels then riding in a strong gale from E.S.E. and very heavy sea in Brixham Roads. The crews in the gig were in great danger owing to the heavy sea and the number of vessels. The Life-boat was out nearly five hours in driving snow and a very heavy gale.—Expense of service, 6*l*. 10*s*.

Jan. 18.—Fearful weather was experienced at Porthdinllaen, North Wales, on this date, and the Life-boat *George Moore* was twice launched to the assistance of the crews of distressed vessels. The wind was blowing a very heavy gale from the E.N.E., and it was freezing hard when the boat was first launched at half-past one o'clock in the afternoon, and it was only with difficulty that she was enabled to rescue the crew of three men from the smack *Fishguard Lass*, of Abersoch, which was then at anchor in the bay in a dangerous position, and which shortly afterwards parted her second chain and drove ashore. At about 7.30 in the evening, the gale still blowing very hard from the same direction, the schooner *Miss Beck*, of Carnarvon, parted her anchors and drove on a rock called Carreg Oysters. The Life-boat quickly proceeded to her assist-

ance, but the vessel was in such an awkward position that the greatest difficulty was experienced in rescuing the crew of five men, the boat being out nearly five hours before she was enabled to accomplish the rescue, and sustaining some damage on the occasion. The Life-boatmen had at last the satisfaction of landing the shipwrecked crew in safety soon after midnight.—Expense of service, 23*l.* 15*s.*

Jan. 18.—The brig *Gyda*, of Swendsall, Norway, stranded half a mile north of Winterton, Norfolk. In consequence of the snow-drift it was found impossible to take the *Edward Birkbeck* Life-boat stationed at Winterton to the scene of the wreck on her carriage. She was then dragged along the shore on her launching-skids by the crew, assisted by a large number of men. When abreast of the wreck she was launched, and was successful in saving four of the crew. The remainder, five in number, had previously been rescued by the rocket apparatus.—Expense of service, 20*l.* 10*s.*

Jan. 18.—A heavy N.E. gale was experienced at St. Ives, Cornwall, accompanied by snow. During the height of the storm the crew of the Life-boat *Exeter*, in response to signals, launched their boat to the help of the crew of a vessel which was riding in the bay on a dead lee shore, and which it was seen must inevitably strike. The Life-boat, which is one of the smaller class, 32 feet long, made gallant attempts to get off in the teeth of the storm, and against a tremendous sea, but she was driven back into harbour, the sea knocking several of the oars out of the men's hands. At about 10 A.M. she again proceeded out, and after a severe struggle got alongside, and was successful in saving the crew of five men—not a moment too soon, for the vessel soon afterwards drove on the rocks. She was the schooner *Rosa Josephs*, of St. Vaast, France, bound from Britonferry to Cherbourg with a cargo of coal.—Expense of service, 24*l.* 10*s.*

Jan. 18.—At 11.30 A.M., a ketch was observed on shore on the North Beach at Great Yarmouth. The Life-boat *Abraham Thomas* immediately proceeded to the spot, and succeeded in rescuing the crew, consisting of four men. The wind at the time was blowing a heavy gale, and the sea was breaking heavily on the beach.

The ketch was the *Manne de Ciel*, a French vessel.—Expense of service, 15*l.* A few hours later, the schooner *Guiding Star*, of Padstow, stranded on the South Beach. The Life-boat was again launched, and took off the only man on board. She was then hauled towards the land by the rocket-line, worked by the people on shore, when she was capsized by a heavy sea, and six of her brave crew and the shipwrecked man unhappily perished.—Expense of launch, 30*l.* The Committee also voted, at the earliest opportunity, 700*l.* in aid of the local subscription for the relief of the families of the six Life-boatmen.

Jan. 19.—In reply to signals of distress from the Middle Lightship this morning, the Clacton Life-boat *Albert Edward* was launched and proceeded to a schooner which was found to be sunk with only the mast heads out of water. As no one was on the masts, the Life-boat made a further search and eventually sighted a dismasted ship. On nearing her, at about 2 P.M., a group of people were seen standing on one of the deck-houses waving a flag. The Life-boat made for her lee bow, the loaded cane was thrown to the crew, who seized it and hauled the boat's cable on board. The sea was making a clean breach over the vessel, and some difficulty was experienced in transferring the crew from her to the Life-boat; eventually, however, this was safely accomplished. The vessel proved to be the brigantine *Hasselo*, of Haguesund, bound from Riga to London with oats. The crew, eight in number, had been on the deck-house since noon on the previous day, and had not tasted anything for thirty-three hours. The Life-boat fortunately had some spirits and biscuits on board, which were distributed amongst the men and for which they were very grateful. On returning to shore the Life-boat saw two other vessels, but it was evident that their crews had been able to get ashore. When about three miles below the Middle Lightship signals were seen going up from the Mouse Lightship; but as the cold was so intense and the crew of the brigantine were in such an exhausted state that they would probably not have lived through the night if the boat had gone to the Mouse, it was considered best that the boat should make for Clacton. The Life-boat men had great difficulty in keeping life in the rescued men by constantly

rubbing their limbs, and were much afraid that they would not reach the land alive. They were, however, all safely landed at Clacton at about 4 o'clock on the following morning, and were taken to an hotel, where their wants were attended to.—Expense of service, 29*l.* 1*s.*

Jan. 19.—At 10.15 p.m., during a moderate gale from the N.E., the Ramsgate Life-boat *Bradford* and harbour steam-tug *Aid* proceeded to the assistance of the ship *Attila*, of Newcastle, which had lost her fore and main masts, and was riding near the Long Sand with a signal of distress flying. Four of the Life-boatmen went on board the vessel to render assistance, and the Life-boat returned to the tug to request her to take the ship in tow. The steamer, however, had not sufficient coal on board to enable her to take the vessel to a place of safety. The tug and Life-boat therefore returned to Ramsgate and obtained a supply. At 12.30 a.m. the Life-boat and tug again went out, having on board eleven of the crew of the *Attila*, who had been landed at Ramsgate by a fishing vessel. At daylight they reached the ship, put the eleven men on board her, and eventually towed her towards the North Foreland. The Life-boat then proceeded ashore to obtain the service of a pilot and another tug, arriving in the harbour at 9.15 p.m. A pilot having been obtained, and another steam-tug having been engaged, the ship was ultimately taken to Gravesend. The *Attila* was bound from Shields to Spezzia with a cargo of coal and coke, was 1,146 tons register, and carried a crew of twenty-two men.

Jan. 19.—A telegram was received at about 10.30 a.m. stating that a ship had sunk about six miles southward of Whitby, and that the crew had been compelled to take to their boat and come to an anchor. A message was sent in reply to say that the Whitby Life-boat *Robert Whitworth* should at once proceed there by road, and requesting that she might be met by men and horses, a gang of men being also despatched to cut the snow in front, which in places was six or seven feet deep. With the help jointly rendered by horses and men from both directions, the Life-boat was got to the scene of the disaster in little more than two hours, and was immediately launched. After pulling for an hour the steer oar and six other oars were broken, and she had to return to

shore for a fresh supply. A double crew then manned the boat, and with a cheer she was again launched through terrific seas. After struggling for an hour and a half, the shipwrecked crew of six men were reached, and safely landed at four o'clock. The poor fellows were thoroughly exhausted and benumbed, and it was only with great difficulty that they were brought back to consciousness, with the help of the medical men who were at hand ready to receive them. The Life-boat crew also suffered severely; one of them was so exhausted that he could not for some time return home. The vessel proved to be the brig *Visitor*, belonging to Whitby. She was bound from Shields to London, with coal.—Expense of service, 70*l.* 10*s.*

Jan. 20.—The Staithes fishing-cobles went out to their usual fishing-ground. During the day the sea became very strong, with heavy snow-showers, and when the boats returned at about 4 p.m. they found it was impossible to land at Staithes, and they then made for Runswick. The Runswick Life-boat *Margaret and Edward* thereupon proceeded to their assistance, and remained afloat three hours, assisting the boats to land.—Expense of service, 9*l.*

Jan. 20.—The *Herbert Ingram* Life-boat at Skegness, Lincolnshire, rendered some assistance to the brig *Matilda*, of Gothenburg. Two of the Life-boat men were put on board the vessel and assisted in taking her to Lynn.—Expense of service, 7*l.* 2*s.* 6*d.*

Jan. 20-21.—The *Springwell* Life-boat, of Harwich, on the night of the 20th January, proceeded out of harbour, in response to signals of distress. The boat was under the command of the second coxswain, WILLIAM BRITTON, Captain Nepean, R.N., the Institution's District Inspector, also being on board. It was freezing hard at the time, and the boat had to break her way clear of the ice which surrounded the piers. After eight hours' rowing the Life-boat fell in with the smack *Albatross*, which took her in tow for about four miles. At about five o'clock in the morning the Life-boat reached a steamer wrecked on the Sunk Sand, about fourteen miles from Harwich. She proved to be the *Ingerid*, of Rotterdam. The seven survivors of the wreck were then taken one by one on board the Life-

boat, which started on her homeward journey, reaching Harwich at ten o'clock. The rescued men received immediate medical attention, but they suffered terribly. The vessel was bound to Naples with fish, and ran ashore early on the morning of the 17th January. The crew made an attempt to launch a boat, manning it with eight hands, but seven of their number were drowned and two more were lost overboard afterwards. They then took refuge in the fore-castle. The next day the ship began to fill, and they had to lash themselves to the rigging, where they remained till they were rescued, enduring the intense cold without any provisions. The captain was the greatest sufferer, his legs being frightfully injured by the cold. The survivors when rescued were in a very precarious condition, most of them raving and delirious.—Expense of service, 48*l*.

Jan. 20.—At about noon information was received that a ship had gone ashore at Fort George, about seven miles W. of Nairn, N.B. The *Caulfield and Ann* Life-boat, stationed at Nairn, went to her assistance, and on reaching the scene of the wreck it was found that the sea was very high, and that the ship must soon go to pieces. Lines were hove aboard her, but the crew were too exhausted to make use of them, and it then became necessary for the Life-boat to go alongside. This was done, and with great difficulty themen, three in number, were rescued from their perilous position in an almost helpless state. The vessel proved to be the schooner *Annie Marie*, of Krageroe, Norway, bound thence to Wick with a cargo of billet wood.—Expense of service, 14*l*. 18*s*.

Jan. 27.—The steamer *Claremont*, of Newcastle, was wrecked at Whale Chine, Isle of Wight. Intelligence of the wreck was received at the Bristhone Grange Life-boat Station, and at about 11.40 P.M. the Life-boat *Worcester Cadet* proceeded to her assistance. Before this, voices had been heard at sea, and the Coxswain of the Life-boat therefore burnt a light and fired a gun to warn the ship's crew against landing, there being a heavy ground swell. As the tide was ebbing, the Life-boat rowed three miles W.S.W., and then picked up one of the ship's boats containing the mate and five men, who were safely landed at 3.40 on the following morning.—Expense of service, 23*l*. 15*s*.

Feb. 2.—In the evening signals of distress were seen from a vessel in the direction of the Barber Sand, off the Norfolk coast. The Caister No. 2 Life-boat *Godsend* promptly proceeded to the Sand and found the smack *Peace*, of Lowestoft, ashore there. The Life-boat dropped her anchor, sheered alongside the smack, and four or five of the Life-boat men jumped on board her. Just then the sea and tide drove the Life-boat away from the vessel: however, a line was got from her, and the boat was again hauled alongside. Immediately afterwards the smack was struck by a heavy sea, which heeled her over on to the boat, her mainboom and mainsail falling across the Life-boat and slightly injuring some of the crew. The crew of the smack and the Life-boatmen who had gone on board, at once jumped into the Life-boat. The next sea slightly righted the smack, and the boat was then cut adrift as quickly as possible, but the eddy tide catching her, swung her round against the vessel, and did some damage to the boat. After this, part of the boat's sail was set, and she hove to just clear of the Sand, and waited three quarters of an hour to see what would become of the vessel. Ultimately the smack drove off the Sand, when the Life-boatmen boarded her, and found her three parts full of water. Some of the sails were then set, and by constant pumping the water was kept under, and the smack was taken into Yarmouth Harbour. She had a crew of 5 men.

Feb. 2. — During a S.W. wind, the weather and sea being moderate, signals were observed from the Tongue Lightship about 7 P.M., in reply to which the *Quiver* Life-boat, stationed at Margate, proceeded to her, and learned that a vessel was in distress in a N.N.W. direction. The Life-boat went there, and found the American barque *Marie Stuart* ashore on the shingles. The crew of the Margate surf-boat, and some smack men were on board, and the captain, not thinking it advisable to leave his vessel without making every effort to save her, employed all the crews to lighten her, and try to get her off. Ten of the Life-boatmen went on board the barque, and the Life-boat laid by to render assistance if the vessel should suddenly break up. Two Margate luggers afterwards arrived, and their crews were also engaged to help to float the vessel. Some of the cargo was thrown out so as to lighten the

barque, and the bower anchor was taken out by one of the luggers, with about sixty or seventy fathoms of chain; two steam-tugs were subsequently engaged, and these combined efforts ultimately resulted in the vessel floating about 3 P.M. on the following day, when she proceeded to London with twenty-one of the Margate men on board, helping at the pumps.

COMMITTEE MEETING, Feb. 3, 1881.

Voted 659*l.* 8*s.* 1*d.* to pay the expenses of the Life-boats at Great Yarmouth, Harwich, Clacton-on-Sea, Aldborough, Whitby, Uppang, Southend (Essex), Donna Nook, Broadstairs, Rye, Brooke, Gorleston, Margate, Newhaven, Sheringham, Lydd, North Berwick, Drogheda, Winterton, Scarborough, Southwold, Theddlethorpe, Tenby, Cemaes, Abersoch, Eastbourne, and Hastings, in either assembling their crews or putting off to the aid of vessels which did not eventually require their assistance.

The *Lizard* and *Montrose* No. 1 Life-boats had also been taken out, but their services had not been ultimately needed.

Voted the Gold Medal of the Institution to Mr. CHARLES E. FISH, Coxswain of the Ramsgate Life-boat, in acknowledgment of his bravery, skill, and determination in aiding in the Ramsgate Life-boat, on the 6th January, to rescue the crew of the barque *Indian Chief*, wrecked on the Long Sands, on which arduous and dangerous service the Life-boat's crew were unceasingly exposed for twenty-six hours to a furious gale and heavy sea.—*Vide* p. 486.

Also the Silver Medal of the Institution, and a copy of the vote inscribed on vellum to each of the crew of the Ramsgate Life-boat, viz.:—RICHARD GOLDSMITH, THOMAS COOPER, SENIOR, THOMAS COOPER, JUNIOR, CHARLES VEINON, HENRY MEADER, STEPHEN GOLDSMITH, THOMAS FRIEND, HENRY BELSEY, JOHN GOLDSMITH, DAVID BERRY, and ROBERT PENNEY, in acknowledgment of their bravery and determination on the above-named occasion.

In addition to these rewards, the Silver Medal of the Institution, accompanied by a copy of the vote inscribed on vellum, was voted to Mr. ALFRED PAGE, Master, in acknowledgment of his bravery, skill, and determination, in aiding, in the Ramsgate Harbour steam-tug *Vulcan*, on the 6th

January, to rescue the crew of the barque *Indian Chief*. The Second Service Clasp of the Institution was also voted to Mr. WILLIAM WHARRIER, Engineer of the steam-tug, and the Silver Medal of the Institution, and its thanks inscribed on vellum, to each of the crew of the steamer, consisting of CHARLES KNIGHT, RICHARD YARE, GEORGE WOODWARD, WILLIAM AUSTEN, and EDWARD REVELL, in acknowledgment of their arduous and gallant services on the occasion.

Voted the Silver Medal of the Institution, and a copy of the vote inscribed on vellum, to Capt. ST. VINCENT NEPEAN, R.N., District Inspector of Life-boats of the Institution, in acknowledgment of his arduous and valuable services in the Harwich Life-boat, in aiding to rescue seven of the crew of the Dutch steamer *Ingerid*, on the night of the 20th January.

Also the Silver Medal of the Institution, accompanied by a copy of the vote inscribed on vellum, to Mr. WILLIAM BRITTON, assistant Coxswain of the Harwich Life-boat, in acknowledgment of his general gallant services in that boat in saving life from shipwreck, and particularly on the occasion of the wreck of the *Ingerid*.

Also the thanks of the Institution inscribed on vellum, accompanied by a Binocular Glass, with a suitable inscription, to Capt. ROBERT GIBSON, Harbour Master of Whitby, and Local Hon. Secretary of the Institution, in acknowledgment of his valuable and skilful services in the preservation of life from shipwreck, and especially for his valuable co-operation on the occasion of the rescue by the Whitby Life-boat of the crew of the wrecked brig *Visitor*, of Whitby, in Robin Hood's Bay on the 20th January.

Also the thanks of the Institution, inscribed on vellum, to Mr. ALEXANDER F. CROOKSHANK, for going off in the *St. Ives* Life-boat, and aiding to rescue the crew of five men from the schooner *Rosa Josephs*, of St. Vaast, France, which was wrecked in St. Ives Bay during a storm on the 18th January.

Also the thanks of the Institution to the Rev. WILLIAM GREEN, Honorary Secretary of the Winterton Branch, in acknowledgment of his zealous and valuable services on the occasion of the stranding of the brig *Gyda* of Swendsall, on the 18th January, in contributing to the rescue of

the crew by means of the Life-boat and the rocket apparatus.

Feb. 4.—At about noon the sea suddenly rose, breaking very heavily across the Bar, at Holy Island, Northumberland. Three cobsles were out fishing, and the *Grace Darling* Life-boat therefore proceeded across the Bar to their assistance, and accompanied each of them through the broken water; they were fortunately all enabled to regain the land in safety.

Feb. 5.—The s.s. *Broomhill*, of Dundee, while endeavouring to enter Sunderland Harbour, during a strong wind from the N.E. with a heavy sea, took the ground on the Bar, and was afterwards carried by the wind and sea on to a dangerous reef of rocks. The Sunderland No. 3 Life-boat *Florence Nightingale* proceeded to her assistance, and succeeded in taking eighteen men and a boy from her. The Sunderland No. 2 Life-boat afterwards, at the request of those interested in the steamer, put some men on board, who succeeded in getting her into Sunderland.—Expense of service, 8*l.* 15*s.*

Feb. 7.—At 9.30 A.M., during thick weather, the wind blowing a strong gale from the S.S.E., accompanied by heavy rain, the brigantine *Bransty*, of Whitehaven, bound from Newry to Penarth, with a cargo of oats, was seen to be drifting towards the Long Rocks in Dundrum Bay. She, however, cleared those rocks, and made a little way out to sea, but in consequence of almost all her canvas having been blown away, she was unmanageable, and it was evident that she would soon be dashed upon the rocks. The Tyrella Life-boat *Memorial* was thereupon speedily launched, and rescued the crew, consisting of 4 men. Great difficulty was experienced in effecting this rescue, owing to the very heavy seas about the vessel. The master had his right leg broken, the Life-boat being suddenly dashed against him by the sea, as he was about to drop from the side of the vessel into the Boat. The brigantine, soon after her crew had been taken off, became a total wreck.—Expense of service, 11*l.* 14*s.*

Feb. 7.—At about 6 P.M., the ketch *Thomas*, of Lynn, while endeavouring to make Hartlepool Harbour, went ashore near the Beacon Rocks. A gale from the S.S.E. was blowing at the time, accompanied by a heavy sea. Signals of distress were made by the crew of the vessel, and

the Hartlepool No. 3 Life-boat *John Clay Barlow*, proceeded to her, took off the crew of three men, and landed them safely.

The same Life-boat afterwards proceeded, in tow of a steam-tug, to the ketch *Yorkshire Lass*, of Boston, which had also stranded near the Beacon Rocks, and was instrumental in saving her crew of three men.

About the same time the Hartlepool No. 2 Life-boat *Charles Ingleby* was launched to a third vessel, the schooner *Mischief*, of Rye, which had also gone ashore near the Beacon Rocks. The crew of four men were taken into the Life-boat, and brought safely to land. Later in the evening the weather moderated, the wind shifted to the W., and the three vessels were got afloat again on the rising tide.—Expense of services, 34*l.* 10*s.*

Feb. 8.—In the morning, during a heavy westerly gale, the ketch *Brothers* lying in Caldys Roads, parted her chain. She then made sail, and stood across the bay, when her main-boom was carried away, which disabled her, and compelled her to bring up, by a single anchor and kedg, about five miles from Tenby. She then hoisted a signal of distress, in response to which the Life-boat *Divine Rescue*, stationed at Tenby, was launched, and took off the crew, consisting of four men. The Life-boat was unable to regain her Station, and therefore made for Pendine, where she remained at anchor for a time until the steam-tug *Hero*, of Pembrey, came and towed her back to Tenby. The service rendered by the Life-boatmen was promptly and well executed, and reflected great credit on the coxswain and crew, who suffered considerably from the severity of the weather.—Expense of service, 14*l.* 15*s.*

Feb. 8.—The Selsey Life-boat *Two Sisters* was launched to the aid of the three-masted schooner *Kyanite*, of Guernsey, which was in a position of much peril, having parted from both her anchors during a strong westerly gale and a very heavy sea. Some of the Life-boatmen, and four of the crew of a galley, went on board, and the vessel, which had a crew of seven men, was taken to a place of safety, the Life-boat accompanying her. The crew of the Life-boat suffered much from the cold and from the drenching sea.

Feb. 9.—About 8 o'clock in the morn-

ing a messenger from Perran Zabuloe arrived at Newquay, Cornwall, with intelligence that a vessel was at anchor, in a very dangerous position, near Hoblyn's Cove, east of Perran Beach. The *Pendock Neale* Life-boat, stationed at Newquay, was speedily launched, and, after encountering some very heavy seas off the five intervening headlands which project from this ironbound coast, she reached the vessel, which proved to be the ketch *Lizzie*, of Bridgwater, bound from Waterford to Falmouth with a cargo of oats. The Life-boat took off the crew of four men, and landed them safely at Newquay. A few hours afterwards the vessel drove ashore and became a total wreck.

The coxswain of the Life-boat, EDWIN CLEMENS, was suffering much from the effects of a broken rib, caused by an accident during the frost, but he nevertheless occupied his usual position in the Boat.—Expense of service, 12l. 9s.

Feb. 10.—At about 2.30 A.M. signals of distress were shown by a vessel off Jury's Gap, Sussex. The wind was blowing strongly from the S.W., and the sea was heavy at the time. The Rye Life-boat was launched, and got to windward of the vessel, but the anchor dragged, and she drifted to leeward, in spite of hard pulling. Eventually the coxswain considered that it would be best to beach the Boat, and have her taken along the shore to windward of the vessel. He therefore landed and procured six horses, but they failed to move the Life-boat and carriage over the heavy shingle, and four more horses were then obtained, but still it was found impossible to get the Boat along the beach. Ultimately she was taken off her carriage and dragged over the beach by men. After great exertions the Boat was again launched, and got alongside the vessel, when a communication was effected by means of the grapnel, and two of the seamen were taken from the rigging into the Life-boat. When about to rescue the remaining man, a tremendous sea broke over the Life-boat, and washed out one of her crew, straightened the grapnel, and broke the Boat's cable, causing her to drift to leeward. The Life-boatman was fortunately picked up, but the Boat could not then regain the wreck, and she had to be beached. The man left on board the vessel was rescued by means of the Rocket Apparatus

and the Coastguard galley. The vessel proved to be the sloop *Sophia Holten*, of Plymouth, bound from London to Jersey with a cargo of wheat. She became a total wreck.—Expense of service, 32l. 13s. 6d.

Feb. 11.—The schooner *John Green*, of Drogheda, Ireland, bound there with coal from Ardrossan, was entering the river Boyne while the wind was blowing hard from the E.N.E., and a very heavy sea running. A great deal of fresh water was passing out of the river and setting to the south, which caused the schooner to lose her steerage way, and come in contact with the sea wall on the south side of the river. The Drogheda No. 2 Life-boat *John Rutter Chorley* was launched, and with great difficulty and danger she fortunately succeeded in saving the crew, consisting of five men, from the stranded vessel.—Expense of service, 9l. 14s.

Feb. 11.—A small screw steamer and a schooner had been at anchor in Fishguard roadstead for some days, being unable to go round St. David's Head, owing to the strong westerly winds. On the night of the 10th February the wind suddenly shifted to the N.N.E., and blew a strong gale with a heavy sea. As the two vessels were in bad anchorage, and riding heavily, a good look out was kept, and soon after 11 o'clock on the following morning they exhibited signals of distress. The Fishguard Life-boat No. 2 went to the steamer, which proved to be the *Udea*, of Llanelly, bound from Ayr to Llanelly with a cargo of pig-iron, and took off her crew of ten men. She then proceeded to the schooner, the *George and Mary*, of Barrow, bound from Ardrossan to Newport with pig-iron, which had parted both chains and had drifted on Goodwick Sands. A tremendous sea was washing over her, and tossing her about fearfully, so that it was with the utmost difficulty that her crew of five men were taken off; but happily all were saved. The schooner became a total wreck. The Life-boat was reported to have behaved admirably on the occasion.—Expense of service, 11l. 10s.

Feb. 14.—The *Richard Lewis* Life-boat, stationed at Penzance, put off to the assistance of the ship *Mac Duff*, of Glasgow, which was riding at anchor in a dangerous position off Lamorna during a strong S.S.W. wind and a heavy sea. Some difficulty was experienced in finding the vessel, on account of the dense fog;

but eventually the Life-boat discovered her, and found that she had previously been boarded by the crew of a pilot gig. At the request of the master, some of the Life-boatmen assisted the other men to weigh the anchor and set the vessel's sails; after which she was taken to a safe anchorage, the Life-boat remaining by her until all danger to the ship and crew was over.

Feb. 14.—The brig *Eliza Emma*, of Shoreham, while entering Hartlepool, at about 7 P.M., during a moderate S.S.E. gale, accompanied by a very heavy sea, ran ashore on the Beacon Rocks, owing to the thickness of the weather preventing the lights from being seen. The Hartlepool No. 3 Life-boat *John Clay Barlow* proceeded to her assistance, and took off her crew of five men. The master, however, refused to leave the vessel, and the Life-boat therefore proceeded ashore with the five men. After they had been landed, the captain made signals, and the Life-boat thereupon returned to the vessel, and brought him also ashore.—Expense of service, 13*l*.

Feb. 22.—At about 11 A.M. signal guns were fired from the Lightship, indicating that a vessel was ashore on the South Bank at the mouth of the Tay, or in imminent danger. The Buddon Ness Life-boat *May* proceeded to the spot as soon as possible, and found a schooner ashore on the elbow end of the sands. The wind was blowing a strong gale from the N.E., with a heavy sea. The Life-boat with difficulty, after breaking two oars in the attempt, besides losing a grapnel, succeeded in getting alongside the vessel, which proved to be the schooner *Oscar*, of Leith, bound from Dundee to St. Felin de Guixols, in Spain, with a cargo of yarns. She had on board a crew of six men and a pilot, all of whom were taken into the Life-boat and safely landed. The sea was breaking over the vessel, and by the time the Life-boat left her she was full of water, and soon became a total wreck.—Expense of service, 6*l*. 10*s*.

Feb. 22.—At 11 P.M. the brigantine *Georgina*, of Portmadoc, bound from London to Cork, with a cargo of railway sleepers, struck on the Levellers Rocks to the north-eastward of Porthoustock, Cornwall. The night was very thick and dark, and a strong wind was blowing from the N.E., causing a heavy sea on the

shore. The coxswain of the *Mary Ann Storey* Life-boat at Porthoustock, seeing the vessel's signals of distress, got his crew together as quickly as possible, launched the Boat, and rescued the vessel's crew, consisting of five men. They were overjoyed at the approach of the Life-boat, as they had been every moment expecting a watery grave. The ship was in shallow water and surrounded by sharp rocks, rendering the Life-boat service very hazardous, as the Boat was liable at any moment to strike on them. The men had to be taken off by a hawser over the stern, and the master, being the last to leave, had to be hauled through the water. The signals of distress had been made with paraffin poured over an old sail, and after the crew had been rescued, the flames caught the vessel and burnt her to the water's edge.—Expense of service, 20*l*. 12*s*. 6*d*.

March 3.—During a very heavy gale from the S.E. the brigantine *Queen of the Usk*, of Whitehaven, bound from Kingstown to that port, in ballast, was riding very heavily in Douglas Bay, with two anchors down and dragging. The *John Turner Turner* Life-boat, stationed at Douglas, put off to her assistance, and brought safely ashore her crew of five men, they deeming it unsafe to remain on board.—Expense of service, 6*l*. 10*s*.

March 3.—At about 1.15 P.M. a vessel was seen to be striking heavily on the Bar. The Life-boat *Richard and Ann Warner* at Duncannon, co. Waterford, was got out, but owing to the state of the tide, and to the wind being in a S.S.E. direction, it was impossible to get down to the vessel until the arrival from Waterford of the steam-tug *Resolute*, which took the Boat in tow. The Life-boat then succeeded in picking up the master of the vessel in an exhausted condition off a piece of wreckage, but unfortunately, owing to the vessel breaking up, the remaining five lives were lost. She was the brigantine *Dayspring*, of Dublin, bound from Newcastle to Waterford with coals.—Expense of service, 12*l*.

March 3.—At noon the smack *Mary Cook*, of Campbeltown, was seen to be drifting from her moorings at the north of the harbour at Girvan, N.B., and was in imminent danger of being blown out to sea. The master of the smack, who was on shore at the time, asked that the

Life-boat might go out to rescue two boys who had been left on board. The Girvan Life-boat *Earl of Carrick* therefore proceeded to the vessel, and brought the two lads safely ashore.—Expense of service, 9*l*.

COMMITTEE MEETING, March 3, 1881.

Voted 26*4l*. 17*s*. 6*d*. to pay the expenses of the Palling, Thorpe, Torquay, Hartlepool, Montrose, Holyhead, Caister, Redcar, Saltburn, Newhaven, Clovelly, Duncannon, Padstow, Swansea, Porthdinllaen, Courtmacsherry, Winchelsea, Drogheda, Peterhead, Lowestoft, Kessingland, Penzance, and Falmouth Life-boats in assembling their crews or putting off to the assistance of vessels which had shown signals of distress, but which did not ultimately need the aid of the Boats.

The Ramsgate Life-boat had also been taken out, but her services had not been required.

March 4.—At about 1 A.M. intelligence was received that a ship had stranded in Ballyhalbert Bay, three miles south of the Life-boat Station at Ballywalter, co. Down. The wind was blowing a hurricane from the S.E., with heavy sleet and rain at the time. Horses were obtained, and the Life-boat *Admiral Henry Meynell* proceeded by road to the scene of the wreck. Great delay was occasioned on account of the horses being unable to draw the Boat against the gale and rain, the road being very bad and exposed. However, she at last reached the Bay, and was then launched with great difficulty over the very rough shore through a very heavy surf. She was repeatedly driven back by the seas, but after great exertion the crew managed to get hold of a line drifted to leeward from the ship, and by rowing and hauling they got under the bow of the vessel, which proved to be the ship *Castlemaine*, of Liverpool, bound from Rangoon to the Clyde, with a cargo of teak and bones, and in two trips brought ashore the crew of twenty-five men. The crew of the Life-boat, who were accompanied by the Rev. J. O'REILLY BLACKWOOD, the local Hon. Secretary at Ballywalter, behaved admirably, under very trying circumstances, and suffered greatly from the cold and long exposure.—Expense of service, 26*l*. 6*s*.

March 4.—A telegram was received

from the officer of Coastguard at Ballycraoneen, co. Cork, at about 3 A.M., stating that a vessel was displaying signals of distress off Queenstown. The *Quiver* Life-boat was speedily despatched to the spot in tow of the tug *Lord Bandon*, and found that the brigantine *Bessie Whinery*, of Maryport, from Pembrey for Cork, with a cargo of coal, was embayed; she was, however, under way, and endeavouring to beat out of the bay when the Life-boat arrived. Some of the Boat's crew went on board to assist at the pumps and direct her into port, where she arrived about 9 A.M. She carried a crew of six men.

March 4.—It was reported, about 5 P.M., that a schooner had gone ashore on the Lady Bank at the mouth of the Tay, and when she could be seen through the snow and drift, which was only at intervals, she appeared to be partially dismantled. The Broughty Ferry Life-boat *English Mechanic* went out under oars, in the teeth of a strong S.E. gale and heavy sea, and found the vessel was ashore between the Lady Bank and the mainland. The weather was very thick, and as darkness was coming on, the Life-boatmen exerted themselves to the utmost to rescue the crew before it became totally dark. After nearly two hours hard pulling, the Boat got alongside the vessel, which proved to be the Swedish schooner *Niels*, took off the crew of five men, and safely landed them at Broughty Ferry.—Expense of service, 7*l*. 11*s*.

March 5.—During a very strong gale from the S.S.E., and an exceedingly heavy sea, accompanied by a snowstorm, the schooner *Agnes*, of Llanelly, bound thence to Newcastle, while running for Montrose Harbour, went ashore on the sands to the northward of the Annat Bank. The Montrose No. 2 Life-boat *Roman Governor of Caer Hün* immediately put off to her assistance through a very heavy surf, and, after a severe struggle, rescued her crew of five men. In the absence of the regular crew, this Life-boat was partly manned by eight young fishermen, who volunteered for the service, and who behaved admirably under very arduous circumstances.

On the following day the gale still continued, and as it was reported that several vessels were ashore along the coast, and that others were in danger, the

crews of the Life-boats assembled in readiness for service. At about 10 A.M. the brig *August*, of Barth, bound from Antwerp to Newcastle, in ballast, was seen to be gradually driving ashore. The Montrose No. 1 Life-boat *Mincing Lane* was accordingly sent to the mouth of the harbour, and the No. 2 Life-boat was despatched to the beach. The brig missed the harbour's mouth and went ashore about a quarter of a mile north of the Annat Bank. The No. 2 Life-boat was launched with the aid of the numerous spectators, who gallantly assisted in the work despite the waves, which again and again came upon them, completely drenching them, and placing them in some peril. No sooner was the Boat floated off than she was dashed back again, and it was only after the most strenuous efforts had been put forth that she succeeded in getting away, when she rowed towards the brig through a very heavy surf. Meanwhile the No. 1 Life-boat, seeing the danger of the brig, pulled across the Annat Bank in a very dangerous sea, and reached the vessel first, but was driven past her two or three times, although her veering line was fast to her. The No. 2 Boat then got nearer to the vessel, and, being a lighter boat, the veering line was transferred to her, and she got alongside the brig and rescued the crew, consisting of seven men, and safely landed them, amidst the cheers of the spectators. The brig's masts soon afterwards went overboard, and she broke up entirely within an hour or two.

The Life-boats had scarcely been hauled out of the surf after the performance of the last-named service, when the s.s. *Norma*, of Bergen, bound to that port from Newcastle with coal, was seen to be driving ashore, and she eventually stranded about a mile north of Montrose. She made signals of distress, in response to which the No. 2 Life-boat, which had been taken along the beach to the spot, the carriage being drawn by ten horses, was again smartly launched through the surf and pulled to the steamer, when she rescued eleven of her crew. Another seaman unfortunately fell into the sea while making his way along the rope to the Boat, and was drowned. The behaviour of the Life-boat on these occasions gave great satisfaction to the crews, and the coxswains stated that they felt sure

that the No. 2 Boat could be launched off their shallow beach under the heaviest sea, with sufficient assistance.—Expense of service, 49*l.* 10*s.* 6*d.*, in addition to local presentations of medals and pecuniary rewards.

March 5.—About 1 P.M., during a most violent storm, and amid blinding showers of snow, a schooner was observed being driven before the fury of the gale towards the West Sands in St. Andrew's Bay. The *Ladies' Own* Life-boat, stationed at St. Andrew's, at once proceeded to the rescue, and, amid the hearty cheers of thousands of spectators, brought safely ashore the crew of five men from the vessel, which proved to be the schooner *Harmonie*, of Mandal, Norway, with a cargo of pit props. While the Life-boat was alongside the wreck, one of her crew was washed overboard, but he was recovered after he had struggled some time with the heavy waves.—Expense of service, 11*l.*

March 5.—About midnight the coxswain of the *Covent Garden* Life-boat, stationed at Caister, received intelligence that a vessel was riding very near the shore at Scratby, and that she was making signals of distress. The Cockle Lightship soon afterwards began to fire guns and rockets. The Life-boat was then launched, and proceeded to Scratby, where she found the barque *Angostura*, of Hamburg, bound thence to Singapore with a general cargo, riding with one cable, the other having parted. The Life-boat's anchor was let go, and, with great difficulty, she was veered down to the ship, this taking nearly an hour to accomplish. Some of the crew then boarded her with much danger, as she was lying in the trough of the sea and was rolling heavily. Had she been half her length nearer the shore she must have been lost with all hands. The master accepted the proffered services of the Life-boatmen, and they were successful in taking the vessel into Yarmouth Roads. A steam-tug was afterwards engaged, and she was towed to Harwich. The barque carried a crew of fourteen men, and the master's wife and two fishermen were also on board.

March 7.—At about 10 A.M., a message from Boarhills reported that a vessel was in a dangerous position about four miles east of St. Andrews, N.B. The wind had fallen, but a very heavy sea was still

running. The *Ladies' Own* Life-boat at St. Andrew's was launched at the harbour's mouth, and proceeded in search of the vessel, the weather being very thick at the time. She returned about 2 p.m., bringing with her the crew of six men of the three-masted schooner *Grasshopper*, of Southampton, who were safely landed at St. Andrew's.—Expense of service, 10*l.*

March 8.—Shortly before 1 a.m., signals of distress were shown from the barque *Jupiter*, of Liverpool, bound from Hamburg to the Tyne in ballast, which was ashore on the Sand Rigg, Goswick, Northumberland. The *Grace Darling* Life-boat stationed at Holy Island went to her assistance through a very heavy sea, which filled the boat many times. When nearing the vessel the Boat was nearly capsized, but by careful use of the drogue succeeded in getting alongside, and she rescued the captain's wife and two children, and thirteen of the crew of the ship, all of whom were safely landed. Another flare was then shown from the vessel, and the Life-boat again went to her, and found that two men had been left on board, they being below when the Life-boat first arrived. They were taken into the Boat, and also brought ashore. The Life-boatmen were occupied seven hours in rendering these gallant services, having to pull a distance of six miles to reach the vessel, against a head wind, and in a very heavy broken sea. Attempts to save the barque's crew by means of the Rocket Apparatus had failed, and a large surf-boat, manned by fishermen, which tried to get to the ship from Goswick, was swamped, but fortunately the crew regained the shore.—Expense of service, 26*l.* 10*s.*

March 9.—At daylight the Coastguard on duty at Penarth, South Wales, observed a small vessel ashore in a very dangerous position on Cardiff sands. The wind was blowing strong from the W.S.W., accompanied by a heavy sea. The Penarth Life-boat *Joseph Denman* was launched and proceeded to the vessel, which was found to be the ketch *Bristol Packet*, of Newport, Mon. The crew asked that the Life-boat might remain by the vessel, the master stating that she was strongly built, and that they hoped when the flood tide made she would float off the sands, which she eventually did, and bore away for Newport, the Life-boat then returning to her station.—Expense of service, 9*l.* 17*s.* 6*d.*

March 18.—At 9 p.m., signals of distress were observed from a vessel on the North end of the Dogger Bank off the coast of Wexford. The Wexford *Civil Service* No. 1 Life-boat was immediately launched, and proceeded to render assistance. On arriving alongside the vessel, which was the schooner *Blue Jacket*, of Beaumaris, bound from Bangor to Wexford, with a cargo of slates, some of the Life-boatmen went on board, assisted to lighten her, and got her afloat at about 7.30 on the following morning. She carried a crew of three men.

April 2.—At about 11 a.m., on observing the brigantine *Danube*, of Guernsey, which was about to enter the Hartlepool East Harbour, hoist a flag of distress, the West Hartlepool No. 1 Life-boat *Rochdale* proceeded to her assistance. On reaching her it was found that she had taken the ground and was striking heavily. The Life-boat remained by her three hours, and the crew were on the point of leaving, having already put their clothes on board the boat, when three steam-tugs arrived, and, after considerable difficulty, they succeeded in getting the vessel afloat, and towed her safely into harbour.—Expense of service, 6*l.* 16*s.*

April 4.—At daybreak, during a strong gale from the E., with a chopping sea, a large steamer was observed, apparently at anchor, about eight miles N. of Towan Head, Cornwall. She was showing colours, but whether signals of distress or not could not be distinguished from the shore. The *Pendock Neale* Life-boat stationed at Newquay was, however, promptly despatched to the steamer, which proved to be the *Celeste*, of Hartlepool. The engines had been disabled by the breakage of the main shaft, and the Life-boat returned ashore, with a telegram to Cardiff asking for the assistance of a steam-tug.—Expense of service, 9*l.* 1*s.* 6*d.*

April 4.—In the evening, information was brought from the Coastguard Station at Ballywalter, co. Down, that the Bell Buoy, a vessel which is placed about two miles off the shore to warn vessels off the Stullmartin Reef, had broken adrift. As there was a strong wind at the time, with considerable sea, precluding the use of any ordinary boat, the Ballywalter Life-boat was launched, and with great difficulty got the craft into the harbour.

COMMITTEE MEETING, April 7th, 1881.

Voted 358*l.* 11*s.* 1*d.* to pay the expenses of the Life-boats at Harwich, West Hartlepool, Groomsport, Courtmacherry, Porthdinllaen, Queenstown, Torquay, Isle of Whithorn, Lowestoft, Pakefield, Broughty Ferry, Castletown, St. Andrews, Kingsdownie, Walmer, Newburgh, Anstruther, Berwick-on-Tweed, Montrose, Tynemouth, Salcombe, Hope Cove, Poole, Fishguard, and Cemlyn, in assembling their crews or putting off to the aid of vessels which did not ultimately need their assistance.

The Ramsgate, Caister, and Thurso Life-boats had also been taken out, but their services had not been required.

Voted the Silver Medal of the Institution, and a copy of the vote inscribed on vellum, to the Rev. J. O'REILLY BLACKWOOD, in acknowledgment of his general gallant services in the Ballywalter Life-boat, and particularly on the occasion of the rescue by that Life-boat of the crew of the ship *Castlemaine*, of Liverpool, which had stranded in Ballyhalbert Bay during a heavy gale from the S.E. on the 4th March.

April 12.—In the morning at low water, the barque *Marmora*, of Copenhagen, bound from Rochfort to Porthcawl, drifted on the Skerweather Sands off Porthcawl, South Wales. The Life-boat *Chafyn Grove* was immediately launched, and rescued the crew of eight men from the vessel, over which a heavy ground sea was dashing; she had been dismasted, and eventually became a total wreck. All hands must have been lost in the absence of the Life-boat.—Expense of service, 11*l.* 18*s.*

April 19.—At daybreak, the trawler *Shamrock*, of Hull, was observed ashore about a quarter of a mile N. of the Thedlethorpe Life-boat station, Lincolnshire, during stormy weather and a very heavy sea. The Life-boat *Dorinda and Barbara* put off to her assistance, but, owing to the wind and the unusually heavy sea, she was driven to leeward, and had to be beached. She, however, proceeded out again as soon as the tide served, and with great difficulty, owing to the floating wreckage and the heavy surf round the wreck, she succeeded in rescuing the crew, consisting of five men, from the rigging of their sunken vessel.—Expenses of service, 62*l.* 13*s.*

April 27.—At 4 A.M., the Life-boat *Bristol and Clifton*, stationed at Lossiemouth, N.B., put off, and rescued five men from the schooner *Cavalier*, of Lossiemouth, which had been driven ashore about fifty yards eastward of the old harbour. The wind was blowing from the S.W. at the time, accompanied by a heavy surf.—Expense of service, 8*l.* 8*s.*

May 3.—At 1 A.M., during a strong gale from the N.E. with a heavy sea, a vessel was observed on shore at Waxham, Norfolk, showing signals of distress. With all possible speed the Palling Life-boat *Parsee* was at once taken along the coast, and, on arriving opposite the stranded vessel, she was launched through the heavy surf with much difficulty, and, after battling with the waves, succeeded in reaching the vessel and rescued her crew of five men. She proved to be the fishing smack *Catherine*, of Ramsgate.—Expense of service, 22*l.* 19*s.*

May 3.—Signal guns from the Gull and Goodwin Lightships were heard at 10.30 A.M. on the 3rd May, and a schooner was seen to run ashore on the North Sand Head. The wind at the time was blowing from the N. The Ramsgate Life-boat *Bradford* and harbour steam-tug *Aid* were immediately manned and proceeded to the vessel; but, before getting to her, both her masts were seen to fall over the side. On arriving to windward the Life-boat was slipped from the steamer and sailed to the vessel. Some of the Life-boatmen went on board, and at once set to work to extricate her from her perilous position. She was thumping heavily and was full of water, but her cargo of deals prevented her from sinking. The starboard anchor was let go, to prevent her from driving farther on the sands; and the steamer was signalled to and backed in under her stern. The tug's large towing hawser was then hauled on board and made fast, and she towed in a N.E. direction for about an hour. The schooner continued to strike heavily on the sand, but she ultimately floated, and was towed into Ramsgate Harbour in a waterlogged condition. She was the *Aldebaran*, of Laurvig, 111 tons, bound from Porsgrund to Abbeville. She had a crew of five men.

COMMITTEE MEETING, May 5th, 1881.

Voted 76*l.* 9*s.* 7*d.* to pay the expenses of the Harwich, Clacton-on-Sea, Cruden, Seaham, New Romney, Portmadoc, and Donna Nook Life-boats in putting off to vessels which had shown signals of distress, but which did not ultimately require any assistance.

The Ramsgate Life-boat had also been taken out, but her services had not been required.

May 18.—At 4.20 A.M., during a strong breeze from the W.S.W., a screw-steamer was seen ashore on the North Sand Head, Goodwin Sands, with signals of distress flying; and about the same time signal guns were fired from the Gull Lightship. The Ramsgate Life-boat *Bradford* and harbour steam-tug *Vulcan* at once proceeded to her assistance, and the North Deal Life-boat *Mary Somerville* was also despatched to the spot. It being necessary to lighten the vessel, both Life-boats' crews commenced to throw overboard the cargo, consisting of boxes of oranges. This was continued for three hours, when the sand alongside dried, and the kedge anchor and hawser were then taken from her port bow and run out on the sand a distance of eighty fathoms, and the bower anchor and cable were run out for about sixty fathoms. Directly these operations were accomplished all hands went to work again, and threw overboard more boxes of oranges for about two hours, until she was nearly afloat, when sail was set to endeavour to force her over the sand, and at the same time the chain and hawser were hove taut. Eventually she floated, and was proceeding round the South Sand Head when her engines stopped, owing to a rope having fouled the propeller. She was then taken in tow by the steam-tug, steering towards the North Foreland. In about half an hour the propeller was cleared, and she was then able to proceed under her own steam to Margate Roads. She was the s.s. *Gervase*, of London, 417 tons, bound from Valencia to the Thames, and carried a crew of nineteen men.

May 23.—This morning, H.M.S. *Lively*, with the DUKE and DUCHESS of EDINBURGH and suite on board, arrived off Sidmouth, and came into the bay, in order that his Royal Highness might land and inspect the Coastguard Station. Shortly

after nine o'clock a steam pinnace was lowered from the *Lively*, and the DUKE and DUCHESS, Lady HARRIET GRIMSTON, and Mr. H. H. RICKARD, R.N., proceeded in it towards the shore. An increasing swell was rolling in from the S.E. at the time, and as the steam-launch neared the land she was struck by a sea, which nearly capsized her. The Sidmouth Life-boat *Rimington*, which had been got out in readiness for inspection by his Royal Highness, was at once launched and proceeded alongside, when the DUKE and DUCHESS and their party were taken into the Life-boat and safely landed, the boat only shipping a little spray as she grounded on the beach. There is no doubt that considerable risk would have attended any attempt to land from the launch, as this beach is rather a dangerous one, when there is any sea on, on account of its steepness.—Expense of service, 8*l.* 10*s.*

May 24.—Early this morning the Cadgwith Life-boat *Joseph Armstrong* and the Lizard Life-boat *Anna Maria* were launched and proceeded, under sail and oars, to the assistance of the schooner *Ellen Vair*, which had been damaged by collision and deserted. On getting near her, a Brixham trawler was found to be close by, having put two men on board. Four of the Cadgwith Life-boatmen were also put on board, who, with the trawler's men, navigated her to Penzance.

COMMITTEE MEETING, June 2nd, 1881.

Voted 21*l.* to pay the expenses of the *Broadstairs* and *Lizard* Life-boats in putting off to the aid of vessels not ultimately requiring their assistance.

The Ramsgate and Porthleven Life-boats had also been taken out, but their services were not eventually needed.

June 5.—At 4 A.M. the barque *Alecto*, of Malta, bound from Cyprus to Aberdeen with locust beans, stranded on the Cross Sand, off the coast of Norfolk, during a fresh wind from S.W. A yawl immediately proceeded to her, and remained alongside until the ebb tide, when the sea became very heavy, and as the yawl shipped a great deal of water she was forced to leave. A steam-tug was then sent to Caister for the surf Life-boat, the *Godsend*, which was launched, sailed to the barque, followed by a large yawl,

and remained by her until she came off and was towed into Yarmouth roads.

June 10.—The s.s. *Norman*, of London, bound from Dantzic to Stockton with grain, went ashore about a mile and a half N. of Seaham Harbour during a N. wind and high sea. The Life-boat *Sisters Carter of Harrogate*, stationed at Seaham, proceeded to her assistance, and brought safely ashore nine of the crew, the master's wife, and a lady passenger.—Expense of service, 12*l.* 8*s.*

June 11.—The *Hannah Somerset* Life-boat at Staithes, Yorkshire, was launched on the 11th June, and rendered great assistance to some fishing cobles which were in danger in a very heavy sea.

COMMITTEE MEETING, July 7th, 1881.

Voted 13*l.* 8*s.* 3*d.* to pay the expenses of the Life-boat at Rye, Sussex, in putting off to the aid of a vessel which did not eventually require her assistance.

July 24.—At 1.45 P.M., during a strong W. gale and heavy sea, a pleasure boat with four men in her was observed from Howth, co. Dublin, to be drifting seaward. The Life-boat *Clara Baker*, stationed at Howth, proceeded to the boat, and brought her safely ashore, she having been partly disabled, and the men in her being entirely exhausted.—Expense of service, 7*l.* 15*s.*

COMMITTEE MEETING, Aug. 4th, 1881.

Voted 9*l.* to pay the expenses of the Life-boat at Broadstairs in putting off to the Norwegian barque *Christine*, which had stranded on the Goodwin Sands.

Aug. 13.—The schooner *William* of Liverpool, bound from Liverpool to Foryd, arrived off Rhyl, North Wales, in the evening, but was unable to get into the Foryd during that tide, and grounded on the east bank. At low water five men went on board to assist to get the vessel up the river with the following tide, but, owing to the gale and the heavy sea, she was compelled to ride at anchor. By about one hour's ebb, having dragged her anchor, she was in a dangerous position, tossing and rolling fearfully. At about 2 P.M. on the 13th the Rhyl No. 2 Life-boat *Jane Dalton* proceeded to her assistance, and brought ashore the five men and one of the crew. The master

and mate remained on board the vessel, which afterwards grounded.—Expense of service, 12*l.* 3*s.* 6*d.*

Aug. 25.—In the morning during a S.S.W. gale and heavy sea, the barque *Strathden*, of Dundee, was seen to go ashore on the north-west end of the Middle Cross Sand off the Norfolk Coast. A yawl immediately proceeded to her assistance, and the master engaged the service of her crew to try to save the vessel. They laid out an anchor and warp, and were returning to the barque, when a heavy sea broke on board the yawl, filling her above the ballast. Signals were then made for the Caister Life-boat, in response to which the *Covent Garden* Life-boat proceeded to the barque and remained by her. In the meantime two steam-tugs had been engaged, and towed during the flood tide, but they were unable to move the vessel. The men on board, assisted by the crew, threw overboard some of the cargo of coal, but the wind and sea increasing, the vessel fell over to windward at about an hour and a half before low water. The Life-boat then, with considerable difficulty and risk, took the men off her, the boat striking heavily on the ground all the time, and shipping a great quantity of water. The barque was bound from Leith to Buenos Ayres, and carried a crew of twelve men.—Expense of service, 15*l.*

Aug. 25.—The brigantine *Lina*, of Aland, Russia, was driven ashore about half a mile east of the Life-boat House at Rye, Sussex, during a very strong S.W. gale, accompanied by a high sea and heavy rain. The Rye Life-boat *Arthur Frederick* was launched, proceeded to the vessel, and brought safely ashore the crew, consisting of eight men.—Expense of service, 24*l.* 14*s.*

Aug. 25.—One of the most severe storms ever experienced at this season of the year prevailed at Fraserburgh, N.B. A report had been circulated among the fishermen on the previous day that a storm was at hand, and on that day only about one-fourth of the fishing-boats proceeded to sea. On the 25th, the weather having been fine in the forenoon and afternoon, the whole fleet, numbering eight hundred and sixty boats, went out. Towards night rain began to fall, and by 9 o'clock there was every appearance of a gale. All through the night the boats were returning to the

harbour, and by daylight between four hundred and five hundred of them had arrived. The wind having veered round from S.E. to N.E., and the violence of the gale increasing, the work of reaching the harbour was rendered exceedingly difficult. To meet any emergency which might occur, the Life-boat *Cosmo and Charles*, stationed at Fraserburgh, was launched at 7 o'clock on the following morning and acted as a guide to the boats which were running for the harbour. From early morning until late at night the piers were crowded, and the excitement was most intense. One boat was wrecked on the rocks to the south of Fraserburgh, but her crew were saved. Many of the boats which reached the harbour lost the whole of their nets, valued for each boat at from 100*l.* to 150*l.*

Some idea of the strength of the gale may be gathered from the fact that the waves dashing over Balaclava Pier were so heavy as to carry away the travelling crane belonging to the Harbour Commissioners, which, with its engine and ballast, weighed about fifty tons.—Expense of service, 7*l.* 6*s.* 6*d.*

Aug. 25.—The brigantine *Bertha*, of Rye, stranded in Pakefield Gat, off the Suffolk coast, during a S.W. wind and heavy sea. In reply to her signal of distress, the Life-boat *Two Sisters Mary and Hannah*, stationed at Pakefield, was launched and proceeded to her, in tow of the Lowestoft steam-tug. On arriving alongside it was found that the vessel was full of water, and her crew, consisting of six men, were thereupon taken into the Life-boat and brought safely ashore.—Expense of service, 14*l.* 17*s.* 6*d.*

Aug. 26.—At about 9 o'clock in the morning, during a strong E. gale and heavy sea, a fishing-boat came into Cruden Bay, Aberdeenshire, but, being unable to make the harbour, the Life-boat *Peep o' Day* went to her assistance, and towed her safely in, the crew being quite exhausted. During the day seven other boats were in like manner taken into the harbour.—Expense of service, 10*l.* 16*s.*

Aug. 29.—The Life-boat *Oxfordshire*, stationed at Looe, Cornwall, was launched, and rescued one of the crew of the ketch *Lion*, of Exeter, which had sprung a leak and had capsized about five miles S.E. of Looe, during a strong S.S.W. wind. The other man of the crew was saved by a

Looe coastguard boat, which also put off to the vessel.—Expense of service, 7*l.* 12*s.*

Aug. 30.—At about 4 A.M., while the wind was blowing strongly from the N.E., accompanied by a heavy sea, the schooner *Zipporah*, of Scarborough, which had been delivering coal at Runswick, Yorkshire, and had anchored in the bay, commenced to drag her anchors, and hoisted a signal of distress. The Runswick Life-boat *Margaret and Edward*, thereupon proceeded to her, took off her crew of two men, and brought them safely to land. The vessel shortly afterwards drove on shore and became a total wreck. Before proceeding ashore with the two men, the Life-boat went to a fishing coble which was dragging her anchor, and towed her into a safe position.—Expense of service, 8*l.* 7*s.* 6*d.*

COMMITTEE MEETING, Sept. 1st, 1881.

Voted 13*l.* 16*s.* to pay the expenses of the Life-boats at Barmouth, Winterton, Rye, New Brighton, Wexford, Montrose, Kessingland, Winchelsea, Banff, and Caister, in assembling their crews or putting off to the assistance of vessels which did not ultimately need their aid.

The Ramsgate and Eyemouth Life-boats had also been taken out, but their services were not eventually needed.

Sept. 5.—Soon after daylight it was reported that a vessel was at anchor in Penzance Bay with a signal of distress flying. A strong gale was blowing from S.E. to S.S.E. The Penzance Life-boat *Richard Lewis* proceeded to her assistance, and on reaching her found her to be the barquentine *Neilly*, of Bridgewater, bound from Lydney with 333 tons of coal for Porthleven, and having a crew of six men on board. She was riding very heavily with both anchors down and chains veered out to their full extent, and it was feared that she would part her chains and drive ashore, being quite to leeward. The Life-boatmen's services were at once engaged to get her into harbour; while making the necessary preparations one chain cable parted and sail was then at once got on the vessel, the second anchor and chain were slipped, and she was taken safely in, arriving off the pier at about 10.30 A.M.

Sept. 23.—Shortly before 4 o'clock in

the morning, while a gale from the S.S.E. was blowing, accompanied by a very heavy sea, the brigantine *John Wesley*, of Seaham, bound from Seaham to London with a cargo of coal, struck the ground on the Beacon Rocks off Hartlepool, and carried her sternpost away. She then drifted on to Middleton Beach, and burned flare-up lights. The Hartlepool No. 3 Life-boat *John Clay Barlow* at once proceeded to her and took off all the crew, five in number. The vessel was full of water, and had sunk by the time the Life-boat reached her. The master of the vessel had previously lowered his jolly-boat, but it was immediately swamped.—Expense of service, 13*l*.

Sept. 30.—At 2 A.M. signals of distress were observed in Dunderum Bay, about a mile S.S.W. of the Craigalea Rocks. The wind was blowing from the S., the weather was thick and hazy, and there was a heavy ground swell. The *Memorial* Life-boat, stationed at Tyrella, co. Down, proceeded to the vessel, which proved to be the barque *Gertrude*, of Liverpool, bound from Quebec to Belfast with timber, and brought ashore thirteen of the crew.—Expense of service, 17*l*. 5*s*.

Oct. 2.—Shortly before 5 o'clock in the morning, the screw collier *Ludworth*, of London, bound from Hartlepool to London, having sprung a leak, ran aground on Hasborough beach, Norfolk, during a fresh gale from the E. by S. and a heavy sea. After an ineffectual attempt to reach the vessel by means of the Rocket Apparatus, the Life-boat *Huddersfield*, stationed at Hasborough, put off and succeeded in safely landing eight of the crew. The remainder of the crew effected their escape in the ship's starboard Life-boat.—Expense of service, 17*l*. 7*s*. 6*d*.

Oct. 5.—At 11 o'clock in the morning the fishing-smack *Triton*, of Yarmouth, stranded on the Barber Sand, off the Norfolk coast. The weather at the time was squally, and there was a heavy sea on the beach and sands. The vessel was seen to lower a boat, which was knocked to pieces as soon as it was in the water, whereupon the Caister No. 2 Life-boat *Godsend* proceeded to the vessel, and having got hold of her trawl warp took it to a steam-tug, the sea breaking over the boat all the time. When the flood-tide made, the steamer towed the smack off, and took her and her

crew of six men safely into Yarmouth Harbour.

Oct. 8.—A little before midnight on the 7th October signals were observed and a steam-whistle was heard in Appledore Bay, Devon, but for some time the signals ceased. About 2 o'clock on the following morning they were resumed, and the gun at Braunton Lighthouse was repeatedly fired. The wind was blowing fresh from the N.N.W., the weather was hazy, and there was a heavy ground sea. In reply to the signals the Appledore No. 1 Life-boat *Hope* was launched, proceeded in search of the vessel, and found her ashore on Saunton Sands. She proved to be the s.s. *Ranee*, of Bristol, bound from Torquay to Newport, in ballast. The Life-boat took off the engineer, his wife, two children, and a Newport pilot, and landed them at Appledore. The master and eleven men refused to leave the vessel.—Expense of service, 21*l*. 4*s*.

COMMITTEE MEETING, Oct. 6th, 1881.

Voted 127*l*. 4*s*. 6*d*. to pay the expenses of the Dungarvan, Broadstairs, Deal, Clacton-on-Sea, Cadgwith, Walmer, Scarborough, Peterhead, West Hartlepool No. 1, Palling No. 1, and Hythe Life-boats in assembling their crews or putting off in reply to signals of distress shown by vessels which did not ultimately need the aid of the Life-boats.

The Ramsgate and Lizard Life-boats had also been taken out, but their services had not eventually been required.

Oct. 14.—During a heavy gale from the W., at 9 A.M. signals of distress were reported at Holyhead to have been shown by two or three vessels anchored in dangerous positions in the bay. The Life-boat *Thomas Fielden* was launched, but the wind was so strong that she had to anchor and wait until a tug came to her. The tug tried for about an hour to put the boat alongside a schooner, but could not succeed, and eventually she had to drop down to the vessel under oars, and rescued the crew, consisting of four men. The vessel was the schooner *Golden Island*, from Belfast to Newport.—Expense of service, 15*l*. 4*s*.

Oct. 14.—The coxswain of the Burnham, Somersetshire, Life-boat saw the smack *Neath Trader*, of Newport, Mon.,

ashore off Burnham during a heavy gale from the W.N.W. at about 10 o'clock A.M. The vessel was full of water, and there were three men on the rigging signalling for assistance. The Life-boat *Cheltenham* was manned and put off to the vessel, took the crew from the rigging and brought them safely ashore. One of the rescued men was in a very exhausted condition, and two of the Life-boatmen had to go up the rigging to assist him to the Boat. The smack was bound from Newport to Highbridge with a cargo of coal.—Expense of service, 8*l.* 18*s.* 6*d.*

Oct. 14.—The Coastguard officer at Ballywalter, co. Down, gave information that a fishing-boat was in danger outside of Long Rock, and as the wind had increased to a perfect hurricane, and had veered round to the N.W. and North, the Life-boat *Admiral Henry Meynell* proceeded to her assistance, and brought her crew of two men ashore. Great difficulty was experienced in rendering this service; for a long time the Life-boatmen were unable to contend with the wind, and the Boat had to lie at anchor. Such a hurricane had not been known on this shore for many years.—Expense of service, 12*l.* 8*s.*

Oct. 14.—At 11 A.M. a messenger arrived on horseback at Moelfre, Anglesey, from Red Wharf, a distance of about four miles, stating that a fishing-boat, with three men on board, was caught in a violent storm, and that the men were in the utmost peril of losing their lives. The Moelfre Life-boat *Lady Vivian* was instantly launched, and reached the vessel just in time to save the men from a watery grave.—Expense of service, 7*l.* 12*s.*

Oct. 14.—At 11 A.M. it was reported at Torquay that the fishing smack *Black Cat*, of Paignton, was hanging on to her nets, in great danger, off that place, having been in that position since the commencement of the gale, which was then raging from the N. to N.W., and which was still increasing. The crew of the Torquay Life-boat, *Mary Brundret*, assembled, and the Life-boat proceeded to the smack, which she reached about 11.30, and found that her crew, consisting of two men, had been seventeen hours in their perilous position. Having cut adrift the nets and gear, the smack was towed into Brixham Harbour, and the men landed.

In returning from Brixham, the fury of

the gale appeared to be at its height, and the Life-boat was caught by a heavy squall when in the middle of the bay, and capsized; she immediately righted herself, and all the men were fortunately able to get on board, and returned to the Station in safety.—Expense of service, 17*l.* 8*s.*

Oct. 14.—About noon the schooner *Eulala*, of Dumfries, was seen to exhibit signals of distress while riding heavily in Ramsey Bay, Isle of Man. She had parted one anchor, and was drifting rapidly towards the rocks. The Ramsey Life-boat was immediately launched and proceeded to her. With considerable difficulty, and after sustaining serious damage, she succeeded in rescuing the vessel's crew of four men, but in consequence of her damaged condition she had to be beached some miles from her Station. The gale was blowing with terrific force, and there was a tremendous sea running. The Life-boatmen state that they never were out in worse weather.—Expense of service, 16*l.* 9*s.*

Oct. 14.—During a very heavy gale from the W.N.W., at about midday, a signal of distress was shown by the screw flat *Tal y fan*, of Liverpool, anchored in Porthdinllaen Bay, North Wales. The Life-boat *George Moore* went off to her and succeeded in taking off the crew, consisting of four men.—Expense of service, 7*l.* 18*s.* 6*d.*

Oct. 14.—At about 12.30 A.M. signals of distress were observed at Pembrey, Carmarthenshire, from the s.s. *Laura Fell*, of London. The wind was blowing a whole gale from the S.W., with thick rain and a very heavy sea. The signals were answered by the Coastguard, and the Pembrey Life-boat *Stanton Meyrick of Pimlico*, put off to the vessel, which was found to have stranded on the Middle Spit, and brought safely ashore her crew of seven men. At 5 o'clock the Life-boat again went out with a steam-tug, and, after much risk and hard work, brought the vessel, which was leaking very badly, into Llanelly.—Expense of service, 17*l.*

Oct. 14.—The Life-boat *Joseph Denman*, stationed at Penarth, Glamorgan-shire, put off to the aid of the barque *Febo*, of Genoa, which had exhibited signals of distress, having lost her fore and mainmasts, and having parted from

three chain cables. A steam-tug took the vessel in tow, and part of the Life-boat crew went on board the barque and helped to rig a jury mast on which sail might be set to ease the tow-ropes. The Life-boatmen also assisted to cut away the wreckage alongside, and the vessel was taken into dock. She carried a crew of fourteen men.

Oct. 14.—At 1 p.m. the brig *Maria*, of and from Hartlepool, bound to London with coal, having struck on Covehitheness Point, off the coast of Suffolk, and being in a sinking condition, made signals of distress, and ran on shore on the beach, four hundred yards south of Kessingland, Suffolk, where she became a total wreck. Her crew, consisting of six men, left in their own boat, and were drifting on the Newcome Sand, when they were rescued by the Kessingland No. 1 Life-boat, the *Bolton*.—Expense of service, 12*l.* 14*s.*

Oct. 14.—The schooner *Equity*, of Boston, bound from Newcastle to London, with firebricks and soda, signalled for assistance while off Aldborough, Suffolk, at 1 p.m., during a heavy gale and rough sea, and a beach yawl thereupon went to her aid. At 4 o'clock another signal was made, and the Life-boat *George Hounsfeld* proceeded to her, and remained by her during the night. At daylight on the following morning the Life-boat accompanied the schooner to Harwich. The vessel had a crew of seven men.

Oct. 14.—Signals of distress were seen flying from a ketch three miles N.E. of Winterton, Norfolk, during a severe storm and a very heavy sea, at about 2.30 p.m. The Winterton No. 2 Life-boat, the *Husband*, proceeded to the vessel, and found her to be the *Time*, of Goole, bound from London to Newcastle with wheat. The Life-boat took off the crew of four men, and brought them safely ashore. The vessel, which was leaking, and had lost her anchor, ultimately foundered.—Expense of service, 19*l.* 10*s.*

Oct. 14.—At 3 p.m., during stormy weather, the schooner *Breton*, of Fowey, was observed to be showing a signal of distress off Portmadoc, Carnarvonshire. The Life-boat *John Ashbury* was immediately manned, and by the time she was afloat the vessel had been beached at Criccieth. The Life-boat went alongside, and brought

her crew of five men ashore. The schooner had parted from her cable in St. Tudwall's Roads, and had lost her bowsprit and jibboom.—Expense of service, 8*l.*

Oct. 14.—At about 5 p.m., during a very heavy gale of wind, the Gull Lightship fired signals of distress, in response to which the Deal Life-boat *Mary Somerville* proceeded to the Goodwin Sands. The Ramsgate Life-boat *Bradford*, in tow of the harbour steam-tug *Vulcan*, also put off in reply to the signals. On arriving at the sands the ship *Ganges*, of London, was found ashore there, the sea breaking over her. The Life-boats remained near the vessel for some time, and eventually, as there was a probability that she would break up, the master and crew decided to abandon her. Fifteen men were therefore taken into the Ramsgate Life-boat, the remaining seventeen men were taken into the Deal Life-boat, and all were brought safely to land, arriving soon after 3 o'clock on the following morning.—Expense of Deal Life-boat service, 25*l.* 12*s.* 6*d.*

Oct. 14.—At about 5 p.m. the s.s. *Northumberland*, of Newcastle, ran into the bay at Newbiggin, Northumberland, for shelter during a very severe storm and very high sea. In reply to signals of distress shown by her, the Life-boat *William Hopkinson of Brighthouse* put off, placed two men on board, and brought her to an anchorage. As her anchor was not likely to hold, a kedge was run out, and the crew of four men were taken ashore for safety. The vessel fortunately rode out the storm, and her crew took her to the Tyne on the following morning, the weather having moderated. She was bound from Leith to Middlesbrough with iron railway plates.

Oct. 14.—At about 7 p.m. the *City of Worcester* Life-boat, stationed at Bembridge, Isle of Wight, put off to the assistance of the Norwegian brigantine *Skjold*, which had lost her masts and was drifting during a W. gale. A steam-tug had arrived at the vessel about half an hour before the Life-boat, and was taking her in tow for Cowes; the Life-boat therefore assisted in that work.—Expense of service, 5*l.* 5*s.*

Oct. 14.—The Clacton-on-Sea Life-boat *Albert Edward* put off at about 7.30 p.m., in reply to signals of distress, during a very strong N.W. wind and very rough sea. After cruising about for some

time the schooner *Ocean*, of Goole, was sighted ashore on the Maplin Sands; her sails were all adrift; she had lost two anchors and chains, and had five feet of water in her hold. Some of the Life-boat men boarded her, helped the crew of four men to pump the water out, and with the aid of a steam-tug she was brought to London on the following morning, the Life-boat accompanying her.

Oct. 14.—The *Albert Edward* Life-boat at Padstow, Cornwall, put off during a strong gale from the N.W., and a very heavy sea, and with great difficulty rescued the crew, consisting of four men, from the schooner *Favorite*, of Quimper, which had lost her sails and had stranded on the middle of the Doom bar. The weather afterwards moderated, and on the next tide the vessel beat over the sand.—Expense of service, 6*l.* 16*s.*

Oct. 14.—During a heavy gale from the S.W. and a rough sea, the *Boys of England* Life-boat stationed at Southend, Essex, rescued the crews, consisting of four men in all, from the distressed barges *Butcher* and *Maria*, of Rochester. The barges were bound from Leigh to London with straw. The Life-boat afterwards rendered some assistance in towing the barge *Violet*, which had been aground on the Maplin Sands, and had been abandoned by her crew.—Expense of service, 14*l.* 1*s.*

Oct. 14.—The schooner *William*, of Dublin, bound from Swansea to Ardrossan with a cargo of coal, and having a crew of five men, sought shelter in Skerries Bay, co. Dublin, from stress of weather, the wind at the time blowing a whole gale from the N.W. The weather having moderated, three of the crew came ashore; but the wind afterwards increased, and the vessel then made for the harbour, but was blown beyond the point of shelter and stranded. The sea was washing over her, and the two men on board her being in great peril a rocket was fired over her, and the line placed on board; but the men were unacquainted with its use, and the *Laura Platt* Life-boat, stationed at Skerries, therefore proceeded to the schooner, and brought the two men safely ashore.—Expense of service, 7*l.* 12*s.* 6*d.*

Oct. 14.—The barque *Margaret*, of Belfast, was endeavouring to enter that port during a very strong gale from the N.N.W. and a very heavy sea at about

12.30 P.M. on the 14th October. She was taken in tow by a steam-tug, but the hawser broke, and the vessel was run into Bangor Bay, where she struck on the sand. The *Florence* Life-boat, stationed at Groomsport, was taken by land to Bangor, where she was launched, and proceeded to the vessel and succeeded in bringing safely ashore the crew of fifteen men. The barque was bound from Quebec to Belfast with a cargo of timber.—Expense of service, 13*l.* 5*s.*

Oct. 15.—At 8 o'clock in the morning, signals of distress were shown from the Norwegian brigantine *Julische*, which had stranded on the Goodwin Sands, and become water-logged. The Kingsdowne Life-boat put off to her assistance, but about twenty minutes before the Life-boat arrived at the wreck, a vessel was seen to lower her boats and take the crew off. The Life-boat remained by the wreck, and, with the assistance of a lugger and a steam-tug, took her into Dover Harbour.

Oct. 15.—While the wind was blowing very hard from the N.N.E., a telegram was received from the chief officer of Coast-guard at Port Gordon, about two miles to the westward of Buckie, N.B., stating that a vessel, flying signals of distress, was drifting ashore there. The Buckie Life-boat *James Sturm* was at once despatched to the spot by land, and on arriving there was successfully launched through a heavy surf and head wind, and was instrumental in saving the crew of four men from the vessel, which proved to be the ketch *Equestrian*, of Banff, bound from Dingwall to Leven. She had shipped a sea off Lossiemouth, her ballast had shifted, her sails had been blown away, and she was on her beam ends.—Expense of service, 8*l.* 15*s.*

Oct. 19.—A ketch was seen in the offing at Padstow, Cornwall, during a strong gale from the S.E., at about 11 A.M. on the 19th October, trying to make the harbour. She had lost her sails and was otherwise disabled. She let go her anchors about a mile below Stepper Point, in a perilous position. At about 7 P.M. it was considered advisable that the Life-boat should proceed to her; the *Albert Edward* was accordingly launched, and after an hour and a half's pull succeeded in reaching her, and brought her crew of three men safely

ashore. She proved to be the ketch *Two Brothers*, of Bridgwater, from Newport to Boscastle, with coal.—Expense of service, 13*l.* 6*s.*

Oct. 19.—The *Christopher Ludlow* Life-boat, stationed at Dungarvan, Ireland, put off in reply to signals of distress shown by the schooner *Dorothy and Mary*, of Newcastle, which was labouring heavily on the bar during a strong E.S.E. gale. With great difficulty the vessel was got off the bar and taken to a place of safety. She was bound from Newcastle to Youghal, with coal, and carried a crew of four men.—Expense of service, 4*l.* 2*s.*

Oct. 20.—During a severe gale the barque *Lebu*, of Liverpool, at anchor about five miles from Douglas Head, hoisted signals of distress, in response to which the Douglas No. 2 Life-boat, the *John Turner Turner*, was at once launched. After some time she was approaching the vessel, when the signal was lowered, and the Boat returned to the harbour, where she grounded. Soon afterwards the distress signal was again hoisted, and the No. 1 Life-boat, the *Manchester and Salford Sunday Schools*, was thereupon launched. After remaining some time by the barque, those on board, numbering fourteen men and two women, were taken into the Boat, which then proceeded towards the harbour.

As she did not make much progress under oars, the men being hampered by the numbers in her, she was put under her foresail, which was double-reefed, and the drogue was used; but thinking that it kept the Boat back too much, it was taken in, and the Life-boat was allowed to run before the sea. They were within a mile of Douglas when a very heavy sea overtook them, raised the stern of the Boat, and buried her port bow, causing her to broach to and capsize, when all on board were thrown into the water. She speedily righted, and nine of her crew, seven sailors, and the two women, regained her; but before the oars could be got out she drifted some distance in the darkness, and could not be pulled to windward to the assistance of the others, who were unfortunately drowned, viz., four Life-boatmen, the master, and six of the crew of the barque.

Voted the sum of 400*l.* in aid of the local subscription for the relief of the widows and families of the drowned Life-boatmen, in addition to an extra reward,

amounting altogether to 32*l.* 5*s.*, to the crew of the Boat.

It will be seen that the real cause of this unfortunate accident arose from the Life-boat being struck by a heavy broken sea on her starboard quarter when running before the wind and sea, which forced her lee bow under water, the Boat being heavily laden at the time, on a dark night, when the approach of the waves could not be seen until almost the moment of impact, a combination of causes amply sufficient to account for the disaster. Unfortunately this Life-boat is much the smaller of the two stationed at Douglas, and, undoubtedly, if the master of the *Lebu* had not hauled down his signal of distress, on seeing the first and larger Life-boat on her way in reply to the same, he and his crew would have been safely landed in her before night set in.

Oct. 20.—The barque *Iron Crown*, of Liverpool, while entering Tynemouth, Northumberland, about midnight, in a tremendous gale from E.S.E. to E. and a very high sea, became unmanageable near the pier ends, and, after narrowly escaping collision with the advanced staging of the south pier, she was driven over to the north and struck the ground outside Tynemouth Haven. Her anchor had been let go before striking. Rockets were fired from the pier, by which four of the crew were with much difficulty landed. In the meantime the *Charles Dibdin* Life-boat was launched, and although she was driven back three times by the seas, she at length reached the vessel and brought ashore seventeen persons, including the captain's wife. It was afterwards discovered that one of the crew had been left on board, and the Life-boat therefore went off again to the vessel, and brought him ashore.—Expense of services, 35*l.* 3*s.* 6*d.*

Oct. 21.—During a strong E. wind, with a heavy sea, a vessel was seen to drive on the beach at Eccles, Norfolk. The No. 1 Life-boat, stationed at Palling, was promptly taken to the scene of the wreck, and succeeded in rescuing the master, the crew having been previously landed by the rocket apparatus. The vessel proved to be the Swedish barquette *Maria*, of Gothenburg, from Hernosand to Trouville, with a cargo of deals.—Expense of service, 25*l.* 5*s.*

Oct. 22.—At about 5 p.m. on the 21st October, the barque *Gustava*, of Laurvig, Norway, bound from Cardiff to the Baltic via Cork, with coal, was seen standing in for Ballycotton Sound, co. Cork. A pilot went off to her in a whale-boat, guided her through the Sound, and brought her to an anchor. The master and crew remained on board, but the wind and sea increasing, they showed signals of distress, in reply to which the Ballycotton Life-boat *Oliver Goldsmith* put off to her at about seven o'clock on the following morning, and brought her crew of eleven men ashore.—Expense of service, 9*l.* 6*s.*

Oct. 22.—The *Clara Baker* Life-boat stationed at Howth, co. Dublin, with much difficulty rescued the crew, numbering sixteen men, of the ship *George H. Oulton*, of St. John, N.B., which had stranded near Sutton during a whole gale from the E.S.E. and a heavy sea.—Expense of service, 26*l.* 12*s.*

Oct. 22.—The schooner *Florence*, of Belfast, bound to that port from Cardiff with coal, was seen to be running for Dundrum Bay, apparently in distress, during a strong E.S.E. gale and a heavy sea, at about 7.30 A.M. on the 22nd October. The *Farney* Life-boat stationed at Newcastle, co. Down, proceeded to her assistance, and rescued the crew, consisting of five men. The vessel had been entirely disabled through loss of sails.—Expense of service, 14*l.* 6*s.*

Oct. 23.—A flash light was observed from a vessel ashore on the Knock Sands off the Lincolnshire coast. The *Herbert Ingram* Life-boat at Skegness was launched as soon as possible, the wind blowing a strong gale from the S.S.E. at the time, accompanied by a very heavy sea. The Life-boat filled three times, two of her oars were broken, and she was driven ashore about two miles south of her station. She was again got on her carriage, and was taken by land abreast of the vessel and again launched, three extra men double-manning the central oars, and succeeded in bringing safely ashore the shipwrecked crew, consisting of ten men. The vessel proved to be the barque *Lom*, of Hudiksvall, Sweden, bound thence to Bilbao, with deals and boards.—Expense of service, 26*l.* 18*s.*

Oct. 23.—At half-past four in the morning, a coastguardman, on the look-

out near Clacton, saw a signal rocket fired from the Gunfleet Floating Lightship, which told of a wreck on the Gunfleet Sand and asked for a Life-boat's aid. He at once ran for the Clacton Life-boat *Albert Edward*, and the crew were got together, and the boat was run down to the beach. The wind and tide were both dead against the boat, which had only oars and sail to propel it, but a steamer was sighted, which proved to be the *Consett*, of Sunderland, whose captain kindly towed them as close to the Sands as he could with safety to his own ship, when he let them go, and they took to their oars. When within about twenty yards of the wreck, on the weather side, they dropped anchor; but a huge roller coming, lifted the wreck, and carried it further on to the sand. They were obliged, therefore, to pay out more cable, and were just successful in making connection by a line with the wreck when another roller lifted it and carried it quite out of reach. They had paid out all their cable, and it was therefore a question whether they should abandon the wreck or voluntarily encounter one of the greatest dangers to which a Life-boat is liable—viz. that of destruction by boarding on the windward side, and the crew unanimously, and with a ready courage which is beyond all praise, determined to risk this, in order to attempt the rescue of the foreigners. They therefore let go the cable, and the next roller cast their boat right on to the deck of the vessel, which proved to be the *Madeleine*, of Boulogne, a new steam fishing vessel, with a crew of sixteen hands. After some buffeting, breaking their rudder and an oar, and otherwise damaging their tackle, they were enabled to make fast to the side of the wreck, and the Frenchmen one by one jumped, fell, or were pulled into the boat. One poor boy, starved with the cold wind and drenching spray, fell into the sea, but was rescued with a boat-hook; and one of the men, falling into the sea, just managed to seize the fortunately long beard of one of the crew, and was actually sustained and partly pulled into the boat by this means. The result was that the whole of the sixteen were safely brought to land.—Expense of service, 22*l.* 10*s.*

Oct. 23.—At about 9 A.M., the barque *Lydia*, of Grimstad, bound from Arendal to Cardiff with pit props, stranded on

Burnham Flats, Norfolk. The *Lily Bird* Life-boat, stationed at Brancaster, proceeded to her, and found that she had 8 feet of water in her hold, had lost her main topmast, and was in a very dangerous position, her rudder also had been much damaged. The Life-boat remained by her some time, and ultimately, as the water was increasing, took off the crew of fourteen men.—Expense of service, 10*l.* 5*s.*

Oct. 23.—The Life-boat *Commercial Traveller*, stationed at Castletown, Isle of Man, brought safely ashore the crew of three men of the schooner *Gleaner*, of Preston, which had lost her rudder and had been otherwise injured.—Expense of service, 7*l.* 19*s.*

Oct. 23.—The Harwich Life-boat *Springwell* saved the crew of twelve men of the barque *Iris*, of Gefle, Sweden, which had stranded on the Cork Sand, during a strong wind and a heavy sea. The Life-boatmen afterwards rendered assistance in saving the vessel.

Oct. 24.—During a N.E. gale and a heavy sea, the schooner *Louise*, of Fredericksstadt, bound thence to Newcastle with barrel staves, drove ashore on the West Sands, St. Andrew's, N.B., and became a total wreck. The *Ladies' Own* Life-boat put off to her and rescued the crew, consisting of five men.—Expense of service, 19*l.* 1*s.* 6*d.*

Oct. 30.—During a strong wind from the N.E. with a heavy sea, signals of distress were shown by the schooner *Ewart*, of Aland, Finland. The Palling No. 1 Life-boat was at once launched, proceeded to the vessel, and found that she had been ashore on the Hasborough Sands, and had drifted off with loss of rudder and chain, and was full of water. The Life-boat remained by her some time, and eventually a steam-tug arrived, and the vessel was taken into Yarmouth.

Nov. 1.—At 8.45 A.M. a message was received at Poolbeg, Co. Dublin, from the Clontarf Coastguard Station, stating that there were eleven riggers on board the ship *George H. Oulton*, which had stranded on the North Bull, off Clontarf. There was a heavy surf at the time, and the men were in great danger, having been in the rigging of the ship all night. The *Poolbeg* Life-boat was launched, towed by a steam-tug to the vessel, and with great difficulty rescued the eleven men and

took them to Dublin. Expense of service, 7*l.* 13*s.*

Nov. 3.—The sloop *Aurora*, of Boston, bound from that port to Newcastle with a cargo of wheat, while entering Tynemouth Harbour during a heavy sea, at about 5.30 P.M., struck on the Black Middens. The Tynemouth No. 2 Life-boat *Forester* was quickly launched, proceeded to the vessel and succeeded in saving her crew, consisting of three men. The sloop shortly afterwards became a total wreck.—Expense of service, 20*l.* 15*s.*

COMMITTEE MEETING, Nov. 3, 1881.

Voted 284*l.* 8*s.* 6*d.* to pay the expenses of the Hythe, Braunton, Giles' Quay, Banff, Hornsea, Padstow, Pakefield No. 1, Plymouth, Poolbeg, Saltburn, Swansea, Brancaster, St. Anne's, Donna Nook, Cresswell, Montrose, Thorpe, Blackrock (Dundalk), Arbroath, Ardmore, Broughty Ferry, Moray Firth, Douglas No. 2, and Skerries Life-boats, in assembling their crews, or putting off in reply to signals of distress exhibited by vessels which had not eventually require the services of the Life-boats.

The Ramsgate Life-boat had also been taken out, but her services had not been ultimately needed.

Voted the Silver Medal of the Institution, accompanied by a copy of the vote inscribed on vellum, to Mr. JOHN BROWN, coxswain of the Newbiggin Life-boat, in recognition of his long and gallant services in the Life-boat, and particularly on the occasion of the rescue of the crew of four men from the s.s. *Northumberland*, of Newcastle, during a very heavy gale, on the 14th October.

Also the Silver Medal of the Institution, and a copy of the vote inscribed on vellum, to Mr. ROBERT LEGGERTON, Coxswain of the Clacton Life-boat, in recognition of his general gallant services, and particularly on the occasion of the rescue, by the Life-boat, of the crew of sixteen men of the lugger *Madeleine*, of Boulogne, which was wrecked on the Gunfleet Sands on the 23rd October.

Also the thanks of the Institution, inscribed on vellum, to Captain H. M. Todd, master of the s.s. *Conssett*, of Sunderland, in acknowledgment of his valuable and prompt services in towing for several

hours the Clacton Life-boat on the last-mentioned occasion, thus contributing, by his timely help, to the rescue of the lugger's crew.

Nov. 4.—The *May* Life-boat, stationed at Buddon Ness, Dundee, proceeded in tow of a steam-tug to the aid of the three-masted lugger *Frances Marie*, of Nantes, which had stranded on the Abertay Sands during a strong S.E. gale and a heavy sea. With considerable difficulty, owing to the low state of the tide and the terrific sea on the bank, the Life-boat reached the vessel, over which the sea was making a complete breach, and took off her crew of five men. One of the men was washed away from the rigging and fell into the water, but he was speedily rescued by the Life-boat. Immediately afterwards the apprentice boy was washed away from the rigging, and while swimming was dashed several times against the main-yard of the lugger, which had fallen across her deck, and from the effect of his previous exposure in the rigging and the blows he received, he immediately sank, but was got on board the Life-boat with the aid of a boat-hook; unfortunately, however, he never rallied, being apparently lifeless when picked up. In rescuing the boy the Life-boat was driven some distance away from the wreck, and the remaining two men on board had to be hauled by means of ropes from the vessel to the Life-boat. This was safely accomplished, and the men were landed at about 11.30 A.M. The vessel became a total wreck.—Expense of service, 9*l.* 15*s.*

Nov. 4.—The barque *Sans Georg*, of Rostock, Germany, bound from Gefle, Sweden, to Hull, with a cargo of iron and wood, went on the rocks at Whitburgh Point, four miles W. of Dunbar. The Dunbar Life-boat *Wallace* put off, and a fishing-boat which was near also proceeded to the distressed vessel, and with their joint help the vessel's crew of twelve men were safely landed. The vessel was waterlogged, and her crew were much exhausted, having been at work at the pumps for many hours.—Expense of service, 8*l.*

Nov. 4.—In reply to signals of distress, the Seaton Carew Life-boat *Job Hindley* went out, and found the s.s. *Germania*, of Hamburg, in a dangerous position on the North Gare. Part of the Life-boat crew went on board the steamer, and the boat

then took out an anchor and hawser towards the channel, by which means the vessel, after beating heavily on the sand, was got into deep water and proceeded to Middlesborough. She was bound from Hamburg to Middlesborough, in ballast, and had on board a crew of sixteen men and a pilot.

Nov. 4.—A steamer was observed making signals of distress on the Horse Bank, near Southport, at about 3 P.M. The Life-boat *Eliza Fernley*, stationed at Southport, was launched and went alongside the steamer, which proved to be the *Glenwilliam*, of Barrow, bound from Seville to Liverpool, with 400 tons of copper ore. The Life-boat remained by her until midnight, when, after throwing overboard about 40 tons of the cargo, she got off into deep water, and the boat then returned to her station.

Nov. 16.—In reply to signals of distress the Caister No. 1 Life-boat the *Covent Garden*, went out and found the fishing dandy *Scud*, of Yarmouth, on the Barber Sand. The vessel was on her beam ends, and under water except her two masts, part of her crew being on the foremast, and part on the mizen. Having effected communication with the vessel by means of the Life-boat's tow-rope, heaving lines were thrown and three men were rescued from the foremast. Then with great difficulty, on account of the broken spars and sea, the boat was hauled to the mizenmast, and succeeded in taking off the remaining six men, losing all her heaving lines in effecting the rescue. The men had to be hauled through the sea up to their armpits in water and were much exhausted when rescued. When the vessel first struck, her boat was washed round from her stern on to her deck. Three of the crew got into it and the next sea washed it away; fortunately they succeeded in getting on board the Cockle Lightship.—Expense of service, 35*l.*

Nov. 16.—The smack *Young Henry*, of Yarmouth, stranded on the Barber Sand, during a strong S.W. breeze. A yawl was launched and proceeded to the vessel, and the master having engaged the services of the beachmen to get her off, an anchor was laid out. As the day wore on the wind and sea increased, and as the yawl was then unable to get alongside the smack, she signalled for the Caister

small Life-boat the *Godsend*, to come to her assistance so as to ensure the safety of the crew and beachmen on board the smack. The Life-boat was thereupon launched, sailed to the sand and remained by the vessel until she floated.

Nov. 19.—About 9 P.M., the fishing smack *James Innes*, of St. Monance, Fife, went ashore on the Bondicarr Rocks, during stormy weather. The Life-boat *Algernon and Eleanor*, stationed at Hauxley, Northumberland, proceeded to her assistance, and rescued the crew consisting of six men.—Expense of service, 20*l.* 12*s.* 6*d.*

Nov. 20.—At about 5 P.M., during a fresh gale from the S.S.W., a small s.s. the *Retriever*, of Montrose, arrived off the Bar of Arbroath, the tide being then five hours ebb and a strong sea running. The master and two of the crew attempted to land in their small boat. It being dark this was unobserved from the shore; but at about 5.45 cries were heard in the direction of the rocks eastward of the bar by some fishermen, who proceeded to the spot and found one man clinging to the boat which had capsized on the bar, the master and one man having been drowned. Only one man had been left on board the vessel and an attempt was thereupon made to go off to her by one of the fishing-boats, but the sea was so heavy that she had to return to the harbour. The Arbroath Life-boat the *People's Journal*, No. 2, was then manned and went off to the vessel; two of the Life-boatmen were put on board and took her safely to Montrose, for which port she was bound.

Nov. 21.—At 9.30 P.M., during a whole gale from the S.W., the s.s. *Darragh Beg*, of Douglas, got her screw foul of a portion of a chain belonging to a sunken schooner in Douglas Bay. Signals were shown from the steamer and the Douglas No. 2 Life-boat, the *John Turner Turner*, was despatched to her assistance and succeeded in taking off her crew consisting of three men. The steamer, which had been engaged by the Harbour Commissioners and was acting as a lightship for a wreck, subsequently became a total wreck on the North side of the Bay.—Expense of service, 16*l.*

Nov. 21.—The Palling No. 2 Life-boat, the *British Workman*, with the aid of a steam-tug and a yawl, succeeded in getting

the barque *August*, of Sundsvall, Sweden, afloat when she stranded on the Hasborough Sands, during a fresh S.W. breeze and a heavy sea. The Life-boat and steam-tug afterwards proceeded to Yarmouth with the vessel, which was bound from Sundsvall to London, with a cargo of wood, and carried a crew of sixteen men.

Nov. 21.—The Selsey Life-boat *Four Sisters*, rescued the crew, consisting of nine persons, from the brig *Ocean Monarch*, of Guernsey, which had stranded on the Middle Bank, Selsey, during a gale of wind and a very high sea, the weather at the time being thick with rain. The vessel was bound from Shields to Plymouth, with coal.—Expense of service, 6*l.* 18*s.* 6*d.*

Nov. 22.—A vessel was seen making for Ayr Harbour. As she approached, it became evident that she was quite unmanageable, and when within half a mile she suddenly sank, and with the force of the gale was driven on the North Beach. She proved to be the brigantine *J. W. Harris*, of Dublin, bound from Troon to Dublin with a cargo of coal. The Ayr Life-boat *Glasgow Workman*, was launched and proceeded out in tow of the stronger of the two harbour steam-tugs; but after several ineffectual attempts to reach the wreck they had to return to the harbour. In one of these attempts four of the Life-boat crew were thrown out, three of them were picked up by the Life-boat, and the other swam to the wreck. A second crew then manned the Life-boat, succeeded in reaching the wreck, and took off the three survivors of the crew. On being landed these men were taken to Ayr Hospital; one of them died shortly after being admitted, but the others recovered. The Life-boatman was also brought ashore. Two of the vessel's crew had been washed overboard and drowned when nearing the harbour, and another got entangled about the wreckage and was drowned.—Expense of service, 15*l.* 19*s.* 2*d.*

Nov. 22.—During a storm from the W.S.W., six schooners lying in Holy Island Harbour dragged their anchors and went ashore. Two of them—the *Lizzie*, of Fowey, and the *Pursuit*, of London,—fouled each other, and the former vessel being in much danger, her crew left her and got on board the other vessel. Signals were then shown, in

response to which the Holy Island No. 1 Life-boat, the *Grace Darling*, was launched; but she was driven ashore. She was, however, launched a second time; went alongside the two schooners, and took the crew of the *Lizzie* back to their own vessel.

Nov. 22.—The Orme's Head Life-boat *Sisters' Memorial* went out, in a very heavy sea, to the aid of the smack *Ellen*. Finding nobody on board the vessel, the Life-boat took charge of her, and at considerable risk succeeded in taking her safely to Rhos Bay.

Nov. 22.—A message was received at Peterhead that a vessel was stranded about two miles to the S. of Rattary Head. The *People's Journal* No. 1 Life-boat, stationed at Peterhead, was launched, proceeded to the vessel, and with great difficulty got alongside. The crew, consisting of twelve men and a pilot, were then taken into the Life-boat one at a time, by means of a line, and safely landed at Peterhead. The barque proved to be the *Excelsior*, of Laurvig, Norway, bound from South Carolina to Bo'ness, with a cargo of phosphates.—Expense of service, 10l. 13s.

Nov. 22.—During a severe gale of wind from the W. the schooner *Cambria*, of Thurso, lying in Scrabster Roads, dragged her anchors. The Thurso Life-boat *Charley Lloyd* put off, and brought ashore the two men who were on board the vessel.—Expense of service, 7l.

Nov. 22.—The brigantine *Flora*, of Swansea, bound from Dublin to Liverpool, in ballast, running for Troon Harbour, drifted into the North Bay. The Troon Life-boat *Mary Sinclair* went to her assistance, took off her crew, five in number, and brought them safely ashore. The vessel rode out the gale, and on the following day, the storm having abated, the Life-boat put the men on board her again, and she was towed into the harbour.—Expense of service, 13l.

Nov. 22.—At 9 p.m. the signal guns were fired for the Douglas Life-boat to proceed to the assistance of the s.s. *Shannon*, of Liverpool, which had previously been towed into the Bay by another steamer. The Douglas No. 2 Life-boat, the *John Turner Turner*, accordingly went to her aid, and found that she had three feet of water in her engine rooms, that she was dragging her anchors and drifting

towards Connister Rock. The Life-boat stood by her for about an hour, when, having got up sufficient steam to make way, she slipped her anchor, and was piloted into the harbour by the Life-boat.—Expense of service, 13l.

Nov. 24.—The Penzance Life-boat *Richard Lewis* went out at about 6.40 p.m., in response to signals of distress exhibited by the barque *Pampero*, of Swansea, which had been disabled and had anchored in a dangerous position to prevent total loss by driving ashore. The wind was blowing from the S.W., with a heavy ground sea. Signals were shown for a tug; and at the master's request the Life-boat also proceeded ashore to procure the services of a steamer, and soon afterwards returned with the steam-tug *Queen of the Bay*. A hawser having been conveyed from the tug to the barque, the anchor and cable were slipped, and the vessel was towed to Falmouth by the steamer, the Life-boat returning to her station, which was reached at 2 o'clock on the following morning. The barque had a crew of fourteen men.

Nov. 26.—During a very heavy gale from the S.S.W., with rain and a high sea, the Ramsgate Life-boat *Bradford* and steam-tug *Vulcan* went out in reply to signals of distress, and took the brig *Innis Fail*, of Dublin, and her crew of eight men, safely into Ramsgate Harbour.

Nov. 27.—The Dutch barque *Baron Van Pallandt*, laden with teak, from Moulmein to Liverpool, parted both her cables and went ashore broadside on in Batten Bay. The Life-boat *Clemency*, stationed at Plymouth, was launched and proceeded to the vessel, but the crew refused to leave her. The Life-boat remained by her until a Government tug came and tried to pass a hawser to the stranded vessel, but failed to do so, the hawser being too short. After waiting some time, eleven of the crew with their effects were taken off by the Life-boat, transferred to the tug, and landed. The captain and two men, who had remained on board, landed in their own boat at low water.—Expense of service, 6l. 9s. 6d.

Nov. 27.—While a heavy gale was blowing from the W., with fierce squalls and a heavy sea, the Ramsgate Life-boat *Bradford*, and steam-tug *Vulcan*, proceeded to the assistance of the schooner *Albion*, of Southampton, and rescued four men who were on board her. The vessel stranded

on the Goodwin Sands, and became a total wreck.

Nov. 27.—The barque *Excelsior*, of Hamburg, bound from Rangoon to Scilly for orders with rice, was riding at anchor in St. Mary's Bay, Scilly, during a strong gale of wind from the W. and a heavy sea. At about 3.30 P.M. she showed signals of distress, in response to which the *Henry Dundas* Life-boat, stationed at Scilly, proceeded to her, and found that she had parted two cables and was then dragging her spare anchor, which had been let go. The anchor was afterwards slipped, and the vessel was run over Crow Bar on to Cruther's Point, St. Martin's. Two pilot gigs also boarded the vessel. The Life-boat remained by her during the night and returned to her station at 8 o'clock on the following morning, having been absent sixteen hours.

Nov. 28.—In reply to signals, the Bembridge Life-boat *City of Worcester* put off and found the barque *Caduceus*, of North Shields, on the Chichester Folds. She was full of water, and her masts had been cut away, the stump of the mizen only being left, round which the crew had gathered for security, as the sea was breaking over the vessel fore and aft, and threatening to wash them overboard at any moment. The men, 10 in number, were taken into the Life-boat and brought safely ashore. — Expense of service, 16*l.* 5*s.* 6*d.*

Nov. 30.—The *City of Dublin* Life-boat, stationed at Courtmacsherry, Co. Cork, put off to the aid of the steamer *Glen-Devon*, which had a signal of distress flying while at anchor on a dangerous lee shore at the Seven Heads. The weather was moderating after a very heavy gale, but a tremendous sea was running. After three hours' hard pulling the Life-boat reached the steamer and found that her engines and screw had been disabled. At the master's request the Life-boat returned ashore and telegraphed for a tug to proceed to the vessel.

COMMITTEE MEETINGS, Dec. 1—31, 1881.

Voted 539*l.* 0*s.* 4*d.* to pay the expenses of the Broughty Ferry, Holy Island, St. Andrew's, Holyhead, Maryport, Penmon, Newhaven, Kingstown, Winterton No. 2, Ramsey, Ardrossan,

Caister No. 1, Hayling Island, and other Life-boats in either assembling their crews or putting off in reply to signals of distress shown by vessels which did not ultimately need the assistance of the Life-boats.

Also the Silver Medal of the Institution to Lieut. A. J. LINDSAY, R.A., in acknowledgment of his prompt and gallant conduct in volunteering his services and forming one of the crew of the Poolbeg Life-boat when that Boat put off with the view of rendering assistance to the crew of the ship *George H. Oulton*, of St. John, N.B., which had stranded on the North Bull, Clontarf, on the 22nd October.

Also the Silver Medal of the Institution, accompanied by a copy of the vote inscribed on vellum, to Mr. H. WILLIAMS, coxswain of the Kingstown Life-boat, in recognition of his long and gallant services in the Life-boat, and particularly at the wreck of the ship *George H. Oulton*, of St. John, N.B., during a heavy gale from the S.E. on the 31st October.

Dec. 6.—The Life-boat *John Abbott*, stationed at Bridlington, Yorkshire, brought safely ashore the crew of 2 men from the sloop *New Eagle*, of Grimsby, which had lost all her sails, during a gale of wind from the S.W. The sloop, which was on a voyage from Hartlepool to Burnham with coal, was afterwards taken into Bridlington Harbour.—Expense of service, 19*l.*

Dec. 6.—The schooner *Reine de Cœur*, of Nantes, bound from Glasgow to Redon, France, put into Douglas Bay for shelter during a moderate gale of wind from the S.S.W. and a heavy sea. When rounding the Battery Pier she missed stays. The anchor was let go, but not soon enough to prevent her drifting on to Connister Rock. Cries of distress were heard from the vessel and signal guns were fired for the Life-boat. The Douglas No. 2 Life-boat *John Turner* was immediately despatched to her assistance, and succeeded in saving the crew of 6 men. The schooner went to pieces about an hour after the men had been taken off.—Expense of service, 12*l.*

Dec. 9.—During a strong S.W. wind and a very heavy sea the Dover Life-boat *Henry William Pickersgill*, R.A., put off to the aid of the barque *Chin Chin*, of Jersey, which had missed stays and gone ashore at the South Foreland. With great

risk, owing to the spars and wreckage floating near the barque, the Life-boat succeeded in rescuing the 5 men on board the vessel, five of her crew having previously landed at low water. Soon after the Life-boat had left her, the vessel's masts fell overboard, and she became a total wreck. The Dover Harbour Tug *Granville* rendered valuable service in assisting the Life-boat to accomplish this rescue.—Expense of service, 10*l.* 17*s.*

Dec. 13.—At 11 p.m. it was reported that a vessel was ashore at Briardean, Northumberland, and that she was burning a tar barrel as a signal of distress. The Cullercoats Life-boat *Palmerston* proceeded to her and found that she was the brig *Arica*, of Whitby. She had been abandoned, and was on fire, the flames from the tar-barrel having set the galley on fire. Some of the Life-boatmen were therefore put on board the vessel and extinguished the flames, thus saving the vessel and her cargo of timber from destruction. They also ran out a kedge to keep the vessel from driving further on the rocks, and then returned to their station. Subsequently the Life-boat again proceeded to the stranded brig, and with the help of some steamers she was taken to Shields.

Dec. 15.—Large flares having been seen in the direction of the Barber Lightship, and rockets and guns having also been fired, the Caister No. 2 Life-boat the *Godsend* proceeded to the Barber Sand, and found the brigantine *Menodora*, of Hartlepool, ashore there. A fresh breeze was blowing from the S. at the time, and there was a nasty sea on the sand. The Life-boat remained by the vessel until the tide flowed, when she filled, and her crew, 6 in number, were taken into the Life-boat. The vessel afterwards drove off the sand and sank in deep water.

Dec. 16.—A French chasse marée, the *St. Anne*, bound to Rye, Sussex, with a cargo of potatoes, took the ground while trying to make Rye Harbour during a strong gale of wind and a heavy sea. The Rye Life-boat *Mary Stanford* proceeded to her assistance, and brought ashore the pilot and the crew of six men. One of the Life-boatmen was washed overboard from the Boat by a heavy sea, and another man, in attempting to board the vessel, fell into the water, but both men were

fortunately rescued.—Expense of service, 20*l.* 10*s.*

Dec. 16.—The brig *Athalia*, of Hartlepool, bound from Gefle, Sweden, to Rochester, with bar iron, deals, and battens, ran ashore off Waxholme, Yorkshire, during a S. by E. wind and a moderate sea. The Life-boat *Admiral Rous*, stationed at Withernsea, went to her assistance, and remained by her until two steam-tugs arrived and towed her off.

Dec. 17.—The Harwich Life-boat *Springwell* was launched in reply to signals of distress, and proceeded in tow of a steam-tug to the Long Sand Head, where she found the barge *Olive Branch*, of Harwich, in a disabled condition, having lost all her sails, and leaking badly. Some of the Life-boatmen went on board her, and with the aid of the steamer she was taken to Harwich. She carried a crew of three men. A gale of wind was blowing at the time from the S.S.W., accompanied by a heavy sea.

Dec. 17.—The three-masted schooner *Constance*, of Swansea, bound from Newport to Santander, with coal, while making for Hayle, Cornwall, during a gale from the W., became unmanageable in crossing the bar, and grounded on the eastern side. The Hayle Life-boat *Isis* went to her aid, and brought ashore nine men and a pilot who were on board her.—Expense of service, 7*l.* 4*s.*

Dec. 18.—The Caister No. 2 Life-boat *Godsend*, with the aid of a steam-tug, took safely into Yarmouth Harbour the brigantine *Fidèle*, of Marstrand, Sweden, which had lost an anchor and chain, and had had her sails blown away during a gale of wind from the W. The vessel was on a voyage from Gothenburg to Yarmouth, with deals, and had a crew of six men.

Dec. 18.—During a strong gale from the W.N.W. the *Albert Edward* Life-boat, stationed at Padstow, Cornwall, proceeded to the assistance of the barque *Milka*, of Fiume, Italy, which had been disabled, and was in a perilous position owing to the heavy sea then running. The Life-boatmen, by means of signalling, directed the vessel round the points, and afterwards remained by her until a steam-tug arrived to tow her into a place of safety. She was bound from Cardiff to Venice, with a cargo of coal.—Expense of service, 6*l.* 16*s.*

SHORE-BOAT SERVICES REWARDED BY THE ROYAL NATIONAL LIFE-BOAT INSTITUTION IN 1881.

Jan. 6, 1881.—Voted the Silver Medal of the Institution, and a copy of the vote inscribed on vellum, to Mr. HENRY SMITH, pilot, of Gloucester, and 1*l.* to his mate, for saving the owner, and two persons on board the yacht *Foam*, which was in a dangerous position in Cardiff Grounds, in a gale of wind and very heavy sea, on the 7th August.

Also the thanks of the Institution to Lieut. G. W. SPANKIE, Royal North Down Rifles, in acknowledgment of his services in swimming out to sea and assisting to rescue the crew, consisting of eight men, of the Norwegian brig *Olaf Kyrre*, which was wrecked in Dundrum Bay on the 28th November.

Also the thanks of the Institution and 2*l.* to JOHN REES, fireman of the steam-tug *Earl of Windsor*, for putting off in the steamer's punt, with only one oar, and at much risk saving the master of the smack *Unity*, of Bideford, which had been in collision with the steamer, and had sunk about two miles from the Breaksea Lightship, in the Bristol Channel, during a fresh S.W. gale, on the 16th November.

Also 5*l.* to five Coastguardmen of Ringsend, Co. Dublin, for putting off in a boat, and, at much risk, saving four men who had been caught in a gale while working on a piling stage on the north side of the breakwater near Poolbeg, on the 23rd November.

Also 2*l.* to four men for saving three other men from the fishing-boat *Billow*, of Peterhead, which had been upset on a sandbank off Newburgh, Aberdeenshire, during heavy weather, on the 7th December.

Also 1*l.* 15*s.* to six men for putting off in a boat and saving a man from another boat off Rotten Island, Co. Donegal, during a strong S.E. wind, on the 27th October. The man, while trimming the sail of his boat, had fallen overboard; he clung to the boat, which filled with water, and was drifting out to sea when the salvors put off to his rescue.

Jan. 6.—At daylight, during a N.E. gale, the brig *Alert*, of Clay, Norfolk, was seen from the cliffs at Sheringham to be in distress, having lost her mainmast. She had her colours flying in the rigging and was running for Clay Beach. The *Augusta* Life-boat, belonging to the Sheringham beachmen, was immediately launched, arrived alongside the vessel ten minutes before she went ashore, and took off the crew numbering seven men, who were safely landed at Wells. Half an hour after the men had been taken off, their vessel had entirely broken up.—Reward, 10*l.*

Jan. 16.—At 1 A.M., during a strong wind from the W. with heavy snow showers, the brigantine *Livonia*, of Arbroath, from Boulogne to Newcastle, struck on the Hasborough Sand. She beat across the Sand; but being in a leaky condition signals of distress were shown, in reply to which the yawl *Dart*, of Palling, went to her assistance, but was unable to lay alongside her owing to the heavy sea. The crew of the *Livonia*, consisting of five men, at last succeeded in launching the ship's boat, and thus

reached the yawl, and were taken on board with great risk.—Reward, 5*l.*

Jan. 18.—A man rescued one of the crew who had fallen overboard from the French lugger *Dupuytren*, which was stranded at Oliver's Gap, Theddlethorpe, during a gale from the E. The rescued man had a narrow escape of being washed out to sea by the ebb-tide.—Reward, 1*l.*

Jan. 18.—Mr. BERNARD HAMILTON, Coxswain of the Black Rock (Dundalk), Life-boat, and five other men, promptly and laudably proceeded to the rescue of a man who had gone out on the ice to recover one of the buoys which had broken loose in Dundalk Bay, and who had been unable to regain the shore during very severe weather.—Reward, 4*l.* 10*s.*

Feb. 3.—Voted the thanks of the Institution and 5*l.* to Mr. SÆVENS, for saving, by means of a rope attached to his cart, the crew of four persons from the schooner *Ann Turgoose*, of Goole, which was wrecked at Saltfleet Haven, during a gale and very rough sea on the 18th January, and 10*s.* each to three men who assisted him in effecting this rescue.

Also 10*l.* to the crew of the *Zetland*, private Life-boat, of Redcar, for rescuing at considerable risk, the crew consisting of seven persons from the brig *Luna*, of Rochester, which was totally wrecked at Redcar during a strong gale of wind from the E.N.E., on the morning of the 29th October.

March 3.—Voted the thanks of the Institution, inscribed on vellum, and 5*l.*, to Mr. C. R. HALL, master of the steam-tug *Daring*, of Gravesend; 3*l.* to the engineer of the tug, and 2*l.* each to the crew of five men, for saving the crew, consisting of eleven men, of the Norwegian barque *Frigate Bird*, which was in a sinking state after striking on the Goodwin Sands during a S.W. gale on the 15th December.

Also 8*l.* to four men for putting off in a boat from Duck Island, Galway, and, at much risk, saving four out of six men from a hooker which had been capsized between Mweenish and Duck Island during a fresh gale from the S.W. and hazy weather, on the 22nd December.

March 3.—Five Coastguardmen put off in their Life-boat at Lambay Island, Co. Dublin, and rescued the crew of five persons from the smack *Diligent*, of Dartmouth, which had been struck by a heavy sea, and dismasted, off Lambay Island during a strong southerly gale.—Reward, 3*l.*

March 3.—Four pilots of Penmon, Anglesey, saved, at some risk, by means of ropes from the shore, the crew of six men from the cutter *Messenger*, of Jersey, which was totally wrecked on the rocks off Penmon, during a heavy gale from the S.S.E.—Reward, 2*l.*

March 5.—Six men put off in a shore boat from Cemaes, Anglesey, and, at considerable risk, saved two men from the barque *Gilbert Thompson*, of Liverpool, which had gone on the West Mouse Rock, in a strong wind and heavy sea. After rescuing these two men who were on board the vessel, the salvors took twenty of

the crew off the rock by means of heaving lines and put them on board a steam-tug which had been towing the barque.—Reward, 6*l*.

March 20.—Five men put off in a boat and assisted to save the fishing lugger *Royal Diadem*, of Cellardyke, and her crew of six men, that vessel being in distress, having lost her sails, off Bressay, Shetland, during a snow storm, and a high sea.—Reward, 2*l*. 10*s*.

March 30.—At about 12.45, A.M., cries for assistance were heard by the Coastguard at Cadgwith, Cornwall, during a gale from the E. The galley was speedily manned by six Coastguardmen, and at great risk brought ashore the crew of two men from the fishing-boat *Start*, of Porthleven.—Reward, 5*l*.

April 7.—Voted the Silver Medal and a copy of the vote, inscribed on vellum, to Mr. THOMAS BATE, coxswain of the Institution's Bude Life-boat, in acknowledgment of his gallant services in assisting, at considerable risk of life, to save four men on the occasion of the wreck of the ketch *Stuclej*, of Bude, on Bude breakwater, during squally weather, on the 31st December.

Also the thanks of the Institution, inscribed on vellum, to Mr. GEORGE TICKELL, writer in H.M.S. *Defence*, and 3*l*. 10*s*. to some other men, in acknowledgment of their highly laudable services in assisting, at considerable risk of life, to save the crew of the *Stuclej*.

Also the thanks of the Institution to Mr. DANIEL PEARCE, Commissioned Boatman in H.M. Coastguard service, in recognition of his highly meritorious conduct in going out twice in the Institution's Rye Life-boat, and once in the galley belonging to Jury's Gap Coastguard Station, and assisting to rescue, at considerable risk, the crew of three men from the sloop *Sophia Holtten*, which was wrecked off Jury's Gap, during a strong W.S.W. gale, on the 10th February.

8*l*. were also voted to the crew of the Jury's Gap Coastguard galley for saving one of the shipwrecked crew on this occasion.

April 28.—Two fishermen of Staithes, Yorkshire, saved the crew of three men of another cable, which, while making for the beach at Staithes, had broached to and had been filled by a heavy sea.—Reward, 2*l*.

May 4.—Two fishermen of Cromer, Norfolk, put off in a small boat and rescued four men whose boat had been capsized by a heavy sea, while proceeding out fishing. One of the rescued men unfortunately died before reaching the shore, and the other three men suffered for some days from the effects of the accident.—Reward, 2*l*.

May 5.—At about 12.30, noon, a pilot boat was observed to capsize about a mile south of Drogheda Bar, and two men who had charge of her were seen to be clinging to her keel. The wind was blowing a moderate gale from the S.S.W. at the time. Four men immediately put off in a pilot boat from Drogheda, proceeded to the rescue of the drowning men and brought them safely to shore.—Reward, 2*l*.

May 7.—GEORGE CORMACK, son of the master of the fishing lugger *Margaret*, No. 192, of Wick, rescued one of the crew of that vessel, who had been washed overboard by a heavy sea in the Pentland Firth during a W. gale.—Reward, 1*l*.

May 16.—Six men rushed into the surf and saved two of the crew of the schooner *Margaret Jane*, of Newry, on the occasion of their boat capsizing while they were endeavouring to reach the land during a gale from the N.W.—Reward, 3*l*. 10*s*.

June 2.—Voted 5*l*. 5*s*. in aid of a local subscription which was being raised at Brighton on behalf of ABRAHAM YOUNGS, late chief Boatman of the Brighton Branch of the Royal Humane Society, who had been instrumental in saving upwards of one hundred and seventy-two lives from drowning on different occasions.

June 13.—At about noon an open boat containing five men, was proceeding across Burial Sound, Co. Down; a strong breeze was blowing from the N. at the time with a very strong tide. The boat shipped so much water as to become entirely unmanageable, and the men were in imminent danger of being lost, when three other men put off in a boat from Ballyhalbert, and with great trouble and risk rescued them.—Reward, 2*l*.

July 6.—Four men helped to save three boys whose boat had been capsized while they were sailing about Poole Harbour, Dorset, during squally weather.—Reward, 1*l*.

July 10.—At about 10 A.M., a boat was observed drifting out to sea off Ballygeary, Co. Wexford. A boy was in her and he was waving his hat and making evident signals of distress. Three men thereupon put off in a boat and brought the boy—who was perfectly helpless in the boat, having only one oar—safely ashore.—Reward, 1*l*.

Aug. 8.—Two men rescued two women, whose boat, while returning ashore laden with seaweed, had sunk near Ballywhorisky Strand, Co. Donegal.—Reward, 1*l*.

Aug. 10.—Three men put off in a boat from Groomsport, Co. Down, during a fresh W.N.W. gale, and rescued two boys, who while out in a fishing punt, had been overtaken by the gale, and were being driven out to sea.—Reward, 1*l*.

Aug. 11.—The crew of the yawl *Dart*, of Palling, Norfolk, put off and brought ashore the crew, consisting of seven men, of the brigantine *Georges*, of Dunkirk, which had been in collision with the barque *Clodian*, and had sunk, during a fresh W.N.W. wind and squally weather.—Reward, 5*l*.

Aug. 25.—Four men put off in a boat from Portrush, Co. Antrim, and brought safely ashore another boat containing a man and three children, which was in a dangerous position during a strong easterly wind.—Reward, 1*l*.

Aug. 29.—The chief officer of H.M. Coastguard Station at Looe, Cornwall, and five of his men went out in the Coastguard Life-boat and saved one man from the ketch *Lion*, of Exeter, which was capsized off Dowderry, during a S.S.W. gale.—Reward, 1*l*. 10*s*.

Aug. 29.—Four Coastguardmen and a fisherman, put off at great risk in the whale-boat belonging to the Dowderry, Cornwall, Coastguard Station, with the view of helping the crew of the ketch *Lion*.—Reward, 2*l*. 10*s*.

Sept. 1.—Voted the Silver Medal, a copy of the vote inscribed on vellum, and 2*l*. to Mr. JAMES TURNER, Chief Officer of H.M. Coastguard at Leysdown, Kent, and 2*l*. each to four

of his men, for putting off at great risk in the Coastguard gig, and bringing safely ashore at Bishopstone—fourteen miles distant from Leysdown—the crew of six men of the steam launch *Edith*, of London, who had taken to their boat, the launch having sunk off Warden Point, Isle of Sheppy, during squally weather and in a heavy sea, on the 31st July.

Oct. 6.—Voted the Silver Medal of the Institution, accompanied by a copy of the vote inscribed on vellum, to Mr. W. J. CUMISKY, Hon. Secretary of the Balbriggan, Co. Dublin, Branch of the Institution; the thanks of the Institution inscribed on vellum to Mr. THOMAS BOYD, chief officer of H.M. Coastguard at Balbriggan, and 10*l.* to that officer and five of his men for putting off at great risk in the Coastguard Life-boat and saving five persons from the brig *Endeavour*, of Whitehaven, which went ashore outside Balbriggan Harbour during a strong gale from the S.S.E., and in a heavy sea, on the 25th August.

Oct. 14.—Ten men saved eight persons on the occasion of the wreck of the s.s. *Cyprian*, of Liverpool, at Rhosgor, Carnarvonshire, during a heavy N.W. gale.—Reward, 6*l.* 10*s.*

Oct. 14.—Five men went off in a boat and rescued the crew of two men from the schooner *Rose*, of Liverpool, which was wrecked off Holyhead during very stormy weather.—Reward, 3*l.*

Oct. 19.—Four men brought safely ashore the fishing boat *Ramsborough*, of Aberystwyth, and her crew of three men, which boat was helplessly drifting during a strong E.S.E. gale.—Reward, 2*l.*

Oct. 19.—Five Coastguard men at Cloghy, Co. Down, put off in the Coastguard whale-boat and rescued the crew of four men from the schooner *Stewart*, of Carrickfergus, which had stranded in Cloghy Bay during a strong gale from the S.E. by S.—Reward, 3*l.*

Oct. 22.—Twelve men went out in a fishing boat and saved five of the crew of the lugger *Twelve Apostles*, of Auray, France, which was in distress off Ballinagoul, Co. Waterford, during a S.E. gale.—Reward, 6*l.*

Oct. 24.—Eight men put off in a boat to the rescue of the crew of the stranded smack *George and Elizabeth*, of Bideford, at Tinaberna, Co. Wexford, during a moderate E.S.E. gale.—Reward, 4*l.* 10*s.*

Nov. 21.—The crews of the Ardrossan Harbour steam-tug and a shore boat rescued two of the crew of the barque *Annetta*, of that port, which was wrecked on Horse Island during a severe gale.—Reward, 6*l.*

Dec. 1.—Voted the thanks of the Institution inscribed on vellum to Mr. SAMUEL LAKE and to Mr. C. H. WOODHOUSE, of Milford, and 3*l.* to their boat's crew of six men, for putting off in a boat at considerable risk and saving a man from a coal hulk off Milford during a strong W.N.W. wind on the 14th October.

Also 2*l.* to THOMAS ROWLANDS for putting off in a small punt from his fishing boat, and saving at great risk seven persons from a pleasure boat, which had sunk off Whirley Point, Carmarthenshire, during squally weather, on the 1st September.

The following is a copy of a Handbill circulated on the Coasts of the United Kingdom by the Institution, for the purpose of informing Boatmen and others that it encourages laudable exertions to save Life from Shipwrecks:—

TO BOATMEN AND OTHERS.

To encourage prompt and energetic exertions in time of Danger on the part of Boatmen and Others, by quickly putting off to save Life in CASES of WRECKS on the Coasts of the British Isles, either by

SHORE-BOATS OR OTHER MEANS,

The Royal National Life-boat Institution

GRANTS

Rewards of Money or Medals. In all cases the Rewards are given without further delay than is necessary to obtain proof of the merits of each case, and to ensure their being paid to the right parties.

Application to be made to the Secretary.

By Order of the Committee.

THE
MEDAL OF THE ROYAL NATIONAL LIFE-BOAT INSTITUTION,
 FOR THE PRESERVATION OF LIFE FROM SHIPWRECK.

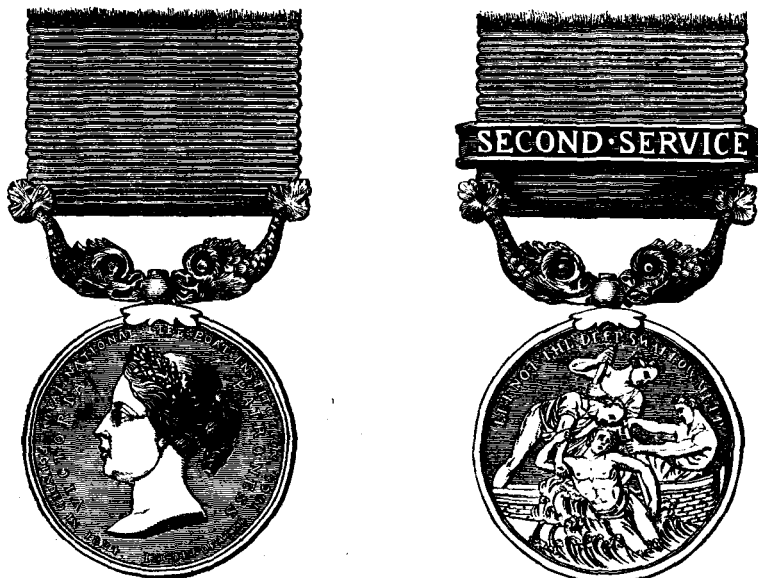

Obverse.—Bust of Her Majesty Queen Victoria; beneath, in minute letters, "L. C. Wyon." Double legend, "Royal National Life-boat Institution. Founded in 1824. Incorporated 1860. Victoria, Patroness."
Reverse.—Three sailors in a Life-boat,—one of whom is in the act of rescuing an exhausted mariner from the waves on a fragment of the wreck. "W. Wyon, Mint." Inscription, "Let not the deep swallow me up."

THE beautiful obverse of this medal, executed by L. C. WYON, Esq., represents the bust of QUEEN VICTORIA, Her Majesty's locks gracefully waving and gathered in a knot behind, from which issues a wreath of oak clustering over the forehead. This life-like portrait of the QUEEN, in high relief, conveys a truly pleasing and faithful likeness of HER MAJESTY at that period (1862), combining the dignity of aspect and benevolence which have always characterised the Queen throughout her long and prosperous reign.

The reverse, representing the Life-boat, in which there are three Seamen, rescuing a fourth from the sea, is a work of great merit. Two of the men are steadying the boat, while the other, stooping, draws in the Shipwrecked Sailor, whose figure is given so as to show the form in the most natural manner; and the expression thrown into his countenance looking up to his preserver is supplicating in the extreme, while the easy flowing lines of this sailor are finely contrasted by those of his companions: the whole displaying a perfect knowledge of the human frame, and a command of the graver to embody what he had shadowed out to himself.

But there is another pleasing motive for admiration of this beautiful Medal, as the figure who is so humanely extending his relief to the drowning Mariner is a portrait of the Artist, the late WILLIAM WYON, Esq., R.A., himself.

The following is a LIST of the GOLD and SILVER MEDALS that have been voted by the Committee of the Institution, since its establishment in 1824, to persons whose humane and intrepid exertions in saving Life from Shipwreck on our Coasts have been deemed sufficiently conspicuous to merit that honourable distinction. The Cases will be found recorded in detail in the several Annual Reports of the Institution.

The total number of Medals granted by the Institution up to the present time is 1,043, 95 of which were in Gold, and 948 in Silver.

Note.—The asterisk (*) after the name denotes the reception of a Gold Medal. The figure after the name signifies the number of honorary distinctions received from the Institution. Abbreviations.—C. G^d.—Coast Guard. R. C.—Revenue Cruiser. M. M.—Master Mariner.

Acraman, Mr. J., Fishguard.	Alexander, W., Coxswain of the Thorpeness Life-boat.	Armstrong, R., Newbiggin.	Bacon, Henry, Harwich.
Adair, Mr. W., C. G ^d , Dundrum.	Allan, Jas., Holy Island.	Armstrong, Mr. W., Blyth.	Bacon, Mr. James, M. M.
Adam, Mr. J., C. G ^d , New-castle. (2)	Allen, Mr. Luke Jas., M. M., Wivenhoe.	Armstrong, W., Newbiggin.	Bailey, Jas., Boatman, Deal.
Adams, Mr. Thomas, M. M.	Amis, Edward, late Coxswain of the Palling Life-boat.	Askin, J., C. G ^d , Ballywalter.	Baillie, Lieut. Henry, R.N.
Agar, J., C. G ^d , Morris Castle.	Anderson, Mr. John G., R.N.	Atkins, T., C. G ^d , Wainfleet.	Baillie, Lieut. H., R.N.
Agnes, Samuel, Wivenhoe.	Annis, Mr. M., C. G ^d . (2)	Austen, Wm., Seaman, Ramsgate Steamer <i>Vulcan</i> .	Bain, Alex., Seaman, Skerries.
Ahern, John, C. G ^d , Kilmore.	Anthony, Mr. Owen, M.M., Holyhead.	Auridge, Lieut., R.N., Doonbeg.	Bake, Lieut., R.N., C. G ^d .
Aikin, J., C. G ^d , Cushendall.		Avisse, Mr. J. N., M. M., Boulogne.	Baker, Lt. W. H., R.N., C. G ^d .
			Baker, Mr. T., C. G ^d , Brooke.
			Banyard, Mr. John, C. G ^d .

- Barlach, Mr. Henry, M. M.
 Barnard, A., C. G.^d. (2)
 Barnes, George, Christchurch.
 Barrett, Mr. J., C. G.^d.
 Carnsore. (2)
 Barrett, W., C. G.^d.
 Barrett, W., Jun., ditto
 Barron, R. N., Esq.
 Barry, Lt. G., R.N., Kinsale.
 Bartholomew, R. J., Esq.,
 Rothessay, N.B.
 Bate, Samuel, Second Cox-
 swain of Padstow Life-boat.
 Bate, Thomas, Coxswain of
 the Bude Life-boat.
 Bates, Mr. Thos., C. G.^d.
 Batist, J., C. G.^d. Dymchurch.
 Beatson, G. B. M., Esq., C. G.^d.
 (2)
 Beauclerk, The late Lord
 Charles.
 Beck, Robert, Point of Ayr.
 Beddoe, D., Fishguard.
 Bedwell, Mr. Wm., M. M.
 Begg, Mr., M. M.
 Belsey, Hy., Life-boatman,
 Ramsgate.
 Bennett, Capt. C. C., R.N.*
 Berriman, Mr. James, M.M.
 Berry, David, Life-boatman,
 Ramsgate.
 Bevan, Mr. John, M. M.
 Bickerstaffe, Mr. R., Cox-
 swain Blackpool Lifeboat.
 Billett, Mr. R., C. G.^d, Cox-
 swain of Lydd Life-boat.
 Bingham, Mr. Wm. [ter.
 Bishop, Mr. S., C. G.^d, Cais-
 Black, A., C. G.^d, Strangford.
 Blackmore, Mr. Wm., Chief
 Officer C. G.^d, Penzance. (2)
 Blackwood, Rev. J. O'Reilly,
 Ballyvalear.
 Blair, Lt. Horatio, R.N., C. G.^d.
 Blampied, Mr. C., Jersey.
 Blanc, John, Shetland.
 Bissendon, William M.
 Biois, Capt. J. R., R.N.*
 Bolitho, Simon, C. G.^d, Bude.
 Bongourd, H., Pilot, Guernsey.
 Bonner, G., C. G.^d, Collieston.
 Bouchard, John, St. Martin's.
 Bowen, Lieut. C. H., R.N.*
 Boyd, Henry, C. G.^d.
 Boyd, Mrs. Captain, R.N.
 Boyle, Marcus, Coxswain of
 Wexford Life-boat.
 Boyle, Lieut. Hon. R. F., R.N.
 Brice, W., C. G.^d, Greencastle.
 Bridle, Mr. W., M. M., Lyme.
 Brine, Thos., Esq., Douglas.
 Brinkamead, Mr. W., M. M.
 Brittain, Lieut. G. S., R.N.,
 C. G.^d. (2)*
 Britton, Mr. J., Master of the
 American Ship *Rochester*.
 Britton, Mr. Wm., Coxswain
 of the Harwich Life-boat.
 Broad, W., Esq., Falmouth.*
 Brooks, A., C. G.^d, Dungeness.
 Brown, Henry, Newbiggin.
 Brown, James, Dunbar.
 Brown, Mr. John, Coxswain
 of Newbiggin Life-boat.
 Brown, Thos. Cresswell.
 Browne, Mr. P. E. M. (2)*
 Brune, Miss B. M. Pridcaux.
 Brune, Miss E. F. Pridcaux.
 Brune, Miss G. R. Pridcaux.
 Brune, Miss M. K. Pridcaux.
 Brunton, Lt. J., R.N. (2)*
 Buck, W. C., Esq., R.N., C. G.^d.
 Buckett, J., Coxswain Bright-
 stone Grange Life-boat.
 Budd, James, Esq., Tramore.
 Bulkeley, J. B., Coxswain of
 T'aignmouth Life-boat.
 Bulley, Lieut. J., R.N. (4)*
 Bumbay, Mr. J., C. G.^d, Clowelly.
 Bunt, Mr. John, C. G.^d.
 Burnard, Mr. T., Bideford.
 Burne, J., C. G.^d, Penzance
- Burne, John, Sen., Shields.
 Burney, Mr. R., C. G.^d, Banff.
 Bury, Lt. Viscount, P. C., M. P.
 Butcher, James, Lowestoft.
 Butcher, Rich., Lowestoft.
 Byrne, Mr. Lawrence, C. G.^d.
- Cahill, D. F. S., Esq., M. D.
 Cain, Wm., Isle of Man.
 Callaway, W., Seaman, Lyme.
 Campbell, James, Leestone.
 Campbell, Miss J., Drogheda.
 Campbell, Mr. Angus, Cutter
 Princess Royal.
 Cameron, Capt. Orford S.,
 R.N., C. G.^d.
 Candlish, J., Coxswain of the
 Lytham Life-boat.
 Cannell, T., Isle of Man.
 Carberry, Patrick, Wexford.
 Carbis, Thos., Coxswain of
 the Penzance Life-boat. (2)
 Carey, H., Esq., Shrove Head.
 Carr, C.S., Gunner R.C. *Sylvia*.
 Carr, Mr. Henry, H.M. Customs,
 Wexford.
 Carr, John, C. G.^d, Dunmanus.
 Carr, Mr. Samuel, C.O. C. G.^d,
 King's End
 Carrington, Mr. J., Master of
 Steam-tug *Liverpool*, of
 Harwich.
 Carrington, Lieut., R.N.
 Carrington, W. H., Esq.
 Carter, Mr. J., C. G.^d.
 Casey, M., Newcastle, Ireland.
 Castel, G., Broadstairs.
 Cay, Capt. R. B., R.N. C. G.^d.
 Chaddock, J., C. G.^d.
 Chappell, Mr. T., Bideford.
 Chappell, Capt. W., Bideford.
 Chard, J., Boatman, Thorpe.
 Chesnut, George, Skegness.
 Chittenden, E., Broadstairs.
 Clark, George, Seaman.
 Clark, Lieut. Joseph, R.N.*
 Clayburn, T., Scarborough. (2)
 Clayton, Lt., R.N., C. G.^d.
 Cleave, Mr. R., M.M., Wivenhoe
 Cloke, W., Pilot, Mevagissey.
 Cobb, Rev. C., M. A., Dym-
 church.*
 Cockrom, W., H.M.S. *Eagle*.
 Coffey, P., Tramore, Waterford
 Colby, Nathaniel, Coxswain of
 the Pakefield Life-boat.
 Cole, J., Seaman, Wivenhoe.
 Collard, Mr. S., Pilot.
 Collins, Mr. J., Master of the
 American ship *Roscius*.
 Collison, Mr. R., M. M.
 Collopy, J., C. G.^d, Portcawl.
 Combe, Lt. M., R.N.
 Coneys, Mr. Anthony, Clifden.
 Connick, Mr. J., Dundalk.
 Cooper, Mr. Hugh, C. G.^d,
 Cromaine Point.
 Cooper, Thomas, Sen., Life-
 boatman, Ramsgate.
 Cooper, Thomas, Jun., Life-
 boatman, Ramsgate.
 Coppin, Lt. F., R.N., C. G.^d.
 Corbett, W., Coxswain of the
 Ardmore Life-boat.
 Corbet, P., Pilot, Guernsey.
 Corbett, W., Esq., Isle of Man.
 Cork, W., C. G.^d, Fort George.
 Corkhill, W., Coxswain of the
 Padstow Life-boat. (2)
 Cornish, Lt. J., R.N., Bovis.
 Costello, M., Esq., Rosslare.
 Coul, Alexander, Montrose.
 Coul, Charles, Montrose.
 Cowin, J., Isle of Man.
 Cox, H. L., Esq., Surgeon,
 Army Medical Depart-
 ment.
 Cox, Lt. H., R.N., C. G.^d. (2)*
 Cox, Joseph, Coxswain of the
 Appledore Life-boat. (3)
- Cox, J., Jun., Second Cox-
 swain, Appledore Life-
 boat.
 Cox, W., Kimlora.
 Craggs, J., C. G.^d, Devonport.
 Cragie, J., Coxswain of the
 Southwold Life-boat.
 Cronne, Dennis, Ballycotton.
 Cropper, Peter, Liverpool.
 Crosby, Nicholas, Dundalk.
 Crosswell, Mr. T., Fowey.
 Crouch, J., Broadstairs.
 Crouch, R., Broadstairs.
 Crowden, Mr. J., Chief Officer
 of C. G.^d, at Muchals, N.B.
 Cubitt, Mr. W., Bacton. (2)
 Cubitt, Mr. W. Jun., Bacton.*
 Culner, Mr., C. G.^d, Leigh.
 Cumisky, W. J., Esq., Bal-
 briggan.
 Cummins, Mr. J., Coxswain
 of the Arklow Life-boat.
 Cunningham, Mr. J., New-
 castle.
 Curnow, Mr. Paul, Coxswain
 of the St. Ives Life-boat.
 Curtels, Mr. W., C. G.^d.
 Curtis, Steph., Christchurch.
- Dabine, Lieut., R.N., C. G.^d.
 Dand, M. H., Esq., Hauxley.
 (2)
 Dark, Mr. William, M. M.
 Darling, Wm., Light-house
 keeper, Fern Islands.
 Darling, Grace, his daughter.
 Darragh, H., C. G.^d, Innis
 Bofin.
 Davies, the late Vice-Admiral
 George. (4)*
 Davies, Capt. Thomas, R.N.
 Davies, George, Hoylake.
 Davison, W., Sunderland.
 Dawson, Mr. T., Hartlepool.
 Day, Chr., Middlesborough.
 Day, Mr. Thomas, Bideford.
 Deane, Mr. Henry, C. G.^d.
 Delpierre, Jean A., Boulogne.
 Dent, J., Newbiggin.
 Desmond, John, Limerick.
 De St. Croix, Mr. F., Jersey.*
 De St. Croix, Mr. J., Jersey.*
 De St. Croix, Mr. P., Jersey.*
 Devereux, M., Master Pilot,
 Rosslare. (3)
 Dillon, Jas. C. G.^d, Arklow.
 Dobson, T., Coxswain of the
 Donna Nook Life-boat.
 Donkin, A., Cullercoats. (2).
 Donovan, Dennis, C. G.^d. (2)
 Donovan, J., C. G.^d, Boatman.
 Dooley, Lt. D., R.N., C. G.^d.
 Douglas, Alexander, C. G.^d.
 Dower, Capt. A., Dungarvan.
 Downing, Nicholas B., Esq.
 Drayson, D., C. G.^d.
 Duffy, M., Mullaghmore.
 Dunmore, The Right Hon.
 The Earl of.
 Dunn, Mr. William, M. M.
 Durban, John, Walmer.
 Dyer, B., Seaman, Wivenhoe.
 Dyer, B., Seaman, Wivenhoe.
 Dyer, Lt. H. McNeill, R.N.
 Dyer, Mr. John, Stratton.
- Earle, Lt. E. C., R.N., Rye.*
 Eastaway, R., Boatman, C. G.^d.
 Eddy, R. Pilot, Plymouth. (3)
 Edington, Mr. Chas., C. G.^d.
 Edwards, Mr. D., Montrose.
 Ellis, Henry, C. G.^d, Bude.
 Elphinstone, Geo., Dundalk.
 Else, Lieut., R.N., Fowey.*
 Elton, Lt. W. H., R.N., C. G.^d.
 Elwin, Lt., R.N., Lymington.
 Elyard, Lt. Col. J., 2nd Royal
 Surrey Militia. (2)*
 Erridge, E., Boatman, Deal.
 Essell, Lieut. Wm. F., R.N.*
- Evans, Mr. Daniel, C. G.^d,
 Coxswain of Poolbeg Life-
 boat.
 Evans, Police Constable
 Henry, Carnarvon.
 Evans, Capt. Thomas.
 Evans, Mr. J., M. M., Fish-
 guard.
 Evans, Lieut. Thomas, R.N.
 Evans, T., sen., New Bright-
 ton. (2)
 Evans, T., jun., New Bright-
 ton.
 Evans, Wm., New Brighton.
 Evans, Wm., Pilot, Neath.
 Evison, Lt. J. C., R.N., C. G.^d.
- Farmer, David, Hayling.
 Farrin, Mr. G., H.M.S. *Ajax*.
 Fellowes, Capt. T. H. B., R.N.
 Festing, Lieut., R.N.
 Festing, Colonel Sir F. W.,
 C.B., K.C.M.G., R.M.A.
 Field, Lieut. Wm. Geo., R.N.
 Field, Mr. W., Milford Haven.
 Finlay, G., C. G.^d, Lambay.
 Finlay, William, Montrose.
 Finlay, Chas. E., Coxswain of
 the Ramsgate Life-boat (2)*
 Fish, John, Southwold.
 Fisher, Mr. S., Horseferry-rd.
 Fisher, Mrs., North Ferde
 Islands.
 Fitzjames, Mr., R.N., Euphrates
 Expedition.
 Fitzpatrick, J., C. G.^d, Malin
 Head.
 Flann, Wm., Portland.
 Fleming, George, Gorleston.
 Fletcher, T., C. G.^d, Rosslare.
 Flynn, P., C. G.^d, Kilmish.
 Foley, Mr., M. M.
 Foley, Mr. J., Port Talbot.
 Forbes, Mr. A., Peterhead.
 Formby, Joseph, Formby.
 Forward, Mr. T. R., Com-
 mauder R. C. *Sylvia*.
 Foster, J., C. G.^d, Aldboro'.
 Found, Mr. W., M. M.
 Fowell, John, Seaman.
 Fowler, Mr. James, M. M.
 Fox, Mr. John, Fleetwood.
 Foy, Thomas, Rosslare.
 Frankish, Lt. H., Bridlington.
 Franklin, Lt. E., R.N., Hove.
 Franklyn, Lieut. G., R.N.
 Freeman, Mr. Henry, Cox-
 swain of the Whitley Life-
 boat. (2)
 Freeman, John, Seaman.
 Freeman, James, Helston.
 Freeman, Capt. C. W.,
 R.N.*
 Freney, John, Killiney.
 French, Mr. Charles, C. G.^d.
 Friend, Thos., Life-boatman,
 Ramsgate.
 Fulton, Mr. Robert, R.N.
 Furlong, A., Fishguard.
- Galbraith, Mrs. E., Whitney.
 Gale, Mr. W., M.M., Barking.
 Gallagher, P., Co. Down.
 George, Philip, Coxswain of
 Caister Life-boat.
 Gerrard, Mr. R., Pilot, Fleet-
 wood.
 Giles, Mr. W. M. M., Pad-
 stow.
 Gillespie, Andrew, Gunner.
 Gilmer, Mr. Wm., Dundalk.
 Gilson, Lt. T. A., R.N., C. G.^d.
 Gimar, Mr. E., Master of the
 French brig *Le Normas*.
 Gin, N. François, Boulogne.
 Gleeson, R. F., Wexford.
 Glover, Mr. J., M.M., Gun-
 fleet Sand.
 Goldring, Mr. W., M.M.,
 Hayling.

- Goldsmith, John, Life-boatman, Ramsgate.
 Goldsmith, Richard, Life-boatman, Ramsgate.
 Goldsmith, Stephen, Life-boatman, Ramsgate.
 Gordon, Mr. John, Second Coxswain of the Tyrella Life-boat.
 Goss, Capt. T., R.N., C. Gd. (2)
 Gough, J., Fisherman, Waterford.
 Gould, Lt. Wm., R.N., C. Gd.
 Graham, G., Lt. R.N., C. Gd.
 Graham, Capt. Philip, R.N.*
 Granby, Mr. Charles, M. M.
 Grandy, Mr., of the R. C. *Harry*.
 Grandy, Lieut. S., R.N. (2)*
 Grant, Mr. W., Coxswain of the Margate Life-boat. (2)
 Graves, Mr. J., M. M., Carlisle.
 Gray, A., C. Gd., Fort George.
 Gray, P., C. Gd., Kilmore.
 Gray, Mr. Geo. Bridlington.
 Gray, Mr. J., M. M., Peterhead.
 Gray, E. W. D., Esq., Dublin.
 Gregory, J., C. Gd., St. Andrews.
 Grey, George, Hartlepool.
 Griffith, David, Beaumaris.
 Griffith, Robert, Anglesey.
 Griffiths, Mr. B., M. M., Portmadoc.
 Griffiths, G., Pilot, Anglesey.
 Griffiths, T., C. Gd., Mulsebay.
 Gruer, Wm., C. Gd.
 Guy, Mr. Philip, Bideford.
 Halse, Mr. R., C. Gd.
 Hamilton, Mr. Geo., C. Gd.
 Hamilton, H. A., Esq. (3)*
 Hamono, Mr. A., M. M.
 Hanning, N., C. Gd., Dingle.
 Hansell, P. S., Broadstairs.
 Hansford, John, Weymouth.
 Harrington, Mr. Dennis, Bere Island, Cork.
 Harrington, Mr. Jas., Bridlington Quay.
 Harrington, T., C. Gd.
 Harris, F., Esq., Inspecting Officer, C. Gd., Seafield.
 Harrison, Jacob, Shields.
 Hatch, Mr. N. G., 1st Mate Ship *Berkshire*.
 Hayden, Mr. F., Sandown.
 Headon, Mr. Richard, Coxswain Clovelly Life-boat.
 Heal, J., Fisherman, Atherfield.
 Heard, Rich., Esq., C. Gd.
 Heath, Mr. Joshua, Coxswain of the Fowey Life-boat.
 Heavy, P., Constable, Knock.
 Hein, Mr. F. J., M. M.
 Henin, P., Boulogne-sur-Mer.
 Hennessy, J., C. Gd.
 Henry Lieut., R.N., C. Gd.
 Henslow, Lt., R.N., C. Gd.
 Henwood, T., C. Gd., Fowey.
 Herbert, The Hon. Auberon.
 Herrington, B., Southwold. (2)
 Hick, Mr. M., Scarborough.
 Hicks, Barnard, Scilly.
 Hicks, Geo., C. Gd., Tyrella.
 Hicks, Samuel, Seaman.
 Higgs, S., jun., Esq., the late. (2)
 Higgins, W., Second Coxswain Penzance Life-boat.
 Highland, Owen, Anglesey.
 Hildebrand, H., Esq. Clifden. (2)
 Hill, Mr. J., Coxswain, Newcastle, Dundrum, Life-boat.
 Hill, Mr. W., Mate.
 Hillary, Sir A. Wm., Bart.
 Hillary, Sir Wm., Bt. (4)*
 Hills, W., late Coxswain of the Padstow Life-boat. (2)
 Hippelwhite, Mr. T., M. M., Warkworth.
 Hodgson, J., Carver, Sunderland.
 Hoed, Mr. F. P., M. M., ship *Phenome*.
 Hogben, J., late Coxswain of Ramsgate Life-boat.
 Hogg, Mr. William, C. Gd.
 Holborn, S., Broadstairs.
 Holland, Lieut. John, R.N.
 Holman, Lieut. T., R.N.
 Hood, R., Coxswain of the Seaton Carew Life-boat.
 Hood, Mr. W., Seaton Carew.
 Hook, R., Coxswain of Lowestoft Lifeboat. (2)
 Houghton, H., Hartlepool.
 Howard, Francis, Private, 57th Regiment.
 Howe, R., C. Gd., Ballygerig.
 Howell, Mr. J., Port Talbot.
 Howarth, Capt. Wm., R.N.
 Hughes, E., Sen., Cwmerran.
 Hughes, G., Pilot, Guernsey.
 Hughes, Mr. John, Liverpool.
 Hughes, T., Pilot, Holyhead.
 Hughes, Mr. W., Fisherman, Pittenween, N.B.
 Humphreys, Mr. D., Liverpool.
 Hurry, Mr. Stephen, M. M.
 Huss, Mr. T., H.M.S. *Rover*.
 Hutchinson, Mr. H., C. Gd.
 Hutchison, Lt., Kingstown.
 Hutchison, Lieut. W., R.N.*
 Hyde, James, Scilly.
 Hynds, Mr. John Dundalk.
 Hynes, E., C. Gd., Galway.
 Iles, The late Mr. John, Scarborough.
 Inkster, Mr. Peter, M. M., Shetland.
 James, Lieut. Horatio, R.N.*
 James, Lieut. Wm., R.N.*
 Japp, Robert, Montrose.
 Jarman, Isaac, late Coxswain of Ramsgate Life-boat. (2)
 Jeffers, Rich., C. Gd., Dingle.
 Jefferson, P., Newbiggin. (2)
 Jellard, Mr. John, M. M.*
 Jenkins, L., Pilot, Port Talbot.
 Jenkins, Mr. W., Fishguard.
 Jennings, Mr. Wm., M. M., Harwich.
 Jennings, W., C. Gd., Looe.
 Jesse, Commander R., R.N.
 Jinks, Mr. R., Chief Officer of *Coast Guard, Cardigan*.
 Joachim, Capt., R.N. (4)
 Jobson, Lt. C., R.N. (2)**
 John, Mr. W., Breaksea.
 Johns, Mr. Rich., Mevagissey.
 Johns, Rich., Seaman, Fowey.
 Johns, R. O., Coxswain of the Tramore Life-boat. (3)
 Johns, Mr. W., M. M.
 Johnson, Admiral W. W. P., the late.*
 Johnson, Wm., Yarmouth.
 Johnston, Mr. B., M. M.
 Jones, Capt. C. Gray, R.N., the late. (2)
 Jones, Mr., C. Gd., Wicklow.
 Jones, Mr., C. Gd., Swords.
 Jones, Mr. E., M. M.
 Jones, Henry, Penzance.
 Jones, J., Pilot, Porthcawl.
 Jones, Owen, Anglesey.
 Jones, Lt. R., R.N., C. Gd. (3)**
 Jones, Mr. T., M. M., Port Talbot.
 Jones, Mr. T., M. M., Cardiff.
 Jones, Mr. Thos., Holyhead.
 Joy, Mr. George, M. M.*
 Juniper, Wm., Mundesley.
 Kavanagh, Peter, Coxswain of the Arklow Life-boat.
 Kearon, Capt. Edw., Arklow.
 Kelly, Lieut. E., R.N.
 Kelly, J. M., Appledore.
 Kendall, W., C. Gd.
 Kennedy, Inspecting-Lt. A., R.N., C. Gd., Ballyheige. (2)
 Kennedy, E., C. Gd.
 Kennedy, Mr. H., Belfast.
 Kennedy, Master J., Belfast.
 Kerley, T., C. Gd., Penzance.
 Kerrish, Mr. John, C. Gd.
 Kidd, D., Fisherman, Dundee.
 Kinch, H., Newcastle.
 King, Mr. T., M. M., Harwich.
 King, Lt. S., R.N., Southend.
 Kisbee, Com. Thos., R.N.
 Knight, Mr. Charles, Mate, Ramsgate Steamer *Vulcan*.
 Knight, J. T., C. Gd., Sunderland.
 Kyle, Geo., Assist. Coxswain Holy Island Life-boat.
 Kyle, Matthew, Coxswain Holy Island Life-boat.
 Lake, Mr. A., Chief Officer of C. Gd., Wick, N.B.
 Lambert, John, Harwich.
 Lambeth, Benj., Harwich.
 Landells, Mr. Thos., Milford.
 Lane, Lt., R.N., Dartmouth.
 Langan, Mr. Michael, First Officer of Steamer *Princess Alexandra*.
 Langton, Lieut. T. W., R.N., C. Gd.
 Large, Mr. J., Master Gunner, R.A.
 Larkin, Thomas, Seaman.
 Lavington, Lt. Thos., R.N.
 Lazoix, Lieut. of the French Marine at Dieppe.
 Leask, Mr. Robert, jun., Ireland, near Stromness.
 Leese, Charles, Gunner, R.A.
 Legerton, Mr. Robert, Coxswain of Clacton Life-boat.
 Le Geyt, Miss A. B., Bath.
 Leggett, Edw., Gunner.
 Leigh, Lt. T., R.N., C. Gd. (3)**
 Leslie, Mr. J., M. M., Stonehaven, N.B.
 Lett, Lt. S. J., R.N., C. Gd.*
 Levett, Mr. N., late Coxswain of the St. Ives Life-boat.
 Lewis, E., Seaman, Barmouth.
 Lewis, Mr. G., C. Gd., Newport, Pembroke.
 Lewis, J., Seaman, Harwich.
 Lewis, Mr. Thos., Dundalk.
 Lewis, W., Seaman. (2)
 Lewis, W., Aberystwith.
 Ley, J., Pilot, Mevagissey.
 Liffen, Thomas, Lowestoft.
 Likely Henry, Limerick.
 Linsaker, Mr. Hiram, New Brighton.
 Lindsay, Lieut. A. J., R.A.
 Lindsay, Lieut. Jas., R.N.*
 Lingard, Lieut. J., R.N., Whitby.*
 Lithaby, P., C. Gd., Boatman.
 Llewellyn, Mr. David, C. Gd.
 Llewellyn, M., Fishguard.
 Llewellyn, Mr. Fartha, ditto.
 Lloyd, O., C. Gd., Lulworth.
 Lloyd, Lt. S., R.N., C. Gd.*
 Lose, Mr. John, C. O., C. Gd., Swanage.
 Louchet, L. P. A. B., Anthie.
 Loughor, Rees, Monkness.
 Love, Private Robert, 63rd Regiment.
 Lovell, Patrick, Belmullett.
 Ludlow, Mr. I., Master of the American ship, *Monmouth*.
 Lusk, Mr. A., Raeberry, N.B.
 Lyons, Lieut. Wm., R.N. (2)
 Macalister, Mr. Robt., Wick.
 Macdonald, George, C. Gd.
 Mackay, Mr. James.
 Mackell, Mr. Patrick, C. Gd.
 Mackintosh, Mr. Alex., M. M.
 MacMahon, Capt. H., M. M., East Clare Militia.
 Macnamara, Lt. T., R.N., C. Gd.*
 McArdle, Thomas, Dundalk.
 McCarthy, J., C. Gd., Dundrum.
 McCarthy, Jas., C. Gd., Killrush.
 McCombie, Mr. Thomas, Second Officer of Steamer *Princess Alexandra*.
 McCulloch, K., C. Gd., Ellie. (2)
 McDonald, Mr. Wm., Irvine.
 McGennis, G., barque *Abany*.
 McGladery, Lt. J., R.N., C. Gd.
 McKenzie, J., C. Gd., Galway.
 McKinnon, Mr. J., M. M., Greenock.
 McMillan, J., Kantyre.
 McNamee, P., C. Gd., Dunmanus.
 McNaughten, Neil, C. Gd.
 McQueen, Alex., Seaman.
 Maddick, Mr. H., M. M.
 Manby, Capt. G. W.*
 Manifold, Mr. William, Assist. Coxswain of the Arklow Life-boat.
 Mann, Lieut., R.N., C. Gd.
 Mariote, J. B., French Pilot.
 Mark, Wm., C. Gd., Dingle.
 Markwell, George, Holy Island.
 Marsh, Capt. D., R.N., C. Gd.*
 Marshall, Capt. J., Bideford.
 Marshall, Mr. John, jun., Second Coxswain of the Seaham Life-boat.
 Martin, Mr. Chas., C. Gd., St. Ives, Cornwall.
 Mason, J., C. Gd., Ellie.
 Matthews, Lt. R. B., R.N.*
 May, Mr. A. C., H.M.S. *Rover*.
 May, W. R., C. Gd., Bosccastle.
 Meader, Henry, Life-boatman, Ramsgate.
 Mearns, Wm., Coxswain of Montrose No. 1 Life-boat.
 Mearns, Wm. Jun., Coxswain *Montrose No. 2 Life-boat*.
 Mearns, Mr. R., jun., M. M., Montrose.
 Metherell, Lt. R. R., R.N., C. Gd.*
 Mewse, A., Boatman, Lowestoft.
 Middleton, John, Deal.
 Milburn, John, Shields.
 Milburn, Wm., Isle of Man.
 Miller, J., C. Gd., Devonport.
 Miller, W., Ramsgate.
 Milligan, Mr. G., Yarmouth.
 Mills, C., C. Gd., Clifden.
 Minter, O., Boatman, Deal.
 Mitchell, J., Pilot, Guernsey.
 Mitchell, C., Port Isaac. (2)
 Mittin, Philip, Wexford.
 Moar, Mrs., Burra Ness.
 Monger, Mr. Thomas, Coxswain of Tenby Life-boat.
 Moody, Samuel, Skegness.
 Moody, Samuel, Coxswain of Skegness Life-boat. (2)
 Moore, Gunner Jas., Coast Brigade, Royal Artillery.

- Morone, Mr., Master of the Austrian Barque *Eva*.
Morgan, John, Thurso, N.B.
Morgan, Lt. R., R.N., C. Gd.
Morgan, Mr. T., R.C., *Stork*.
Morris, Capt. J. Row, R.N.*
Morris, R., Seaman, Holyhead.
Morris, Mr. W. E., Port Madoc.
Morrison, Lt., R.N., C. Gd.
Morrison, W., Ballywalter.
Morrison, Mr. Silvester, C. Gd., Sennen Cove.
Mortley, Mr., C. Gd., Padstow.
Mose, J., Boatman, Walmer.
Mudd, Wm., Harwich.
Mulligan, James, Sligo.
Murdoch, Mr. Peter, Glendrisnaig, Ayrshire.
Murphy, James, C. Gd., St. Ives, Cornwall (2).
Murphy, Mr. Adam, Coxswain of Tyrella Life-boat.
Murphy, Mr. Michael, C. Gd., Coxswain of New Romney Life-boat.
Murray, A., C. Gd., Eile.
- Nelson, Mr. W., R.N., C. Gd.
Nepean, Capt. St. Vincent, R.N.
Newham, Lt. N., R.N., C. Gd.
Newsom, Mr. W., M. M., Harwich.
Nichol, Mr. J., M. M., Montrose.
Nicholas, Matt., Coxswain of the Sennen Cove Life-boat.
Nicholson, M., Knock.
Nicolle, Mr. Philip, Jersey.
Norcock, Capt. G. L., R.N.
Norris, Benj., Boatman, Deal.
Norris, Mr. James, M. M.
Norris, Martin, R.N.R.
Norsworthy, Mr. William, C. O. C. Gd., Carnarvon.
Notit, Capt. E. B., R.N. (2)
- O'Neil, Patrick, Scilly.
Orr, Mr. Robt., Irvine, N.B.
O'Shaughnessy, Miss Nora.
O'Sullivan, Mr. M., Bere.
O'Sullivan, D., C. Gd.
Owen, Capt. Wm., Holyhead.
Owen, Mr. William, M. M.*
Owen, Richard, Anglesey.
Owston, Mr. John, Coxswain of the Scarborough Life-boat.
- Page, Mr. Alfred, Master, Ramsgate Steamer *Vulcan*.
Palmer, G., Esq., M.P. (2)**
Parker, Mr. Edw., C. Gd., Mothecombe.
Parker, Mr. J., Flamboro'.
Parker, Mr. Wm., M. M.
Parrott, Mr. R., C. Gd., Tenby (2).
Parry, Lieut., R.N.*
Parry, Mr. Henry, Anglesey.
Parry, Mr. R., M. M., Portmadoc.
Parsons, Lieut. Thos., R.N.
Parsons, Lieut. Rich., H.M. 35th Regiment.
Parsons, Lt. W., R.N., C. Gd.
Partridge, Capt. W. L., R.N., C. Gd.
Pascoe, Peter, Porthleven.
Paul, Thos., C. Gd., Bude.
Payne, Mr. John, C. O., C. Gd., Skerries.
Paynter, Capt. Richard.
Peake, Admiral T. L.*
Peake, James, Esq., H.M. Dockyard, Devonport.*
- Pearce, Rich., Esq., Penzance.
Pearse, Jas. Pilot, Porthcawl.
Pearse, T., Pilot, Porthcawl.
Pear, John, Montrose.
Pedder, Lt. W., R.N., C. Gd.
Peebles, Mr. John, Irvine.
Peebles, Mr. T., M. M., Irvine.
Peiron, S. H., C. Gd., Ballygerig.
Penney, Robert, Ramsgate Life-boatman.
Pepper, J., C. Gd., Lynton.
Perkins, Jas., C. Gd., Bude.
Perrott, Sir Edward G. L., Bart., V.P.*
Petrie, Ellen, Shetland.
Phillips, J., Newcastle, Ireland.
Picard, Mr. P., French M. M.
Pilcher, Mr. Stephen, Coxswain Tramore Life-boat.
Pillar, W., Gunner, H.M.S. *Eagle*.
Pincomb, T., Pilot, Exmouth.
Pitt, E., C. Gd., Atherfield.
Pomeroiy, H., C. Gd., Mevagissey.
Porter, William, Seaman.
Powell, Mr. John, M. M.
Pratt, Lt. Jas., R.N., C. Gd.
Prattent, Lieut. John, R.N.*
Preston, Mr., C. Gd., Newton.
Prewel, R., C. Gd., Kilrush.
Price, Thos., Beaumaris.
Pride, C., C. Gd., Christchurch.
Prior, Lt. T. H., R.N., C. Gd.
Prosser, Mr. H., C. Gd.
Purdy, H., C. Gd., Tyrella.
Puxley, H., Esq., Dunboy.
Pym, Lt. R. E., R.N., Whithy.*
- Quadling, Mr. B. E., C. Gd. (2)*
Quayle, Capt. E., Isle of Man. (2)
Quigley, Mr. W. T., C. Gd.
Quirk, G., Esq., Douglas.
- Rae, Wm., Whitburn.
Randall, Lt. H., R.N., C. Gd., (2)**
Randle, Mr. J., Bristol.
Rawstone, Lt., R.N., C. Gd.
Ray, J., Boatman, Tenby.
Raye, Lieut. H. R., R. M.
Read, Lieut. J., R.N., C. Gd.
Reade, W. M., Esq., Tramore.
Reading, Mr. Daniel, Master of Ramsgate Har. stm. tugs.
Redford, J., Cullercoats.
Rees, Mr. A., Port Talbot.
Rees, Mr. T. M., St. David's.
Rees, Mr. W., Fishguard.
Reeve, Mr. J., Swansea.
Reilly, Patrick, Private, A.S.C.
Regan, D., C. Gd., Kilmora.
Renowden, J., C. Gd., Dingle.
Revell, Edw., Seaman, Ramsgate Steamer *Vulcan*.
Richards, Mr. E., M. M.
Richards, Mr. T., M. M.
Richards, James, Penzance.
Richards, Henry, Penzance.
Richardson, Mr. A., M. M.
Richardson, W., Esq., Coleraine.
Ridge, Capt. G. A. E., R.N.
Ridge, Mr. J., Mate of R.C. *Kite*.
Ridge, Mr. J., C. Gd., Cadgwith.
Rioch, R., C. Gd., Colleston.
Ritche, Mr., Sanda.
Rivers, T., C. Gd., Lydd.
Roberts, Mr. John, Clugwyn.
Roberts, Mr. R., Carnarvon.
Roberts, O., Pilot, Anglesey.
Robertson-Macdonald, Vice-Admiral D.
Robertson, Lieut. R., R.N.*
Robertson, Lt. J. H. M., R.N.
- Robins, Mr. J. Gunn, C. Gd.
Robinson, Mr. J., Aberdeen.
Robinson, Lieut., R.N.
Robinson, T., Whithy.
Rockliffe, W., Southport.
Roderick, E., C. Gd., Dunmanus.
Roderick, J. S., Esq., Ardmore.
Rodgers, J., *Royal Charter*.
Roel, R., Esq., J.P., Lynnmouth.
Rose, W., Boatman, Lowestoft.
Ross, Capt. Sir Thos., R.N.*
Ross, R., C. Gd., Curracloe.
Ross, R., C. Gd., Dunmore.
Rossiter, T., Wexford.
Rothery, Lieut. J., R.N.
Rowe, W., C. Gd., Dingle.
Rowe, W., Scilly.
Rowe, W., Seaman, Helston.
Rowlands, Mr. T., M. M., Newport, Pembroke.
Rowlands, Mr. W., Coxswain, Holyhead Life-boat. (2)
Ruddock, J., Boatman, Fley.
Russell, R., Esq., J.P.
Rutter, Mr. J., Scarborough.
Rymer, Lt. D., R.N., C. Gd.*
- Salmon, C., Fisherman, Gorseleston.
Sanderson, Lieut. J. P., R.N., C. Gd., Bridge of Don.
Sands, Mr. R., M. M., Bahamas.
Sarony, Mr. O., Scarborough.
Sauvage, Mr., French Fishing-boat *Isabelle*.
Sawtell, Mr. Edwin, C. Gd.
Scarlett, R., Harwich.
Scott, Mr. G. R., *Beethoven*.
Scott, Mr. J., M. M.
Scott, Major Henry, Dover.
Selly, W. H., C. Gd., Penzance. (2)
Sergeant, Lt. J., R.N., C. Gd.
Sewell, Lt. H. F., R.N., C. Gd.*
Sewell, Master John, Belfast.
Shanahan, Mr. Michael, Bere Island, Cork.
Shankey, R., C. Gd. (2)
Shannon, P., C. Gd., Kilrush.
Sharrock, J. P., C. Gd., Boscastle.
Shaw, Lt. C., R.N., C. Gd.
Shea, D., Coxswain of the Padstow Life-boat. (3)
Shea, D., C. Gd., Porthcawl.
Sheldon, Robt., Redcar.
Simpson, Mr. Jas., late Mate of Ramsgate H. Steamtugs.
Sims, J., C. Gd., Dungeness.
Sims, Lt. And., R.N. (2)
Sinclair, Mr. B., Thurso, N.B.
Sinnott, R., C. Gd., Mullaghmore.
Smallridge, Mr. J. H., Coxswain Braunton Life-boat.
Smith, F., Boatman, Lowestoft.
Smith, Hy., Pilot, Gloucester.
Smith, J., Shields.
Smith, Mr. J., Thurso.
Smith, Mr. Owen, Bideford.
Smith, Peter, C. Gd., Lydd.
Smith, T., C. Gd., Ballina.
Smith, Wm., Bombardier, R.A.
Smith, Mr. W., Aldborough.
Smyth, H., C. Gd., Kilmora.
Snell, Lt. G., R.N., C. Gd.*
Somerville, Lt. J., R.N., C. Gd. (2)*
Southey, Lt., R.N., C. Gd.
Spark, Mr. A., M. M.
Spraggs, J., Seaman, Hayling.
Stables, R., Holyhead.
Stannard, Mr. F., M. M., Southwold.
Stap, Mr. R., C. Gd., Dunbar.
Stark, Lt. P., R.N., C. Gd. (2)*
Starke, Mr. J., C. Gd., Queens-town.
Steane, Lt. J., R.N., Rye.*
- Steel, Mr. C., C. Gd.*
Steele, John, Esq., Ayr.
Stephens, A., Tramora.
Stephenson, Mr. B., Coxswain of the Boulmer Life-boat.
Stevens, Henry, Gunner R.A.
Stewart, W., C. Gd., Ardmore.
Storr, J., Whithy.
Stone, J., C. Gd., Boscastle.
Stragnell, Lt., R.N.
Strahan, Mr. H., Pilot.
Strains, Mr. J., C. Gd.
Streater, Mr. W. T., H.M. Customs, Shoreham.
Strong, Mr. Fran. F. M.
Stuart, Lt. J., R.N., C. Gd.
Stuart, Lt. T., R.N., C. Gd. (2)
Stubbs, C., Seaman.
Stubbs, H., Atherfield.
Stuggins, Mr. W., Second Coxswain of Teignmouth Life-boat.
Sullivan, J., Newhaven.
Summer, Mr. R., Formby.*
Superville, Mr. M. M., Bordeaux.
Surry, W., Penzance.
Sutherland, D., C. Gd., Katerline.
Sutter, Mr. J., M. M.
Sutton, Mr. C., Port Talbot, M. M.
Swarbrick, Mr. W., M. M.
Symmes, Lt. H. A. S., R.N., C. Gd.*
Synges, The Rev. A., Balbriggan
- Tait, Grace, Shetland.
Talbot, C. R. M., Esq., M.P.
Taylor, J., C. Gd., Dundrum.
Taylor, Mr. W., C. O., C. Gd., Dunny Cove. (3)
Tegg, Mr. T., M. M., Cornwall.
Terrett, T., Constable, F. neck.
Thomas, J., C. Gd., Atherfield.
Thomas, J., C. Gd., *Rocken*, Isle of Wight.
Thomas, R. J., Coxswain of New Brighton Life-boat.
Thompson, D., Thurso, N.B.
Thompson, Mr. G., Annalong.
Thompson, Mr. R., Kirkpatrick, C. O., C. Gd. (3)*
Thompson, W., Apprentice, *Smack Ruby* of Hull.
Thorp, Mr. T., Newcastle.
Tindall, Mr. Smith, M. M., Scarborough.
Tindall, The late W., Esq., Scarborough.
Toole, Capt. W., Curracloe.
Toomey, J., Kingstown.
Torrens, Lieut. John A. W. *O'N. Royal Scots Greys*.
Town, J., C. Gd., Folkestone. (2)
Town, J., C. Gd., Castle-gregory.
Tredwen, Mr. R., Padstow.
Tregldgo, Mr. W. H., C. Gd., Newquay. (3)
Trent, J., Atherfield.
Trestilian, Mr. R.
Triphook, Mr. R., R. C. *Hamilton*, Dumworldly.
Trott, T., Boatman, Deal.
Tuckfield, Mr. T., Bideford.
Tudor, Capt. J., R.N., Wick. (2)
Tully, W., Newcastle. [bar.
Turnbull, R., Fisherman, Dun-
Turner, Lt. C., R.N.
Turner, Mr. Jas., C. O. C. Gd., Leysdown, Kent.
Turpin, Mr. J., C. Gd., Salcombe.
Tutt, E., C. Gd., Dunmanus.
Tuvache, Mr. M. M. French.
- Urell, Mr. Joseph, C. O., C. Gd., Hope Cove.
Usher, Mr. J., Bridlington.

Van Houten, Mr. W., Rotterdam. (2)	Warn, W., sen., Atherfield.	Wheeler, J., ditto. (2)	Williamson, W., Pilot, Wick.
Verion, Chas., Life-boatman, Ramsgate.	Warn, W., jun., ditto.	Wheeler, E., ditto.	Wilson, J., Pilot, St. Andrew's.
Vicary, Lt. W., R.N., Atherfield.*	Warren, Lt. C. D., R.N.	Wheeler, W., Pilot.	Wilson, Mr. J., M. M.
Vondy, I., Isle of Man. (3)	Wasey, Capt. E. F.N. K., R.N. (3)	White, Jas., Coxswain of the Fishguard Life-boat. (3)	Wilson, Ralph, Holy Island.
Waddy, Dr., Churchtown.	Waters, Wm., Southwold.	White, John, Coxswain of the Houth Life-boat.	Wilson, T., Esq., M.P.*
Wade, Mr., M. M., Padstow.	Watt, A., Montrose.	White, Joseph, Portland.	Wilson, T., Pilot, Holy Island.
Wake, Mr. Baldwin Arden, Mid. H.M.S. Forester.	Watts, Lieut. W. S., R.N.*	White, J. Kearney, Esq., C. G ^d . (2)	Wilson, W., Pilot, Holy Island.
Wales, G., Broadstairs.	Watts, Mr. Charles, M. M.	White, J. Kearney, Esq., C. G ^d . (2)	Wishart, J., Wick, N.B.
Wales, J., ditto, ditto.	Watts, Mr. William, M. M.	Whitley, Mr. Elias, Jersey.	Wood, Mr. T. L., C. G ^d . (2)
Walker, Lieut., R.N.	Waugh, E., C. G ^d , Wexford.	Wilds, Mr. Robert, Coxswain of the Deal Life-boat. (2)	Woodham, Lt., R.N., Banff.
Walker, Mr. J., Brigg.	Webbin, J., C. G ^d , Tramore.	Wilkie, Mr. C., M. M.	Woodward, Geo., Stoker, Ramsgate Steamer <i>Vulcan</i> .
Walker, Mr. W. Lewis, Beaumaris. (2)	Webster, Mr. John, Coxswain of Maryport Life-boat.	Willcox, J., C. G ^d , Lydd.	Wortley, S., Harwich.
Wallace, Mr. J., M. M.	Wedge, W., C. G ^d , Salcombe.	Williams, Mr. D., Aberdovey.	Wright, John, Seaman.
Walsh, J., Esq., Lloyd's Agent, Dublin.	Weekes, Wm. Wall, Seaman.	Williams, Mr. H., Coxswain of Kingstown Life-boat.	Wright, Mr. J., M. M.
Walsh, Mr. Martin, M. M.*	Weldrake, E., Spurn Point.	Williams, Mr. J., Swansea.	Wyatt, G., Seaman, Harwich.
Ward, J., R. C. <i>Sylvia</i> .	Welsh, Mr. M., M. M.	Williams, Owen, Cemlyn.	Wyde, Lt. S., R.N., C. G ^d .
Ward, Vice-Admiral J. R.	West, Mr. Wm., C. G ^d , Dymchurch.	Williams, Rev. O. Lloyd. (2)	Wyrill, H., Boat ^r , Scarborough.
Warder, D. T., C. G ^d .	Westbrook, Lieut., R.N.	Williams, Rev. J., Anglesey.*	Yare, Richd., Stoker, Ramsgate Steamer <i>Vulcan</i> .
	Wharrier, Mr. William, Engineer of Ramsgate Harbour Steam-tug. (2)	Williams, Mr. J. M., Padstow.	Young, A., C. G ^d , Shoreham.
	Wheeler, C., Atherfield.	Williamson, Mr. R., M.M. (2)	Young, A. H., C. G ^d , Blatchington.
		Williamson, Robert, Thurso.	Young, Lt. T., R.N., C. G ^d .

THE LIFE-BELTS IN USE BY THE CREWS OF THE LIFE-BOATS OF THE NATIONAL LIFE-BOAT INSTITUTION.



The requisite qualities of a life-boatman's life-belt are—

1. Sufficient extra buoyancy to support a man heavily clothed, with his head and shoulders above the water, or to enable him to support another person besides himself.

2. Perfect flexibility, so as to readily conform to the shape of the wearer.

3. A division into two zones, an upper and lower, so that between the two it may be secured tightly round the waist; for in no other manner can it be confined sufficiently close and secure round the body without such pressure over the chest and ribs as to materially affect the free action of the lungs, impede the muscular movement of the chest and arms, and thereby diminish the power of endurance of fatigue, which, in rowing-boats, is a matter of vital importance.

4. Strength, durability, and non-liability to injury.

The cork life-belts of the NATIONAL LIFE-BOAT INSTITUTION possess the first two qualities in a greater degree than any other life-belt, and the third one exclusively. (*Vide* annexed figure.)

THE LIFE-BOAT STATION.

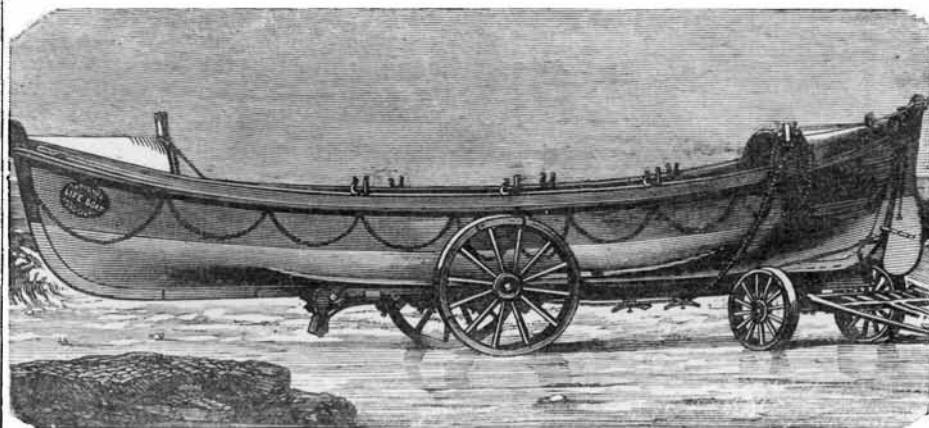

THE following brief description and diagrams illustrative of a complete Life-boat Establishment, including the House for the protection of the boat, will serve to convey an idea of the general character of one of the 271 Life-boat Stations of the NATIONAL LIFE-BOAT INSTITUTION.

It will be seen that it is a work of a costly nature, and that not only in the first instance, but that a large permanent expense is entailed in keeping the whole machinery in an efficient state, in the re-supply of any part of it which may be destroyed or worn out, in the exercise of the boats' crews, in launching and working the boats, and in remunerating them for their services in saving their fellow-creatures. Yet, looking to the vast importance of the result effected, and the responsibility of calling on men to risk their lives in effecting the same, it is felt that few if any persons will be found who will consider that expense to be incurred in vain.

THE LIFE-BOAT.

(See Diagrams on next page.)

The following figures show the general form, the nature of the fittings and air-chambers of one of these boats, 33 feet in length and 8 feet in breadth. In figs. 1 and 2, the elevation and deck plans, the general exterior form of the boat is shown with the sheer of gunwale, length of keel, and rake of stem and stern-posts. The dotted lines of fig. 1 show the position and dimensions of the air-chambers within board, the relieving-tubes, and ballast. In fig 2, A represents the deck, B the relieving-tubes (6 inches in diameter), C the side air-cases, D the end air-chambers, E ballast, F scuttles to admit of a free current of air under the water-tight deck, G scuttle for air, and to receive pump. In fig. 3, the exterior form of transverse sections, at different distances from stem to stern, is shown. Fig. 4 represents a

midship transverse section, A being sections of the side air-cases, B the relieving-tubes, of the same depth as the space between the deck and the boat's floor. c, c, c, c, are spaces beneath the deck, placed longitudinally, at the midship part of the boat, with cases packed with cork, forming a portion of the ballast; *d* scuttle for ventilation, having a pump fixed in it, by which any leakage beneath the deck can be pumped out by one of the crew whilst afloat. The festooned lines in fig. 1 represent exterior life-lines attached round the entire length of the boat, to which persons in the water may cling till they can be got into the boat; the two central lines are festooned lower than the others, to be used as stirrups, so that a person in the water, by stepping on them, may climb into the boat without assistance.

Fig. 1.

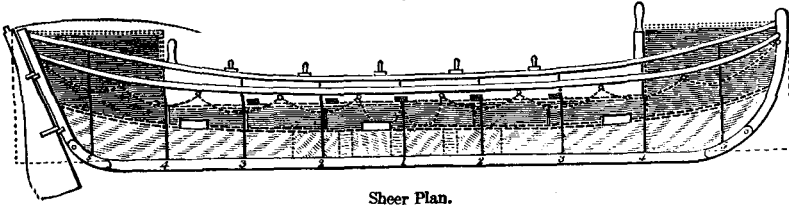

Sheer Plan.

Fig. 2.

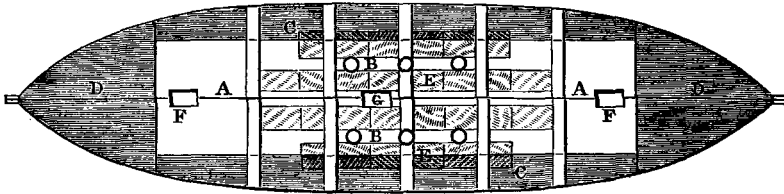

Deck Plan.

Fig. 3.

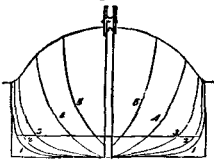

Body Plan.

Fig. 4.

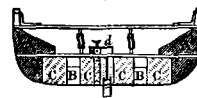

Midship Section.

This Life-boat possesses in the highest degree all the qualities which it is desirable that a Life-boat should possess:—

1. Great lateral stability, or resistance to upsetting.
2. Speed against a heavy sea.
3. Facility for launching and taking the shore.
4. Immediate self-discharge of any water breaking into her.
5. The important advantage of self-righting if upset.
6. Strength.
7. Stowage room for a large number of passengers.



THE LIFE-BOAT TRANSPORTING-CARRIAGE.

The Life-boat transporting-carriage is a very important auxiliary to the boat. Every Life-boat, except a few of the larger size, is provided with a carriage, on which she is kept in the boat-house ready for immediate transportation to the most favourable position for launching to a wreck. A Life-boat is thus made available for a greater extent of coast than she otherwise would be; and even when launched from abreast of the boat-house, can be much quicker conveyed to the water's edge than she could be if not on a carriage. In addition to this ordinary use, a carriage is of immense service in launching a boat from a beach, to that extent, indeed, that one can be readily launched from a carriage through a high surf, when without one she could not be got off the beach.

The carriage consists of a fore and main body. The latter is formed of a keelway, and of side or bilgeways attached to the keelway, and resting on the main axle, the

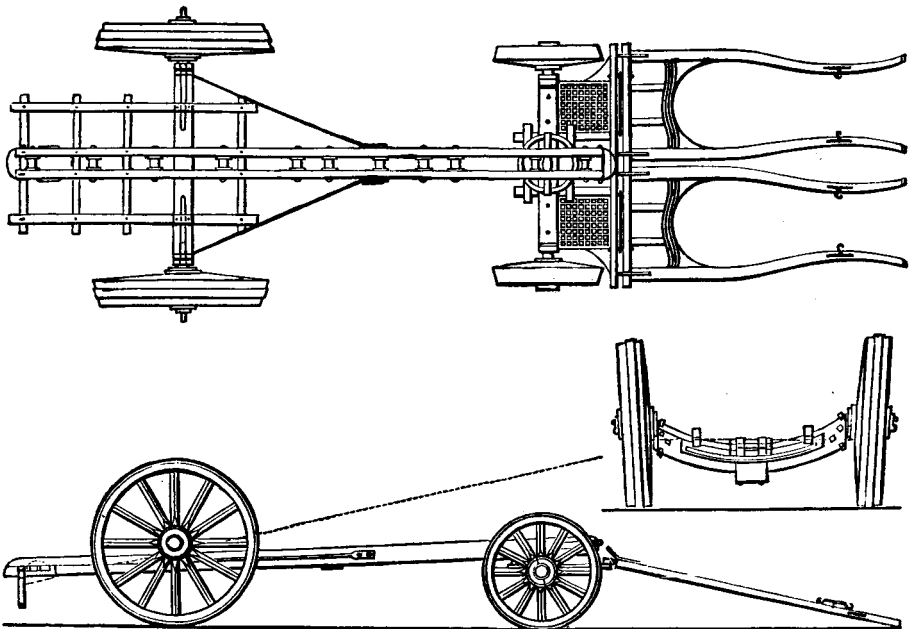

boat's weight being entirely on the rollers of the keelway. Its leading characteristic is that, on the withdrawal of a forelock pin, the fore and main bodies can be detached from each other. The advantages of this arrangement are that, whilst on the one hand the weight of the boat when she is launched from the rear end forms an inclined plane by elevating the keelway and fore-carriage; on the other hand, to replace her on the carriage she can be hauled bow foremost up the fore end or longer incline, by disconnecting the fore-carriage, and letting the end of the keelway rest on the ground, thus forming an inclined plane up which the boat is easily drawn. The bilgeways are needed at the rear end, that the boat may be launched in an upright position, with her crew on board, but they are not required at the fore end of the carriage.

A very full equipment of stores is supplied to the Life-boats of the Institution—such as cork life-belts, anchors and cables, grapnels and lines, life-buoys, lanterns, rockets, and many other articles, together with portable or launching-skids.

THE LIFE-BOAT HOUSE.

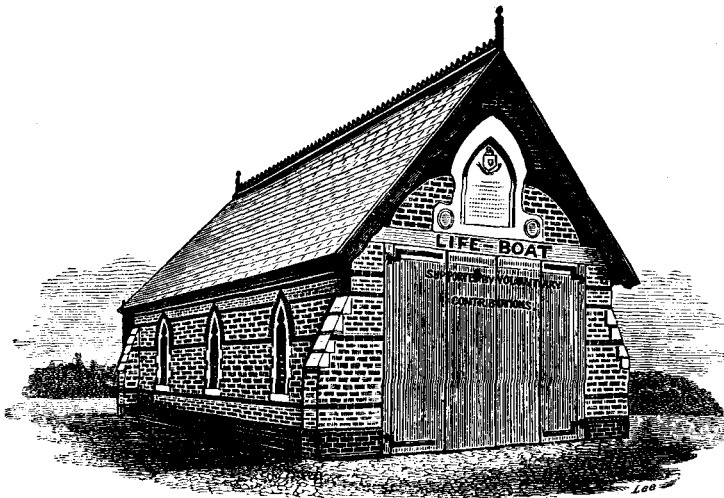

The boats of the NATIONAL LIFE-BOAT INSTITUTION, and all belonging to them, are kept in roomy and substantial boat-houses, under lock and key, in charge of paid coxswains, under the general superintendence of local honorary committees of residents in the several localities. Each boat has its appointed coxswain at a salary of 8*l.*, and an assistant at 2*l.* a year. The crew consists, in addition, of a bowman, and as many boatmen as the boat pulls oars. The members of the volunteer crews are registered, and wherever practicable, at least double the number of men required are entered on the register. Such men are mostly resident boatmen, fishermen, or Coastguardmen. On every occasion of going afloat to save life, the coxswain and each of the crew receive alike from the funds of the Institution (whether successful or not) 10*s.*, if by day, and 1*l.*, if by night; and 4*s.* each for every time of going afloat for exercise.

A reward of 7*s.* is given to the man who first brings intelligence of a wreck at such a distance along the coast as not to be in sight of the Coastguard Station or other look-out.

A flag hoisted by day, and the firing of a carronade (or other alarm signal) by night, are the well-known signals for calling the crew together.

On boarding wrecks, the preservation of life is the sole consideration. Should any goods or merchandise be brought into the Life-boat, contrary to the coxswain's remonstrance, he is authorised to throw them overboard.

The expense of a Life-boat Station averages 1,000*l.*, and is made up as follows:—

Life-boat and her equipment, including Life-belts for the Crew,	
Skids, and Transporting-carriage	£650
Boat-house (average cost)	350
Total	£1,000

The average Annual Expense of maintaining a Life-boat Station is 70*l.*

Such is a brief summary of the chief of the Regulations under which the Life-boats are worked. How faithfully and with what result they are carried out let the journals of each Life-boat Station and the annals of the Institution tell.

The NATIONAL LIFE-BOAT INSTITUTION has now 271 Life-boats under its charge. Every one of these has been specially presented to it, and they save every year from 600 to 700 shipwrecked sailors. Altogether, the Institution has contributed to the saving of 28,724 lives.

Despite, however, this fleet of 271 Life-boats, and of 30 others locally provided and supported, and despite the numerous rocket and mortar stations on our coast, there remains the melancholy fact that an average of 700 lives are lost annually on and around our own shores alone, proclaiming solemnly, though silently, that, for humanity's sake, and for the national credit, no exertions should be spared in providing every possible means for the conveyance of succour to the shipwrecked.

The Institution needs a permanent income of about 40,000*l.* to maintain its great Life-saving Fleet; and the Committee feel assured that it will never lack it so long as it maintains its boats in the state of thorough efficiency that they are in at the present time, and manned as they are on every emergency by as fearless and noble a class of men as ever our Nelsons and Collingwoods led to battle to uphold our country's honour and glory.

LIST OF LEGACIES

PAID TO THE

ROYAL NATIONAL LIFE-BOAT INSTITUTION.

[Legacies of £50 and under are omitted after having been published twice in the Annual Reports.]

	Amount received.		
	£	s.	d.
1871—ABBOTT, JOHN, Esq., Halifax (Free of Duty)	2,078	13	4
1881—ADAMS, Miss ELIZA, Eltham	406	10	0
1868—ALDRED, Dr. G. E., Richmond (Free of Duty)	100	0	0
1880—ALLAN, ROBERT, Esq., Glenhouse, N.B. (Ditto)	500	0	0
1881—ALLSOP, W. G., Esq., Nottingham	121	9	1
1877—ANDERSON, Miss MARGARET, Leamington	450	0	0
1874—ANNANDALE, ALEX., Esq., Bolton, Lasswade, N.B. (Free of Duty)	199	7	6
1866—ANSTICE, GEORGE, Esq., Chipping Norton	90	0	0
1870—ANSTICE, Mrs. ELEANOR, Tynemouth (Free of Duty)	700	0	0
1865—APPLYARD, JOHN, Esq., Halifax	1,800	0	0
1878—ARMSTRONG, THOMAS, Esq., Ore, near Hastings (Free of Duty)	200	0	0
1877—ARNOLD, Miss ANN, Tavistock Hotel, Covent Garden	1,118	1	11
1872—ATTON, ROBERT, Esq., Taunton (Free of Duty)	800	0	0
1878—BACK, Admiral Sir GEORGE, F.R.S.	90	0	0
Ditto (Special Bequest)	180	0	0
1880—BAGLEY, WILLIAM, Esq., Leicester (Free of Duty)	200	0	0
1872—BAKER, Miss ELIZABETH, Stutton, Suffolk (Ditto)	100	0	0
1872—BAKER, Miss HARRIET, Stutton, Suffolk (Ditto)	100	0	0
1875—BARKER, ALEXANDER, Esq., Piccadilly	1,800	0	0
1880—BARNARD, ROBT., Esq., Painswick, Gloucester	100	0	0
1879—BARNICOT, RICHARD, Esq., Dorking (Free of Duty)	200	0	0
1868—BARROW, ROGER, Esq., Newcastle-on-Tyne	90	0	0
1881—BARTRAM, Miss ANN, Hull	19	19	0
1879—BATHO, JOSEPH ALEXANDER, Esq., Brighton	90	0	0
1882—BAX, Mr. EDWARD, Cockspur Street	90	0	0
1867—BEBB, Miss MARTHA, Bootham, York	1,570	16	0
1869—BECKETT, J. S., Esq., Tormoham, Devon	625	10	3
1877—BECKETT, Miss A., Fornham-St.-Martin (Free of Duty)	600	0	0
1879—BECKWITH, Mrs. MARY, Tynemouth (Ditto)	800	0	0
1870—BELL, MATTHEW, Esq., Glasgow (Ditto)	200	0	0
1865—BENNETT, Miss JEMIMA, Sloane Street, Chelsea (Ditto)	90	0	0
1875—BENTINCK, Lady CHARLES CAVENDISH	339	6	0
1875—BERGONZI, Madame, Boulogne (Free of Duty)	200	0	0
1871—BERRY, ARTHUR, Esq., Liverpool (Ditto)	100	0	0
1880—BEST, Mrs. ELEANOR, Kelston Millbrook, Southampton (Ditto)	200	0	0
1874—BEWLEY, JOHN, Esq., Kingsland Road	118	18	4
1880—BIGG, Mrs. ELIZA, Clifton	109	9	7
1859—BIGGS, GEO., Esq., Strand (Free of Duty)	100	0	0
1877—BIGGS, Miss L. M., St. John's Wood (Ditto)	1,000	0	0
1877—BIRKETT, WILLIAM, Esq., Newton-in-Cartmell	720	0	0
1876—BERTWHISTLE, Miss M. A., Cheltenham	900	0	0
1881—BLACK, Rev. A. P., Bow	19	2	11
1879—BOITEFEUR, ALEX., Esq., Bayswater	8,020	6	2
1879—BOLT, ROBT., Esq., Poulton, Gloucester (Free of Duty)	100	0	0
1868—BOLTON, Miss ELIZABETH, Chelsea	415	2	6
1880—BOND, CHARLES, Esq., Potton, Bedford	19	19	0
1860—BOWERBANK, Captain, R.N.	90	0	0
1876-8—BOWLES, Admiral Sir WILLIAM, K.C.B., Hill Street	180	12	0
1877—BOYS, THOMAS, Esq., Hove	5,447	14	9
1879—BRADBERRY, THOS., Esq., Finsbury Park (Free of Duty)	500	0	0
1881—BRADSHAW, Mrs. S. H., Reading	1,356	15	0
1880—BROADHURST, Hon. Mrs. H. M., Richmond (Free of Duty)	300	0	0
1865—BRODIE, Miss, York Place, Portman Square (Ditto)	400	0	0
1869—BRODIE, Mrs. MARY ANN, Harley Street	90	0	0
1868—BROMEHEAD, E. A., Esq., Thornthwaite, Cumberland (Free of Duty)	100	0	0
1879—BROOKES, J. M., Esq., M.D., St. John's Wood	90	0	0
1864—BROWN, Capt. HUGH, Kilmarnock, N.B. (Free of Duty)	99	18	6
1881—BROWN, J. D., Esq., Lynden, Rutland	10	0	0
1881—BROWN, PETER, Esq., Castle Douglas	90	0	0
1869—BROWN, THOMAS, Esq., Ludgate Hill (Free of Duty)	500	0	0
1877—BROWNE, Miss MARY, Liverpool (Ditto)	250	0	0
1867—BROWNRIGG, Dr. THOMAS, Keighley, York	180	0	0
1880-1—BRUCE, Miss JANE ISABELLA, Haddington	1,237	8	0
1871—BURD, Mrs. MARY, Wantage (Free of Duty)	1,500	0	0
1878—BURRELL, Miss F. A., Durham (Ditto)	100	0	0

[Continued.]

LIST OF PAID LEGACIES—*continued.*

	Amount received.	
	£	s. d.
1877—BURY, CHARLES, Esq., Nazing (Free of Duty)	500	0 0
1876-8—CAMERON, Miss E.	1,330	8 10
1877—CAMERON, Miss MARGARET	356	19 11
1864—CAMPBELL, DAVID, Esq., Rothesay, N.B.	107	18 11
1877—CARLILE, Miss H. E., Clifton, Bristol	90	0 0
1880—CAVE, the Right Hon. Sir STEPHEN, G.C.B.	4	4 0
1868—CHAPMAN, Mrs. MARY, Aldborough (Free of Duty)	60	0 0
1876—CHELLINGWORTH, Miss A. W., Upton Bishop (Ditto)	103	19 0
1872—CHORLEY, HENRY F., Esq., Eaton Place West (Ditto)	600	0 0
1858—CHURCH, Miss, Berkeley	90	0 0
1869—CLARK, Mrs. M. E., Addison Road, Kensington	450	0 0
1868—CLAYTON, THOMAS, Esq., Wakefield (Free of Duty)	250	0 0
1877—COATES, P. E. Esq., Stanton Court, Somerset.	450	0 0
1881—COBB, Mrs. M. A., Jersey	1,621	15 9
1881—COHEN, Miss MATILDA, Inverness Terr., Bayswater (Free of Duty)	100	0 0
1855—COLES, B., Esq., Tunbridge Wells	155	18 0
1881—COLLER, Mrs. CAROLINE, Brompton (Free of Duty)	302	6 0
1878—COCKER, C. J., Esq., Ramsgate	449	10 0
1872—COSENS, WILLIAM, Esq., Langdon, Dawlish (Free of Duty)	200	0 0
1870—COSTELLO, DUDLEY, Esq., Acacia Road, St. John's Wood	399	17 3
1881—COURTNEY, Miss A. M.	10	0 0
1882—COWLEY, J. C., Esq., Kilsby	9	0 0
1882—CRADDOCK, C. R., Esq., St. John's Wood (Free of Duty)	100	0 0
1876—CRANHAM, CHARLES, Esq., Audlem, Chester	450	0 0
1872—CROYDEN, Mrs. LUCY, Portswood, Southampton	69	10 8
1863—CURRIE, WILLIAM, Esq., Cornhill	180	0 0
1862—CUTTO, Mrs. ANN, Old Kent Road (Free of Duty)	1,000	0 0
1866—DALTON, RICHARD, Esq., Wigton (Ditto)	100	0 0
1881—DANCE, Miss ANN, Kelso, N.B.	270	0 0
1873—DANFORD, WILLIAM, Esq., Highweek, Devon (Free of Duty)	100	0 0
1868—DANGAR, WILLIAM, Esq., Cheltenham (Ditto)	200	0 0
1872—DAVIDSON, Mrs. ISABELLA, Conway (Ditto)	100	0 0
1857—DAVIES, Miss JANE, Clapham	90	0 0
1872-9—DEAN, W. H., Esq., Stratford.	402	11 2
1867—DEANE, Mrs. MARIA, Cheltenham (Free of Duty)	100	0 0
1880—DEIGHTON, Miss SARAH, Peckham	180	0 0
1874—DEWAR, EBENEZER, Esq., Leith, N.B.	89	8 0
1881—DEWAR, Mrs., Edinburgh	88	8 6
1876—DEWAR, Mrs., Vogrie, N.B. (Free of Duty)	500	0 0
1875—DICKMAN, Captain W. H., R.N., Holloway	368	16 1
1881—DOBSON, Mrs. A. M., Pall Mall	19	19 0
1875—DOLLING, Miss, Shrewsbury	90	0 0
1869—DONCASTER, Mrs. ELIZA, Winthorpe, Nottingham (Free of Duty)	100	0 0
1870—DORSET, Miss SARAH, Reading (Ditto)	100	0 0
1873—DOUGLAS, Miss E. HOUSTON, Eaton Place (Ditto)	250	0 0
1878—DOUGLAS, Mr. JOHN, Skirbeck, near Boston	1,343	6 3
1881—DOWNIE, Miss, Appin, N.B. (Free of Duty)	1,000	0 0
1872—DRUMMOND, Mrs. S. J. DUNDAS, Kensington (Ditto)	2,500	0 0
1832—DUPPA, Mrs., Homerton, Middlesex	1,000	0 0
1873—EDISON, Mrs. H. M. ADEL, Leeds (Free of Duty)	200	0 0
1873—ELWOOD, Mrs. A. K., Clayton Priory, Hurstpierpoint	90	0 0
1877—EVERARD, Miss GRACE, Laverstock, Wilts (Free of Duty)	1,000	0 0
1870—EVANS, ALFRED SMITH, Esq., Edgbaston (Ditto)	500	0 0
1880—EVANS, Mrs. LOUISA, Belgrave Square	19	19 0
1877-8—FAIRLIE, Lady CUNNINGHAM	893	6 2
1879—FARMER, JOHN, Esq., Darlington	270	0 0
1864—FARNELL, JOHN, Esq., Isleworth (Free of Duty)	1,000	0 0
1877—FARTHING, MICHAEL, Esq., Hartlepool (Ditto)	120	0 0
1882—FAWCETT, Mrs. ANN, Norfolk Terrace, W.	450	0 0
1880—FERGUSON, JOSEPH, Esq., J.P., Carlisle	5	0 0
1876—FERGUSON, the Misses, Edinburgh	4,500	0 0
1873—FERNLEY, JOHN, Esq., Southport (Free of Duty)	500	0 0
1874—FINDLATER, ALEXANDER, Esq., Kingstown (Ditto)	200	0 0
1876—FINNIE, JOHN, Esq., Bowden Lodge, near Altrincham	666	13 4
1877—FIRBANK, EDWARD, Esq., Uplyme, Devon (Free of Duty)	1,000	0 0
1880—FIRBANK, Mrs. ANNE, Charlton (3 per Cent. Consols)	908	5 0
1879—FISHER, EDWARD, Esq., Ashby-de-la-Zouch (Free of Duty)	100	0 0
1872—FITCH, Mrs. FRANCES, Bath	500	0 0
1856—FITZGERALD, Captain HAMILTON, R.N., V.P.	9,551	14 2
1864—FITZROY, The Hon. Mrs., Upper Grosvenor Street (Free of Duty)	400	0 0
1879—FLETCHER, G. H., Esq., Carshalton	450	0 0
1879—FOLEY, Miss MARY, Bramley Road, Notting Hill	233	1 6
1881—FORBES, Mr. & Mrs. PETER, Dunsholt, Fife	550	0 0
1880—FORBES, WILLIAM, Esq., Glasgow (Free of Duty)	20	0 0
1881—FORTUNE, Mrs. A. P., Liverpool (Ditto)	200	0 0

[Continued.]

LIST OF PAID LEGACIES—*continued.*

	Amount received.		
	£.	s.	d.
1858—FOSTER, GEO. HOLTGATE, Esq., V.P., Moorgate Street (Free of Duty)	1,000	0	0
1875—FOULSTON, MRS. ELIZA, South Kensington	83	0	6
1869—FOX, ROBERT, Esq., Falconhurst, Kent (Free of Duty)	100	0	0
1878—FOXTON, MRS. C. D., Pendlebury, near Manchester (Ditto)	1,000	0	0
1867—FRITH, MRS. ANNE, Deptford	90	0	0
1868—FYDELL, R. S., Esq., Morcot Hall (Free of Duty)	100	0	0
1873—GARDEN, R. J., Esq., South Kensington	1,193	6	0
1862—GEDGE, Miss ALICE, Great Yarmouth	304	16	0
1876—GIBB, B., Esq., Deptford	90	0	0
1878—GIBBON, L. P., Esq., Pembroke	450	0	0
1875—GIBBONS, MRS. SILLS, Bath (Free of Duty)	500	0	0
1874—GIBSON, Capt. ROBERT, R.N., C.B., Lancaster (Ditto)	100	0	0
1877—GIBSON, Dr. ALEXANDER, Auchenreoch, N.B.	802	16	0
1866—GILBERT, JOHN GRAHAM, Esq., Yorkhill (Ditto)	100	0	0
1877—GILBERT, MRS. JANE GRAHAM, Yorkhill, N.B. (Ditto)	250	0	0
1875—GOADSBY, MRS. M. A., Fallowfield	450	0	0
1875—GODIN, Miss SARAH, Maida Vale (Free of Duty)	100	0	0
1879—GOOCH, JAMES, Esq., Ipswich (Ditto)	100	0	0
1866—GOODMAN, Miss ELLEN, Eversholt	540	0	0
1877—GORDON, Capt. J. A., R.N., Ittingston, N.B.	271	19	2
1868—GORFENKLE, JACOB, Esq., Liverpool (Free of Duty)	500	0	0
1872—GOVEE, Miss ELEANOR, Pimlico (Ditto)	94	9	0
1872—GRAHAM, JOHN, Esq., Ide Hill, Sevenoaks (Ditto)	1,000	0	0
1877—9—GRAHAM, JAMES, Esq., Cornwall Terrace, Regent's Park.	2,500	0	0
1877—GRAHAM, Miss ANN MAXWELL, Williamswood (Free of Duty)	500	0	0
1851—GRANTHAM, MRS. JANE, Altincham, Cheshire	100	0	0
1871—GREENE, JOHN, Esq., Gateshead (Free of Duty)	200	0	0
1877—GRIFFITH, H. DAVIES, Esq., Caer Hûn, Carnarvon (Ditto)	2,000	0	0
1875—GRIFFITHS, Miss REBECCA, Dudley	180	0	0
1874—GRINDLAY, THOMAS, Esq., Edinburgh (Free of Duty)	1,000	0	0
1866—GROVE, WILLIAM CHAFYN, Esq., Mere, Wiltshire	90	0	0
1875—HABERFIELD, Lady, Clifton (Free of Duty)	640	0	0
1868—HALL, Miss LOUISA, Maida Vale (Ditto)	945	0	0
1880—HALL, THOMAS, Esq., Welbeck St., Cavendish Square	1,742	0	3
1867—HALL, WILLIAM JOHN, Esq., Trinity Square	580	11	10
1880—HAMILTON, ADAM, Esq., Glasgow	19	19	0
1873—HAMILTON, Miss MARY ANN, Harrogate (Free of Duty)	200	0	0
1864—HARCOURT, Admiral O. V., Swinton Park (Ditto)	1,000	0	0
1880—HARCOURT, MRS. A. H. DANBY VERNON, Swinton (Ditto)	500	0	0
1881—HARGRAVE, CHARLES, Esq., Bayswater	3,600	0	0
1873—4—HARRIS, Capt. E. W., Roehampton	8,342	8	0
1880—HARRIS, HENRY, Esq., Streatham	900	0	0
1881—HARRIS, MRS. HENRY, Streatham (Free of Duty)	1,000	0	0
1876—HARRISON, Miss H. M. Bath (Ditto)	500	0	0
1868—HARRISON, Miss SARAH, Edge Hill (Ditto)	100	0	0
1834—HAYMAN, MRS., Topsham, Devon	88	0	0
1825—HECKER, JOHN HENRY, Esq., Finsbury Square	1,000	0	0
1860—HEMINGTON, THOMAS FISHER, Esq., Uplyme, Devon (Free of Duty)	100	0	0
1877—HENLEY, MRS. ANN, Plymouth	180	0	0
1881—HENRIKER ALDBOROUGH, J. B., Esq., Catcott, Somerset (Free of Duty)	100	0	0
1879—HINDLEY, Miss ELIZABETH, Heaton Norris	90	0	0
1882—HINKLEY, JOHN, Esq., Derby	45	0	0
1878—HOLTGATE, JOHN, Esq., Burton-in-Lensdale (Free of Duty).	200	0	0
Ditto, for the widows and families of men lost or injured while engaged in Life-boats (Free of Duty).	200	0	0
1865—HOLLINS, Wm., Esq., Over Wallop, Southampton (Ditto)	511	11	6
1880—HOLME-SUMNER, MRS. H. K., Swaffham (Ditto)	100	0	0
1872—HOLME, THOMAS, Esq., City Road	4,545	0	0
1881—HOLT, Col. W. J., Gorphwysfa, Bangor	460	0	0
1867—HOOPER, MRS. MARIANA, Andover (Free of Duty)	100	0	0
1880—HOPE, MRS. ELLEN, Upper Seymour Street	270	0	0
1869—HORTON, Miss MARY ANN, Highbury (Free of Duty)	100	0	0
1865—HORTON, SAMUEL, Esq., Prior's Lee (Ditto)	100	16	10
1872—HOWARD, THOMAS, Esq., Rotherhithe (Ditto)	100	0	0
1874—HOWELL, JOHN, Esq., Cadogan Place (Ditto)	210	13	9
1879—HOYLE, DUNCAN, Esq., Orme Square, Bayswater (Ditto)	1,000	0	0
1868—HUDSON, JOSEPH, Esq., Barrow-upon-Soar	90	0	0
1879—HUGHES, Miss HANNAH, Budleigh-Salterton	214	5	9
1879—HUNT, MRS. MARIA, Hornsey	450	0	0
1873—HYDE, Colonel J. C., Timbercombe Lodge, Somerset (Free of Duty)	247	7	6
1873—INGLEBY, Rev. CHARLES, Cheadle, Stafford (Ditto)	100	0	0
1880—INGO, JOHN, Esq., Gosforth, Northumberland (Ditto)	50	0	0
1877—IRLAM, GEORGE, Esq., North Row, Park Lane (Ditto)	1,000	0	0
1867—IRLAM, Miss MARIA, Dibbinsdale (Ditto)	1,000	0	0

[Continued.]

LIST OF PAID LEGACIES—*continued.*

		<i>Amount received.</i>		
		£	s.	d.
1876—	IRVINE, Mrs. S., Geneva	270	0	0
1878—	JACKSON, Miss A. C., Croydon (Free of Duty)	100	0	0
1877—	JEFFERSON, EDWARD, Esq., Pontefract (Ditto)	400	0	0
1875—	JEREMY, Mrs. C. A., Axminster (Ditto)	1,000	0	0
1863—	JOLLY, Mr. JOHN, Farmer, Eastone, Oxford	189	0	0
1868—	JONES, CHARLES WILLIAM, Esq., Norwich	180	0	0
1879—	JONES, EDWARD, Esq., Port Hope, Ontario	611	5	11
1880—	JONES, Mrs. LUCY, Woburn	10	0	0
1861—	JUDKIN, J. R., Esq., Hackney (Free of Duty)	105	0	0
1870—	J. L., Esq., Horsham	450	0	0
1864—	KEATE, Miss EMMA, Kensington (Free of Duty)	300	0	0
1869—	KEMP, Miss E. S., City Road (Ditto)	100	0	0
1878—	KENDALL, Wm., Esq., Exeter (Ditto)	1,000	0	0
1877—	KENDRICK, Mrs., Philpot Street (Ditto)	100	0	0
1875—	KERR, MALCOLM, Esq., Glasgow (Ditto)	250	0	0
1881—	KING, Mrs. ARABELLA, Kentish Town (Ditto)	50	0	0
1868—	KINGSTON, FRANCIS HOUSE, Esq., Harpenden	432	2	0
1874—	KIPLING, Mrs. S. E., Kentish Town	450	0	0
1874—	KIRBY, Mrs. F. S., Dublin	180	0	0
1880—	KIRKPATRICK, Mrs. HARRIET SUTTON (Free of Duty)	100	0	0
1864—	KITCHING, JOHN, Esq., Stamford Hill (Ditto)	100	0	0
1872—	KNIGHT, Miss MARIA, Hathern, Leicester	90	0	0
1875—	LAMBERT, JAMES, Esq., Alloa, N.B.	502	11	6
1880—	LANDSEER, CHARLES, Esq., R.A., St. John's Wood (Free of Duty)	500	0	0
1880—	LANDSEER, Miss JESSIE, Kensington Park Gardens (Ditto)	100	0	0
1882—	LE CAPPELAIN, J., Esq., Highgate (Ditto)	100	0	0
1877—	LEE, Miss MARY, Foleshill, Warwickshire (Ditto)	250	0	0
1872—	LEEVEES, EDWARD, Esq., Venice (Ditto)	100	0	0
1876—	LEWTHWAITE, Miss SARAH, Bowdon, Chester	450	0	0
1877—	LEWTHWAITE, Miss F. J., Colton, Lancashire (Free of Duty)	200	0	0
1876—	LIDDELL, HENRY, Esq., Kingston-upon-Hull (Ditto)	100	0	0
1870—	LLOYD, CHARLES, Esq., Kennington (Free of Duty)	500	0	0
1876—	LONG, Miss CATHERINE, Chipping Norton	172	16	6
1876—	LONSDALE, HENRY, Esq., M.D., Carlisle	90	0	0
1864—	LOWE, SAMUEL J., Esq., Shadwell	871	15	0
1880—	LUPTON, Miss MARY, Broughton, Lancaster (Free of Duty)	103	16	0
1862—	LUPTON, WILLIAM, Esq., Salford (Ditto)	100	0	0
1872—	LYON, Mrs. JANE, Knightsbridge (Ditto)	500	0	0
1869—	MACKIE, Dr., Greenock	359	12	5
1864—	MACNAB, JAMES, Esq., Guildford (Free of Duty)	99	4	6
1879—	MACNAMARA, Admiral Sir BURTON, Kingstown	525	3	0
1864—	MAGENIS, F. R., Esq., Grosvenor Place (Free of Duty)	1,000	0	0
1881—	MAHONY, Dr. MONTAGUE MARTIN, Chelsea	7,646	1	3
1875—	MARKLAND, Miss ELLIN, Notting Hill (Free of Duty)	200	0	0
1875—	MARSHALL, ROBERT, Esq., Edinburgh	270	0	0
1881—	MARTIN, Miss CHARLOTTE, Lowestoft	10	0	0
1879—	MASON, Miss ELIZABETH, Necton	900	0	0
1877—	MAY, Dr. H. S., Exeter	180	0	0
1869—	MCALLEY, WILLIAM, Esq., Stirling, N.B.	99	1	10
1874—	McKINNELL, or HANNAY, Mrs., Kirkcudbright, N.B.	91	11	0
1881—	McMASTER, E. C., Esq.	12	10	0
1872—	MEREDITH, Mr. THOMAS, Edgware Road	52	10	0
1874—	METGE, PETER PONSONBY, Esq., Athlumney, Navan	180	0	0
1881—	MEYER, Mr. CECIL, Upper Norwood	2	2	0
1871—	MEYNELL-INGRAM, Miss LOUISA E., Hoar Cross (Free of Duty)	300	0	0
1871—	MEYRICK, STANTON, Esq., Brompton	611	7	6
1863—	MILLER, JAMES, Esq., Glasgow (Free of Duty)	100	0	0
1878—	MILLOTT, Miss EMILY, Pendleton, near Manchester (Ditto)	100	0	0
1877—	MITCHELL, JAMES, Esq., Kincairney, N.B. (Ditto)	506	5	0
1881—	MONK, Capt. JOHN, R.N., Neston, Cheshire (Ditto)	500	0	0
1864—	MONTAGU, Captain M., R.N., Bath (Ditto)	98	13	4
1865—	MORGAN, Mrs., Cheltenham (Ditto)	204	11	10
1876—	MORRIS, Mrs. C. H., Hammersmith	463	14	4
1877—	MOSTYN, T. A. B., Esq., St. James's Place (Free of Duty)	100	0	0
1875—	MYTTON, Miss C. H. A., Shelton, near Shrewsbury	450	0	0
1868—	NAYLOR, WILLIAM, Esq., Twickenham (Free of Duty)	500	0	0
1871—	NEALE, Miss, towards "Pendock Neale" Life-boat	£246	16	7
1872—5—	Also donations from Miss HERRING, Newport, for same Life-boat, in memory of departed friends	353	3	5
		600	0	0
1876—	NEWEN, GEORGE, Esq., Cambridge Terrace (Free of Duty)	100	0	0
1881—	NICHOLS, Miss CHARLOTTE, Finsbury Park (Ditto)	785	6	0
1878—	OVEY, Miss JANE, Henley-on-Thames (Ditto)	500	0	0
1867—	OXENHAM, Miss C. N., Kensington	180	0	0

[Continued.]

LIST OF PAID LEGACIES—*continued.*

	Amount received.		
	£	s.	d.
1881—PACKER, CHAS., Esq., Regent Street (Free of Duty)	100	0	0
1875—PARK, WILLIAM, Esq., Torwoodhill, N.B. (Ditto)	148	18	5
1875—PARK, MRS. Do. Do.	500	0	0
1877—PARKER, MRS. M. D., Whippingham, Isle of Wight (Ditto)	300	0	0
1881—PARKIN, WM., Esq., Louth	100	6	8
1881—PARMETER, R. W., Esq., Cambridge	19	19	0
1880—PECK, MRS. AMELIA KEZIA, Plymouth (Free of Duty)	250	0	0
1857—PETERSON, Miss MARIA, Bromley	90	0	0
1876—PHELPS, MRS. MARGARET, Chichester (Free of Duty)	101	18	3
1876—PICKERSGILL, H. W., Esq., R.A., Blandford Square	900	0	0
1881—POLLARD, JOHN, Esq., Holker Cartmel, Lancaster	47	18	0
1879—POPHAM, MRS. J. E. M., Ardhattan, N.B.	464	8	7
1880—PRICE, ALLIN FOOD, Esq., M.D., Deptford (Free of Duty)	100	0	0
1830—PRIOR, WILLIAM, Esq., Herne Hill, Camberwell.	1,827	14	8
1880—PRYOR, MRS. ELIZABETH, Redruth, Cornwall	6	15	2
1880—PYCOCK, Miss JANE, Howden, York (Free of Duty)	50	0	0
1879—RADCLIFFE, H. J., Esq., Eastbourne	520	14	5
1875-6—RANDELL, JAMES, Esq., Mark Lane	483	15	11
1874—RATTRAY, Miss MARY GRAY, Tavistock Square	200	0	0
1867—RAWSON, Miss MARIA, Sheffield	90	0	0
1876—RAYMENT, MRS., Dartford (Free of Duty)	100	0	0
1881—REARDON, Miss ELLEN, Islington	5,331	19	5
1874-5—REEVE, JOHN, Esq., Reading (Ditto)	948	15	0
1848—RENNELL, THOMAS THACKERAY, Esq., Enfield	360	0	0
1880—RHODES, W. B. Esq., Hounslow	27,779	2	9
1881—RICHARDSON, MR. BENJAMIN, Gosberton, Lincoln	2	0	0
1869—RICHARDSON, MRS. HARRIETT, Greenwich	4,412	0	6
1874—RICHARDSON, Miss MARY, Edinburgh (Free of Duty)	500	0	0
1877—RIDEOUT, W. J., Esq., Charles Street, Berkeley Square (Ditto)	1,000	0	0
1876—RIGDEN, the Misses, Chepstow (Ditto)	100	0	0
1877—ROBERTSON, CHARLES, Esq., Long Acre	450	0	0
1870—ROBERTS, JOHN, Esq., Mornington Road (Free of Duty)	200	0	0
1882—ROBERTS, RICHARD, Esq., Blackley, near Manchester (Ditto)	600	0	0
1873—ROBERTSON, MRS. M. J., Kelso, N.B.	450	0	0
1881—ROBINSON, MR. ANTHONY, Whitcombe Street, Haymarket	0	10	0
1863—ROBINSON, MR. THOS., Cheetham, Manchester	189	0	0
1879—ROE, MRS. MARY, Nutley, Co. Dublin (Free of Duty)	400	0	0
1870—ROLLESTON, MRS. HARRIET, Swindon (Ditto)	450	0	0
1874—ROYOU, WILLIAM, Esq., Tottenham	501	11	11
1881—RUDGE, W. N., Esq., South Audley Street (Free of Duty)	1,000	0	0
1874—RUSSELL, Lady FRANKLAND, Thirkleby, Yorkshire	106	19	8
1869—SCOTT, SAMUEL, Esq., Cavendish Square (Free of Duty)	1,000	0	0
1853—SELL, MR. CHARLES, Hoxton	66	2	11
1867—SHARPE, Miss JANE, Whitburn	89	6	8
1866—SHAW, JAMES DAVIDSON, Esq., Newcastle-on-Tyne	449	1	8
1879—SHAW, JAMES, Esq., Brighton (Free of Duty)	100	0	0
1881—SHEPHERD, ROBT., Esq., Rochdale	900	0	0
1876—SHEPPARD, FREDERICK, Esq., Folkington, Sussex (Free of Duty)	2,000	0	0
1868—SILVER, THOMAS TEMPLE, Esq., Woodbridge (Ditto)	650	0	0
1868—SINCLAIR, DAVID, Esq., Thurso (Ditto)	100	0	0
1869—SINCLAIR, WILLIAM, Esq., Sowerby, York (Ditto)	138	18	3
1874—SKURRAY, W. H., Esq., Leamington	1,155	12	4
1863—SLADE, FELIX, Esq., Lambeth (Free of Duty)	300	0	0
1866—SMALL, MRS. SARAH, Brighton	76	7	6
1865—SMITH, Miss ANN FRANCES, Greenwich	50	15	0
1875—SMITH, JOHN, Esq., Hull (Free of Duty)	200	0	0
1867—SMITH, MRS. MARY ANN, Greenwich (Ditto)	1,000	0	0
1875—SMITHMAN, JOHN, Esq., Hertford	90	0	0
1880—SOMERVILLE, Miss MARTHA CHARTERS, Genoa (Free of Duty)	2,500	0	0
1864—SPENCER, RICHARD, Esq., Gower Street	180	0	0
1880—SPURRELL, Miss CHARLOTTE, Brompton, Norfolk	90	0	0
1881—STANFORD, J. F., Esq., North Bank, Regent's Park	4,500	0	0
1878—STAINTON, J. J., Esq., Meadowcroft, Lewisham	107	8	10
1874—STANNAH SAMYNTAS, Esq., Gower Street	450	0	0
1873—STANTON, WILLIAM, Esq., Bramly Wharf, Surrey	473	17	5
1875—STEAD, MRS., Helensburgh (Free of Duty)	100	0	0
1876—STONE, RICHARD, Esq., Ulceby, Lincolnshire	101	11	1
1866—STORY, MRS. MARY ANN, Kensington (Free of Duty)	500	0	0
1870—STUART, CHARLES, Esq., Norfolk Street (Ditto)	200	0	0
1865—STUBBS, THOMAS, Esq., Hulme, Manchester (Ditto)	500	0	0
1869—STURM, JAMES, Esq., High Holborn (Ditto)	500	0	0
1865—SYKES, Capt. JOHN, R.N., Bolsover Street (Ditto)	100	0	0
1878—SYKES, MRS. ANN ELIZABETH, Butcharlyp, How Grasmere (Ditto)	600	0	0
1881—"T. J. M." (Ditto)	400	0	0

[Continued.]

LIST OF PAID LEGACIES—*continued.*

	Amount received.		
	£	s.	d.
1871—TANCRED, J. J., Esq., Pearville, Co. Dublin (Ditto)	1,350	0	0
1866—TAYLOR, THOMAS TRAVERS, Esq., Southport (Ditto)	500	0	0
1879—THOMAS, MISS LOUISA, Bowden, Chester	900	0	0
1881—THOMAS, MRS. FANNY E., Nunney, Somerset	7	17	0
1874—THOMPSON, JOHN, Esq., Nottingham (Free of Duty)	500	0	0
1859—THOMPSON, MRS. ANN, Greenwich	82	8	1
1865—THORNTON, RICHARD, Esq., Old Swan Wharf (Free of Duty)	2,000	0	0
1875—TOMPKINSON, THOS., Esq., Bath	90	0	0
1880—TOMLINSON, JOHN, Esq., Walkerith, Lincoln	15	0	0
1882—TOWER, MISS JANE, Edinburgh	25	2	1
1881—TRAVIS, MISS ANNE, Moston, Lancaster	31	10	9
1866—TRAVIS, SAMUEL, Esq., Cheltenham (Free of Duty)	100	0	0
1873—TREDWELL, WM., Esq., Handsworth, Staffordshire (Ditto)	105	0	0
1878—TROWELL, WM., Esq., Fletton, Hunts (Ditto)	100	0	0
1869—TUCKETT, MISS LUCRETIA, Osnaburgh Street (Ditto)	100	0	0
1880—VANDELEUR, RICHD. J. O., Esq., Dublin	448	19	0
1863—VENABLES, THOMAS ARUNDEL, Esq., Worcester	450	0	0
1872—WALDRON, MISS MARIA, Trowbridge (Free of Duty)	100	0	0
1867—WALKER, CHARLES, Esq., Southport (Ditto)	100	0	0
1870—WALKER, MISS MARY, Coates, N.B. (Ditto)	500	0	0
1869—WALKER, MRS. MARY ANN, Onslow Square (Ditto)	500	0	0
1879—WALLACE, WM., Esq., Curtain Road, Shoreditch	550	19	4
1872—WALMESLEY, MRS. C. E., Connaught Square (Free of Duty)	300	0	0
1869—WARNER, MRS. ANN, Lyncombe, Somerset	224	10	0
1869—WARNER, MISS ELIZABETH SOPHIA (Free of Duty)	350	0	0
1876—WATKINS, Capt. W., R.N., Croydon (Free of Duty)	100	0	0
1871—WATSON, MRS. ELIZA, Loughton, Essex (Ditto)	100	0	0
1861—WATSON, MRS. WILHELMINA, Berwick-on-Tweed	450	0	0
1864—WEBSDALE, W., Esq., Ipswich (Ditto)	79	16	0
1880—WEDGWOOD, MISS S. E., Down, Kent (Ditto)	100	0	0
1862—WEST, Dr. CHARLES TURNER, Hull	90	0	0
1879—WEST, RICHARD THORNTON, Esq., Streatham Hall, Exeter (Free of Duty)	500	0	0
1864—WHEELHOUSE, G., Esq., Deptford (Ditto)	260	0	0
1880—WHITE, MRS. ANN, Brockley	90	5	0
1877—WHITTINGHAM, MRS. J. P., Manchester Street, Manchester Square	303	4	4
1875—WILLIAMS, MRS. ROBINA, Edinburgh (Free of Duty)	1,000	0	0
1877—WILLIAMS, C. T. LLOYD, Esq., Cheltenham	540	0	0
1870—WOOD, MISS MARY ANN, Bath (Free of Duty)	100	0	0
1877—WOOD, GEORGE, Esq., Chelsea (Ditto)	1,000	0	0
1875—WOODBURN, MISS MARY FRANCES, Kensington Park Gardens	270	0	0
1875—WOODHOUSE, MRS. S. D., Upper Grosvenor Street (Free of Duty)	127	13	3
1880—WOODWARD, MISS MARY, Sproughton, Suffolk (Ditto)	1,500	0	0
1879—WOODWARD, MISS SARAH, Oldham Place	1,800	0	0
1879—WRIGHT, MISS M. A., Cottingham, York	268	19	0
1875—WRIGHTSON, MRS. C. R., York	180	0	0
1875—YATES, MRS. HANNAH, Sheffield	900	0	0
1882—YOUNG, Major ROBERT WALKINSHAW, Dunmore, Kinn, N.B.	250	0	0

FORM OF BEQUEST OF MONEY, STOCK, OR OTHER PERSONAL ESTATE.

I give and bequeath to the ROYAL NATIONAL LIFE-BOAT INSTITUTION for the Preservation of Life from Shipwreck, founded in 1824, London, the sum of £ _____ *for the use of the said Institution; and I do hereby direct that the same be paid exclusively out of such part of my Personal Estate as may lawfully be appropriated to such purpose, and that the receipt of the Treasurer for the time being of the said Institution shall be a sufficient discharge to my Executors for the same.*

ROYAL NATIONAL LIFE-BOAT INSTITUTION,
14 John Street, Adelphi, London,
1st May, 1882.

LIST OF DONATIONS AND ANNUAL SUBSCRIPTIONS.

* * Donations of £5 and under are omitted after having been published *once* in the Report.

HER MOST GRACIOUS MAJESTY THE QUEEN (Annual, £50) (1858) £100 0 0
HIS ROYAL HIGHNESS THE PRINCE OF WALES, K.G. 135 0 0

	Ann. Subs.		Donations.			Ann. Subs.		Donations.	
	£.	s. d.	£.	s. d.		£.	s. d.	£.	s. d.
A. (1881)			5	0 0	Addison, Mrs. (New Brighton)	2	2 0		
A. B., Penryn (1872-81)			10	0 0	Agar, W. T., Esq. (1870-80)	30	0 0		
A. C., Croydon (1859-81)			125	0 0	Aidam, William, Esq.	1	0 0		
A. C., In Memoriam (1871)			20	0 0	Alexander, Jas., Jun., Esq. (1880)	10	10 0		
A. C. S. (1875)			10	0 0	Alexander, T. H., Esq. (1873-5)	21	0 0		
A. D. M., Mrs., born Hawkins, in memory of two Officers Indian Army (Madras), Hawkins and Spinks (many years deceased) (1876)			1,000	0 0	Alexander, The Misses	1	1 0		
A. L., Cheltenham (1863-81)			90	0 0	Allen Bros. and Co., Messrs.	1	1 0		
A. L., Clapham	1	1 0			Allen, C. F. R. Esq. (1869-76)	10	0 0		
A. L., A. W., M. W., and A. A., Wimbledon (1877-81)			56	4 3	Allen, Francis, Esq., Alexandria	5	0 0		
A. M. B. (1877)			10	0 0	Allen, Hanbury, & Co. Messrs.	1	1 0		
A. M. T. (1878-82)			1	0 0	Allen, J., Esq., Cornhill	1	1 0		
A. M. T. (1882)			2	0 0	Allen, Murray, & Co., Messrs.	1	1 0		
A. S. W. (1875-82)			41	10 0	Alloa Branch (1882)	52	15 2		
A few friends, per Jas. Lahy, Esq. (1882)			2	2 0	Airutz, & Co., Messrs.	1	1 0		
A Friend (1872)			15	0 0	Alston, Chas. H., Esq.	2	2 0		
A Friend (1881)			5	0 0	Alston, Hamilton, & Co. Messrs.	1	1 0		
A Friend (1882)			7	10 0	Ames, A. M., Esq., Bow (1881)			0	10 0
A Friend at Cirencester (1882)			0	10 0	Amos, Mrs. M., St. Ibbs	1	1 0		
A Friend at Horncastle (1877-81)			6	0 0	Amos, Robt., Esq., Texas, U.S.	1	0 0		
A Friend at Leominster (1869-78)			37	0 0	Amphlett, Rev. J.	1	1 0		
A Friend at Llangollen	1	0 0			Anderson, C. A., Esq., Waverley Abbey	2	2 0		
A Lady, per J. B. Parker (1863-73)			135	0 0	Anderson, Dr. Robt. (1881)			0	10 6
A Lady, per W. H. Moore, Esq. (1876)			10	0 0	Anderson, Mrs. J., Dalhousie	2	2 0		
A Lady (1880)			20	0 0	Anderson, Robt., Esq., Ar- broath	1	1 0		
A Mother whose Son was Lost at Sea (1869-74)			12	0 0	Andrews, Capt. (1881) in aid of "Hey- land Memorial Life-boat"			0	10 0
A New Year's Gift for the Life-boat, Oxford (1882)			1	0 0	<i>Andrina</i> , V., Austrian barque, Under- writers of the cargo of the (1879)	26	5 0		
A Shipowner, Greenock	5	0 0			An old Sailor, Native of Faversham, now of Canada (1875)	40	0 0		
A Sufferer on Shore (1881)			0	10 0	Anonymous	1	1 0		
A Thank-offering for a Son's preserva- tion at Sea (1870)			10	0 0	Anonymous (1872)	10	0 0		
Ditto, for safe return of Sons from long Voyages (1874)			10	0 0	Anonymous (1873-4)	10	0 0		
A Thank-offering from F. R. A. (1879)	100	0 0			Anonymous (1874-6)	350	0 0		
A Thank-offering from G. A. N. (1882)	10	0 0			Anonymous, "W." (1878)	100	0 0		
A Thank-offering from T. H. L. (1867-76)	54	0 0			Anson, Miss, Chester (1875-81)	35	0 0		
A Thank-offering ("Let not the deep swallow me up") (1871)	25	0 0			Antrobus, Hugh Lindsay, Esq., <i>Treasurer</i> (1878)	10	10 0		
A Well Wisher and Regular Subscriber (1880)	30	0 0			Antrobus, Miss C. H. (1865-79)	17	4 0		
Aberdeen Branch (1882)	74	0 0			Ditto	2	0 0		
Ackers, Mrs., Moreton	5	0 0			Appach, T. H., Esq. (1880)	31	10 0		
Acland, Sir T. Dyke, Bart., M.P. (1875)	10	0 0			<i>Archer</i> , J., Esq.	1	1 0		
Acocks Green, Yardley and Olton Branch (1882)	40	19 0			Androssan Branch (1882)			10	0 0
Acton, Miss, Teston (1879-82)	6	10 0			Arbroath Branch (1882)			6	0 0
Adam, E., Esq., Kilmarnock (1881)	2	1 0			Arkwright, J. C., Esq.	1	1 0		
Adam, Messrs. John and James and Co.	1	1 0			Armitage, E., Esq., R.A.	1	1 0		
Adams, A., Esq., Skelwith	0	10 0			Armitage, Miss H., Bath	1	1 0		
Adams, Edgar T., Esq., Hal- stead	1	1 0			Armourers & Braziers, Wor- shipful Company of (1882)			10	10 0
Adams, Mr. J., Brecknock Rd.	0	10 6			Armstrong, Henry, Esq.	1	1 0		
Adams, R., Esq., St. Ives	1	1 0			Armstrong, Sir W. G., F.R.S.	1	1 0		
Adamson, A., Esq.	1	1 0			Artill, J. D., Esq.	0	5 0		
Adamson & Co., Messrs. D., Blyth	1	0 0			Ash, Hy., Esq., Weston	0	10 0		
Addington, Mrs. Henry (1873)	10	0 0			Ash, W., Esq., Weston	0	10 0		
					Ashby, James, Esq.	0	10 6		
					Ashmole, Wm., Esq., Ilford	1	1 0		
					Ashwood, John, Esq.	1	1 0		
					Astell, Mrs. H. D. (1866-73)			13	10 0
					Astley, Miss, Princes Gardens	2	0 0		
					Atkinson and Co., Messrs.	2	2 0		
					Atkinson, G. C. W., Esq.	2	2 0		
					Atkinson, Lieut.-Col. Ralph (1873)	10	0 0		

	Ann. Subs.		Donations.			Ann. Subs.		Donations.	
	£.	s. d.	£.	s. d.		£.	s. d.	£.	s. d.
Atkinson, W., Esq., Beckenham	1	1	0	0	Barron, W. T., Esq.	1	1	0	0
Attenborough, R., Esq., Sawtry	1	0	0	0	Barrow, A. M., Esq.	1	1	0	0
Attwell, T. M., Esq.	1	1	0	0	Barry, F. T., Esq., for the barques <i>Mertola</i> & <i>Umgeni</i>	2	2	0	0
Auerbach, Emil, Esq.	1	1	0	0	Barton, Bertram F., Esq. (1873-81)	21	0	0	0
Auldjo, Henry, Esq., Cowes (1851-82)	49	17	0	0	Barton, Daniel, Esq. (1868-73)	20	10	0	0
Austin, F., Esq., Aubert Park (1880)	2	2	0	0	Barton, Mrs. Hope (1881)	15	0	0	0
Austin, G., Esq., London St.	1	1	0	0	Bastard, T. Horlock, Esq.	1	0	0	0
Austin, Mrs., Clifton	1	1	0	0	Bates, Brian, Esq., (the late)	1	1	0	0
Ayr Branch (1881)	25	0	0	0	Bates, Colonel Robert	1	1	0	0
"Azure 9 Crossbits Argent," per Mrs. Dalton (1882)	2	2	0	0	Bath Branch (1881)	17	9	0	0
B. H. C. (1872-81)	100	0	0	0	Batho, Mrs. (1882)	5	0	0	0
B. Y.	1	1	0	0	Batho, W., Esq., Amesbury	1	1	0	0
Baber, Harry H., Esq. (1870)	10	10	0	0	Batten and Edwards, Messrs.	1	1	0	0
"Baby," per Mrs. Dalton (1881-2)	5	5	0	0	Batten, Messrs. J. and I. & Co.	1	1	0	0
Backhouse, James E., Esq.	5	0	0	0	Battersea Chapel Sunday School	1	1	0	0
Bacup Co-operative Stores (1868-81)	135	0	0	0	Battysany, Count Edmund	1	0	0	0
Badley, Mrs. Laura E., Horseley House	2	2	0	0	Bax, E., Esq., the late, Cockspur St.	1	1	0	0
Badcock, H., Esq.	1	0	0	0	Bax, H. A., Esq.	1	1	0	0
Badcock, H. J., Esq.	0	10	0	0	Baxter, John George, Esq.	1	1	0	0
Bagehot, T. W., Esq. (1878)	60	0	0	0	Bayley, B. S., Esq., Demerara	1	1	0	0
Bailey, E., Esq., Berners St.	1	1	0	0	Bayley and Ridley, Messrs.	1	1	0	0
Bailey, E. H., Esq., ditto	1	1	0	0	Baylis, T. C., Esq.	2	2	0	0
Baillie, Mrs. E. F., Leicester	1	1	0	0	Bayly, Miss, Plymouth (1875)	10	0	0	0
Baily, Miss A. L., Sudbury	1	1	0	0	Bazett, Lieut.-Col. C. G. (1867-79)	12	0	0	0
Baily, Miss E., ditto	1	1	0	0	Beach, Messrs. E. & Co.	1	1	0	0
Bainbridge, E. M., Esq., Eshott Hall	1	1	0	0	Beachcroft, Miss (the late)	1	1	0	0
Ditto (1882)	1	1	0	0	Beaumont, G., Jun., Esq.	1	1	0	0
Baines, Charles J., Esq.	1	1	0	0	Beaumont, Mrs., Durham Terrace	0	10	6	0
Baker, John, Esq., Clapham	1	0	0	0	Beckett, Rev. W. P., B.A.	0	10	0	0
Baker, Mrs., ditto	0	10	0	0	Beckett, James, Esq., Senr., Rathmines (1876-8)	20	0	0	0
Baker, Mrs. Hy., Cottayam (1881)	2	0	0	0	Beddoes, Mrs. C. C.	1	1	0	0
Baker, Rev. Sir T. H. B., Bart.	1	1	0	0	Beddoes, Miss A. F. E.	2	0	0	0
Baker, Sir George, Bart. (1865-74)	25	0	0	0	Bedford, Henry, Esq.	1	1	0	0
Balderson, Mrs., Hanover Sq.	1	1	0	0	Beech, Chas., Esq., Coventry	1	0	0	0
Baldwin, Alfred, Esq. (1877)	10	10	0	0	Beech, W. T., Esq., Balham	2	2	0	0
Balézeaux, Captain Ed., Inspector, French Lifeboat Society	1	1	0	0	Begbie, T. S., Esq.	0	10	6	0
Balfour, John B. Esq. (1868-75)	10	14	0	0	Begley, Mrs., Hammersmith (1862-79)	21	0	0	0
Balkwill, Robt. Coad, Esq.	1	1	0	0	Belcher, Lady (1864-73)	12	6	0	0
Ballard, George, Esq., the late, Residuary Legatees of, per Mrs. Ballard (1875)	50	0	0	0	Ditto	2	2	0	0
Banff and Macduff Branch (1882)	25	0	0	0	Belcher, Miss H.	2	2	0	0
Banfield, R., Esq.	1	1	0	0	Belfast & Groomsport Branch (1882)	57	12	8	0
Bannatyne, C., Esq. (1880)	10	10	0	0	Bell, Alex., Esq., Tooting	1	1	0	0
Bannockburn Branch (1881)	11	16	8	0	Bell, Messrs. Alexander, & Co.	1	1	0	0
Barber, Mrs.	0	5	0	0	Bell, Mrs. L.	1	0	0	0
Barber and Co., Messrs. J.	1	1	0	0	Bell, Mrs. Mary, Maldon	1	1	0	0
Barclay and Sons, Messrs.	2	2	0	0	Bell, Mrs., Penge (1881-2)	0	15	0	0
Baring Bros. & Co., Messrs.	5	0	0	0	Bellamy, Miss	2	2	0	0
Barker, F. C., Esq., Leigh (1871-81)	10	0	0	0	Belli, W. H., Esq., The Courtlands (1861-74)	31	2	0	0
Barkworth & Spaldin, Messrs.	1	1	0	0	Belper Branch (1881)	14	9	0	0
Barkworth, J. B., Esq., Hull (1873)	50	0	0	0	Belsham, J., Esq., Heybridge	0	10	0	0
Barkworth, Miss M., Tunbridge Wells (1880)	50	0	0	0	Benecke, Otto A., Esq. (1873)	10	10	0	0
Barlow, Miss, Kersal	2	2	0	0	Benetfink, S. A. & Co., Messrs.	0	10	6	0
Barnard, Rev. Thomas (1879-80)	20	0	0	0	Benham, John, Esq.	1	1	0	0
Barnard, Rev. Wm. (1878-9)	10	0	0	0	Bennetts, Miss Olympia (1864-81)	55	0	0	0
Barnardiston, N. C., Esq.	1	1	0	0	Bentinck, Lady (1874-81)	30	0	0	0
Barnes, Mrs. (1881-2)	1	0	0	0	Ditto	10	0	0	0
Barnes, Messrs.	0	5	0	0	Bentley, Mrs. S. C., Croydon (1873-82)	40	0	0	0
Barnett, Brose., Messrs.	2	2	0	0	Bentwitch, Herbert, Esq.	1	1	0	0
Barnett, John, Esq. (1867-81)	65	0	0	0	Beresford, Mrs. L.	1	1	0	0
Barnett, Mrs., Meopham Court (1874-7)	20	0	0	0	Berman's Charity, Trustees (1872-82)	115	10	0	0
Barningham, Thos., Esq. (1873-7)	20	0	0	0	Berry, George, Esq.	0	10	6	0
Barras, Mrs., Farnaces	2	2	0	0	Berry, Mr. M. U. (1882)	1	12	0	0
Barrett, Messrs. R. & Son	1	1	0	0	"Beta" (1882)	50	0	0	0
Barrington, R., Esq.	10	0	0	0	Bettell, Wm., Esq., Brixton (1874-82)	28	7	0	0
Barron, F., Esq.	2	2	0	0	Bevan, Geo. J., Esq.	1	1	0	0
					Beveridge, Capt.	1	1	0	0
					Bicknell, Percy, Esq.	1	1	0	0
					Bieber & Co., Messrs. (1881)	1	1	0	0
					Bigge, Francis E., Esq., Carlton Curlien	1	1	0	0
					Billingsley, Capt., R.N.	0	10	0	0

LIST OF DONATIONS AND ANNUAL SUBSCRIPTIONS.

535

	Ann. Subs.			Donations.				Ann. Subs.			Donations.		
	£.	s.	d.	£.	s.	d.		£.	s.	d.	£.	s.	d.
Birch, Miss Eliza, Cheddar	1	1	0				Brassey, H. A., Esq., M.P.	5	0	0			
Birch, Miss J. M. W., Neston	0	5	0				Brassey, Sir Thos., K.C.B., M.P.	5	5	0			
Birch, J. W., Esq.	1	1	0				Bray, T. B., Esq.	8	3	0			
Birchall, J. Dearman, Esq.	1	1	0				Brayne, Charles Seymour, Esq.	0	10	0			
Bird, S. G., Esq.	1	1	0				Brecks, L. C. & W.	1	0	0			
Birkbeck, Edward, Esq., M.P., V.P. (1861-82)				1050	0	0	Brett and Co., Messrs.	0	10	6			
Birkenhead National Eisteddfod, the Committee of (1879)				50	0	0	Brettell, J. Vaughan, Esq.	1	1	0			
Birmingham Branch (1881)				73	10	1	Brettell, Mrs., Camden Square	1	1	0			
Birt, Messrs., Dock Street	4	4	0				Bridge, T. J. L., Esq.	2	2	0			
Bischoff and Sons, Messrs.	1	1	0				Bridges, Capt. H. E. (1873)				20	0	0
Black, Alex., Esq. (1875)				50	0	0	Bridport Branch (1882)				7	6	1
Blackburne, Col. Wm.	1	1	0				Bridson, Josh., Esq., Winder- mere	2	0	0			
Blackwell, Samuel J., Esq.	2	2	0				Briggs, Major-Gen. W. L., C.B. (1879)	26	5	0			
Blain, Samuel, Esq., Liverpool	2	2	0				Brighton Branch (1882)	48	9	0			
Black, H. M. A., Esq., Demerara	1	1	0				Brinckman, Sir Theodore, Bart. (1878)	15	0	0			
Blackpool Branch (1882)				40	0	0	Bristol Branch (1882)	60	3	10			
Blake, T. N., Esq., Gosport	5	0	0				Bristol Histrionic Club, in aid of the support of their Life-boat at Lossie- mouth (additional) (1878)				50	0	0
Blakiston, John R., Esq.	1	0	0				Bristol, The Marquis of	2	2	0			
Blakiston, M., Esq., Maberley	2	0	0				British Ship Owners' Com- pany (Limited)	5	5	0			
Bland, Captain, R.N.	5	0	0				Broad, H. Eustace, Esq. (1881)				1	0	0
Blane, Capt. A. Rodney, R.N.	1	1	0				Broadwood, Mrs., St. Leonards	2	2	0			
Blane, T. L., Esq., (1875-81)				35	0	0	Brock, Mrs. Osmond de Beauvoir	2	2	0			
Blath, F., Esq., Theale	2	0	0				Brocklehurst, Chas., Esq.	5	0	0			
Blathwayte, Rev. C. W., M.A.	1	1	0				Brocklehurst, F. D., Esq. (1868-76)	18	3	0			
Blenkinsop, B., Esq.	1	1	0				Brocklehurst, Wm. Walter, Esq.	5	0	0			
Bligh, Harbottle, and Co.	1	1	0				Brogden, J., Esq., Charing Cross	1	1	0			
Blockley Branch (1881)				2	12	6	Bromley, H. M., Esq. (1881-2)	2	1	0			
Boldero, Major-Genl.	1	0	0				Bromley, Wm., Esq. (1881-2)	2	2	0			
Bolton Branch (1882)				42	0	10	Brook, Mrs. Foxcote	1	1	0			
Bonamy, Lieut.-Col.	1	1	0				Brooke, John T., Esq., Haughton	1	1	0			
Bonser, Mrs. (1873)				10	10	0	Brooke, Sir W. M. de Capell, Bart (1857-82)	215	0	0			
Boord, Mrs. Joseph, Stanley Gardens	1	1	0				Brooke, the Misses, sisters of the late John Brooke, Esq., Q.C., per John Richardson, Esq., Q.C., in addition to special gifts on behalf of Cahore, Giles' Quay, Greencastle, Balbriggan, and Skerries Life-boats (1878-81)	200	0	0			
Booker, Mrs., Putney	0	5	0				Ditto in aid of Irish Life-boats (1881)	100	0	0			
Borough, J. C. B., Esq.	2	2	0				Brooks, Thomas, Esq.	1	1	0			
Borradaile, J. H., Esq. (1875-80)				16	0	0	Brooks, G., Esq., Laceby	2	2	0			
Borror, Mrs.	0	10	0				Brooksbank, Miss M. S., Acroplats (1862-70)	50	0	0			
Borwick, Alfred, Esq.	1	1	0				Brougham, Major-Genl. (1881)	1	0	0			
Bosanquet, Curtis, and Co. Messrs.	2	2	0				Broughton, John, Esq., Poole	2	2	0			
Boston Shipwreck Association (1865-82)	90	0	0				Brown, Bateman, Esq., Hunt- ingdon	1	1	0			
Ditto	5	0	0				Brown, David, Esq.	1	1	0			
Bouchier, Lady (1863-81)				25	0	0	Brown, G. W., Esq., Houghton	1	1	0			
Boulton, M. P. W., Esq.	2	2	0				Brown, George Gilpin, Esq., Sedbury Park (1874)	10	0	0			
Bourdillon, E. D., Esq.	0	10	0				Brown, James Clifton, Esq. (1868-79)	200	0	0			
Bourne, John K., Esq.	1	1	0				Brown, Miss A. M., Sudbury	0	5	0			
Bourne, Miss A. S.	5	0	0				Brown, Mr. H., Luton	1	0	0			
Bouts, T., Esq., Gracechurch Street	1	1	0				Brown, the Misses, Luton	1	0	0			
Bower, J. A., Esq.	1	1	0				Brown, Shipley, & Co., Messrs.	3	3	0			
Bowles, H. C. B., Esq.	2	2	0				Browne, G. B., Esq., Preston	2	2	0			
Bowling, Henry P., Esq., Sacombe	2	2	0				Ditto (1878-82)	601	0	0			
Bowyer, George, Esq.	1	1	0				Browne, G. H., Esq., Greenwich	3	3	0			
Bowyer, John, Esq., the late	1	1	0				Browne, J. W., Esq., Frascati	2	2	0			
Bowyer, Miss Mary	1	1	0				Browne, Lieut. A. G. F., B.S.C.	0	10	6			
Bowyer, W., Esq., Buckden	1	1	0				Browne, Mrs., Avenue Road	1	1	0			
Box No. 48, Birmingham (1882)				5	0	0	Browne, W. J., Esq., Kidwelly	1	0	0			
Boyd & Co., J. & C., Messrs.	2	2	0				Brumell, Mrs. M. E.	1	0	0			
Boyd, Alfred, Esq., Barlaston	1	0	0				Bruce, Henry, Esq.	1	1	0			
Boyd, E. F., Esq.	1	1	0				Bruno, Silva, & Son, Messrs. (1867-71)	26	5	0			
Boyle, Vice-Adml. A.	2	2	0				Brushfield, Mr. Richard	0	10	6			
Boyton, F. R., Esq.	3	3	0				Bryant, Arthur C., Esq.	5	5	0			
Bradford Branch (1882)				297	9	0							
Bradford, Gen. Sir J. F., K.C.B.	1	1	0										
Bradford, Mrs. H. W.	1	1	0										
Bradford, Mrs. J. E.	1	1	0										
Bradford & Sons, Messrs. (1881)				1	11	6							
Bradshaw, Capt., R. A.	1	1	0										
Bramley, W. J., Esq.	1	0	0										
Bramwell, John, Esq., Ken- sington	2	2	0										
Brander, Mrs., Leamington (1880)				10	0	0							
Brassey, Albert, Esq. (1873)				100	0	0							

	Ann. Subs.			Donations.				Ann. Subs.			Donations.		
	£.	s.	d.	£.	s.	d.		£.	s.	d.	£.	s.	d.
Brydges, Sir Harford Jones, Bart. (1857-78)				25	0	0							
Brymer, Miss (1877-8)				10	0	0							
Buckle, Capt. C. M., R.N.	1	0	0										
Bucclough, His Grace the Duke of, K.G.	10	10	0										
Buchanan, Mrs., Edinburgh	1	1	0										
Buckingham, Miss S. C. (1868-82)				33	10	0							
Buckle, Rev. John, M.A.	1	1	0										
Buckley, Victor, Esq.	2	0	0										
Budge, Rev. H. S., B.A.	1	1	0										
Budgett, Messrs. J. & Son	2	2	0										
Budgett, James & Branch, Messrs. (1873)				21	0	0							
Bulkeley, Miss Louisa, Brighton (1866-82)				180	0	0							
Bullard, King, & Co., Messrs.	1	1	0										
Bullock, Messrs. J. & G., & Co.	3	3	0										
Bunbury, Sir Charles, Bart.	3	0	0										
Bunn, Mrs., Sydenham	2	2	0										
Bunn, Miss, Sydenham	0	10	6										
Burbidge, Pritchard, and Bartleet, Messrs.	1	1	0										
Burch, E. C., Esq.	2	0	0										
Burden, Stephen, Esq.	1	0	0										
Burgess, the Misses	0	10	0										
Burgoyne, Montagu, G., Esq.	2	2	0										
Burgoyne, Thos., Esq. (1871)				10	10	0							
Burkett, Rev. Jas.	0	5	0										
Burmeister, Miss	1	1	0										
Ditto (1881)				52	10	0							
Burnett, D. W., Esq.	0	5	0										
Burnett, E. L., Esq.	1	1	0										
Burnett, W. H. W., Esq.	1	1	0										
Burney and Co., Messrs.	2	2	0										
Burr, D. Higford D., Esq.	2	0	0										
Burrell, H., Esq., Gravesend	1	1	0										
Burrell, Hy., Esq., Castle Grey	2	2	0										
Burton-on-Trent Branch (1882)				59	0	9							
Burton, Rev. R. C.	0	5	0										
Burton, W. F., Esq. (1879-70)	15	0	0										
Burton, W. Hally, Esq.	1	1	0										
Busfield, Major	1	1	0										
Busfield, Mrs., South Cave	1	1	0										
Busk, Capt. Hans, trelate	1	1	0										
Busk, Mrs. (1869-78)	27	4	0										
Butcher, Mrs. M. A., Islington, towards support of Margate and Yarmouth Life-boats (1873)	200	0	0										
Butler, C., Esq., Drury Lane	0	10	0										
Butler, Paul, Esq. (1873-4)	11	0	0										
Butler, S., Esq., Fen Court	2	2	0										
Butlin, C., Esq., Nottingham	1	1	0										
Butlin, Thomas, Esq.	0	10	0										
Butterworth, Edward, Esq. (1879)	20	0	0										
Buxton, Fras. W., Esq. (1874)	10	0	0										
Byng, Admiral J. L.	1	1	0										
C., Mrs. M. L., South Australia, "In grateful remembrance of her merciful preservation from imminent dangers by sea in 1862" (1866-81)	130	0	0										
C. D. H. (1881)	5	0	0										
C. S. and G. S. (1874)	11	0	0										
C. T. (A Seaman's Daughter, produce of her Needlework) (1864-72)	60	0	0										
Cain, Geo., Esq.	0	5	0										
Cain, Miss, Edmonton	0	5	0										
Caldwell, J., Esq., Starcross (1878)	100	0	0										
Calrow and Son, Messrs. J.	1	1	0										
Campbell, Arthur E., Esq. (1871)	50	0	0										
Campbell, C. M., Esq., Stoke	2	2	0										
Campbell, Mrs. Emma R.	1	1	0										
Cambridge Life-boat Fund, per Capt. Going, R.N. (1882)	70	0	0										
Cameron, Lady Vere (1882)	20	0	0										
Campbeltown and Southend Branch (1882)													
Candler, P. W., Esq.	2	0	0				10	0	0				
Ditto (1872-5)							40	0	0				
Cann, James, Esq.	1	1	0										
Capel, Frank C., Esq.	5	5	0										
Capel, J. D., Esq.	1	1	0										
Capel, Messrs. Arthur & Co.	1	1	0										
Capper, Alexander & Co., Messrs., Cardiff (1881)													5 0 0
Carbutt and Co., Messrs.	1	1	0										
Cardale, Rev. E. T.	0	10	0										
Carew, Mrs. G., Mytton Hall	2	2	0										
Carew, Rev. Gerald	1	1	0										
Carew, Miss Elizabeth Louisa (1881)	100	0	0										
Carew, Mrs. Hollowell (1870-81)	110	0	0										
Carew, T., Esq., Collipriest	1	0	0										
Carew, Capt. R. Pole	1	0	0										
Carey, S. W., Esq., New York, \$100 (1876)	18	16	4										
Carlingford, the Right Hon. Lord	2	0	0										
Carlisle, the Bishop of	1	1	0										
Carmichael, Sir W. G., Bart.	2	0	0										
Carr, W. J., Esq.	1	1	0										
Carrera, C. L., Esq.	1	1	0										
Carson and Sons, Messrs. W. (1879)	10	10	0										
Carswell, Morris, Esq., in memory of his wife (1880)	15	0	0										
Carter, Fredk., Surgeon-Major (1881-2)	4	0	0										
Carter, Rev. S. R., B.D. (1875)	10	10	0										
Cartwright, Col. H.	1	1	0										
Ditto (1882)													3 0 0
Cartwright, Capt. R. Norton	1	0	0										
Cartwright, Miss, Bury St. Edmunds (1862-81)													150 0 0
Cartwright, Rev. R., Ellingham	1	0	0										
Cartwright, Mrs., Ditto	0	10	0										
Cassell, Smith & Co., Messrs.	1	1	0										
Cator, Miss S. H. Bertie (1861-73)	18	13	0										
Ditto	1	1	0										
Cator, Mrs. Wm. A.	1	1	0										
Causton, Sir J., & Sons	1	1	0										
Cave, B., Esq., Wigmore St.	0	10	6										
Cave, L. T., Esq.	5	0	0										
Cave, Lady (1881)													5 5 0
Cave-Browne-Cave, Mrs. Edward F.	2	2	0										
Cave, W., Esq., Wigmore St.	0	10	6										
Chads, Admiral	1	0	0										
Chadwick, Mrs.	1	1	0										
Chalmers, Guthrie, and Co. (1871)	10	10	0										
Chalmers, Sir David, Demerara	1	1	0										
Chamberlain, Herbert, Esq.	2	2	0										
Chamberlain, Miss C.	1	1	0										
Chamberlain, Richard, Esq.	1	1	0										
Chamberlain, Capt. Tankerville J. (1870-9)													12 2 0
Ditto													1 0 0
Champion, F. C., Esq.	1	1	0										
Chance, Geo., Esq., Leinster Gardens (1882)													5 0 0
Chaplin, E., Esq., Hamburg (1867-74)	26	5	0										
Chapman, T., Esq., F.R.S., Chairman													21 0 0
Chardless, H., Esq. (1867-82)													48 19 0
Charles, Mrs., Finchley	1	1	0										
Charlesworth, W. H., Esq. (1881)													10 0 0
Charley, E., Esq., Lisburn	0	10	0										
Charley, Mrs., and Family, Dunmurry	1	0	0										
Charrington, Miss E., Woodsleigh (1875)	10	0	0										
Charrington, Miss M., Harley Street	2	0	0										
Charteris, Lady Margaret	2	2	0										
Chatterton, A. J., Esq., Dublin (1881)	1	0	0										

LIST OF DONATIONS AND ANNUAL SUBSCRIPTIONS.

537

	Ann. Subs.	Donations.		Ann. Subs.	Donations.
	£. s. d.	£. s. d.		£. s. d.	£. s. d.
Chatterton, Miss J., Dublin	1 0 0		Colling, Joseph, Esq., Islington (1875)	10 10 0	0
Chavasse, Mrs. Horace	1 1 0		Ditto	1 1 0	
Chaytor & Co., Messrs.	1 1 0		Collingwood, Miss M. A.	1 1 0	
Cheape, G. C., Esq., Wellfield (1864-80)	62 0 0		Collinson, Admiral Sir R., K.C.B.	1 1 0	
Cheesman, G., Esq., Dorking	3 3 0		Collinson, Miss A. M., Weston (1865-82)	69 11 0	
Cheetham, C., Esq.	2 2 0		Collinson, T., & Sons, Messrs. (1881)	1 0 0	
Cheltenham Branch (1881-2)	15 19 1		Colonial Company (Limited)	2 2 0	
Cheshire, Mr. C., Birmingham (1882)	1 1 0		Colville, Lord	2 2 0	
Chester Branch (1882)	18 3 3		Colvin, Miss E. H.	2 2 0	
Chester, C., Esq.	5 0 0		Commeline, Thomas, Esq.	0 10 0	
Chetwynd, The Viscount	1 0 0		Commercial Union Assurance Company (1879)	10 10 0	
Chetwynd, Major the Hon. C.C.	1 1 0		Comptoir d'Escompte de Paris	3 3 0	
Chichester Harbour & Selsey Branch (1882)	50 0 0		Conlan, F. P., Esq., Lincoln	1 1 0	
Child and Co., Messrs.	2 2 0		Conolly, Gen., C.B. (1882)	5 0 0	
Childers, Rt. Hon. H. C. E., M.P.	1 1 0		"Continental Daily Parcels Express"	1 1 0	
Childers, Miss L.	1 1 0		Conyngham, Marquis of	2 2 0	
Cholmondeley, The Marquis of	2 2 0		Copley, Miss E. M. (1879-82)	5 2 0	
Chorlton, Isaac, Esq., Withington	1 1 0		Cooch, Mrs.	2 2 0	
Christy and Co., Messrs., Gracechurch Street	1 1 0		Coode, Sir John	1 1 0	
Christie, Mrs. (1878)	10 10 0		Cook, Mrs. A., the late	0 5 0	
Chudleigh, Mrs.	2 2 0		Cooke, Mrs. Martha (1865-71)	20 0 0	
Church and Son, Messrs.	0 10 0		Cooper, Cooper, & Co., Messrs.	1 1 0	
Church, Rev. G. L.	0 10 6		Cooper, J. E., Esq., Milford	3 3 0	
Chuter, Mrs., Croydon	2 2 0		Coote, Thomas, Esq.	1 1 0	
Civil Service Life-boat Fund, <i>vide</i> p. 557.			Corbet, Sir Vincent R., Bart. (1882)	5 0 0	
Claris, Sydney, Esq. (1881)	15 15 0		Cordes, T., Esq., Bryn Glas	2 2 0	
Clark, W., Esq., Brompton	2 2 0		Cordwainers, Worshipful Company of (1875)	21 0 0	
Clarke and Rowe, Messrs.	1 1 0		Cornell, Geo., Esq., Oakland	1 1 0	
Clarke, H. M., Esq.	2 0 0		Cornell, R., Esq., Brockley	1 1 0	
Clarke, Mrs. Cowden	1 1 0		Cornell, Samuel, Esq., Chelsea	1 11 6	
Clarke & Co., Stephenson	2 2 0		Cornish-Bowden, Admiral W.	2 2 0	
Clarke, The Misses, Carlisle	2 0 0		Corrie, Mackie, & Co., Messrs.	2 2 0	
Clatworthy, J., Esq.	1 0 0		Corrie, A. J., Esq., Dunrod	2 2 0	
Clayton, Colonel Fitz-Roy	2 0 0		Corrie, Rev. E. S., in memory of E. B. C.	0 10 0	
Clayton, C. H., Esq.	1 1 0		Corscaden, Mrs., Holland Park	5 5 0	
Clayton, F. S., Esq.	1 1 0		Cory, Miss, Stamford	1 0 0	
Clayton, T. W., Esq., Ryde (1859-73)	15 0 0		Coster, Capt.	1 1 0	
Clegram, W. B., Esq., J.P.	2 2 0		Cotesworth, W., Esq.	1 1 0	
Clerk, Major-Gen. H., R.A.	1 1 0		Coupland, J. M., Esq., Tinsley (1859-71)	15 0 0	
Clerke, Chas. L., Esq. (1882)	5 0 0		Courage and Co., Messrs. (1859-80)	50 0 0	
Clermont, Lord	2 2 0		Court, A., Esq., R.N.	0 5 0	
Clermont, Lady	1 1 0		Court and Co., Messrs.	0 5 0	
Clevedon Life-boat Fund, <i>vide</i> p. 557.			Courtenay, Messrs. J. & W. J.	2 2 0	
Clifford, Messrs. C., & Son	1 1 0		Courtenay, Miss, Brompton (1880)	50 0 0	
Clifford, Colonel, and Mrs.	2 0 0		Courthope, G. C., Esq.	1 1 0	
Clifford, Rev. John (1878-81)	2 1 0		Ditto, in aid of Sussex Life-boats	1 0 0	
Clinton, Lady Charlotte P.	1 1 0		Courtney, Mrs., Exmouth	1 1 0	
Cloid, Routledge, and Co.	2 2 0		Coutts and Co., Messrs.	10 0 0	
Clothworkers, Worshipful Company of (1855-81)	156 9 0		Covent Garden Life-boat Fund, <i>vide</i> p. 557.		
Clough, Hugh C.B., Esq. (1880)	10 0 0		Cowie, T. S., Esq. (1863-74)	21 0 0	
Clowes, R., Esq., Stockwell (1861-81)	18 18 0		Cowper, Edw. Alfred, Esq., C.E.	1 1 0	
Clutterbuck, Mrs. C. F.	2 2 0		Cowie, Mrs., in remembrance of little Alfred's 15th birthday (1882)	1 1 0	
Coal Factors' Society	5 5 0		Ditto, and Family (1872-82)	12 3 6	
Coal Merchants' Society	5 5 0		Cox and Co., Messrs.	5 5 0	
Coates, James, Jun., Esq., Paisley (1874)	20 0 0		Cox, Henry, Esq., Trevereux (1864-77)	50 0 0	
Coates, Jos., Esq., North Bank	1 1 0		Cox, Miss, M. A.	1 1 0	
Cochrane, Robt., Esq., Alwyne Sqre. (1881)	5 0 0		Cracklow, General	2 0 0	
Cock, Miss E. A. (1868-82)	75 0 0		Cranfield, Wm., Esq.	1 1 0	
Cockey, E., Esq., & Mrs. Frome	0 10 0		Craven, Miss S.	0 10 0	
Codd, Admiral	1 1 0		Crawley, Edmund, Esq.	0 5 0	
Cole, A. C., Esq., Lee	1 1 0		Crawley, Mrs. G., Spratton (1877-82)	4 12 0	
Coleman, Capt. G.	1 1 0		Crichton, Alexander, Esq. (1864-71)	10 10 0	
Coleman, Rev. W. (1868-82)	7 10 0		Croggon & Co., Messrs. T. J.	1 1 0	
Coles, J., Esq., Throgmorton Street	1 1 0		Crosbie, Rev. Howard A.	2 0 0	
Coles, Miss A., West Hove	0 10 6		Crosse, Mrs. St. Croix	1 1 0	
Collet, W. W., Esq.	1 1 0		Crosse & Blackwell, Messrs.	5 5 0	
Collie, Dr. G. D. Milne	1 0 0		Crosley, Messrs. John & Sons (Limited), Halifax	10 0 0	
Collier, Messrs. F. H. & A.	1 1 0		Crowley, J. S., Esq., Croydon	1 1 0	
Collin, J., Esq., Lewisham	1 1 0				
Collin, Miss, Store Street	2 2 0				

	Ann. Subs.			Donations.				Ann. Subs.			Donations.				
	£.	s.	d.	£.	s.	d.		£.	s.	d.	£.	s.	d.		
Croxall, R. F. T., Esq.	2	2	0				Dell, L., Esq., Pelham Cres-	1	1	0					
Crutchell, Mrs., Brighton (1882)				5	0	0	cent								
Cruddas, Charles J., Esq.	1	1	0				Delmé-Radcliffe, Comr., and								
Cruddas, W. D., Esq.	1	1	0				Mrs.	2	0	0					
Crum-Ewing, J. D., Esq.	1	1	0				Denison, Alfred, Esq.	2	2	0					
Cuff, Miss (1872-81)				50	0	0	Denison, Lady	5	0	0					
Cullimore, D., Esq., Monkstown	1	0	0				Dennistown, A. H., Esq.	1	1	0					
Cullingford, W. H., Esq.	2	2	0				Dent and Co., Messrs. E.	3	3	0					
Cumberbatch, L. T., Esq., M.D. (1880)				5	5	0	Dent, George, Esq. (1872-4)				10	10	0		
Cumberlege, Miss A. T.	1	0	0				Ditto	1	1	0					
Cumming, Mrs., Delamere Terr. (1879-81)	3	3	0				Dent, W., Esq., Streatham	10	10	0					
Cunard Steam Ship Co. Limd.	10	0	0				Ditto (1880)				100	0	0		
Cunnynghame, Hugh, Esq. (1864-81)	67	0	0				<i>Deo Gratia</i> (1882)				25	0	0		
Curling, Miss Martha, Cam-				45	0	0	Derby, Chas., Esq., Brighton (1881)				2	0	0		
berwell (1874-82)							Derby Branch (1882)				30	9	0		
Curme, Admiral C. T.	0	10	0				Desborough, C. J., Esq.	1	1	0					
Curteis, Whitworth, and Co.,							Devall, Miss	0	10	0					
Messrs.	1	1	0				Devey, The Misses	5	0	0					
Curtis, R. Mayne, Esq.	1	1	0				Devitt and Hett, Messrs.	1	1	0					
Curwen, Mrs. Ewing	1	1	0				Devon Central Branch (1881-2)				36	12	8		
Cutbill, Reginald, Esq.	0	10	0				Devon, H. C., Esq.	1	1	0					
Cutbill, W. J., Esq.	1	1	0				Devon, The Earl of	2	0	0					
Cutler, Palmer, & Co., Messrs.	2	2	0				Dew, Rev. E. Parker, M.A.	1	1	0					
							Dewes, Mrs. Bromley (1877-81)				2	5	0		
							Deykin, Mrs., Edgbaston	1	1	0					
D. G. E.	1	1	0				Dickson, Mrs.	2	2	0					
Da Costa, Miss, Oxford Ter. (1875-80)	1000	0	0				Dickson, Rev. W. R.	1	0	0					
Daggett, Mrs. S. J.	1	1	0				Digby Commr. H. A., R.N. (1882)				5	0	0		
Dalgety, Du Croz, and Co.,							Dixon, Mrs. R. R., Shilling-								
Messrs.	2	2	0				thorpe	1	0	0					
Dalkeith Branch (1881)				10	2	9	Domecq and Co., Messrs. P.	1	1	0					
Dallas, Sir George (1873-82)				42	0	0	Domett, John, Esq.	1	1	0					
Dallas, Capt. Rupert C. F. (1882)				2	10	0	Ditto (1881-82)				5	5	0		
Dalton, General Edward T.	1	0	0				Domville, Sir J. G., Bart.	1	1	0					
Dalton, H., Esq., Tunbridge							Donaldson, George, Esq., New								
Wells (1874-82)				24	0	0	Bond Street (1873-78)				23	2	0		
Dalton, Mrs. H. (1874-82)				21	0	0	Donkin, R. S., Esq.	10	10	0					
Dalton, Miss, Clapham	1	1	0				Douglas, Sir Percy, Bart.	0	10	0					
Dalton, Miss Hannah, ditto.	1	1	0				Dover Branch (1882)				20	0	0		
Dalton, R. F. V., Esq.	1	1	0				Dovers, George, Esq.	1	1	0					
Daly, Hon. R.	1	0	0				Dowling, D. J., Esq., (1880)				10	0	0		
Dand, J., Esq., Sutton	1	1	0				Dowling, E. S., Esq.	1	0	0					
Daniel, Miss Emma	1	1	0				Downes, Edward, Esq.	0	5	0					
Danson, Dr.	2	2	0				Downshire, Marchioness of	1	1	0					
Darling, Col. A.	1	1	0				Doxat, Miss C., Furthoe House,								
Darling, Mrs., Cromwell Rd.	2	2	0				Stony Stratford	0	10	6					
Darnley, The Earl of	1	0	0				Doyle, P. W., Esq.	2	2	0					
Davey, Rev. W. H.	0	10	0				Drake, T., Esq. (1867-74)				14	0	0		
Davies, M., Esq., East Cowes	0	10	0				Draper, John, Esq.	0	10	6					
Davies, Miss, Mallow	0	5	0				Drapers, Worshipful Com-				81	10	0		
Davies, Mrs., Carmarthen (1881-2)				1	1	0	pany of								
Davis, Frederick, Esq.	3	3	0				Ditto (1877)				52	0	0		
Davison, A., Esq.	0	10	6				Drummond, Capt. Alfred M.	2	0	0					
Davison, Newman, & Co.	1	1	0				Drummond, Capt. C. G. A.	2	2	0					
Davson, J.W. Esq., Demerara	1	1	0				Drummond, Lady E. E. F.	2	0	0					
Davy, F., Esq., Topsham	1	0	0				Drummond, George F., Esq.	2	2	0					
Davy, Yates, and Routledge	1	1	0				Drummond, Messrs.	10	0	0					
Dawber, Robert, Esq.	1	1	0				Drury, H. Dru, Esq.	1	0	0					
Dawlish Branch (1882)				32	14	5	Drysdale, John J., Esq. (1882)						1	1	0
Dawson & Son, Messrs.	0	5	0				Drysdale, R.P., Esq., Demerara	1	1	0					
Dawson-Scott, Lt.-Col., R.E.	1	1	0				Duarte, Miss	5	0	0					
Day, John, Esq.	1	1	0				Duberly, Mrs.	1	1	0					
Day, Mrs. F.	1	0	0				Dublin Port and Docks Board	75	0	0					
Dayman, C. O., Esq.	3	0	0				Du Croz, F. A., Esq. (1882)				10	0	0		
Deacon, Messrs. E. and A.	1	1	0				Dugdale, J. B., Esq.	2	2	0					
Deacon, W. M., Esq.	0	10	6				Dugmore, Lieut.-Col.	1	1	0					
Dean, Albert A. & Co., Messrs.	1	1	0				Duncan, G., Esq., East India								
Dean, Rosser S., Esq.	1	0	0				Avenue	5	5	0					
Deane, Mrs., Chelsea (1879-81)				3	0	0	Duncombe, G. T., Esq.	3	3	0					
Deane and Co., Messrs., King							Dundee Branch (1882)				120	0	0		
William Street	1	1	0				Dunfermline Branch (1882)				25	14	2		
Deans, Mrs., Stockwell	1	1	0				Dunman, Thos., Esq., Clovelly	1	1	0					
Debenham, T. N., Esq. (1879-81)				6	6	0	Dunn and Co., Messrs. W.	1	1	0					
De Kantzow, Rear-Adm. H.P.	1	11	6				Dunn, Ernest H., Esq.	1	1	0					
De la Granja, The Marquis	1	0	0				"Dunsappie" (1874)				10	0	0		
							Dunsford, Miss (1873-81)				9	9	0		

LIST OF DONATIONS AND ANNUAL SUBSCRIPTIONS.

539

	Ann. Subs.		Donations.			Ann. Subs.		Donations.			
	£.	s. d.	£.	s. d.		£.	s. d.	£.	s. d.		
Durnford, Rev. Edmund	1	1	0		Esdaille, Mrs., Penge (1881-2)			0	15	6	
Durrant, Capt. F., R.N.	2	0	0		Esse, F., Esq. (1877-81)			4	4	0	
Dyas, Capt. R. H.	3	0	0		Estridge, Edward, Esq.	1	1	0			
Dyer, John, Esq., Blackheath	2	2	0		Evans, Capt. Sir Fredk. J. O., R.N., K.C.B., F.R.S.	2	2	0			
Dyer, Wm., Esq.	3	3	0		Evans, E. P., Esq.	1	1	0			
E. A. (1870)			10	10	0	Evans, Mrs., Seymour Street	2	0	0		
E. A. B. (1872-5)			17	0	0	Eversfield, C. G., Esq.	1	1	0		
E. C., Lancaster Gate	1	0	0		Ewart, Maccaughey, and Co., Messrs.	2	2	0			
E. C. (1872-5)			20	0	0	Ewart, Miss Mary A.	3	3	0		
Ditto, a Thank-offering (1876)			10	0	0	Ewart, William Lee, Esq.	10	0	0		
E. C. F. (1881)			5	0	0	Ewing, W. Orr, Esq.	5	0	0		
E. C. W. (1869-82)			9	0	0	Exmouth Branch (1882)			20	0	0
E. G. (1876-81)			21	0	0	Eyemouth Branch (1881)			20	0	0
E. H. (1873)			10	0	0	Eyre, G. J., Esq., Brighton (1872-82)			110	0	0
E. M. C.	5	0	0		Ditto	5	5	0			
E. V. A. (1875-7)			45	0	0	Eyre, Rev. H. S.	1	0	0		
Earle's Shipbuilding and Engineering Co., Limited	1	1	0		Eyre, Mrs. Robert	0	10	6			
East, Sir Gilbert A. C., Bart.	5	0	0		F. G. R. (1878)			10	0	0	
Easton, John, Esq., M.D.	1	1	0		F. P. H. (1871)			10	0	0	
Eastwood, John F., Esq.	1	1	0		Faber and Co., Messrs. A.	2	2	0			
Echalaz, Rev. Theophilus S.	1	1	0		Fair, J., Esq.	2	2	0			
Ecroyd and Sons, Messrs.	3	3	0		Fairbank, H., Esq., Willenhall	1	1	0			
Eden, Mrs. Henry	2	0	0		Fairthorne, E., Esq.	2	2	0			
Edge, Mrs., Penge (1882)			0	10	0	Fairthorne, Miss A.	5	0	0		
Edge, W. M., Esq.	1	1	0		Fairthorne, Miss E.	1	1	0			
Edgeworth, M. P., Esq.	0	10	0		Fairthorne, Mrs., Slade End.	0	10	6			
Edinburgh, Leith, and Granton Branch (1881-82)			383	19	4	Falcon, Mrs. (1867-71)			15	0	0
Edwardes, T. D., Esq.	1	0	0		Falcon, Rev. R. S.	2	2	0			
Edwards, J., Esq., Record Office	1	1	0		Falmouth, The Viscount	5	0	0			
Edwards, Miss, Clifton	1	1	0		Fane, W. D., Esq.	2	2	0			
Edwards, Miss M. (1871)			50	0	0	Fanning and Co., Messrs. W.	1	1	0		
Edwards, S., Esq., Fenchurch Street	1	1	0		Fanshawe, Mrs. F., Uckfield	0	10	0			
Edwards, S., Esq., Lewisham	1	1	0		Fanshawe, Rev. Arthur A. (1872)			20	0	0	
Egan, T. Selby, Esq.	1	1	0		Fanshawe, Adm. Sir Edward G., K.C.B.	1	1	0			
Egerton, Mrs. M. A. F.	5	0	0		Farmer, Capt. Wm. R. G.	1	1	0			
Egerton, Miss G. C.	2	0	0		Farnell, Mrs., Colchester	1	1	0			
Egerton, Rev. J. C., in aid of Sussex Life-boats			0	10	6	Farquhar, Captain H.K., 24th Regt. (1865-74)			70	0	0
Ekins, Mrs. P. J.	5	5	0		Featherstonhaugh, C., Esq.	1	0	0			
Elam, Miss	2	10	0		Feeney, John, Esq.	1	1	0			
Elder, A. L., Esq.	1	1	0		Fellows, C. F., Esq.	5	0	0			
Elias and Co., Messrs.	1	1	0		Felton, W. V., Esq. (1873)			10	0	0	
Eliot, Hon. H. C.	2	0	0		Fenwick, C. R., Esq.	5	0	0			
Ellen and Co., Messrs.	0	10	6		Fenwick, Capt. John	1	1	0			
Elliot, Geo., Esq., Croydon (1873-81)			15	0	0	Fenwick, Mrs. S. C.	1	0	0		
Elliot, Sir Walter	1	0	0		Fenwick & Sons, Messrs. John	5	5	0			
Elliott, Mrs., Bournemouth	2	2	0		Few, Chas., Esq. (1881)			5	5	0	
Elliott, Wm., Esq.	1	1	0		Few, Rev. Charles E., M.A.	2	2	0			
Ellis and Sons, Messrs. H.	1	1	0		Field, Capt. E., R.N., J.P.	1	0	0			
Ellis, The Rt. Hon. J. W., Lord Mayor of London.	1	1	0		Field, Rev. F., Heigham	1	1	0			
Ellis, Capt., Lymington	2	0	0		Field, J. P., Esq.	2	2	0			
Ellis, Mrs., Hampstead	1	1	0		Figgis, Samuel, Esq.	2	2	0			
Ellis, Miss, Hampstead	1	1	0		Filliter, Freeland, Esq.	1	1	0			
Ellis, Mrs., Bognor	0	10	6		Fincham, Miss	0	10	6			
Elwes, J. H., Esq.	2	0	0		Findlater, Mackie, and Co.	2	2	0			
Ely, The Most Noble the Marquis of	20	0	0		Findlay, Mrs. James, in aid of Scotch Life-boats	1	1	0			
Emery, William, Esq.	0	10	6		Finnis, Fisher, & Co., Messrs.	1	1	0			
Emmerson, Mrs. Susan (1873-81)			8	6	0	Fisher, G. A., Esq.	1	1	0		
Engelhardt, L. A., Esq.	1	1	0		Ditto (1881)			2	2	0	
English, Bros., Messrs.	1	1	0		Fishmongers, Worshipful Company of (1873)			105	0	0	
English, Capt., R.E.	1	0	0		Fishwick, J. H., Esq. (1871-82)			12	11	0	
Engström, George, Esq.	1	1	0		Fishwick, S. E., Esq. (1875-82)			8	7	0	
Entwistle, Mrs., Leamington (1881)			5	5	0	Fisk, Rev. J. H. (1857-71)			45	0	0
Enniskillen Branch (1882)			19	11	6	Fitz-George, Major G.	1	1	0		
Epps, Jas., Esq., Norwood	1	1	0		Fladgate, Mrs., Staines	1	1	0			
Erne, The Earl of, K.P.	1	0	0		Fleming, B. R., Esq., Down St.	5	5	0			
Erne, The Countess of	1	0	0		Fletcher, W., Esq., Cheltenham	2	0	0			
Ernsthausen and Oesterley, Messrs.	1	1	0								

	Ann. Subs.		Donations.			Ann. Subs.		Donations.		
	£.	s. d.	£.	s. d.		£.	s. d.	£.	s. d.	
Flood, Frederick, Esq.	5	5	0		Gibb, T. Jones, Esq.	2	2	0		
Ford, Mrs., Croydon (1872-9)			12	5	0	Gibbes, W., Esq.	1	0	0	
Foreman, Mr. Owen	0	5	0		Gibbs, A. E., Esq., St. Thomas's Street	1	1	0		
Foresters, Ancient Order of, <i>vide</i> p. 557.					Gibbs, Geo., Esq., Junr. (1877-82)			6	6	
Forrest, Major-General	1	1	0		Gibbs, H. H., Esq.	2	2	0		
Forrester, Miss (1870-81)			50	0	0	Gibson, Mrs. (1873-81)			8	0
Forrow, B. A., Esq., and Edwin Taffs, Esq., Poplar (1874)			10	10	0	Giesler and Co., Messrs.	3	3	0	
"For those in peril on the Sea" (1872-81)			46	5	0	Gilbert, J. A., Esq.	1	1	0	
Fortnum, Mason, and Co., Messrs.	2	2	0		Gill, John, Esq., Battersea	1	1	0		
Foster, James L., Esq. (1875-81)	40	0	0		Gillespies, Moffatt, and Co.	2	2	0		
Foster, Rev. Sir C., Bart.	2	2	0		Gillett, W. S., Esq.	2	2	0		
Foster, Richard, Esq.		5	0	0	Gilmour, Rankin, & Co., Messrs.	1	1	0		
Fothergill, The late Mr., per Mrs. Fothergill (1881)	50	0	0		Girdlestone, Mrs. R. B., Oxford	1	0	0		
Fowler, John, Esq., Sheffield (1874-7)	11	6	0		Gladstone, John E., Esq.	2	0	0		
Fox, Rev. G. T.	1	1	0		Glasgow Branch (1882)			391	2	
France-Hayhurst, Rev. T.	1	0	0		Glen, Joseph, Esq. (1873-9)			52	0	
Francis, Mrs. A., Colchester	0	10	0		Glover Brothers, Messrs.	0	10	0		
Francis, Mrs. Sarah, Quay Hall	1	1	0		Goddard, Miss, Addiscombe (1882)			5	5	
Franklyn, H. W., Esq.	2	2	0		Godlee, Mrs. R.	1	1	0		
Fraser, E., Esq., Inch (1872-8)	35	0	0		Godman, Col. (1881)			2	0	
Fraser, Mrs., Manchester	2	2	0		Godsall, P. W., Esq.	2	0	0		
Fraserburgh Branch (1882)	20	0	0		Godwin & Son, Messrs., Poole	2	2	0		
Frazer, Miss Florence M.	1	1	0		Goff, Major R.	1	0	0		
Frazer, John, Esq., Cornhill	1	1	0		Goldsmith, Admiral, C.B.	1	1	0		
Friends (1881)			0	11	6	Goldsmiths, Worshipful Co. of (1877)	150	0	0	
Freeland, Messrs. J. and A. B.	1	1	0		Goldsworthy, Col. (for 1881)			10	0	
Freeling, Mrs. (1869-81)	43	1	0		Gollop, G. T., Esq.	2	2	0		
Freeman, C., Esq., Leamington (1874)	10	0	0		Gollop, Mrs.	1	1	0		
Freeman, Miss, Canterbury (1872-81)	50	0	0		Gomonde, Mrs. Anne, Pau (1864-81)	360	0	0		
Freer, Rev. T. H., M.A.	1	1	0		Gonne, Edward, Esq.	1	1	0		
Freer, Leacroft, Esq.	1	1	0		Goode, Miss M. H. (1877-82)			3	0	
French, B. F., Esq. (1880)	10	0	0		Goodenough, S. R., Esq.	1	0	0		
French, David, Esq. (1881)	10	10	0		Goodman, Miss M. (1869-82)			47	0	
Freshfield, Miss	1	1	0		Gopsill, Brown & Sons, Messrs.	0	10	0		
Fribourg and Treyer, Messrs.	0	10	0		Gordon and Stamp, Messrs. for the steamers <i>Nettleworth</i> , <i>Leverston</i> , <i>Monica</i> , <i>Consul</i> , <i>Usworth</i> , <i>John Johnson</i> , <i>Dorcas</i> , <i>Eunice</i> , <i>Sybil</i> , <i>Becton</i> , <i>Florence</i> , <i>Emmy</i> , <i>Haase</i> , <i>Violet</i> , and <i>Gordonia</i>	7	0	0		
Frith, Rev. Wm. A., M.A. (1871-82)	11	9	0		Gore, Miss E. E.	1	0	0		
Frost, Brothers, Messrs.	1	1	0		Gore, Rev. G. (1876)			10	0	
Fry, The Hon. Justice	2	0	0		Gorell, Miss, Norwich (1881)			5	0	
Fryer, Captain, Worthy Park Ditto (1880)	10	0	0		Gorringe, Frederick, Esq.	2	2	0		
Fuller, Mrs. Trayton	2	0	0		Gosling, Francis, Esq.	1	1	0		
					Gosling, General W. C., R.A.	1	1	0		
G., Thurloe Square	1	4	0		Gosling, Mrs. Mary, Wyesham	1	1	0		
G. B. (1872)	25	0	0		Gotobed, Miss	2	2	0		
G. E. W. (1882)	1	1	0		Ditto (1873-6)			10	0	
G. J. A. (1872)	20	0	0		Goyeneche, J. V., Esq.	1	1	0		
G. L. (1877-82)	2	10	0		Graham, Col. Sir L., Bart.	2	0	0		
G. R. B. (1877-82)	20	10	0		Graham, Cyril C., Esq.	1	0	0		
Gadsby, John T., Esq.	1	1	0		Grant, Messrs. J. and R. (1874)			21	0	
Gairdner, Mrs., Ivy Lodge	1	1	0		Grant, Henry, Esq., Fenchurch Street	2	2	0		
Gale and Co., Messrs.	2	2	0		Grant, R., Esq., Leadenhall St. (1881)	21	0	0		
Galloway, Joseph, Esq.	1	0	0		Grant, Ed., Esq., Leamington	1	1	0		
Gambier, Admiral R. F.	1	0	0		Grant, W. D., Esq., Leamington	1	0	0		
Garden, Miss Emma (1858-81)	47	10	0		Gray, B. G., Esq. (1881)			2	2	
Garden, Mrs. (1863-72)	34	10	0		Gray, Dawes & Co., Messrs.	1	1	0		
Gardiner, Miss	1	1	0		Gray, Rev. C.	0	5	0		
Gardner, F. G., Esq.	1	1	0		Greaves, Mrs.	0	10	0		
Gardner, Rev. T. J. C.	1	1	0		Green, Frederick, Esq.	1	1	0		
Garland, C., Esq.	0	10	6		Green, J., Esq., Dover St.	1	1	0		
Garrett, Mrs. Robt., Anerley (1881)	2	2	0		Green, Joseph E., Esq.	1	1	0		
Garrett, W. H., Esq.	1	1	0		Greenock Branch (1882)			45	19	
Garrett, Mrs. W. H.	1	1	0		Greenway, Mrs., Myton	2	2	0		
Garston, Edgar, Esq., K.R.G. (1871-3)	15	0	0		Greenwood, John, Esq.	0	10	6		
Gas Light and Coke Company	10	0	0		Gregory and Co., Messrs. F.	1	1	0		
Gatty, C. H., Esq.	2	2	0		Gregory and Prentis, Messrs., Bermondsey	1	1	0		
Gatty, Mrs. Buckden	1	0	0							
Gea, Mrs. Isabella, Aberdeen (1879)	17	10	0							
Gibb, B. D., Esq., Royal Exchange (1874)	10	10	0							
Gibb, Chas. J., Esq., M.D. (1871)	10	10	0							
Gibb, Col. W. E. (1873-82)	10	10	0							

LIST OF DONATIONS AND ANNUAL SUBSCRIPTIONS.

541

	Ann. Subs.		Donations.			Ann. Subs.		Donations.	
	£.	s.	d.	£.		s.	d.	£.	s.
Grey, Lady, Norwood (1872-9)				50	15	0			
Ditto	1	0	0						
Grice & Co., Messrs. W. (1862-82)				195	0	0			
Griffin, E., Esq., Oakley Square (1867-81)	62	11	0						
Griffith, C. W. Darby, Esq.	1	0	0						
Griffith, Sir G. Waldie, Bart.	3	0	0						
Griffith, J., Esq., Regent's Park				52	10	0			
Griffith, Mrs. (1881-2)				1	0	0			
Griffiths, Tate, and Selby	2	2	0						
Grindall, Mrs. Sturt (the late)	1	0	0						
Gripper, John E., Esq.	1	1	0						
Grocers, Worshipful Company of (1877)				100	0	0			
Grosvenor, Capt. the Hon. Norman de l'A., M.P.	1	0	0						
Grosvenor, Chater, and Co., Messrs.	1	0	0						
Grove, Chs. B., Esq., Callender	1	1	0						
Grove, Mrs., Bolton Row	1	1	0						
Grove, Miss Chafyn				5	0	0			
Gubbins, Mrs.				2	2	0			
Guimaraens, M. F., Esq.				0	10	6			
Gun Makers, Worshipful Company of (1882)				10	0	0			
Gunning, Rev. Sir Henry, Bart.	0	10	0						
Gurdon, W., Esq. (1864-76)				25	0	0			
Guthrie, Miss A. K., Northallerton (1877-81)				3	0	0			
Guthrie, Mrs., in memory of the late Major C. O. James	5	0	0						
Gwilt, Alfred, Esq.	1	1	0						
Gwilt, Mrs.	1	1	0						
Gwilt, Mrs. Hannah Jackson (1877)				10	10	0			
H. and F. M., in aid of Hummersea, Whitby, or Staithes Life-Boats (1875-6)	15	0	0						
H. B. T. (1867-81)				12	0	0			
H. E. U., Bitterne (1874)				100	0	0			
H. G. (1870)				10	10	0			
H. M. (1877)				25	0	0			
H. R. (1871)				25	0	0			
H. R. S. (1875)				10	0	0			
H. S. C. (1859-81)				500	0	0			
Haarbleicher and Schumann	1	1	0						
Haerdashers, Worshipful Company of (1878-80)				15	15	0			
Hack, C., Esq., Poplar	5	0	0						
Hackett, Ausender, and Co. Messrs.	1	1	0						
Hacon, The Misses	1	0	0						
Haddington, The Earl of	1	0	0						
Haigh & Son, Messrs. W.				0	10	6			
Halford, Lady	1	1	0						
Hall, John, Esq., Addiscombe	2	2	0						
Hall, Miss M. S.				0	10	0			
Hall, Miss, Whitechurch	1	1	0						
Hall, Richard, Esq., Wigton	1	1	0						
Hall, Richard, C. Esq., Bath	1	0	0						
Hall, The Misses, Penge (1881-2)				0	10	0			
Hallam, C. T., Esq.				0	10	0			
Halsey, Mrs. (1881-2)				1	0	0			
Hambro & Son, Messrs. C. J.	1	0	0						
Hamilton, F. A., Esq.				10	10	0			
Hamilton, Rear-Admiral, C.B.	1	0	0						
Hamilton, Major T. B.	1	1	0						
Hammick, Mrs. W. M.	1	1	0						
Hand, Vice-Adm. G. S., C.B.	1	1	0						
Hankey, Capt. F. T. B., R.N.	1	0	0						
Hankey, George, Esq.				1	1	0			
Hankey, Capt. Walter A. (1879)				10	10	0			
Hankey, E. A., Esq., Elmhurst (1882)	50	0	0						
Hankey, Wm. Barnard, Esq.	1	0	0						
Hanmer, Capt. J. G. J., R.N.	0	10	0						
Hanson, Mrs.				0	10	6			
Harcourt, Adm. F. E. Vernon	1	1	0						
Hardie, Mrs. Peter, Bayswater (1874-82)	40	5	0						
Hardie, Thos. Kincaid, Esq., do. (1874-82)	50	5	0						
Hardwick, Mrs. F. W.	1	1	0						
Hardy, Mrs.				1	1	0			
Hardyman, Miss C. J.	1	1	0						
Hare, John, Esq., Stonehouse	1	1	0						
Harker & Co., Messrs. G.	1	1	0						
Harper, A. C., Esq. (1881)							2	2	0
Harper, E. N., Esq.	1	1	0						
Harper, Henry L., Esq., Kensington (1882)							5	5	0
Harris, G. S. & P., Messrs.	1	1	0						
Harris, J., Esq., Thames St.	0	10	0						
Harris, Miss, Cambridge Terr. (1878-82)	15	0	0						
Harris, Miss, Brighton	1	1	0						
Harris & Dixon, Messrs.	2	2	0						
Harrison, C. A., Esq., Lincoln	2	2	0						
Hart, Henry, Esq., Rotherham				0	10	0			
Hartley & Co., Messrs. James	2	2	0						
Hartley, F., Esq., Exeter	0	5	0						
Hartley, Jas. Robt., Esq. (1881)				10	10	0			
Harton, Samuel, Esq.	1	1	0						
Harton, W. H., Esq., V.P.	2	2	0				15	10	0
Harvey and Greenacre, Messrs. (1875-8)	15	0	0						
Ditto				5	0	0			
Harvey, Charles, Esq.	1	1	0						
Harvey, H. M., Esq., Hexworthy (1866-79)							90	0	0
Harvey, Miss B. A., Ickwell Bury				1	0	0			
Harvey, the late Mrs. Alicia, Exors. of, Rev. G. M. Gorham and Rev. J. Holmes (1879)							20	0	0
Harvey, Wm. Mascall, Esq. (1881)				5	5	0			
Harvie, Miss Hannah (1877)				50	0	0			
Harwood, Knight, and Allen, Messrs.				1	1	0			
Haslam, Henry, Esq., Croydon	1	1	0						
Hassell, Mrs., C. G., Cheltenham				5	0	0			
Hastings & St. Leonard's Branch (1882)	25	0	0						
Haswell, Vice-Admiral W. H.	1	0	0						
Hatchett, Mrs. John	1	1	0						
Hatherton, Lord	1	1	0						
Hathornthwaite, Rev. R. (1881)				3	3	0			
Hatton, Miss A.	0	10	6						
Hatton, Mrs., Leamington	0	10	0						
Haverfield, Rev. W. R., M.A.	0	10	0						
Hawes and Hertz, Messrs.	0	10	0						
Hawker, Charles F., Esq.	1	1	0						
Hawkins, Clement J., Esq.	1	1	0						
Hawkins, Rev. Bradford D., in memory of E. B. C.	0	10	6						
Ditto (1882)							0	10	6
Hay, Adm. J. B. L.	2	2	0						
Hay, Adm. J. B. P.	1	0	0						
Hay, Mrs., Carshalton	0	10	6						
Ditto, (1879-81)							2	1	6
Haycock, Miss H., Clifton	1	0	0						
Hayes, Mrs. L., New Hampton	2	0	0						
Ditto (1877-80)							11	0	0
Hayes, Lieut. M. R., R.N., The late, per Vice-Admiral Hayes, C.B. (1881)	10	0	0						
Hayle Branch (1882)							10	0	0
Hayne, Chas. Seale, Esq., Eaton Square				1	0	0			
Haynes, Edmund C., Esq.	1	1	0						
Hay's Wharf, Proprietors of	1	1	0						
Hayter and Hayter, Messrs.	1	1	0						
Hayward, J. Fred., Esq. (1873-81)	41	5	0						
Head and Co., Messrs. H.	2	2	0						
Headfort, The Marquis of	2	0	0						
Hearne, T. P., Esq. (1869-81)				21	0	0			

	Ann. Subs.			Donations.				Ann. Subs.			Donations.		
	£.	s.	d.	£.	s.	d.		£.	s.	d.	£.	s.	d.
Heathorn, W., Esq., and Lady Prinn	2	2	0				Holland, Edmund, Esq., Hyde Park Square (1872-81)				36	10	0
Heath, Robert, Esq., St. George's Place	1	1	0				Holland, Mrs. J. C., Pinner	2	2	0			
Heatley and Son, Messrs.	1	1	0				Holland, The Hon. Mrs. F.	1	1	0			
Hemery, C., Esq.	0	10	6				Holmes, Saucroft, Esq.	1	0	0			
Henckell, Du Buisson, and Co., Messrs.	2	2	0				Home, Mrs., Edinburgh	0	10	0			
Henderson, Miss F., in memory of the late J. Henderson, Esq., R.N.	2	2	0				Homer, C. G., Esq.	1	1	0			
Heneage, Major	5	5	0				Homer, Rev. H. "In Memory of his Mother"	0	10	0			
Henley-on-Thames Branch (1882)				14	3	7	Honychurch, Mrs., Dartford	0	10	6			
Hennell, Thomas, Esq.	0	10	0				Hood, Admiral, C.B.	2	0	0			
Henning, E. Nares, Esq.	0	10	6				Hood, Miss Jacomb (1864-71)				91	0	0
Henning, Mrs., Orsett Ter. (1882)				1	0	0	Hooper, A., Esq., Royal Institution (1863-82)				30	0	0
Henry, Lieut.-Col.	1	1	0				Ditto	1	1	0			
Henty, C. P., Esq., Chichester	1	1	0				Hooper, A. D., Esq., Lloyd's	1	0	0			
Hepburn, Mrs. Emily M.	1	1	0				Hooper, Miss A. M., Bristol	2	2	0			
Herbert, Dennis, Esq.	1	1	0				Hooper, Miss E., Gloucester	0	10	0			
Herd, Mrs. J.	1	1	0				Hooper, Mrs. H., Blackheath	1	1	0			
Hereford, Miss Lucy, Mordiford	4	0	0				Hooper, T. W., Esq., Southsea	1	1	0			
Herring, Messrs. G. & A., & Co.	1	1	0				Hope, Charles, Esq.	1	1	0			
Herring, Miss J. E.	1	0	0				Hope, Mrs. W. C., Bath (1873-81)	39	5	0			
Hertford, The Marquis of (1879)				10	10	0	Hopkins, Mrs., Northleigh	1	0	0			
Ditto	2	2	0				Hopkins, Miss R. (1873)				10	0	0
Hetherington, John M., Esq. (1871)	115	10	0				Hopkins, Rev. Canon	1	1	0			
Hewett & Co., Messrs. J. D.	2	2	0				Hopkins, Rev. F.	2	2	0			
Hewetson, Thos. Esq.	1	1	0				Hopkins, The Misses, Nottingham	5	0	0			
Ditto (1873-81)				7	7	0	Hopkins, Joshua Scales, Esq. (1874)	50	0	0			
Hewitt, The Misses, Lytham (1873-82)	600	0	0				Hopkinson, Mrs., Ichester	2	2	0			
Heywood, E. S., Esq.	2	2	0				Hopton Chapel Sick and Funeral Society	3	3	0			
Hichens, A. K., Esq.	1	1	0				Horn, Mr. J. E., West India Dock Road	1	1	0			
Hickes, Miss C., Bath	1	0	0				Hornby, Rev. Phipps J.	1	0	0			
Hickes, Mrs. A. J., the late, per Miss Hickes, Bath (1875)				100	0	0	Horniman, John, Esq.	1	1	0			
Hickman, Mrs. (1869-80)				12	11	0	Horrockses, Miller, and Co.	2	2	0			
Hickman, Miss (1869-79)				15	15	0	Horschitz and Co., Messrs.	1	1	0			
Ditto	1	1	0				Horton, Rear-Admiral W.	1	0	0			
Higham, W. S., Esq.	0	10	6				Horton, T. E., Esq.	3	3	0			
Hilhouse, Miss	0	10	6				Hotchkis, John, Esq.	1	0	0			
Hilhouse, Miss Harriett	0	10	6				Hotham, Beaumont, Esq.	1	0	0			
Hill and Sons, Messrs. J.	1	1	0				Hotham, The Hon. Lady	2	2	0			
Hill, F., Esq., Hampstead	1	0	0				Hothfield, the Right Hon. Lord	3	3	0			
Hill, Jas. D., Esq.	3	3	0				Hovell, J. R., Esq. (1872-82)				9	8	0
Hill, Lord Arthur William	5	5	0				Hovenden, F. P., Esq. (1872-81)	280	0	0			
Hill, Major	1	1	0				How, Mrs., Aspley	0	5	0			
Hillier, Miss M. A.	1	0	0				Howard, Dr., Sandycroft	1	1	0			
Hillier, W. G., Esq.	2	0	0				Howard, Geo., Esq., Palace Green	2	0	0			
Hillman, Mrs. Clerk	1	0	0				Howard and Escombe, Messrs. (1879)	10	10	0			
Hills and Underwood, Messrs.	1	0	0				Howson, F. J., Esq.	1	1	0			
Hills, E. H., Esq. (1881)	2	2	0	2	0	0	Hoyland, Rev. J., Brierly	1	1	0			
Hills, F. C., Esq., Deptford	1	1	0				Hubbard, Colonel C. J.	1	0	0			
Hills, F. Ernest, Esq., Redleaf	2	2	0				Huddersfield Branch (1881-2)				114	7	0
Ditto (1880)				15	0	0	Hudson, Mrs. W.	1	1	0			
Hilton, Anderson, and Co., Messrs.	0	10	6				Hudson, Thos., Esq.	1	1	0			
Hilton, Jas., Esq., Shawhall	2	2	0				Hughes, Fredk., Esq., Reigate (1879-82)	5	0	0			
Hindley, W. H., Esq.	1	1	0				Hughes, H., Esq., Elm Park	0	10	6			
Hirsch, J. F. Esq.	0	10	0				Hughes, Miss, East Bergholt	1	0	0			
Hoblyn, Jas., B. P., Esq. (1869-81)				11	11	0	Hughes, W., Esq., Meole	1	1	0			
Hobson, Chas., Esq., Beverley	1	1	0				Hull Branch (1882)				102	12	10
Hobson, Mrs., Taunton	1	1	0				Hunt, C. Brooke, Esq.	1	0	0			
Hodd and Sons, Messrs. R.	1	1	0				Hunter, John & Co., Messrs.	2	0	0			
Hodgkinson, W. S., and Co., Messrs.	1	1	0				Hunter, Mark William, Esq. (1872-81)	39	18	0			
Hodgson, E. D., Esq., Temple	1	1	0				Hunter, the Misses Harriet & Isabella, in memory of their mother (1881)	100	0	0			
Hodgson, F. C., Esq., Downing Street	1	10	0				Hunwicke, F. S., Esq.	1	0	0			
Hodgson, F. W., Esq., Friday Street	1	1	0				Hurst, T. G., Esq.	0	10	6			
Hodgson, Miss, Penge (1882)				1	1	0	Husey and Son, Messrs. R. A.	1	1	0			
Holden, E. T., Esq., Walsall	1	1	0				Hutchins, Mrs., Portland Place	1	0	0			
Holder, Chas. V., Esq.	5	0	0				Hutchinson, A., Esq. (1860-81)	230	0	0			
Holland, Commander S.C., R.N.	1	1	0				Hutchinson, Miss, Longworth (1881-2)	75	0	0			
							Hutchinson, Miss C. (1863-81)	32	0	0			
							Hutchinson, Miss Fanny (1871-81)	22	0	0			

LIST OF DONATIONS AND ANNUAL SUBSCRIPTIONS.

543

	Ann. Subs.			Donations.		
	£.	s.	d.	£.	s.	d.
Hutchinson, Miss, Great Malvern (1877-80)				16	1	0
Ditto	1	1	0			
Hutchinson, Rev. J. R., B.D.	1	0	0			
Huth & Co., Messrs. F. (1864-73)				21	0	0
I. W. (1877)				10	0	0
F'Anson, Charles, Esq.	1	1	0			
Image, Mrs., Mildenhall (1879-80)				10	10	0
Image, W. E., Esq.	1	1	0			
Imlach, R. W., Esq., Demerara	1	1	0			
Ingilby, Sir William	1	1	0			
Inglis, J., Esq., Colchester	1	1	0			
Ingram, Mrs. Herbert	5	5	0			
Ingram, Rev. H. M.	1	0	0			
"In Memoriam" (1875-6)				150	0	0
"In Memoriam"	25	0	0			
"In Memory of a Sister who was an Annual Subscriber" (1877)				50	0	0
"InterCruces," per Mrs. Dalton(1876-81)				11	11	0
Ipswich Branch (1882)				43	15	9
Irby, Rev. The Hon. L. C. R.	1	1	0			
Iredell, Chas., Esq.	1	1	0			
Iredell, Major J. S.	1	0	0			
Ironmongers, Worshipful Company of (1863-73)				21	0	0
Irving, Mrs. Colonel (1860-81)				22	10	0
Isle of Purbeck Branch (1882)				25	0	0
Isle of Whithorn Branch (1881)				20	0	0
Ivegill Church Temperance Society	0	10	6			
Iver, Archd., Esq.	1	1	0			
J. B. S.	5	0	0			
J. B. W. (1879)				50	0	0
J. C. (Birmingham) (1870)				20	0	0
Ditto	2	2	0			
J. C. and J. S. C. (1869-82)				25	0	0
J. E. D.	1	1	0			
J. D. (1870-81)				16	10	0
J. G. (1877)				100	0	0
J. H., an Ex-Sailor (1881)				0	10	0
J. S.	10	0	0			
J. S. (1878-81)				15	0	0
J. S. A. (1872-81)				21	12	0
J. S. G. H. D. (1881)				0	10	0
J. T. C. (1862-75)				73	10	0
J. W. (1871-81)				40	0	0
Jackson and Till, Messrs.	1	1	0			
Jackson, Miss (1881-2)				2	2	0
Jackson, Miss H. A., Gloucester	1	1	0			
Jackson, Rev. J.	0	5	0			
Jackson, S., Esq.	1	1	0			
Jackson, W., Esq., Tower St.	1	1	0			
Jacobs, Alfred M., Esq.	1	1	0			
Jacomb, Charles, Esq. (1868-72)				21	0	0
Jaffray and Co., Messrs.	5	0	0			
James, F., Esq., Kensington (1877)				50	0	0
James, Robert, Esq., Store Street	1	1	0			
Jamieson, Hugh, Esq. (1878-80)				12	12	0
Janson, R., Esq.	1	1	0			
Jaunsey, G. M., Esq.	2	2	0			
Jeffery, Miss S.	1	0	0			
Jenkins and Phillips, Messrs.	1	1	0			
Jenkins, A. H., Esq. (1877)				50	0	0
Jenner and Sons, R. and H.	2	2	0			
Jenson, John, Esq.	1	1	0			
Jersey Swimming Club	1	0	0			
Jobson, W. W., Esq.	1	1	0			

	Ann. Subs.			Donations.		
	£.	s.	d.	£.	s.	d.
Johnson, Admiral	1	0	0			
Johnson, F., Esq.	0	5	0			
Johnson, David, Esq., Chester	1	1	0			
Johnston, T., Esq.	2	2	0			
Johnston and Sen, Messrs. Botolph Lane	1	1	0			
Johnston & Sons, Messrs. N., Seething Lane	1	1	0			
Johnston, Sons, & Co., Messrs. E., Great St. Helens	1	1	0			
Jones, C. W., Esq., the late, Cheltenham	1	1	0			
Jones., H. Cadman, Esq.	1	1	0			
Jones, James, Esq., Ramsey	1	1	0			
Jones, Miss Isabella G. E., Bayshill	1	1	0			
Jones, Miss S., Cheltenham	1	1	0			
Jones, Mrs., Faversham (1878)				25	0	0
Jones, Winslow, Esq., Exeter	1	1	0			
Joy, Mr., Deal				0	10	6
Jubb, John, Esq., J.P. (1879-81)				15	0	0
Jubb, Samuel, Esq., Batley (1875)				10	0	0
K. and E. C. (1873-81)				35	0	0
"K. M. Y. C." The (1882)				1	0	0
K. S. (1880-1)				3	0	0
K. W. (1878)				20	0	0
Kaye, C., Esq., Northwich	1	0	0			
Kaye, Miss E. F.	2	2	0			
Keal, Miss, Hereford	1	1	0			
Keeling, Rev. Wm., B.D.	1	1	0			
Keighley Branch (1882)				30	11	1
Keiler, William, Esq.	2	0	0			
Kellock, Messrs. C. W. & Co.	1	1	0			
Kelly, Mrs., Ealing	1	1	0			
Kelso Branch (1882)				22	2	6
Kemble, Mrs. Henry	10	10	0			
Kemble, William, Esq.	5	0	0			
Kempster, John, Esq., and Mrs.	1	1	0			
Kennard and Co., Messrs. S.	2	2	0			
Kendal, T. Herbert, Esq., Woodleigh (1871-81)				9	4	0
Kennaway, Rev. W. B., Weymouth (1881)				25	0	0
Kennedy, Adm., C.B.	1	1	0			
Kent and Co., Messrs. G. B.	0	10	6			
Kent, Henry, Esq., Shepherd's Bush	1	1	0			
Kent, Mrs. Henry, Ditto	1	1	0			
Kent, T. J., Esq. (1871)				10	10	0
Kent, Rev. Chas., Ludlow	1	0	0			
Keppel, Admiral the Hon. Sir Henry, K.C.B.	1	1	0			
Keppel, W. H. A., Esq.	1	0	0			
Kidd, Miss Pringle (1877-81)				40	0	0
Kidd, Mrs.	1	1	0			
Ditto (1882)				1	1	0
Kiddle, Com. W. W., R.N. (1879-81)				10	10	0
Kiddle, Mrs. W. W. (1880-81)				10	10	0
Kilvert and Sons, Messrs., Manchester	1	1	0			
Kimeridge Branch (1882)				25	0	0
Kinahan and Co., Messrs.	5	5	0			
King, G., Esq., Algiers	2	2	0			
King, Mrs., Algiers	2	2	0			
King, Miss Louisa A.	1	0	0			
King, Miss Sarah, Skipton	1	0	0			
King, Messrs. H. S. and Co.	2	2	0			
Kinglake, Rev. F. C.	1	1	0			
King's Lynn Branch (1882)				28	8	11
Kingstown Branch (1882)				18	8	7
Kinloch, Miss, Sussex Place	1	0	0			
Kirk, Miss, Guildford	0	10	6			

	Ann. Subs.		Donations.			Ann. Subs.		Donations.		
	£.	s.	d.	£.		s.	d.	£.	s.	d.
Kirkliston Branch (1881)				5	2	6				
Knight, Fred., Esq.	0	10	0							
Knill and Co., Messrs. J.	2	2	0							
Knowles and Foster, Messrs. (1851-70)	102	10	0							
Knowles, the late Miss M.	5	0	0							
Knox, B. D., Esq., Ardmillan	2	0	0							
Ditto (1872)				10	0	0				
Knox, Lady Louisa	1	0	0							
"L." (1875)				10	5	0				
L. A. R. (1873)				50	0	0				
L. E. B. (1881)				5	0	0				
L. E. W., Croydon	0	10	0							
Laddie, Mr., per Mrs. Dalton (1877-80)	18	18	0							
Ladda, Capt. W.	0	10	6							
Laing, Capt. Jas. (1880-1)				2	2	0				
Lambert Bros., Messrs.	2	2	0							
Lambert, F. D., Esq.	5	0	0							
Lambert, T., Esq.	2	2	0							
Lampard & Foster, Messrs.	1	1	0							
Lampson, George C., Esq.	2	2	0							
Lancaster Branch (1882)				150	4	10				
Lancaster, Mrs. Mary	1	1	0							
Lance, Mrs., Redhill	1	1	0							
Land, Philemon, Esq. (1874-82)				400	0	0				
Landon, Mrs., Putney	2	2	0							
Landon, The Misses (1881)				1	5	0				
Lane, Rev. T. L.	1	0	0							
Lanerton, Lady	5	0	0							
Langley, Charles, Esq.	1	1	0							
Langley, Miss	1	1	0							
Langton, Miss Maria	1	1	0							
Langton, Rev. Charles	5	0	0							
Langton, W. Gore, Esq. (1865-72)	250	0	0							
Lansdell, Mr. G.	1	1	0							
Lanyon, J. C., Esq.	1	1	0							
Larcom, Mrs. Capt.	1	0	0							
Larden, Rev. G. F., D.C.L.	1	10	0							
Larking, Alfred J., Esq.	2	2	0							
Larwill, Miss F. R.	1	1	0							
Laurie, Mrs., St. George's Place, per Rev. Sir Emilius Bayley, Bart. B.D. (1876)				500	0	0				
Law, the Hon. H. S.	1	1	0							
Lawrence, G. H., Esq. (1870-8)				34	0	0				
Ditto	2	0	0							
Lawrence, Gen. H.	1	1	0							
Lawrence, Miss J., Wimbledon	0	10	0							
Lawrence, Mrs.	1	1	0							
Lawrence, Mrs., City Road (1882)	10	0	0							
Lawrence, Rev. H. Geraldton, Western Australia	0	10	0							
Lawrence, Sydney, Esq., Clapham Park (1882)				50	0	0				
Lawson, Miss Elizabeth	10	0	0							
Laye, Mrs., Southsea	1	0	0							
Le Bailly, H. J., Esq., Edinburgh	2	2	0							
Le Cocq, Capt. W. G., R.N.	5	0	0							
Le Lacheur, John A., Esq.	2	2	0							
Le Marchant, The Dowager Lady	1	1	0							
Lea, Charles Wheelley, Esq., Worcester (1881)				100	0	0				
Lea, M., Esq. (1865-82)				18	18	0				
Leach, Francis, Esq.	1	1	0							
Learmonth, W. Livingstone, Esq. (1882)	1	10	0							
Leathersellers, Worshipful Company of (1874)				10	10	0				
Leckie, Messrs. J. B. & Co.	1	1	0							
Ledger, J. W., Esq.	1	1	0							
Ledoux, M. Henri, Demerara	1	1	0							
Ledward, Chas. A., Esq., Fairlawn	2	2	0							
Ledward, Miss F. G., Ditto	0	5	0							
Lee, James, Esq., Notting Hill (1876-81)							3	0	0	
Lee, Miss, Kinfare	2	2	0							
Lee, Mrs., Towcester (1876-80)										9
Lee, Son, and Co., Messrs. Wm. (1873)				21	0	0				
Leeds Branch (1882)				78	14	5				
Leek Branch (1881)				26	15	6				
Legge, Gen. the Hon. A. C.	2	0	0							
Legge, Lieut.-Col. the Hon. E.H.1	1	1	0							
Leicester Branch (1881)							70	0	0	
Leigh, Mrs. D. H.	1	1	0							
Leiningen, Capt. H.S.H. the Prince, R.N., G.C.B.	1	0	0							
Leishman, Inglis, & Co.	1	1	0							
Leman, Henry, Esq. (1876-81)							16	13	0	
Letchworth, Miss, Woburn	1	1	0							
Lethbridge, Mrs. A. G.	3	3	0							
Lethbridge, Rev. J. K., M.A.	0	10	0							
Levesley, B., Esq.	0	10	0							
Levi, Miss C.	0	10	0							
Lewis, Professor Hayter (1872)							10	10	0	
Lewis, R. Esq., Inner Temple	1	1	0							
Lewis, Mrs. Richard, Gloster Place	1	1	0							
Lewis, R. E., Esq., Anerley	1	1	0							
Lewis, Richd., Esq., Hereford	1	1	0							
Leyland, Mrs. Naylor	5	0	0							
Liddell, H. T., Esq., Colwall (1860-79)	106	0	7							
Liddon, E., Esq., M.D.	1	1	0							
Liddon, J., Esq., Wimbledon	1	1	0							
Liddon, W., Esq.	0	10	0							
Liebenrood, Capt. J., R.N. (1866-82)				47	10	0				
Lightfoot, Mrs. General	1	10	0							
Lightfoot, Miss	1	10	0							
Lightfoot, J. E., Esq., Ac-crington	1	1	0							
Lighton, Sir C. R., Bart.	1	1	0							
Lilian, per H. Bentwitch, Esq. (1882)				1	1	0				
Lincolnshire Coast Shipwreck Association Branch (1882)				50	0	0				
Lindesay, Lieut. A. H., R.N.	1	0	0							
Lindley, W., Esq., C.E. (1864-81)				11	10	0				
Linford, Mrs. W. T.	1	1	0							
Lingen, Sir R. Ralph W., K.C.B.	2	2	0							
Lingham, Mrs.	1	1	0							
Linney, Albert, Esq.	0	10	0							
Lintott, W., Esq., Horsham	1	1	0							
Lister, Beck, and Co., Messrs.	1	1	0							
Littleboro' Co-operative Soc.	2	2	0							
Littledale, C. R., Esq. (1876-82)							18	12	0	
Littledale, Major (1861-9)				250	0	0				
Ditto							10	10	0	
Littlehales, Capt. E., R.N.	1	0	0							
Little, Mrs., Penge (1881-2)							0	10	0	
Liveing, Miss C.	0	5	0							
Liverpool and New Brighton Branch (1881)							350	0	0	
Lloyd, Matheson, & Co., Messrs.	1	0	0							
Lloyd, Mrs. G. J. M.	1	1	0							
Lloyd, Miss, Twickenham	0	10	0							
Lloyd's, The Committee of	10	10	0							
Lockwood, Miss	1	1	0							
London Assurance Corporation (1870)				31	10	0				
Long, Captain S., R.N.	5	0	0							
Longman, C. J., Esq.	1	1	0							
Longridge, the Misses	1	1	0							
Longson, Joseph, Esq., Kirkham (1882)				5	0	0				
Longstaff, Messrs. F. & Sons	1	1	0							
Lonsdale, W., Esq. (1872)							20	0	0	
Love, Mr. William, Paisley (1860-81)				22	0	0				
Loveday, J. T., Esq., Norwood	1	1	0							
Low, Alex. F., Esq.	2	2	0							
Lowdell, Miss, Baldwyns (1871)				10	10	0				
Lowdell, Mrs., Bedales (1873)				50	0	0				

LIST OF DONATIONS AND ANNUAL SUBSCRIPTIONS.

545

	Ann. Subs.		Donations.			Ann. Subs.		Donations.					
	£.	s. d.	£.	s. d.		£.	s. d.	£.	s. d.				
Lowe, Rev., H. E., M.A.	3	3	0		Marine and General Mutual								
Lowndes, Rev. E. S.	1	1	0		Life Assurance Society	10	0	0					
Lowndes, Rev. W. D.	0	5	0		Mark Lane Life-boat Fund, <i>vide</i> p. 558.								
Loyd, Mrs. Lewis (1859-81)			45	5	0	Markby, Alfred, Esq. (1878-81)	20	0	0				
Lucas, Mrs. C. H.	1	1	0		Markham, Chas., Esq., North-								
Lury, Miss (1877-81)			0	15	0	ampton	1	0	0				
Luscombe, Mrs.	2	0	0		Marks, J. C., Esq., Swansea (1880-2)	7	10	0					
Lushington, Mrs. J. D.	2	0	0		Marriott, Capt. Edwd.	1	1	0					
Luttrell, Miss, St. Katherine's (1861-70)	36	10	0		Marriott, Miss, Clipstone (1882)			0	15	0			
Lutwidge, C. R. Fletcher, Esq.	1	1	0		Marryat and Sons, Messrs. J.	2	2	0					
Lyall, George, Esq., the late	2	2	0		31	10	0						
Lyall, W. H., Esq.	1	1	0		Marryat, Charles, Esq.			1	1	0			
Ditto (1881)			5	5	0	Marsh, Miss, Gloucester			1	0	0		
Lyde, Rev. Wm., M.A. (1881)			1	1	0	Marshall, A., Esq., Huntingdon			1	1	0		
"Lydia," Southampton (1874-81)			4	2	0	Marshall, C., Esq., Huntingdon			1	1	0		
Lyell, Miss C., Shielhill (1877-8)			20	0	0	Marshall, Rev. E. (1854-77)			33	14	6		
Ditto			1	0	0	Ditto			1	0	0		
Lyell, The Misses (1871)			10	0	0	Marshall, J. M., Esq., Wal-							
						lingford			1	1	0		
M. (1863-82)			19	19	0	Marter, Miss Mary B.			1	1	0		
M. (1873-4)			150	0	0	Marter, Wm. Ingram, Esq.			1	1	0		
M., per Messrs. Coutts & Co. (1867-82)			47	0	0	Martin, Capt. W. L., R.N.			1	0	0		
M. A. F.			1	1	0	Martin, Dowager Lady (1880)					10	0	0
M. A. L., per W. Arnott, Esq. (1872)	200	0	0		Martin, E. M., Esq.			5	5	0			
M. A. S. (1879-81)			4	0	0	Martin, J. Stapleton, Esq.			0	10	0		
M. B. T. W. (1869-75)			150	0	0	Martin, J. B., Esq., Lombard Street (1873)			10	10	0		
Ditto (1877)			50	0	0	Martin, Capt. Leslie (1873)			25	0	0		
M. C. M. (1869-73)			10	0	0	Martin, Mrs., West Buckland			2	2	0		
M. E. C.			2	2	0	Martin, The Misses, Bloomsbury							
M. E. I.			1	1	0	(1869-75)			18	12	6		
M. E. W. E. C. (1877-81)			5	0	0	Martin, T., Esq., St. Austell			1	1	0		
M. M. M., In Memory of			10	0	0	Martin, Rev. Glanville			1	1	0		
M. R.			5	0	0	Martineau, Miss F., Clapham			2	2	0		
M. R., "A Thank-offering" (1872)			20	0	0	Martyn, Miss Jane A., Carthew			5	0	0		
M. S. S.			1	1	0	"Mary," Wisley (1882)					1	1	0
M. T. (1865-75)			25	0	0	Mason, Miss, Lillington			0	10	6		
M. T. (1880-1)			2	0	0	Mason, Rev. J. M., Langley			1	1	0		
Macan, Lieut.-Gen. H., C.B.	2	0	0		Massey, R., Esq., Handforth			2	0	0			
MacAndrew & Co., Messrs. R.	2	2	0		Massy-Beresford, Very Rev.								
Macdonald, D., Esq., Larne (1875-9)	25	0	0		John M.			1	0	0			
Macdonald, Miss, Victoria Gardens (1881)			5	0	0	Masterman, N., Esq.			5	0	0		
MacDonald, The Misses	2	0	0		Mathew, Major E. W., Wem.			2	2	0			
Mackenzie, Colonel	2	2	0		Mathews, G. H., Esq.			2	2	0			
Mackenzie, Mrs. E.	2	2	0		Matthews and Luft, Messrs.			1	1	0			
Mackeson, H. B., Esq.	1	1	0		Matthews, W. E., Esq. (1881)					10	0	0	
Mackie, Dr., Alexandria (1880)			1	0	0	Matthie, Miss, Penge (1881-2)					0	15	0
Mackinlay, Mrs., Regents Park			1	1	0	Matveiff and Co., Messrs.			1	0	0		
Mackreth and Fosters, Messrs.	1	1	0		Maude, Capt. Hon. F., R.N.			1	1	0			
Maclean, Maris & Co., Messrs.	1	1	0		Maude, John, Esq., Clapham			1	1	0			
Macleod, Capt. R. B. E., R.N.	2	2	0		Maudslay, Chas. E., Esq.			1	0	0			
Macmillan and Sons, Messrs.	1	1	0		Maudslay, Henry, Esq.					11	0	0	
Macpherson, Hugh M. Esq. (1881)			1	0	0	Maudslay, Son, and Field			2	2	0		
MacWhirter, John, Esq., and Miss MacWhirter (1871-81)			38	19	0	Maughan, Mrs. (1881-2)					2	0	0
Magrath, Rev. J. R.			0	10	0	Mawe, Mrs., Hampstead (1882)					1	8	6
Maingay, Mrs.			2	0	0	Maxwell, Rev. E.			2	0	0		
Maitland, Capt. H. L., R.N.	1	1	0		Maxwell, Col. G. Shirley			1	0	0			
Major and Field, Messrs.	1	1	0		Maxwell, Lieut.-Gen. H. H., R.A.					10	0	0	
Major, C. M., Esq.	1	1	0		Mayne, Adm. R. C., C.B.			1	1	0			
Malcolm, W. E., Esq.	1	0	0		Mayor, Mrs. J. B. (1882)					1	0	0	
Mallam, Richard, Esq.	1	0	0		Ditto collected by Toby (1882)					1	3	5	
Maltby, Major E. P.	1	1	0		McArthur, Messrs. W. & A.			2	2	0			
Manchester Branch (1882)			220	12	9	McBayne, Miss Frances (1875-82)					16	0	0
Manley, A. E., Esq.			2	0	0	McCance, Henry J., Esq.			0	10	0		
Mann, Mrs. Dixon			1	1	0	McDonogh, Mrs., Molesey			2	2	0		
Mannock, W. M. S. P., Esq.			1	1	0	McDougall Bros., Messrs.			1	1	0		
Mansel, J. C., Esq.			1	1	0	McEwan and Co., Messrs. J.			1	1	0		
Marcet, W., Esq., M.D. (1869-81)			18	18	0	McHardy, Admiral			1	1	0		
March, Lieut., Santander			0	10	0	McIlwraith M'Eacharn & Co.							
Margate Branch (1882)			28	3	5	Messrs.			1	1	0		
Margetts, Mrs. H.			1	1	0	McKerrell, Wm., Esq. (1863-72)					80	0	0
						McNeill, Sir J., G.C.B.			1	0	0		
						Mead, Joseph B., Esq.			1	1	0		
						Meaden, W. J., Esq. (1882)					2	2	0
						Meadows, T., and Co., Messrs.			1	1	0		
						Meares, Thos., Esq.			1	1	0		
						Medlycott, Capt. M. B., R.N.			1	1	0		

	Ann. Subs.		Donations.			Ann. Subs.		Donations.	
	£.	s. d.	£.	s. d.		£.	s. d.	£.	s. d.
Medwin, Dr. A. G.	1	1	0		Morehead, Dr. C.	1	1	0	
Mee, Mrs. J. H.	1	1	0		Morgan & Co., Messrs. J. S.	1	1	0	
Meggeson and Co., Messrs.	1	1	0		Morgan & Medhurst, Messrs.	1	1	0	
Melhuish, Sons, & Co., Messrs.	1	1	0		Morice, John C., Esq.	1	1	0	
Meller, Capt. A., Ipswich (1874-9)			30	0 0	Morland and Sons, Messrs. J.	1	1	0	
Mellish, Henry, Esq.	1	1	0		Morley, Mrs., Derby	1	1	0	
Mellish, Mrs. Leigh	1	1	0		Morpheew, J., Esq., Jermyn St.	1	1	0	
Mellor, The Hon. Justice (1878)			50	0 0	Morrice, R. E., Esq., Eitham (1872-6)			10	10 0
Melrose Branch (1882)			15	1 9	Morrison, Col. Robert			2	2 0
Melville, Lady F.	1	1	0		Morris, Prevost, & Co., Messrs. (1864-73)			15	10 0
Mendelssohn & Co., Messrs. (1881)			1	1 0	Morris, Mrs., Lee (1879-81)				1 10 0
Merchant Taylors, Worshipful Com- pany of (1857-76)			147	0 0	Morris, Jas., Esq., Cadogan Place (1881)			20	0 0
Meredith, Miss Emma (1870-81)			24	8 3	Morrison, Mrs., Reading (1881)			50	0 0
Merrick, Col.	1	0	0		Morrison, Miss, Reading (1881)			10	0 0
Metcalf, Mrs., Jersey	1	1	0		Morton, Mrs. (1864-81)			35	14 0
Methuen, Rev. H. H.	0	10	0		Morton, Rose, & Co., Messrs.	1	1	0	
Meux & Co., Messrs.	5	5	0		Mosenthal, Sons, and Co., Messrs. J.	1	1	0	
Michell, Rev. T. H.	1	1	0		Moser and Sons, Messrs. (1878)			10	0 0
Michie, A. S., Esq.	1	0	0		Moss and Co., Messrs. C.	2	2	0	
Michie, Mrs. A. S.	1	0	0		Moss, Mrs. G. W.	2	2	0	
Middleton, The Misses (1860-76, in addition to 30l. 5s. collected			42	12 6	Moss & Co., Messrs. R. J.	1	0	0	
Miland, Mrs., Wimbledon	2	0	0		Moules, G., Esq., Sutton (1865-72)			21	0 0
Milburn, Messrs. William, & Co.	5	5	0		Moysey, Rev. F. L.	1	1	0	
Miller, R. M., Esq.	1	1	0		Muff, F. B., Esq., Ilkley	1	1	0	
Miller, Mrs., Roehampton (1880-2)			9	4 0	Mullens, J. A., Esq., Lom- bard Street (1880-1)			52	10 0
Millington & Co., Messrs. W.	1	1	0		Müller, C. J., Esq.	1	1	0	
Millington, C., Esq.	1	1	0		Munns, Col. E. C. (1874-81)			8	7 0
Mills, J., Esq., Yateley	1	1	0		Munns, Mr., Wrexham	1	1	0	
Mills, Mark, Esq. (1864-80)			85	5 0	Murdock & Co., Messrs., Glasgow (1881)			1	1 0
Mills, Wm., Esq., Clapham	1	1	0		Mure, Mrs. Geo. Herringswell (1873)			10	0 0
Millward, Wm., Esq.	1	1	0		Murphy, J. J., Esq., Lisburn	1	0	0	
Milne, Mrs. J. D., Aberdeen (1864-75)			12	0 0	Muspratt, Henry, Esq., "A Thank- offering for mercies bestowed on him- self and family" (1875)			10	0 0
Milner, Chas., Esq., Sheffield (1882)			10	0 0	Musselburgh Branch (1882)			14	2 9
Milner, Rev. E. W. (1881)			10	0 0	Mytton, Miss, Welshpool	2	2	0	
Minotto, Alex., Esq., Alex- andria	1	0	0						
Mitchell, A. C., Esq.	1	1	0		N., per Messrs. Morris, Pre- vost, and Co.	5	0	0	
Mitchell, F. H., Esq. (1857-81)			114	0 0	N. B. A. (1875)			30	0 0
Mitchell, F. J., Esq., Newport	1	1	0		N. F. H.	1	1	0	
Mitchell, G. W., Esq.	0	10	0		N. L., Dublin (1861-79)			80	0 0
Mitchell, J. H., Esq.	2	2	0		Napier, Rev. J. W.	1	1	0	
Mitchell, W. R., Esq., Wim- pole Street	1	1	0		Nash, C., Esq., Kensington (1878-81)			4	0 6
Mitchell, Yeames, and Co., Messrs.	5	0	0		Nash, F., Esq., Ludlow	1	1	0	
"Modern Lower Remove," The, Harrow (1881-2)			5	0 0	Naylor, Benzon, & Co., Messrs.	5	5	0	
Moir, Mrs. M. T.	1	1	0		Naylor, Joseph Ulysses, Esq.	1	1	0	
Moline and Co., Messrs. (1865-73)			41	10 0	Neale, Miss C., Brighton	0	10	6	
Molison, Mrs., Errol (1881)			500	0 0	Neilson & Sons, Messrs. Claud	2	2	0	
Molyneux, Lady Georgina (1874-7)			15	0 0	Nelson, Dale, & Co., Messrs.	1	1	0	
Molyneux, Miss	0	10	0		"Nemo"	5	0	0	
Moncrieff, Colonel	1	0	0		Nesbitt, Messrs. A. & W.	1	1	0	
Montague, A., Esq., Penton	1	1	0		Nesbitt, Miss Downing (1877-8)			10	0 0
Montgomerie & Workman, Messrs.	1	1	0		Neumann, G., Esq., Honiton	1	0	0	
Montgomery, John, Esq.	5	0	0		Neve, Mrs. R.	0	5	0	
Montgomery, Sir G., Bt., M.P.	2	0	0		Neville, M., Jun., Esq. (1882)			0	10 0
Montrose Branch (1881)			40	0 0	Newark Branch (1882)			25	10 0
Moody, Miss, Derby	0	5	0		Newbon, Robt. Alger, Esq.	1	1	0	
Moon, R., Esq., Coventry	2	2	0		Newcastle Trinity Board	10	10	0	
Moore, Rev. G. B., Tunstall (1857-80)			42	0 0	Newhaven Branch (1882)			20	0 0
Moore, Capt. Richmond, R.N.	1	1	0		Newman, Mrs., Sen.	0	10	0	
Moore, The late Lieut.-Gen. R. C., C.B.			2	0 0	New River Company	1	1	0	
Ditto, and Mrs. Moore (1871-6)			12	0 0	New Romney Branch (1881)			4	19 0
Moore, W., Esq., Bury St.	0	10	6		Newsom, S. H., Esq., Cork	1	0	0	
Moore, W., Esq., Wierton	1	1	0		Newsom, Mrs. Geo., Clapham	1	1	0	
Moore, W. B., Esq., Hampstead (1881)	21	0	0		Newsom, Thomas, Esq.	1	1	0	
Moore, W. E., Esq., Royal Exchange (1876)			100	0 0	Newton Abbott Branch (1882)			20	4 0
Moorsom, Rev. J. R.	1	1	0		Newton, F. W., Esq.	1	0	0	
					Newton, Lieut. W. H., R.A. (1873-5)			20	0 0
					Ditto			5	0 0
					Newton, Miss			2	3 0
					Nicholl, Henry F., Esq.	5	5	0	
					Nicholson, G. P., Esq., Wath	2	2	0	

LIST OF DONATIONS AND ANNUAL SUBSCRIPTIONS.

547

		Ann. Subs.		Donations.				Ann. Subs.		Donations.			
		£.	s.	d.	£.	s.	d.	£.	s.	d.	£.	s.	d.
Nicholson, W. L., Esq.		1	1	0				Pacific Steam Navigation Co.	5	5	0		
Nicolson, Admiral Sir F. W., Bart., C.B.		1	0	0				Padstow Branch (1882)			10	0	0
Nixon, C. J., Esq., Bourne-mouth		1	1	0				Paine, J., Esq., Springfield	2	2	0		
Noble, John, Esq., Park Place (in addition to gift of Life-boat and House)		2	0	0	20	0	0	Paine, Wm., Esq., St. Neot's	1	1	0		
Noble, R. H., Esq., Caversham Hill		3	0	0				Painter, T., Esq., Wrexham	1	0	0		
Noble, Wilson, Esq., Henley Ditto (1881)		2	2	0	8	8	0	Palfrey, E. W., Esq., Texas (1882)			1	0	6
Norris, Miss A. H.		0	10	0				Palmer, Col. G.	1	1	0		
Norwich National Fisheries Exhibition Committee of (1881)					25	0	0	Palmer, George, Esq.	1	1	0		
Noel, Eugene F., Esq.					10	10	0	Palmer, Miss, Manton (1860-82)			22	15	0
Nolloth, Dr. E., R.N.		1	0	0				Palmer, Rev. H. G. (1880)			5	5	0
Norfolk Branch (1882)					110	7	5	Pantin, Messrs. W. & C.	1	1	0		
Norsworthy, G., Esq.		1	1	0				Parbury, Mrs.	1	1	0		
Norsworthy, H., Esq. (1866-77)		100	0	0				"Parish Pump," The (1881)			1	1	0
Northampton Branch (1882)					21	18	0	Parker, F., Esq. (1877)			10	0	0
Northampton, The Marquis of		5	0	0				Parker, Miss (1875)			10	0	0
Northey, E. R., Esq., Epsom (1878)		10	0	0				Parker, Miss, St. Clear's (1862-71)			20	0	0
Northumberland, Duke of		2	0	0				Parker, Rev. Wm. (1858-77)			41	0	0
Nottingham Branch (1882)					38	19	0	Parker, Mrs., and Friends, Fifehad			1	0	0
Nottingham, Mrs., in memory of her late uncle, A. Worthington, Esq., Whitechurch (1874)					250	0	0	Parkin, Miss, Leonfield	1	1	0		
"Number 99, East Sussex" (1881-2)					10	0	0	Parkin, Miss M. J., ditto	1	1	0		
Nutter, James, Esq.		0	10	6				Ditto (1879-81)			8	8	0
								Parkin, W., Esq., Blaithewaite	1	0	0		
Oakes, Arthur, Esq.		1	1	0				Parnell, John, Esq., J.P.	1	0	0		
Oakes, Mrs. (1871-81)					9	9	0	Parnell, Louis, Esq.	2	0	0		
Oakley, Christopher, Esq.		1	1	0				Parnell, Mrs. Gervas, Fetcham	1	1	0		
Odd Fellows, Independent Order of (M. U.) vide p. 558.								Partington, E., Esq.	1	1	0		
O'Donovan, The		1	1	0				Partridge, C., Esq., exors. of (1882)			2	0	0
Ditto (1881-2)					2	2	0	Pasley, Adm. Sir T. S., Bart., K.C.B.	1	0	0		
Offley, Forrester, and Co., Messrs.		2	2	0				Paterson, Laing, & Bruce, Messrs.	1	1	0		
Oliver, George, Esq.		1	1	0				Paton, Jas., Esq. (1882)			3	0	0
O'Maley, Michael R., Esq., Demerara		2	2	0				Pattenden, Philp., Esq., Brixton	1	1	0		
O'Maley, Miss, Demerara (1881)		0	10	6				Paul, H. T., Esq.	2	2	0		
Onslow, Lady, M.A. (1882)		2	2	0				Paulet, Lady Henry (1862-72)			32	0	0
Onslow, Miss M. (1881) (in addition to her gift of the Sennen Life-boat)					3	0	0	Paulin, G., Esq., Lloyd's	1	1	0		
Oppenheim, Henry, Esq.		5	0	0				Pawle, J. D., Esq.	1	1	0		
Oram, Jas., Esq. (1863-82)					95	0	0	Payne, Miss H., Glenfield	1	0	0		
Ord, W. H. G., Esq.		1	1	0				Payne, W. H., Esq., Bolton	0	10	6		
Orde, Miss A. M. F. (1865-77)					30	0	0	Peach, The Misses, Langley Hall, further in aid of Memorial Life-boat (1877-81)			60	0	0
Ditto		1	1	0				Peacock & Buchan, Messrs.	2	2	0		
Ormerod, G. W., Esq., Brookbank (1875)		15	15	0				Peacock Bros., Messrs., Sunderland, for the s.s. Larch	1	1	0		
Ormskirk Branch (1882)					29	5	6	Peacock, Thos. B., Esq., Finsbury (1877)			10	10	0
Ormston, R., Esq. (1861-70)					42	0	0	Peale, W., Esq., Loose (1865-71)			100	0	0
Osborn, Mrs. C., Down End		1	1	0				Pearce, Maresco, Esq.	1	1	0		
Osborne, Martin, Esq.		1	1	0				Pearson, Miss Sophia	1	1	0		
Osborne, Miss (1881-2)					0	15	6	Peart, H. B., Esq.	2	0	0		
Osborne, Rev. Philip		2	10	0				Peckover, A., Esq., Wisbeach (1857-81)			50	0	0
Otter, Mrs. H. C., Bruntsfield		1	1	0				Peckover, J., Esq., the late, ditto	2	2	0		
Otter, E. H., Esq., Downlands		5	0	0				Peckover, W., Esq., ditto (1857-74)			80	0	0
Otway, Rear-Adml. R. J.		5	0	0				Peebles Branch (1882)			20	0	0
Outram, Sir Francis, Bart.		5	0	0				Peek, Winch & Co., Messrs.	5	5	0		
Outram, The Dowager Lady		2	0	0				Peel, Sir Robert, Bart., G.C.B. (1871)			20	0	0
Overstone, The Rt. Hon. the Lord (1865-82)					271	0	0	Peel, Edmund Yates, Esq.	2	0	0		
Ovey, The Misses (1865-72)					90	0	0	Pelham, Lord (1876)			10	10	0
Owen & Graham, Messrs. (1866-77)					56	5	0	Pemberton, E. L., Esq., M.P. (1868-73)			31	0	0
								Pembroke and Montgomery, The Earl of (1875)			250	0	0
P. H. H. E. (1882)					2	10	0	Penarth Branch (1881)			15	15	0
P. P. (1879)					10	0	0	Penfold, E. H., Esq.	2	2	0		
Pace, Rev. Henry H., Dorchester		1	1	0				Peninsular and Oriental Steam Navigation Company	5	5	0		
								Penn and Sons, Messrs. John	5	0	0		
								Pennington, Mrs., Thickthorn	1	1	0		
								Penny, Louis, Esq., Beckenham	1	0	0		
								Penny, Thos. S., Esq., Taunton	1	1	0		
								Penson, Miss	0	10	6		
								Penson, Mrs.	3	3	0		
								Penzance and Sennen Branch (1882)			9	1	3
								Pepys, J. A., Esq. (1880-2)			21	0	0
								Percy, Lady Louisa (1870-8)			150	0	0

	Ann. Subs.		Donations.			Ann. Subs.		Donations.			
	£.	s. d.	£.	s. d.		£.	s. d.	£.	s. d.		
Percy, The Right Hon. the Earl, P.C., M.P.	2	0	0		R. B. and Co. (1867-82)	122	7	0			
Perrott, Sir E. G. L., Bart., V.P.	1	1	0		R. B. J. (1881)	5	0	0			
Pertwee, Joseph, Esq. (1867-71)			130	0	0	R. H., Rosedale (1882)	1	1	0		
Peterhead Branch (1882)			20	0	0	Rabbetts, Rev. F. D., M.A. . . .	0	5	0		
Peters, The Misses Nowell	0	10	0		Rackham, Willoughby, Esq. . . .	2	2	0			
Perre, John Berney, Esq.	2	2	0		Radcliffe, Josiah, Esq., Bryn Dinarth (1881)			5	5	0	
Phillips & Co., Messrs. J. & N.	10	10	0		Radcliffe, John, Esq., Furlane . . .	1	1	0			
Phillips, J. W., Esq.		2	0		Rahn and Co., Messrs.	2	2	0			
Phillips, Miss, Leamington	1	1	0		Raincock, H. D., Esq., the late, Waltons (1881)			10	10	0	
Phillips, W. W., Esq.	1	1	0		Ralli Brothers, Messrs.	2	2	0			
Phillimore, Capt. W. B. (1859-82)	225	10	0		Ralph, Rowland W., Esq.	1	0	0			
Phillimore, Vice-Admiral A.	3	0	0		Ram, Rev. Stopford J.	1	0	0			
Phillips and Graves, Messrs.	1	1	0		Ramsay, Capt. John, R.E.	2	0	0			
Phillpotts, W. F., Esq.	1	1	0		Randells, Howells, and Co. . . .	1	1	0			
Pick, Edgar S., Esq.	1	1	0		Randolph, Admiral G.	5	0	0			
Pickersgill, Mrs. & Master Ernest (1881) .	0	12	6		Rawlins, Mrs., Tunbridge Wells	1	0	0			
Pickering, Leonard, Esq. (1872)	200	0	0		Rawlinson, J., Esq.	1	0	0			
Pickernell, Brothers, Messrs. (1881) . . .	1	1	0		Rawson, Miss, Tilney Street (1879) .	100	0	0			
Pickernell, F. C., Esq. (1881)	1	1	0		Rawson, Miss E., Nydd Hall (1880) .	100	0	0			
Piel Branch (1882)			20	0	0	Ray, Brisco, Esq., in memory of the late Richard Glaister, Esq. (1875)			10	0	0
Pigeon, Henry, Esq. (1864-79)			52	10	0	Ray, Capt. H. R. (1873)			10	0	0
Pike, Mrs. Justine (1873-8)			20	0	0	Ray, Rev. Henry, B.A.	1	1	0		
Pilcher, R.A., Esq., Cromwell Houses	1	1	0		Raymond and Reid, Messrs. (1873) .	50	0	0			
Pilgrim, C. H., Esq.	2	2	0		Reading Branch (1882)	143	4	1			
Pirie and Co., Sir John	2	2	0		Redfern, Alexander, and Co.	5	0	0			
Pitt, Miss E., Ossington Street (1874-82) .	4	0	0		Reece, Miss (1869-77)	24	0	0			
Platt, Fredk., Esq., Oldham (1873)	90	0	0		Reeves, A., Esq.	0	5	0			
Platt, Owen, Esq., Manchester	2	2	0		Regent's Canal Company	3	3	0			
Playne, Peter, Esq. (1860-79)	95	0	0		Reid, P., Esq., Stock Exchange (1879) .	50	0	0			
Plymouth Branch (1881)	50	0	0		Reinachs, Nephew, and Co.	0	10	6			
Poë, Rev. J. Leslie	1	1	0		Reiss Bros., Messrs.	2	2	0			
Pol, Paris, Esq. (1871)	10	10	0		Remington, Rev. T. M.	2	2	0			
Port of Rochester Branch (1881-2)	17	5	6		Rendell, Jas. & Sons, Messrs. . . .	1	1	0			
Porteous & Senior, Messrs.	2	2	0		Reneau, Mr. & Mrs. R. P. W.	1	1	0			
Porter, Rev. C. F.	0	10	0		Reynardson, Rev. G. B. (1865-72) . . .	15	0	0			
Porter, Capt. H. R.	1	1	0		Ditto	2	0	0			
Portrush Branch (1882)			12	0	0	Reynardson, Rev. J. B.	1	1	0		
Postans and Sons, Messrs.	0	10	6		Reynolds, Rear-Admiral	0	5	0			
Potter, J. D., Esq.	2	2	0		Reynolds, E. M., Esq.	1	1	0			
Potts, John E., Esq. (1882)			5	5	0	Reynolds, J., Esq.	0	10	6		
Powell, Messrs. T. J. and T.	1	1	0		Rich, H. T., Esq., Hounslow	0	6	6			
Poyer, J. P., Esq.	1	1	0		Richards, M., Esq.	1	1	0			
Poynder, William, Esq., Hartham Park (1874)			500	0	0	Richardson, Brothers and Co.	1	1	0		
Prall, Z. E., Esq.	2	2	0		Richardson, James G., Esq.	1	0	0			
Pratt, Mrs. H., Leamington (1863-82) . . .	210	10	0		Richardson, Jonathan, Esq.	1	0	0			
Pratt, T. R., Esq., Daventry (1881) . . .	10	0	0		Richardson, Miss	0	10	6			
Prescott, H. W., Esq.	2	2	0		Richardson, Miss, per Mrs. Dalton (1881-2)			7	2	0	
Preston, Miss L. F. M.	5	0	0		Richardson, T., Esq.	1	0	0			
Price and Pierce, Messrs.	5	5	0		Rickards, Walter, Esq. (1879)	10	0	0			
Price, Miss, Gloucester	1	1	0		Rickett, Smith, & Co., Messrs. . . .	1	1	0			
Price, Mrs. Admiral (1880-1)	20	0	0		Ricketts, Miss Frederica L.	1	1	0			
Priestley, Wm., Esq.	1	1	0		Riddell, Miss, Beaufort Grdns. . . .	2	2	0			
Primrose, The Hon. B.F., C.B.	2	2	0		Ridge, Henry, Esq., Stock Exchange (1876-82)			16	16	0	
Prince, John, Esq.	2	2	0		Ridgway & Co., Messrs.	2	2	0			
Prince, Ogg and Co., Messrs.	1	1	0		Ridpath, E., Esq.	1	1	0			
Pritchard, J., Esq.	1	1	0		Rigge, H. F., Esq.	1	1	0			
Pritchard, Mrs., Astley Abbots	1	1	0		Riley, C., Esq.	1	0	0			
Prowett, N. H. E., Esq. (1862-82)	65	0	0		Rivaz, Charles, Esq.	1	1	0			
Prowse, Capt. G. J. W.	1	1	0		Rivington, Septimus, Esq.	1	1	0			
Pryor, Miss, Penge (1881-2)			0	15	6	Roake, J. J., Esq., Anerley	0	10	0		
Psaila, Luigi, Demerara	1	1	0		Robartes, The Rt. Hon. Lord	2	2	0			
"Psalm 107"	1	0	0		Roberts, C. W., Esq.	1	1	0			
"Psalm 66, 13-14" (1881)	20	0	0		Roberts, Jas., Esq., Brockley	1	1	0			
"Pug," per Mrs. Dalton (1882)	2	2	0		Roberts, Miss, Slade End	0	10	6			
Pugh, Miss, Leighton	0	10	6		Roberts, W. H., Esq., Brixton (1881) .	5	5	0			
					Robertson, Capt. G. M.	5	0	0			
					Robertson, Graham, Esq., F.R.G.S., Cleveland Square (1880-1)			20	0	0	
"Queenie," per Mrs. Dalton (1882)	3	3	0		Robertson, Henry, Esq., Hull (1873) .	100	0	0			
Queensbury, Marquis of	2	2	0								
Quick, Rev. R. H., M.A.	2	2	0								

LIST OF DONATIONS AND ANNUAL SUBSCRIPTIONS.

549

	Ann. Subs.		Donations.			Ann. Subs.		Donations.		
	£.	s. d.	£.	s. d.		£.	s. d.	£.	s. d.	
Robertson, Henry, Esq., Glasgow (1880)	20	0	0		Samuelson, B., Esq., M.P.	5	5	0		
Robertson, Mrs., Girton (1863-79)	17	0	0		Samuelson, Miss F. A. (the late)	0	10	6		
Robertson, J. C., Esq.	1	0	0		Sanders, S., Esq., De Vere Gardens	2	2	0		
Robins, Miss, Woburn Place	1	0	0		Sanders, F., Esq., Cross Keys	1	1	0		
Robins, Miss G., ditto	1	0	0		Sandford, T. H. Esq., Sandford	5	0	0		
Robinson, F. J., Esq., Chester St.	2	2	0		Sandwich, The Countess of (1872-82)	80	0	0		
Robinson, G., Esq., Skipton	1	1	0		Sandwich, The Earl of	1	1	0		
Robinson, Lawson, Esq.	1	1	0		Sandys-Lumsdaine, Mrs.	1	1	0		
Robinson, Miss M. (1881)			1	0	Santley, Charles, Esq. (1879)			20	0	0
Robinson, Rev. Henry (1874)			10	0	Sartoris, Alfred, Esq.	5	0	0		
Robinson, Rev. T. B. B.	1	1	0		Sartorius, Sir G. R., Admiral of the Fleet, K.C.B.	1	1	0		
Rochdale Branch (1881)			76	12	Sassoon and Co., Messrs. D.	2	2	0		
Rochester, Thomas, Esq. (1870)			1000	0	Saul, G. T., Esq., Bow	1	1	0		
Rockley, J., Esq., Boro'	1	1	0		Saunders, Mrs., Durham Ter.	2	2	0		
Rodocanachi, Sons, and Co.	1	1	0		Savage and Hill, Messrs.	2	2	0		
Rodwell, Mrs. Helen, Winchester (1863-77)			91	9	Savory and Moore, Messrs.	3	3	0		
Rogers, Mrs., Westbourne Sq.	1	1	0		Saxe-Weimar, General H.S.H. Prince Edward of, K.C.B.	1	0	0		
Roget, Mrs., Maida Hill	1	1	0		Scales and Rogers, Messrs.	0	10	0		
Rohrweger, J. C., Esq.	1	1	0		Scarborough Branch (1882)			75	0	0
Rolle, The Hon. Mark	10	0	0		Scarth, W., Esq., Highbury	1	1	0		
Rolleston, Miss, Bath	1	1	0		Schilizzi and Co., Messrs. (1867-74)			37	16	0
Rolt and Co., Messrs. Peter	2	2	0		Schloss Brothers, Messrs.	0	10	0		
Romilly, Cosmo, Esq. (1881)			10	10	Scholey, Mrs.	1	1	0		
Ropes, W. H., Esq.	1	1	0		Schroder & Co., Messrs. J. H.	2	2	0		
Rose, Mrs. A. M., Fulham	1	1	0		Scorer, A., Esq.	1	1	0		
Rosher, W. H. Burch, Esq. (1880)	10	10	0		Scott & Dinham, Messrs.	1	1	0		
Ross, Wm. Lewis, Esq.	2	2	0		Scott, E., Esq., Colchester (1869-81)	8	6	0		
Ros-e, Dowager Countess of	2	0	0		Scott, Fredk. A., Esq. (1881)			1	0	0
Rothery, H. C., Esq., M.A. (1880)			25	0	Scott, Harold Spencer, Esq.	1	1	0		
Rothschild, Messrs. N. M., & Sons	10	0	0		Scott, Patrick, Esq.	1	1	0		
Routh, Miss A.	1	0	0		Scott, Rev. Canon	1	1	0		
Routh, W. D., Esq.	5	0	0		Scott, Rev. M. R., M.A., & Miss	1	1	0		
Rowbotham, Dr. Wm.	0	10	6		Scott, R. H., Esq., M.A.	1	1	0		
Rowlandson, Miss Ann	1	1	0		Scringeur, Mrs., Highgate (1872-81)	57	5	0		
Rowley and Davies, Messrs.	1	1	0		Scringeur, Miss, Dorking	1	0	0		
Rowley, Col. Sir C., Bart.	2	2	0		Ditto proceeds of sale of Fancy Articles (1881-2)			1	0	0
Royal Harwich Yacht Club	2	2	0		Scriveners, Worshipful Company of (1860-78)			37	7	0
Royal Mail Steam Packet Co. (annual)			10	0	Seager, Charles H., Esq. (1872-8)			15	15	0
Royal Yacht Squadron	10	0	0		Seaton Carew Branch (1881)			1	1	0
Rubie, J. P., Esq., Cowes	1	1	0		Sebag, Joseph, Esq. (1877-81)			15	0	0
Ruck Bros., Messrs.	0	10	0		Seely, Chas., Esq., M.P. (1872)			20	0	0
Ruck, Mrs. Marie, on behalf of the late Josiah Ruck, Esq. (1881)	100	0	0		Selborne, The Lord	2	0	0		
Rudge, W. N., Esq., the late (1865-81)	52	10	0		Semple, A., Esq., Maida Vale	2	2	0		
Rufford, F. T., Esq.	1	1	0		Senior, J., Esq., Streatham	2	2	0		
Rugg, Mrs. J. S.	1	1	0		Senior, Julian, Esq. (1877-9)			31	0	0
Ruskin, Professor, M.A.	5	0	0		Settle Branch (1881)			175	13	2
Rust, George J., Esq.	1	1	0		Seyern, J. P., Esq.	3	3	0		
Rutherford Brothers, Messrs.	1	0	0		Sewell, Miss A., Louth (1882)			0	10	0
Rycroft, Chas. A. W., Esq. (1863-71)	25	0	0		Sewell, Mrs., Brompton	1	1	0		
Ryder, Admiral A. P.	1	0	0		Sewell, W., Esq., Richmond.	1	1	0		
					Seyd and Co., Messrs.	1	1	0		
					Shackleton, Richard, Esq.	3	3	0		
					Shafro, Mrs. J. D.	1	0	0		
S. C. H. (1859-77)	41	11	0		Ditto in aid of Swanage Lifeboat (1875)			50	0	0
Ditto	1	1	0		Ditto (1881-2)			100	0	0
S. H. H., "Little Colonial"	1	1	0		Sharp, A. M., Esq., Epworth	1	1	0		
S. M., Kensington (1882)	10	10	0		Sharp, Sidney, Esq.	2	0	0		
S. S., Tunbridge Wells (1882)	2	2	0		Sharpe and Co., Messrs. R.	1	1	0		
S. W., per C. S. W.	1	0	0		Sharpe, Sutton, Esq.	3	0	0		
S. Y. N. (1872-80)	40	0	0		Sharps and Wilkins, Messrs.	1	1	0		
Sabel, Max, Esq.	1	1	0		Shaw, Miss L. C.	0	5	6		
Saddlers, Worshipful Company of (1877-8)	30	10	0		Shaw, Rev. F.	1	1	0		
Sadler, Harrison, and Co.	2	2	0		Shaw, Savill, and Co., Messrs.	1	1	0		
Saker, W. E., Esq.	2	2	0		Sheffield Branch (1882)			44	16	6
Salisbury, Mrs. L. (1881)			1	0	Sheepshanks, W., Esq.	1	1	0		
"Sally-forth," per Mrs. Dalton (1878-81)	14	14	0		Sheldon, Rev. J. (1881-2)			20	0	0
Salmon, Capt. Henry Thomas (1875)	10	0	0		Shepard & Co., Messrs.	2	2	0		
Salt, John Chas., Esq. (1879)	10	10	0		Shepherd, Arthur, Esq. (1869-74)			41	0	0
Salters, Worshipful Company of	5	5	0		Shepherd, Major Howell (1859-80)			50	0	0
Samuel, Mrs. J., Ryde (1881-2)	4	2	0							

	Ann. Subs.		Donations.			Ann. Subs.		Donations.	
	£.	s. d.	£.	s. d.		£.	s. d.	£.	s. d.
Sherwood, Joseph, Esq. (1862-78)			15	15	0	Society for the Discharge and Relief of Persons Imprisoned for Small Debts, additional	100	0	0
Shewell, Rev. Frank, M.A.	1	1	0			Sommer, Chas., Esq., New-castle-on-Tyne	1	1	0
Shiffner, Miss J. P. (1871-82)			25	4	0	Somes, Mrs. Joseph	1	1	0
Shipp, T. P., Esq.	1	1	0			Somes and Co., Messrs.	1	1	0
Short, F. B., Esq., Buckham (1878)			10	0	0	Soper, Joseph, Esq., Dawlish (1873)	25	0	0
Short, Mrs., Hastings	2	0	0			"Son of a Sailor, and one who has so often been exposed to the dangers of the sea" (1881)	15	15	0
Ditto (1869-75)			55	0	0	Soule, Bernard M., Esq.	1	1	0
Shropshire Branch (1882)			11	1	0	Souter, Miss, Norwood	1	1	0
Shuckburgh, Sir Geo., Bart.	1	1	0			South Devon Shipping Co.	3	3	0
Ditto, Contribution Box			18	6	5	South Metropolitan Gas Light and Coke Company (1864-81)	73	10	0
Shum, Robert, Esq. (1880)			10	10	0	Southard and Co., Messrs.	2	2	0
Sibthorp, Colonel	5	0	0			Spaldin, Miss, Hull	1	1	0
Ditto (1874)			10	0	0	Spalding Shipwreck Society	1	0	0
Sim, Captain Alexander, the late	1	1	0			Sparks, Mrs. Wm.	0	10	0
Simes, N. P., Esq., Horsham	1	1	0			Spartali and Co., Messrs.	1	0	0
Simon and Dale, Messrs.	2	2	0			Spawforth, Joseph, Esq.	5	5	0
Simonds, Robt. Henville, Esq.	1	1	0			Spawforth, Mrs. E.	2	2	0
Simper, Mrs., Salisbury	1	1	0			Spence, Frank, Esq. (1881)	2	2	0
Simpson, B. W., Esq.	1	1	0			Spencer, Maitland, Esq., Underleigh (1875-6)	30	0	0
Simpson, Lightly, Esq.	1	1	0			Spencer, W., Esq.	2	2	0
Simpson, The Misses, Hadley	0	10	0			Spencer, Rev. W. M.	1	1	0
Sinclair, Mrs., Greenock (1874)			20	0	0	Sperling, Arthur, Esq.	1	1	0
Sismey, Mrs., Hadley Green	2	2	0			Sperring, Henry John, Esq. (1878)	10	0	0
Skinnners, Worshipful Company of (1865-77)			52	10	0	Spicer, J. J., Esq.	1	1	0
Slater, Henry, Esq.	1	1	0			Spies Bros. and Co., Messrs. (1879-81)	25	0	0
Slater, John, Esq., "A Thank-offering to Almighty God for his late mercies"			10	0	0	Spottiswoode, James, Esq., Perth (1859-73)	30	0	0
Ditto	1	1	0			Spreckley, White, and Lewis	2	2	0
Slater, Rev. Leonard, Bakewell (1881-2)			7	7	0	Sprigins, Miss, Bow	1	1	0
Smiles, Samuel, Esq., LL.D. (1882)			5	0	0	Staffordshire Potteries Branch (1881-2)	10	10	0
Smith and Co., Messrs. F.	2	2	0			Stafford, The Lord (1880)	10	0	0
Smith and Sons, Messrs. G.	2	2	0			Stallebrass, Mrs., South Hackney	0	10	6
Smith, Colonel J. (1866-82)			88	10	0	Stalschmidt, E. E., Esq. (1872)	10	10	0
Smith, Elder, and Co., Messrs. (1881)			6	6	0	Stamp, Mrs. Ann G., Hull	1	1	0
Smith, Geo., Esq., St. John's Wood	1	1	0			Standen, Wm., Esq.	0	10	0
Smith, Heathfield, Esq., Epsom (1864-81)	42	0	0			Standidge and Co., Messrs.	1	1	0
Smith, J. B., Esq., Wood Green			1	1	0	Standing, Geo. C., Esq.	0	10	6
Smith, J. MacLaren, Esq.	10	0	0			Stanley, W. F., Esq.	1	1	0
Smith, J. W., Esq., Oundle	1	1	0			Stannus, T. R., Esq.	0	10	0
Smith, Lieut.-Gen. J. W. S., C.B.	1	1	0			Stanton, J. T., Esq.	1	1	0
Smith, Mr. G., Walsall	0	5	0			Starkie, Mrs. (1867-75)	21	0	0
Smith, Mrs., Old Park	1	1	0			Starky, Mrs., Bronham	1	0	0
Smith, Mrs. Joseph, Newstead (1880)			5	5	0	Stead, J. J., Esq.	0	5	0
Smith, Mrs., Tavistock Square	1	1	0			Steains and Co., Messrs. J.	1	1	0
Smith, Mrs. Peploe	5	0	0			Stechford Branch (1882)	34	14	4
Smith, Mrs. W. Wilthrew	5	0	0			Stedman, Miss	1	1	0
Smith, Samuel, Esq., Bungay	2	2	0			Steel, Mrs., Cockermonth (1877)	10	0	0
Smith, T. H., Esq., Regina Road	1	1	0			Steinmetz, J. H., Esq.	1	1	0
Smith, Thomas Valentine, Esq., Grosvenor Road (1878)			10	10	0	Stennett, J. H., Esq., Miningsby (1877-9)	9	10	0
Smith, Thos., Esq., Cirencester	1	1	0			Stennett, Mrs., Pennerley (1882)	1	0	0
Smith, W. Arthur, Esq., Birmingham (1873-81)			21	0		Stephen, Mrs. Leslie	2	2	0
Smith, The Rt. Hon., W. H., M.P.	5	5	0			Stephens, P. S., Esq.	2	2	0
Smith, Wm., Esq., Woodfield	10	0	0			Stericker and Co., Messrs.	1	1	0
Smitheman, Mrs. F., Guildford (1879-81)			6	6	6	Sterling, Miss Julia	5	5	0
Smithers, H. W., Esq., Amsterdam (1872)			10	0	0	Stern, Baron Herman De, per M. Lea, Esq. (1878)	10	0	0
Smithers, H. W., Esq., Moor-gate Street	1	1	0			Stern Brothers, Messrs. (1876-7)	47	5	0
Smythies, G., Esq.	2	2	0			Stevenson, Miss H. B., Iver	3	3	0
Soame, The Misses	2	0	0			Steward, Rev. C. H.	1	1	0
Soames, Capt., R. A. (1881)			5	0	0	Stewart, Rev. J.	1	0	0
Soames, E., Esq. (1876)			10	10	0	St. Germans, Earl of	2	0	0
Soames, Miss L. K., Greenwich	0	5	0			Stiebel Brothers, Messrs.	1	1	0
Soames, W., Esq., Blackheath	2	2	0			Stilwell, Thomas, Esq. (1862-75)	42	0	0
						Stirling Branch (1882)	55	13	0
						Stock, Mrs., Bristol (In Memoriam)	2	2	0
						Stocken, F., Esq., Pimlico	1	1	0
						Stocks, Major, Halifax	2	2	0

LIST OF DONATIONS AND ANNUAL SUBSCRIPTIONS.

551

	Ann. Subs.		Donations.			Ann. Subs.		Donations.	
	£.	s.	d.	£.	s.	d.	£.	s.	d.
Stone, E. M., Esq., and Mrs.									
Stone	5	5	0						
Stone, J., Esq., Broad St.	1	1	0						
Stone, Mrs. John, Ashburton	1	0	0						
Stonehaven Branch (1881)				15	0	0			
Stopford, Mrs. Grosvenor . . .	1	0	0						
Stowers, Rev. H. M.	1	1	0						
Strahan, W. S., Esq., Buxton	2	2	0						
Strange, Mrs. Mary Ann	1	1	0						
Streatfield, R. J., Esq.	5	0	0						
Streddart, Capt. (1882)				3	16	0			
Street, George, Esq.	1	1	0						
Strickland, A. E. C., Esq. . . .	1	1	0						
Stuart, Colonel, J. F. D. C., M.P.	2	0	0						
Stuart, Geo., Esq.	3	0	0						
Stucley, Lieut.-Colonel	1	0	0						
Sturge, Geo., Esq., Woodthorpe (1882)	21	0	0						
Sturgeon, Samuel, Esq. (1881)		1	0	0					
Sturrock, Archibald, Esq. . . .	2	2	0						
Stutfield, W., Esq.	1	1	0						
Stutfield, Mrs. (1867-76)				45	0	0			
Stuart, Mrs. Alfred	1	0	0						
Sugden, Richard, Esq.	1	1	0						
Sugg, Henry, Esq., Reading . . .	1	1	0						
Sullivan, Capt. T. B. M., R.N.	1	0	0						
Summerson, T. R., Esq.	0	7	6						
Surr, Watson, Esq.	1	1	0						
Surrey Commercial Dock Co.	5	5	0						
Sutherland, H., Esq., Dulwich	1	1	0						
Sutherland, His Grace the Duke	5	0	0						
Sutherland, R., Esq., Egham	5	0	0						
Swanage Branch (1882)				12	0	0			
Swansea Branch (1882)				40	0	0			
Swanzy, Messrs. F. and A. . . .	1	1	0						
Swinburne, Sir J., Bart., F.R.S.	5	0	0						
Sx. B.	0	10	6						
Sykes, J., Esq.	2	2	0						
Sykes, Miss, Bristol	1	1	0						
Symes, Mrs. Elizabeth S., in addition to Poolbeg Life-boat (1881)				10	0	0			
Symons, Wm. Thos., Esq.	2	2	0						
T. A. S., Rothwell St. (1881)				2	2	0			
T. H. N., Thanksgiving for a safe voyage (1870)				10	0	0			
T. J. K. (1871-81)				15	15	0			
T. J. M. (1877-81)				70	0	0			
T. J. S.	0	5	0						
T. M. C. (1881)				1	1	0			
Taddy and Co., Messrs.	3	3	0						
Taite, Charles, Esq.	1	1	0						
Talbot, Lady	1	1	0						
Tallow Chandlers, The Wor- shipful Company of (1869-70)				21	0	0			
Tangye Bros., Messrs.	1	1	0						
Tanqueray & Co., Messrs. C. . . .	2	2	0						
Tanqueray, Mrs., Canonbury . . .	1	1	0						
Tapling and Co., Messrs. Thos. . .	2	2	0						
Tapper, A. A., Esq.	1	1	0						
Turner, A. T., Esq.	2	0	0						
Turner, E. T., Esq.	1	0	0						
Turner, G. Edward, Esq.	1	1	0						
Turner, H. T., Esq.	1	0	0						
Turner, Miss C. T.	0	10	0						
Turner, Miss L. T.	0	10	0						
Tarratt, Josh., Esq.	2	2	0						
Tarratt, Mrs., Ashford Hall (1877)				300	0	0			
Tassell, Mr. F.	0	5	0						
Tate, Miss C. E.	1	1	0						
Tatham, C. N., Esq. (1882)				2	2	0			
Tattersall, John, Esq., one year's main- tenance of a Life-boat station (1877)	70	0	0						
Tatton, Lees W., Esq., Man- chester	1	1	0						
Tatton, Mr. Samuel, Chorley	0	10	0						
Taunton, Miss, in memory of the late Lady Taunton	1	1	0						
Taunton, Mr. T.	0	5	0						
Tawke, A., Esq., and Mrs. Tawke, The Lawn, Rochford	0	10	0						
Taylor and Sons, Messrs. J.	1	1	0						
Taylor, Charles, Esq., Man- ningtree	1	1	0						
Taylor, J. D., Esq. (1865-79)				85	0	0			
Taylor, Rev. Alfred R.	1	1	0						
Taylor, Wm., Esq.	1	1	0						
Taylor, W., Esq., Jun.	1	1	0						
Taylor, W. R., Esq.	0	10	0						
Teevan, Major G. J.	1	0	0						
Temperleys, Carter, & Darke	1	1	0						
Tempest, J., Esq., Derby	1	1	0						
Templer, R. B., Esq.	1	1	0						
Terry, John, Esq.	3	3	0						
Tesdorpf & Co., Messrs. A.	2	2	0						
Tetley and Co., Messrs. J.	0	10	0						
Tetley, Son, & Layton, Messrs. . . .	1	1	0						
Tetley, The Misses, Oaklands (1869-82)	85	0	0						
"Thank-Offering for Oct. 8th, 1881"				1	1	0			
Thames & Mersey Marine In- surance Co., Royal Exchange	5	5	0						
Thomas, Capt. Montagu, R.N. (1868-82)	69	0	0						
Thomas, Charles, Esq.	0	10	6						
Thomas, D. C., Esq.	0	10	6						
Thomas, Mr. W., Caerphilly	0	10	0						
Thompson, Adam, Esq.	1	1	0						
Thompson, Vice-Adm. T. P.	1	0	0						
Thompson, Henry, Esq.	1	1	0						
Thompson, Messrs. W. J. & H. . . .	2	2	0						
Thorley Rectory, Bishop's Stortford	2	2	0						
Thorngate, W., Esq. (the late), Trustees of	80	0	0						
Threlfall, Chas., Esq.	5	5	0						
Threlfall, Mrs.	1	1	0						
Thresher, Capt. W. (1871-80)				15	15	0			
Ditto	2	2	0						
Thurlow, Major Edwd. H.	1	1	0						
Thwaites, D., Jun., Esq. (1868-70)				15	0	0			
Tidd, Frederick A., Esq. (1870) . . .				10	10	0			
Tidd, Walter R., Esq. (1873)				10	10	0			
Tindall, Riley, & Co., Messrs. . . .	1	1	0						
Tindall, W. H., Esq.	1	1	0						
Tinley, Mr. R. R.	0	10	0						
Tippinge, F. Gartside, Esq.	1	1	0						
Tisdall, Mr. Sidney	1	0	0						
Toke, Major	1	1	0						
Tollemache, Hon. Algernon Grey (1867-77)				250	0	0			
Tomkinson, Thomas, Esq. (1864-74)	115	0	0						
Toms and Co., Messrs.	0	10	0						
Toppin, Miss, Putney	1	1	0						
Torquay Branch (1882)				105	0	0			
Towgood, Alfred, Esq.	1	1	0						
Towgood, Edw., Esq.	2	2	0						
Townend and Co., Messrs. T.	1	1	0						
Toynbee, Capt. H.	1	1	0						
Tramore Branch (1881)				10	0	0			
Trinder, Anderson, & Co.	3	3	0						
Trotter, Mrs., Thurlow Sq.	5	0	0						
Ditto (1881)				10	0	0			
Trotter, William, Esq. (1872-81)	60	0	0						
Troyte, C. A. W., Esq.	1	1	0						
Tryon, Hon. Mrs.	1	0	0						
Tudor, E. O., Esq.	1	1	0						
Tudor, Henry, Esq.	1	1	0						
Tudor, Mrs. W. Langley	1	1	0						

	Ann. Subs.		Donations.			Ann. Subs.		Donations.	
	£.	s. d.	£.	s. d.		£.	s. d.	£.	s. d.
Tulloch, General, R. A.	1	1	0		Walker Gum Company, Limited	1	0	0	
Tupp, Mr. J., Tottenham Court Road (1874-81)			7	16	0	Walker, John, Esq., Halifax (1876)	20	0	0
"Tuppence," per Mrs. Dalton (1882)	2	2	0		Walker, Lady	1	1	0	
Tupper, Hon. Mrs. (1882)	1	0	0		Walker, Miss Mary, Peterboro'	0	5	0	
Turle, James, Esq., M.D.	1	1	0		Walker, Philip A., Esq.	1	1	0	
Turle, Mrs.	0	10	6		Walker, Thos., Esq., M.D., Peterborough	1	1	0	
Turner, Miss, Holloway	0	10	0		Walker, W. N., Esq. (1873-6)	1	1	0	15
Turner, Miss J., Cotton Rectory	1	1	0		Ditto	1	1	0	
Turner, Mrs., Liverpool (1877-81)	200	0	0		Wallace, Brothers, Messrs.	3	3	0	
Tweddle, Mrs. Thomas (1872-81)	17	17	0		Walrond, C. T., Esq.	1	1	0	
Twenty-Two (1881)			0	10	0	Walsh, Mrs., Winchester	0	10	0
Twining, H. H., Esq.	1	1	0		Walters, Rev. A. V., B.A.	0	5	0	
Two Friends, per Miss Wor- sencroft	1	0	0		Walton, Charles, Esq.	1	0	0	
Two Sisters (1877-80)			8	0	0	Walton, Geo., Skipton (1873)			10
Tylden, Mrs., Oxford	1	0	0		Wanklyn, J. B., Esq. (1872)			10	
Tyndall, W. H., Esq.	1	1	0		Wanstall, Rev. R. C. (1882)			0	
Tyser, G. D., Esq., Lloyd's	1	1	0		Ward, Vice-Admiral J. R.	1	1	0	
Tyson, Miss H. (1881-2)			1	8	0	Ward, C. B., Esq.	1	1	0
Tyson, Mrs., Penge (1881-2)			0	10	0	Ward, Miss, St. Leonards	0	5	0
Tytler, Genl. J. M. B. Fraser, C.B. (1881)	2	0	0		Wardlaw, Major-Gen. R.	1	0	0	
					Ware, Nathl. Webb, Esq., Cork (1880)	10	0	0	
Uhthoff & Co., Messrs.	1	1	0		Warner, F., Esq., Hoddesdon	0	10	0	
Ulph, Messrs. J. B. and Son	1	1	0		Warner, J. T., Esq., Chertsey	0	10	6	
Union Steam Ship Company (1877)			10	10	0	Warner, R., Esq.	2	0	0
Unite, W. O., Esq.	1	1	0		Warner, W. H. Lee, Esq., Tiverton Court (1879-81)			6	
Upton, H., Esq.	3	3	0		Warren and Jones, Messrs.	0	10	6	
Urwick, W. H., Esq.	1	1	0		Warren, Mrs., Leamington (1861-82)	23	0	0	
Usborne and Sons, Messrs.	1	1	0		Warton, Capt. R. Gardner	1	1	0	
Usherwood, Miss	2	2	0		Waterall, Nathaniel, Esq.	1	1	0	
					Waterall, Roby, Esq.	1	1	0	
Vacher, E. P., Esq. (1871)			10	10	0	Waterfield, Mrs.	1	0	0
Vacher, H. P., Esq. (1871)			10	10	0	Waterfield, The Misses	2	2	0
Vanner and Prest, Messrs.	1	1	0		Waters and Co., Messrs. Jas.	1	1	0	
Vansittart, A. A., Esq. (1859-80)			160	10	0	Watson, C., Esq., Halifax	2	2	0
Vardon, Miss E.	1	1	0		Watson, J., Esq.	1	1	0	
Vardon, Mrs. F. (1868-81)			13	10	0	Watson, Lieut. H. J. (1875)			12
Vardon, H., Esq.	1	1	0		Watson, Col. W. H., R.A., in aid of Holy Island Life- boat			5	
Varnam, Miss H., Pailton	0	10	6		Watson, Mrs., Holland Park (1876-81)	60	0	0	
Vaughan, Henry, Esq. (1870-3)			30	10	0	Watson, Rev. G. Bowes	1	1	0
Vaughan, Mrs., Westbourne Terrace	5	5	0		Watts and Manton, Messrs.	2	2	0	
Venables, T. G., Esq. (1881)			2	2	0	Waugh, James, Esq.	1	1	0
Venning, Edgcombe, Esq.	1	1	0		Wayet, Rev. W.	2	2	0	
Verney, Capt. E. H., R.N.	1	1	0		Webb, Mrs. Holden	0	10	6	
Vernon, Miss Emma P.	1	1	0		Webb, R. T., Esq.	2	2	0	
Vernon, Rev. H. J., B.A.	0	10	0		Webb, W. L., Esq.	1	1	0	
Verrall, Miss Laura, Southover (1873)	50	0	0		Weber, Arthur, Esq.	1	1	0	
Verulum, The Earl of (1876)	10	0	0		Webster, George, Esq., Fins- bury Street, on account of a Life-boat (1864-78)			200	
Vesey, Capt., R.N. (1864-78)			21	0	0	Webster, Mrs., Ealing	1	0	0
Vigne, John, Esq.	1	1	0		Webster, W., Esq.	0	10	0	
Vincent, J., Esq.	1	1	0		Wedge, Fras., Esq. (1866-72)			30	
Vincent, Miss M., Pyrland Road (1881-2)	2	0	0		Welch, Henry, Esq., Bright- ton (1870-7)			31	
Vivian, Younger, and Bond, Messrs.	1	1	0		Welch, Margetson, and Co., Messrs.	1	1	0	
					Weldon, J., Esq. (1880)			10	
W. (1862-78)			80	0	0	Wells, Wm., Esq., Redleaf	1	0	0
W. A. D. (1875-82)			70	0	0	Welsh, A., Esq. (1878-9)			10
W. B., Barnsbury	1	1	0		Ditto	5	0	0	
W. B., Hull (1881)			0	10	0	Welsh, W. S., Esq., Wells	1	1	0
W. F. S., Lloyd's (1877)	25	0	0		Wentworth, Miss L. M. H. V. (1870-9)	70	0	0	
Wace, J. R., Esq.	1	1	0		Ditto	2	2	0	
Waddington, Mrs. J. T. (1869-78)	52	10	0		Wentworth, Vernon, Esq. (1876)			10	
Wagstaff, James, Esq.	1	1	0		Were, Josh., Esq., Broadchist (1861-77)	170	0	0	
Wain, R., Esq., Clifford St.	1	1	0		Were, Mrs. Bouville (1860-75)	33	12	0	
Wakefield Branch (1881-2)	31	5	8		Ditto	2	2	0	
Wakefield, Miss M. R. (1860-73)	76	5	0		Western Central Counties Branch (1881)			32	
Waldegrave, the Earl	5	5	0		Westley, W., Esq., Regent St.	2	2	0	
Walker, Geo., Esq.	1	1	0		Westmore, Rev. H. H., M.A.	1	1	0	
					Weston, Ambrose, Esq. (1872-5)	31	10	0	

LIST OF DONATIONS AND ANNUAL SUBSCRIPTIONS.

553

	Ann. Subs.		Donations.			Ann. Subs.		Donations.	
	£.	s.	d.	£.		s.	d.	£.	s.
Weston and Westall, Messrs.	1	1	0						
Weston-super-Mare Branch (1882)	72	11	5						
Weston, W., Esq., Bramley (1880)	10	0	0						
Whalley, F. R., Esq.	2	2	0						
Whalley, John, Esq., Blackburn (1881)	10	10	0						
Wheatley, Mrs. George, Sacombe Lodge	1	1	0						
Wheatley, Rev. C., M.A. (1882)	10	0	0						
Wheeler, E., Esq., Stock Exch.	1	1	0						
Wheeler, George, Esq.	1	1	0						
Wheeler, H. S., Esq.	1	1	0						
Whichcote, Mrs. Francis	2	0	0						
Whish, Admiral (1879)	25	0	0						
Whitaker, T. S., Esq., F.R.G.S.	1	1	0						
Whitby, Messrs. W. and G.	1	1	0						
White, Brothers, Messrs.	1	1	0						
White, J., Esq., Gt. St. Helens	1	1	0						
White, John, Esq., Cowes	1	1	0						
White, Miss M. C., Brighton (1868-81)	17	10	0						
White, Mrs., Brighton (1882)	2	0	0						
Whitehaven Branch (1882)	50	0	0						
Whitehead, T. S. & Co., Messrs.	0	10	6						
Whiteley, George, Esq. (1871)	50	0	0						
Whiteman, Stephen, Esq.	1	0	0						
Whiter, Frederick W., Esq., Birmingham	1	1	0						
Whiting, R. M. & H., Messrs.	0	10	0						
Whyte, Admiral W. H.	1	0	0						
Wieting and Richter, Messrs., Demerara	1	1	0						
Wigram, E., Esq. (1882)	5	0	0						
Wilbe, R. H., Esq., M.D.	1	1	0						
Wilcox, Robt. M., Esq.	2	2	0						
Wilde, Spencer C., Esq.	1	1	0						
Wilkinson, J. R., Esq.	1	1	0						
Wilkinson, Mrs. M. D. P., "In remembrance of a dear friend" (1874)	10	0	0						
Wilkinson, O. R., Esq.	1	1	0						
Wilkinson, Robt., Regents Park (1882)	10	0	0						
Willans, Mrs. Russell	1	1	0						
Williams, Admiral W. J. (1871-82)	24	0	0						
Williams, J., Esq., Mark Lane	0	10	0						
Williams, O. J., Esq.	1	1	0						
Williams, Robert, Esq., Wrexham	0	10	6						
Williamson, A. D., Esq., Haxby (1861-73)	31	15	6						
Willimott, Miss E. A.	1	1	0						
Willimott, W., Esq. (1877)	21	0	0						
Willink, W. W., Esq.	2	2	0						
Willis, Com. G. H. R., R.N.	1	0	0						
Willis, H. B., Esq.	1	1	0						
Willis, Henry Esq. (1876)	10	10	0						
Willis, J. E., Esq. (1864-70)	65	0	0						
Willis, Major W.	1	1	0						
Willis, Mrs.	1	1	0						
Wills, Mrs., Shaftesbury	0	10	0						
Wilmott, E. W., Esq.	1	1	0						
Wilson, Capt. J. E. M., R.N.	1	1	0						
Wilson, John R., Esq.	1	1	0						
Wilson, J., Esq., Hackney	1	1	0						
Wilson, Lieut. William, R.N. (1874-82)	31	0	0						
Wilson, Miss, Maidenhead (1878)	10	0	0						
Wilson, Miss H. J.	4	4	0						
Wilson, Rev. Robert (1858-75)	102	10	0						
Wilson, Wm., Esq., Highbury	1	1	0						
Wiltshire, John Walter, Esq. (1882)	30	0	0						
Winckworth, Lewis, Esq.	2	2	0						
Windley and Barwick, Messrs.	2	0	0						
Windsor, Miss E.	0	10	0						
Wing, Thomas, Esq., Bos- more Hall (1875)	10	10	0						
Winn, W., Esq. (1860-80)	105	0	0						
Winter, The Misses M. E. and E. (1869-82)	29	8	0						
Wintle, Thos. D., Esq., Cheltenham (1881)	10	10	0						
Wire, Travers, B., Esq.	1	1	0						
Wire, Mrs. Travers B.	1	1	0						
Wise, H. C., Esq.	1	1	0						
Witherby, Arthur, Esq., Lee (1880)	5	5	0						
Wolverhampton Branch (1882)	35	15	0						
Wood, Chas., Esq., East Street	1	1	0						
Wood, F., Esq., Sidcup	1	1	0						
Wood, J. Gathorne, Esq.	5	0	0						
Wood, Mrs. B., The Lodge (1854-76)	235	0	0						
Wood, W. N., Esq. (1876-82)	5	0	0						
Woodcock, Henry, Esq., Bol- nore	2	2	0						
Woodhouse, Rev. J.	0	10	0						
Woodley & Co., Messrs. (1881)	5	5	0						
Woodroffe and Westrope, Messrs.	1	1	0						
Woodruff, Rev. Thos., M.A.	1	1	0						
Woods, Mrs. H. T.	1	1	0						
Woolcott, Wm., Esq.	1	1	0						
Woolfe and Son, Messrs.	2	2	0						
Woolley, Miss (1877)	15	0	0						
Worcester Branch (1882)	30	18	6						
Workington Branch (1881)	31	5	1						
Worsley, Rev. P. R., M.A. (1876-81)	6	0	0						
Worthing Branch (1882)	25	0	0						
Wright, Henry E., Esq.	2	2	0						
Wrigley, Miss, Holbeck	1	0	0						
Wrigley, Mrs., Holbeck	2	0	0						
Wyndham, Mrs., Salisbury	1	1	0						
X. L. V.	1	0	0						
X. Y. Z. (1867-75)	215	0	0						
Yates, Capt. R. B.	1	1	0						
Yeves & Co., Messrs. (1881)	1	1	0						
York Branch (1882) <i>vide</i> also p. 603	103	5	0						
Youle, F., Esq. (1863-81)	75	5	0						
Young and Lark, Messrs.	1	1	0						
Young, Capt. Sir A. W.	1	1	0						
Zulueta and Co., Messrs.	1	1	0						

LIST OF GENERAL COLLECTIONS, ETC., 1881-82.

	£.	s.	d.		£.	s.	d.
"A. G. T.," two months' earnings and collection by	0	7	6	Martin, Lieut. Leslie, collected by	1	16	0
Aberford Alms Box, one month, per Rev. Canon Eden	1	5	8	Netheravon Church, collection per Rev. W. H. Heaven, M.A.	1	5	0
Adderley Church, offertory, per Rev. A. Corbet, M.A.	11	6	6	Newton-by-Sudbury, share of harvest thank-offering, per Rev. Reginald Smith	1	0	0
"Admiral Lutwidge" Life-boat Fund, on account, per C. R. Fletcher Lutwidge, Esq.	150	0	0	Nottingham Amateur Dramatic Club, Entertainment by, per A. Vickers	0	7	0
Ashford, Alexander Academy, Scholars and Family of Mr. T. H. Vie	1	1	0	Odd Fellows, Independent Order of (M.U.), Loyal Hope of Bloomsbury Lodge	1	1	0
Ball, Mrs. J., Canonbury, collected by Batson, Mr. Albert E., Brewer Street, collected by	8	15	6	Ditto, Hope Lodge, Southampton (Annual)	1	1	0
Brightwell, proceeds of Penny Readings at, per R. T. Brockman, jun., Esq.	1	6	0	Ditto, Nelson Lodge, Norwich (Annual)	2	2	0
Bromley, Mrs. W., Penge, collected by Cavell, Fredk. E. A., Esq., New Inn, collected after some Recitals	11	11	0	Ditto, Prosperity Lodge, Norwich (Annual)	1	1	0
Chilton Parish Church, portion of Harvest Festival collection, per Rev. Herbert Smith, M.A.	2	0	0	Oxford Gas Works employes, per J. Eldridge, Esq.	3	2	0
Christ's Hospital, collected from the Boys of, per Rev. R. Lee, M.A.	1	1	0	Park Chapel Boys' Sunday School, per Mr. Ernest Wench	1	10	0
Crawford, Master A. T., Highgate, collected by	2	0	0	Pateley Bridge, proceeds of Lecture at, per Geo. V. Gaskell, Esq.	1	12	10
Demerara, West Indies, collected by M. R. O'Maley, Esq. (Annual)	0	10	0	Peterborough, collection at St. Paul's Church on Christmas Day, per Rev. C. R. Ball, M.A.	2	18	1
Drury, Rev. E., proceeds of Lectures Felixstowe, proceeds of Amateur Theatricals, per Mr. C. E. Harding	11	0	6	Phillips, J. B., Esq., Southampton, collected by	1	1	0
Freemasons Chronicle, Life-boat Endowment Fund	6	4	9	Pin-cushions, Patent Life-boat, portion of profits by their sale, per Miss M. A. Rich, Neston	0	5	6
Freemasons, Leigh Lodge of, in aid of Lady Leigh Life-boat (Annual)	4	4	0	Railway Clearing House, collected at, per Hy. Turner, Esq.	4	14	0
Ditto, Prosperity Lodge 65	1	1	0	Satchwell, Mr. George and Mrs. Satchwell, proceeds of entertainments, &c.	50	0	0
Ditto, Temperance Lodge 789 (Ann.)	2	2	0	Schon, Master Percy, Chorlton-cum-Hardy, collected by	0	5	6
Ditto, Lodge 809, Wisbeach (Ann.)	2	2	0	S. Michael's Life-boat Fund, per Rev. G. F. Prescott, M.A., towards support of Kessingland No. 2 Life-boat	22	18	9
Freemasons, the Borrowstoness Douglas Lodge No. 409, per Messrs. J. Duguid and H. Polson	5	0	0	St. Mark's College, Chelsea, Students at, per Mr. Hawkins	0	12	0
Hadnall Church, near Shrewsbury, per Rev. Brooke C. Mortimer	12	15	8	Shaboe, Rev. D., in aid of Masonic Life-boat	1	11	6
Harby Church, per Rev. M. O. Norman Holy Trinity Schools, Paddington, collected by the members of Miss Courtney's Bible Class.	1	10	0	Shepperton, Profits from Penny Readings, per Rev. W. F. J. Hanbury	4	3	0
Hotham, F. W., Esq., Buckland Rectory, collected by	0	10	6	Strathbungo Mission Sabbath School, Glasgow, per G. D. Stirling, Esq.	1	14	8
Hutton Rudby, Yarm, collected after Lecture in Board School, by Rev. C. T. Pratt, M.A.	2	10	0	Stubton Church, offertory at, per Rev. P. R. Worsley, M.A.	2	0	0
Johnson, Adml., col. by (Annual)	1	8	0	Sunningdale School, collected in school chapel amongst the boys, per Dr. Girdlestone	1	10	0
Johnson, Miss, Wrexham, collected by Johnson-Smyth, Miss Lillie, Donnybrook, collected by	9	3	6	Thompson, Mr. H., Leigh, collected by Tilney, All Saints Church, collection at, per Rev. S. J. Phillips	0	6	7
Kington Parish Church, collected in, per Rev. Matthew Wood	2	15	0	Underriver, offertory at St. Margaret's Church, per Rev. C. R. Hardy	1	2	3
"Langham" Life-boat Fund, on account, per the Langham Hotel Co., Limited	1	0	0	Veasey, Miss, Woburn	1	10	0
Lewisham High Road Congregational Church Sunday School, per Robt. Harry, Esq.	3	11	9	Ventnor, Friends at, per Mrs. M. Johnson Walker, Miss M., Peterborough, collected by	2	13	0
Licensed Victuallers School, collected in aid of the Licensed Victualler Life-boat at Hunstanton, per E. Grimwood, Esq.	1	15	0	Welshpool, Reading Room, proceeds of Penny Reading at, per H. E. Forrest, Esq.	0	7	0
Maidenhead, Balance of proceeds of Lecture at, per Col. FitzRoy Clayton	1	15	0	West Haddon Church, Rugby, collection at, per Rev. G. L. W. Fauquier	7	5	0
	2	6	0	Wood, Rev. R., Carlisle, proceeds of Life-boat Lecture	3	0	3
					1	15	0

CONTENTS OF PILLAR AND OTHER CONTRIBUTION BOXES, 1881-82.

(In addition to those included under "SEAMEN'S COLLECTIONS.")

	£.	s.	d.		£.	s.	d.
Alexandra Palace Pillar Box	0	14	6	Keal, Miss, Hereford	0	17	6
Allen, Ashton C., Esq., Park Crescent .	6	14	4	La Touche, Mrs. Ashley, Parkstone .	0	10	0
Allen, C. B., Esq., Kilburn	1	1	0	Lambeth Police Court, per G. A. Bird, Esq.	1	2	6
Army & Navy Provision Market, per Mr. J. G. Cook	0	9	10	Liverpool Street, Great Eastern Railway Station	2	11	5
Barker, Edwd., Esq., Shepherd's Bush .	0	7	3	London Bridge Railway Station	2	0	4
Barker, R. E., Esq. Ditto	0	10	9	London Docks Pillar Box, per Mr. Cox	0	7	3
Bird, Mrs., Putney	0	16	6	Macclesfield, per Mr. T. R. Comberbach	0	10	3
Brittain, J., Esq., Ilkeston	0	10	0	Maitland, J. N., Esq., Doura Place . .	1	3	3
Burnley, Thorn Hotel, per Mr. G. C. Ogden	1	1	0	"Margaret" Box, per Mrs. Etherington Smith, in aid of <i>Joseph Sykes</i> Life-boat at Uppang	2	14	0
Calcot Church, contents of Box, Collected from School Children, and by Mr. A. M. Henniker, per Miss Henniker	1	19	2	Martin, J. S., Esq., Montague Place . .	1	8	0
Cox and Son, Messrs., Chancery Lane . .	0	17	3	Oakmere, Box in the Hall, per H. Kemble, Esq.	2	4	0
Cox, Mr. C. H., Liverpool	0	12	0	Old Bell Hotel, Holborn, per Miss Bunyer	2	0	0
Crystal Palace Pil. Boxes, per Dr. Price	4	15	5	Patshull, Box at The Fishing Temple, per J. Wilkins, Esq.	0	7	0
Dashwood, C. E., Esq., Park Street . .	2	11	2	Payne, Miss, Bewdley	0	13	6
East India Docks Pillar Box, per Capt. Middleton	5	11	3	Ramsgate Pillar Box, per Captain Braine	5	8	8
Exeter, Albert Memorial Museum . . .	1	1	0	Do. Contribution Boxes at Hotels, &c. Ramsgate—Contribution Box at South-Eastern Railway Station	1	10	8
Farrar, Miss, Brixton	2	9	2	Roskrow, T., Esq., Redruth	0	14	8
Fenchurch Street Railway Station . . .	4	9	9	Skinner, Mrs. C., Cambridge	1	1	10
Finsbury Central Club, on account of Special Life-boat Fund	1	12	6	Southampton Pillar Box	2	17	4
Geary, Mr. W. N., Tunbridge	2	0	0	Strutt, Miss Susan, Belper	1	1	4
Gore, Mrs., Brighton	1	2	0	Tompkins, F. G., Esq., Witton Hall . .	1	1	0
Greet, Miss H., Charlton	0	7	0	Trowbridge, Mr. T., Holloway	0	7	6
Hancocks, Alfred, Esq., Wolverley . . .	3	3	0	Tupp, Mr. John, Tottenham Court Road	1	10	0
Harper, Bros., Messrs., Billiter House .	1	13	0	Victoria Railway Station	1	12	11
Harris, Master Josh. C., Calne	0	10	0	Waudesford, The late, Mr. C. B., per Richd. Cooke, Esq.	0	15	6
Haxell's Hotel, Strand, per Mr. E. N. N. Haxell	1	6	4	Waterloo Railway Station	4	7	3
Jacob, Mr. C. J., Basingstoke	0	5	0				
Jeffery, Miss C., Walworth	0	10	9				
Jersey, Pillar Box, per J. Sullivan, Esq.	1	5	0				
Johnson, Mrs., Hoddesdon	17	3	0				

COLLECTIONS FROM SEAMEN AND OTHERS, BY COLLECTORS OF CUSTOMS, BY THE AGENTS OF THE SHIPWRECKED MARINERS' SOCIETY, AND BY OTHERS, IN 1881-82.

	£.	s.	d.		£.	s.	d.
<i>Alsatia</i> , s.s., collected on board, per Messrs. Henderson Bros.	0	19	0	Charlestown and Bo'ness, per J. Campbell, Esq.	5	3	9
<i>Austrian</i> , s.s., collected on board, per Captain Barrett	0	19	9	<i>City of York</i> , collected on board, per Capt. Wm. M. Greive	4	11	6
Belfast, per E. Foyster, Esq.	5	13	9	<i>Corean</i> , s.s., per Capt. McDougall . . .	3	9	0
Belfast Mercantile Marine Office, per A. Dent, Esq., R.N.	7	14	0	<i>Cwm Donkin</i> , collected on board, per Capt. H. Munchausen	0	5	9
Blyth, per Mr. J. Robinson, Jun.	4	14	0	Fowey, per W. Gray, Esq.	1	13	3
Board of Trade Shipping Office, Poplar, per Capt. Furnell & Jas. Swain, Esq. .	12	8	3	Gainsborough, per T. Gray Jones, Esq.	0	5	3
Boston, per J. E. Ridlington, Esq. . . .	0	15	6	Glasgow Sailors' Home, proceeds of concert	10	8	6
Bristol, per G. C. Whitwill, Esq.	7	0	4	Glasgow, per M. O'Holloran, Esq.	85	18	6
<i>Buenos Ayrean</i> , s.s., collected on board, per Captain McLean	0	9	2	<i>State of Nebraska</i> , coll. on board by Capt. A. G. Braes	12	0	6
<i>Bulwark</i> , ship, collected on board, per Capt. Seaton	0	16	0		97	19	0
Carnarvon, per John Jackson, Esq., Half Proceeds of Entertainments by the Carnarvon Dramatic Society . . .	5	15	6	Grangemouth, per G. Reynolds, Esq. .	3	9	0
Collected by Capt. E. Roberts				<i>Grecian</i> , s.s., collected on board, per Captain Le Gallais	5	19	10
Dolbadarn Hotel, Llanberis	1	5	6	Greenock, per B. S. W. Macalister, Esq. and A. Gosset, Esq.	1	11	11
Donations from Mariners	0	15	3	Hull, per T. Gray Jones, Esq.	3	3	0
Contribution Boxes	3	8	3	Hull, per J. W. Day, Esq.	10	0	0

	£.	s.	d.		£.	s.	d.
Ipswich, per I. Walker, Esq.	1	12	6	Port William, per Thos. Whyte, Esq.	0	7	6
Jersey, per E. J. Bellingham, Esq.	5	0	0	<i>Prussian</i> , s.s., per Capt. Stephen	2	10	10
Jersey, per George Clayton, Esq.	1	12	0	Rochester, per C. T. Ellington, Esq.	2	19	1
<i>Justitia</i> , s.s., per Capt. E. Good	1	5	0	"Sea-going Engineers," collected from,			
<i>Lady Jocelyn</i> , proceeds of two concerts				per Chas. Smith, Esq.	6	6	0
on board, given by Mr. F. Warm and				Silloth, per Mr. W. Smith	0	17	7
a Passenger, per Messrs. Park Bros.	4	1	0	Sligo, per W. Petherick, Esq.	1	1	4
Leith, per Foster Franklin, Esq.	11	1	6	Southampton Mercantile Marine Office,			
Limerick, per R. Mostyn, Esq.	4	2	4	per G. S. Coxwell, Esq.	2	17	2
Liverpool, per W. G. Stewart, Esq.	1	16	0	<i>Trojan</i> , s.s.; collected on			
London Custom House, per J. W.				board, per Capt. C. D.			
Douglas, Esq.	0	11	1	Coxwell	7	6	9
Lowestoft, per J. W. Robertson, Esq.	2	14	2				
<i>Manitoba</i> , s.s., collected on board, per				St. Andrew's, per N. McLeod, Esq.	10	3	11
Capt. A. Macnicol	4	15	10	St. Katherine's Docks, Mercantile			
Montrose, per Lawrence S. Smith, Esq.	1	12	5	Marine Office, per Capt. J. Watson	8	9	6
Newport Mercantile Marine Office, per				Sunderland, per Messrs. R. Hudson and			
Jas. Lyons, Esq.	4	17	0	Sons	1	7	0
Newport, Monmouth, per Caleb Cox,				Sutton Bridge, per J. H. Webb, Esq.	1	0	0
Esq.	5	7	0	<i>Tenedos</i> , H.M.S., collected on board,			
Newtown, Mont., per A. Took, Esq.	0	16	0	per Rev. J. M. Clarkson, R.N.	2	17	3
<i>Orient</i> , s.s., amount of collection and				<i>Utopia</i> , s.s., collected on board, per			
subscriptions, per Capt. Hewison	15	0	0	Captain McRitchie	1	7	2
<i>Pegasus</i> , collected on board, per Capt.				<i>Waldensian</i> , steamer, collected on			
Owen Owen	1	12	6	board, per Captain R. P. Moore	2	14	6
<i>Phanician</i> , s.s., collected by Capt. J.				Wigtown, per R. Chalmers, Esq.	0	13	0
Scott	0	16	6	Wisbeach, per J. H. Webb, Esq.	4	19	8
Portsmouth, per Robert Raggett, Esq.	0	18	6	Woodbridge, per H. Fisher, Esq.	0	18	6

The Royal National Life-boat Institution

Is prepared to establish and maintain a Life-boat Station on any part of the coast of the United Kingdom where it can be shown, from previous disasters, that a Life-boat is required. It is requisite that there should be a sufficient number of men (fishermen, or others accustomed to the management of boats at sea) to man the Life-boat, and a Committee formed from the residents in the neighbourhood to superintend the Station and obtain such small Annual Subscriptions as may contribute towards a portion of the expense of the Life-boat Station.

Communications may be addressed to

THE SECRETARY OF THE INSTITUTION,

1st May 1882.

14 JOHN STREET, ADELPHI, LONDON, W.C.

SPECIAL LIFE-BOAT CONTRIBUTIONS.

CIVIL SERVICE LIFE-BOAT FUND.

Patron—
HIS ROYAL HIGHNESS THE DUKE OF EDINBURGH, K.G., K.T. &c.
 Treasurer—
CHARLES G. TURNER, Esq.
 Hon. Secretary—
CHARLES DIRDIN, Esq., F.R.G.S.

Annual Subscriptions of 2s. 6d. have been promised in aid of the above Fund by 5449 gentlemen in the following Government Departments:—

Admiralty	290
Board of Trade	36
British Museum	22
Charity Commission	47
Chatham Dockyard	15
Civil Service Commission	31
Colonial Office	27
Copyhold Commission	34
Court of Bankruptcy	53
Customs	372
Devonport Dockyard	28
Ecclesiastical Commission	47
Education Department	64
Exchequer and Audit Office	120
Foreign Office	62
Gazette Office	5
General Post Office	711
Great Seal Patent Office	51
High Court of Justice	311
Home Office	65
House of Commons	34
House of Lords	29
India Office	121
Inland Revenue	990
Local Government Board	119
Miscellaneous Post Offices	163
National Debt Office	39
Nautical Almanac Office	10
Office of Commissioners in Lunacy	6
Office of Woods and Forests	77
Office of Works	66
Paymaster-General's Office	9
Penrthorpe Dockyard	34
Portland Prison	4
Portsmouth Dockyard	33
Privy Council Office	12
Public Record Office	30
Public Works Loan Office	18
Queen Anne's Bounty	15
Record Office of Seamen	40
Registrar-General's Office	89
Registry of Friendly Societies	11
Royal Chelsea Hospital	10
Royal Clarence Yard, Gosport	8
Royal Mint	88
Royal Victoria Yard, Deptford	13
Royal William Yard, Portsmouth	4
Science and Art Department	42
Sheerness Dockyard	23
Stationery Office	45
Treasury	50
War Office	149
Miscellaneous	16

SCOTLAND.

Auditor of the Court of Session Office	2
Bankruptcy, Office of Accountant	1
Board of Lunacy	8
Board of Manufactures	8
Board of Supervision	13
Chancery Office	3
Commissary Office	2
Court of Session	11
Crown Office	5

Customs, Greenock	9
Exchequer	10
Fishery Board	4
General Post Office	71
Miscellaneous Post Offices	82
General Register of Sasines	70
General Registry Office	7
Horning Office	1
Inland Revenue	69
Justiciary Office	6
Lord Clerk Register's Office	6
Northern Lighthouse Board	4
Office of Works	1
Prison and Judicial Statistics	19
Register of Deeds and Probative Writs Office	5
Science and Art Department	2

IRELAND.

Customs	9
General Post Office	115
General Survey and Valuation Office	23
High Court of Justice	8
Inland Revenue	22
Miscellaneous Post Offices	13
Office of National Education	61
Total	5,449

CLEVEDON LIFE-BOAT FUND.

Honorary Secretary—
Mrs. E. LAVINGTON, Belgrave House, Clevedon, Somerset.

Donations.		£.	s.	d.
Proceeds of Soirée Musicale (Dec. 1872)		25	0	0
Ditto do. do. (1874)		26	17	0
Ditto do. do. (1875)		26	6	0
Collected by Mrs. Lavington's Pupils during the half-year ending June 1875		20	18	7
Ditto half-year ending June 1876		10	4	9
Collected by Miss Wrigley, Holbeck, Windermere, during the half-year ending June 1876		15	15	0
Sale of Work and Christmas Tree, December 1876		27	4	0
Sale of Pupils' Work 1878		38	4	2
Penruddocke, Miss, Fyfield, Wilts, contributions from the sale of work (1875-82)		6	17	3
Harrison, Miss, French coins		—	3	5
Collected by Miss Ettie Lovibond, Bridgwater		4	0	0
Contents of Life-boat Box, and collections during the year 1877		6	11	6
Contents of Life-boat Box to Christmas 1878		2	2	6
Sale of Pupils' Work, 1879		46	4	2
Sale of Clevedon Wild Flowers		16	16	6
Sale of Work, Donations, and sale of Clevedon Wild Flowers, 1880		39	13	4
Ditto 1881		53	5	7
Total		£366	3	9

THE "COVENT GARDEN" LIFE-BOAT FUND.

Amounts handed to the NATIONAL LIFE-BOAT INSTITUTION by the Stewards of this Fund, being the Contribution for the year 1881, in aid of the support of the Covent Garden Life-boat, now stationed at Caister, near Great Yarmouth.

	£.	s.	d.
Chadwick, S. Esq.	—	10	0
Cumberlege, Rev. S. F., M.A.	1	1	0
Coutts, J. Esq.	—	12	6
Hale, —, Esq.	—	1	0
Norman, W. Esq.	—	1	2
Parker, H. Esq.	—	1	0
Part Proceeds of Entertainment	47	4	0
Total	£52	11	0

THE "FORESTER" AND "FORESTERS' PRIDE" LIFE-BOATS FUND.

List of Voluntary Contributions received for the Fund from the following DISTRICTS, COURTS, &c., of the ANCIENT ORDER OF FORESTERS, from January 31, 1881, to January 31, 1882, per SAMUEL SHAWCROSS, Esq., P.S.

	£.	s.	d.
Amount previously published in Foresters' Reports from 1863 to Jan. 31, 1881	3,222	2	5

DISTRICTS.

Ashton-under-Lyne	—	10	0
Beverley	—	15	0
Bishop's Stortford	—	13	0
Bucks, &c.	—	10	6
Cardiff	—	17	0
East Dereham	—	1	0
Falsworth	—	2	0
Flintshire	—	1	0
Hyde	—	16	7
London United	—	25	13
South London	—	4	5
South Western	—	5	13
Watford	—	14	4

COURTS.

113	—	1	0	0
159	—	—	5	0
337	—	—	5	6
363	—	—	10	0
469	—	—	10	0
681	—	—	10	0
757	—	—	9	8
854	—	—	5	8
857	—	—	6	5
957	—	—	10	0
1007	—	—	13	2
1057	—	—	9	10
1112	—	—	8	0
1120	—	—	15	0
1142	—	—	6	0
1192	—	—	14	8
1169	—	—	12	6
1293	—	—	10	0
1309	—	—	10	0
1442	—	—	5	0
1471	—	—	14	5
1548	—	—	1	0
1631	—	—	5	0
1701	—	—	10	0

	£.	s.	d.
1756	-	10	0
1762	-	9	2
1911	1	1	2
1952	-	5	0
2140	-	10	0
2157	1	1	0
2156	-	7	6
2250	-	10	0
2293	1	1	0
2309	1	1	0
2505	-	5	0
2559	-	6	5
2572	-	10	6
2609	-	7	5
2626	-	5	0
2634	10	10	10
2658	-	5	0
2682	-	10	0
2732	-	5	0
2762	1	1	0
2772	-	5	0
2932	-	10	0
2948	-	5	0
2992	-	10	1
3052	-	10	0
3102	-	5	0
3151	-	6	1
3157	1	0	0
3229	-	5	0
3344	-	10	6
3398	-	6	10
3416	-	12	0
3457	-	14	0
3470	-	12	7
3477	-	7	6
3529	1	16	6
3570	1	0	0
3597	-	7	6
3641	1	0	0
3715	-	9	5
3742	-	10	6
3874	-	10	0
4105	-	10	0
4148	-	10	0
4195	1	5	0
4458	-	5	0
4558	-	8	6
4565	-	5	3
4865	-	5	0
4987	-	13	6
4640	-	10	0
5106	-	10	0
5190	-	5	6
5244	1	0	0
5461	1	1	0
5464	-	5	0
5747	-	6	0
5755	2	0	0
5802	1	1	8
5836	1	0	0
5848	-	5	9
5956	-	5	0
6029	-	8	0
6049	-	6	0
6106	-	6	6

	£.	s.	d.
6241	-	5	8
6494	-	10	6
6725	1	10	0
One Year's Dividend on £450	-	13	10
New 3 per Cents.	-	13	10
Sums under 5s.	8	4	10
Total	£3,351	7	7

THE "MANCHESTER UNITY" LIFE-BOAT FUND.

Contribution from The INDEPENDENT ORDER OF ODD FELLOWS (Manchester Unity) FRIENDLY SOCIETY, for the year 1881, per THOMAS COLLINS, Esq., Secretary.
 £50 0 0

"MARK LANE" LIFE-BOAT FUND.

Hon. Sec.—H. KAINS-JACKSON, Esq.
 Subscriptions at Christmas, 1881-2.

	£.	s.	d.
A. B.	1	0	0
Anderson and Boyd, Messrs.	-	7	6
G. and A.	-	10	6
Ardley, Messrs. R. and J.	-	10	0
Aste, Son, and Kerchevall, Messrs.	1	1	0
Baucher, Mr. B. L.	-	10	0
Beane and Newton, Messrs.	-	10	6
Begbie, Ross, and Gibson, Messrs.	-	10	0
Bell and Co. Messrs. A.	-	10	6
Bellamy, Mr. W. C. B.	-	10	6
Borrowman & Phillips, Messrs.	1	1	0
Bovill and Co., Messrs.	1	1	0
Bovill and Sons, Messrs. Benj.	-	10	6
Bowyer, Messrs. S. and H.	-	10	0
Carter, Mr. J. J.	-	10	0
Child, Messrs.	-	10	0
Church, Mr.	-	10	0
Claudius and Chattaway, Messrs. C. F.	-	10	6
Cole, Mr. R.	-	10	6
Colman, Messrs. J. and J.	-	10	6
Corder, Mr. F. J.	-	10	6
Coventry and Sheppard, Messrs.	-	10	0
Cross, Mr. C. H.	-	10	0
Denny, Messrs. C. and J.	-	10	0
Dewar and Webb, Messrs.	1	1	0
Doo, Mr. G.	1	0	0
Doo Brothers, Messrs.	-	7	6
Dornbusch's List	-	10	0

	£.	s.	d.
Dunham, Wm. ("The Miller")	-	10	0
Edwards Brothers, Messrs.	-	10	6
Elphinstone, A. & R. Messrs.	1	1	0
Gade and Co., Messrs.	-	10	0
Girdwood and Co., Messrs.	-	10	0
Gregory and Co., Messrs.	-	10	6
Geiselbrecht, Mr. J. C.	-	10	0
Harris Brothers, Messrs.	1	1	0
Hastie, Mr. F.	-	10	0
Hewitson R. and J., Messrs.	-	10	0
Hopkinson, Mr. C.	-	5	0
Horne and Son, Messrs.	1	1	0
Hutchinson, Mr. F.	-	10	0
James and Sons, Messrs.	-	10	0
Johnson and Son, Messrs.	-	10	0
Jones and Sons, Messrs. R. P.	-	10	0
Judkins, Connorton, and Son, Messrs.	-	10	0
Judkins, Mr. B. L.	-	10	0
Kains-Jackson, Mr. H.	-	10	6
Klein & Sons, Messrs.	-	10	0
Ledger, Mr. E. W.	-	10	0
Lenders and Co., Messrs. F.	1	1	0
Love, Mr. Martin	-	10	0
Maidlow and Sons, Messrs.	-	10	6
McDougall Bros. Messrs.	-	10	0
Mongredien, Ellerby, and Co., Messrs.	-	10	0
Muggeridge, Mr. T. B.	-	10	0
Muggeridge and Co., Messrs. Wm.	-	10	0
Mumford, Messrs. S. P. & C.	-	10	0
Nixon, Gower, and Co., Messrs.	-	10	0
Patent Granary Company	1	1	0
Peek, Freat, and Co., Messrs.	1	1	0
Perks, Messrs. J. B. and T. H.	-	10	0
Rathbone, Edward, and Son, Messrs.	-	10	6
Roberts, Chas. & Co., Messrs.	-	10	0
Robins, Mr. H.	-	10	6
Robinson, Mr.	-	10	6
Roffey and Son, Messrs.	1	1	0
Rumford, Messrs. L. M. and C.	-	10	0
Schacht, Mr. T.	-	10	0
Skelton, Mr. T. W., col. by	13	7	1
Smith, Mr. Walter	-	10	6
Spartali and Co., Messrs.	1	1	0
Stokes, Mr. R.	-	10	0
Stuckenschmidt, Mr.	1	1	0
Taylor, Mr. Seth	-	10	0
Tyser and Pechey, Messrs.	-	10	6
Usborne and Son, Messrs.	-	10	6
W. M.	-	10	6
Watney and Keene, Messrs.	-	10	6
Watson, Medill & Co. Messrs.	1	1	0
Webster Brothers, Messrs.	-	10	6
Woodley and Co., Messrs.	-	10	0
Wright and Sons, Messrs. R.	1	1	0
Wright, Mr. T. W.	1	0	0
90° in the shade	1	5	0
Sums under 5s.	-	9	0

Total..... £65 9 7

INDEX TO THE BRANCHES.

	PAGE		PAGE		PAGE
ABERDEEN	603	EYMOUTH	605	PADSTOW	564
ABERDOVEY	584	FALMOUTH	563	PALLING	586
ABBERTSWITH	561	FILBY	598	PEEBLES	613
ACOCK'S GREEN	596	FISGUARD	589	PENARTH	575
ALDBOROUGH AND THORPE	591	FLAMBOROUGH	598	PENZANCE AND SENWEN COVE	564
ALDERNEY	621	FLEETWOOD	579	PETERHEAD	604
ALLOA	606	FOWEY	563	PIEL	582
ALNMOUTH	587	FRASERBURGH	604	POOLE	572
ANGLESEY	560	GIVAN	605	PORTCAWL	575
ANSTRUTHER	609	GLASGOW	611	PORTHDINLAWN AND ABERSOCH	562
ARBROATH	610	GOODWIN SANDS AND DOWNS	577	PORTHLEVEN	565
ARDMORE	619	GORLESTON	592	PORTHOUSTOCK	565
ARDBOSMAN	604	GOURDON	611	PORT ISAAC	565
ARKLOW	620	GREENOCK	614	PORTLOR	565
ATE	604	GREYSTONES	620	PORT LOGAN AND BAY OF LUCH	616
BALLBRIGGAN	618	GURNESEY	621	PORTMADOC	562
BALLANTRAE	605	HARTLEPOOL	573	PORT OF PLYMOUTH	569
BALLYCOTTON	616	HARWICH	574	PORT OF ROCHESTER	578
BALLYWALTER	617	HASBOROUGH	585	PORT OF RUNCOORN	563
BANFF AND MACDUFF	605	HASTINGS AND ST. LEONARDS	595	PORT PATRICK	615
BANNOCKBURN	614	HAUKLEY	587	PORTRUSS	616
BARMOUTH	584	HAYLE	563	PORTSMOUTH AND HAYLING ISLAND	576
BARNSTAPLE AND BRAUNTON	587	HENLEY-ON-THAMES	589	RAMSEY	621
BATH	590	HOLTHRAD	560	READING	560
BELFAST AND GROOMSFORT	615	HOLY ISLAND	588	RHYL	574
BELPER	567	HORNSEA	599	ROBIN HOOD'S BAY	600
BEMBRIDGE	576	HUDDERSFIELD	599	ROCHDALE	582
BERWICK	587	HULL	599	ROGERSTOWN	618
BIBFORD AND APPLDORRE	597	HUNA	606	RUNSWICK	600
BIRMINGHAM	586	HUNSTANTON	585	RYE AND WINCHELSEA	585
BLACKBURN	578	HYTHE	577	SALCOMBE AND HOPE COVE	570
BLACKPOOL	578	ILFRACOMBE AND MORTE	568	SCARBOROUGH	600
BLAKENET	585	IRWICH	592	SCILLY ISLANDS	565
BLOCKLEY	597	IRVINE	605	SEAHAM	573
BLYTH	587	ISLE OF ARRAN	606	SEASCALE	586
BOLTON	578	ISLE OF FURBECK	572	SEATON CAREW	573
BOSTON	584	ISLE OF WHITHORN	615	SETTLE	602
BOULMER	587	ISLE OF WIGHT	576	SHEFFIELD	602
BRADFORD	597	KIRKBY	600	SHERINGHAM	586
BRANCASTER	585	KELSO	614	SHOREHAM	596
BRIDGWATER AND BURNHAM	590	KINGSBURY	577	SIDMOUTH	570
BRIDLINGTON	598	KING'S LYNN	586	SKEBBIE AND BALLBRIGGAN	618
BRIDPORT	572	KINGSTOWN	618	SOUTHEND	574
BRIGHTON	592	KIRKCUDBRIGHT	611	SOUTHPORT	583
BRISTOL	575	KIRKLISTON	613	SOUTHWOLD	592
BROADSTAIRS	577	LANCASTER	579	STAFFORDSHIRE POTTERIES	591
BUCKLE	605	LEEDS	600	ST. ANDREW'S	610
BURK	563	LEEK	591	ST. ANNE'S	582
BURTON-ON-TRENT	590	LEICESTER	583	ST. DAVID'S AND SOLVA	589
CADGWITH	563	LIMERICK	618	ST. IVES (CORNWALL)	566
CAHOBE	619	LINCOLNSHIRE	583	STATHES	602
CAMBRIDGE	561	LIVERPOOL AND NEW BRIGHTON	580	STECHFORD	597
CAMPBELTOWN AND SOUTHERND	604	LIZARD (POLPEAR)	563	STIBLING	614
CARDIGAN	561	LLANDDULAS	566	STONEHAVEN	611
CARLISLE AND SILLOTH	565	LLANDUDNO	562	STROMNESS	613
CARMARTHEN BAY	562	LLANELLY AND PEMBREY	562	SUNDERLAND AND WHITEBURN	573
CARNSBORO	620	LONDONDERRY AND GREENCASTLE	619	SWANAGE	572
CASTLETOWN	621	LONGHOPE	613	SWANSEA	575
CAVAN	616	LOOR	563	TEES BAY	602
CHELTENHAM	576	LOSSMOUTH	609	TEIGNMOUTH	570
CHESTER	562	LOWESTOFT AND PAKEFIELD	592	TENBY	589
CHICHESTER HARBOUR & SELSEY	593	LYDD, DUNGENESS	578	THURSO	606
CLACTON-ON-SEA	574	LYME REGIS	572	TORBAY	570
CLEETHORPES	584	LYNNMOUTH	569	TORQUAY	570
CLOVELLY	567	LYTHAM	581	TRALEE BAY	618
CORK AND QUEENSTOWN	616	MANCHESTER	581	TRAMORE	619
COURTMACHERRY	616	MARGATE	578	TROON	605
COURTOWN	620	MARTPORT	566	TYRELLA	617
CRESSWELL	587	MELBOSE	614	VALENTIA	618
CROMER	585	MEVAGHSEY	564	WAKEFIELD	602
CRUDEN BAY	604	MILFORD HAVEN	589	WATCHET	590
DALKRITH	607	MONROSE	610	WELLS	586
DARTMOUTH	568	MORAY FIRTH	613	WESTERN COUNTIES CENTRAL	571
DAWLISH	568	MULLION	564	WEST HARTLEPOOL	573
DERBY	567	MUNDERSLEY	586	WESTON-SUPER-MARE	590
DOUGLAS	621	MUSSELBURGH	609	WEXFORD AND ROSLARE	620
DOVER	577	NEWARK	588	WYEMOUTH	572
DROGHEDA	619	NEWBIGIN	588	WHITBY AND UPGANG	602
DUBLIN	617	NEWBURGH	604	WHITEHAVEN	566
DUNBAR	611	NEWCASTLE (DUNDRUM)	617	WHITELINK BAY	604
DUNCANNON AND WATERFORD	620	NEWCASTLE, TYNEMOUTH, ETC.	688	WICK AND ACKERGILL	606
DUNDALK	619	NEWHAVEY	595	WICKLOW	620
DUNDEE	610	NEWQUAY AND ABBEYATON	562	WINTERTON	586
DUNFERMLINE	610	NEWQUAY (CORNWALL)	564	WITHERNSEA	603
DUNGARVAN	619	NEW ROMNEY AND DUNGENESS	578	WOLVERHAMPTON	591
DUNWICH	591	NEWTON ABBOT	569	WORCESTER	597
EASTBOURNE	594	NORFOLK	585	WORKINGTON	566
EDINBURGH AND LEITH	607	NORTHAMPTON	587	WORTHING	596
ENNISKILLEN	618	NORTH BERWICK	611	YARMOUTH AND CAISTER	586
ESSEX AND COLCHESTER	574	NORTH SUDBERLAND	588	YEALM RIVER	571
EXETER	568	NOTTINGHAM	588	YORK	603
EXMOUTH	568	ORMSKIRK	582	YOUGHAL	617

SPECIAL LIFE-BOAT CONTRIBUTIONS.—CIVIL SERVICE, p. 557; CLEVEDON, p. 557; COVENT GARDEN, p. 557; FORRESTS', p. 557; MARK LANE, p. 558; ODD FELLOWS, p. 558.

LISTS OF CONTRIBUTORS TO THE BRANCHES OF THE ROYAL NATIONAL LIFE-BOAT INSTITUTION.

Amounts acknowledged in these Lists are those chiefly received between 1st April, 1881, and 31st March, 1882. The sign (*) opposite the name of a Contributor indicates that he is on the Local Committee.

ENGLAND AND WALES.

Anglesep.

ANGLESEY BRANCH.

Treasurer and Hon. Sec.—
WILLIAM PRESTON, Esq.

Annual Subscriptions.

£.	s.	d.
Atkinson, John, Esq.	10	0
Bangor, Bishop of	2	2
Barber, H. Esq.	10	6
Beever, J. F. Esq.	1	1
Boston, The Right Hon. Lord	2	0
Clegg, Henry, Esq.	1	0
Davies, R. Esq., M.P.	2	2
Davies, Robert, Esq.	2	2
Docker, F. W. Esq.	10	0
Duff, C. G. Esq.	10	0
Duncaft, J. Esq.	10	0
Edwards, Miss E. W.	1	0
Evans, T. F. Esq.	10	0
Eyton, T. Wynne, Esq.	1	0
Gartside, J. H. Esq.	1	0
Gartside, Mrs.	1	0
Griffith, H. F. D. Esq.	1	0
Griffith, Miss Conway	1	0
Griffith, W. G. Esq.	1	0
Hall, J. Esq.	1	0
Hamppton, Miss	10	0
Hartford, Rev. E.	10	0
Higgins, G. Esq.	1	0
Hughes, General	10	0
Hughes, J. W. Esq.	10	6
Hughes, W. B. Esq., M.P.	1	0
Hughes, R. Jones, Esq.	1	0
Hussey, Horace, Esq.	1	0
J. W.	1	7
James, R. L., Lieut. R.N.A.V.	1	0
Jones, Archd. Wynne	10	0
Jones, T. Nicholls, Esq.	1	0
*Lewis, Col. Hampton	1	0
J. W.	1	0
Lewis, Miss	10	0
Lewis, Wm. P. Esq.	1	0
Lingham, F. H. Esq., per Rhosneigr Life-boat	1	1
Lingham, Mrs., per Rhosneigr Life-boat	1	1
Luck, Richard, Esq.	10	6
Mason, Rev. Wms.	10	0
Massey, Mrs.	10	0
Massey, W. Esq.	10	0
McCorquodale, Mr.	1	0
McCorquodale, Mrs.	1	0
Meयरick, Sir George, Bart.	2	0
Millington, Jno. Esq.	10	0
*Mitchell, H. B. Esq.	1	0
Mitchell, Mrs. H. B.	1	0
Morgan, Rev. B.	1	0
Neave, The Hon. Lady	10	0
Nunn, J. P. Esq., per Rhosneigr Life-boat	1	1
Nunn, Mrs. for Rhosneigr Life-boat	1	1
Ogie, Admiral	10	6
Owen, John, Esq.	1	0
Owen, Rev. H. D., D.D.	1	0
Treudraeth	1	1
Owen, Rev. H. D., M.A., Penmynydd	1	0
*Owen, R. Brysco, Esq.	1	0
*Owen, R. E. Esq.	10	0

£.	s.	d.
Owen, W. H. Esq.	2	2
Pacey, J. Esq.	1	0
Faynter, J. W. Esq.	10	0
Penrhyn, Lord	5	0
Platt, J. H. Esq.	5	0
Platt, Robert, Esq.	2	0
Poole, Henry R., Esq.	1	0
Preston, N. Francis, Esq. Swainston	10	0
Price, Mrs. Hugh	1	0
Price, J. B. Esq.	10	0
Pritchard, Rev. H.	10	0
Rayner, Captain G.	5	0
Pritchard	5	0
Roberts, Arthur, Esq.	1	0
Roberts, Mr. J., Brynhyfryd	10	0
Roberts, J. Esq., Tydydn Mawr	10	6
Roberts, Mr. David, Rhyd	10	6
Roberts, Robert, Esq.	2	2
Roscoe, Mrs.	1	1
Scotfold, W. J. Esq., per Rhosneigr Life-boat	1	1
*Slater, Mr. J.	10	0
Smith, Asherton, Esq.	2	0
Smith, Branston, Maj.	1	1
Souter, Miss, per Rhosneigr Life-boat	1	1
Souter, Miss F., per Rhosneigr Life-boat	1	1
Spargo, Nicholas, Esq.	10	0
Sparrow, J. Bodychan, Esq.	1	1
Spode, Josiah, Esq.	2	0
Staples, Mr. E.	10	0
*Thomas, Mr. E. R.	10	0
Thomas, Lieut.-Col. Wm. Beaumaris	10	6
*Trevor, Rev. Warren	0	0
Trevor, Mrs.	10	6
Verney, Captain E., R.N.	1	0
Warner, Thos. Esq.	2	0
Whitehead, J. D., Esq.	5	0
Williams, Rev. Robt.	1	1
Williams, Rev. W. Wynne, Jun.	10	0
Williams, Miss, Tanygraig	1	0
Williams, Mrs. Tros-y-afon	1	1
Williams, Mrs. H. O.	10	0
Williams, W. Esq.	2	0
Williams, Rev. John	10	0
Williams, Rev. J. Evan	5	0
Wyatt, Mrs., Port Dinorwic	1	0
Wynne, Mrs. Henry	16	0
Sums under 5s.	4	0
Total	124	6

Donations and Collections, 1881-82.

Contribution boxes at Bulkeley Arms Hotel, Beaumaris	11	1
Buller, The Hon. Mrs. Yarde	2	0

£.	s.	d.
Coll. in Llanbadrig Church, per Rev. T. Lloyd, Kyffin	4	3
Collected in Llansadwrn Church, per Rev. R. H. Williams	1	3
Evans, Rev. J. W., at Moelfre Church	2	8
Fluett, Thomas, Esq.	1	0
Hughes, D.	10	0
Llanfaes & Penmon churches, per Rev. T. W. Trevor	17	0
Preston, W. M. Esq., Collecting Box	1	1
Proceeds of Concert at Beaumaris, per W. M. Preston, Esq.	21	8
Rayner, Mrs. G. Pritchard, contents of Contribution Box	2	18
Stewart, Capt.	1	0
Trevor, Rev. T. Warren, Llanfaes, Collecting Box	14	6
Turner, Miss, Collecting Box	3	3
Williams, W.	16	0
Wynne Eyton, T. Esq., Collecting Box	1	1
Sums under 5s.	1	3
Total Dons.	61	0
Total Subs.	124	6
£185 6 6		

HOLYHEAD BRANCH.

President— The Hon. W. O. STANLEY.		
Chairman— Rev. Chancellor BRISCOE, D.D.		
Treasurer and Hon. Sec.— W. P. ELLIOTT, Esq.		
Annual Subscriptions.		
Beaumont, Capt.	10	0
*Briscoe, Rev. Chancellor, D.D.	10	0
*Cay, Capt. R.N.	10	0
City of Dublin Steam Packet Co.	5	0
Davis, Richd., Esq. M.P.	1	1
*Elliott, W. P. Esq.	10	6
Ellis, Mr. John	5	0
*Griffith, J. Lloyd, Esq.	1	0
*Haldane, Capt.	1	0
Hughes, Mr. John	5	0
Hughes, Mr. H. G.	5	0
*Jones, Capt. J. E., R.M.S. Ulster	1	0
Jones, Mr. Jos.	5	0
*Jones, R. R. Capt.	10	0
*Kendall, Captain of R.M.S. Connaught	10	0
Lewis, Capt. Geo.	10	0
Lloyd, Morgan, Esq., Q.C., M.P.	1	1
London and North Western Raily Co.	10	0
*Mackenzie, Admiral	1	0
Peters, Mr. John	5	0

£.	s.	d.
Pritchard, J. M. Esq., N. P. Bank	1	1
Pritchard, Mr. R.	5	0
Stanley, Hon. W. O.	1	0
Williams, Mr. Hugh	10	0
Williams, Mr.	5	0
Sums	29	0

Donations.

King's Arms Hotel	7	1
Life-boat House Box	6	0
Marine Hotel	1	0
Sums under 5s.	12	9
Total Dons.	2	6
Total Subs.	29	0
£31 6 8		

Berkshire.

READING BRANCH.

Honorary Secretary—
C. STEPHENS, Esq.

Annual Subscriptions.

£.	s.	d.
Andrews, C. J. Esq.	10	6
Austen, Capt. R.N.	1	1
Bailey, Mr. J.B.	2	2
Barnett, F. C. C. Esq.	1	1
Beale, Lansdowne, Esq.	1	1
Benyon, R. Esq.	3	3
Birch, Capt. R.N.	1	0
Blackwell, Messrs. E. and F.	10	6
Blagrove, J. H. Esq.	1	1
Blandy, F. J. Esq.	1	1
Blandy, H. B. Esq.	1	1
Blandy, W. F. Esq.	1	1
Blowers and Son, Messrs.	10	6
Bourne, J. Esq.	10	0
Brown, Mr. G. J.	1	0
Butler, Mr. G. R.	10	0
Bracher and Sydenham, Messrs.	10	6
Bradley, Mr. R.	10	0
Cantrell, Mr. W. S.	10	0
Catchpool, Mr. R. D.	1	0
Cobham, Capt. A. W.	1	1
Cobham, A. C. Esq.	1	0
Cocks, Mrs. C.	10	0
Collins, Chas. Esq.	10	6
Collins, Henry, Esq.	10	0
Cooper, Messrs. J. O. and Son	10	0
Cooper, Mr. Lewis	10	0
Cowslade, H. H. Esq.	1	1
Cowslade, W. W. Esq.	1	0
Crawshay, Mrs.	5	0
Davis, Mr. E.	10	6
Dodd, J. T. Esq.	10	6
Edge, Mrs.	1	1
Elliot, Adml. R.N.	1	1
F. W. A.	2	0
Ferguson and Son, Messrs.	10	6
Fleet, Mrs.	1	0
Forbes, A. C. Esq.	1	1
Fuller, Mr. Jesiah.	1	0

NEWQUAY & ABER-AYRON BRANCH.

President—
Captain TAYLOR.

Honorary Secretary—
Capt. DAVID JAMES.

Annual Subscriptions.

	£.	s.	d.
Davey, Rev. W. H., M.A.	10	6	
Davies, Mrs.	5	0	
Davies, T. Esq.	10	0	
*Evans, Dr.	5	0	
Evans, Stephen, Esq.	1	0	
*Griffiths, Rev. D.	5	0	
*James, Capt. David	5	0	
*Jones, Dr.	5	0	
*Jones, J. Esq.	5	0	
*Jones, Rev. J.	5	0	
*Jones, Mr. Thomas	5	0	
Jones, T. J. Esq., Aberdare	10	0	
Morris, Thos. Esq., National Provincial Bank	2	0	0
*Perrott, Mr. J.	5	0	
Pyce, J. P. V. Esq.	10	6	
Stickland, W. J. Esq.	5	0	
*Taylor, Capt.	10	0	
Thomas, Mrs.	5	0	
Total	£9	17	0

Carmarthenshire.

CARMARTHEN BAY BRANCH.

President—
VISCOUNT EMLYN, M.P.

Vice-President—
MICHAEL JENNINGS, Esq.

Honorary Secretary—
J. B. RISLEY, Esq.

Annual Subscriptions.

	£.	s.	d.
Bath, Mrs. Henry J., Altyferin	1	0	0
*Bradley, F. L. Esq.	1	1	0
Bright and Garrard, Messrs.	5	0	
Brigstocke, W. B. P. Esq.	1	1	0
Hrigstocke, Mrs.	2	6	
Buckley, Mr. J. N.	5	0	
Cawdor, The Earl of	5	0	
Cross, Miss Arengo	10	0	
Davies, Mostyn, Esq.	5	0	
*Day, Lieut.-Col.	10	6	
Edwardes, Messrs.	2	6	
*Edwardes, Richard, Esq.	1	1	0
Evans, Rev. Pugh	5	0	
Evans, William, Esq.	1	0	
Falkener, E. Esq.	1	1	0
Gwynne, Sackville, Esq.	5	0	
Hamilton, Lady	1	0	
*James, Rev. R. J.	10	6	
*Jennings, R. Esq.	1	1	0
Lester and Co., Messrs. T.	1	1	0
Morgan, Mr. W. J., "Welshman"	10	6	
Morgan, Mr. D. M.	5	0	
Morris, T. G. Esq.	1	1	0
*Nevill, W. H. Esq.	1	1	0
Norton, Henry, Esq.	10	6	
Norton, Mrs. W.	1	0	
*Parnell, Robert, Esq.	2	2	0
Peel, Mrs.	10	0	

	£.	s.	d.
*Peel, R. W. Esq.	10	0	
Richards, R. W. Esq.	5	0	
*Risley, J. B. Esq.	1	1	0
*Scott, J. J. Esq.	10	0	
Sinnett, Rev. W. H.	10	0	
Spurrell, George, Esq., St. David's, The Bishop of	2	2	0
Thomas, George, Esq.	10	0	
Thomas, Henry, Esq.	1	0	
Thomas, Thos. Esq.	5	0	
*Tregoning, J.S. Esq.	1	0	
Vaughan, Mr. E.	5	0	
Warburton, Mrs.	1	0	
Wienholt, Mrs. F.	2	0	
Wilkins, Messrs., Bank	1	1	0
Williams, B. T. Esq., Q.C., M.P.	10	6	
Williams, Mrs. H.	1	1	0
Total	37	10	6

Donations.

Contribution Boxes.	8	8	6
Total	£45	19	0

LLANELLY AND PEMBREY BRANCH.

President—
GENERAL MALCOLM, C.B.

Vice-President—
CHARLES NEVILL, Esq.

Chairman—
Capt. LUCKKRAFT, R.N.

Honorary Secretary—
GERARD ELKINGTON, Esq.

Annual Subscriptions.

	£.	s.	d.
Ashburnham, Right Hon. the Earl of	5	0	0
Bevan, Mrs. Samuel	10	6	
Broom, Mr. C. N.	10	6	
Buckley, Dr.	10	6	
*Buckley, Mr. James	1	1	0
Burry Port and Gwendreath Valley Co.	2	2	0
Bythway, Mr. W.	10	6	
Coysh, Mr. Joseph	5	0	
*Elkington, Mr. G. B. I	0		
*Elkington, Mr. H.	1	1	0
*Elkington, Mr. J. B. I	0		
Evans, Mr. Evan	10	0	
Evans, Mr. G.	5	0	
*Gausen, Mr. C. W.	1	0	
Griffiths, Mr. Thomas	10	6	
Hand, Mrs. T. K.	1	1	0
Jenkins, Mr. John	1	1	0
Jones	1	1	0
Johnson, Mr. Thos.	10	6	
Jones, Mr. B.	10	0	
*Jones, Capt. T.	5	0	
Lewis, Mr. C. W.	2	0	0
Mansel	2	0	0
Llanelly Harbour Commissioners	5	0	0
Lloyd, Mr. E. H.	5	0	0
*Luckraft, Capt.	1	1	0
J. P., R.N.	10	0	
*Maclaran, Mr. Rowland	1	1	0
*Malcolm, General, C.B.	2	2	0
Margrave, Mr. Robt.	10	6	
Mason & Elkington, Messrs.	2	2	0
Mitchell, Mr. J.	5	0	
Nevill, Druce & Co., Messrs.	3	0	0
Pemberton, Mr. H. W.	2	2	0
Phillips, Mr. Edward	1	1	0
Randell, Mr. John	5	0	
Rees, Mr. Bernard	5	0	
*Rees, Mr. David	10	6	
*Rees, Mr. Mansel	1	1	0

	£.	s.	d.
*Risley & Burgman, Messrs.	1	1	0
Roberts, Mr. W.	10	0	
Rogers, Mr. John H.	10	6	
Samuel Bros. Messrs.	1	1	0
Stepney, Sir A. K. Cowell	3	0	0
T. R. T.	5	5	0
Thomas, Mr. Henry	1	1	0
Thomas, Mr. R. Goring	1	1	0
Thomas, Mr. Wm.	1	1	0
*Tregoning, Mr. J.S.	1	1	0
Waddle, Mr. J. R.	10	6	
Young, Mr. T.	5	0	
Total	£57	13	0

Carmarthenshire.

ORME'S HEAD (LLANDUDNO) BRANCH.

Chairman—
Rev. J. MORGAN, Llandudno.

Treasurer—
J. ADEY WELLS, Esq. N.P. Bank, Llandudno.

Honorary Secretary—
G. F. FELTON, Esq.

Annual Subscriptions.

	£.	s.	d.
Chantrey, J. Esq.	10	6	
Hazledine, H. Esq.	1	1	0
J.P.	1	1	0
Myatt, J. Esq.	1	1	0
Nicol, Dr., J.P.	10	6	
Rees, Rev. H., Conway	1	1	0
Rws. Mrs. Conway	1	1	0
Williams, Dr. Bold	10	6	
Woodward, W. Esq.	2	2	0
Total	7	17	6

Donations.

Arrowsmith, E. Esq. Collected	7	3	6
Badley, Mrs. (per J. A. Cheeseman, Esq.)	1	0	0
Dennis, G. J. Esq. (col. by)	8	0	
Warrin, W. Esq.	7	0	
Pillar Box	14	13	4
Total Dons	23	11	10
Total Subs.	7	17	6
Total	£31	9	4

PORTHDINLLAEN AND ABERSOCH BRANCH.

Honorary Secretary—
Rev. O. LLOYD WILLIAMS.

Annual Subscriptions.

	£.	s.	d.
Asheton-Smith, G.W. D. Esq.	2	0	0
Finch, Col. Wynne	3	0	0
Hughes, W. Hulkeley, Esq. M.P.	2	0	0
Lloyd-Edwardes, F. W. Esq.	5	0	0
Parry, Love Jones, Esq.	5	0	0
Total	£17	0	0

ABERSOCH BRANCH.

Annual Subscriptions.

	£.	s.	d.
Asheton-Smith, G.W. D., Esq.	3	0	0
Concert at Pwllheli	9	16	0
Dawgoc Mine Co.	1	1	0
Evans Owen, Esq.	2	0	0
Nanney, J. H. Ellis, Esq.	2	0	0
Pearson, G. F. Esq.	1	1	0
Port Madoc Mutual Marine Insurance	5	0	0
Tan-y-Bwlch Mine Co.	1	1	0
Total	£24	19	0

PORTMADOC BRANCH.

Chairman—
Capt. D. RICHARDS.

Honorary Secretary—
D. HOMFRAY, Esq.

Annual Subscriptions.

	£.	s.	d.
Roberts, Mr. J. P. for Tremadoc Estate	1	1	0
Cwmorthin Slate Co.	1	1	0
Dunlop, A. M. Esq.	10	6	
Ellis-Nanney, H. J. Esq.	2	0	0
Evans, Owen, Esq.	1	1	0
Greaves & Sons, John W.	1	0	0
Harlech, The Rt. Hon. Lord	1	1	0
*Holland, S. Esq., M.P.	1	0	0
*Homfray, D. Esq.	10	0	
Hopkinson, Jno. Esq.	1	0	0
Horn, John, Esq.	1	0	0
Jones, J. H. Esq.	5	0	
Jones, William, Esq.	1	0	0
Mutual Insurance Society	10	0	0
Oakley, W. E. Esq.	5	0	0
Owen, Capt. G. H.	1	0	0
Perival, F. S. Esq.	1	0	0
Priestley, Miss	1	0	0
Spencer, C. E. Esq.	10	6	
Welsh Slate Co.	1	0	0
Total	£32	0	0

Cheshire.

CHESTER BRANCH.

Hon. Secretary—
THOMAS H. DIXON, Esq.

Annual Subscriptions.

	£.	s.	d.
Brassey, J. E. Esq.	10	6	
Dixon, Miss P. A.	1	1	0
Dixon, Mrs. A. M.	1	1	0
Dixon, T. H. Esq.	3	3	0
Garnett, W.	10	6	
Masse, Admiral	1	0	0
Parry, C. T. W. Esq.	1	1	0
Potts, A. Esq.	3	3	0
Rogers, John	1	1	0
Theton, Miss	1	1	0
Townshend, C. Esq.	1	1	0
Walker, Parker, and Co. Messrs. J.	2	2	0
Wood, Albert, Esq. J.P.	1	1	0
Contribution Box	7	3	
Total	£18	3	3

BRANCHES—LIST OF ANNUAL SUBSCRIPTIONS AND DONATIONS.

565

PORT OF RUNCORN BRANCH.

Honorary Secretary—
F. SAMONS, Esq.
Collector H.M. Customs.

Annual Subscriptions.

£. s. d.	
Anderson, Capt.	
"Four Brothers",	- 10 6
Brundrit, John, Esq.	1 1 0
Clark, Capt.	1 1 0
Findley, E. Esq.	- 10 6
Hatchurst & Sons,	
Messrs.	1 1 0
Higson, J. Esq.	1 1 0
Hayes, W. and Co.	1 1 0
Simpson, Davies, & Sons, Messrs.	1 1 0
Speakman, Philip, Esq.	- 10 6
Stoek, Samuel, Esq.	1 1 0
Weaver Navigation Company, per Capt. Clarke.	1 0 0
Wells, L. B. Esq.	- 10 6
Contribution Box at Custom House	1 5 6
Total	£11 14 6

Cornwall.

BUDE BRANCH.

President—
Sir T. DYKE ACLAND,
Bart., M.P.

Treasurer—
Rev. E. HIGHTON.

Honorary Secretary—
WILLIAM ROWE, Esq.

Annual Subscriptions.

£. s. d.	
Acland, Sir T. D.	
Bart., M.P.	5 0 0
*Carnes, Rev. T. S.	- 10 0
*Carnes, Mrs.	- 5 0
*Chamier, E. Esq.	1 0 0
Constable, Mrs.	- 10 0
*Davey, Oliver, Esq.	- 5 0
*Highton, Rev. E.	- 5 0
Hockin, John, Esq.	1 0 0
Hockin, Mrs. Frank	- 5 0
*Mills, A. Esq.	1 1 0
Thynne, Rev. Lord John	5 0 0
Sums under 5s.	- 2 6
Total	£15 3 6

CADGWITH BRANCH.

President—
Captain SYMONS, R.N.

Chairman—
Mr. Cox, Cadgwith.

Honorary Secretary—
Rev. F. C. JACKSON.

Annual Subscriptions.

Beringer, Mr.	- 2 6
Boaden, Mr. Joseph	- 5 0
Davis, Thomas, Esq.	1 1 0
Rogers, Henry, Esq.	- 10 6
St. Aubyn, Sir John, M.P.	1 0 0

£. s. d.	
Tyacke, Walker, Esq.	- 10 6
Vivian, Pendarvis, Esq., M.P.	1 1 0
Vyvyan, Sir Vyvell	1 1 0
W.B.L.	1 1 0
Total	£6 12 6

Donations.	
Cadgwith Boxes	- 18 6
Haynes, Mr. T.	- 5 0
Penzance Hotel Boxes	1 7 6
Total Dons	2 11 0
Total Subs.	6 12 6
	£9 3 6

FALMOUTH BRANCH.

President—
HOWARD FOX, Esq.

Chairman and Treasurer—
THOMAS WEBBER, Esq., J.P.

Honorary Secretary—
CHARLES CLIFT, Esq.

Annual Subscriptions.

Baset, G. L. Esq.	3 0 0
Brett, H. Balliol, M.P.	2 2 0
*Broad, and Sons, Messrs.	1 1 0
Bull, Col. M.	- 10 0
Carn, Messrs. W. and E. C.	1 1 0
*Carter, Mr. R.	- 5 0
*Chard, Mr. A.	- 5 0
*Cheesman, Mr. R. G.	- 10 6
*Clift, Mr. C.	- 5 0
Clinton, Lord.	2 2 0
Corfield, Mr. T.	- 2 6
Corfield, Mr. W.	- 5 0
*Cox & Sons, Messrs.	- 10 6
Fitzgerald, Colonel.	- 10 0
*Fox and Co., Messrs. G. C.	2 2 0
Fox, Mrs. Alfred	1 1 0
Freeman, Mrs. John	- 10 0
Genn, Mr. W. J.	- 10 6
Halliday, Mr. J. W.	- 5 0
Hitchens, Mr. J. O.	- 10 6
Hosken, Mrs. S.	1 0 0
Jenkins, Mr. D. J., M.P.	2 2 0
Jenkins, Mr. G. A.	- 10 6
Jenkins, Mr. W.	- 5 0
Kemble, Mrs.	5 0 0
*Kimberley, Earl of.	1 1 0
*Kennerley, Mr. J. C.	1 0 0
*Lean, Mr. W. H.	- 10 6
Melville, Mr. P.	1 1 0
Oliver, Mrs. J.	- 5 0
*Pollard, Mr. H.	- 5 0
Selley, Mrs. Wm.	- 5 0
*Solomon, Mr. W. H.	- 5 0
Snow, Mr. R.	- 5 0
St. Aubyn, Sir John, Bart., M.P.	1 1 0
*Symons, Mr. G. W. H.	- 10 0
*Tilly, Mr. H.	- 5 0
Tremayne, Col.	1 1 0
Vivian, Mr. Pen- darvis, M.P.	1 1 0
*Webber, Mr. T.	- 10 6
Williams and Co., Messrs.	1 1 0
*Willmore, Mr. A.	- 5 0
Total	£36 19 0

FOWEY BRANCH.

President—
JONATHAN RASHLEIGH, Esq.
Chairman—

Treasurer—
ARTHUR COODE, Esq.

Honorary Secretary—
W. E. GRACH, Esq.

Honorary Collector—
W. LOWRY, Esq.

Annual Subscriptions.

£. s. d.	
*Bate, Mr. George	- 5 0
Carlyon, E. Esq.	1 1 0
Carnall, R. Esq.	- 10 0
Cocks, Lieut.-Col.	1 1 0
*Coode, Arthur, Esq.	1 1 0
Coode, Edward, Esq.	1 1 0
Coode, John, Esq.	1 1 0
Crowder, A. E. Esq.	2 12 6
*Davis, A. A., M.D.	- 5 0
Fortescue, Capt.	1 0 0
Freeth, George, Esq.	1 1 0
Martyn, W. L. Esq.	1 1 0
Peard, Mrs.	1 0 0
*Purcell, Rev. H. N.	- 10 0
*Rashleigh, Jonathan, Esq.	2 2 0
Robartes, Lord (the late)	1 1 0
Sartoris, E. J. Esq.	2 12 6
Stopford-Sackville, Mrs.	2 2 0
Truscott, Chas. Esq.	- 10 6
White, Mrs. S.	- 10 0
*Wreford, W. Esq.	- 5 0
Total	£22 12 6

HAYLE BRANCH.

Chairman—
Rev. F. HOCKIN, Rector.

Honorary Secretary—
JOHN POOLE, Esq.

Annual Subscriptions.

Bain, D. W. Esq.	- 5 0
Basset, G. L. Esq.	2 0 0
Bazeley, Mr. Jas.	- 5 0
Bolitho, Sons and Co. Messrs.	1 1 0
Burall, Mrs. J. H.	1 1 0
Goldsworthy, Mr. I.	- 5 0
Harvey and Co.	5 0 0
*Harvey, Frank, Esq.	1 1 0
Harvey, Wm. Esq.	1 1 0
Hitchens, M. T. Esq.	- 5 0
Hockin, G. C. Esq.	1 1 0
*Hockin, Rev. F.	1 1 0
*Hosken, Wm. Esq.	- 10 0
*Husband, W. Esq.	1 1 0
Millett, R. O. Esq.	1 1 0
Minors, Richard, Esq.	- 5 0
Mudge, James, Esq.	- 10 0
Nicholls, Mr. Loam.	- 10 0
Oliver, Miss	- 5 0
Pearce, Mr. G.	- 5 0
Polkinghorne, Mr. T.	- 5 0
Pool, Capt. F. H.	- 10 6
Pool, Mr. Henry	- 5 0
Pool, Messrs. J. F.	- 5 0
Præd, C. Esq.	2 2 0
Rawlings, W. J. Esq.	- 10 0
Rodd, F. Esq.	1 1 0
Roskelly, Capt.	- 5 0
Rowe, Mr. John.	- 5 0
Spray, Capt. P. B.	- 10 6
St. Aubyn, Sir John, Bart., M.P.	1 1 0
St. Aubyn, Rev. St. Aubyn H. Moles- worth	1 1 0
The Trevethoe Estate	2 2 0
Trevithick and Sons, Messrs. J. H.	1 1 0

*Vivian, John, Esq.	- 10 0
West, Nicks, J. Esq.	- 10 0
West, William, Esq.	- 10 0
Total	31 7 0

Donations.

Mills, Miss	1 0 0
Sums under 5s.	- 12 4
Total	£32 19 4

LIZARD (POLPEAR) BRANCH.

President—

Honorary Secretary—
Rev. P. VYVYAN ROBINSON.

Annual Subscriptions.

Jauvrin, Misses	1 0 0
Gregory, Mrs. (Mada- gascar)	2 2 0
Robartes, Lord (the late)	10 10 0
Spencer, Rev. E.	1 1 0
St. Aubyn, Sir John, Bart., M.P.	1 1 0
Western Morning News, Proprietors of	1 1 0
Total	16 15 0

Donations.

Collection Boxes— Hill's Hotel	1 15 0
Boat House	1 6 0
Total Dons	3 1 0
Total Subs.	16 15 0
	£19 15 0

LOOE BRANCH.

President—
W. H. POLK CAREW, Esq.

Chairman—
G. KERSWILL, Esq.

Honorary Secretary—
ROBERT THOMAS, Esq.

Annual Subscriptions.

Allen, Misses	- 5 0
Bawden, Mr.	- 5 0
*Bewes, Rev. T. A.	1 0 0
Buller, J. P. Esq.	5 0 0
Bush, Rev. Paul	- 10 0
Campbell, Rev. Ed.	- 5 0
Campbell, John, Esq.	- 10 0
Campbell, Mrs. T.	- 10 0
Campbell, T. Esq.	- 10 0
*Campbell, Truman, Esq.	- 10 0
Carew, W. H. P. Esq.	1 0 0
Caunter, Henry, Esq.	- 10 0
*Childs, Horlase, Esq.	- 10 0
Clogg, J. L. Esq.	- 10 0
Clymo, Mrs. James	- 10 0
Coad, J. L. Esq.	- 5 0
Congdon, Mr. J.	- 10 0
Courtney, L. Esq., M.P.	1 0 0
Crichton, M. F. Esq.	- 10 0
Fisher, Rev. J. F.	- 10 0
Foster, L. C. Esq.	- 10 0
Foeter, Rd. Esq.	1 1 0
Furneau, Rev. A.	- 5 0
Garrett, Rev. S.	- 10 0
Gill, Dr.	- 5 0
Glanville, Rev. H. C.	- 10 0
*Glencross, Rev. Ed.	- 10 0
Glencross, Rev. Jas.	- 10 0
Gooch, Sir Alfred	
Shirlock	2 2 0

	£.	s.	d.
Grigg, John, Esq.	10	0	0
Hawke, Rd. Esq.	10	0	0
Hicks, Mr. B.	5	0	0
Hicks, Mrs. J. S.	5	0	0
Hicks, Mr. William	5	0	0
Hill, Capt. John	5	0	0
Hooppel, Mrs.	5	0	0
Iago, Mr.	5	0	0
Jenkins, Rev. D.	5	0	0
Jenkins, S. W. Esq.	10	0	0
*Jones, Rev. E. D.	10	0	0
Kemble, Rev. A.	1	0	0
*Kerswill, Geo. Esq.	10	0	0
Kerswill, Mrs. Geo.	5	0	0
*Kerswill, J. B. Esq.	10	0	0
Kerswill, Robt. Esq.	10	0	0
King, Rev. Joseph	10	0	0
Kitson, Rev. J. F.	10	0	0
*Little, Mr. Rd.	5	0	0
*Marshall, Capt. John	5	0	0
Marshall, L. Carrington, Esq.	10	0	0
Marshall, Wm. Esq.	1	0	0
Martin, Rev. (anon.)	1	0	0
Medland, James, Esq.	5	0	0
Moret, Col. de	10	0	0
*Neale, E. Jas. Esq.	1	0	0
Nicholas, John, Esq.	10	0	0
Norris, Mrs.	10	0	0
Olver, Mr. Thomas	5	0	0
*Poad, Mr. John	5	0	0
Pole, Henry, Esq.	1	0	0
*Polkinghorne, Wm. Esq.	10	0	0
Rendle, C. B. Esq.	5	0	0
Roberts, Miss, Trehill	1	0	0
St. Germans, The Earl of	1	0	0
St. Germans, The Countess of	10	0	0
Symons, J. Esq.	5	0	0
Tatham, Mrs.	5	0	0
*Thomas, Dr.	5	0	0
*Thomas, Robert, Esq.	10	0	0
Trelawny, Sir John	1	0	0
Trelawny, W. L. S. Esq.	1	0	0
Tucker, Mr. W. T.	5	0	0
Walters, Mr. James	5	0	0
Walters, Capt. John	5	0	0
Walters, Capt. Sam.	5	0	0
West, Rev. O.	10	0	0
White, J. Esq.	10	0	0
White, Mrs.	10	0	0
Wilcocks, Isaac, Esq.	10	0	0
Willcock, H. D., Esq.	5	0	0
Willes, C. Esq.	10	0	0
Wynhall, Mr. E.	5	0	0
Total	48	14	0
Donation.			
Small sums	12	6	6
Total	£47	6	6
MEVAGISSEY BRANCH.			
President—			
JOHN TREMAYNE, Esq., J.P.			
Chairman—			
Capt. WILLIAM BALL.			
Honorary Secretary—			
Capt. J. BALL FARRAN.			
Annual Subscriptions.			
Bailey, Edward, Esq.	2	0	0
Coode, Arthur, Esq.	10	6	0
*Farran, Capt. J. B.	5	0	0
Higman, H. W. Esq.	10	0	0
Mr. Edcumbe, Lord	3	0	0
*Tremayne, J. Esq.	5	0	0
Williams, John M. Esq.	3	0	0
Sums under 5s.	2	6	0
Total	£14	8	0

MULLION BRANCH.		
President—		
Chairman—		
J. SYDNEY DAVEY, Esq., J.P.		
Honorary Secretary—		
E. G. HARVEY, Vicar.		
Annual Subscriptions.		
	£.	s. d.
Benney, Mrs. R.	1	1 0
Davey, J. Sydney, Esq.	1	1 0
Davey, Richard, Esq.	1	1 0
Head, Mrs.	5	0
Jose, Mr. Jer.	5	0
Kemphorne, Mr. J. B.	10	0
Robartes, Lord (the late)	5	5 0
*Shepherd, Mr. T.	5	5 0
*Thomas, Mr. Joseph	5	0
*Thomas, Mr. Fredk.	5	0
Tronson, Mr. T.	10	0
Vvyyan, Rev. Sir Vyell, Bart.	2	0 0
*Williams, Mr. Peter	10	0
Sums under 5s.	1	7 6
Total	14	10 6
Donations.		
Collection Box	1	4
Total	£14	11 10

NEWQUAY BRANCH.		
Chairman—		
Major W. E. MICHELL.		
Honorary Secretary—		
Capt. W. THOMAS.		
Annual Subscriptions.		
Boyle, Mr.	5	0
Carriell, T. M. Esq.	5	0
Carter, Capt. W. J.	5	0
Carus-Wilson, E. S. Esq.	10	0
Collins, J. B. Esq.	1	0
Crocker, Capt. John	5	0
Edwards, Mr. J. V.	5	0
Ennor, Mr. J.	5	0
Hicks, Mr. W.	5	0
*Hicks, Mr. G.	10	0
Hooper, Mr. J.	5	0
Jenkin, Mr. Albert	5	0
Jenkin, Capt. Thomas	5	0
Jenkin, Capt. James	5	0
Martyn, Mr. S. E.	1	0
Michell, Major W.	1	0
*Michell, Major	1	0
Molesworth, Sir P. Bt.	10	0
*Morgan, Capt. W. R.N.	5	0
Oates, Richd.	5	0
Oliver, Mr. R. S.	5	0
Pearse, Miss	1	0
*Prout, Capt. Thos.	5	0
Reynolds, Mr. Jno.	5	0
Rillstone, Mr.	5	0
Shuckford, Mrs.	1	0
Stephens, Mr. Sampson	5	0
*Thomas, Capt. Wm.	5	0
Tonkyn, Capt. W.	5	0
Tredwen, Mr. R.	5	0
Treffry, C. E. Esq.	1	0
Tummon, Mr. Cotton	5	0
Wellington, Mr. B.	5	0
Weston, Mr. Fredk.	5	0
Willyams, A. Esq.	10	0
Willyams, B. Esq.	1	0
Total	116	6 0
Donations.		
James, Miss Ellen.	1	0 0

Box at Life-boat		
House	1	4 0
Do. at Wellington Hotel, Boscastle, per Capt. J. Bellamy	1	14 9
Other Boxes	8	8 8
Total Dons.	4	7 5
Total Subs.	16	6 0
£20	13	5

PADSTOW BRANCH.		
Chairman—		
C. G. PRIDEAUX BRUNE, Esq.		
Honorary Secretary—		
Capt. ROBERT KEY.		
Annual Subscriptions.		
*Allport, Mr. Sam.	10	0
*Allport, Mr. W. S.	5	0
Beatrice, Lady Molesworth	10	6
*Bishop, Mr.	1	0 0
Broad, Mr. Arch. J. B.	10	0
*Brune, Prideaux, Esq.	2	0 0
Clemow and Son, Messrs.	1	1 0
Carlyon, the Rev. J.	5	0
Cory & Sons, Messrs.	10	0
Gurney, Rev. Goldsworthy	1	0 0
Guy, Mrs.	10	6
Hellyar, Miss	1	1 0
Hicks, Mr.	10	0
Key, Capt. R.	5	0
*Langford, Capt. R.	5	0
*Langford, Mr. Sussex	5	0
Lloyd, Mr. J. S. H.	5	0
Mann, Rev. C. N.	5	0
Marley, Mr. Hen. F.	5	0
*Martyn, Mr. Henry	1	1 0
Martyn, Miss G.	10	6
Martyn, Mr. I.	1	1 0
Martyn, Mr. S. Symons	1	0
Martyn, Mrs. S. Symons	5	0
Martyn, Mr. Thomas	1	1 0
Molesworth, Sir Paul W. Bart.	10	6
Nicholls, Mr.	10	0
Paynter, Rev. Samuel	1	0 0
Peter, Mrs.	1	0 0
Peter, Miss	1	0 0
Phillipps, Mr. H. N.	2	2 0
Potter, W. R. C. Esq.	1	0 0
*Rawle, Capt.	10	6
Rawlings, Miss	1	0 0
Richards, Mr. W.	1	0 0
Robartes, Lord (the late)	1	1 0
Rolleston, Mrs.	5	0
Sawle, Dowager Lady Graves	1	1 0
Stephens, Mrs.	10	0
Tregaskis, Mr. Saml.	5	0
*Tyacke, the Rev. R.	10	0
Wilson, Capt.	1	1 0
Total	30	8 6

PENZANCE AND SENNEN COVE BRANCH.		
Chairman—		
THE MAYOR.		
Treasurer—		
JOHN R. BRANWELL, Esq.		
Honorary Secretary—		
FREDK. C. MATHEWS, Esq.		
Annual Subscriptions.		
Adkins, J. C. Esq.	1	1 0
Aitkin, Rev. R. W., St. Paul	5	0

Ash, Mr. J. W.		
Bazeley and Son, Messrs. George	5	0
Bedford, Capt. D. B.	5	0
Bennett, W. S. Esq.	5	0
*Boase, Francis, Esq. (Mayor)	10	0
*Bodilly and Sons, Messrs. T. H.	10	0
Bolitho, Edw. Esq.	1	0 0
Bolitho, R. F. Esq.	1	1 0
*Bolitho, T. S. Esq.	1	0 0
Bolitho, T. Robins, Esq.	10	0
Bolitho, T. Bedford, Esq.	10	0
Bolitho, W. Esq.	1	1 0
Bolitho, Mrs. W.	5	0
Borlase, Vice-Adm. C.B.	10	0
Borlase, Walter H. Esq.	10	0
Borlase, W. Copeland, Esq. M.P.	10	0
Boyns, Richd., St. Just	5	0
Boyns, Richd. Boscawden	5	0
Boyns, Nichs., St. Sennen	5	0
*Branwell and Sons, Messrs. R. M.	10	0
Branwell, Miss	5	0
Britain, F. W. Esq.	10	0
Carne, Miss	2	0 0
Carter, Mrs.	5	0
Chenhalls, Mr. A., St. Just	5	0
Clarke, Mr. F. J.	5	0
Cock, William	5	0
Code, T. Esq., Marazion	1	1 0
Cornish, Thomas, Esq.	5	0
Corporation of Penzance	5	0 0
Coulson, Messrs. Tho. and Co.	5	0
Coulson, Rev. T. B., St. Buryan	10	6
Davy, Messrs. E. & H. Davy, Messrs. R. V. and H.	5	0
Dennis, Jas. Esq.	5	0
Dennis, Rev. R. N.	1	1 0
Dennis, Wm. Esq.	10	0
*Doble, Mr. E.	5	0
Hodge, W. H. Esq.	5	0
Downing, S. T. G. Esq.	1	0 0
Edmonds, Miss	5	0
Field, T. W. Esq.	10	0
Fisher, Mrs. E. A.	5	0
Giles, Com. G., R.N.	5	0
Grenfell, P. Esq.	5	0
Hamilton, Mrs.	5	0
Harvey, Mrs. Nichs.	10	0
Harvey, Mr. S. St. Sennen	5	0
Harvey, Mr. H. H., Trevarian	5	0
Hatherton, The Dowager Lady	10	0
*Hedgland, Rev. P., M.A.	10	0
Helni, G. F. Esq.	5	0
Hill, Mr. W.	5	0
Hodge, Hy. Esq., St. Sennen	5	0
*Hobbrook, Mr. A.	5	0
*Holman, Fred. Esq.	1	1 0
Hora, Mr. A. H.	1	1 0
Humphrys, Mr. R., St. Sennen	5	0
Humphrys, Mr. H. T. Escalls	5	0
Jago, the Misses	5	0
James, Mr. F. H.	5	0
James, Mr. John	5	0
*James, Mr. S. H., St. Just	10	0
Jones, J. Winter, Esq.	10	0
King, T. Esq.	10	0

BRANCHES—LIST OF ANNUAL SUBSCRIPTIONS AND DONATIONS. 565

£.	s.	d.	
Laity, Mr. Hy., Penrose	5	0	
Laity, Mr. Hy., Tregurno	5	0	
Lanyon, Mr. J. J.	5	0	
Lavin, Mr. Chas.	5	0	
Le Grice, Chas. D. N. Esq.	10	0	
Longhurst, Miss.	5	0	
Magor, M. Esq.	10	0	
*Marrack, Mr. Philip	5	0	
Martyn, Rev. R. J.	5	0	
*Mathews, Mr. F. C.	5	0	
*Mathews, Messrs. W. D. and Sons	10	0	
Michell, A. O., Esq.	10	0	
Michell, Mr. A. H.	5	0	
Michell, Mrs. John	10	0	
Millett, J. N. R. Esq. Bosavern	5	0	
Milton, J. P. Esq.	10	0	
Montgomery, Dr.	5	0	
Molesworth, Sir P. W.	10	0	
Olver, Mr. G. T.	5	0	
Olver and Symons, Messrs.	5	0	
Pascoe, H. and Son	5	0	
Pascoe, Mr. Nichols, St. Sennen	5	0	
Peel, Miss	5	0	
Peters, Miss.	10	0	
Phillips, Mr. Geo., St. Sennen	5	0	
Polsue and Co.	5	0	
Pool and Son	10	0	
Preston, Rev. Geo. H.	5	0	
Prockett and Bucket	5	0	
Quick, J. R. Esq.	5	0	
Roberts, Mr. Thos., St. Sennen	5	0	
Robinson, Lady	5	0	
*Rodd, W. H. Esq.	5	0	
*Roe, Rev. R. J., St. Sennen	1	1	0
Rogers, Miss (Frearthian)	1	1	0
Rogers, the Misses	5	0	
Ross, C. C. Esq., M.P.	10	0	
Ross, Mrs.	10	0	
Ruck, Mr. John	5	0	
Saundry, J. and Son, St. Sennen	5	0	
Scobell, Geo. Esq.	1	0	0
Spratt, Mr. G. O., Porthurnow	5	0	
St. Aubyn, Sir John, Bart., M.P.	1	1	0
Thomas, Henry, Esq.	5	0	
Thomas, R., St. Just	5	0	
Tonkin, Rev. John, St. Buryan	10	0	
Tonkin, Rev. F.	5	0	
Travers, Major	5	0	
Trelawney, Colonel	5	0	
Tremewen, Mr. N. T., St. Sennen	5	0	
Trevethick, Mrs.	10	0	
Trythall, W. Esq.	10	0	
*Uren, Mr. J. G.	5	0	
Victor, Messrs. R. R. and H.	5	0	
Vigurs, Mrs.	10	0	
White, W. Fodd, Esq.	10	0	
Williams, Mrs.	5	0	
Wills, Mrs.	5	0	
Wingfield, Rev. W. W.	10	0	
Sums under 5s.	13	18	0
Total	£71	12	0

Donations.

Pillar Box, Promenade, and Box at the Lifeboat Station, Penzance	5	5	0
Box, Union Hotel (the Misses Longhurst)	1	0	0
Do. Western Hotel (Mr. W. Mitchell)	7	8	0

£.	s.	d.	
Box, Mount's Bay House (Mrs. Lavins)	13	7	
Mr. Toman, Land's End Hotel	17	1	
Porthcrown Mess., Eastern Telegraph Co.	1	6	6
Small sums	10	10	0
Total Dons.	10	0	8
Total Subs.	71	12	0
Total	£81	12	8

PORThLEVEN BRANCH.

President—

Chairman—

Rev. E. PRIDMORE.
Honorary Secretary—
J. P. THOMAS, Esq.

Annual Subscriptions.

Robartes, Lord	5	5	0
*Bickford-Smith, W., Esq.	1	1	0
Bolitho, Sons & Co.	1	1	0
Cade, Mr. R.	5	0	0
Coode, Ed. Esq.	1	1	0
Cornish Bank Limited, H-iston	1	1	0
Grylls, Col.	1	1	0
Harvey, Wm. Esq.	2	2	0
Ianvon, Mrs.	5	0	0
*Lear, E. W. Esq.	10	0	0
Martyn, Mr. R.	5	0	0
Molesworth - St. Aubyn, W. Esq., M.P.	10	0	0
Pridmore, Rev. E.	1	1	0
Roberts, Mr. H.	5	0	0
Rogers, Capt. J. P., R.A.	1	1	0
Rogers, Miss Elizab.	1	1	0
St. Aubyn, Sir J. M. P.	1	1	0
*Simons, J. Esq.	5	0	0
Sleeman, Mr. W.	5	0	0
Vyvyan, Rev. Sir Vyvell, Bt.	3	3	0
Wise, Rev. R. F.	1	1	0
Young, W. A. Esq.	1	0	0
Sums under 5s.	15	0	0
Total	£25	5	0

PORThUSTOCK BRANCH.

President—

WILLIAM TREVENEN, Esq.

Chairman—

EDWD. J. LEVERTON, Esq.

Honorary Secretary—

Mr. E. P. ROSKRUGE.

Annual Subscriptions.

Robartes, Lord	2	2	0
*Billett, Mr.	5	0	0
Dolman, Jas. Esq.	2	2	0
Fox, G. C. and Co.	1	1	0
Glubb, Rev. P. S.	1	1	0
Griffith, Rev. E.	2	2	0
*Hearle, Mr.	5	0	0
Howard, Rev. A. W.	10	0	0
*James, Mr. Wm.	10	0	0
*Leverton, Edw. Esq.	10	0	0
Lory, C. M. Esq.	5	0	0
Lory, Rev. F. A. P.	5	0	0
*Pengilly, Mr. Alex.	10	0	0
Smedley, Miss.	2	0	0
Smelt, Rev. M. A.	10	0	0

£.	s.	d.	
St. Aubyn, J. Esq. M.P.	1	0	0
Tremayne, Colonel	1	1	0
Trevenen, Wm. Esq.	1	1	0
Venables, Mrs.	10	0	0
Vyvyan, Rev. Sir Vyvell	2	2	0
Total	£19	12	0

PORT ISAAC BRANCH.

Honorary Secretary—
W. R. GUY, Esq.

Annual Subscriptions.

Allen, Mr. Edw.	1	1	0
East Cornwall Bank	1	1	0
Fortescue, Earl.	5	0	0
*Guy, W. R., Esq.	10	0	0
Guy, Mrs. Mark	10	6	0
Hambly, Mrs. E.	10	0	0
Havnes, Jas.	0	2	6
Hellyar, Miss.	1	1	0
*Johnson, Mr. Thos.	5	0	0
Magor, E. A., Esq.	1	0	0
Page, Rev. V.	1	1	0
Pearse, W. Esq.	10	6	0
Pearse, Miss	1	0	0
Stephens, Mrs.	1	1	0
*Treffry, Rev. R.	1	1	0
*Trevan, Dr. M.R.N.	10	0	0
*Trevan, Mr. F.	10	0	0
Wharnciffe, Lord	2	2	0
Total	£18	16	6

PORTLOE BRANCH.

Chairman—
The LORD HYLTON.

Honorary Secretary—
Rev. Canon CORNISH.

Annual Subscriptions.

*Blamey, Mr. J. A.	5	0	0
Blamey, Mr. T.	5	0	0
Carlyon, E. T. Esq.	10	6	0
*Cornish, Rev. J. R.	5	0	0
Devon and Cornwall Bank	10	0	0
*Dunstone, Mr. P.	10	0	0
*Dunstone, Mr. W.	5	0	0
Fookes, Rev. W.	5	0	0
Hylton, Lord.	3	3	0
Miners' Bank, Truro	10	0	0
Peter, Rev. L. M.	1	1	0
Wise, Rev. Canon	10	0	0
Young, J. T. Esq.	10	6	0
Total	£8	10	0

ST. IVES (CORNWALL) BRANCH.

Treasurer and Honorary Secretary—
W. T. TRESIDDER, Esq.

Annual Subscriptions.

Anthony, Mr. M. D.	5	0	0
Bamfield, Mr. R. H.	10	0	0
Batten, Carne and Carne, Messrs.	10	6	0
Best, Mr. W. H.	5	0	0
Bolithos & Co. Messrs.	1	1	0
Care, Capt. H.	5	0	0
Care, Capt. W. H.	5	0	0
Chellew, Capt. J.	5	0	0
Cogar, Thomas	5	0	0
Coles, Rev. R. E.	10	0	0
Comley, Mr. J. J.	5	0	0
Cowley, Earl, K.G.	2	2	0
Docton and Sons	5	0	0

£.	s.	d.	
Gyles, Capt. William	5	0	
*Hain, Edw., & Son, Messrs.	10	6	
Hain, Capt. John	5	0	
Hain, Capt. R. P.	5	0	
Hamllyn, G. S.	5	0	
Harris, Mrs. Henry	10	0	
Harry, Capt. T. R.	5	0	
*Hodge, Capt. John	5	0	
Johns, Mr. W.	5	0	
Joll, Dr. B. B.	5	0	
*Jones, Rev. J. B.	10	6	
Morton, Capt. R.	5	0	
Permewan, Mr. R.	5	0	
Phillips, Capt. J. G.	5	0	
Reed, Sir Chas., M.P., the late	2	2	0
Richards, Mrs. G.	5	0	
Robartes, Lord (the late)	1	1	0
Rosewall, Mr. G. B.	5	0	
Rowe, Mr. James	5	0	
St. Aubyn, Sir John, Bart. M.P.	1	1	0
Staff, Dr.	5	0	
Stevens, Mr. D. F.	5	0	
Tremearne, Mrs. J. N.	10	0	
*Tresidder, Mr. W. T.	10	0	
Trehella, W.	5	0	
Tysacke, Rev. R. F.	10	0	
Vivian, A. Pendarves, Esq., M.P.	1	1	0
Wallis, Capt. S.	5	0	
Wasley, Mr.	5	0	
Williams, Mr. Geo.	5	0	
Sums under 5s.	3	1	0
Total	£23	0	6

Donation.

Messrs. Dillon, Harrowing, and Co.	2	2	0
Total	£25	2	6

SCILLY ISLANDS BRANCH.

President—

T. ALGERSON SMITH DORRIEN SMITH, Esq.

Chairman—

W. M. HOSKIN, Esq.

Honorary Secretary—
Mr. E. J. BLUETT.

Annual Subscriptions.

Smith, T. A. Smith	1	3	0
Dorrien, Esq.	1	3	0
Hayn House Hotel	5	0	0
Life-boat House and other Boxes, &c.	1	16	11
Total	£3	4	11

Cumberland.

CARLISLE AND SILLOTH BRANCH.

Chairman—

The MAYOR OF CARLISLE.

Honorary Secretary—
JOHN STROBACH, Esq.

Annual Subscriptions.

£.	s.	d.	
Blair, Mr. Thomas	10	0	0
Carlisle, The Very Rev. the Dean of.	1	1	0
Carr and Co. Messrs.	1	1	0
Committee, The Local, Silloth	10	6	0

	£	s.	d.
Creighton, R. Esq.	10	0	0
Elliott, R. Esq. M.D.	10	0	0
Ferguson, J. C. Esq.	10	0	0
Ferguson, Rt. Esq.			
M. P.	1	0	0
Harrison, Mrs. W.	1	0	0
Hope, Mrs. Joseph	10	0	0
James, Isaac, Esq.	10	0	0
Lawson, Sir W. Bart.			
M. P.	1	0	0
Little, Miss	10	0	0
Maxwell, Mr. Wm.	10	0	0
Page, W. B. Esq.	1	0	0
Redford, Rev. F. M. A.	10	6	
Standish, E. R. W. P.			
Esq.	1	1	0
Sutton, Wm. Esq.	10	0	0
Total	12	16	0

Donations.			
Contribution Pillar			
Box	18	3	
Contribution Box,			
Boat-house and			
other Boxes	2	8	5
Total Dons.	3	6	8
Total Subs.	12	16	0
	£16	2	8

MARYPORT BRANCH.

Chairman—			
H. P. SENHOUSE, Esq., J.P.			
Honorary Secretary—			
W. H. ECKERSLEY, Esq.			
Annual Subscriptions.			
A Friend, W. P. S.	5	0	0
Addison, John, Esq.	5	0	0
Brayton Coal Co.	1	1	6
Brown, Mrs.	10	0	0
Campbell, John, Esq.	10	0	0
Collin, P. de E. Esq.	10	0	0
Crosby Colliery Co.	1	1	0
Dickinson, J.	5	0	0
*Eckersley, W. H.	5	0	0
Graham & Co. Messrs.	10	0	0
Hewitson, Mrs.	10	0	0
Hine Bros. Messrs.	10	0	0
Kenyon, H. Esq.	10	0	0
*Mark, Jos. Esq.	10	0	0
Maryport Hematite			
Iron Co.	1	1	0
*Melmore, John	5	0	0
Pearson, Dr.	10	0	0
Penrice, Jas. Esq.	5	0	0
Ritson, Messrs. Robt.			
and Co.	1	1	0
Robinson, Jos. Esq.	10	0	0
*Senhouse, H. P. Esq.			
J.P.	1	1	0
Sewell, Mrs.	5	0	0
Solway Hematite Iron			
Co.	1	1	0
Tomlinson, J.	5	0	0
Tyson and Hobson, Messrs.	1	0	0
Wilson, Robert, Esq.	1	0	0
Wood, Mr. J. H.	5	0	0
*Wood, William Wilton, Esq.	5	0	0
Total	15	17	6

Donations.			
Excelsior Lodge of Odd Fellows, Maryport.	1	0	0
Box in H.M. Customs, Maryport	1	3	0
Do. in "Royal Oak" Inn	8	1	
Pillar Boxes	1	2	11
Other Boxes	5	0	0
Total	£19	16	6

WHITEHAVEN AND SEASCALE BRANCHES.

Chairman—
CAPT. MANN,
3 Hilton Terrace.

Honorary Secretaries—
W. J. TRYON, Esq.,
Whitehaven.
MR. J. MOLYNEUX, Seascale.

Collector—
MR. L. BORROWDALE,
16 Woodville Terrace.

Annual Subscriptions.			
	£	s.	d.
Lonsdale, The Right Hon. The Earl of	5	5	0
Adair, Mr. J.	5	0	0
Ainsworth, Mr. D.			
M. P.	10	6	
Ainsworth, Mr. J. S.	10	6	
Argrossan Steam Sulp Co.	1	0	0
Atkinson, Mr. H.	5	0	0
Atter, Mr. E.	10	6	
Bentnick, Right Hon. G. A. C. M.P.	1	1	0
BelfastRopeWorksCo. 1	1	1	0
Brackenbridge, T. & Co.	5	0	0
Bramwell, Dr.	2	2	0
Brockbank, Mr. Jas.	10	0	0
Brown, Mr. T.	10	0	0
Buckham, Mrs.	10	0	0
Burnyeat, Mr. W.	10	6	
Cameron, Mr. Peter. 1	1	0	0
Colebank, Captain	2	0	0
Collins, Mr. J.	5	0	0
Collis, Mr. Isaac.	10	0	0
Cousins, Mr. R.	5	0	0
Crossfield Iron Ore Co. 1	1	0	0
Davis, Mr. John.	5	0	0
Dees, Mr. James G.	10	0	0
Dickinson, Mr. J. N.	5	0	0
Dixon, Mr. T. C.	10	0	0
Feldtman & Co. Messrs. R.	1	1	0
Fisher, Mr. Charles. 1	1	0	0
Fletcher, Mr. H. A.	10	0	0
Fletcher, Mr. W.	5	0	0
Furness Railway Co. 2	2	0	0
Gibson, Mr. W. B.	5	0	0
Gordon, Mr. C. D.	5	0	0
*Helson, Mr. John S.	10	0	0
*Helder, Mr. A.	10	0	0
Hodgetts, Mr. A.	1	1	0
Hodgson, Capt. Isaac	5	0	0
Howson, Mr. Thos.	10	6	
*Huddart, Captain.	3	3	0
Hudson, Mr. T.	1	1	0
*Inanson, Dr.	10	0	0
Jackson, Mr. George	5	0	0
*Jackson, Mr. James	5	0	0
Jackson, Messrs. George & Co.	5	0	0
Jackson, Messrs. J. and W.	10	0	0
*Jacquea, Capt.	1	1	0
Jefferson, Messrs. R. and H.	1	0	0
Jenkins, Mr. John.	10	0	0
Johnson, the Misses 1	1	0	0
Leconfield, Lord.	1	1	0
Lindow, Messrs. S. & J.	2	2	0
Little, James & Co., Barrow (per Mr. E. Eddie)	1	0	0
Lumb, Mr. W. W.	10	0	0
Mackenzie, Mr. H. M. 1	1	0	0
McGowan, Messrs. J. A. & W.	5	0	0
Metcalf and Jackson, Messrs.	5	0	0
Moore & Co. Messrs.	10	0	0
Mossop, Mr. J. B.	5	0	0
Muncaster, Lord	5	0	0
Murray, Miss	5	0	0

Musgrave, Mr. John	1	0	0
Musgrave, Mr. J. R.	10	0	0
Nelson and Sons, Messrs. G.	5	0	0
Nicholson, Mr. J.	5	0	0
Nicholson, Mr. T.	5	0	0
*Pearson, Messrs. John and Son	5	0	0
Porter, Mr. J.	5	0	0
Postethwaite, Mr. J.	10	0	0
Postethwaite, Mr. M.	10	6	
Rigg & Co. Messrs. C. A.	5	0	0
Robinson, Mr. J. H. 1	1	0	0
Robinson, Mr. R. A.	10	0	0
Russell, Mr. John	5	0	0
Senhouse, Miss	10	0	0
Sparrow, Mr.	5	0	0
Spencer, Major	1	1	0
Sterling, Mr. John	2	2	0
Steward, Mr. A. B.	1	0	0
Thompson, Mr. A.	10	0	0
Thompson, Miss	1	1	0
Todd, Capt. s.s. South Western	5	0	0
Turner, Mr. W. B.	1	1	0
Vivian, Mr. John	5	0	0
Walker, Mrs. R.	1	1	0
Walker, Mr. Wm.	5	0	0
Watson, Rev. Mr., Bootle	1	1	0
Whiteside, Mr. H. J.	5	0	0
Whittle & Son, Messrs.	5	0	0
Wilson and Kitchin, Messrs.	10	0	0
Winder Iron Ore Co. 1	1	1	0
Whitehaven, Trustees of the Port of	10	0	0
Wordsworth, Rev. J.	10	0	0
Total	80	1	6

Donations.			
Boxes at Seascale Hotel and Boat-house.	1	15	5
Do. Custom House, Whitehaven	0	11	5
Collection Gosforth Church	3	0	0
Do. Seascale Church, per Rev. Mr. Wordsworth	2	5	7
Clarke, Capt. s.s. Henry Schofield.	5	0	0
Markham, Capt. s.s. Alne Holme	5	0	0
Scott, Rev. Dean	10	0	0
Sums under 5s.	4	4	6
Total Dons.	22	6	11
Total Subs.	80	1	6
	£102	8	5

WORKINGTON BRANCH.

Chairman—			
CHARLES J. VALENTINE, Esq.			
Honorary Secretary—			
J. C. THOMPSON, Esq.			
Annual Subscriptions.			
Alexander, Miss.	5	0	0
Barnett, Rev.	5	0	0
Bell, Capt. Thomas.	5	0	0
Bouch, the Misses	2	0	0
Broatch, J. A.	5	0	0
Clifton, Rev. C. W.	10	0	0
Cook, Miss.	5	0	0
Crosthwaite, Thomas	10	0	0
Dickinson, Wm., J.P.	10	0	0
Douglas, T. S.	10	0	0
Fisher and Sprott.	1	1	0
Gambles, John.	10	0	0
Hodges, Rev.	5	0	0

Hodgson, R. H.	10	0	0
Hodgson, D. L.	5	0	0
Hogg & McKerrow, Messrs.	5	0	0
Iredale Brothers.	1	0	0
Jackson, John	5	0	0
Jackson, Thos.	5	0	0
Jacques, Miss.	10	0	0
Jenkinson, Robt.	5	0	0
Litt, Miss	5	0	0
Milburn, John	10	0	0
Milburn, Tom.	10	0	0
Moordaff, Miss.	2	0	0
Moody, John	5	0	0
Murdy, William	1	0	0
Moss Bay Company, The	3	3	0
Musgrave, Robt.	5	0	0
Ormrod, F.	10	0	0
Paisley, Wm.	10	0	0
Patten, Capt.	10	0	0
Pelle, Alfred	10	0	0
Penrice, the Misses	5	0	0
Reed, Mrs.	5	0	0
Robinson, Capt. R.	5	0	0
Robinson, D. B.	1	1	0
Salters, M.	5	0	0
Saunders, G. F.	5	0	0
Scott, Mrs. Isaac	10	0	0
Scott, W. G.	5	0	0
Smart, James	5	0	0
Snelus, G. J.	5	0	0
Thompson, R. S., J.P.	10	0	0
Thompson, J. C.	10	0	0
Thompson, Miss, Elizabeth St.	5	0	0
Thompson, Wm.	5	0	0
Thompson, Wm., J.P.	5	0	0
Thompson, the Misses	10	0	0
Thornley, Rev. J. J.	5	0	0
Walker, Josh.	5	0	0
Wallace, J. R.	10	0	0
Walters, Mounsey	5	0	0
Warr, Lancelot	5	0	0
Wagh, Miss	5	0	0
Wilson, William	5	0	0
Sums under 5s.	6	9	6
Total	£34	9	6

Donations.			
Money in Boxes.	2	3	2
	£36	12	8

Benbighshire.

LLANDDULAS BRANCH.

Chairman—			
ANDREW DOYLE, Esq.			
Honorary Secretary—			
REV. J. DAVIES, M.A.			
Annual Subscriptions.			
	£	s.	d.
Davies, Rev. J.	1	0	0
Doyle, A. Esq.	2	0	0
Hesketh, R. B. Esq.	5	0	0
Kneeshaw & Co., Messrs.	5	0	0
Llanddulas Quarry Company	5	0	0
Total	£18	0	0

BRANCHES—LIST OF ANNUAL SUBSCRIPTIONS AND DONATIONS.

567

Derbysbire.

BELPER BRANCH.

Chairman—
H. LOMAS, Esq.

Treasurer—
W. WINTERBOURNE, Esq.

Honorary Secretary—
W. P. ADSHREAD, Esq.

Annual Subscriptions.

	£.	s.	d.
Adshread, Mr. W. P.	1	1	0
Adshread, Mrs. W. P.	10	6	
Adshread, Miss W. P.	10	6	
Adshread, Mr. G. H.	5	0	
Anthony, Mr. W. B.	10	6	
Bourne, Mrs.	1	1	0
Calvert, Mr.	5	0	
Friend, Rev. F. A.	5	0	
Hanson, Mr.	10	0	
Hogg, Mr. F.	5	0	
Hunter, Mr. J.	1	1	0
Lloyd, Rev. R. L.	10	0	
Lomas, Mr. H.	10	6	
Slater, Mr.	5	0	
Smedley Bros.	10	0	
Smedley, Mr. J.	10	0	
Stone, Mr. S.	5	0	
Tomlinson, Mr.	5	0	
Topham, Miss.	10	6	
Wheeldon, Messrs.	5	0	
Sums under 5s.	2	6	6
Collecting Boxes.	2	7	0
Total	£14	9	0

DERBY BRANCH.

Treasurer—

WILLIAM PEAT, Esq.

Honorary Secretary—
T. H. HARRISON, Esq.

Annual Subscriptions.

Abney, Rev. E. H.	1	1	0
Bailey, John, Esq.	1	1	0
Bakewell and Wilson, Messrs.	1	1	0
Bottomley, Geo. Esq.	10	6	
Cox, Samuel R. Esq.	1	1	0
Curzon, Hon. Mrs.	1	1	0
Curzon, N. C. Esq.	1	1	0
Evans, Henry, Esq.	1	1	0
Evans, Walter, Esq.	2	2	0
Gascoyne, Geo. Esq.	1	1	0
Harrison, T. H. Esq.	1	1	0
Holden, Rev. J. S.	1	1	0
King, J. F. Esq.	1	1	0
Leech & Neal, Messrs.	1	1	0
Moody, John, Esq.	10	6	
Morley, Francis, Esq.	2	2	0
Newbold, J. W. Esq.	10	6	
Newton, C. E. Esq.	1	1	0
Peach, Mrs. Edward.	2	2	0
Peat, Wm. Esq.	2	2	0
Peters & Co. Messrs.	1	1	0
Rensals, John, Esq.	1	1	0
Smith, John, Esq.	1	1	0
Schwind, Chas. Esq.	1	1	0
Swingler, Alfred, Esq.	1	1	0
Swingler, Henry, Esq.	1	1	0
Walters, Mrs.	1	1	0
Total	£30	19	6

Devonshire.

BARNSTABLE AND BRAUNTON BRANCH.

Vice-Patron—
The EARL FORTESCUE.

Chairman—
Rev. A. E. SEYMOUR.

Treasurer—
T. W. GUPPY, Esq.

Honorary Secretary—
Mr. H. C. GUPPY.

Annual Subscriptions.

	£.	s.	d.
Alford, Mr. Wm.	5	0	
Avery, W. Esq.	5	0	
*Basset, C. H. Esq.	10	0	
Basset, Rev. Francis	5	0	
Baylis, J. E. Esq.	5	0	
Benge, W. G. Esq.	5	0	
*Brady, Jas. Esq.	10	6	
*Brewer, J. Esq.	2	2	0
*Chanter, J. R. Esq.	5	0	
*Chichester, R. Esq.	10	0	
*Craig, John, Esq.	10	0	
Cranz, Miss	5	0	
*Crosse, R. J. Esq.	3	3	0
*Darracott, Mr. R. J.	5	0	
*Day, G. H. Esq.	5	0	
*Dennis, T. J. Esq.	10	0	
Dennis, Edw. Esq.	5	0	
Devolf, Rev. R. B.	5	0	
Downing, Miss.	10	0	
Edger, E. Esq.	5	0	
Fletcher, Miss.	5	0	
Fletcher, W. Esq.	1	1	0
*Fortescue, Rt. Hon. Earl	4	4	0
Gifford, J. B. Esq.	1	0	0
Gould, W. Esq.	10	0	
Gribble, the Misses	5	0	
*Guppy, T. W. Esq.	5	0	
Haggard, Rev. C.	10	6	
Hall, Rev. W. C.	5	0	
Haming, J. G. Esq.	10	0	
Harper, Jos. Esq.	10	0	
Heathcoat, Miss	10	0	
*Hiern, W. P. Esq.	1	0	0
Joce, Mrs.	5	0	
Lamping, Mr. Jas.	5	0	
Lang, Capt.	10	6	
*Law, A. J. Esq.	10	6	
Lock, Jas. Esq.	10	0	
Mackrell, T. Esq.	1	1	0
Marshall, J.P.S. Esq.	1	1	0
Marsh, Mrs.	10	0	
Martin, A. Esq.	10	6	
Martin, Mrs. W.	1	1	0
*Mock, E. Esq.	1	0	0
*Morcom, Rev. W. G.	5	0	
Munro, Mrs. C. A.	1	1	0
Nat. Prov. Bank of England	10	0	
Nott, Mrs.	1	0	0
Parminster, Mrs.	10	0	
Pick, J. P. Esq.	10	0	
Pinckney, G. H. Esq.	10	6	
Pinckney, Mrs.	10	6	
Pinkett, E. Esq.	1	0	0
Pitowsky, A. Esq.	5	0	
Quick, Mrs.	5	0	
Rafarel, W. C. Esq.	10	6	
Richards, John, Esq.	10	6	
Roberts, Rev. E.	5	0	
Robinson, J. D. Esq.	5	0	
Rossett, W. Esq.	10	6	
*Seymour, Rev. A. E.	1	6	
Sharland, Mrs.	5	0	
Skinner, Mr. Jno.	5	0	
*Smith, W. O. Esq.	10	6	
Smyth, Mr. John	5	0	
Smyth, John, Esq.	10	0	
Snow, Mr. J.	5	0	
Stout, Miss.	1	1	0
Tamlyn, J. Q. Esq.	10	6	
Tamlyn, P. H. Esq.	5	0	

Tatham, Mrs.	1	1	0
Toller, W. H. Esq.	10	0	
Vellacott, Mr. H.	5	0	
Webber, C. H. Esq.	5	0	
*White, Richard, Esq.	1	1	0
Wills, John, Esq.	5	0	
Wills, Miss.	5	0	
Sums under 5s.	1	19	0
Total	£47	17	6

Donations.

Griffiths, Miss	2	0	0
Pinckney, Mrs.	2	0	0
Moiety of Collections divided with Shipwrecked Mariners' Society, per Rev. A. E. Seymour	6	6	6
Rev. A. J. Bull	16	3	
Rev. Monseigneur Provost Brindie	1	0	9
Sums under 5s.	10	3	6
Total	£70	4	6

BIDEFORD AND APPLDORRE BRANCH.

Chairman—
E. U. VIDAL, Esq.

Honorary Secretary—
Rev. I. H. GOSSERT, M.A.

Assist.-Honorary Secretary—
Mr. W. NICOL.

Annual Subscriptions.

Ball, Mrs.	5	0	
Bazeley, H. M. Esq.	5	0	
Benson, Mrs.	1	0	0
Brooke, Mrs.	10	0	
Buckland, Rev. S.	5	0	
Chapple, W. Esq.	5	0	
*Charlewood, Admiral	1	0	0
Chichester, Mrs. E.H.	5	0	
*Churchward, Rev. M. D. Dimond	10	0	
*Cock, Mr. R. Esq.	5	0	
*Coffin, J. R. Pine, Esq.	1	0	0
Cohen, Dr.	5	0	
*Cooper, Mr. and Mrs. J. Groves	10	0	
Darracott, Mr. J.	5	0	
Davie, B. Esq.	5	0	
Dayman, A. Esq.	5	0	
Dayman, Miss.	5	0	
Didham, Capt. R.N.	5	0	
Donne, Mrs.	5	0	
*Dowell, Vice-Admiral, C.B.	10	0	
Drew, Miss	5	0	
Fierville, J. M. Esq.	5	0	
Fisher, G. Esq.	5	0	
Fraser, P. H. Esq.	5	0	
Glubb, Messrs.	5	0	
*Gordon, Capt.	1	0	0
*Gosset, Rev. I. H.	10	0	
Guille, Rev. G. de C.	1	1	0
Hake, Mr. G.	5	0	
Haverfield, T. W. Esq.	10	0	
Heathcoat, C. Esq.	5	0	
Hinchliff, Major C.H.	5	0	
Hole, C. W. Esq.	5	0	
Hole, Miss.	10	0	
Holland, S. Esq.	5	0	
How & Co. Messrs.	10	0	
Hutchinson, Gen.	10	0	
Hutchinson, Lt.-Col.	1	0	0
Inclodon, Miss.	5	0	
James, Boucher, Esq.	10	0	
Keir, J. L. Esq.	10	0	
Keir, Mrs.	5	0	
Kempe, Rev. J. C.	10	0	
Large, Miss	5	0	
Lawrence, Miss	5	0	
Lock, T. Esq.	5	0	

*Luxton, G. F. Esq.	5	0	
Macartney, Miss	10	0	
Macleod, Mrs.	5	0	
Mallett, Mr. H. L.	5	0	
Narraway, Mr.	5	0	
Peard, G. Esq.	5	0	
Pinkett, T. E. Esq.	5	0	
Portsmouth, Countess	1	0	0
Price, Cormell, Esq.	10	0	
Price, W. E. Esq.	5	0	
Prust, Mrs.	5	0	
Pyke, Mrs.	1	1	0
Pymsent, T. Esq.	10	0	
Remmett, Miss	5	0	
Reynolds, Miss	5	0	
*Reynolds, Rev. E.	5	0	
Rickard, Mrs.	5	0	
Rogers, Thos. Esq.	10	0	
Rooker, J. Esq.	5	0	
Rouse, E. Esq.	5	0	
Sanders, R. Esq.	1	1	0
Sawer, F. Esq.	10	0	
Smart, Miss	5	0	
Stapledon, W. Esq.	10	0	
Stevens, J. C. M. Esq.	1	0	0
Stucley, Sir G. Bart.	1	1	0
Suchiffe, Dr.	5	0	

Thursby, Lieut.-Col. R. H.	5	0	
Turner, G. Esq.	5	0	
*Vidal, E. U. Esq.	10	0	
Vidal, Mrs.	10	0	
Ward, Mr. W.	5	0	
Wheeler, Lt.-Col.	5	0	
White, Wm. Esq.	5	0	
Whyte, Capt. R. R.N.	5	0	
Whyte, R. Preston, Esq.	10	0	
Willet, Capt.	10	0	
Willet, Rev. C.	5	0	
Wilson, Messrs.	5	0	
Winterscale, Major	5	0	
Witto, 1880.	5	0	
*Wren, A. B. Esq.	10	0	
Wren, Capt. R. F.	5	0	
Sums under 5s.	16	5	6
Total	£52	4	6

Donations

Gloag, Mr. L. R.	1	1	0
Junior School, United Services College, Westward Ho! (fines)	10	0	
Box at Baths, Westward Ho!	5	0	
Box at Boat House	16	11	
Box at Post Office, Northam	5	1	0
Other Boxes	4	10	
Total Donations	£32	2	10
Total Subs.	£84	6	6

CLOVELLY BRANCH.

Chairman—
N. H. FANE, Esq.

Honorary Secretary—
Mr. JOHN BUMBY.

Annual Subscriptions.

*Berriman, Mr.	5	0	
*Bumby, Mr. J.	5	0	
Chandler, Rev. Mr.	5	0	
*Chichester, Rev. J. J.	5	0	
*Cooke, G. R. Esq.	1	0	0
*Fane, N. H. Esq.	2	2	0
Harris, John Mr.	5	0	
Raymond, Louis Roumieu	5	0	
Rees, David	5	0	
Stucley, Lieut.-Col.	1	0	0
Tucker, T. Pitts, Esq.	10	6	

	£.	s.	d.
Vine, Mrs. M. in memory of late Capt. Heard	5	0	0
*Whitefield, Mr. Edward	5	0	0
Total	6	17	6
Donations.			
Cooke, G. R. Esq.	1	1	0
Hewett, Sir Harald	1	0	0
Pollock, H. Esq.	10	0	0
Walker, Wm. Esq.	5	0	0
Watney, James Esq.	5	0	0
Sums under 5s.	1	11	0
Total Dons.	9	7	0
Total Subs.	6	17	6
	£16	4	6

DARTMOUTH BRANCH.

Chairman—
CHARLES CHALKER, Esq.

Honorary Secretary—
PERCY HOCKIN, Esq.

Annual Subscriptions.

Chalker, Mr.	10	0	
Crauford, Mr. R.	5	0	
Hurrell, Mr.	10	0	
Head, S. J.	5	0	
Hockin, Mr. Percy.	5	0	
Hockin, Mr. C. L.	5	0	
Rees, Mr.	5	0	
St. Aubyn, Rev. E. (2 years)	2	2	0
Tolman, Capt.	5	0	
Toms, Major (2 yrs.)	1	1	0
Total	5	13	0

Donations.

Browne, Rev. R.	5	0	
Hannaford, N. Esq.	5	0	
Contents of Life-boat Collecting Box on board H.M.S. Britannia	17	6	
Do. on board Conway Castle	1	1	0
Sums under 5s.	4	2	
Total Dons	2	12	8
Total Subs.	5	13	0
	£8	5	8

DAWLISH BRANCH.

Chairman—
SIR J. DUNTZE, BART.

Treasurers—
ALEX. McCASLAND, Esq.
C. H. TURNER, Esq. J.P.

Honorary Secretary—
J. B. PIKE, Esq.

Collector—
MR. DAVID PHELAN, R.N.

Annual Subscriptions.

Adams, Miss	5	0	
Bagshaw, Mrs. F.	10	0	
Brett, Capt. R.N.	10	6	
Brown, Mr. M. G.	10	6	
Collins, Miss	1	1	0
Cradge, Mrs.	1	1	0
*Duntze, Sir J., Bart.	1	0	0
Ermen, Mr. P.	10	0	
Ermen, Mr. G.	10	0	
Ferris, Mr. R.	10	6	
Ferris, Mr. W.	5	0	
Fortiscue, M. (Judge)	1	0	0

	£.	s.	d.
Grace, Mrs.	10	0	
Grace, Miss	10	0	
Hoare, Mr. P. M.	2	2	0
Holt, Mr.	5	0	
Hughes, Col.	10	6	
Jackson, Major	1	1	0
Lea, Mr. Thomas	5	5	0
Little, Mr. J. H.	5	0	
Manley, Rev. O.	5	0	
Marshall, Miss	5	0	
Maye, Mrs.	10	0	
Maye, Mr. Thos.	1	1	0
Mayne, Rev. Jas.	10	0	
*McCasland, Mr. A.	1	1	0
Moss, Mr.	10	6	
Nuthall, Mrs.	10	6	
Pennell, Mr.	5	0	
*Pike, Mr. John B.	10	0	
Pike, Mrs. W. J.	10	6	
Riach, Colonel	2	2	0
Savit, Lieut.-Col.	5	0	
Sneyd, Mr. Thos.	5	0	
Strickland, Miss	1	1	0
Sweete, Colonel	5	0	
Tebbit, Mr. W.	1	1	0
*Turner, Mr. C. H.	1	1	0
Ware, Mrs.	10	6	
Welsh, Mr.	10	0	
Weston, Mrs. P.	10	0	
Whiteborne, Mr. J. S.	10	0	
Whitelock, Lady	5	0	
Wiley, Mr. J. W.	10	0	
Total	32	16	0

Donations.

Douglas, Lady	1	1	0
Doxat, Lieut. R.N.	10	0	
*Macer, Mr. L. I.	5	0	
Marshall, Miss	5	0	
Millman, Mrs.	5	0	
Newell, Mrs.	5	0	
West, Mrs.	5	0	
Sums under 5s.	2	1	0
Pillar and Collecting Boxes	4	15	7
Total Dons.	9	12	7
Total Subs.	32	16	0
	£42	8	7

EXETER BRANCH.

President—
The Right Hon. the EARL OF DEVON.

Honorary Treasurers and Secretaries.
THOMAS B. GIBBS, Esq.
COURTENAY H. EDMONDS, Esq.

Annual Subscriptions.

Acland, Sir T. D.	1	1	0
Arden, Mrs.	1	1	0
Barnes, W. Esq. Jun.	1	1	0
Belfield, J. Esq.	1	1	0
Bond, Miss	5	0	
Boyd, Very Rev. Dn.	1	1	0
Brembridge, Miss.	1	1	0
Brice, Mrs.	5	0	
Bridges, Mrs.	1	1	0
Bullivant, J. Esq.	1	1	0
Cardew, Mrs.	5	0	
Cuthbertson, W. Esq., J.P.	5	0	
Churchill, Miss.	2	0	0
Dawson, Mrs.	5	0	
Dickens, Capt.	10	0	
Drake, Dr.	5	0	
Drake, Mr.	5	0	
Ellis, Rev. R.	5	0	
Evans, Miss.	2	6	0
Follett, J. C. Esq.	1	1	0
Gard, Mrs.	1	1	0
Geare, J. Esq.	5	0	
Gibbs, T. B. Esq.	10	0	
Gray, W. Esq.	5	0	
Green, E. Esq.	5	0	
Hooper, Smith, Esq.	5	0	

	£.	s.	d.
Hoskins, Rev.	5	0	
Huxham, C. Esq.	1	1	0
I'Anson, J. Esq.	10	0	
Kennaway, Miss A.	1	1	0
Lee, Canon	10	6	
Lloyd, H. Esq.	10	6	
Martyn, H. Esq.	10	0	
Mason, Browne, Esq.	5	0	
Mathews, Miss	5	0	
Milford, J. Esq.	1	0	
Milford, Miss	10	0	
Milne, Mr.	5	0	
Mortimer, Major	5	0	
Norman and Pring, Messrs.	1	0	0
Payne, Major	5	0	
Pengelly, Mr. J. J.	5	0	
Pinder and Tuckwell, Messrs.	5	0	
Sanders, R. Esq.	1	1	0
Segan, Mrs.	5	0	
Smith, Mrs.	5	0	
Snow, E. Esq.	10	6	
Tharpe, Mrs. T. R.	1	0	0
Thomas and Co., Messrs. J. L.	10	6	
Tremlett, Miss	1	0	0
Tucker, C. Esq.	5	0	
Tucker, J. S. Esq.	5	0	
Varwell, Mr.	5	0	
White, Vice-Admiral C.B.	1	1	0
Wilcocks, Weston, & Dinham	1	1	0
Williams, Mr.	5	0	
Wimble, Mrs.	1	0	0
Wilson & Son, Messrs.	5	0	
Wippell, Mr. C. J.	10	0	
Wippell, J. Esq.	5	0	
Total	37	18	6

EXMOUTH BRANCH.

Patroness—
The Right Hon. LADY ROLLE.

Chairman—
CHARLES PRETTIJOHN, Esq.

Honorary Secretary—
Capt. C. SQUIRE.

Collector—
MR. E. GARD.

Annual Subscriptions.

Abbott, Misses	10	0	
*Adams, H. C. Esq.	10	0	
Allen, G. T. Esq.	5	0	
*Bartlett, General.	10	0	
Bastin, Mrs.	5	0	
Baldcock, Mrs.	5	0	
Bazalgette, Col. C.	10	0	
Beaven, The Misses.	5	0	
Beleon, Mrs.	5	0	
Bevans, T. P. Esq.	10	0	
*Birch, C. Esq.	10	0	
Bligh, F. I. Esq.	10	0	
Boase, —, Esq.	10	0	
Brent, Miss	5	0	
Brent, Mrs. E.	10	6	
Browning, Mrs.	1	1	0
Bryce, J. P. Esq.	1	0	0
Bundock, The Misses	1	0	0
*Carr, Rev. C. R.	10	0	
Cazaly	5	0	
Campbell, Mrs.	5	0	
Chetwynd, Viscountess	10	0	
Chown, W. C.	5	0	
Cooke, Miss.	5	0	
Cookes, Major-Gen.	5	0	
Copleston, Miss	10	0	
Cordes, Mrs.	1	0	0
Claggett, Major.	10	0	
Cole, E. S. Esq.	1	0	0
Daniel, Major-Gen.	1	1	0
*Darke, A. J. Esq.	5	0	
Davies, W. C.	5	0	
Dawson, Miss	5	0	
Devon, The Earl of.	1	0	0

	£.	s.	d.
Drake, Lady Elliot	10	0	
D'Urban, Mrs.	10	0	
Dumbleton, H. Esq.	10	0	
Ensor, the Misses	5	0	
Ewen, A. B. Esq.	5	0	
Foster, G. Esq.	5	0	
Freeman, M. J. Esq.	10	0	
Freeman, Rev. R.	5	0	
*Fulford, J. D. Esq.	1	0	
Gordon, J. Esq.	1	1	0
Greatwood, Captain.	5	0	
Hall, Major	10	0	
Hamilton, A. K. Esq.	5	0	
Harborough, Countess of	10	0	
Hecks, H. P. Esq.	10	0	
Henderson, Admiral	5	0	
Hill, Miss	10	0	
Holman and Sons	2	0	0
Howard, Rev. W.W.	5	0	
Hussey, Col.	10	0	
Jameson, Miss F. R.	10	0	
Johnstone, Miss	5	0	
Landon, H.W.L. Esq.	10	0	
*Langley, John Esq.	5	0	
Leicester, Major	5	0	
Lee, Miss	10	0	
Long, Mrs.	10	6	
Macaulay, The Misses	5	0	
Malet, Rev. C. D.	5	2	
Neave, M. T. Esq.	5	0	
Patrick, the Misses.	5	0	
Pennel, Miss	10	0	
Perry, T. P. Esq.	1	0	0
Perkins, Dr. Steele	5	0	
Peters, W. H. Esq.	10	0	
Phear, Sir John	1	1	0
Prettijohn, General.	5	0	
*Prettijohn, C. Esq.	10	0	
Prettijohn, Mrs.	5	0	
Purrell, Rev. W.H.D.	5	0	
Pycroft, G. Esq.	10	0	
Pycroft, Mrs.	5	0	
Robert, Mrs.	5	0	
Robertson, Misses	5	0	
Rolle, Hon. Mark.	1	5	0
Ross, Mrs. R.	5	0	
Rundall, Gen.	5	0	
Shatlock, Rev. J. B.	5	0	
Shirreff, Dr. J. W.	10	0	
*Spettigue, J. Esq.	10	0	
*Squire, Capt.	5	0	
Trail, D. Esq.	5	0	
Trueman, C. R.	5	0	
Turnbull, G. W. Esq. M.D.	5	0	
Upton, Capt.	10	0	
Vangdon, G. C. Esq.	5	0	
Ward, Miss	5	0	
Ward, T. M. Esq.	5	0	
Walker, R.	5	0	
Webster, D.	1	0	0
Wood, J. Esq.	10	0	
Sums under 5s.	19	6	1
Total	£67	16	3

ILFRACOMBE AND MORTE BRANCH.

Chairman—
P. STONEHAM, Esq.

Honorary Secretary—
N. VYE, Esq. J.P.

Annual Subscriptions.

Adams, George Esq.	10	6	
Blandy, Mrs.	1	1	0
Butcher, L. G. Esq.	5	0	
*Corrie, Misses	1	1	0
Clay, Mrs. S.	5	0	

Collected in Lymington Church, per Rev. C. D. Malet. — 14 9
R. B. P. — 5 0
£68 16 0

BRANCHES—LIST OF ANNUAL SUBSCRIPTIONS AND DONATIONS.

	£.	s.	d.
Chanter, Rev. J. M.	—	5	0
Darbyshire, C. Esq.	—	10	6
Deacon, Mrs. Head			
(2 years)	1	0	0
Down, Mrs. J.	—	5	0
Foquet, H. R. Esq.	—	10	0
Faber, Mrs.	—	5	0
Gardner, F. Esq.	—	5	0
Hooper, Mrs.	—	10	0
*Hooper, Admiral J.	—	10	0
Hooper, Miss.	—	5	0
Hotel Co.	—	5	0
*Hicks, Cap. G. W.	—	5	0
Huxtable, Mr. R.	—	5	0
Huxtable, Mr. W.	—	5	0
Hillsborough, J. J. S.	—	10	0
Jenkinson, Misses	1	0	0
Leigh, General	—	10	0
Leman, Misses	—	10	0
Man, J. L. Esq.	—	10	0
Martin, Miss.	—	10	6
Mauder, Mrs.	—	5	0
*Maule, G. N. Esq.	1	1	0
Mello, Miss C.	2	0	0
Miligan and Co.	—	5	0
*Naish, J. G. Esq.	—	10	0
Prevost, Mrs. Anne			
Eleanor	1	1	0
Pemell, Jas. Esq.	—	5	0
Richardis, Mr. P.	—	5	0
*Stoneham, P. Esq.	1	1	0
Sopwith, Mrs.	—	10	0
Sale, D. Esq.	—	5	0
*Swain, Capt. R.N.	—	5	0
*Vye, N. Esq.	1	1	0
Wingrove, Mrs.	—	10	0
Wright, Rev. Harry	1	1	0
Wren, Miss	—	10	0
Welch, T. Esq.	—	5	0
Yelland, R. E. Esq.	—	10	0
Sums under 5s.	4	2	6
Total	27	11	0

<i>Donations.</i>			
Ark.	—	10	0
Bailey, Mrs.	—	10	6
Bright, H. Esq.	—	5	0
*Broughton, Lieut. C.D.I.	0	0	0
Chaito, W. J. P. Esq.	—	10	0
Cath, W. Esq.	—	10	0
Clapps, Mr. R.	—	5	0
Dickenson, C. H. Esq.	—	10	0
Foyster, Miss	—	10	0
Fox, Miss	—	5	0
H. J.	—	5	0
Holland, Mrs.	—	5	0
I. O. H. N. D.	—	5	0
J. W. M.	—	5	0
Leadman, W. Esq.	—	10	0
Lawrence & Davies	—	5	0
M. A. W.	—	10	0
Moody, J. C. Esq.	—	5	0
Nicholletts, Mrs.	—	5	0
Prout, S. G. Esq.	—	5	0
Robertson, E. B. Esq.	—	10	0
Speke, Wm. Esq.	1	0	0
Swaffield, Mrs. A.	—	5	0
Stephens, Admiral.	—	10	0
Teape, C. A. Esq.	—	5	0
Tors	—	10	0
Watson, Rev. T. H.	—	5	0
Wilcocks, B. E. g.	—	5	0
Wildersdale	—	6	0
Sums under 5s.	14	18	10
Winter Entertainments, per W.			
Huxtable, Esq.	5	0	0
Collected by Mrs.			
Groves	2	9	0
Pillar Boxes	20	2	4
Total Dons.	54	1	8
Total Subs.	27	11	0
£81	12	8	

LYNMOUTH BRANCH.

Honorary Secretary—
MR. JOHN CROOK.

Annual Subscriptions.

	£.	s.	d.
*Baker, Mr.	—	10	6
Bevan, Mr.	—	5	0
*Crook, Mr.	—	10	6
Edmonds, F. E. Esq.	—	10	6
*Halliday, W. H. Esq.	1	0	0
*Heywood, Mr.	—	10	6
Hockley, Rev. A. R.	—	5	0
Jones, Mr. T.	—	10	0
Kennett, E. Lean, Esq.	1	0	0
*Medway, Mr.	—	10	6
*Riddell, W. K. Esq.	—	10	0
Whitehead, Mrs.	1	1	0
Sums under 5s.	—	6	6
Total	7	11	0

Donations.

F. J.	—	10	0
Cochrane, Basil, Esq.	—	10	0
Lean, Mrs.	—	10	6
Palmer, H. Esq.	—	10	0
Contribution Boxes.	3	2	2
Total Dons.	14	12	8
Total Subs.	7	11	0
£22	3	8	

NEWTOWN ABBOT BRANCH.

Honorary Secretaries—
Major F. D. Bewes,
Mr. R. L. LLOYD.

Annual Subscriptions.

Armstrong, Dr. Leonard	—	5	0
Baker, R. H. M. Esq.	—	10	0
Bearne, Mr. J. S.	—	5	0
Bewes, Capt.	—	10	0
Bradnee, Mrs.	—	5	0
Cornish, Mrs.	—	5	0
Devon and Courtenay			
Clay Co.	1	1	0
Francis, Robt. Esq.	—	10	0
Harris, Rev. S. G.	—	5	0
Heyward, Mrs.	—	5	0
Rae, Lady	—	5	0
Rowland, Mrs.	—	5	0
Seraton, D. B. Esq.	1	0	0
Taylor, Gen. R. G.	1	0	0
Vicary, J. Esq.	—	5	0
Warner, Rev. G.			
Townsend	1	0	0
Watts, Blake, Bearne, and Co.	—	1	0
Sums under 5s.	5	17	6
Total	14	13	6

Donations.

Beachey, H. G. Esq.	—	10	0
Lifeboat Pillar Box	3	9	0
Rendall & Symonds	—	5	0
Sums under 5s.	2	7	0
Total Dons.	6	11	0
Total Subs.	14	13	6
£21	4	6	

PORT OF PLYMOUTH BRANCH.

Chairman—
ADMIRAL H. D. HICKLEY.

Treasurer—
JOHN STEVENS.

Honorary Secretary—
JAMES ROONEY.

Annual Subscriptions.

	£.	s.	d.
Adams, B.	—	5	0
Adams, Clark, and Linton	—	10	0
Allen, John	—	10	0
Artiss, Ward	—	5	0
Ash, A.	—	10	6
Barker, Nathaniel	—	5	0
Barrett, G. R.	—	10	0
Bastow, T. W.	—	10	6
Bennett, J. N.	—	5	0
Bewes, Rev. Thomas	1	1	0
Boger, Hext	—	10	0
Boolds, C. C.	—	10	0
Bourne, James	2	0	0
Braggs, Miss	1	0	0
British & Irish Sugar Refining Co.	—	10	6
Brown, H.	—	1	1
Brown, Wills, and Nicholson	—	10	0
Burnard, Lack & Alger	1	1	0
Butt, W. and Co.	—	5	0
Carpenter, Richard	—	5	0
Chubb, Mrs.	—	5	0
Clark, W.	—	10	6
Coates and Co., Distillery	—	1	1
Coles, S. J.	—	1	0
Collier Brothers	—	1	1
Crossing, J.	—	5	0
Crowther, A.	—	5	0
Cuddeford, T.	—	10	0
Curgenvon, Muford, and Kendall	—	10	0
Davies, Edward	—	10	0
*Derry and Co.	—	10	0
Devon and Cornwall Banking Co.	—	1	1
Dupre, John	—	5	0
Eads, John	—	5	0
Edgcombe, Mount, Earl of	—	1	1
Edmonds and Son	—	10	0
Elworthy, Curtis, and Dawe	—	10	0
Foale and Son	—	10	0
Fowler, Mrs.	—	1	0
*Fox, Elliot, and Co.	—	10	0
Fox, Sons, and Co.	—	10	0
Gard, E. O.	—	5	0
Gas Co., Plymouth	2	2	0
Gidley, G.	—	5	0
Goldfinch, Mrs.	—	5	0
Goldsmith, J. P.	—	10	0
Goulding, F. H.	—	10	0
Greaves, Rev. H. A.	—	5	0
Greenway, John	—	10	0
Hare, Hon. Colonel	—	10	0
Harvey, J. & T.	—	1	1
Haycroft and Pethick	—	10	0
Hearder and Son	—	5	0
Heywood, Henry	—	10	0
*Hickley, Adml. H.D.	1	0	0
Hicks and Co.	—	10	0
Hoare, Henry	—	5	0
Hodge, W. & Co.	1	0	0
Holmes, Mrs. A. E.	—	10	0
Hubbard, G.	—	10	0
Hurrell and Co.	—	5	0
Hyne, Simon	—	5	0
Jackman, William	—	5	0
James and Son, E.	2	2	0
James and Rosewall	—	10	0
James, J. S.	—	5	0
Joll, W.	—	10	0
Keen, Edmund	—	5	0
King, James	—	10	0
Lansdown, T. W.	—	10	0
Lethbridge, J.	—	5	0
Liscombe, R. L.	1	1	0
Lloyd, S. S.	—	1	1
Lott, Misses	—	10	0
Lowe, Admiral	—	1	1
Loye, P. and Co.	—	5	0
Luce, W.	—	10	0
*Margary, P. J.	—	1	0
Marshall, E.	—	5	0
Matthews, Henry	—	10	0
Matthews, J. W.	—	5	0
Maynard, H.	—	5	0
Melhuish, E.	—	5	0
Monk, J. E.	—	5	0
*Moore, James	—	1	1
*Morrish, F. A.	—	5	0
Morshead, Capt. R.N.			
per Rev. B. Mills	5	0	0
Mortimer, J. F.	—	5	0
Nathan, Jacob	—	1	9
Naval Bank	—	1	1
Newcombe, J. R.	—	10	0
Norrington, Charles, and Co.	—	1	1
Page, Keen, and Page	—	10	0
Parkhouse, S., and Sous	—	2	0
*Pearn, E. A.	—	5	0
Pearn, F.	—	1	1
Peek, W.	—	1	1
Penrose, E. A.	—	5	0
Pethick, J.	—	10	0
*Phillips, Capt.	—	10	0
Picken and Co.	—	10	0
Pitts, Son, and King	—	5	0
Polkington, Mrs.	—	5	0
Popham, Radford, & Co.	—	10	0
France, Dr.	—	1	0
Ralph, A.	—	5	0
Rendle, T. and Co.	—	5	0
Rew and Co.	—	10	0
Rolston, J., M.D.	—	5	0
Rolston, G. T.	—	5	0
Rooper, Miss	—	10	0
*Rooney, J.	—	10	0
*Roseveare, E.	—	10	6
Rowse, W.	—	10	0
Rundle, G.	—	5	0
Rundle, Rogers, and Brook	—	1	1
St. Aubyn, Sir J.	—	1	1
Saltash Corporation	—	1	1
Shaper and Co.	—	5	0
Shelly, John	—	5	0
Shilston, Wm.	—	5	0
Skardon, C.	—	5	0
Skardon, W.	—	5	0
Sparrow, B., and Co.	1	1	0
Spearman and Spearman	—	5	0
Spoooner and Co.	—	1	1
Stanbury, F. R.	—	5	0
Steadman and Co.	—	10	6
Stephens, Robert	—	10	0
*Stevens, John	—	1	1
*Stevens, Thos. Jones	1	1	0
Stidston, W.	—	5	0
Stoll, Mrs.	—	1	0
Stoneman & Square	—	5	0
Tanner, C. F.	—	1	0
Tanner, Mrs.	—	1	0
Treby and Co.	—	10	0
Tremayne, H. H.	—	5	0
Tyeth, T. B.	—	5	0
Usborne, Capt.	—	10	0
*Vosper, S.	—	5	0
Walters, C. H.	—	5	0
Watt, C.	—	5	0
Watt, R. J.	—	5	0
Watts, I.	—	5	0
Weary, J.	—	10	0
Webber, John	—	10	0
Western Counties Manure Co.	—	10	0
*Westlake and Son	—	5	0
*Whitty, Rev. T.	—	5	0
Whiteford, H.	—	5	0

	£.	s.	d.
Wilkinson, Rev. Dr.	10	0	0
Willoughby Brothers	10	6	
Wills, Son, and Box	10	0	
Wilson, Rev. C., M.A.	10	0	
Windeatt, J.	1	1	0
Windeatt, Miss.	10	0	
Sums under 5s.	15	0	
Total	94	13	0

Collecting Boxes, &c.

H.M.S. Cambridge	1	2	3
Browne's Victoria Hotel	14	11	
Chubb's Hotel	8	0	
Hoare's "Rose and Crown"	10	0	
Navy Hotel	7	5	
Ramsden's Criterion	5	11	
Royal Devonport	1	3	5
South Devon Railway	1	0	6
Thomas' Hotel, Devonport	10	8	
Small sums	5	0	9
Weeks, Phillips & Co.	11	3	10
Total Dons	94	13	0
Total Subs.	105	16	10

SALCOMBE & HOPE COVE BRANCH.

President—
The Right Hon. the EARL OF DEVON.

Chairman—
ROBERT HUBBELL, Esq.

Honorary Secretary—
W. H. WEBB, Esq.

Annual Subscriptions.

Balkwill, R. C. Esq.	1	0	0
Brown, Rev. Bevel.	10	0	
Cubitt, Wm. Esq.	5	0	0
*Devon, Right Hon. the Earl of	5	0	0
Douglas, Mr.	1	0	0
Earle, Rev. and Ven. Archdeacon	1	1	0
Earle, Miss.	10	6	
Foale, Mrs.	10	6	
*Hill, J. H. Esq.	10	6	
*Hurrell, John S. Esq.	1	1	0
*Hurrell, Robert, Esq.	1	1	0
Hurrell, Mrs.	1	1	0
Ilbert, Rev. P. A.	1	0	0
Kelly, Rev. Maicland	1	0	0
Netherton, R. L. Esq.	1	0	0
Seaton, J. Esq.	10	6	
Turner, Misses	1	1	0
Twysden, Capt. R.N.	1	1	0
Twysden, Rev. Thos.	1	0	0
*Webb, W. H. Esq.	10	6	
Contribution box, South Sands	19	0	
Total	£26	8	6

SIDMOUTH BRANCH.

Chairman—
The Rev. H. G. CLEMENTS, Vicar.

Honorary Secretary—
W. M. FLOYD, Esq.

Annual Subscriptions.

	£.	s.	d.
Balfour, E. Esq.	2	2	0
Barnard, F.	5	0	
*Bartelot, Capt.	10	0	
*Clements, Rev. H. G. J.	1	1	0
Comber, Miss	5	0	
Coulson, Bros.	10	0	
*Dunning, Messrs.	1	1	0
Fisher, Edward, Esq.	10	0	
*Floyd, W. M. Esq.	1	1	0
Gordon, Mrs.	1	1	0
Gore, Mrs.	5	0	
*Hine-Haycock, W. Esq.	1	1	0
Hooke, Mr. J. E.	5	0	
Kennett - Were, T. Esq.	10	0	
Kennett-Lawson, R. Esq.	10	0	
King, J. G. Esq.	10	0	
Majendie, W. Esq.	1	0	0
McArthur, Rev. C.	10	0	
Mathews, Mrs.	10	0	
May, Mrs.	1	1	0
Morshead, Rev. J. A.	1	1	0
*Pile, Mr. S. J.	5	0	
Potbury, Mr. J.	5	0	
Radiord, Dr.	10	0	
Radford, J. G. G. Esq.	10	0	
Redman, Mrs.	5	0	
Richards, Mrs.	5	0	
Richards, Mr.	5	0	
Robinson, Rev. J.	10	0	
Scott, George, Esq.	10	0	
Stokes, Dr.	10	0	
Thornton, Rev. R. T.	10	0	
Trump, William	5	0	
Warner, Miss	10	0	
*Webber, Mr. C. F.	5	0	
Willcock, Robt. Peel, Esq.	10	0	
Sums under 5s.	1	13	6
Total	22	17	6

Donations.

Addington, Major, the Hon. L. A.	5	0	
Barrow, Gen.	5	0	
Bird, R.	5	0	
Bradley, F. Esq.	10	0	
Denby, Mr.	5	0	
Douglas, Miss C.	1	0	0
Ede, H. Esq.	5	0	
Grundy, Thomas Esq.	5	0	
Heugb, John, Esq.	5	0	
Ingham, F. Esq.	10	0	
Martin, Miss.	10	0	
Popular Readings Committee	1	0	0
Sargant, Mrs.	10	0	
Taylor, R. Esq.	5	0	
Wade, Miss.	1	0	0
Walker, Major	5	0	
Sums under 5s.	19	0	
Total Dons	8	4	0
Total Subs.	22	17	6

£31 1 6

TEIGNMOUTH BRANCH.

President—
The Rt. Hon. LORD HALDON.

Chairman—
THOMAS FLAMANK, Esq.

Treasurer and Hon. Sec.—
J. W. BEATER Esq.

Annual Subscriptions.

	£.	s.	d.
Atkins, E.	5	0	
Arnold, B. A. Esq.	1	1	0
Barrows, Hill T. Esq.	10	0	
Barrows, Col.	10	0	
*Beater, John Mr.	5	0	
Beavan, J. G. Esq.	10	0	
J.P.	10	0	
Bergman, J. G. Esq.	10	0	
Betts, W. Esq.	5	0	
Blake, G. P. Esq.	10	0	
Bower, J. B. Esq.	10	0	
Brown, Lewis, Major, J.P.	10	0	
Burrowes, Hy., Esq.	1	0	0
Call, Mrs. G.	1	1	0
Carthright, Rev. A.	10	0	
Chandless, Mr.	1	1	0
Clayton, Mrs.	10	0	
Collings, Mr. C. H.	10	0	
*Cook, F. Esq.	10	0	
Dawson, C. A. Esq.	10	0	
Field, Mrs. O.	5	0	
*Flamank, Capt. T.	10	0	
Flamank, J. F.	5	0	
Fripp, Miss.	10	0	
Fry, Rev. James	10	0	
Guerin, Colonel	5	0	
Halford, Mrs.	5	0	
Holt, H.	5	0	
Huddleston, Mrs.	10	0	
*Hutchings, Mr. T.W.	10	0	
Hutchins, Rev. H.	10	0	
King, Miss.	5	0	
Ker-teman, J. S. Esq.	1	1	0
Keys, H. C.	10	0	
Langley, Miss.	1	1	0
*Lysaght, Mr.	10	0	
Mainwaring, General	10	0	
Marsh-Lynn, Mrs.	10	0	
Marsh.	10	0	
Ogle, Rev. W. R.	5	0	
Oliver, Mrs.	10	0	
Parson, Mrs.	10	0	
Preston Cook, F. O.	5	0	
Richards, Miss	10	0	
Robin, John, Esq.	5	0	
Roebuck, W. R.	10	0	
Rotherham, Mrs.	1	1	0
*Rudkin, G. W. A.	5	0	
Saunders, J. B. Esq.	10	0	
Simson, Graham, Mrs.	1	1	0
Smyth, Rev. T. R.	10	0	
Spencer, H. H. Esq.	10	0	
Stayner, Mrs.	5	0	
Stoulder, E.	5	0	
Teignmouth Harbour Commissioners	10	0	
Templer, R. W. Esq.	10	0	
*Ward, P.	10	0	
Whidborne, J. Esq.	1	1	0
Wood, C. H., Esq.	10	0	
*Wright, John, Esq.	10	0	
Young, Gen.	10	6	
Sums under 5s.	3	18	6
Total	44	2	0

Donations.

Kesteman, J. S. Esq.	1	1	0
Pillar and Life-Boat Station boxes, &c.	15	17	4
Total	£16	0	4

TORBAY BRANCH.

President—
The Rt. Hon. LORD CHESTER.

Honorary Secretary—
Rev. R. FENWICK ELLINGTON.

Annual Subscriptions.

	£.	s.	d.
Apletre, Mrs.	5	0	
Bartlett, Mr. O. H.	5	0	
Benbow, Mr. Vernon	5	0	
Berthon, Capt.	5	0	
Brown, Mr. J.	5	0	
Cook, Mrs.	10	0	
Douglass, Mrs.	5	0	
Eales, Miss	10	0	
Elrington, Rev. R. F.	5	0	
Freke, Mr. J. G.	10	0	
Gains, Mrs. G.	5	0	
Green, Mr. C.	5	0	
Goodfellow, Dr.	10	0	
Hall, M. S. T. G.	5	0	
Hogg, Mrs. Maxwell	10	0	
Hunt, Mr. G.	10	0	
Hunt, Mrs. G.	10	0	
Kendrick, Mr. W. G.	5	0	
Lakenan, Mr. T.	10	0	
Milford, Mrs.	10	0	
Norman, Capt. R.N.	10	0	
Patrick, Mr. W.	10	0	
Poland, Rev. F.	5	0	
Russell, Mrs.	10	0	
Smith, Mr. N.	5	0	
Tamier, Mr.	5	0	
Umacke, Capt.	10	0	
Sums under 5s.	3	12	0
Total	£13	12	0

TORQUAY BRANCH.

President—
The Rt. Hon. LORD HALDON.

Vice-President—
R. S. GARY, Esq.

Secretary and Collector—
Mr. R. G. COVE, of the Post Office. Residence: Clifton Villa.

Annual Subscriptions.

Adams, Mrs. J. (the late)	1	1	0
Adams, Miss.	1	1	0
Ainslie, W.	10	0	
Ainsworth, Miss	5	0	
Apthorp, Mrs.	5	0	
Auldjo, T. R.	1	1	0
Baillie, Mrs. Alex.	10	0	
Barkley, Edith	5	0	
Bernard, Mrs. H.	5	0	
Besley, the Misses	5	0	
Best, Mrs. N.	5	0	
Hevan, J. P.	10	0	
Black, Miss	5	0	
Bogle, Mrs.	10	0	
Boileau, Miss	5	0	
Bolingbroke, Miss	5	0	
Booth, Mrs.	1	0	0
Boudier, General E.W.	10	0	
Bovill, B.	10	0	
Borwick, G.	10	0	
Bowling, L. B.	5	0	
Baldwin, Miss.	5	0	
Brandt, Mrs.	5	0	
Bridson, Major T. R.	1	1	0
Bridges, W.	10	0	
Briggs, Mrs.	1	0	0
Brooman, Captain	10	0	
Brownlow, Colonel	10	0	
Burchard, O.	10	0	
Burdon, G.	2	0	0
Campbell, J. (Possil)	10	0	
Campbell, Mrs. A.	5	0	
Campbell, the Misses	5	0	
Carew, Mrs. J. D.	1	1	0
Duntz	1	1	0

BRANCHES—LIST OF ANNUAL SUBSCRIPTIONS AND DONATIONS. 571

£.	s.	d.	£.	s.	d.
Cartwright, the Misses	10	0	Lambert, Mrs.	10	0
Cary, R. S.	1	0	Latham, Mrs. R.	10	0
Cassaviti, J.	10	0	Latham, Mrs.	5	0
Casson, Rev. G.	5	0	Lavers, W.	10	0
Chadwick, W.	1	1	Lear, Thomas	2	6
Chapman, Rev. C.	1	1	Le Breton, Mrs.	5	0
Chatto, W. J. P.	1	0	Lee, J. E.	2	0
Clark, R. A.	1	1	Lillingstone, the Misses	15	0
Clarke, Rev. T.	10	0	Lloyd, Mrs.	1	0
Clifford, Colonel M.	5	0	Louax, Mrs. R. E.	5	0
Coates, Dr.	5	0	Lombe, Dr. and Mrs.	10	0
Cobb, J. F.	10	0	Louis, Mrs.	5	0
Croker, E. J.	1	0	Lushington, Colonel	5	0
Coggan, Miss.	1	0	Macdougall, Lt.-Col.	5	0
Cole, R.	1	0	Macgregor, Sir G. and Lady	10	0
Cole, Miss	10	0	Maconchy, George	10	0
Collet, C.	10	0	Madden, Dr. W. H.	1	1
Colthurst, Colonel	10	0	Maddison, Miss	10	0
Countess, Miss	5	0	Manning, Capt. G.	10	0
Coventry, Miss	10	0	Martyn, Mrs.	10	0
Coulson, F. R.	5	0	McGrath, Rev. Canon	5	0
Cubitt, The Rt. Hon. Geo.	10	0	Meade, Spencer	5	0
Dale, Mrs.	5	0	Medley, Capt.	10	0
Davis, Rev. W. B.	5	0	Midgley, Miss	5	0
Daw, W. B.	10	6	Mills, Robert F.	10	0
Dawson, Rev. J.	5	0	Mills, Mrs.	10	0
De Lisle, A.	10	0	Mitchell, Mrs.	5	0
De Mierre, Mrs.	10	0	Muller, Miss	10	0
Dunston, A. C.	5	0	Myers, Mrs.	1	1
Dennistown, the Misses	5	0	Ordfield, Mr.	5	0
Diggle, J.	10	0	Pammel, C. L.	10	0
Draie, Mrs.	10	0	Parker, W.	5	0
Drinkwater, P. B.	1	1	Parker, C. E.	1	1
Durham, J. S. W.	5	0	Patteson, Miss	10	0
E. T.	5	0	Peacock, Miss	5	0
Earle, Miss	1	1	Perkins, Capt. R.N.	1	1
Edmonstone, G.	1	1	Perks, R.	5	0
Edmonstone, Miss.	5	0	Perrens, W. K.	10	0
Edwards, Rev. Evan	5	0	Petty, George	10	0
Egerton, P.	5	0	Phillips, Capt. Leigh	5	0
Erskine, Dowager Lady	1	1	Phillips, the Misses	1	0
Everard, Miss	5	0	Porter, L.	5	0
Fielder, Miss	5	0	Prater, Rev. T.	10	6
Fisher, J.	5	0	Prince, Rev. E. B.	5	0
Forbes, Maj.-Gen.	5	0	Proctor, W.	5	0
Fox, F. H.	5	0	Pulford, A.	5	0
Gamble, Mrs. Henry	2	2	Purton, Miss	5	0
Gamble, Miss	10	0	Rainbeaux, A.	5	0
Gaston, Mrs.	10	0	Rawdon, Mrs.	2	0
Gibbons, the Misses	5	0	Ray, Mrs. Brisco	10	0
Gibson, Mrs.	10	0	Reid, Dr.	5	0
Gilbert, G. R.	5	0	Remfry, G. F.	10	0
Glossop, Colonel	1	1	Rich, Mrs. General	5	0
Goodfellow, General	5	0	Ridley, Colonel	10	0
Gooch, Miss	10	0	King, Mrs.	5	0
Gosse, P. H.	10	0	Robertson, Mrs. F.R.	10	0
Gould, Miss	10	0	Robertson, Mrs.	1	0
Grant, the Misses	5	0	Robinson, Mrs. B.	5	0
Gregor, Miss	1	1	Russall, J. H.	5	0
Grosvenor, Mrs.	10	0	Rowe, H.	10	0
Harvey, W.	5	0	Sanders, Mrs.	5	0
Hewett, Rev. J.	10	0	Schuster, Mrs.	1	0
Hagart, Mrs. Colonel	10	0	Self, Rev. W. H.	5	0
Haig, G. A.	1	0	Sheppard, Mrs.	10	0
Haliburton, Mrs.	5	0	Skeffington, the Hon. Mrs.	5	0
Hames, Mrs.	5	0	Smith, Major-General	10	0
Hamlyn, J.	10	0	Smithwick, Rev. W. J. (the late)	2	0
Hanbury, Sampson	1	1	Smithwick, Miss (the late)	1	1
Hannay, R.	5	0	Smyth, F. C.	10	0
Harvey, Mrs.	1	0	Soltan, John F.	10	0
Heath, Dr.	5	0	Southill, W. H.	5	0
Hood, Lady	5	0	Spatt, W. F.	1	0
Hugonin, Mrs.	1	0	Squire, Capt.	10	0
Huxley, J. U.	10	6	St George, Mrs.	1	1
im Thurn, Mrs.	5	0	Stanley, Mrs.	5	0
Ingham, Mrs.	5	0	Stayner, F. H.	10	0
Jamieson, Rev. J. Audry	5	0			
Jamieson, Mrs.	5	0	Stephenson, P.	5	0
Jervoise, S. C. Clarke	1	1	Stewart, N. B.	1	0
Johnston, James	5	0	Stone-treet, F.	1	0
Jolly, C. W.	10	0	Sutherland, the Duchess of	1	0
Kinder, J. W.	5	0	Swinburne, Capt.	1	1
Kinnear, Mrs. G.	5	0	Taylor, C. W.	1	0
Kinnoull, The Countess	10	0			
Kitchener, Captain	10	0	Thompson, Mrs.	1	0
Kitson, John	5	0	Thomson, Dr. S.	5	0
Kitson, William	10	0	Tinney, Mrs.	10	0
			Tomlinson, Rev. J.P.	1	0

Trevor, Miss E. F.	5	0
Tucker, Capt. F.	5	0
Turnbull, Miss	10	0
Unwin, Major-Gen.	5	0
Unwin, Mrs. H.	5	0
Walker, Mrs. R.	5	0
Walker, Miss	10	0
Ward, Mrs.	5	0
Warneford, Dr. C. F.	5	0
Warrington, Miss	1	0
Waymouth, Captain	5	0
Webster, James	5	0
Whidborne, the Misses	10	0
Whiteway and Ball	10	0
Wilks, Dr.	1	1
Wilton, C. F.	1	0
Woodhouse, W. S.	10	0
Wylie, J. L.	1	0
Total	£127	13 0

Donations.

Bright, J.	10	0
Campbell, A. N.	5	0
Drew, R. W.	5	0
Fox, D. M.	5	0
Hay, Cunningham, Mrs.	5	0
Hughes, Mrs.	10	0
Lloyd, Mrs. and Miss	10	0
Snecgrove, Mrs.	10	0
Vere, J.	5	0
Box at All Saints, Babbicombe	15	9
Do. Imperial Hotel	17	9
Do. Boat House	13	6
Do. Pillar Box	5	4
Sums under 6s.	1	17 0
Total Dons.	7	14 4
Total Subs.	127	13 0
	£135	7 4

WESTERN COUNTIES CENTRAL BRANCH.

President—
The Right Hon. the EARL OF DEVON.

Honorary Treasurer—
THOMAS B. GIBBS, Esq.

Annual Subscriptions.

Barnard, Admiral	1	1	0
Bere, Mrs. Sen.	1	1	0
Knight, Rev.	1	1	0
Low, Miss	5	0	0
Neumann, G. Esq.	1	0	0
Simcoe, Capt., R.N.	2	2	0
Total	6	10	0

Donations.

English, J. T. Esq.	5	0
Florence, Miss	3	0
Knight, H. Esq.	5	0
Sharpe, J. Esq.	5	0
Contribution boxes on G. W. R.	5	13 6
Ditto on L. & S. W. Railway	4	11 5
Ditto on Somerset & Dorset Railway	4	10 1
Ditto on South Devon Railway	7	8 3
Ditto on Great Eastern Railway	2	14 9
Ditto Bodega, London, per Messrs. Lavery & Co.	2	8 0
Ditto, per Mr. Davis, 'London Tavern,' Mark Lane	3	7 8
The Shades, per Mr. Abbott	11	9

G.W. Hotel, Deunbigh	13	0
Clarence Hotel	4	0
P.O. Crediton	1	1
Pillar boxes	14	12 4
Total Dons	50	10 10
Total Subs.	6	10 0
	£57	0 10

Contributions in aid of Walton-on-Naze Life-boat Fund.

Pillar Contribution box	4	5 10
Contribution boxes at Albion Brooks', and Post Office	6	9
Ditto Marine Hotel	4	4
Ditto Queen's Head Hotel	4	0
Total	£5	0 11

CITY OF TRURO, per Mr. J. Reynolds.

Annual Subscriptions.

Box at All Saints, Babbicombe	15	9
Do. Imperial Hotel	17	9
Do. Boat House	13	6
Do. Pillar Box	5	4
Sums under 6s.	1	17 0
Total	2	5 6

Donations.

The Right Rev. The Lord Bishop	1	1 0
E. G. Spry, Esq.	1	10 0
Total Dons	2	11 0
Total Subs.	2	5 6
	£4	16 6

YEALM RIVER BRANCH.

Hon. Secretary—
MICHAEL WILLIAMS, Esq.

Annual Subscriptions.

*Baring, Edward C.	1	1 0
*Bastard, Baldwin J. P.	1	1 0
*Collinsplatt, Hawtreyl	0	0
*Collinsplatt, Henry	1	1 0
*Cory, Richard	1	1 0
Cory, Mrs.	1	1 0
*Dawson, Ralph	1	1 0
Dawson, Mrs.	1	1 0
Hicks, Col., C. B.	1	0 0
Hicks, Miss	1	0 0
Holberton, T. & V.	1	1 0
*Laine, Rev. Richard	1	1 0
Midnigh, H. B.	1	1 0
Roe, Rev. Henry F.	1	1 0
Williams, Michael	1	1 0
Total	£15	12 0

Dorsetshire.

BRIDPORT DISTRICT BRANCH.

President—
THOMAS COLFOX, Esq.
Secretary and Collector—
Mr. H. GOOD.

Annual Subscriptions.

£.	s.	d.
Beach, Thomas,....	10	0
Chick, W. H.....	5	0
*Colfox, T.....	1	0
Colfox, W.....	1	0
Cox, E.....	10	0
Crocker & Son, W.....	5	0
Edmunds, T. H. & C.....	10	0
Good, F.....	5	0
Gundry, F. W.....	5	0
Gundry, J. P. F.....	1	0
Hounsell, H. E. (Lim.).....	5	0
Hounsell, J.....	5	0
Hounsell, R.....	5	0
Hounsell, T.....	10	0
Hounsell, W.....	10	0
Howell, H.....	5	0
Knight, W.....	5	0
Legg, Job.....	10	0
Manley, W. H.....	5	0
Rendall & Coombs.....	5	0
Sutill, J. P.....	5	0
Tucker, Francis.....	5	0
Tucker, Harry.....	5	0
Waldron, Capt.....	5	0
Wansley, Miss.....	5	0
Collecting Box.....	2	2
Sums under 5s.....	2	6
Total.....	£10	4 8

ISLE OF PURBECK BRANCH.

President—
THE EARL OF ELDON.

Vice-President—
Lieut.-Col. MANSSEL.

Honorary Secretary—
GEORGE H. BOND, Esq.

Annual Subscriptions.

*Earl of Eldon.....	15	0
Banques, Albert, Esq. 1 0 0	1	0
*Banques, Rev. Canon 1 0 0	1	0
Bennett, S. Esq.....	10	0
Best, Mr. J. B. C.....	5	0
Bond, George, H. Esq. 1 0 0	1	0
*Bond, Nath. Esq.....	10	0
Bond, Rev. Canon 1 0 0	1	0
Bond, Thos. Esq.....	10	0
Browne, Rev. Wm. C.....	10	0
Cann, Mr. R.....	5	0
Colson, Mr.....	5	0
Cust, Mr.....	5	0
Daniel, Woodruffe, Esq.....	10	0
Digby, G. Wingfield, Esq.....	2	2
Drew, Mr. J. S.....	5	0
Farrer, Mrs.....	1	0
Fittler, F. Esq.....	1	0
Fyler, J. Esq.....	1	0
Hoare, Mrs. C. R.....	1	0
Hooper, Mr. R.....	10	0
Hutchings, R. C. Esq.....	10	0
Jackson, Miss.....	1	0
Johnson, Mr. J.....	10	0
Kent, Mr. J.....	5	0
Lester, Rev. Lester 1 0 0	1	0
*Mansel, Lieut.-Col. 1 0 0	1	0
*Mansel, Rev. O. L. 1 0 0	1	0
Marshall, Mr. R. J.....	10	0
Marshall, Mr. F.....	10	0
Oakley, Mr.....	5	0
Panton, J. Esq.....	10	6

£.	s.	d.
Pearce, Rev. T.....	2	2
Pike, W. J. Esq.....	1	0
Randall, Mr. I.....	5	0
Rodgett, Mrs.....	2	0
Selby, Mr. C.....	10	0
Serrell, Mrs.....	1	0
Stilwell, H. Esq.....	10	0
Trenchard, Mr. F.....	7	6
Willshire, Mr.....	5	0
Total.....	45	8 0

Donations.

Col. the Lord E. G.	5	0
Cecil, M. P.....	5	0
The Rev. S. W. Nash.....	5	0
Mrs. Serrell's Sunday Classes.....	3	0
Collected by Miss Ricketts, Grange School.....	10	0
Rev. T. Seavill.....	5	0
Collected by E. G. Mansel, Esq., 62nd Regt.....	7	0
Collecting Box, Kimeridge.....	5	0
Collected by Mr. Syms, small sums.....	12	6
Collected by Miss Hunt.....	1	10
Small Sums.....	1	0
Total Dons.....	12	14 6
Total Subs.....	45	8 0
Total.....	£58	2 6

LYME REGIS BRANCH.

Chairman—
WILLIAM HINGESTON, Esq.
Honorary Secretary—
Mr. H. MILLER.

Annual Subscriptions.

Ames, E. L. Esq.....	1	0
Andr-ws, A.....	5	0
*Brandram, Lt.-Col. 1 0 0	1	0
Bullen, Capt. R. N.....	10	0
Chalmers, A. J. Esq.....	5	0
Hayward, Miss.....	10	0
Henley, Miss.....	10	0
*Hingeston, Wm. Esq. 1 0 0	1	0
Homan, E.....	10	0
Ingram, H. F. Esq. 1 0 0	1	0
Landon, Mrs.....	5	0
Lean, Mrs.....	10	0
Lewin, Lieut.-Col. 1 0 0	1	0
Lister, Mr.....	10	0
Marsh, Isaac, Esq.....	5	0
Matthey, C.....	5	0
*Newall, G. F. Esq.....	5	0
Palgrave, Mr.....	5	0
Peek, Rev. Edward.....	1	0
*Preston, I. W. Esq.....	10	0
Radford and Radford Shore, Mrs.....	5	0
Smith, Rev. J.....	5	0
Symons, Mrs.....	10	0
*Tucker, Henry, Esq.....	10	0
Vizard, Mrs. H. B.....	1	0
Walls, Mrs. W. D.....	5	0
Waring, Mrs.....	5	0
Williams, R. & R. and Co.....	1	1
Wrey, Mrs.....	10	0
Sums under 5s.....	5	0
Total.....	16	8 0

Donations.

Ames, E. L. Esq.....	10	0
Hussey, Mrs.....	5	0
Leathes, the Misses Stanger.....	7	6
Munro, Capt.....	10	0

£.	s.	d.
Powell Family, The 3 3 0	3	3
Skinner, D. S.....	5	0
Visitor to Lyme.....	5	0
Sums under 5s.....	1	7
Pillar and other collecting boxes.....	6	8
Total Dons.....	13	1 2
Total Subs.....	16	8 0
Total.....	£29	9 2

POOLE AND BOURNEMOUTH BRANCH.

Patron—
The Right Hon. the Earl of Shaftesbury, K.G.

President—
The Right Hon. Lord WIMBORNE.

Chairman—
Rev. J. A. LAWSON.

Honorary Secretary and Treasurer—

G. BRAXTON ALDRIDGE, Esq.

Annual Subscriptions.

*Aldridge, G. B. Esq.....	5	0
Alington, Lord.....	1	0
*Belben, G. Esq.....	10	6
Belben, T. Esq.....	10	6
Blisset, Rev. G.....	10	0
Budge, P. E. L. Esq.....	5	0
Cavell, Rev. H. T.....	10	0
*Colquhoun, Sir Jas., Bart.....	2	0
Cox, T. Esq.....	1	0
Damer, Rev. L. Dawson.....	1	0
Davey, Horace, Esq. M. P.....	1	0
Digby, G. D. W. Esq. 2 10 0	2	10
Glyn, Sir R. G. Bart. 2 0 0	2	0
Glyn, Rev. C. J.....	10	0
*Grey, Admiral.....	10	0
*Godwin, Jas. P. Esq. 1 0 0	1	0
Jennings, Reginald.....	10	0
Kemp, Rev. A.....	1	0
Kemp, Miss.....	1	0
Kettle, Miss.....	10	0
Lang, Major.....	10	0
*Lawson, Rev. J. A.....	5	0
McWilliam, J. Esq.....	10	0
*Mercedith, H. Esq.....	5	0
Norton, J. J. Esq.....	10	6
Ouslow, Rev. C.....	10	6
*Phelps, Miss.....	10	0
Portman, Hon. W. H. B.....	1	0
Schreiber, C. Esq., M. P.....	2	2
Shaftesbury, Earl of, K.G.....	5	0
Sladen, Rev. E. H. M.....	10	6
Stockton, Mrs.....	10	0
*Sullivan, Admiral Sir B. J., K.C.B.....	1	0
Waterman, W. Esq.....	5	0
*Welch, M. Kemp, Esq.....	10	6
West, Miss.....	10	0
Wimborne, Lord.....	2	2
Wood, M. Esq.....	5	0
Young, C. E. Baring, Esq.....	1	1
Total.....	35	2 0

Donations.

Congregational Chpl. 2 2 0	2	2
Sums under 5s.....	5	1
Pillar Box, Bourne-mouth Pier.....	4	18
Do. Arcade.....	6	15
Total.....	£49	3 3

SWANAGE BRANCH.

President—
G. BURT, Esq.
Treasurer—
G. C. DE LA MORTE, Esq.

Honorary Secretary—
Mr. H. J. HIXSON.

Annual Subscriptions.

£.	s.	d.
Burt, G. Esq.....	2	2
Colson, Miss.....	5	0
Crawford, Dr.....	1	0
Digby, Capt., M. P.....	1	0
Docura, Thos. Esq.....	10	0
Marsh, Mr. S.....	5	0
Randall, Mrs.....	10	0
Robinson, J. C. Esq. 2 2 0	2	2
Seavill, Rev.....	5	0
Serrell, Mrs., and her Sunday School Scholars.....	3	0
Travers, Rev. R. D.....	10	0
Wilde, S. Esq.....	3	0
Wilde, Miss.....	2	0
Total.....	16	10 0

Donations.

B. A. A.....	10	0
F. T. C.....	5	0
J. C. B.....	5	0
R. H.....	5	0
Overy, Rev. P. T.....	10	6
Pollock, Baron.....	10	0
Other Sums.....	14	6
Pillar Box & Collected at Royal Victoria Hotel... 1 9 10	1	9
Proceeds of Concert... 9 12 9	9	12
Total Dons.....	14	2 7
Total Subs.....	16	10 0
Total.....	£30	12 7

WEYMOUTH BRANCH.

Patron—
The Right Hon. the EARL OF STRAFFORD.

President—
The Right Hon. LORD ASHLEY.

Honorary Secretary—
G. H. PRICE, Esq.

Annual Subscriptions.

Baunton and Sons Messrs.....	5	0
Bayley, E. Esq. J. P.....	1	1
Chimmo, Capt.....	10	6
Church, Mrs. J.....	5	0
Devenish and Co. Messrs. J. A.....	10	6
Eliot & Co. Messrs.....	1	0
*Eliot, George, Esq.....	10	6
Erskine, Miss.....	5	0
*Evans, Capt. R. N., Inspecting Com-mander.....	1	1
Gooden, H. C. Esq. J. P.....	10	0
Groves, T. B. Esq.....	5	0
Groves, J. Esq.....	5	0
*Haune, T. A.....	5	0
Hodges, J. F. Esq.....	10	6
*Hooper, Pelly, Esq., Town Clerk.....	5	0
Hopkins, B. Esq.....	10	6
*Howard, R. N. Esq., Mayor.....	5	0
Lynes, Rev. J.....	5	0
Moorhead, Dr.....	10	0
Penny, Colonel.....	5	0
*Phelps, Capt.....	1	0

BRANCHES—LIST OF ANNUAL SUBSCRIPTIONS AND DONATIONS. 573

Pigon, Rev. H. C.	10	0	0
*Pretor, Capt.	5	0	0
Roberts, W. and Co.	7	6	0
Saunders, Mr. C.	5	0	0
Sewell, Hy. Esq., R.N.	10	6	0
*Stapson, R. P. Esq.	5	0	0
Smith, Dr. M.D.	10	0	0
*Speake, Hugh, Esq.	5	0	0
Thompson, S. Esq.	10	0	0
*Tizard, Dr.	5	0	0
Walsford, G. B. Esq.	5	0	0
Williams, Messrs R. and H. and Co.	1	1	0
Total	£15	4	6

Donations.

Aquila s.s., Capt. Painter	8	17	1
Brighton s.s., Capt. Falle	14	0	4
Causey & Co.'s steam- boats	1	4	8
Great Western s.s., Capt. E. S. Blamp- ied	1	2	6
South of Ireland s.s., Capt. Pearn	2	4	7
Pillar Box	3	4	3
Total Dons.	30	13	5
Total Subs.	15	4	6
£45	17	11	

Durham.

**HARTLEPOOL
BRANCH.**

Honorary Secretary— S. HERBERT BELK, Esq.			
Assistant Secretary— ALFRED BELK.			
<i>Annual Subscriptions.</i>			
*Burdon, Rev. J.	3	0	0
Hartlepool Port and Harbour Commis- sioners	5	5	0
Total	8	5	0

Donations.

Voluntary contribu- tions from ship- ping	45	19	5
£54	4	5	

SEAHAM BRANCH.

President— The MARQUESS OF LONDON- DERRY.			
Chairman— Rev. A. BETHUNE.			
Honorary Secretary— WILLIAM WARHAM.			
<i>Annual Subscriptions.</i>			
*Londonderry, The Marquess of	3	3	0
*Bethune, Rev. A.	10	6	0
Brough, Mrs. T.	10	0	0
Brydon, R. Esq.	5	0	0
Childish, R. Esq.	10	0	0
Chilton, Thos. Esq.	5	0	0
Clazey, J. O. Esq.	5	0	0

Colling, Rev. J.	5	0	0
Corbett, V. W. Esq.	5	0	0
Ditchfield, S. J. Esq.	5	0	0
*Elliot, Thos. Esq.	5	0	0
*Eminson, J. B. Esq.	10	6	0
Lough, W. Esq.	5	0	0
Mann, Major.	10	6	0
North Hetton Coal Company	2	2	0
Pallister, W. Esq.	10	6	0
Scott, Rev. W. A.	5	0	0
*Sheridan, W. Esq.	10	0	0
Smith, T. & W. Messrs. 1 The South Hetton Coal Company	2	2	0
Thorman, Robt. Esq.	10	6	0
Turnbull, T. S. & Co.	5	0	0
Warham, William	5	0	0
Woods & Co. Messrs. 1 Wright, H. B. Esq.	1	1	0
Young, Ehlers, & Co. Messrs.	2	2	0
Collecting Box	4	6	0
Collected from ships. 7 Total	7	1	0
£26	4	0	

**SEATON CAREW
BRANCH.**

Chairman— M. PRAESE, Esq.			
Treasurer— JOHN BAKWELL, Esq.			
Honorary Secretary— Rev. JOHN LAWSON, M.A.			
<i>Annual Subscriptions.</i>			
Eldon, The Earl of. 5 Backhouse, A. Esq. 1 Backhouse, E. Esq. (the late)	5	0	0
Backhouse, Edmund, Esq.	2	2	0
*Bakewell, John, Esq. 1 Barclay, Mrs.	1	1	0
Boyne, Viscount.	3	3	0
*Clarke, George, Esq. 1 Date, David, Esq.	1	1	0
Dalton, Rev. C. W.	1	1	0
Dalton, Miss.	2	2	0
Fawcus, Henry, Esq. 2 Fawcus, R. S. Esq. 1 *Garbutt, E. W. Esq. 1 Herskind, F. Esq.	2	2	0
Hodgkins, J. B. Esq. 1 *Hudson, T. S. Esq. 1 Ingilby, Lady Am- cotts.	1	1	0
Lawson, Professor. 1 *Lawson, Rev. John 2 Longbotham, J. Esq. 1 Lucas, Albert, Esq.	1	2	0
McIntire, Rev. T.	1	1	0
Michell, John J. Esq. 1 *Mounsey, E. B. Esq. 1 *Pearse, M. Esq.	1	1	0
Reay, Thomas M. Esq.	1	1	0
Rogers, Rev.	1	1	0
*Surtees, W. E. Esq. 2 *Swanson, W. Esq.	2	2	0
*Tilly, Harry T. Esq. 1 Tone, Miss.	1	1	0
Vivian, Mrs.	1	1	0
Total	45	16	0

Donation.

Allison, William	10	0	0
Barometer Pillar	1	7	0
Life-boat House Box	7	3	0
Total	£46	14	10

**SUNDERLAND AND
WHITBURN
BRANCH.**

Chairman—
ALDERMAN REED.
Treasurer and
Honorary Secretary—
J. C. PORRETT, Esq.
Hon. Sec. at Whitburn,
W. H. WILLIAMSON, Esq.

Annual Subscriptions.

Alderson, C. Esq.	10	0	0
Allison, J. J. and W. H. Messrs.	1	0	0
Allison, Robt. Esq.	10	0	0
Anderson, T. Esq.	1	0	0
Armstrong, Addison & Co. Messrs.	1	0	0
*Austin, S. P. & Son, Messrs.	1	1	0
Backhouse and Co., Messrs.	1	1	0
Barnes, T. Esq.	3	0	0
Bartram & Haswell, Messrs.	10	6	0
*Barwick, I. S. Esq. 4 Blain, Thomas Esq.	9	0	0
Blumer & Co. Messrs. 5 Booth, George R. Esq.	10	0	0
Bramwell and Co., Messrs.	1	1	0
Brantingham, P. T. Esq.	10	0	0
Briggs, Wm. & Sons, Messrs.	10	0	0
Christal, J. and Sons, Messrs.	10	0	0
Clarke, George Esq. 1 Cockin, Rev. Canon.	1	1	0
Craven and Speeding, Messrs.	1	0	0
Crosby, Thos. Esq.	10	6	0
Croze, John, Esq. per N. P. Bank Sunder- land Branch.	1	1	0
Culliford, J. H. W. Esq.	10	6	0
Davison, R. G. Esq.	5	0	0
Dickenson, J. Esq.	10	0	0
Dixon and Wilson, Messrs.	1	1	0
Durham, Right Hon. Earl of.	2	2	0
Elder, Wm. Esq.	5	0	0
Elliot, Thomas, and Son, Messrs.	10	0	0
Fairley, T. W. and C. Messrs.	7	6	0
Fairman, J. C. Esq.	5	0	0
Featherstonhaugh, A. W. and E., Messrs.	10	0	0
Fenwick, Arthur, Esq. 2 Forster, John, Esq.	1	0	0
Gayner, R. H. Esq.	1	1	0
Gowland, G. H. Esq.	10	6	0
Graham, John, Esq.	10	0	0
Graham, Henry, Esq.	5	0	0
Greives, J. W. Esq.	5	0	0
Grimshaw and Sons, Messrs.	10	0	0
Harrison Brothers	5	0	0
Harrison, T. E. Esq. 1 Harrison, W. B. Esq.	10	0	0
Hartley, James, Esq. 1 Hill, J. G. Esq.	10	0	0
Hills, James, Esq.	5	0	0
Hills, John, Esq.	5	0	0
Hills, W. H. Esq.	5	0	0
Hitchcock, Rev. Canon W. M.	2	2	0
Hodgson, Mrs.	10	0	0
*Horan, James, Esq.	10	0	0
Hudson, R. & Sons, Messrs.	10	0	0
Keyll, J. J. Esq.	10	6	0
Kish, Thos. Esq.	10	6	0
Laing, James, Esq.	1	1	0

Lambton and Co., Messrs.	1	1	0
*Lilburn, Chas. Esq.	10	6	0
Lumsdon, Byers, and Co. Messrs.	1	1	0
Meier, C. W. and Co. Messrs.	5	0	0
Modlin, T. Esq.	5	0	0
Morton, H. T. Esq.	10	6	0
Newbiggin, E. J. Esq.	5	0	0
Oliver, R. Esq.	10	0	0
*Peckot, G. C. Esq.	5	0	0
Pemberton, R. L. Esq. 1 Pinky, D. G. and Sons, Messrs.	1	1	0
*Porrett, R. B. Esq. 1 Potts, J. Jun. Esq.	1	1	0
Potts, R. H. & Bros. Messrs.	1	0	0
Reay, T. J. Esq.	5	0	0
*Reed, Alderman.	1	1	0
Richardson, S. Esq.	10	0	0
Ritson, Henry, Esq.	5	0	0
Ritson, John & Sons, Messrs.	10	0	0
Robinson, G. H. Esq.	5	0	0
Robson, E. C. & Son, Messrs.	10	0	0
Robson, W. W. and Sons, Messrs.	5	0	0
Rutter, R. P. W. Esq.	5	0	0
Service and Phillips, Messrs.	5	0	0
Shadforth, Robt. Esq. 1 Sheraton, Richd. Esq.	0	5	0
Smith, Alexander, Esq.	10	0	0
*St. John, Wm. Esq.	10	6	0
Steel, Thomas, Esq.	5	0	0
Stobart, William, Esq.	10	0	0
*Taylor & Sanderson, Messrs.	10	0	0
*Thompson, Alder- man William	10	0	0
Thompson, J. and H. H. & Co. Messrs.	10	0	0
Thompson, John, Esq.	5	0	0
Thompson & Wright- son, Messrs.	10	0	0
Tone, William, Esq.	10	0	0
Tinkler, Wm. Esq.	5	0	0
Tyzack & Branfoot. 1 Vaux, C. and Sons, Messrs.	0	5	0
Watson, George, Esq.	10	0	0
*Wayman, J. W. Esq.	10	6	0
Wiener, Martin, Esq. 1 Williamson, Sir H., Bart.	1	1	0
*Williamson, W. H. Esq.	2	0	0
Wilson, C. Stanley, Esq.	10	6	0
Wilson, C. Esq.	10	6	0
Woods & Co. Messrs. 1 Woodcock, Mrs., In- terest on the legacy of the late.	1	1	0
Total	£77	18	0

Sundry Donations,
per H.M. Customs 96 11 4
Collecting Boxes 4 14 7

£179 3 11

**WEST HARTLEPOOL
BRANCH.**

Chairman— W. UPWARD, Esq., H.M.C.			
Honorary Secretary— C. A. BAKER, Esq.			
<i>Annual Subscriptions.</i>			
*Appleby, Thos. Esq. 1 Cory, Lobden & Co. 2 East Coast Insurance Co.	1	1	0
F. F.	2	2	0
Farmer, A. Esq.	1	1	0
Fryer, E. Esq.	5	0	0

	£.	s.	d.
*Gray, W. & Co. Messrs.	2	0	0
*Groves, Maclean & Co. Messrs.	1	1	0
Harsley, Geo. and Co. Messrs.	-	10	6
Herskind, F. Esq.	-	10	6
*Irvine, R. & Co. Messrs.	2	2	0
Lauder, R. & Co. Messrs.	-	10	6
Lister, Beaumont, & Co. Messrs.	-	5	0
Lane, Chas. S. Esq.	-	10	6
Middleton and Co. Messrs.	1	1	0
Pease, Joseph and Partners, Messrs.	1	1	0
*Pyman, G. and Co. Messrs.	2	2	0
Merryweather, Jos. and Co. Messrs.	-	10	0
Roe, W. Esq.	1	1	0
Robinson, T. Esq.	-	10	6
Turnbull, E. Esq.	1	0	0
Wilkinson, T. H. Esq.	-	5	0
*Young, W. J. Esq.	2	2	0

Total£24 6 0

Donations.			
Cunningham, J. Esq. per C. A. B.	1	0	0
Sundry donations per H.M. Customs.	19	14	6
Voluntary Tolls collected at the Dock Office	45	6	0

£30 6 6

ESSEX.

ESSEX AND COLCHESTER BRANCH.

President— G. H. ERRINGTON, Esq., High Steward of Colchester.
Chairman— Mr. Alderman J. BAWTREE HARVEY.
Vice-President— Major BISHOP.
Treasurer— JOHN BAWTREE, Esq.
Hon. Secretary—

Annual Subscriptions.
1880.

	£.	s.	d.
Balderston, Miss	1	1	0
Bannatyne, Rev. C.	1	0	0
Bawtree, John, Esq.	1	1	0
Bishop, Major	1	1	0
Carlingford, Rt. Hon. Lord	2	0	0
Causton, R. K. Esq., M.P.	1	1	0
Errington, G. H. Esq.	1	0	0
"Essex Standard"	-	10	6
"Essex Telegraph"	-	10	6
Freeland, Mrs.	1	1	0
Harvey, J. Bawtree, Esq.	1	1	0
Hanson, Mrs. G.	1	1	0
Luard, Admiral, C.B.	1	1	0
Round, Mrs. Chas. G.	1	1	0
Round, Mrs. Geo.	1	0	0
Willis, W. Esq., Q.C., M.P.	1	1	0

16 12 0

Donations.			
Bannatyne, Rev. C.	2	0	0
Bawtree, John, Esq.	2	2	0
Bawtree, Mrs.	1	1	0
Errington, G. H. Esq.	5	6	0
Luard, Admiral, C.B.	2	2	0
Morrill, Mrs.	1	0	0
Wright, Miss Starley	-	10	6

Total Dons.....14 0 6
Total Subs.....16 12 0
£30 12 6

GLACTON-ON-SEA BRANCH.

President— Rev. HENRY LAW.
Chairman— JAMES HARMAN, Esq.
Honorary Secretary— WILLIAM W. TOWSE, Esq.

Annual Subscriptions.			
Agate, Wm.	-	10	6
Ager, George	-	10	6
Albans, St. Lord Bishop of	1	1	0
Allen, —	1	1	0
Andrews, —	-	5	0
Atwood, George	1	1	0
*Baker, W. S.	-	5	0
Bawtree, Octavius	1	1	0
*Boys, John	2	2	0
Chambers, George	-	10	6
Chapman, James	-	10	6
Cox, Mr.	-	10	6
Ellis, James	-	10	6
Farnell, Capt.	1	1	0
Fowler, J. T.	-	10	6
Garnham, F.	1	1	0
Green, Rev. W.	-	5	0
Green, Robt.	-	5	0
*Harman, James	1	1	0
Harman & Mathews	-	10	6
Hayes, T. D.	-	10	6
Hudson, Matthews, and Co.	3	3	0
Jackson, W. P.	-	10	6
Kitching, F. Esq.	1	1	0
*Law, Rev. Henry	2	2	0
Law, Mrs.	1	1	0
Lavir, Dr.	1	1	0
*M'Bride, Rev.	1	1	0
Main, Wm.	-	10	6
*Mann, F.	-	10	6
Mitchell, James	-	10	6
Newman, Rev. D.D.	1	1	0
Nichols, F. M. Esq.	-	1	0
J.P.	1	1	0
Nunn, F. J.	-	5	0
Osborne, A. T.	-	10	6
*Page, Henry James	1	1	0
Penfold, Abell	-	10	6
Phillips, —	-	2	6
Piggott, Rev.	-	10	0
Poston, C.	1	1	0
Reynolds, and Co.	-	10	6
Richardson, —	-	10	6
Round, James, Esq., M.P.	1	1	0
Rutherford, W.	-	5	0
Salmon, Robt.	-	10	0
Salmon, Wm.	1	1	0
*Sizer, J. H.	-	12	0
Sm. th, I.	-	10	0
Smith, John	-	10	6
South and Giale.	1	1	0
Tabrum and Jones	-	10	6
Topp, Jas.	-	10	6
Towse, W. B.	1	1	0
*Towse, W. W.	1	1	0
Trigg, Miss.	-	10	0
Vincent, W. T.	-	5	0
Wells and Co.	1	1	0
Wallis, Frederick	1	1	0

Total.....45 3 0

Donations.			
Bilborough, —, Esq.	1	1	0
Fomess, —, Esq.	1	1	0
Proceeds of Concert.	16	2	9
Do. Royal Hotel and other Boxes	6	9	6

Total Dons.....24 14 3
Total Subs.....45 3 0
£69 17 3

HARWICH BRANCH.

President— EDGAR WALTER GARLAND, Esq., High Steward of the Borough of Harwich.
Chairman— J. R. FRANKS, Esq.
Honorary Secretary— S. EVANS, Esq., L.R.C.P. (Lond.)

Annual Subscriptions.			
*Barnes, R. S. Esq.	-	10	0
Bevan, Mr. C. F.	-	10	0
*Brady, H.	-	1	0
Burmester, Rev. G. and Family	1	10	0
Carlingford, Lord	2	0	0
Cottingham, F.	-	10	0
Eley, Chas. Esq.	1	0	0
Evans, Mrs.	-	10	0
*Evans, S. Esq.	-	10	0
*Franks, J. R.	-	10	0
Garland, E. W. Esq.	10	0	0
*Groom, W. Esq.	-	10	0
Grice, Mr. J.	-	10	0
Hammond, Misses	-	10	0
Jackson, G. L.	-	2	6
Marsden, Canon	1	1	0
*Murray, Mr. W.	-	10	0
Nalborough, W. J.	-	10	0
Nichols, F. M. Esq.	2	0	0
Patrick and Son, Messrs.	1	1	0
Tyler, Sir Henry	1	0	0
*Yaux, J. H. Esq.	-	10	0
*Watts, John, Esq.	-	10	0
Worts, Mr. A.	-	10	0

Total£27 14 6

Donations.			
Contribution Box at boathouse	7	7	9
Do. on board G. E. R. steamers, per Capt. Howard	2	8	10
Sundry Boxes	-	9	5

Total Dons.....10 6 0
Total Subs.....27 14 6
£38 0 6

SOUTHEND BRANCH.

Chairman— Rev. F. THACKERAY.			
Honorary Secretary— JAMES RICHMOND, Esq.			
Annual Subscriptions.			
*Beard, Mr.	-	10	0
Bell, Miss L.	-	10	6
*Bligh, Mr.	1	0	0
Brightwell, Mr. I. R.	1	1	0
Browne, Rev. R. C.	-	5	0
Davies, Miss	-	5	0
Deeping, Mr. G. D.	-	10	6
*Dettmar, Mr.	-	10	0
Dettmar, Miss	-	5	0

Dettmar, Miss May	-	5	0
*Dowsett, Mr.	-	10	0
Fache, Mr. Chas J.	-	10	0
*Gregson, Mr. W.	-	10	6
Lancaster, Mr. J. L.	1	1	0
Merritt, Mr. W. D.	-	10	6
Merritt, Mrs. W. D.	-	10	6
*Richmond, Mr.	-	10	0
Smith, Mr. T.	-	10	6
Swaine, Mrs. G.	-	10	0
*Thackeray, Rev. F.	1	1	0
Verral, Mr.	-	10	0
*Waters, Samuel	2	0	0
Webster, Mr. W.	-	10	6
Withers, Mr.	1	1	0
Wood, Mr. F.	1	1	0
*Woodsman, Mr.	-	10	6

Total 16 19 0

Donations.			
All Saints' Church, Lent Offertory	3	8	8
Meggy, Mrs.	-	5	0
Priory Masonic Lodge	10	0	0
Contribution Boxes	4	11	7

£35 4 3

flintshire.

RHYL BRANCH.

President— R. BAMPFORD HESKETH, Esq.			
Chairman— T. GRIFFIES DIXON, Esq.			
Treasurers— NORTH AND SOUTH WALES BANK.			
Honorary Secretary— Mr. ROBERT HUGHES.			
Annual Subscriptions.			
Buddicom, W. B. Esq.	2	0	0
*Butterton, Rev. G. A., D.D.	-	10	0
Churton, John, Esq.	-	10	0
*Conwy, Major Conwy Rowley	-	5	0
*Dixon, T. Griffies, Esq.	2	2	0
Fuller, Mrs.	1	1	0
George, Oliver, Esq.	1	1	0
Gladstone, Rev. S. E.	1	0	0
*Hesketh, R. Bamford, Esq.	-	5	0
Hughes, H. R. Esq., Kimmel	-	5	0
*Johnson, G. Esq.	-	5	0
Jones, Mrs. E. Olinda	2	2	0
*Jones, W. Price, Esq.	-	10	6
Jones, Mrs. Price	-	10	6
Mainwaring, T. Esq.	5	0	0
*Morgan, Edwin, Esq.	-	10	0
Mountfield, W. B. Esq.	-	10	6
Penn, Major	-	10	6
Pennant, P. P. Esq.	1	0	0
*Richardson, Rev. T. M.A.	-	10	0
Roberts, J. Esq. M.P.	1	1	0
Roberts, R. Price, Esq. the late	2	2	0
*Sisson, R. J. Esq.	1	1	0
Sneyd, Miss, 1880-1.	2	0	0
St. Asaph, Dean of	1	0	0
Wilkin, W. Esq.	1	1	0
Winston, Thos. Esq.	1	1	0
Wynn, Mrs. Wms.	1	1	0

Total.....45 0 0

BRANCHES—LIST OF ANNUAL SUBSCRIPTIONS AND DONATIONS. 575

	£.	s.	d.
<i>Donations.</i>			
Churton, John, Esq.	2	0	0
<i>Boxes—</i>			
Alexandra Hotel	5	5	
Barometer Box	12	4	
Belvoir Hotel	1	7	5
Dudley Hotel	7	9	
Mona Hotel	10	1	
Mostyn Hotel	11	1	
Parade Pillar Box	4	17	0
<i>Pier Refreshment</i>			
Rooms	8	7	
Queen's Hotel	18	10	
<i>Railway Refreshment</i>			
Rooms, Rhyl	13	4	
Ditto Rugby	2	17	9
Royal Hotel	1	19	5
Steamer Queen	13	0	
Sun Inn	11	3	
Westminster Hotel	1	5	11
Sums under 5s.	19	3	
Total Dons.	20	18	5
Total Subs.	45	0	0
	£65	18	5

Glamorganshire.

CARDIFF AND PENARTH BRANCH.

Patron—
C. R. M. TALBOT, Esq. M.P.
Chairman—
Colonel E. S. HILL.
Treasurer—
JAS. EDWARDS, Esq.
Penarth.
Honorary Secretary—
Commander W. M. FEN-
GELLY, H.M.'s late Indian
Navy.

Subscriptions for 1881.

	£.	s.	d.
Aberdare Coal Co.	10	6	
Adams, Mr. G. F.	10	0	
Adams, Wilson, and Co.	5	0	
Alexanders & Co.	1	0	
Andrews, Mr. S.	10	6	
Anning, Mr. J. H.	10	0	
Baker, T. and Son.	10	6	
Barnes, Guthrie & Co.	10	6	
Bewick, Mr. Geo.	10	6	
*Bland & Co., Messrs. J.	1	0	
*Bovey, John and Co. Messrs.	10	6	
Brown, Mr. Forster.	5	0	
Burness, Jas. & Sons	1	0	
Bute, Marquis of	10	0	
Byers, Dr.	5	0	
Capper, Mr. E. H.	10	6	
Clive, Lady Mary Windsor	1	0	
Coedcae Coal Co.	10	6	
Cloake, Capt. H.	5	0	
Coffin and Co.	1	0	
Cornwell, Mr. D.	10	6	
Cory Bros. and Co.	1	0	
Cory, J. and Sons.	10	0	
Davies, David, & Co.	1	0	
Davis, David, & Sons	1	0	
Decandia, Mr. S.	5	0	
Duncan, Mr. R.	5	0	
Edwards, Mr. FK.	10	0	
Elliott, J. and Son, Messrs.	10	0	
Fothergill, Mr. H.	5	0	
Frazier and Co.	10	0	
Fry, Mr. John	10	0	
*Fry, Mr. W. J. B.	10	0	
Gaskell, Mr. W. G.	10	6	

	£.	s.	d.
Gibbs, Mr. Peter	10	0	
Glamorgan Coal Co.	1	0	
Greenhill, Mr. F. R.	10	0	
Guere, L. & H. Messrs.	10	0	
Hacquell Bros.	10	6	
Harrison Bros. and Moore, Messrs.	10	6	
*Hill, C. and Son, Messrs.	1	0	
Hodge & Hill, Messrs.	5	0	
Hollier, Mr. H.	10	6	
Hollyer & Co. Messrs.	10	0	
Insole, G. and Sons, Messrs.	1	0	
Jacobs, Mr. C. M.	10	6	
Jessen, Mrs. G. N.	5	0	
Johnson, Mr. S. N.	5	0	
Jones, Mr. Edward O.	5	0	
Jones, E. & Co.	5	0	
Jones, Heard, and Ingram, Messrs.	10	6	
Jones, Mrs. W. G.	5	0	
Jotham, D. and Son, Messrs.	5	0	
Krieger, Mr.	5	0	
Lee, Mr. R.	5	0	
Lucovich, Mr. A. T.	1	0	
Martin & Marquand, Messrs.	5	0	
Marychurch, J. & Co.	1	0	
Matthews, D.	5	0	
Morel Bros. & Co. Messrs.	10	6	
Nell, Dr. R. F.	10	6	
Nixon, Mr. Thos.	5	3	
Nixon, Taylor, and Cory, Messrs.	1	0	
Page & Co., Messrs.	1	0	
Parry Bros., Messrs.	5	0	
Penn, Cooper and Edward	5	0	
Plain, Mr. T.	10	6	
Powell, Duffryn & Co. Messrs.	1	0	
Price, W. and Sons, Messrs.	5	0	
Pyman, Watson, and Co. Messrs.	10	0	
Rees, D.	5	0	
Richards, Mr. D.	5	0	
*Riley, Mr. W.	2	0	
Ronnefeldt, Mr. W.	5	0	
Rous, The Misses.	1	0	
Rundle, Mr. C. O.	1	0	
Short and Dunn, Messrs.	10	0	
Spiller & Co. Messrs.	1	0	
Stallybrass, Balmer, and Co.	10	0	
Stephens, Mr. T. H.	10	6	
Stowe, Mr. G. S.	5	0	
Strong, W. & R. H., Messrs.	1	0	
Tapson, Mr.	5	0	
Tellefsen, Wills and Co. Messrs.	1	0	
Thomas and Griffiths, Messrs.	5	0	
Thomas, Mr. A. R.	10	6	
Thomas, Mr. W.	5	0	
Thompson, Mr. T. R.	5	0	
Thomson, Mr. A.	5	0	
Todd, Mr. R. R.	5	0	
Troedyrhew Coal Co.	10	6	
Turnbull, Bros.	10	6	
*Vellacott, Mr. H.	5	0	
Webb, Mr. T.	5	0	
Williams, Mr. T. J.	5	0	
Wilson, Mr. J. H.	10	6	
Windsor, Lord	2	0	
Worms and Josse, Messrs.	1	0	
*Young, C. O. & Christie, Messrs.	1	0	
Sums under 5s.	7	6	
Total	67	1	0

Donations.

Strina, Mr. M.	5	0	
X. Y. Z.	5	0	

	£.	s.	d.
<i>Boxes:—</i>			
Worms & Josse	3	14	2
Custom House	2	14	5
Williams, T. J.	16	5	
Lucovich, A. T.	6	0	
Spiller and Co.	5	0	
Eagle Brewery	5	0	
Penarth Hotel	6	11	
Life-boat House	1	1	4
Boxes under 5s.	4	11	
Total Dons.	10	4	2
Total Subs.	67	1	0
	£77	5	2

PORHCRAWL BRANCH.

Patron—
C. R. M. TALBOT, Esq. M.P.
President—
*J. C. NICHOLL, Esq.
Honorary Secretary—
Rev. W. JONES.
Annual Subscriptions.
*Brogden, James, Esq.

Bute, Marquis of	5	0	0
Byass & Co., Messrs.	2	2	0
R. B.	2	2	0
Carne, J. W. Stradling, Esq., D.C.L.	1	0	0
Clark, G. T. Esq.	1	0	0
David, Edward, Esq.	10	0	0
*David, Evan, Esq.	10	6	0
Davis, Wm. Esq.	1	0	0
Dunraven, Earl.	5	0	0
Dyke, T. J. Esq.	10	6	0
Edmondson, Rev. Thos.	10	6	0
Fothergill, Miss	2	0	0
Gibbon, J. S. Esq.	1	0	0
Gwyn, Howel, Esq.	1	0	0
Halkett, Mrs.	10	0	0
Honfray, J. R. Esq.	1	0	0
Jenkins, Mrs. Blandy	1	0	0
Jones, J. D. Esq.	5	0	0
*Knight, Rev. C. R.	1	0	0
*Knight, Mrs. E. D.	1	0	0
Llewellyn, G. Esq.	1	0	0
Llewellyn, J. T. D. Esq.	1	0	0
*Llewellyn, R. W. Esq.	10	6	0
*Llewellyn, W. Esq.	1	0	0
Morris, G. Byog. Esq.	1	0	0
*Morse, Lieut.-Col.	1	0	0
Nicholl, Lieut.-Col. C. R. H.	1	0	0
*Nicholl, J. C. Esq.	2	2	0
Ollivant, Mrs.	1	0	0
Pritchard, W. Esq.	10	6	0
Stacey, Rev. C.	1	0	0
Traherne, Major.	1	0	0
*Turberville, Lt.-Col.	1	0	0
Turberville, Mrs.	10	6	0
Williams, W. Esq.	10	6	0
*Wilson, Thos. Esq.	10	6	0
Wimborne, Lord	5	5	0
Total	£47	12	0

SWANSEA BRANCH.

Honorary Secretary—
F. W. ISLAY YOUNG, Esq.
Annual Subscriptions.
Bath, Henry & Son.

Bath, Henry & Son.	5	5	0
*Capper, R.	1	0	0
Cory, T.	1	0	0
Crowhurst, Mr. H. W.	10	6	0
Davidson, T. R. R.	10	6	0
Evans, J. M.	10	6	0
*Ford, Capt.	1	0	0
Forester, Mr. W. H.	1	0	0

Gilbertson, W. & Co.	1	1	0
*Gold, Mr. Charles.	1	1	0
Goodall, Mr. H. G.	10	6	0
Grenfell and Sons.	2	2	0
*Harvey, B. R.	10	6	0
*Haynes, Mr. G. B.	10	6	0
*Horman-Fisher, Mr. S. S. H.	10	6	0
Ilid, Thomas.	1	1	0
James, Mr. F.	1	1	0
Jones, Jno.	1	1	0
Manger, E. O.	2	6	0
Mesnier & Co.	1	0	0
Michael, Mr. James.	10	6	0
Morris, Sir J. A., Bt.	1	0	0
*Nettell, J. T.	10	6	0
Prevost & Letricheux	5	0	0
Richards, T. P.	1	1	0
Richardson, Mr. J. C.	1	1	0
Richardson and Co.	2	2	0
Sailors' Chapel, per Rev. E. J. Wolfe.	2	2	0
Thomas, J. D.	10	6	0
Townsend, Wood, & Co.	1	1	0
Trustees of Swansea Harbour	30	0	0
Tulloch, L.	10	6	0
*Vivian, Mr. H. H., M.P.	3	3	0
Vivian, Mr. W. G.	1	1	0
Walter, J.	10	6	0
Williams, Mr. F. E.	10	6	0
Total	£67	12	0

Gloucestershire.

BRISTOL BRANCH.

Chairman—
M. WHITWILL, Esq.
Honorary Secretary—
Captain HURCHINS.
Collector—
Mr. S. JONES, 19 College
Green.

Annual Subscriptions.

	£.	s.	d.
Bligh, Mrs. R.	2	2	0
Bush, J. and R.	10	6	0
Butterworth, M ^c Ar- thur & Co.	1	1	0
Daniel, Thos. & Sons	5	5	0
Edgar, Miss	1	0	0
Edgar, Miss R.	1	0	0
Gell, Mrs.	2	2	0
Goodwyn, T. W.	1	1	0
Goody, Cripps, & Sons	1	0	0
Grace, J. and H.	10	6	0
Hill, C. and Sons	1	1	0
Hutchins, T. C.	10	6	0
Justice, F. W.	10	0	0
Justice, Miss	10	0	0
Justice, Miss M. E.	10	0	0
King, R. P. & W. P.	2	2	0
Miles, W. H.	1	1	0
Phillips, A. Esq.	1	1	0
Powell, W. & Sons	2	2	0
Rushforth, Mrs. E. M.	1	0	0
Russell, Miss C. E.	10	0	0
Russell, Rev. J. C.	5	0	0
Stroud, Rev. H.	1	0	0
Stuckey and Co.	1	0	0
Terrell, W. and Sons	1	0	0
Thomas, C. J. & Bros.	1	0	0
Wancey, A.	1	0	0
Wedmore, T.	1	0	0
Whitwill, M.	2	2	0

Table with columns £, s, d. Lists names and amounts: Woodman, C. 10 6; Wright, W. 1 0; Total £36 14 0. Includes sub-section 'Donations' with names like Tulloch, Mrs. Box, Bristol Marine Association, etc.

CHELTHENHAM BRANCH.

Table for Cheltenham Branch. Lists names and amounts: Hon. Secretary—Captain G. E. Hodgson; Collector—Mr. W. WITCHELL; Annual Subscriptions: Bell, W. E. Esq. 1 0; Buckle, Mr. 1 0; Total £18 15 6.

Hampshire.

PORTSMOUTH AND HAYLING ISLAND BRANCH.

Table for Portsmouth and Hayling Island Branch. Lists names and amounts: Honorary Secretary—Wm. PAYNE, Esq.; Nat. Prov. Bank of England, Portsmouth; Annual Subscriptions: Allnutt, Mr. 5 0; Austen, Rev. G. 10 0; Total £5 0 0.

Table with columns £, s, d. Lists names and amounts: Cndlipp, Arthur, Esq. 10 6; DeIma, H. P. Esq. 1 0; *Dunlop, Commander R.N. 5 0; Emanuel, A. L. Esq. 5 0; Emanuel, Alderman, J.P. 10 0; Foster, H. P. Esq. 10 6; *Galt, Col. Edwin 5 0; Grant & Co. Messrs. 1 0; Hackman, L. L. Esq. 1 0; Hall Hall, Mrs. 1 0; *Hall, J. S. Esq. 1 0; Harly, Rev. C. 10 0; Harrison, Miss H. W. 10 0; Heron, M.L., of Dundee, per Stokes & Co. 1 0; Holdsworth, Miss 10 6; Key, Comm. & Mrs. 10 0; Key, Capt. 10 0; *Knight, J. P. Esq. 1 0; *Knight, S. P. Esq. 10 0; *Knighton, Sir W. W. Bart. 1 0; Jeans, Mrs. 1 0; Johnson, Maj.-Gen. S. 10 0; Lancaster, Capt. H. J. 8 0; Lantridge, Rev. O. A. 5 0; *Lethbridge, Admiral 5 0; Marvin, Mrs. R. 5 0; Mawbey, Col. R.M.A. 2 0; *Miller, Gordon, Esq. 10 6; Moore, Miss M. S. 1 0; Murray, Mrs. E. D. 10 6; Pares, John, Esq. 1 0; *Payne, W. 5 0; *Peile, Capt. M. S. L., R.N. 10 6; Pike, Spicer, & Co., Messrs. 1 0; Power, F. Esq. 5 0; *Raby, Admiral, V.C. 5 0; *Rake, George, Esq. 5 0; Ricketts, E. Esq. 10 0; Ricketts, Miss F. Z. 1 0; Ryder, Admiral, Commander-in-Chief. 1 0; Sandeman, Mrs. 1 0; Seymour, Admiral Sir M. Bart., G.C.B. 1 0; Sheppard, C.W. Esq., of Liverpool 5 0; Sheppard, Rev. H.W. 1 0; Stokes, Mrs. Hannah 1 0; Stokes, Capt. R., R.N. 1 0; Tatchell, Albert G. Esq. 10 6; Taylor, Capt. R.N. 5 0; Thompson, —, Esq. 5 0; Turner, Mr. W. C. 5 0; Woodman, Mrs. 10 0; Collecting Boxes 7 8 3; Total £47 10 3.

Isle of Wight.

ISLE OF WIGHT BRANCH.

Table for Isle of Wight Branch. Lists names and amounts: Chairman—CHARLES SELBY, Esq., M.P.; Treasurer—G. WYATT, Esq., Newport, I.W.; Honorary Secretaries—Rev. W. E. HEYGATE, Rector of Brightstone; Rev. R. BROUGHTON, Vicar of Shorwell; *WILLIAM SELBY, Esq., Brooke; Annual Subscriptions: *Barrett, O. Moulton, Esq. 3 0 0; Beckford, Mrs. 2 0 0.

Table with columns £, s, d. Lists names and amounts: Blake, J. Ruffin, Esq. 10 6; Brigstocke, Miss. 1 0; *Broughton, Rev. R. 10 6; *Brown, Mr. C. 5 0; *Brown, Mr. H. 5 0; Browne, Lt.-Col. H.G. 1 0; Bushnell, Mrs. 10 0; Carter, E. Esq. 1 0; Carter, Miss 10 6; Cochran, Lady 1 0; Collins, E. P. Esq. 10 6; Collins, Miss 10 6; Connor, Rev. Canon R. 10 0; Cottle, Rev. Thomas 1 0; Cotton, B. T. Esq. 1 0; Crozier, Mrs. 1 0; Diprose, Mr. John. 0 10 6; Eldridge, Jas. Esq. 10 0; Eveleigh, Captain 1 0; Feilden, Misses 2 0 0; *Gaze, Rev. J. Fellow George, Mr. Jas. 5 0; Giles, Mrs. George 2 2 0; Golden, Mr. Isaac 10 6; Gordon, Lady Mary. 1 0; Harvey, Capt. T. & Mrs. 2 0 0; *Hayton, Rev. G. 10 6; Herschel, Sir Wm. 10 0; *Heygate, Rev. W. E. 1 0; Heytesbury, Lord 1 0; Hoffmeister, W. C. Esq., M.D. 5 0; *Hillier, Mr. W. 5 0; Hood, Hon. Mrs. Grosvenor 5 0; Howard, G. Esq. 10 0; Isaacson, Rev. Canon Jephson, Commr. A., R.N. 2 2 0; Jolliffe, Mr. Jonathan 10 0; Kentfield, Mr. T. 5 0; Kerr, Mrs. B. 1 0; Kirkpatrick, Miss. 1 0; Law, Miss Mary. 5 0; *Le Marchant, Thos. Esq. 1 0; Love, Miss. the late. 1 0; *Lowther, Capt. Marcus, R.N., and Mrs. 2 2 0; Macnamara, Rev. T.B. 1 0; Manners, Lieut.-Col. W. W. 10 0; Martin, Miss F. P. 3 0 0; Meares, Hush, Esq. 10 0; Mew, Messrs. W. B. Langton and Co. 1 0; Meyers, Barnett, Esq. 1 0; Miltmay, Sir Henry, Bart. 1 0; Millidge, Mr. Alfred Mortimer, H. Esq. 10 0; J.P. 10 0; Mortimer, Wm. Esq. 10 6; J.P. 10 6; *Mowbray, Mr. John 5 0; Newnham, Mr. C. 5 0; Oglender, Lady 2 0; *Ommaney, Admiral Sir Erasmus 10 6; Pattinson, Maj. W.H. 5 0; Pelham, Hon. Mrs. D. 1 0; Pennethorne, J. Esq. 1 0; Pring, Mr. Samuel 10 0; Richards, Mrs. Russell 1 0; Scott, Miss. 5 0; Secker, G. H. Esq. 1 0; *Seely, C. Esq., M.P. 2 0; Seely, Mrs. 1 0; *Seely, Mr. Wm. 5 0; Sewell, Miss W. 10 0; Shelden, Mrs. W. G. 1 0; *Simcon, Sir Barrington, Bart. 1 0; Smith, Capt. Gilbert Spencer 1 0; Sorby, Misses H. & L. 10 0; Southouse, Rev. G.W. 7 6; Spickernell, Mr. J. J. 5 0; Spickernell, Mr. Wm. 5 0; Swift, Mrs. Catherine 1 0.

Table with columns £, s, d. Lists names and amounts: Tennyson, A. Esq. 1 0; Thornton, A. B. W. Esq. 1 0; Thornton, H. S. W. Esq. 1 0; Tubby, Miss A. 10 0; Tuffey, Mr. T. H. 5 0; Upward, E. J. Esq. 1 0; Vibert, Mr. Benjamin 1 0; Ward, W. G. Esq. 1 0; *Way, Mr. Henry 10 6; Way, Mr. W. C. 5 0; Winther and Co. Messrs. 1 0; Wood, J. Esq. 2 0; Worsley, J. Esq. 1 0; Wright, H. Smith, Esq. 1 0; *Wyatt, Mr. G. 10 6; Yard, Mrs. Alleyne. 1 0; Total £2 14 6.

Donations.

Table with columns £, s, d. Lists names and amounts: Ashley, Hon. Evelyn, M.P. 2 0 0; Barrett, O. M. Esq. 1 0 0; Carisbrooke Congregational Collection by Rev. E. B. James. 4 4 0; Dowling, Mr. H. 5 0; Gordon, Lady Mary. 10 0; McAll, Mrs. 10 0; Pattinson, Maj. W.H. 5 0; Seely, Mrs. 1 0; Tuffey, Mr. R. 5 0; Wilson, the Misses 10 0; Collecting Boxes:—Brooke Boat-house 10 0; Golden, Master Leonard 18 5; Marine Hotel, Ventnor 5 0; Roy. Needles Hotel, Alum Bay 7 6; Royal Pier Hotel, Ryde. 5 0; Sums under 5s. 8 7; Total Dons. 13 3 6; Total Subs. £2 14 6.

BEMBRIDGE BRANCH.

Table for Bembridge Branch. Lists names and amounts: Chairman—The Marquis of CHOLMONDELEY; Honorary Secretary—Admiral WILMSHURST, C.B.; Annual Subscriptions: *Clayton, Rev. A. P. 10 6; *Clayton, W.L.N. Esq. 10 0; Freeman, H. S. Esq. 1 0; *Le Mesurier, Rev. J. 1 0; Pring, Mr. Samuel 10 0; Levinge, W. H. Esq. 10 0; Moreton, Captain A. M. D. 2 2 0; Palmer, Rev. J. N. 1 0; Thomas, F. B. Esq. 1 0; Wilmshurst, Admiral 1 0; Small Subscriptions, 16 0; Total £9 12 6.

BRANCHES—LIST OF ANNUAL SUBSCRIPTIONS AND DONATIONS. 577

Kent.

BROADSTAIRS BRANCH.

Chairman—

Honorary Secretary—
Mr. THOS. JACKSON.

Annual Subscriptions.

	£.	s.	d.
His Grace the Archbishop of Canterbury.....	1	0	0
Anson, Admiral.....	10	0	0
Banting, W. Esq.....	2	2	0
*Barritt, Mr.....	10	0	0
Bligh, C. Esq.....	1	1	0
Brown, Miss.....	10	0	0
Buckingham, J. Esq.....	1	1	0
Bullivant, —, Esq.....	1	0	0
*Carr, Rev. J. H.....	1	0	0
*Chapman, Mr. Lucy.....	10	6	0
Delo, Mr. S. H.....	5	0	0
*Elyard, Lieut.-Col.....	10	0	0
Elyard, The Misses.....	1	1	0
Eveling, M. Esq.....	10	6	0
Fawcett, Rev. R. A.....	10	0	0
Harwood, Mrs.....	1	1	0
Jackson, Mrs.....	1	1	0
Lasham, Mr.....	5	0	0
Marriott, E. T.....	1	1	0
Mortimer, —, Esq.....	1	1	0
McNally, Mr.....	5	0	0
Moyes, John, Esq.....	1	1	0
North, Hon. H. F.....	1	1	0
Poore, E.....	5	0	0
Walter, O. C. Esq.....	10	0	0
Wyatt, W. Esq.....	1	1	0
Total.....	20	13	0

DOVER BRANCH.

Chairman—
Major SCOTT.

Honorary Secretary—
Lieut.-Gen. BRUCE, C.B.

Annual Subscriptions.

Ayers, Mr.....	5	0	0
Back, Mr.....	5	0	0
Baird, Dr.....	5	0	0
Boodle, W. C. Esq.....	1	0	0
Boyle, the Ladies.....	5	0	0
Bradley Brothers.....	10	0	0
*Bruce, Capt. Sir T., R.N.....	5	0	0
*Bruce, General, C.B.....	10	6	0
Cannon, Capt.....	10	0	0
Court, P. S. Esq.....	10	0	0
Cow, Capt.....	5	0	0
Crosby, Mrs.....	1	0	0
Dickeson, R. Esq.....	1	1	0
Finnis, S. Esq.....	5	0	0
Flashman, Mr.....	5	0	0
Fritch, Major.....	2	2	0
Graves, —.....	5	0	0
Goren, James, Esq.....	1	1	0
Goren, James N. Esq.....	1	1	0
Hathorn, Mrs.....	10	0	0
Hayward, — Esq.....	5	0	0
Heath, General.....	1	0	0
Hills, Mr.....	5	0	0
Hughes, Carter, Esq.....	10	0	0
Hyde, Mrs.....	5	0	0
Iglesleden, Mr. B. A.....	5	0	0
Joyce, Messrs.....	5	0	0
Knocker, W. Esq.....	1	1	0
*Marsh, Cullen.....	10	0	0
Maxwell, General.....	1	1	0
Mesham, Mrs.....	1	0	0
Morgan, E. D. Esq.....	1	0	0
Ramsbottom, J. K. Esq.....	1	0	0
Rose, Miss.....	1	1	0
Schryott, N. Esq.....	5	0	0
*Scott, Major.....	1	1	0
Sisco, Mr.....	5	0	0
Stilwell, J. Esq.....	5	0	0

Stuart, G. Esq.....	1	1	0
Sutton, Dr.....	1	1	0
Warsford, — Esq.....	5	0	0
Weston, Mr. L.....	10	6	0
Wilson, Mr.....	5	0	0
Wissenden, Miss E. S.....	10	0	0
Sums under 5s.....	12	6	0
Total.....	27	9	6

Donations.

Mitchell, F. H. Esq.....	10	10	0
Watlington, Perry, Esq.....	5	5	0
Collecting Boxes.....	16	4	5
Total Dons.....	31	19	5
Total Subs.....	27	9	6
£59 8 11			

GOODWIN SANDS AND DOWNS BRANCH.

Patrons—
The Right Hon. the EARL GRANVILLE, K.G., P.C.
SIR WALTER JAMES, BART.

Chairman—
*Capt. G. DOUGLAS, R.N.

Treasurer and Hon. Sec.—
*Rev. T. S. TREANOR.

Local Hon. Secretary at Kingsdowne—
Mr. W. BAILEY.

NORTH DEAL LIFE-BOAT.

Annual Subscriptions.

Boys, Capt. H., R.N.....	1	1	0
Chennell, F. A. Esq.....	10	6	0
Cinque Ports Pilots, 26 Subs. under 5s.....	3	5	0
Cullen & Son, Messrs.....	5	0	0
Darby, Mrs.....	5	0	0
Edwards, J. B. Esq.....	10	6	0
Elbeck, The Misses.....	1	1	0
Evans, R. P. Esq.....	1	1	0
Frost Bros., Messrs.....	10	0	0
Griffith, Rev. T. Ll.....	10	6	0
Hammond and Co., Messrs G.....	10	6	0
Harvey, J. J. Esq.....	10	6	0
Henderson, J. Esq.....	10	6	0
*Hilton, Dr.....	1	0	0
Iggulden, John, Esq.....	1	0	0
James, Sir W. C. Bart.....	3	3	0
Laplough, H. Esq.....	10	0	0
McCreaigh, Lady.....	10	0	0
Morris, Mrs.....	1	1	0
*Nethersole, Jno. Esq.....	10	6	0
Pittock, Mr. W.....	10	0	0
Roope, T. Esq.....	10	6	0
Sydney, Earl.....	1	1	0
Seward, N. Esq.....	10	0	0
Watt, Miss.....	5	0	0
Westhorp, Theophilus.....	1	1	0
Wood, H. D. Esq.....	10	0	0
Total.....	422	13	0

Donations.

Bray, Miss.....	1	0	0
Chambers, Miss, per Messrs. Mercer and Edwards.....	2	10	0
Deal Amateur Christy Minstrels, per Mr. George Brown.....	2	17	6
Deal collecting boxes.....	5	4	5
Hicks, G. M. Esq.....	10	10	0
Do. (1878-81) £42.....			
Total Dons.....	22	11	11
Total Subs.....	22	13	0
£44 14 11			

WALMER LIFE-BOAT.

Annual Subscriptions.

Granville, Earl, K.G., P.C.....	5	0	0
Benson, Rev. M.....	10	0	0
Boys, Mrs.....	1	0	0
Brassey, H. Esq. M.P.....	5	0	0
Brooke, Miss.....	15	0	0
*Bushe, Capt. R.N.....	10	0	0
Cannon, Vice-Adm. E. St. Leger.....	1	10	0
Cullen & Sons, Messrs.....	5	0	0
*Davey, Dr.....	10	0	0
Douglas, Capt. J.....	10	0	0
*Douglas, Capt. G.....	5	0	0
Elliston, Rev. E.....	1	1	0
Fisher, Miss.....	5	0	0
Green, A. Esq.....	1	0	0
Green, Lieut.-Gen.....	1	1	0
Griffith, Rev. T. Ll.....	10	0	0
Hales, Miss.....	5	0	0
Harvey, Vice-Adm.....	1	0	0
Harvey, Mrs. W. H.....	10	6	0
Hilton, Rev. G. S.....	1	0	0
James, Sir W. Bart.....	2	0	0
Kemball, Mrs.....	5	0	0
Kenrick, Mrs.....	1	0	0
*Leith, H. Esq.....	1	0	0
Monins, Mrs.....	5	0	0
Nethersole, Mr. W.....	5	0	0
Samler, Miss.....	5	0	0
Simpson, Miss.....	10	0	0
Smith, Arthur, Esq.....	1	0	0
Thompson and Sons, Messrs.....	1	0	0
Walmor Collecting Box.....	4	10	8
Watt, Miss.....	5	0	0
Woodruffe, Mrs.....	1	0	0
Total.....	35	18	2
North Deal.....	44	14	11
£80 13 1			

HYTHE, SANDGATE, AND FOLKESTONE BRANCH.

President—
The Rt. Hon. Lord PRLEHAM.

Chairman—
Capt. SARGEAUNT, R.N. Folkestone.

Treasurer—
J. R. DAVY, Esq., N. P. Bank, Folkestone.

Honorary Secretary—
GEORGE WILKS, Esq., Hythe.

Annual Subscriptions.

Ashdown, Mr. Ed.....	5	0	0
Barton, Mrs.....	5	0	0
Bligh, Lady.....	10	0	0
Brockman, F. Esq.....	1	1	0
Burden, Mrs.....	5	0	0
Cobb, Mr. J. V.....	5	0	0
Cobb, Thomas, Esq.....	5	0	0
Davy, J. R. Esq.....	5	0	0
Dawson, Mrs.....	10	0	0
Deedes, Major.....	5	0	0
Deedes, William, Esq.....	1	0	0
*Du Boulay, J. Esq.....	10	6	0
Edwards, J. B. Esq.....	10	0	0
*Fitness, John, Esq.....	10	6	0
Godden, Mr. Stephen.....	5	0	0
Hankey, General.....	1	0	0
Harrison, W.G.S. Esq.....	10	6	0
Hart, Miss.....	5	0	0
Hoad, J.....	5	0	0
Holden, Mr.....	10	0	0
*Jenkins, Rev. Canon.....	10	6	0
*Kingsford, K. Esq.....	10	6	0
Kirkpatrick, Major.....	10	6	0
Lonsdale, J. Esq.....	10	6	0

Annual Subscriptions.

*Markeson, H. B. Esq.....	10	6	0
Morton, Major.....	5	0	0
*Nelson, John, Esq.....	10	6	0
Oxenden, Mr. Geo.....	5	0	0
Oxenden, Mrs.....	1	1	0
*Pledge, W. Esq.....	10	6	0
Rigden, Mr. R.....	10	6	0
Russell, G. Esq.....	10	6	0
Sampson, Mrs.....	10	0	0
Sandilands, E. Esq.....	10	6	0
*Sherwood, John, Esq.....	10	6	0
Shipwash, Mr. E.....	5	0	0
*Sargeant, Capt. A. R.N.....	10	6	0
Side, Mrs.....	10	6	0
Smith, W. S. Esq.....	5	0	0
Thomson, E. S. Esq.....	5	0	0
Thompson, Robert, Esq.....	5	0	0
*Tolpitt, J. B. Esq.....	10	6	0
Tournay, Tournay W. Esq.....	1	1	0
Walton, Mr. E. C.....	5	0	0
Ward, Rev. V.....	5	0	0
Watkin, Sir E., M.P.....	10	6	0
Wildash, Dr.....	10	0	0
Wilks, George, Esq.....	10	6	0
Williamson, Rev.....	10	6	0
Wilson, Mr. William.....	5	0	0
Sums under 5s.....	4	12	5
Total.....	£28	0	6

Donations.

Pillar Boxes, Folkestone Harbour.....	2	18	11
Do. Pier.....	9	6	4
Hythe.....	3	1	6
Sandgate and Box at Boat-house.....	5	7	6
Total Dons.....	20	14	3
Total Subs.....	28	0	6
£48 14 9			

KINGSGATE BRANCH.

Honorary Secretary—
Capt. ISAACRE, H.C.S.

Assistant Secretary—
Mr. J. J. FRANCIS.

Annual Subscriptions.

His Grace the Archbishop of Canterbury.....	1	1	0
Alexander, C. Esq.....	2	2	0
Cotton, Mrs.....	1	0	0
Edmeades, Rev. W.H.....	1	2	0
Fearn, Capt.....	1	0	0
*Hannam, G. E. Esq.....	10	0	0
Harris, T. N. Esq.....	1	1	0
Hodgson, Rev. J. G.....	1	1	0
*Isacke, Capt. H.C.S.....	1	0	0
L Levy, Jonas, Esq.....	5	0	0
Metcalf, Col. C.B.....	1	1	0
Rammell, Mr. G.....	5	0	0
*Webb, Major.....	10	0	0
Whish, G. P.....	1	1	0
Whish, Mrs G. T.....	1	1	0
Whitehead, Rev. A.....	10	0	0
Total.....	19	4	0

Donation.

Pillar Boxes (1881).....	2	4	8
Total.....	£21	8	8

LYDD DUNGNESS BRANCH.

Chairman—
ALURED DENNE, Esq., D.L.

Honorary Secretary—
E. T. BASS, Esq., J.P.

Annual Subscriptions.

	£.	s.	d.
Bartholomew, Mrs.			
William	1	0	0
*Bass, C. E. Esq.	10	0	0
*Bass, E. T. Esq.	10	0	0
Bevan, Rd. Esq.	10	0	0
Blacklocks, Mr. J.	5	0	0
*Blacklocks, Mr. Wm.	10	0	0
Burra, James, Esq.	10	0	0
Burton, Rev. Chancellor	2	0	0
*Denne, Alured, Esq.	10	0	0
Denne, Col. R.H.A.	1	0	0
*Finn, Mr. Arthur	10	0	0
*Finn, Mr. Edwin	10	0	0
Finn, Mrs. George	5	0	0
Finn, Miss Mary	5	0	0
Gell, Rev. E.	10	0	0
Hutchings, Lewis	10	0	0
Prescott, Mr. Wm.	5	0	0
*Procter, J. C. Esq.	10	0	0
Rayner, S.	10	0	0
Selmes, Messrs.	10	0	0
White, Mrs. C.	5	0	0
Wingate, Rev. W.C.I.	10	0	0
Wood, Field, & Hanbury, Messrs.	1	0	0
Young, E. D., Esq.			
E.N.	10	0	0
Sums under 5s.	2	6	
Total	£13	18	6

MARGATE BRANCH.

Chairman—
J. T. FRIEND, Esq., J.P.

Honorary Secretary—
Wm. CHAWFORD, Esq.

Annual Subscriptions.

Amos, Mr. G.	5	0	0
Andrews, Mrs. O.	5	0	0
Bayly, Mr. John	5	0	0
Bolton, Rev. A. C. H.	10	0	0
Barrett, T. J. Esq.	1	0	0
Bentley, Messrs. D. and W. and Son	5	0	0
Blyth, Rev. E. H., M.A.	5	0	0
Boulden, Rev. A. W., M.A.	10	0	0
Carroway, Mr. John	5	0	0
Chancellor, Mr. S. S.	5	0	0
Chubb, Mr. J. F.	5	0	0
Cobb, A. B. Esq.	10	0	0
Cobb, F. C. Esq.	1	0	0
Cobb, T. F. Esq.	1	0	0
Cockerell, Mrs.	5	0	0
*Cotton, H. H. P. Esq.	1	0	0
Crawford & Co. Messrs.	1	1	0
Cutlack, R. and A.	5	0	0
DeVaynes, Miss	1	0	0
Dentry, James, Esq.	10	0	0
Daring, Sir E. C. Bart.	2	2	0
Edgar, Miss R.	10	0	0
Emptage, Mr. D.	5	0	0
Eveling, Mr. M.	10	0	0
Fagg, Mr. W. A.	5	0	0
Foord-Kelcey, Geo., Esq.	10	6	
*Friend, J. T. Esq.	1	0	0
Gallindo, Miss	5	0	0
Gilder, Mrs.	10	0	0
Goddard, J. Esq.	1	0	0
Gray, Mr. W. G.	5	0	0
Green, Walter, Esq.	5	0	0
Greensted, Mr. P.	5	0	0
Harris, Mrs. Chas.	5	0	0

	£.	s.	d.
Harvey, Mr. W. S.	5	0	0
Hatfield, Capt.	10	0	0
Head, G. F. Esq. L.L.D.	10	0	0
Hermifage, Mr. H. F.	5	0	0
Horwell, T. E. Esq.	1	0	0
Hume, Mr. J.	5	0	0
*Issacson, E. Esq.	1	0	0
Jones, Rev. W.			
Taylor	1	1	0
Kember, Miss	10	0	0
Kidd, Mrs.	10	6	
Knight, Rev. C.	10	0	0
Larkin, John, Esq.	1	0	0
Love, Horatio, Esq.	10	6	
Makins, Mr. J. B.	5	0	0
Mercer, W. Esq.	5	0	0
Paramor, Messrs. R. and Son	5	0	0
Pittcock, Dr.	5	0	0
Rapson, Mr. J.	5	0	0
Robinson, G. W. Esq. M.A.	10	6	
Rowe, Dr. T. S.	1	0	0
Rowe, Mr. F. S.	5	0	0
Russell, Geo. Esq.	2	2	0
Scott, Miss	2	2	0
Searles, Mr. Walter	5	0	0
Smith, C. D. Esq.	5	0	0
Staner, Mr. J. H.	5	0	0
Stile, S. Esq.	1	0	0
Tassell, Mr. P. J.	5	0	0
Thornton, Miss	2	2	0
Treves, W. K. Esq.	5	0	0
Wastall & Co. Messrs.	5	0	0
Weekley, Mr. J.	5	0	0
Willets, Mr. F. W.	5	0	0
Woodruff, Mr. W. C.	5	0	0
Wootton, Mr. A.	5	0	0
Wootton, S. Esq.	10	0	0
Young, Mr. H. W.	5	0	0
Total	£40	2	6

Donations.

Enticknap and Sons, Messrs. 10 6

Jones, H. C. Esq. 5 0

Prosser, Rev. S. 5 0

Rowe, W. Esq. 1 0

Simpson, The Misses

Veal, Mr. J. (Collected by him at Ramsgate) 3 16 6

Sums under 5s. 2 17 6

Small Sums 9 2

Pillar Box on Jetty

Extension 1 18 4

Do. at L. C. & D. R. Station 18 0

Do, Crown Inn 11 9

Do, Hoy Hotel 7 4

Total Dons. 13 10 1

Total Subs. 40 2 6

£53 12 7

NEW ROMNEY BRANCH.

Chairman—
HENRY COBB, Esq.

Honorary Secretary—

Annual Subscriptions.

Finn, Mrs. G.	10	0	0
Miller, Mrs.	5	0	0
Scott, Miss	1	1	0
Thornton, Miss	3	3	0
Total	£4	19	0

PORT OF ROCHESTER BRANCH.

President—
His Worship the MAYOR.

Honorary Secretary—
Mr. J. H. CROCKFORD.

Annual Subscriptions.

	£.	s.	d.
Aldridge, Mr. W.	10	0	0
Aldridge, Mr. J. T.	10	6	
Allen, Mrs.	5	0	0
Aveling, T. Esq.	1	0	0
Bartram, W. Esq.			
Sch.-Yacht <i>Merlin</i>	1	1	0
Belsey, F. F. Esq.	10	6	
Benton, J. S. Esq.			
(Mayor of Rochester)	1	1	0
Budden, A. F. Esq.			
Capt. 12th R. A. V.	10	6	
Budden, W. Esq.	10	0	0
Bullard, Mr. C.	5	0	0
Burfield, Mr. R. C.	5	0	0
Crockford, Mr. J. H.	1	1	0
Edwards, J. L. Esq.	5	0	0
Foord, W. W. Esq., Medway Steam Packet Company	1	1	0
Foord, J. and Sons, Messrs.	1	1	0
Gardiner, Mr. A. F.	10	0	0
Gill, Mr. G. W.	10	0	0
Haymen, W. Esq.	1	1	0
Hills, Mr. J. S.	5	0	0
Hills, Mr. G.	5	0	0
Royal Engineer Yacht Club, School of Military Engineering, per Lieut. A. E. Haynes, R.E.	2	0	0
Watson and Gill, Messrs.	10	6	
Webb, Mr. W.	5	0	0
Woodhams, W. Esq.	10	6	
Total	£15	13	6

Donations.

Contents of Box London & County Bank, Chatham Branch 1 1 6

Royal Victoria Owl Club, Rochester 2 2 0

Amounts under 5s. 4 6

Total Dons. 3 8 0

Total Subs. 15 13 6

£19 1 6

Lancashire.

BLACKBURN BRANCH.

President—
His Worship the MAYOR.

Treasurer—
J. S. POLLITT, Esq., Manchester and County Bank.

Honorary Secretary—
JOSEPH BRIERLEY, Esq. C.E.

Donations and Subscriptions.

	£.	s.	d.
His Worship the Mayor, John Lund, Esq.	1	1	0
Appleby and Son	1	1	0
Boyd, John	5	0	0
Brierley, J., C.E.	10	0	0

	£.	s.	d.
Bryan, W. B. C.E.	5	0	0
Dean, John, Esq.	15	0	0
Dugdale, Adam, Esq.	1	0	0
Eccles, S. M. Esq.	5	0	0
Embley, J.	10	0	0
Hart, Thomas, Esq.	1	0	0
Howard, Thomas	5	0	0
Paffard, F.	5	0	0
Pollitt, J. S.	5	0	0
St. George's School, per Rev. A. B. Grosart, L.L.D.	6	8	10
Thompson, W.	5	0	0
Umpleby, J.	10	6	
Total	£19	8	4

BLACKPOOL BRANCH.

Chairman—
HENRY HALL, Esq., Mayor.

Treasurer—
J. PICKOP, Esq.

Honorary Secretary—
A. M. VIENER, Esq.

Annual Subscriptions.

Aspinwall, Miss	5	0	0
*Bickerstaffe, Robert	10	6	
Brown, Dr.	1	1	0
Carter, Miss	10	6	
Caw, Mrs.	10	0	0
*Cocker, W. H. Esq.	1	1	0
Dutton, Miss	10	0	0
Grindrod, Mr.	1	1	0
*Handley, Mr.	10	6	
Hanley, Esq.	1	1	0
*Harrison, R. Esq.	1	1	0
Haydock, Mrs.	1	0	0
*Jeffrey, Rev. N. S.	10	6	
Jenkinson, Miss	10	0	0
Lowe, Miss	10	0	0
Masheter, Mr.	5	0	0
*Meredith, Esq.	1	1	0
Farnell, Mr.	1	1	0
*Pickop, J. Esq.	1	1	0
Rycoft, Capt.	10	0	0
Sharples, Mr. George, Southshore	10	0	0
Smith, Mr. John	5	0	0
Sutcliffe, Mr.	1	1	0
*Sykes, Benj. Esq.	1	1	0
Thomas, Mrs.	1	1	0
Threlfall, Laz. Esq.	1	1	0
Tolson, Mrs.	1	1	0
Topping, Ewd. Esq.	1	1	0
*Viener, A. M. Esq.	1	1	0
Whiteley, Miss	1	1	0
Williams, Mr.	10	0	0
Young, Capt. R.N.	1	1	0
Total	£25	4	0

Donations.

Pillar and other Collecting Boxes 19 17 3

Total 45 1 3

BOLTON BRANCH.

Chairman—
THOMAS GLAISTER, Esq. Mayor of Bolton.

Honorary Secretary—
THOMAS H. WINDER, Esq.

Annual Subscriptions.

Abbatt, Mr. Wm.	10	6	
*Ainsworth, R. H. Esq.	1	1	0
J.P.	1	1	0
Arrowsmith, Mr. T.H.	1	1	0
*Barlow and Jones, Messrs.	2	2	0

BRANCHES—LIST OF ANNUAL SUBSCRIPTIONS AND DONATIONS. 579

£.	s.	d.	£.	s.	d.	£.	s.	d.	£.	s.	d.
*Barnes & Co. Messrs.			*Carson, Mr. Alex.	1	0	Barrow, Thomas	5	0	*Maxsted, G. W.	1	0
Thomas	3	3	Clemesha, Mr. Alfred	10	6	Barrow, Miss S.	5	0	*Moon, J. C.	1	0
Bradshaw, Mr. J.	1	0	Cook, Capt.	10	0	Barrow, William	10	0	Moon, Jas., London.	1	0
Briggs, A. L. Esq.,			Coulburn, Mr. William	5	0	Bartlett, Rev. P.	10	0	Moon, Geo., London.	10	0
J.P.	1	0	Cross, Capt.	10	6	Barton, Mrs.	1	0	Moser, R. P.	5	0
Briggs, Chris. Esq., J.P.	1	0	Daniels, Rev. Geo. S.	5	0	Baynes, Chr.	10	0	Moss, W. E.	10	0
Brown, James	1	0	Davies, Mr. Alex.	5	0	Beesley, James	3	0	Noon, Mrs.	10	0
Butler and Murton,			*Drewry, Mr. Thomas	5	0	Bell, John	5	0	Ormond, Mrs.	1	0
Messrs.	1	0	Drewry, Mr. William	5	0	Bell, Thomas	5	0	Paget, Miss	10	0
*Cooper, Mr. Thomas	1	0	Drummond, Mr. Thomas	1	0	Bell, W.	5	0	Parker, James	1	0
Croft, Rev. R. C. W.	10	6	Dunderdale, Robert,			*Blades, Chas.	1	0	Parr, H. W.	5	0
*Crook, Joseph, Esq.,			Esq., J.P.	1	0	Bond, R.	2	6	Peacock, Rev. E. The	1	0
J.P.	2	2	Fisher, Mr. Thomas	5	6	Bone, Rev. John	5	0	Pedder, Mrs. E. The		
*Cross, John and Sons,			Fleetwood Estate Co.	3	3	Booker, S., Swarth-			late	1	0
Messrs.	1	0	*Gaulter, Mr. Cuth-			dale	1	0	Peebles, Mrs.	1	0
Crowther, Mr. Samuel	10	6	bert,	10	0	Bowes, Miss	5	0	Pritt, Rev. F. D.	10	0
Crowther, Mr. Wm.	10	6	*Gibson, Mr. Jas. R.	10	6	Bradshaw, Isaac	5	0	Pritt, Mrs.	10	0
Cunliffe, Mr. George	1	0	Gornall, Mr. William	5	0	Bradshaw, Miss	5	0	Procter, W.	1	0
Dorrian, James, Esq.,			Graham, Rev. Walter	5	0	Bradshaw, W.	10	0	Pryke, Rev. W. E.	1	0
J.P.	1	0	Harrison, Mr. Ains-			*Briggs, Capt. Robert	1	0	Redmayne, Mrs.	5	0
Fell, Mrs. G.	10	0	worth	5	0	Briggs, Mrs.	10	0	Redmayne, Miss J.	5	0
Fernthigh, Mr. W.	10	6	Hudson, Mr. Luke.	10	0	Burrell, J. S. Liver-			Ripley, Mrs. The late	2	0
Freeman, Mr. R. K.	1	0	*Humphrys, Capt.	10	6	pool	1	0	Roper, W.	10	0
Glaister, Thomas, Esq.	1	0	James, Rev. Herbert			Burrow, Miss Jane,			Rothwell, Miss	5	0
Gidlow, Mr. Thomas	10	6	A., B.D., Rossall			Burrow, Mrs.	5	0	Boyd, Rev. C. T.	1	0
Greenhalgh, Mr. E. P.	10	6	School.	2	2	Butler, Mrs.	10	6	Boyd, Mrs., Heysham		
Green, Mrs. J.	1	0	Johnson, Mr. John	5	0	Carson, Miss	1	0	Cottage	1	0
Hardcastle, Mr. F.	1	0	*Kemp, Frederick,			Charnley, R.	10	0	Saunders, C. M.	1	0
Haslam, J. and Co.	1	0	Esq., J.P.	2	2	Chippindall, Misses	15	0	Seward, Abram	5	0
*Heywood, Mr. John	1	0	Knight, Mr. Robert	10	0	Clark, C. T.	1	0	Sharpe, F.	10	0
*Hick, J. Esq.	1	0	Lancaster Bank. Co.	2	0	Clark, Miss, Queen St.	10	0	Sharp, Mrs. Jno.	1	0
Holden, Mr. C. H.	1	0	*Lings, Rev. Henry.	10	6	Clarke, Miss	10	0	Sherson, Miss	1	0
*Holden, Mr. Thos.	1	0	North Lancashire S.			Clayton, Miss	1	0	*Simpson, M.	1	0
Holden, Mr. T. W.	2	2	Navigation Co.	21	0	Cleminson, Chas.	10	0	Smith, Joseph	1	0
Holden, Mr. A. T.	1	0	*Orr, Dr.	1	0	Crompton, Miss	2	0	Starkie, J. P. C.	1	0
*Houldsworth, Mr. J.S.	10	6	*Pearson, Rev. James,			Dalzell, J. H.	10	0	Storey, Edward	5	0
Hulton & Son, Messrs.	1	0	M.A.	10	0	Davis, Rev. D.	1	0	Storey, J.	2	6
*Kevan, Mr. Peter	10	6	Porter, Mr. Edmund	5	0	*Dawson, E. B.	1	0	*Storey, Thos.	1	0
*Knowles, Jas. Esq.			Porter, Dr.	5	0	Dawson, Mrs. E. B.	10	0	Swainson, Thos.	40	0
J.P.	1	0	Porter, Mr. William	5	0	Dawson, Mrs.	5	0	Swainson, Wm.	2	6
*Knowles, John, Esq.,			Preston Banking Co.	2	0	Dickinson, John	5	0	pool	10	0
J.P.	1	0	Preston, Mr. Joseph.	5	0	Diggins, James	5	0	Taylor, Messrs. R. & J.	1	0
*Lee, Henry, Esq. M.P.	1	0	Riley, Mr. Thomas	5	0	Dixon, Miss	2	6	Threlfall, Misses	10	0
Marsden, J. & Sons,			Shuttleworth, Mr.			Dixon, Miss M.	2	6	Townley, Miss	5	0
Messrs.	1	0	William	10	0	Donaldson, J. H.,			Townley, John,		
McIntosh, Dr.	1	0	Smith, Rev. Henry W.	5	0	London	2	2	Southport	1	0
Mitchell, Mr. T.	1	0	Smith, Jervoise	2	0	Duxbury, S.	2	6	Tunstall, Mrs.	1	0
*Muggrave, J. & Sons,			Sumner, J. and Co.,			Eastwood, L.	2	6	Walker, Rev. Canon	10	0
Messrs.	1	0	Messrs.	1	0	Edmondson, T. Lon-			Watson, J.	5	0
Nicholson, Mr. Wm.	1	0	Warbrick, Mr. Richard	10	6	don	10	0	Wearing, S. W.	10	0
Richardson, H. M.			*Ward, Mr. John	10	6	Edmondson, Mrs., do.	10	0	Welch, W. G.	10	6
Esq.	1	0	*Wignall, Mr. John	1	0	Fielding, Mrs.	1	0	Welch, Misses	5	0
Shaw, Mr. Richard	10	6	Total	54	19	Ford, Miss	1	0	Whimpray, J.	1	0
Taylor, Mr. S.	1	0				Ford, W.	1	0	Williamson, Jas.	1	0
Thomasson, J. P.,						Friend, A.	3	0	Woods, Mrs.	10	0
Esq., M.P.	5	0				*Greene, Lieut.-Col. T.2	2	0	Wright, Mrs.	4	4
*Walmsley, T. Esq. J.P.	1	0				Greene, Rev. T. H.	2	0	Total	112	7
*Wilkinson, Mr. T.	1	0				Greene, T. P.	10	6			
*Winder, R. and T. H.	1	0				Greg, Albert	1	0			
*Winkworth, S. Esq.						Greg, John	1	0			
J.P.	1	0				Hadwen, Mrs.	10	0			
Total	57	17				Hall, Dr.	10	0			
						Hall, Richard	10	0			
						Hall, S.	2	6			
						Harris, S. J.	1	0			
						Hatch, James	10	6			
						Hathornthwaite, Rev.					
						Dr.	1	0			
						Hinde, Misses	1	0			
						Hodgson, Thomas	10	6			
						Hornby, Mrs.	2	0			
						Howitt, Mrs.	10	0			
						Jackson, George	1	0			
						Jackson, Edmund	5	0			
						Johnson, C.	10	0			
						Johnson, Dr. James	1	0			
						Lancaster Quay Com-					
						missioners	5	5			
						Lancaster Banking Co.	3	3			
						Langshaw, Mrs.	2	6			
						Leeming, Misses	5	0			
						Leeming, Mrs. John	5	0			
						*Leeming, R.	2	2			
						Lord, James	10	6			
						Lowndes, Miss	10	0			
						Lowndes, Miss Kate	10	0			
						Macnicol, Miss.	10	0			
						Mansergh, E.	5	0			
						Mansergh, Mrs.	5	0			
						Masonic Lodge of					
						Fortitude, 281	1	0			

FLEETWOOD BRANCH.

Patron—
F. KEMP, Esq., J.P.
Chairman—
J. WIGNALL, Esq., J.P.
Treasurer—
THOS. DREWRY.
Honorary Secretary
(pro tem.)
J. PICKERING, Esq.
Annual Subscriptions.
Albion Steam Saw-
Mill Comp. Limit. 1 1 0
Ashton, Mr. Walter . . . 5 0
Barker, Alfred . . . 10 6
Butterworth, Isaac . . . 10 6
*Carr, Mr. Thomas H. 1 1 0

LANCASTER BRANCH.

President—
Lieut.-Col. GREENE.
Honorary Treasurer—
J. C. MOON, Esq.
Honorary Secretary—
M. SIMPSON, Esq.
Annual Subscriptions.
Allen, Rev. Dr. . . . 1 0 0
Baines, L. T. . . . 1 0 0
Baldwin, Miss. . . . 1 0 0
Ball, T. . . . 5 0
Barker, Mrs. . . . 10 0

Donations.

Carson, Miss . . . 5 0 0
Caton Choir Enter-
tainment . . . 1 11 6
Legacy, J.S. Harrison 19 0 0
Christ's Church Offert. 2 11 0
St. Anne's Do. 3 3 8
Seward, A. C. (Model
Life-boat) . . . 10 0
St. John's, Offertory. 3 5 6
County Hotel (Model
Life-boat) . . . 7 5
Bank interest . . . 1 9 3
Total Dons . . . 37 17 4
Total Subs. . . . 112 7 6
£160 4 10

LIVERPOOL & NEW BRIGHTON BRANCH.

Chairman—
ALFRED BOWEE, Esq.
Treasurer—
HAROLD L. BOWEE, Esq.
Hon. Secretary at Liverpool—
CHARLES H. BRUCE, Esq.
Hon. Sec. at New Brighton—
J. L. C. HAMILTON, Esq.
Assistant Secretaries—
MR. MATTHEW HENDRIE.
MR. JOHN COLE.

Annual Subscriptions.

	£.	s.	d.
Adam, E., Esq. M.D.	1	0	0
Adams, R., Esq.	5	0	0
Alexander, Robt. Esq.	1	0	0
Allan Brothers & Co. Messrs.	1	0	0
Allan, R. G. Esq.	1	0	0
Allender, Miss	1	0	0
Anderson, W. H. Esq.	1	0	0
Anderson, R. & Co. Messrs.	1	0	0
Armstrong, Jos. Esq.	1	0	0
Ashe, T. F. Esq.	1	0	0
Aspinall, Son, and Brooke, Messrs.	1	0	0
Atherton, Wm., Esq.	1	0	0
Babcock, B. F., Esq.	1	0	0
Baker, Chas. Esq.	1	0	0
Bailey, John, Esq.	1	0	0
Bald, A., Esq.	1	0	0
Balfour, Williamson, and Co. Messrs.	1	0	0
Banke, Meyrick, Esq. the late	1	0	0
Baring, Brothers & Co. Messrs.	2	0	0
Barrow, James, Esq.	1	0	0
Bartlett, Thos. Esq.	1	0	0
Bartlett, Wm. Esq.	1	0	0
Bates, E. and Son, Messrs.	2	0	0
Battersby, W. & C. & Co. Messrs.	1	0	0
Beazley, James, Esq.	1	0	0
Beazley, James H., Esq.	1	0	0
Belcher, M. Esq.	1	0	0
Belcher, Wm. M. Esq.	1	0	0
Bell, Wm. Esq. M.D.	1	0	0
*Beloe, Charles H. Esq.	1	0	0
*Beloe, H. C. Esq. J.P.	1	0	0
Bennett, Wm. Esq.	2	0	0
Bewley, Jno. Esq.	1	0	0
Bingham, W. Esq.	1	0	0
Blain, Samuel, Esq.	2	0	0
Blower, Dr.	10	6	0
B. ddy, Gill, Esq.	1	0	0
Bouch, John, Esq. J.P.	1	0	0
Bouch, T. W. Esq.	1	0	0
*Bower, A. Esq.	3	0	0
*Bower, H. L. Esq.	2	0	0
Bowring, C. T. & Co. Messrs.	2	0	0
Boxwell, Wm. Esq.	1	0	0
Branker, John, Esq.	1	0	0
Brandreth, Thos. Esq.	1	0	0
Brierley, Wood, and Co., Messrs.	2	0	0
*Briggs, Capt. W. S.	1	0	0
Bristow, J. Esq.	1	0	0
British and African Steam Ship, Co.	2	0	0
British and Eastern Shipping Company, Limited.	2	0	0
Brocklehurst, G. W. Esq.	5	0	0
Brocklehurst, H. Esq.	1	0	0
Brocklehurst, R. Esq.	1	0	0
Brocklehurst, S. Esq.	1	0	0
Bromham, W. Esq.	1	0	0
Browne, A. F. Esq.	10	0	0
Bulley, S. M. & Sons, Messrs.	1	0	0

	£.	s.	d.
Bulley, S. M., Esq.	1	0	0
Butterworth, Miss J.	1	0	0
Caivert, Capt.	1	0	0
Cannington, John and Co., Messrs.	1	0	0
Carter, Tyner, and Parker, Messrs.	1	0	0
Carter, Wm. Esq.	1	0	0
Chadburn, W. Esq.	1	0	0
Chamberlain, G. Esq.	1	0	0
*Chambres, Major Wm., J. P.	2	0	0
Coltart, R. Esq.	1	0	0
Comber, Thos. Esq.	1	0	0
Comberbach, W. S. Esq.	1	0	0
Cookson, Edward H., Esq.	1	0	0
Cookson, T. W. Esq.	1	0	0
Cope, Bros. and Co. Messrs.	1	0	0
Cotesworth, Lyne and Co. Messrs.	1	0	0
Coubrough, H. Esq.	1	0	0
*Coutbourne, E. W. Esq.	1	0	0
Cox, G. R. Esq.	2	0	0
Cox, Henry, Esq.	1	0	0
*Cox, James, Esq.	2	0	0
Crellin, H. Esq.	10	0	0
Crooks, R. F. Esq.	1	0	0
Crooks, Robt. Esq. the late	1	0	0
Crosbie, Major C. E.	1	0	0
Crosby, R. Esq.	10	6	0
Crosfield, J. D. Esq.	1	0	0
Crosfield, C. J. Esq.	1	0	0
Cunningham, H. Esq.	1	0	0
Currey, Major Henry	1	0	0
Currey, John, Esq.	1	0	0
Davies, Ellis & Co. Messrs.	1	0	0
Derby, Right Hon. The Earl of	2	0	0
Dixon, W. T. Esq.	1	0	0
Dobell & Co. Messrs.	1	0	0
Durning, Wm. Esq. the late	1	0	0
Earles and King, Messrs.	1	0	0
Easton, Thos. O., Esq.	2	0	0
Eccles, E. S., Esq.	1	0	0
Eden, Dr. Thos.	1	0	0
*Edwards-Moss, Sir T. Bart.	5	0	0
Elder, Dempster, and Co. Messrs.	1	0	0
Ekington and Co. Messrs.	1	0	0
Ellery, Mrs.	2	0	0
Elmslie, L. C., Esq.	5	0	0
Esckrigge, R. A. Esq.	2	0	0
Evans, T. Esq.	5	0	0
Fairhurst, J. Esq.	1	0	0
Fallows, John, Esq.	1	0	0
Fletcher, G. H. & Co. Messrs.	1	0	0
Fogg, N. B. Esq.	1	0	0
Fowell, Rev. R. D.	10	6	0
Friend, E. C. and Co. Messrs.	1	0	0
Gamble, D. Esq.	1	0	0
Gardner, Major.	1	0	0
Gardner, Henry, Esq.	1	0	0
Gardner, Joseph, Esq.	5	0	0
Gardner, R. C. Esq.	10	6	0
Gardner, W. R., Esq.	5	0	0
Garnett, Alex. Esq.	1	0	0
Garratt, John, Esq.	10	0	0
Gaudy, Captain M.	1	0	0
Gillespie, Co. Messrs.	1	0	0
Gladstone, Robt. Esq.	1	0	0
Glynn, Jno. & Sons, Messrs.	1	0	0
Goffey, Thos., Esq.	1	0	0
Gordon, John, Esq.	1	0	0
Gordon, James, Esq.	1	0	0
Gossage, Fred. H. Esq.	2	0	0
Goodlass, Wall, and Co. Messrs.	1	0	0
Graham, Henry, Esq. the late	2	0	0
Graham, Miss	10	0	0

	£.	s.	d.
Graves, Robt. E., Esq.	1	0	0
Greenshields, T. E. Esq.	1	0	0
Grey, Edward, Esq.	1	0	0
Groves, Charles, Esq.	1	0	0
Gruning & Co. Messrs.	2	0	0
Gunson, Brown & Co. Messrs.	1	0	0
*Hamilton, John L. C. Esq.	1	0	0
*Hannay, J. M. Esq.	1	0	0
Harding, Thos. Esq.	2	0	0
Hargreaves, Jno. Esq.	2	0	0
Harris, G. Esq.	10	6	0
Harrison, E. H. Esq.	1	0	0
Harrison, Fredk. J. Esq.	1	0	0
Harrison, Gilbert and Bros. Messrs.	1	0	0
Harrison, T. and Co. Messrs.	1	0	0
Hay, John, Esq.	1	0	0
Healey, S. R. Esq., the late	2	0	0
Henderson, F., Esq.	1	0	0
Henderson, Capt. H.	1	0	0
Henderson, W. G. Esq.	1	0	0
Herschell, Adolph, Esq.	1	0	0
Heywood Sons and Co. Messrs.	1	0	0
Higginbottom, Miss E. A.	1	0	0
Higgins, Wm. Esq.	1	0	0
Hind, Miss A.	5	0	0
Hind, Wm. Esq.	5	0	0
Hind, John H., Esq.	1	0	0
Holder, Thomas, Esq.	1	0	0
Holland, Mrs.	2	0	0
Holland, W. G. Esq.	10	6	0
Hollinshead, Miss	1	0	0
Holt, G. A. Esq.	1	0	0
Holt, Miss	2	0	0
Hope, S. T. Esq.	1	0	0
Hope, William, Esq.	1	0	0
Hornby, H. B. Esq.	10	6	0
Hornby, Rev. Thos.	1	0	0
Horsfall, Robt., Esq. the late	1	0	0
Houghton, E. P. Esq.	10	6	0
Houghton, Jno. Esq.	1	0	0
Houghton, Miss E. D.	1	0	0
Houghton, Miss Jane	1	0	0
Hughes, John W. Esq.	1	0	0
Hurworth, R. Esq.	5	0	0
Hutchinson, Miss	10	0	0
Hutchinson, W. H. Esq.	10	6	0
Ihlers & Bell, Messrs.	1	0	0
Inman Steam Ship Co. Limited	1	0	0
Irven, Geo. S. Esq.	1	0	0
*Imay, Imrie, & Co. Messrs.	2	0	0
Jack & Co. James, Messrs.	2	0	0
Jackson, Jos. Esq.	1	0	0
Jackson, R. Esq.	1	0	0
Jardine, D. Esq.	2	0	0
Jacob, W. T. Esq.	1	0	0
Japp & Kirby, Messrs.	1	0	0
J. K. C.	1	0	0
Johnson, F. Esq.	1	0	0
Johnson, Richd. Esq.	1	0	0
Johnson, R. C. Esq.	1	0	0
Johnston, W. and Co. Messrs.	5	0	0
Jones, Edw. W. Esq.	1	0	0
Jones, Wm. Esq.	5	0	0
Jones, Thos. Esq.	10	6	0
Jones, W. H. Esq.	1	0	0
Joyson, Capt. Ed.	1	0	0
Joyson, T. Esq.	1	0	0
Just, Wm. Esq.	10	6	0
*Kent, Alfred, Esq.	10	6	0
Kerferd, G. B. Esq.	1	0	0
Kitley, Wm. and Co., Messrs.	1	0	0

	£.	s.	d.
King, W. Esq.	1	0	0
Knox, Wm. Esq.	1	0	0
Kurtz, A. G. Esq.	1	0	0
Kurtz, Charles & Sons, Messrs.	2	0	0
Laird, McGregor, Esq.	1	0	0
Laird Bros. Messrs.	2	0	0
Lampont and Hoit, Messrs.	3	0	0
Langton, Chas. Esq.	1	0	0
Lear, John, Esq.	1	0	0
Leitch, Jas. & Co. Messrs.	1	0	0
Litherland, W. Esq.	1	0	0
Little, James, Esq.	1	0	0
Little, William, Esq.	1	0	0
Littledale, H. Esq.	2	0	0
Lister, Jas. Esq.	1	0	0
Liverpool Steam Tug Co. Messrs.	2	0	0
Lloyd, Mrs. M.	10	6	0
Lockett, C. H. Esq.	1	0	0
Lowndes, R. Esq.	1	0	0
Lunt, W. J. Esq.	10	6	0
*McDiarmid, J. Esq.	1	0	0
MacAlister, Mrs. Annie	2	0	0
Macfie and Sons, Messrs.	2	0	0
Macgregor, A. Esq.	1	0	0
Macgregor, Alex. Esq.	2	0	0
MacIntyre, L. H. & Co. Messrs.	1	0	0
*MacIver, D. Esq. M.P.	1	0	0
Macrae, G. G. Esq.	2	0	0
Maddock, F. T. Esq.	1	0	0
Maddock, Mrs.	1	0	0
Mahler, John, Esq.	1	0	0
Maples, A. Esq.	10	6	0
Marquis, Robt., Esq.	1	0	0
Marquis, Robt., Esq. for 1880	1	0	0
Marrlott, Wm. Esq.	1	0	0
Marshall, W. B. Esq.	1	0	0
Martin, Jas. T. Esq.	10	6	0
Mason, E. G. Esq.	10	6	0
Massey, Fredk. Esq.	1	0	0
Mellor, J. H. Esq.	1	0	0
Meyer, F. A. Esq.	1	0	0
Minoprio, Chas. Esq.	2	0	0
Molyneux, Capt. A. M.	1	0	0
Moore, Dr.	1	0	0
Moss, Thomas Esq.	1	0	0
Moss, Rev. J. Miles	1	0	0
Mounsey, E. Esq.	1	0	0
Muspratt, E. K. Esq.	1	0	0
National S.S. Co. Limited Messrs.	1	0	0
Newgass, B. Esq.	1	0	0
Nicholson, R. & Sons, Messrs.	1	0	0
Nickels, J. T. & Co., Messrs.	1	0	0
Nicol, William, Esq.	1	0	0
North, Fred. Esq.	1	0	0
Pappacalo, D. Esq.	1	0	0
Papayanni and Co. Messrs.	2	0	0
Parker, A. T. Esq.	1	0	0
Parker, Mrs. Ellen.	10	0	0
Parr and Rae, Messrs.	2	0	0
Pearson, John, Esq.	1	0	0
Peel, John, & Co. Messrs.	1	0	0
*Peers, James, Esq.	1	0	0
Phillips, Son, and Nephew, Messrs.	1	0	0
Pickering, C. W. H. Esq. (the late).	1	0	0
Poole, Braithwaite, Jun. Esq. the late.	1	0	0
Pooley, Mrs. Henry.	1	0	0
Powell, Masters J. G. S. and Frank	10	0	0
Porter, Wm. & Co. Messrs.	1	0	0
Preston, G. F. Esq.	1	0	0
Preston, R. P. Esq.	1	0	0
Preston, R. W. & Co. Messrs.	1	0	0
Psicha, G. F. Esq.	1	0	0

BRANCHES—LIST OF ANNUAL SUBSCRIPTIONS AND DONATIONS. 581

£.	s.	d.	£.	s.	d.		
Quiggan, John M. Esq.	10	6	*Tipton and Falcon, Messrs.	1	1	0	
Radcliffe, R. Esq.	10	0	Tomlinson, Hodgetts and Co. Messrs.	1	1	0	
Ralli, Bros. Messrs.	2	2	0	Tory, Mrs. E.	1	1	0
Ralli, C. M. Esq.	2	2	0	Travis and Wilde, Messrs.	1	1	0
Rathbone, Benson, Esq.	2	2	0	Turner, Alfred, Esq.	1	1	0
Rathbone Brothers and Co. Messrs.	7	7	0	Turner, John, Esq.	1	1	0
Rathbone, Martin and Co. Messrs.	1	1	0	Urmson, Thos. Esq.	1	1	0
Rathbone, Wm. Esq. M.P.	2	2	0	Wainwright, Rowland & Co. Messrs.	2	2	0
Ravenscroft, W. Esq.	1	1	0	Walker, A. and Co. Messrs.	2	2	0
Rawdon, J. F. Esq.	10	6	0	Walker, Horace, Esq.	2	2	0
Rayner, E. W. Esq.	1	1	0	Walker, Parker and Co. Messrs.	2	2	0
Rayner, Rod., Esq.	3	3	0	Wall, F. Esq.	10	6	0
Rayner, M. Esq.	1	1	0	Walsh, R. J. Esq.	1	1	0
Reade, T. Mellard, Esq.	1	1	0	Waterhouse, Miss M. E.	1	0	0
Rew, John, Esq. (the late)	1	1	0	Watmough, Mrs.	1	1	0
Richardson, Miss E.	10	0	0	Watson, R. B. Esq.	1	1	0
Rigby, Alderman T.	1	1	0	Watson, Hy. Esq.	2	2	0
Rigby, Samuel, Esq.	2	2	0	Webster, Jas. Esq.	1	1	0
Rigg, Morden, Esq.	1	1	0	Weightman, W. H. Esq.	1	1	0
Rimmer, Miss A.	10	6	0	West, Montague, Esq.	1	1	0
Robertson, Alex. Esq.	1	1	0	West India and Pacific Steam Navigation Co.	2	2	0
Robertson, Crowe & Co. Messrs.	1	1	0	White, Alex. & Sons, Messrs.	1	1	0
Robinson, Isaac W. Esq.	1	1	0	White, Forman and Co. Messrs.	10	6	0
Robinson, Robt. Esq.	1	1	0	Wilkinson, E. W. Esq.	10	6	0
Robinson, W. L. Esq.	1	1	0	Williamson, Samuel, Esq.	10	6	0
Roberts, M' Cubbin and Co. Messrs.	1	1	0	Williamson, Thos. Esq.	1	1	0
Roberts, J. Esq.	5	0	0	Williams & Powell, Messrs.	1	1	0
Rodgers, Robert, and Co. Messrs.	2	2	0	Williams, J. W. and Son, Messrs.	10	6	0
Rodger, W. Esq.	1	0	0	Williamson, Milligan & Co. Messrs.	1	1	0
Rolls, Thomas C. Esq.	1	0	0	Willis, M. M. Esq.	1	1	0
Rome, Wm. Esq.	1	1	0	Wood, Henry, & Co. Messrs.	1	1	0
Ronald Sons & Co. Messrs.	5	5	0	Woods, William, Esq.	1	0	0
Rosenheim, L. and Sons, Messrs.	1	1	0	Wrenn, J. & Co. Messrs.	1	0	0
Saunders, Needham, and Co. Messrs.	2	0	0	Wright, A. T. Esq.	1	0	0
Schotefeld, J. W. Esq.	1	1	0	Wright, Crossley & Co. Messrs.	1	0	0
Schroeder and Co. Messrs. J. H.	2	2	0	Wyllie, E. Esq.	1	0	0
Septon, Mr. John.	5	0	0	Yates, E. W. & Co. Messrs.	1	1	0
Shallcross, T. R. Esq.	1	1	0				
Silberbach, J. H. Esq.	10	0	0				
Skinner, Dr. Thos.	1	1	0				
Slater, J. Esq.	1	1	0				
Smart, David, Esq.	2	2	0				
Smith, A. M. and Co. Messrs.	1	1	0				
Smith, James, Esq.	1	1	0				
Smith, Robert, Esq.	2	2	0				
Smith, Samuel, Esq.	5	0	0				
Smith, Samuel, Esq.	2	0	0				
Smyth, Ross, T. & Co. Messrs.	2	2	0				
Sparrow, A. and Co. Messrs.	1	0	0				
Spoonley, S. Junr. Esq.	1	1	0				
Springmann, E. Esq.	10	6	0				
Stanistreet, G. Esq.	1	0	0				
Steel, James, Esq.	1	1	0				
Stuart & Co. D. G. Messrs.	2	2	0				
Stevenson, John, Esq.	1	1	0				
Stevenson, Geo. Esq.	2	0	0				
Swire, John, & Sons, Messrs.	2	2	0				
Taylor, Cameron, and Co. Messrs.	2	2	0				
Taylor, Chas. Esq.	1	1	0				
Tetley, T. W. Esq.	1	1	0				
Thomas and Cook, Messrs.	1	1	0				
Thompson, J. W. Esq.	1	1	0				
Thomson, T. Esq.	1	0	0				
Thornwall, E. J. Esq.	1	1	0				
Threlfall, the late J. M., Trustees of	1	1	0				
Timuis, T. S. Esq.	2	2	0				

Total.....477 16 6

Donations.

Browne, Miss M. F.	10	0
Bull, Miss Lucy	10	0
Ashton, The Misses	2	0
Charlton, Isaac, Esq.	1	0
Connolly, L. Esq.	1	0
Crosthwaite, Arthur, Esq.	1	1
Drury, Captain	5	0
For services rendered at Tynemouth on the occasion of the loss of the ship <i>Iron Crown</i> , per Shallcross and Higham.	10	0
Crew of <i>City of Delhi</i> , per Capt. Adair.	4	0
Officers and crew of <i>City of Cashmere</i> , per Capt. Grieve.	4	0
Gostenholer, C. T. Esq.	5	0
Haddrell, J. Esq.	5	0
Hamilton, Fraser & Co. Messrs.	2	2
Jackson, Mrs. M.	10	0
Lightbody, Miss M. A.	5	0
Macalister, Robt. Esq.	5	0
Molyneux, Capt. W. H., R.N.	2	2

£.	s.	d.
Morgan, Walter, Esq.	1	1
Tatham, Miss	5	0
Wheatley, R. Esq.	1	0
	0	0
Roz List.		
Alexandra Hotel	1	2
Hamson, Mr. Thos.	13	11
New Brighton Landing Stage	2	12
New Brighton Ferry Hotel	12	9
Promenade Pier	1	6
Union Hotel	1	0
Williams, Miss	17	2
Woodside Ferry	1	6
Birkenhead Railway Station Refreshment Room	2	1
Capt. Main	6	10
Miss Lauer, <i>The City</i>	12	0
Life-boat House	1	6
Batham, Miss	9	6
Sums under 6s.	1	7
	3	6
Total Dona.	72	3
Total Subs.	477	16
	550	0

LYTHAM BRANCH.

President—

Chairman—

Rev. H. B. HAWKINS —
Honorary Secretary—
Mr. JOHN EDMONDSON.

Annual Subscriptions.

*Banister, Capt.	10	0
Clifton, J. T. Esq. (the late)	5	5
Clifton, Lady E.C.	3	3
Cockcroft, Miss	10	6
Dannett, Miss, Cheltenham	1	1
Fair, Thomas, Esq.	1	1
Hall, Miss	1	1
Hankinson, J. Esq.	1	0
Harrison, Miss	1	0
*Hawkins, Rev. H. B.	1	0
Hewitt, Miss E.	1	0
Hewitt, Miss Sarah	1	0
*Hinckman, Major	1	1
Howarth, Miss	1	0
Knowles, Mrs.	10	6
Pocock, Rev. Charles	1	1
Richardson, John, Esq.	10	6
Threlfall, Mrs.	1	1
*Wartenberg, S. Esq.	1	1
Total	23	17

Donations.

Pillar Boxes	6	19
Coll. at Encampment of 3rd Adm. Batt. Lanc. R. V., Col. Dugdale (1881)	7	18
Offertory at the Harvest Festival at Lytham Parish Church, by Rev. H. B. Hawkins	38	16
Total Dona.	53	13
Total Subs.	23	17
	477	11

MANCHESTER BRANCH.

Honorary Treasurers—
ROBERT WHITWORTH Esq. (Messrs. B. WHITWORTH Bros.)
S. L. HELM, Esq.

Honorary Secretaries—
Rev. E. HEWLETT, M.A.
J. CORBETT, Esq.

Annual Subscriptions.

£.	s.	d.
Anonymous	1	1
Agelasto, A. and Co.	1	0
Agnew, J. H.	10	6
Agnew, J. H. & Bros.	10	6
Armistead, R.	1	1
Armistead and Son, Sir E.	1	1
Ashton, Thomas	2	2
Aspell and Bradley	2	2
Barbour, R. & Bros.	3	3
Barlow and Jones (Limited)	1	1
Barlow, Thos. & Bros.	1	1
Bealey, Richard	1	0
Beattie, William	1	0
Beatty, Altgeld, & Co.	1	1
Böhrens, S. L. and Co.	2	2
Bell, Wm.	1	1
Binks, Mrs.	1	1
Bles, S. D. and Sons	1	0
Bremner, J. A. and Co.	1	1
Briggs, Thos.	1	1
British and Foreign Marine Insurance Co.	5	5
Broadhurst, Lee & Co.	5	5
Broome, Jos.	1	1
Brown, A. C. & Co.	1	0
Bryan, H.	5	0
Buchly and Co.	1	1
Buckley, James	1	0
Burton, Fredk.	1	1
Carver Bros.	1	1
Chadwick, Jas. Esq.	5	5
Charlesworth, T. L.	1	1
Clayton, G. E.	2	6
Clegg, Mrs. Thos.	5	0
Craigtree, H. & Sons	3	3
Craig, Mrs. Jas.	1	0
Credwood, Alfred	1	1
Davies, R.	1	1
Dehn, Arnold	10	6
De Trafford Sir H. Bt.	5	0
Dewhurst, G. and R.	1	1
Diggles, Thos.	10	6
Dods, Ker, and Co.	2	2
Du Fay & Co.	2	2
Dugdale, John	2	2
Ede, Frederick C.	1	1
Edmunds, John	10	0
Edwards, Cunliffe, Wilson, and Co.	10	6
Ellinger and Co.	1	1
Farbridge, Holliday, and Co.	1	1
Ffarington, Miss	1	0
Findlater and Mackie	2	2
Foster, T. Barham	1	1
Pothergill & Harvey	1	0
Gaddum and Co.	1	1
Galbraith, Johnson, and Co.	1	1
Galloway and Co., J.	1	1
Gent, F. and Co.	1	1
Goldschmidt, P.	1	1
Grafton, F. W.	5	0
Gray, Wm. 1882-3.	1	1
Green, G. H.	1	1
Greg, H. R.	1	1
Grover, F. A.	5	0
Gunnis, G. P. & Co.	1	1
Hanby, Richard	10	0
Hardman, S. L. J.	5	0
Harling, John	1	1
Harrison, Miss	3	6
Hartley, Mrs. W.	10	0
Haslam, Jas.	1	0
Haworth & Co. Rich.	1	1

	£.	s.	d.
Hayes, Henry	1	0	0
Helin, S. L.	2	2	0
Heywood, A. H.	2	2	0
Heywood, Oliver, J.P.	2	2	0
Higgin, Lloyd & Co.	2	2	0
Holme, John	10	6	
Hoyle, Joshua, & Son (Limited)	2	2	0
Illingworth and Heywood	2	2	0
Interest at Bank	1	16	3
Jones, T. E.	2	2	0
Kirkpatrick, E.	5	0	0
Kolp, M. and Co.	2	2	0
Ledward, Thomas, and Sons	1	1	0
Leedham, F. H.	1	1	0
Leppoc, H. J., J.P.	2	2	0
Lomax, Eliza	1	1	0
Lomnitz & Duxbury	1	1	0
Lyon, Lord, and Co.	1	1	0
Luke, Jas.	10	6	
M'Kead, Mrs. Jos.	1	1	0
Maclaren, Nephews	1	1	0
Malthy, Jos.	10	6	
Mather and Platt	2	2	0
Melland and Coward	1	1	0
Merton, A.	10	6	
Micholls, Lucas, & Co.	1	1	0
Middleton, T.	1	1	0
Miller, Mrs. Colonel Murray	5	0	0
Millward and Cryer	1	0	0
Murray, Alex.	1	1	0
Novell & Co.	2	0	0
Occleston, Fitzgerald, and Co.	10	6	
O'Hanlon, Mrs.	1	0	0
Openshaw, Wm.	1	1	0
Patterson, J. & B.	1	1	0
Peacock, Mollison and Co.	1	1	0
Pear, Thos.	1	0	0
Pease, Mrs. Gurney	1	0	0
Pecher, Ed. and Co.	1	0	0
Peel and Co. John	5	0	0
Petrocchino Bros.	1	0	0
Phillips, Herbert	2	0	0
Porter, Miss E.	1	0	0
Rahr and Raundrup	1	1	0
Railton, John	1	1	0
Rall Bros.	1	1	0
Reinsch am Ende & Co.	1	0	0
Reischer and Ellisco	10	0	0
Renshaw, R. T.	1	1	0
Ridge, W. R.	1	0	0
Robertson, J.	1	1	0
Robinson, G. and Co.	1	1	0
Rose, Thomas	1	1	0
Ryder, James	1	1	0
Samson, H.	2	2	0
Samson, John, and Co.	1	1	0
Schuster, Fulda, & Co.	1	1	0
Schwabe, Salls, & Co.	2	2	0
Sewell, Jos.	1	1	0
Slagg and Co. John	1	1	0
Smith and Sons, B.	2	2	0
Smith, William, Bowdon, one year's dividend on £300 invested in Manchester Corporation Water Works Perpetual Annuities, towards support of Manchester Life-boats	12	0	0
Stone, Dr. J.	1	1	0
Stretton, B. and Co.	1	1	0
Sutcliffe, John F.	1	1	0
Taylor, Garnett & Co.	2	2	0
Thames and Mersey Marine Insurance Company	5	5	0
Turner, Mrs.	10	0	0
Watts, Edward	1	1	0
Wedemeyer, R.	1	1	0
Whalley, Thos. & Co.	1	1	0
Whitworth, Edmund	1	1	0
Windsor, Councillor	10	6	
Worthington and Son	10	6	

	£.	s.	d.
Wright and Shaw	1	1	0
Ziegler, Ph. and Co.	1	1	0
Sums under 5s.	9	0	0
Total	216	11	9

Donations and Legacies.

Collected by Mr. J. P. Consterdine—

Barnes, H. A.	5	0	0
Bubch, Mrs. and Masters	7	0	0
Cooper, Mr. & Mrs.	5	0	0
Cooper, Mr. W. H.	5	0	0
Chippendall, Mrs. J.	5	0	0
Consterdine, Mrs.	5	0	0
Consterdine, Mrs. J.	5	0	0
Consterdine, J. P.	5	0	0
Le Mare, Mrs.	5	0	0
Small sums	4	6	
Burrows, Mast. Children's Bazaar	3	0	6
Chadwick, Mrs.	2	18	9
Freemason's Lodge of Integrity	10	10	0
Friend	10	10	0
Heywood, Oliver, J.P. (for "City of Manchester" Life-boat)	30	0	0
Ditto	10	0	0
Legacy under will of the late Miss Lupton	103	16	0
Lower Moseley Street Sunday School	2	4	0
Scotch Church Sunday Sch. (Bloomsbury)	1	0	0
St. Thomas's Sunday School, Ardwick	2	9	6
Storey, K., Executors of the late	30	0	0
Townend, Mrs., for Life-boat at Saltburn-on-Sea	1000	0	0
Watts, George F.	10	0	0
Whalley Range, Young Friends	11	6	

Total Dons., &c.	1269	11	9
Total Subs.	216	11	9
	£1486	3	6

ORMSKIRK BRANCH.

President—
Rev. CANON SHELDON, M.A.

Treasurer—
LUKE BARGHOUS, Esq.

Hon. Secretary—
HARRISON GRUNDY.

Annual Subscriptions.

Alty, Thomas, Esq.	10	0	0
Barnacle, the Rev.	5	0	0
John, Rainford	5	0	0
Brighouse, Luke, Esq.	10	6	
Brighouse, H. Esq.	10	6	
Brighouse, Mrs., The Cottage	10	0	0
Burgess, Geo. C. Esq.	1	1	0
Casteja, The Hon. Count de	3	3	0
Chittlburgh, F. J. Esq.	5	0	0
Holcroft, Thos. Esq.	5	0	0
Gardiner, Fred. Esq.	10	6	
Garside, W. H. Esq.	10	0	0
Garside, S. A. Esq.	10	6	
Grundy, Mr. Harrison	10	0	0
Grundy, Edwin, Esq.	10	6	
Rawthorne, J. Esq.	1	1	0

Sheldon, The Rev. Canon, M.A.	1	1	0
Stretch, Herbert, Esq.	5	0	0
Tomlinson, R. Esq.	1	1	0
J.P.	12	19	6

Donations.

Prescott, John, Esq.	2	0	0
Jones, Mrs. Trafalgar House	10	0	0
Williams, Mrs. D. Artigas	5	0	0
Total Dons.	17	0	0
Total Subs.	12	19	6
	£29	19	6

PIEL BRANCH.

President—
His Grace the DUKE OF DEVONSHIRE, K.G.

Honorary Secretary—
CAPTAIN STOKES.

Annual Subscriptions.

Duke of Devonshire	2	2	0
Barrow Steam Nav. Co.	2	2	0
Fowle, J. F.	5	0	0
Gradwell, W.	10	6	
Hodgson & Sons	1	1	0
Little & Co.	2	2	0
Smith, J. T.	2	2	0
Strongitharne, A. H.	1	1	0
Westray, Copeland, and Co.	10	6	
Worrall, F.	10	6	
Total	12	6	6

Donations.

Amateur Dramatic Society	30	0	0
Armagh Crew	1	0	6
Apollo Crew	1	9	0
Ariadne Crew	1	3	6
Hoole, Mr.	1	0	0
Manxman Crew	17	8	
Scully, F.	2	10	0
Life-boat Boxes	1	2	10
Total Dons.	39	3	6
Total Subs.	12	6	6
	£51	10	0

ROCHDALE BRANCH

Honorary Secretary—
ROBT. TAYLOR HEAPE, Esq.

Annual Subscriptions.

Ashworth, Wm. Esq.	1	1	0
Ashworth, Miss	1	1	0
Barlow, Edwd. Esq.	1	1	0
Barrett, Joseph, Esq.	1	1	0
Brierley, James, Esq.	1	1	0
Brierley, Adrm. Esq.	1	1	0
Bright, J. A. Esq.	1	1	0
Bright, Thomas, Esq.	1	1	0
Chadwick, G. T. Esq.	1	1	0
Chadwick, Hector, Esq.	1	1	0
Clegg, E. A. Esq.	1	1	0
Coupe, Mrs.	1	1	0
Crowther, Frank, Esq.	1	1	0
Davenport, J. M. Esq.	1	1	0
Dearden, J. G. Esq.	1	1	0
Dimmock, Jas. Esq.	1	1	0
Entwisle, J. B. N. Esq.	1	1	0

	£.	s.	d.
Grundy, John, Esq.	1	1	0
Haigh, J. W. Esq.	1	1	0
Heap, James, Esq.	1	1	0
Heap, Joshua, Esq.	1	1	0
Heape, R. T. Esq.	1	1	0
Heape, R. T. Jun. Esq.	1	1	0
Heginbottom, Mrs.	1	1	0
Holt, W. C. Esq.	10	6	
Hoyle, Mrs. James	10	6	
Hurst, Richard, Esq.	1	1	0
Hurst, Wm. Esq.	1	1	0
Jackson, Robert, Esq.	1	1	0
Jewison, R. S. Esq.	1	1	0
Kay, E. G. Esq.	1	1	0
Kay, Miss	1	1	0
Kemp, Mrs.	2	2	0
King, Mrs.	10	6	
King, W. H. Esq.	10	6	
Knight, Mrs.	1	1	0
Lancashire, J. H. Esq.	1	1	0
Leach, Robert, Esq.	1	1	0
Leech, Robert, Esq.	10	6	
Littlewood, J. S. Esq.	1	1	0
Lord, James, Esq.	1	1	0
Lord, T. K. Esq.	1	1	0
Moore, J. E. Esq.	1	1	0
Newall, Henry, Esq.	1	1	0
Openshaw, J. H. Esq.	1	1	0
Ormerod, Wm. Esq.	1	1	0
Petrie, George, Esq.	1	1	0
Petrie, J. E. Esq.	1	1	0
Petrie, John, Esq.	1	1	0
Petrie, Mrs. James	1	1	0
Pilling, Edwin, Esq.	1	1	0
Pilling, John, Esq.	1	1	0
Philippi, F. T. Esq.	1	1	0
Radcliffe, James, Esq.	1	1	0
Robinson, John, Esq.	1	1	0
Robinson, Philip H. Esq.	1	1	0
Robinson, Rich. Esq.	1	1	0
Robinson, Salkeld, Esq.	1	1	0
Rochdale Equitable Pioneers' Society	1	1	0
Royds, A. H. Esq.	1	1	0
Royds, C. M. Esq.	1	1	0
Royds, E. A. N. Esq.	1	1	0
Schofield, Captain	1	1	0
Schofield, G. W. Esq.	1	1	0
Schofield, Mrs. Jos.	1	1	0
Schofield, Robert	1	1	0
Shaw, William, Esq.	1	1	0
Shawcross, Leonard, Esq.	1	1	0
Shepherd, John, Esq.	1	1	0
Smithson, Thos. Esq.	1	1	0
Standing, John, Esq.	1	1	0
Tatham, John, Esq.	1	1	0
Watson, Thos. Esq.	1	1	0
Whittaker, Chas. Esq.	1	1	0
Whittaker, Geo. Esq.	1	1	0
Willans, T. E. Esq.	1	1	0
Wood, Joseph, Esq.	1	1	0
Wrigley, Fred. Esq.	1	1	0
Wrigley, Miss	1	1	0
Wrigley, Oswald, Esq.	1	1	0
Total	£82	8	6

ST. ANNE'S BRANCH.

Chairman—
JOHN GREENHALGH, Esq.

Hon. Secretary—
W. A. LLOYD.

Donations.

A Friend by Dr. Pountney	10	6	
Clifton, J. T.	2	2	0
Dearden, James	1	1	0
Ellerbach, Joseph	1	1	0
Fair, Thomas	10	6	
Freeman, R. Knill	1	1	0
Greenhalgh, John, Esq. Chairman	5	5	0

BRANCHES—LIST OF ANNUAL SUBSCRIPTIONS AND DONATIONS. 583

	£.	s.	d.
Hargreaves, Robert.	1	0	0
Lomax, Mr. J. F.	3	4	
Maxwell, James	1	0	0
Porritt, W. J.	1	0	0
Pomfret, Wm.	1	0	0
Terry, Rev. W. G.			
Vicar	1	0	0
Thompson, John	1	0	0
Half Collections made at Parish Church, per Rev. W. G. Terry, Vicar	5	0	0
Cash from Box	1	3	0
	<u>£24</u>	<u>3</u>	<u>4</u>

SOUTHPORT BRANCH.

President—
The Rt. Hon. EARL LATHOM.
Chairman—
SAML. BOOTHROYD, Esq. J.P.
Honorary Secretary—
J. A. ROBINSON, Esq.

Annual Subscriptions.

Acton, Mrs.			
Atkinson, John, Esq., J.P.	1	1	0
*Atkinson, W. Esq., J.P.	1	1	0
Banning, J. J. Esq.	1	1	0
Bellhouse, W. Esq.	1	1	0
*Boothroyd, Samuel, Esq., J.P.	2	2	0
Bradbury, Mrs.	1	1	0
Bromilow, Mrs.			
Buckley, R. Esq.			
Buckley, Mrs.	1	1	0
Chadwick, Mrs.	10	0	0
Cheetham, B. Esq.	1	1	0
Clarke, Rev. B.S., D.D.	10	6	
Cornwell, Dr. John	10	6	
Cross, Rev. T. H.	5	0	
Darwell, Mrs.	10	6	
Fernley, Wm. Esq.	1	1	0
Fornshaw, Mrs.	1	1	0
Garton, Miss	1	1	0
Geddes, Miss	1	1	0
Geldert, Mrs. Chas.	1	1	0
Glover, Isaac, Esq.	10	6	
Glover, James, Esq., J.P.	1	1	0
Gregory, H. L. Esq., J.P.	1	1	0
Halliday, J. W. Esq. (the late)	1	1	0
Halliday, Misses	1	1	0
Heap, Robert, Esq.	1	1	0
Heaton, Miss	1	1	0
Hesketh, Col. J.P.	1	1	0
Hordern, J. L. Esq., J.P.	1	1	0
Knowles, Mrs.	1	1	0
Knowles, Miss	1	1	0
Lancashire and Yorkshire Railway Co.	3	3	0
*Lathom, The Earl	5	0	0
Lea, Mrs. S.	1	1	0
Litton, Wm. Esq.	1	1	0
Macrae, Misses	1	1	0
Mason, Henry, Esq. (the late)	1	1	0
*Mathwin, Henry, Esq., B.A.	1	1	0
Mawdsley, Mrs.	1	1	0
Mocatta, E. Esq. (the late)	1	1	0
Mottram, J. Esq.	1	1	0
*Nicholson, R. Esq., J.P.	1	1	0
Sharpe, Misses	10	0	0
*Smith, W. Esq., J.P.	1	1	0
Stead, J. F. Esq., J.P.	1	1	0
Stephenson, T. R. Esq., J.P.	1	1	0
Storey, Mrs.	1	1	0
*Swire, S. Esq., J.P.	1	1	0

*Sutcliffe, Rev. T. J.P.	1	1	0
Thomas, W. Esq., M.D., J.P.	1	1	0
Thorniley, G. H. Esq., J.P.	1	1	0
West, Mrs.	1	1	0
*Wood, James, Esq., J.P.	1	1	0
Wood, P. F. Esq.	1	1	0
Total	£7	19	6
<i>Donations.</i>			
Pillar, and Boat-House Boxes	6	7	7
Total Dons	6	7	7
Total Subs	£7	19	6
	£64	7	1

Leicestershire.

LEICESTER BRANCH.

Chairman—
W. H. WALKER, Esq.
Treasurer—
T. T. PAGER, Esq., M.P.
Honorary Secretaries—
WILLIAM GREEN, Esq.
FRANK HODGES, Esq.

Annual Subscriptions.

	£.	s.	d.
Allen, Mr. Joseph	5	0	0
Atkins Bros. Messrs.	5	0	0
Baines, Messrs. Geo. and Sons	10	6	
Baines, John & Sons, Messrs.	10	6	
Barrs, Mr. J. H.	5	0	0
Bellairs, Major	5	0	0
Blunt, Dr.	10	6	
Bowmar, Mr. C.	10	6	
Bowmar, Mr. W.	1	1	0
Brookhouse, Miss	5	0	0
Brown, Jno. & Sons, Messrs.	5	0	0
*Burfield, Rev. Canon Burgess, Mr. A.	1	1	0
*Burgess, Mr. A. H.	5	0	0
Burgess, Mr. Josh.	1	1	0
Burnaby, Maj.-Gen. M.P.	5	0	0
Burnaby, Mrs.	5	0	0
Burnaby, Mr. A. E.	5	0	0
Burnaby, Miss H. L.	5	0	0
Charlesworth, Mr. T. G.	5	0	0
Church, Mr. W. H.	10	6	
Clarke, Mrs. J. C.	1	1	0
*Clephan, Mr. E.	10	6	
Colls, Mrs. Thomas (Edgbaston)	1	1	0
Coltman, Mr. T.	5	0	0
Cook, Mrs. John, London	1	1	0
Cooper, Mr. J. H.	10	6	
Cort & Paul, Messrs.	10	6	
Crow, Mr. J.	5	0	0
Davis, Mr. S. (Hinckley)	10	6	
Dicks, Mr. Wm.	10	6	
Ellis, Mrs. A.	10	6	
Ellis, Mrs. E. S.	1	1	0
Ellis, Mr. G. H.	1	1	0
C. Ellis and Everard, Messrs.	10	6	
Else, Mr. A.	10	6	
Everard, Mr. W.	5	0	0
France, Mr. E.	5	0	0
Gilson, Mr. H. T.	1	1	0
Gimson, Mrs. Josiah	10	6	
Goddard, Mr. J. W.	5	0	0

Goddard, Mr. Josh.	10	6	
Goodchild, Mrs. (Rotherby)	1	1	0
Goodchild, Mstr. T. P. (Rotherby)	5	0	0
Green, Messrs. John and Co.	5	0	0
*Green, Mr. W.	1	1	0
Hall, Mr. J.	5	0	0
Hamel, Mr. A. J.	1	1	0
Harrison and Sons, Messrs. T.	5	0	0
Hart & Levy, Messrs.	10	6	
Haxby, Mr. J. B.	10	6	
*Hewitt, Mr. F.	10	6	
Hodges, Mr. J. E.	1	1	0
*Hodges, Mr. F.	1	1	0
Hodges, Mr. G. H.	1	1	0
Howcutt, Mr. John	10	6	
Hutchinson, Mr. W. E.	1	1	0
Ingram, Mr. Thomas	10	6	
Interest from Bankers	14	10	
Interest on borough loan	3	18	3
John of Gaunt Lodge of Freemasons	1	1	0
Johnson, Mr. J.	10	6	
Johnson, Mr. T. F.	1	1	0
Jones, Messrs. T. & J.	10	6	
Kemp, Messrs. E. & Son	10	6	
*Kempson, Mr. W.	1	1	0
*Lanckester, Mr. H.	10	6	
Leicester Butchers' Association, The	1	1	0
Leicester Fishmonger's Assoc., The	1	1	0
Livens, Mrs. F.	10	6	
McAlpin, Mr. J. W.	10	6	
Morley and Sons, Messrs. R.	10	6	
Norman, Mr. T.	10	6	
*Odames, Mr. S.	10	6	
Paget, Mr. Alfred	1	1	0
*Paget, Mr. T. T., M.P.	1	1	0
Panter, Mr. Alfred	10	6	
Parry, Mr. H. H.	10	6	
Pochin, Rev. E. N.	2	2	0
Ptacek, Mr. F.	10	6	
Raven, Mr. W.	5	0	0
Roberts, Mr. J. D.	10	6	
Sewell, Mrs.	10	6	
Shaw, George, M.D.	1	1	0
*Sidley, Mr. C. M.	10	6	
Simonds, Mr. B. W.	5	0	0
Smith, Mr. C.	1	1	0
Smith, Mrs. Conyer	5	0	0
Snow and Bennett, Messrs.	1	1	0
*Stanyon, Mr. W.	1	1	0
Stimson, Mr. W.	1	1	0
Stretton, Messrs. C. and A.	10	6	
Stretton & Hutchinson, Messrs.	10	6	
Thorp, Messrs. J. & G.	5	0	0
Turner, Mr. Luke	1	1	0
Vickers, Mrs. S.	5	0	0
Walker, Mr. R.	10	6	
*Walker, Mr. W. H.	1	1	0
Webster, Mr. Thos.	10	6	
West, Mr. W.	5	0	0
Whitmore, Mr. Jno.	1	1	0
Williams, Mr. J. H.	10	6	
Wright & Sons, Messrs. M.	10	6	
Yeomanson, Mr. W.	5	0	0
Sums under 5s.	5	0	0
	69	6	7

Donations.

Collected at Free Library	1	10	0
Collected at Pillar Box	3	18	5
Collected in Box at Rutland House, Leicester	13	6	
Total	£74	0	4

Lincolnshire.

LINCOLNSHIRE SHIPWRECK ASSOCIATION BRANCH.

Treasurer—
WILLIAM GARFIT, Esq.
Joint Honorary Secretaries—
Rev. R. W. GRACROFT and
Rev. E. RAWNSLEY.

Annual Subscriptions.

	£.	s.	d.
Ainslie, Rev. Robert	1	1	0
Alington, Geo., Esq.	1	1	0
*Alington, Rev. John	1	1	0
Alleyby, S. Esq.	1	0	0
Allott, Rev. J.	1	1	0
Armcoats, Col. C.	1	1	0
Armstrong, Capt.	10	6	
Aubertin, E. Esq.	1	1	0
Aveland, Rt. Hon. Ld.	5	0	0
Bellamy, Mr.	10	6	
Bentley, W. Esq.	1	1	0
Bethlehem Hospital, Governors of	5	5	0
Bird, Mrs.	1	1	0
Booth, Mrs.	1	1	0
Boucheret, Miss	1	1	0
Bradshaw, R. Esq.	1	0	0
*Brooks, Rd. Esq.	10	0	0
Brownlow, Earl	20	0	0
Cheales, Rev. H.	1	0	0
Cherrington, Mr. R.	10	6	
Cholmeley, S. Esq.	1	1	6
Clarke, Mr. C.	5	0	0
Clayton, N. Esq.	2	2	0
Clitheroe, R. Esq.	10	0	0
*Coltman, Rev. Geo.	1	1	0
*Coltman, R. P. Esq.	1	1	0
Conington, Rev. Jno.	1	1	0
*Cracroft, Rev. Robt.	1	1	0
Cross, Rev. J. E.	1	1	0
Cussons, Mr. D.	10	0	0
Cussons, Mr. J.	10	6	
Cussons, Mr. W.	1	1	0
Dallas-Yorke, T. Esq.	1	1	0
Davy, J. Esq.	10	6	
Dixon, Miss	1	1	0
Drax, J. S. W. S. Esq.	2	2	0
Edmunds, Mrs.	1	1	0
Elmhirst, Genl.	1	1	0
Eve, Mr. T.	10	0	0
*Everington, W. Esq.	1	1	0
Franklin, Rev. J.	1	1	0
Garfit, Claypons, and Garfit, Messrs.	4	4	0
Grantham, Col.	1	1	0
Hamilton, Lady M.	2	2	0
Handsley, S. Esq.	10	0	0
Harrison, J. Esq.	10	0	0
Harrison, R. Esq.	19	0	0
Harrowby, Earl of	2	2	0
*Heanley, J. Esq.	1	1	0
Heanley, Mr. Marshall	5	0	0
Heneage, W. Esq.	1	1	0
Hewson, Mr. J.	5	0	0
Higgins, J. Esq.	10	6	
Holloway, Captain C.	1	1	0
Holloway, H. Esq.	1	1	0
Holloway, J. G. Esq.	1	1	0
Holloway, Miss	1	1	0
Hopkinson, Rev. W.	1	1	0
Hurrell, S. Esq.	1	1	0
Inglby, Sir H. D. Bart.	2	0	0
Jackson, Howard, Esq.	2	2	0
Kennedy, Rev. L. D.	1	1	0
Langton, Bennet, Esq.	2	2	0
Lister, J. Esq.	1	0	0
Lister, J. S. Esq.	1	1	0
Lister, Rev. J. M.	1	1	0
Lister, Rev. T.	1	1	0
Maddison, J. W. Esq.	1	1	0
Magdalen College, Oxford, President and Fellows of	3	3	0

Mason, J. Esq.	1	0
Mason, Miss	10	0
Maasingberd, C. L. Esq.	1	1
Maasingberd, Rev. W. O.	1	1
Monson, Lord	1	0
Monson, Hon. and Rev. E.	1	1
Mundy, C. J. H. Esq.	1	0
*Mundy, C. M. Esq.	5	0
Middleton, R. Esq.	1	0
Neville, George, Esq.	1	0
Owen, Rev. Henry	10	0
Palmer, Rev. E.	10	0
*Parker, Rev. Richd.	1	0
Parker, Wm. Esq.	2	2
Pickford, Rev. F.	1	0
Pretyman, Rev. Fred.	1	0
Price, Potter, Walker, and Co. Messrs.	2	2
Rainey, Dr.	1	0
Rawnsley, P. Esq.	1	0
*Rawnsley, Rev. D.	1	0
*Rawnsley, Rev. Edw.	1	0
Reynardson, C. B. Esq.	1	0
Ripon, Marquis of ..	2	0
Robinson, J. N. Esq.	10	0
Sale, Rev. T.	1	0
Scarborough, Earl of ..	2	2
Seaton, Mr.	2	6
Sibthorp, C. W. Esq.	3	0
Sibthorp, M. W. Esq.	1	0
Sibthorp, Miss Waldo ..	2	2
Sibthorp, Mrs. Waldo ..	1	0
Sladen, Rev. E.	10	6
Smith, Mr. S.	10	6
Smith, Ellison, and Co.	2	0
Smyth, W. H. Esq.	1	0
Stanhope, the Hon. E. M.P.	2	2
Stanhope, J. B. Esq.	2	2
Staniland, M. Esq.	1	0
Starmer, Chas. Esq.	1	0
Sutton, Rev. R.	2	2
Swan, J. & R. Esqs.	1	0
Thimbleby, T. Esq.	1	0
Travers, Rev. J. B.	1	0
Turner, Rev. C.	1	0
Turner, E. Esq. M.P.	1	0
Tweed, F. W. Esq.	10	6
Uppley, G. C. Esq.	1	0
Vessey, J. H. Esq.	1	0
Vyner, H. C. Esq.	2	0
Vyner, Rev. W. P.	1	0
Waite, Rev. J. D.	10	6
Walker, G. Esq.	10	6
Walls, Rev. R. G.	1	0
Ward, Rev. G.	10	6
West, Mr.	10	6
Whitfield, E. W. Esq.	1	0
White, F. T. Esq.	1	0
Whitworth, Rev. T.	10	0
Williamson, Mr.	10	6
Willoughby d'Eresby, Baroness	5	0
Willson, Mr. J.	1	0
Wilson, Mr.	1	0
Wilson, Mr. J.	5	0
Wingate, Mrs.	10	0
Winn, R. Esq. M.P.	2	2
Yarbro, Earl	2	2
Total	179	14

LOUTH BRANCH

Allison, T. F. Esq.	10	0
Allison, Wm. Esq.	10	0
Bell, Dr.	10	0
Bourne, Mrs.	10	0
Bowmar, C. Esq.	1	0
Cartwright, S. Esq.	1	0
Cusworth, Mr. J.	5	0
Emeris, W. R. Esq.	1	0
Eve and Ranshaw, Messrs.	1	0
Hurst, Mr. John	5	0
Hyde, W. Esq.	10	0
Locock, E. Esq.	10	0

Marsden, Mr. F. D.	5	0
Nell, Mr.	10	0
Parker, Mr. J.	5	0
Sharpley, T. Esq. M.D.	1	0
Smith, C. G. Esq.	10	0
Symmons, Mrs.	5	0
Tupholme, Mr. J.	5	0
Wilde, Rev. A.	1	0
Total	11	14

Donation.		
Lister, Miss	10	0
Total	£201	8

BOSTON BRANCH.

J. H. GARBIT, Esq., Steward.

Annual Subscriptions.		
Allen, Mr. Thompson ..	10	6
Allen, John & Co.	10	6
Balles, W. H. Esq.	10	6
Baker, Mr. J. H.	10	6
Barton, Mr. W.	10	6
Bedford, W.	10	6
Blenkin, Rev. G. B.	1	0
Bothamley, Mr. H.	5	0
Buck, Mr. S. James	5	0
Buxton, S. C. Esq.	2	0
Caudwell, J. Esq.	1	0
Chambers, Mr. J.	5	0
Conington, Mrs. R.	1	0
Cooper, Mr. M.	5	0
Crafcroft, Mrs. J.	10	0
Daulton, Mr. L.	10	6
Dodds, Mrs.	1	0
Dyer, B. B. Esq.	10	6
Gask, John, Esq.	10	0
Hartley, H. W. Esq.	1	0
Harwood, H. Esq.	10	6
Harwood, R. J.	10	6
Hildred, Mr. G.	10	6
Holdsworth, W. H. Esq.	1	0
Horry, Mr. W.	10	0
Hutson, Mr. W. G.	5	0
Holland, Rev. C. D.	10	0
Holland, C. G. Esq.	10	0
Ingram, W. J. Esq.	1	0
Jackson, Mrs. S. and M. A.	10	6
Jebb, J. J. Esq.	1	0
Johnson, W. W. & Sons	10	6
Kenington, John, Esq.	5	0
J.P.	5	0
Kitwood, Thos. Esq.	10	6
Malcolm, J. W. Esq.	10	0
Martin, George, Esq.	10	6
Millington, R. W. Esq.	10	6
Nelsey, the Misses ..	10	6
Oldrid, Mrs.	1	0
Oldrid, Rev. J. H.	10	6
Pattenden, Rev. Dr.	1	0
Pearson, The Misses ..	10	0
Pilcher, J. W. Esq. J.P.	10	6
Pilley, Mr. Samuel ..	10	6
Rainey, A. Esq.	10	6
Rawling, Mr. R. C.	5	0
Raymond, Cuthbert, Esq.	1	0
Rice, Mrs. Charles	1	0
Rice, Joseph, Esq.	2	0
Rowland, J. W. Esq.	10	0
Rowley, G. Fydel, Esq.	10	0
Roy, Rev. R. E.	10	0
Sharp, C. H. Esq.	5	0
Sharp, J. W. Esq.	10	6
Sherwin, Samuel, Esq., J.P.	10	6
Simonds, J. C. & Son ..	1	0
Skinner, Charles, and Son	10	6
Small, J. H. & Son	10	6
Smith, Captain	1	0
Stainton, W. Esq.	10	6

Stamford, Spalding, and Boston Banking Company	5	5
Staniland, R. W. Esq.	1	0
Storr, Mrs.	10	6
Swain, C. F. Esq.	10	6
Swain, R. H. Esq.	10	6
Thomas, J. H. & Son ..	10	6
Thomas, G. W. Esq.	1	0
Thompson, Mr. John ..	5	0
Thorns, Son & Mawson ..	1	0
Thorpe, Mr. T. W.	10	6
Tunnard, Mrs.	1	0
Tunnard, C. T. Esq.	1	0
Tuxford, J. E. Esq.	1	0
M.D.	1	0
Walker, The Misses ..	1	0
Ward, Mr. John	10	6
West, John, Esq.	1	0
Wiglesworth, P. Esq.	10	6
Wise, George, Esq.	10	6
Wood, Mr. W. H.	10	6
Wren, J. Esq.	1	0
Wright, C. T. & H. T.	1	0
Yeatman, C. Esq.	1	0
Total	£59	12

GLETHORPES BRANCH.

The Countess of YARBOROUGH.

Chairman—		
A. W. T. GRANT-THOROLD, Esq.		
Honorary Secretary—		
F. C. DAWSON, Esq.		
Annual Subscriptions.		
*Bannister, Mr. Ald., J.P.	1	0
*Chapman, J. Esq.	1	0
*Charlton, T. Esq.	1	0
*Grant-Thorold, A. W. T. Esq., J.P.	2	2
Heneage, E. Esq., M.P.	1	0
Jones, Rev. W. P.	1	0
*Josse, Henri, Esq.	1	0
Manchester, Sheffield, and Lincolnshire Railway Company ..	5	5
Marshall and Atkinson, Messrs.	1	0
Mason, R. Esq.	10	0
Moody, Walker, Esq.	10	6
Mudd, H. Esq.	10	0
*Oates, Thos. Esq.	1	0
*Seddon, P. K. Esq.	2	2
J.P.	2	2
Total	19	7

Donations.		
Barnsley, S. S.	6	11
Boathouse	1	16
Clethorpes Station ..	17	0
Custom House	17	0
Grimsby Station	9	11
Huddersfield, S. S.	10	6
Sheffield do.	14	4
Small sums	—	7
Total	£26	0

Strettoncheshire.

ABERDOVEY BRANCH.

Chairman—		
J. WEBSTER, Esq.		
Honorary Secretary—		
Dr. F. H. V. GOSHOLZ.		
Annual Subscriptions.		
Coney, Major B. (the late), in memoriam ..	1	1
Corbett, J. Esq. M.P.	1	1
Corbett, Mrs.	1	1
Dunlop, A. M. Esq.	1	1
*Griffiths, Rev. John, Rector of Merthyr ..	10	6
*Grostolz, Dr.	10	6
Holland, S. Esq., M.P.	1	1
Hurt, Miss F.	15	0
Jones, J. H. Esq.	10	0
Lewis, M. L. Esq.	10	0
Lucas, Rev.	10	0
Morris, Colonel	1	1
Pochin, Miss.	1	0
Price, Capt. C. K.	10	0
Stewart, Colonel	1	0
Tamberlain, J. Ll. Esq.	10	0
Thruston, C. F. Esq.	1	1
*Webster, J. Esq.	10	0
Williams, Rev. E. O.	10	0
Wynne, W. R. M. Esq.	1	0
Sums under 5s.	18	0
Total	16	11

Donations.

Corbett, J. Esq. M.P.	1	1
Ruck, L. Esq.	10	0
Sums under 10s.	1	0
Total Dons.	2	11
Total Subs.	16	11
Total	£19	2

BARMOUTH BRANCH.

Chairman—		
J. R. DAVIES, Esq.		
Honorary Secretary—		
Mr. JOHN JENKINS, H.M.'s Customs.		
Annual Subscriptions.		
Beale, W. J. Esq.	1	1
Davis & Sons, Messrs.	5	5
*Davies, J. R. Esq.	10	0
Holland, S. Esq., M.P.	1	1
Jones, Rev. J.	10	0
Jones, Wm. Esq.	1	1
Lloyd, Miss	1	0
*Morris, Mr. W. J.	10	0
*Owen, R. P. Esq.	5	0
*Richards, Capt. R.D.	10	0
Ricketts, Miss.	1	1
*Talbot, G. Q.P. Esq.	1	1
Talbot, Mrs.	2	2
Thomas, L. H. Esq.	1	0
*Wayne, R. S. Esq.	10	0
Sums under 5s.	5	0
Total	17	12

Donations.

Barmouth Hotel Box ..	3	4
Corsygedal Hotel Box ..	3	5
Pillar Box	8	19
Rent of old Boathouse	2	0
Total Dons.	11	6
Total Subs.	17	12
Total	£28	18

BRANCHES—LIST OF ANNUAL SUBSCRIPTIONS AND DONATIONS. 585

Norfolk.

NORFOLK BRANCH.

Honorary Secretary—
F. O. TAYLOR, Esq., Norwich.

Annual Subscriptions.

	£.	s.	d.
Albemarle, Rt. Hon.			
Earl of	1	0	0
Andrew, Rev. W. W.	1	1	0
Bagge, Richard, Esq.	2	2	0
Bailey, Rev. John	1	1	0
Barclay, J. G. Esq.	2	2	0
Baxter, Jas. Esq.	1	1	0
Bayning, Lady	4	4	0
Bennett, Edwd. Esq.	10	0	0
Bensly, W. T. Esq.			
L.L.D.	1	1	0
Bentlnck, G. W. P.			
Esq., M.P.	2	2	0
Birkbeck, Hen. Esq.	2	0	0
Blake, Henry, Esq.	1	1	0
Blake, Mrs. C. Jex.	1	1	0
Buxton, C. Louis, Esq.	1	0	0
Buxton, Geoffrey, Esq.	5	0	0
Carey, Joseph Henry,			
Esq.	2	0	0
Chamberlin, G. M.			
Esq.	1	1	0
Choimondeley, The			
Marquis of	2	0	0
Cooper, Geo. H. Esq.	1	1	0
Corbett, Admiral J.	1	0	0
Cubitt, Major	1	0	0
Fairymple, Mrs.	1	1	0
Dolphin, Rev. John	1	0	0
Dowson and Son,			
Messrs.	2	2	0
Edwards, Rev. B.	1	1	0
Elwin, Hastings, Esq.	1	0	0
Fletcher, B. E. Esq.	1	1	0
Fountaine, Miss	2	2	0
Fryer, W. B. Esq.	1	1	0
George, Mr. T. W.	5	0	0
Goulburn, Very Rev.			
E. M., D.D., Dean	2	2	0
of Norwich	2	2	0
Gunton, Rev. J.	1	1	0
Gurdon, B. Esq.	2	2	0
Hamond, R. N. Esq.	1	0	0
Harmer, F. W. Esq.	1	1	0
Harvard, S. Esq.	1	1	0
Heavyside, Rev. Canon	1	1	0
Hindes, Francis, Esq.	1	1	0
Holmes, Mrs.	1	1	0
Humfrey, R. Blake,			
Esq.	1	1	0
Irby, Mrs. Isabella H.	2	2	0
Jones, Sir W. Bart.	2	2	0
Keppel, Hon. & Rev.			
E. S.	1	1	0
Keppel, Rev. W. A. W.	1	1	0
Lacon, Sir E. H. K.			
Bart. M.P.	1	1	0
L'Estrange, W. R.			
Esq.	1	0	0
Lothian, The Mar-			
chioness Constance	2	2	0
Lucas, George, Esq.	1	1	0
Lucas, Rev. R. G.	1	0	0
Marsh, Rev. W. H.	1	1	0
Marsham, Rev. H. P.	1	1	0
Matchett and Co.			
Messrs.	1	1	0
Mealing and Mills,			
Messrs.	1	1	0
Nevill, Rev. Canon	1	1	0
Nisbet, Rev. Canon	1	1	0
Norwich, the Hon. &			
Right Rev. the			
Bishop of	2	2	0
Nugent, Sir G. Bart.	2	0	0
Parmeter, R. W. Esq.	1	1	0
Preston, Isaac, Esq.	1	1	0
Preston, Miss Ellen	2	0	0
Preston, Miss Sophia	2	0	0
Preston, Sir J. H.,			
Bart.	2	0	0

Ripley, Rev. W. N.	2	2	0
Springfield, G.O. Esq.	1	1	0
Stafford, Rt. Hon. the			
Lord	2	2	0
Steward, Patteson &			
Co. Messrs.	1	1	0
Taylor, F. O. Esq.			
Hon. Secretary ...	1	1	0
Taylor, J. O. H.			
Esq.	1	1	0
Thorn, C. Esq.	10	0	0
Tillett, J. H. Esq.	1	1	0
Trafford, E. W. Esq.	2	2	0
Tuck, C. E. Esq.	1	1	0
Upcher, H. R. Esq.	2	2	0
Watson, John Ferris,			
Esq.	1	1	0
Wild, Edward, Esq.	1	0	0
Wodehouse, Mrs. C.	2	2	0
Total	112	14	0

Donations.

Bircham, F. S. Esq.	10	0	0
Buxton, S. Gurney,			
Esq.	5	0	0
France, Rev. G.—Of-			
ferty at Brock-			
dish Church	1	0	0
North, Charles, Esq.	1	0	0
Collected in box at			
Old Bank Buildings	7	3	
Interest on Banking			
Account	10	1	
Total Dons. &c.	8	7	4
Total Subs.	112	14	0
£121	1	4	

BLAKENEY BRANCH.

Treasurer and Honorary
Secretary—
Rev. R. H. TILLARD, M.A.

	£.	s.	d.
<i>Annual Subscriptions.</i>			
Townshend, Marquis	2	0	0
Birkbeck, Edward,			
Esq., M.P.	5	5	0
Boulnois, E. Esq.	5	0	0
Breton, Rev. E. B.	1	1	0
Brumell, Rev. E.	10	6	0
Buck, W. Esq.	5	0	0
Burroughes, T. H. Esq.	5	0	0
Cooke, Mr. Robins.	1	0	0
Fenwick, Rev. J.	10	0	0
Hardy, W. H. C. Esq.	1	1	0
Hudson, George, Esq.	1	1	0
Jodrell, Mrs.	1	1	0
Marsham, Rev. T.	5	0	0
Page, M. F. Esq.	1	1	0
Pearson, J. Esq.	10	0	0
Purdy, W. Esq.	10	0	0
Tillard, Rev. R. H.	1	1	0
Total	£17	11	6

BRANCASTER BRANCH.

President—
The Earl of OXFORD.

Chairman—
SIMMS REEVE, Esq.

Honorary Secretaries—
Rev. E. K. KERSLAKE.
E. DEWING, Esq.

Annual Subscriptions.

Bircham, Mr. B.	1	1	0
Bird, S. Esq.	10	0	0
Bowman, Rev.	5	0	0
Calver, Mr. Henry	10	6	0
Cook, Mr. Dennis	10	6	0

Cook, Mr. Henry	10	6	0
Curson, Mr. Samuel	1	0	0
Everitt, Mr. Thomas	5	0	0
Green, Mr. John	10	0	0
Hare, Rev. H.	10	6	0
Hoste, Miss	1	1	0
Jickling, Mr. F. A.	10	0	0
*Kerslake, Rev. E. K.	1	1	0
*Lane, Mr. Thos. Sen.	10	0	0
Levien, Rev. J.	1	1	0
Mack, Mr. Thos. T.	10	0	0
Noel, Rev. A. W.	1	0	0
Orford, Earl of	10	0	0
Overman, Mr. John	10	6	0
Oxley, Mr. George	1	0	0
Porritt, Mr. Wm. L.	1	1	0
*Press, Mr. Wm.	10	6	0
*Reeve, Simms, Esq.	2	2	0
Riches, Mr. Michael	5	0	0
Ringer, Mr. Alfred	1	0	0
Savory, Mr. John	1	1	0
Seymour, Mrs.	1	1	0
*Sharpe, Mr. Samuel	10	0	0
Simpkinson, Rev.	1	1	0
Wiseman, Mr. George	1	0	0
Sums under 5s.	10	0	0
Total	£42	9	0

CROMER BRANCH.

Chairman—
Right Hon. LORD SUFFIELD.

Honorary Secretary—
Mr. W. G. SANDFORD.

Annual Subscriptions.

Barclay, K. H. Esq.	1	1	0
Birkbeck, Edward,			
Esq., M.P.	5	5	0
Breese, Mr. George	5	0	0
Buxton, Sir T. F.	2	2	0
Buxton, The Dowager			
Lady	2	2	0
Buxton, T. Fowell,			
Esq.	2	2	0
Cabbell, Mrs. Bond	1	1	0
Fitch, The Rev. F.	10	6	0
Fitch, The Misses	5	0	0
Gurney, J. E. Esq.	1	1	0
Hansell, P. H. Esq.	10	0	0
Hoare, Joseph, Esq.	2	2	0
Hoare, Samuel, Esq.	2	2	0
Rudge, Miss	10	0	0
Rust, Mr. Benj.	5	0	0
Sandford, G. W. Esq.			
(London)	10	0	0
Suffield, the Rt. Hon.			
Lord	2	2	0
Sums under 5s.	17	6	0
Subscription boxes	1	19	6
Total	£26	12	6

Donations.

Beare, A. P. Esq.	25	0	0
Worsley, P. Esq.	10	0	0
£52	2	6	

HASBOROUGH BRANCH.

President—
R. S. BAKER, Esq.

Honorary Secretary—
Rev. J. SLATER, M.A.

Annual Subscriptions.

*Baker, R. S. Esq.	2	0	0
Birkbeck, Edward,			
Esq., M.P.	5	5	0
*Faulke, Mr.	5	0	0
Frarey, Mrs. T. H.	10	6	0
Lernit, Rev. Dr.	1	1	0

Morgan, Messrs.	1	0	0
*Selly, Mr.	5	0	0
Shepherd, Mrs.	1	1	0
*Slater, Rev. J.	1	0	0
Wenn, Wm. Esq.	1	0	0
Wilkinson, Mrs.	1	1	0

Total

HUNSTANTON BRANCH.

President—
H. LE STRANGE, Esq.

Honorary Secretary—
Rev. A. WALLER.

Annual Subscriptions.

Ainslie, Miss	10	0	0
Beckett, Rev. W. T.	1	1	0
Beckett, Miss	5	0	0
Bellamy, Rev. Dr.	1	1	0
Brand, J. Esq.	1	1	0
Brand, Miss	1	1	0
Brand, Miss Janet	1	1	0
Burgis, Mr. R.	5	0	0
Collins, G. D. Esq.	1	0	0
Curson, Mr. R.	10	0	0
Davy, Mrs.	1	1	0
Dawbarn, G. Esq. J.P.	1	1	0
Dawbarn, Richard W.			
Esq.	1	1	0
Dawbarn, Robert,			
Esq. J.P.	1	1	0
*Dodman, Mr. M.	1	1	0
English Brothers	1	1	0
*Ewen, Rev. E.	10	0	0
Eyre & Co. Messrs.	1	1	0
Fenwick, C. H. Esq.	3	3	0
Gates, H. P. Esq.	1	1	0
Gurney & Co. Messrs.	2	2	0
Howard, Miss	10	6	0
Howard, Miss C. M.	10	6	0
Howlett, Miss	10	0	0
*Hunn, Mr. J. W.	1	2	0
Jarvis, Sir L. W.	1	1	0
Kitton, Mr. T. B.	1	1	0
Lambert, Messrs. J.			
and J.	10	0	0
Lambert, Mrs. John	5	0	0
*Le Strange, Hamon,			
Esq.	3	3	0
Lovejoy, A. Esq.	10	6	0
Lyde, Ames, Captain	1	1	0
Margetts, Mr. H.	5	0	0
Oliver, L. Esq.	10	0	0
Peele, G. T. Esq.	1	0	0
Robertson, Mr. J. W.	7	6	0
Rolfe, E. N. Esq.	2	2	0
Rolfe, Miss N.	10	0	0
Sharpe, Mrs. J.	5	0	0
Skelton, E. D. Esq.	1	0	0
Thew, J. D. Esq.	10	0	0
Thompson, Rev. G. T.	10	0	0
Wales, Mr. C.	10	0	0
Wales, Mrs. S.	10	0	0
*Waller, Rev. A.	1	0	0
Wells, R. Esq.	10	0	0
Wharton, Mr. L.	10	0	0
Whitmore, G. Esq.	1	1	0
Whitty, Dr.	5	0	0
Wilson, Mr. J.	10	0	0
Worsley, Rev. Dr.	1	1	0
Total	44	18	0

KING'S LYNN BRANCH.

Treasurer—
F. J. CRESSWELL, Esq.
Honorary Secretary—
Mr. WILLIAM HITCHCOCK.

Annual Subscriptions.	
£.	s. d.
Archer, T. G. Esq.	10 0
Bagge, T. E. Esq.	1 0
Bird, Mr. J. M.	10 0
Blencowe, Misses	1 0
Boon, Mr. W. D.	5 0
Bray, Mr. John	5 0
Coldham, H. J. Esq.	1 0
Coulton, Miss	10 0
Cresswell, F. J. Esq.	1 0
Dickinson, Rev. W. W.	1 0
Durrant, E. E. Esq.	10 0
Everard, R. C. F. Esq.	1 0
Everard, Miss	1 0
Freeman, J. Esq.	1 0
Fuller, Mr. Robert	5 0
Green, Mr. Edmund	10 0
Groom, John, Esq.	10 0
Groom, Mr. J. E.	5 0
Gurney, John, Esq.	5 0
Gurney, S. A. Esq.	1 0
Hoff, Mr. W. G.	10 0
Hogge, Miss Fanny	5 0
Horsley, Mr. J. H.	5 0
Household, Mr. R. B.	1 0
Laws, Mrs. Sarah	2 0
Mariott, Mr. T. B.	5 0
Marshall, Mr. S. N.	5 0
Mills, Mr. G. W.	5 0
Patrick, J. Esq.	5 0
Philcox, Mr. George	5 0
Queensberry, Dowager	
Marchioness of	2 0
Robinson, Mr. C. T.	5 0
Saunders, A. Esq.	5 0
Stevenson, Mr. T. S.	5 0
Thompson, Patrick,	
and Woodwork	1 0
Thornon, H. J. Esq.	10 0
Vynne, Mr. R.	10 0
Ward, David, Esq.	10 0
Wigg, Mr. W. C.	5 0
Wilkin, T. M. Esq.	5 0
Winfield, S. H. Esq.	5 0
Total	29 13 0

Donations.	
Cresswell, F. J. Esq.	
Boat	8 0
Bank do.	1 4 0
Messrs. Laws and	
Co.'s do.	1 1 0
Total Dona.	2 13 0
Total Subs.	29 13 0
	£32 6 0

MUNDESLEY BRANCH.

Honorary Secretary—
Mr. G. GORDON.

Annual Subscriptions.	
Athill, Mrs.	5 0
Atkinson, C. Esq.	1 0 0
Barnard, Bishop, and	
Barnard	5 0
Belding, Mr. W.	5 0
Bennett and Hill	5 0
Blacklock, Archden.	7 0
Blanchflower, J. Esq.	10 0
Bonser, Mr.	5 0
Brown, Mr. H.	5 0
Caley, Mr. A. J.	5 0
Caley, Mr. W.	5 0
Chamberlin, Mr.	5 0
Chamberlin and Sons	10 0

£	s.	d.
Chapman, Miss	5	0
Collyer, Col.	2	0
Cooper, R. Esq.	5	0
*Cooper, Rev.	10	0
Copeman, John & Son,		
Messrs.	5	0
Cubitt, Mr. C.	5	0
Cubitt, Mr. G.	5	0
Denny, Mr. E. T.	5	0
Fitch, Mr. J.	5	0
*Flavell, T. Esq.	1	1 0
Freeman, Mr. F., and		
brother	5	0
Gilham, Mr. S.	5	0
*Gordon, Mr. G.	1	0
Gordon, Miss M.	1	0
Green & Wright	10	0
Gregory, Mr. F.	5	0
Gwyn, Rev.	5	0
Horsfield, Mr.	5	0
Hurn, Mr. D.	5	0
Jarrold, Messrs.	5	0
Juniper, Mr. R.	10	0
Ladyman, Mr. H.	10	0
Lake, Mr. W.	5	0
Livock, Mr.	5	0
Marston, Mr.	10	0
Morris, Capt.	10	0
Muriel, C. E. Esq.	10	0
Norgate and Son.	5	0
*Pain, Mr.	5	0
Petre, J. B. Esq.	2	0
Porrett, Mr. J. B.	5	0
*Purdy, Mr.	5	0
Rackham and Sons	5	0
Randell, F. and H.	5	0
Ray, Mr.	5	0
*Robinson, H. Esq.	1	1 0
Rudd, Ash, Esq.	5	0
Samuel, Mr.	5	0
Seaman, Grimmer,		
and Co.	5	0
Shepherd, J. Esq.	5	0
Silley, A. Esq.	10	6 0
Smith, Mr. G.	5	0
Smith and Sons.	10	0
Steward, J. Esq.	10	0
Steward, Patterson,		
and Co.	10	0
Taylor, Rev. A.	5	0
Tipping, Mr.	5	0
Wild, Mr. E.	5	0
Willett, Mr. H.	5	0
Willis and Southall	10	0
Wrench, C. E. Esq.	5	0
Total	26	19 6

Donations.	
Jephson, Mrs.	1 0 0
Sums under 5s.	1 6 0
Box at L. B. House	5 2
Total	£29 10 8

PALLING BRANCH.

Honorary Secretary—
Mr. E. FRENCH,
Chief Officer of Coastguard.

Annual Subscription.	
Birkbeck, Edward,	
Esq., M.P.	5 5 0
Ready, Rev. Hy.	1 0 0

Donations.	
Palling Life-boatmen	2 0 0
Total	8 5 0

SHERINGHAM BRANCH.

Chairman—
HENRY R. UPHAM, Esq.
Honorary Secretary—
Rev. L. MOORE, M.A.

Annual Subscriptions.	
£.	s. d.
Barclay-Gurney, Esq.	5 0 0
Birkbeck, Edward,	
Esq.	5 5 0
Buxton, Sir Fowell	2 2 0
*Cremet, T. W. Esq.	1 0 0
Fraser, Mrs.	5 0 0
Hoare, Joseph, Esq.	1 1 0
Hoare, Samuel, Esq.	1 1 0
Wilson, Rev. Roland	1 0 0
	21 9 0

WELLS BRANCH.

Patron and President—
The Right Hon.
The EARL OF LICHFIELD.

Annual Subscriptions.	
*Bellett, Lieut. E. T.	10 0
Birkbeck, Edward,	
Esq., M.P.	5 5 0
Bullard & Son	2 2 0
Bygott, —, Esq.	10 0
Chad, J. Scott, Esq.	1 0 0
Crisp, R. S.	1 0 0
*Dewing, Herbert,	
Esq.	5 0
Doggett, J. R. Esq.	10 0
Dugmore, J. Esq.	1 1 0
England, R. Esq., J.P.	10 0
*Everitt, G. Esq.	5 0
*Foot, Dr.	10 0
Gurney & Co. Messrs.	2 0 0
Hudson, Wm. Esq.	5 0
Jones, Rev. H.	1 0 0
Lacon, Sir E. Bart.	3 0 0
Letcher, Earl of	5 0 0
Loynes, E. B.	5 0 0
*Rump, Hugh R. Esq.	1 0 0
*Mack, J.	5 0
Mariott, Messrs. J.	
and R.	1 1 0
*Middleton, C. Esq.	10 0
Middleton, E. P. Esq.	10 0
Pilling, Rev. J. R.	1 0 0
Rippingall, Miss	1 0 0
Shellabear, S. Esq.	1 0 0
Smith, Messrs. F. & G.	2 2 0
*Southgate, F. B.	5 0
Warner, H. Lee, Esq.	1 0 0
Sums under 5s.	10 0
	£35 1 0

WINTERTON BRANCH.

Honorary Secretary—
Rev. W. GREEN, M.A.

Annual Subscriptions.	
Birkbeck, Edward,	
Esq., M.P.	10 10 0
Copeman, Mrs.	1 0 0
*Green, Rev. W.	1 1 0
*Harden, Rev. H. W.	10 0
Mrs. Hume	2 2 0
*Lucaa, Rev. Charles	2 2 0
Waters, Wm. Esq.	10 0
Total	£17 15 0

GREAT YARMOUTH AND CAISTER BRANCH.

Chairman—
Wm. WORSHP, Esq.
Honorary Secretaries—
Rev. E. G. H. MURRELL, M.A.
Mr. JOHN PETTS.

Annual Subscriptions.	
£.	s. d.
*Aldred, C. C. Esq.	10 6
Arnold Brothers,	
Messrs.	10 6
Barge, S. Esq.	5 0
Biddlecomb and	
Bening, Messrs.	1 1 0
Birkbeck, Edward,	
Esq., M.P.	5 5 0
Bostock, E. Esq.	5 0
Beeching Brothers	2 2 0
*Bracey, John, Esq.	10 6
Bebee, J. W.	5 0
Burroughs, T. E. Esq.	1 1 0
Breton, J. B. Esq.	
Q.C.	1 1 0
Buxton, H. E. Esq.	1 0 0
Cachpole, Mrs. M. A.	1 1 0
Carr, George, Esq.	10 0
Chamberlin and Co.	
Messrs.	1 1 0
Clowes, John, Esq.	1 1 0
*Clowes, J. E. Esq.	10 6
Coleman, Mr.	5 0
Curry, D. A. Esq.	10 6
Diver, O. Esq.	10 6
Edwards, Mrs.	2 2 0
Edwards, John	10 0
*Fellows, J. H. Esq.	10 6
Ferrer & Co.	10 6
Goodman, J., R.I.P.	10 6
Garratt, E. Esq.	10 6
Gurney & a Banker	2 2 0
Itemau, Charles	5 0
Lacon, Youell & Co.	1 1 0
Leach, John	10 6
Lee, John, Esq.	10 6
Livingstone, S. Esq.	1 1 0
Paigrove, R.A.I. Esq.	10 6
*Petts, John	10 6
Saul & Son, Messrs.	1 1 0
Shales, W. W. Esq.	10 6
Shingles, G. Esq.	10 6
*Steward, T. B. Esq.	10 6
Sutton, J. Esq.	10 6
Taylor, J. Esq.	1 1 0
*Venable, Rev. G.	10 6
Walpole, R.H.V. Esq.	1 1 0
Walpole, Mrs.	1 1 0
Watling, A. Esq.	2 2 0
Wild, Baker, & Co.	5 0
*Woolverton, C. Esq.	10 6
*Worship, Wm. Esq.	1 1 0
Youell, Mrs. E.	10 6
Sums under 5s.	2 6
Total	£41 19 0

Donations.	
Captain Thorp, Offi-	
cers and Crew of	
Trinity steamer	
Beacon	1 18 0
Cotton, Mr. and Mrs.	14 9
Cricket Club, Mr.	
Bartlett	5 0
Keith Circus, Per-	
formance given at	12 10 0
Mitchell, Miss	5 0
Service at Caister	
Church, Rev. E. G.	
H. Mursell	1 0 0
Turrell and Talkin-	
sen, Messrs.	3 6 0
Wigg, W. S.	5 0
Railway and Pier	
Pillar Boxes	3 9 5

BRANCHES—LIST OF ANNUAL SUBSCRIPTIONS AND DONATIONS. 587

	£.	s.	d.
Boxes at Public Places.....	4	19	10
Do. Life-boat House 28 15 5			
<i>Legacy.</i>			
Mrs. Jay (the late).....	19	19	0
Total Dons.....	77	7	5
Total Subs.....	41	19	0
	£119	6	5

Northamptonshire.

NORTHAMPTON BRANCH.

Chairman—
Rev. S J. W. SANDERS, M.A.
Treasurer—
A. KEMPSON, Esq.
Collector—
Mr. E. LAW.

Annual Subscriptions.

	£.	s.	d.
Aris, Mr. Thos.	1	1	0
Barry, Mr. Jas.	1	0	0
Becke, Mr. John	10	0	0
Blencowe, Mr. C.	1	0	0
Boémé, Mr. M. A.	5	0	0
Boétock, Mr. F.	10	0	0
Chandler, Mr. H. P.	10	0	0
Grafton, Duke of	1	0	0
Hesleden, Mr. B.	5	0	0
Hill, Mr. W.	1	0	0
Jeffery, Mr. W.	10	0	0
Kempson, Mr. A.	1	0	0
Kenning, Mr. Chas.	1	1	0
Law, Mr. E. F.	10	6	0
Law, Mr. W. A.	5	0	0
Osborn, Mr. Geo.	5	0	0
Osborn, Mr. Thos.	5	0	0
Page, Mr. Alfred	5	0	0
Peirce, Mr. W. J.	5	0	0
Perry, Mr. P. P.	5	0	0
Phippe, Mr. John	10	0	0
Phippe, Mr. P., M.P.	1	0	0
Phippe, Mr. W.	10	0	0
Portal, Mr. W. T.	1	0	0
Robinson, Mr. J.	10	0	0
Rust, Mr. B.	10	0	0
Sanders, Rev. S. J. W.	1	0	0
Saull & Son, Messrs.	5	0	0
Scriven, Mr. Thos.	5	0	0
Sheffield, Mr. D.	10	6	0
Shipman, Mr. Luke.	2	2	0
Shipman, Mr. W.	1	1	0
Shoosmith, Mr. W.	10	0	0
Stanton, Mr. J. U.	5	0	0
Turner Bros., Messrs.	10	0	0
Vernon, Mr. J. M.	5	0	0
Wilson, Mr. John	5	0	0
Total	£22	13	0

Northumberland.

ALNMOUTH BRANCH.

Chairman—
Rev. E. L. MARRERT, Vicar.
Honorary Secretary—
Major H. SMITH.

Annual Subscriptions.

	£.	s.	d.
Northumberland, The Duke of	2	0	0
Armstrong, Sir W. G.			
Kt. C.B.	1	1	0
Blair, Mr. H. Hunter	5	0	0
Browne, A. H. Esq.	1	0	0
Browne, Major	1	0	0
Burrell, Bryan, Esq.	10	0	0
Buston, R. Esq.	10	0	0
*Cadogan, C. H. Esq.	1	0	0
Chrip, L. C. Esq.	1	0	0
Cooke, Miss.	10	0	0
Crewe, Lord, Trusts. of	1	1	0
*Dickson, W. Esq.	1	1	0
Granville, Lady C.	1	1	0
*Gray, John, Esq.	10	0	0
Grey, Lt.-Col. Alfred	1	0	0
Hindmarsh, W. T. Esq.	1	0	0
Jones, Mrs.	10	0	0
Lisle, Mrs.	1	0	0
*Marrett, Rev. E. L.	1	1	0
Maule, Mr.	5	0	0
*Moore, Rev. David	10	0	0
Paynter, H. W. Esq.	5	0	0
*Pease, J. Esq.	2	2	0
Percy, Earl	1	0	0
Purvis, Mr. H. T.	10	0	0
Richardson, Mr. G.	5	0	0
Riddell, Sir W. B. Bt.	2	2	0
Robertson, Mr. T.	5	0	0
Shillottle Colliery, Lessees of.	10	0	0
Simpson, Mrs. Anne	10	0	0
*Smith, Henry	1	0	0
Stephenson, W.	5	0	0
*Strother, Wm. Esq.	5	0	0
Tate, G. Esq.	10	0	0
*Tate, John, Esq.	10	0	0
Tate, T. Esq.	10	0	0
Thew, Arthur H. Esq.	10	0	0
Wilkinson, Capt. J. F.	10	6	0
Total	£29	4	6

BERWICK BRANCH.

Chairman—
Rev. C. BALDWIN, Vicar.
Honorary Secretary—
B. G. SINCLAIR, Esq.

Annual Subscriptions.

	£.	s.	d.
*Agent, Shipwrecked Mariners' Society.	1	1	6
Allan Bros. Messrs.	5	0	0
Allan, Thomas, Esq.	5	0	0
Askew, Watson, Esq.	1	0	0
Berwick Salmon Fisheries Company	1	0	0
*Bolam, B. G. Esq.	10	0	0
Border Brewery Co.	10	6	0
*Cabill, Dr. F.	5	0	0
Clay and Son.	5	0	0
*Crossman & Paulin	1	0	0
Darling, Thomas, Esq.	5	0	0
Dodds, R. Esq.	5	0	0
Fleming, L. T. & J.	10	0	0
*Forbes, Capt. R.N.	10	0	0
Forster, Capt. James	1	1	0
Harbour Commissioners.	2	2	0
Innes, J. H. Esq.	10	6	0
Johnston, Thos. Esq.	1	0	0
Lowrey, A. R. Esq. J.P.	10	0	0
*Norman, Capt.	10	0	0

	£.	s.	d.
Paxton and Purves	5	0	0
Purves, James D. Esq.	10	0	0
*Richardson, Dr. R.N.	10	0	0
Riddell, Mrs. W. E.	5	0	0
Robertson, A. Esq. J.F.	10	0	0
*Rutter, Rev. Evan.	5	0	0
*Sanderson, S. Esq.	10	0	0
*Sinclair, B. G. Esq.	5	0	0
Thompson, A. Esq.	5	0	0
King, Rev. Mr.	5	0	0
Vicar, The.	5	0	0
Woods & Co. Bankers	1	1	0
Sums under 5s.	1	15	0
Total	19	17	6

Donations.

	£.	s.	d.
Amateur Theatrical Performance, per H. Macfarlane, Esq.	5	0	0
Collecting-box at Custom House	5	14	0
Do. at Boat-house	4	10	0
Total Dons.....	10	18	10
Total Subs.....	19	17	6
	£30	16	4

BLYTH BRANCH.

Chairman—
JOHN DENT, Esq.
Honorary Secretary—
Mr. JAMES DARLING.

Donations.

	£.	s.	d.
Arkless, Bell, & Co.	10	0	0
Cole, John	5	0	0
Darling, James	10	0	0
*Dawson, George R.	10	0	0
Dent & Co.	10	0	0
*Dent, John	10	0	0
Dixon, John	5	0	0
Dromgoole, Rev. P. O.	5	0	0
Eccles, Thomas	10	0	0
Gray, Robert, & Co.	10	6	0
*Hedley, John	1	0	0
*Hodgson, Joseph	10	0	0
*Hodgson, Richard	10	0	0
Keenlyside, Jacob	5	0	0
*Laws, John	10	0	0
Lund, G.	5	0	0
Lynn, J. R. D.	5	0	0
Ridley, Sir M. W. Bt.	5	0	0
Robinson, Edw. A.	5	0	0
Robinson, William.	5	0	0
Saunders & Co.	10	0	0
Sidney & Son	10	0	0
*Smith, Thomas A.	5	0	0
*Smith, William R.	10	0	0
Trustees Thornton & Croft Estates, per William Gough.	2	2	0
*Ward, Dr. G.	10	0	0
Ward, William M.	5	0	0
Watts, Ward, & Co. (London)	5	5	0
Whitehead & Son.	5	0	0
*Wood, James	5	0	0
Sums under 5s.	4	18	6
Total	£28	6	0

BOULMER BRANCH.

Chairman—
JOHN CRASTER, Esq.
Honorary Secretary—
Rev. L. J. STEPHENS, M.A.

Annual Subscriptions.

	£.	s.	d.
Northumberland, The Duke of	2	0	0
Browne, A. H. Esq.	1	1	0
Grey, The Earl.	2	0	0

	£.	s.	d.
Grey, Sir G. Bart.			
M.P.	1	0	0
Tankerville, Earl of.	1	0	0
Percy, Earl, M.P.	1	0	0
Allgood, Hunter, Esq.	1	0	0
Bosanquet, C. B. P. Esq.	1	1	0
Brown, Rev. Dixon.	1	0	0
*Brown, Robert, Esq.	10	0	0
Burrell, Bryan, Esq.	10	0	0
Collinson, Mr.	10	0	0
*Craster, John, Esq.	10	0	0
*Dodds, Mr.	10	0	0
Grey, Mr. James.	10	0	0
Horsley, Mr. John.	5	0	0
Lombard, Mrs.	3	0	0
Ronaldson, James T. Esq.	10	0	0
Sanderson, Mr.	5	0	0
Smith, Mr. Mark, The executors of the late	5	0	0
*Stephens, Rev. L. J.	10	0	0
Tate, John, Esq.	10	0	0
Thorpe, Mrs.	10	0	0
Yeaman, Mr.	5	0	0
Total	£20	2	0

CRESSWELL BRANCH.

Chairman—
Rev. J. E. LEEFE, M.A.
Honorary Secretary—
Mr. THOS. BOLTON.

	£.	s.	d.
Baker-Cresswell, Maj. O. C.	5	0	0
Cresswell, Francis, Esq.	1	0	0
Hodson, Mr. Wm.	10	0	0
*Leeffe, Rev. J. E.	1	0	0
Matheson, Mr. Thos.	5	0	0
Slater, Mrs. Jane.	10	0	0
Total	£8	5	0

HAUXLEY BRANCH.

Chairman—
S. F. WIDDINGTON, Esq.
Honorary Secretary—
Rev. A. O. MEDD.

Annual Subscriptions.

	£.	s.	d.
Northumberland, His Grace the Duke of	2	0	0
Atkinson, G. C.			
Wilson, Esq.	1	0	0
Browne, General.	1	1	0
Carr, Rev. T. W.	1	1	0
*Cutterbuck, T. Esq.	1	1	0
Currie, Dr.	10	0	0
*Dand, M. H. Esq.	1	1	0
*Dand, Robert, Esq.	10	6	0
*Dand, James, Esq.	10	0	0
*Dand, Rev. J. J.	10	0	0
*Dunn, Rev. J. W.	10	6	0
*Forster, Col.	1	1	0
Forster, Miss F.	10	0	0
*Hiderton, Rev. Thos.	1	0	0
Maling, C. Esq.	1	1	0
*Thomson, Rev. G. S.	1	0	0
Warkworth Harbour, Commissioners of.	10	0	0
*Widdington, S. F. Esq.	2	2	0
Sums under 5s.	14	0	0
Total	£27	3	0

HOLY ISLAND BRANCH.

Chairman— ROBERT CROSSMAN, Esq.

Honorary Secretary— Rev. W. W. F. KEELING.

Annual Subscriptions.

Table listing annual subscriptions for Holy Island Branch, including names like Armstrong, Sir W. G., Bart., Askew, Watson, Esq., and Wilson, Mrs. R. A., with amounts in £, s., d.

£14 1 6

NEWBIGGIN BRANCH.

Chairman—

JAMES EDWARDS, Esq.

Honorary Secretary—

*Rev. E. SHORTT, M.A.

Woodhorn Vicarage.

Annual Subscriptions.

Table listing annual subscriptions for Newbiggin Branch, including names like Davidson, A. Esq., Dent, Mrs. Hedley, and Parker, Thos. Esq., with amounts in £, s., d.

Total.....£15 6 6

NEWCASTLE, TYNE-MOUTH, & CULLERCOATS BRANCH.

Vice-Patrons—

Rt. Hon. EARL RAVENSWORTH.

Right Hon. LORD HASTINGS.

W. B. BRADY, Esq. M.P.

Chairman—

HUGH TAYLOR, Esq.

Treasurer—

Hon. Sec. at Tynewmouth—

P. J. MESSENT, Esq. C.E.

Hon. Sec. at Cullercoats—

Major WILLIAM ADAMSON.

Annual Subscriptions.

Table listing annual subscriptions for Newcastle, Tyne-mouth, & Cullercoats Branch, including names like Northumberland, His Grace the Duke of, and Adam Brothers & Co., with amounts in £, s., d.

Table listing names and amounts for the Newcastle, Tyne-mouth, & Cullercoats Branch, including Bedlington Coal Co., Benson, W., and others, with amounts in £, s., d.

Table listing names and amounts for the Newcastle, Tyne-mouth, & Cullercoats Branch, including Schlessinger, Davis & Co., and others, with amounts in £, s., d.

Total.....137 7 0

Donations.

Table listing donations for the Newcastle, Tyne-mouth, & Cullercoats Branch, including Box at Central Station, Do. on Pier, and others, with amounts in £, s., d.

£148 17 3

NORTH SUNDERLAND BRANCH.

Chairman—

Rev. Wm. DARNELL.

Honorary Secretary—

Capt. A. MARSHALL.

Annual Subscriptions.

Table listing annual subscriptions for North Sunderland Branch, including Lord Crew's Trustees, Broadbent, L. G., and others, with amounts in £, s., d.

Total.....£42 3 6

Nottinghamshire.

NEWARK BRANCH.

Honorary Secretary—

Mr. E. T. SIMMONS.

Annual Subscriptions.

Table listing annual subscriptions for Newark Branch, including names like Allen, Miss, Castle Gate, col. by, and others, with amounts in £, s., d.

Total.....£25 15 6

COLLINGHAM.

Woolley, Mr. T. S. 1 1 0

NOTTINGHAM BRANCH.

Chairman—

WILLIAM VICKERS, Esq.

Honorary Secretary—

SAMUEL COLLINSON, Esq.

Annual Subscriptions.

Table listing annual subscriptions for Nottingham Branch, including names like Adams, Mr. John, Adlington, W. D., and others, with amounts in £, s., d.

	£.	s.	d.
Edge, J. T. Esq.	1	1	0
Goater, Mr. A.	10	6	
Goldschmidt, E.	10	6	
Gripper, E.	1	1	0
Hardwick, G.	10	6	
Heymann, Mr. A.	1	1	0
Heymann, H. Esq.	1	1	0
Hodgson, Wm. Esq.	10	0	
Hogg, J. T.	10	6	
Hollins and Co.			
Messrs. W.	1	1	0
Hutchinson, Mr.			
Robert 1	0	0	
Jacoby and Co.	1	0	
Kirk, Henry 10	6		
Kulp & Son, Messrs. 1	1	0	
Lottimer and Co.			
Messrs. 2	2	0	
Miller, W. W. 10	6		
Parker and Booth. 1	1	0	
Rayner, Miss. 1	1	0	
Richards, Mr. W. A. 10	6		
Seely, Charles, Esq.			
Jun., M.P. 2	2	0	
Simon, May, and Co. 10	6		
Simpson, Henry & Co. 2	2	0	
Sulley, E. Esq. 2	2	0	
Vickers, Wm. Esq. 1	1	0	
Walker, Messrs. J. and T. 1	1	0	
Wells, Mr. A. 1	1	0	
Whitlock, Mrs. 1	1	0	
Wright, Dr. T. 1	1	0	
Total 37	4	0	

Donations.

Allsopp, W. G. Esq.	10	0	0
Amateur Christy			
Minstrels 50	0	0	
Butler, Mrs. S. 2	2	0	
Kenrick, Geo. Esq. 30	0	0	
Ditto, second don. 50	0	0	
Sulley, E. Esq. 10	0	0	
Ditto, second don. 10	0	0	
199	6	0	

Legacy.

Allsop, W. G. 121	9	1	
£320	15	1	

Oxfordshire.

HENLEY-ON-THAMES BRANCH.

Chairman—
C. LUCKY, Esq.
Honorary Secretary—
A. R. AWBERRY.

Annual Subscriptions.

	£.	s.	d.
Barnett, Mrs.	10	0	
Bennett, J. Esq.	10	6	
Brakspear, W. H. Esq. 1	1	0	
Child, Miss 10	0		
Elwes, Miss. 1	1	0	
Lockey, Miss. 10	6		
Lucey, C. Esq. 1	1	0	
Melvin, Miss. 5	0		
Morgan, F. Esq. 1	1	0	
Noble, J. Esq. 2	0		
Pinckney, Rev. W. P. 1	0		
Schwabe, G. C. Esq. 1	0		
Boxes at Hotels, &c. 1	4	3	
Total £11	14	3	

Donations.

Almack, Rev. Dr. 5	0	0	
Awbery, A. R. 10	0		
£17	4	3	

Hampshire.

FISHGUARD BRANCH.

Chairman—
LEWIS MATHIAS, Esq.
Honorary Secretary—
MR. WILLIAM VAUGHAN.

Annual Subscriptions.

	£.	s.	d.
Aubrey, W. A. L. P.	10	0	
Bland, Mr. G. J. 5	0		
Bowen, Capt. C. 5	0		
Billon, A. Esq. 5	0		
Brettingham, C. Esq. 10	0		
Corbett, Rev. R. 10	0		
Dalton, W. Esq. 5	0		
Davies, W. Esq., M.P. 1	0		
Eaton, Evans, and Williams, Messrs. 10	0		
Emment, Mrs. 10	0		
Evans, E. H. Esq., R.N. 10	0		
Green and John, Messrs. 10	0		
Greenish, Messrs., and Dawkins, 5	0		
James, John, Esq. 10	0		
Hamilton, Lady (3 years) 3	0		
*Harries, H. Ll. Esq., Kensington, Rt.Hon. Lord, M.P. 2	0		
Lanyon, J. C. Esq. 5	0		
Macaulay, J. B. Esq. 1	1	0	
*Mathias, L.ewis, Esq. 1	0		
Mortimer, Rev. T. G. 10	0		
Owens, John, Esq. 5	0		
Powell, G. E. J. Esq. 1	0		
Pritchard, A. Esq. 5	0		
Plumtre, Rev. Mr. 5	0		
Polak, J. M. Esq. 5	0		
Protheroe, Miss Schaw—	10	0	
Roberts, J. Esq. 10	0		
Thomas, A. Esq. 5	0		
*Vaughan, Mr. W. 5	0		
Wilkins & Co. Messrs. (2 years) 1	1	0	
Sums under 5s. 5	9	3	
Collecting Boxes 4	8		
£24	15	11	

Donations.

Phillipps, C.E.G. Esq. 2	0	0	
Sums under 5s. 5	9	9	
£31	3	9	

MILFORD HAVEN BRANCH.

Patron—
The Right Hon. the EARL OF CAWDORE.

President—
Sir J. OWEN SCOURFIELD, Bt.
Chairman—
Admiral J. LORT STOKES.

**Honorary Secretary—
H. PATTISON, Esq.**

Annual Subscriptions.

Allen, H. G. Esq., Q.C. M.P. 1	1	0	
Allen, Lady Catherine 10	0		
Appleby, F. Esq. 5	0		
*Cawdor, Earl of. 2	0		
Clark, F. L. Esq. 5	0		
Davies, Wm. Esq. 1	1	0	
Dawkins, W. Esq. 5	0		
Evans, James Eaton, Esq. 5	0		
Green & John, Messrs. 5	0		
Greenish & Dawkins, Messrs. 5	0		
Griffith, Geo. Esq., J.P. 5	0		
Harries, George, Esq. Ricketstone. 2	0	0	

	£.	s.	d.
Jackson, S. Esq.	5	0	
Jackson, T. Esq.	5	0	
Jones, Rev. E. H.	5	0	
Lake & Co. 1	1	0	
Lambton, Colonel .. 1	0	0	
Lambton, Lady 1	0	0	
Lawton, J. H. S. Esq. 5	0		
Leach, Major. 1	0	0	
McMaster, Thos. Esq. 5	0		
Meyrick, T. C. Esq. 1	1	0	
*Mirehouse, R. W. B. Esq. 1	0	0	
Morgan, Mrs. E. S. 10	0		
Morgan, Miss Alice. 10	0		
Morrison, Dr. 5	0		
Falmer, Mr. T. 5	0		
Farkin, Capt. R.N. 1	0	0	
Phillips, F. Lort, Esq. 10	0		
Roberts, W. R. Esq. 5	0		
Roeh, Nicholas, Esq. 1	0	0	
Saurin, M. A. Esq. 1	0	0	
*Stokes, Admiral 1	0	0	
*Stokes, Colonel. 10	0		
Smedley, Isaac, Esq. 5	0		
Stamper, J. F. Esq. 5	0		
Teasdale, J. H. Esq. 10	0		
Trayler, E. and A. Messrs. 5	0		
Life-boat Boxes			
23	14	0	

Donations.

Phillipps, C.E.G. Esq. 2	0	0	
Sums under 5s. 5	9	9	
£31	3	9	

ST. DAVID'S AND SOLVA BRANCH.

Patron—
Right Rev. Lord Bishop of Sr. DAVID'S

President—
Rev. Canon LEWIS.

Chairman—
EBENEZER REES, Esq., J.P.

Vice-Chairman—
SAMSON WILLIAMS, Esq.

Honorary Secretaries—
W. PROPERT, Esq., LL.D.
SAMSON T. WILLIAMS, Esq.

Annual Subscriptions.

Allen, Rev. Dean ... 1	1	0	
Allen, Miss 1	1	0	
Appleby, Mr. W. 5	0		
Arnold, Mr. W. 5	0		
Bevan, Rev. Canon 1	1	0	
Bickerstaff, Colonel. 1	1	0	
Bishop of St. David's 1	1	0	
Cawdor, Earl. 2	2	0	
Davies, J. Esq. 5	0		
Davies, W. Esq., M.P. 1	1	0	
Foley, F. Esq., M.D. 5	0		
Griffiths, Capt. 5	0		
Harries, G. Esq. 2	0		
Harries, Gilbert D. Esq. 10	6	0	
Hicks, Capt. D. 5	0		
Hicks, H. Esq., M.D. 10	0		
James, P. Esq., M.D. 10	6		
Lewis, Rev. Canon 1	1	0	
Lloyd, Capt. 5	0		
Morgan, C. Esq. 10	6		
Phillips, Rev. J. 10	0		
Propert, Dr. 1	1	0	
Rees, E. Esq. 10	0		
Robinson, E. Esq. 10	0		
Roach, Capt. S. 5	0		
Thomas, Miss 1	1	0	
Williams, Mr. G. O. 5	0		
Williams, J. Esq. 10	0		
Williams, Mr. W. 5	0		
Williams, W. W. Esq. 5	0		
Total £20	7	6	

Donations.

Collecting Boxes at Grove Hotel 5	7		
Do, St. Justinian 6	4		
Sums under 5s. 1	17	1	
£22	16	6	

TENBY BRANCH.

President—
F. D. DYSTER, Esq., M.D.

Chairman—
C. ALLEN, Esq.

Treasurer and Hon. Sec.—
JOHN R. BOWLANDS, Esq.

Annual Subscriptions.

*Allen, Charles, Esq. 1	0	0	
Ash, P. J. Esq. 5	0		
Batye, George, Esq. 10	0		
Brook, Mrs. 5	0		
Brooks, Misses 5	0		
Brook, T.			
Bull, Mrs. 5	0		
Catworthy, A. E. 5	0		
Cox, General. 10	0		
Craddock, J. D. 5	0		
Davies, H. 10	0		
Dunn, N. J. Esq. 10	0		
*Dyster, Dr. 1	0	0	
Elwell, F. Esq. 5	0		
*Evans, Capt. 5	0		
Ferrier, Mrs. 5	0		
Fleet, Mrs. 5	0		
Fritch, W. P., R.A.			
Graham, Mr.			
Gregory, Mr. Joseph			
Hamilton, General. 10	0		
Harries, Miss 10	0		
Harris, Miss Lloyd . 5	0		
Hatchets, —, Esq.			
Hawkesley, J. Esq. 10	0		
Herbert, Rev. H. H. 5	0		
Highmore, Miss 5	0		
Holmes, W. 10	0		
Howell, Miss. 5	0		
Huntington, Rev. G. 5	0		
Hutchinson, Lt.-Col. 5	0		
James, Miss 5	0		
*Jones, Mrs. B. 10	0		
Kemmis, T. 5	0		
*Kentley, A. G.			
K., W. E. C.			
Large, C. F. 5	0		
Lee, Mrs. 5	0		
Lewes, Colonel			
Lloyd, Howard 10	0		
Lock, Mrs. Wm. 5	0		
*London and Provincial Bank 5	0		
Maddy, Mrs. 5	0		
Mar and Kellie, Dowager Countess.			
Mathias, Mr. Thomas 5	0		
Morgan, J. 5	0		
Morley and Sons ... 5	0		
National Provincial Bank. 5	0		
Owen, M. 5	0		
Owen, Peter, Esq. 10	6		
Paget, F.			
Paget, W. B. 1	0	0	
Parkinson, R. J. H. Esq. 10	0		
Power, E. R. Esq. 10	0		
Prothero, T. Esq. 10	0		
Pryse, Sir Pryse			
Rees, William, Esq.			
Richards, W. H. Esq. 5	0		
Smith, E. Jun. 5	0		
Smith, Mrs. C. H.			
Spiller, Misses			
Stevenson, J. P.			
Stone, Mrs. C. 1	0	0	
Story, H. V. 5	0		
Summers, Wm. Esq. 5	0		
Taylor, J. R.			

	£.	s.	d.
Todd, Miss	10	0	0
Traford, Mrs.	5	0	0
Tucker, Miss	-	-	-
Warner, E. H.	-	-	-
Warrick, W. H.	-	-	-
Watters, Miss	-	-	-
Webb, A. H. Com.	-	-	-
R. N.	5	0	0
Wells, Major	5	0	0
Whalley, Thos.	-	-	-
White, W. E.	5	0	0
Wratistlaw, Rev. A. H.	5	0	0
Sums under 5s.	20	9	3
Total	40	9	3

Somersetshire.

BATH BRANCH.

Collector—
Mr. WATERMAN.
Annual Subscriptions.

	£.	s.	d.
Bond, Rev. J.	5	0	0
Breton, Capt. R. N.	10	0	0
Broke, Miss	1	0	0
Brooke, Major-Gen.	5	0	0
Davies, Miss	5	0	0
Dobson, Mrs. Berdett	10	0	0
Dobson, W. Esq.	10	0	0
Doherty, General	5	0	0
Domaeager, Miss	5	0	0
Eden, General	1	1	0
Eden, Mrs.	5	0	0
Evans, Mrs.	5	0	0
Gilmore, Lt.-Col.	5	0	0
Goselin, G. Esq.	5	0	0
Hare, Lt.-Col.	5	0	0
Hickes, C. R. Esq.	5	0	0
Holbourne, Miss	5	0	0
Lawrence, Mrs.	5	0	0
Lean, G. S. Esq.	5	0	0
Little, Mrs. Bartlett	1	1	0
Mundy, General	10	0	0
Orde, Miss	10	0	0
Paynter, Mrs.	10	0	0
Rogers, Miss	5	0	0
Scott, Mrs. Fitzmaurice	10	0	0
Sheppard, Mrs.	5	0	0
Smith, Mrs. Portica	5	0	0
Sprowle, Mrs.	5	0	0
Stanley, Mrs.	5	0	0
Thorn, Lady	5	0	0
Thornton, Mrs.	5	0	0
Warren, The Misses	10	0	0
Whingates, General	5	0	0
Sums under 5s.	115	0	0
Total	£19	7	0

BRIDGWATER AND BURNHAM BRANCH.

President—
The MAYOR OF BRIDGWATER.
Chairman—
J. B. TAWATTES, Esq. J.P.
Honorary Secretary—
BEVERLEY R. MORRIS, Esq. M.D.
Collector—
Mr. J. BAKER.
Annual Subscriptions.

Ash, W. Esq.	1	1	0
Armstrong, Capt.	10	0	0
Bagshot, Edwd. Esq.	2	2	0
Clunie, R. C. Esq.	5	0	0
Corporation of Bridgwater	10	0	0

	£.	s.	d.
Denison, the Ven. Archdeacon	1	1	0
Elton, Sir Arthur, Bt. Clevedon	1	1	0
Harford, Mrs.	2	2	0
Harte, E. Esq.	5	0	0
Hervey, Lord A. C. Bishop of Bath and Wells	2	2	0
Hobbs, S. Esq.	5	0	0
Holt Bros. Messrs.	1	1	0
Knyfton, T. T. Esq. J.P.	1	1	0
Luttrell, Colonel H. A. F., J.P.	1	0	0
Mapleton, Rev. D. W.	1	1	0
Munbee, Gen.	1	0	0
Paget, Major R. H. M.P.	1	1	0
Ritson, C. Esq. J.P.	10	0	0
Spiller & Co. Messrs. Bridgwater	1	1	0
Stephenson, Rev. Prebendary	1	1	0
Thwaites, J. B. Esq. J. P.	10	0	0
Sums under 5s.	2	6	0
Total	£30	2	6

WATCHET BRANCH.

Patrons—
Sir A. A. HOOD, Bart.
G. F. LUTTRELL, Esq.
JOHN HALLIDAY, Esq.
Chairman—
The Rev. R. POOLE,
Vicar of St. Decumans.
Honorary Secretary—
R. J. GIMBLETT, Esq.

	£.	s.	d.
Alben, Mrs. St.	10	0	0
Blommart, J. Esq.	1	0	0
Bosanquet, H. A. Esq.	10	0	0
Copp & Co. Messrs.	5	0	0
Cunningham, Rev. A.	5	0	0
Daniell, Rev. A. H.	1	1	0
Elwea, Rev. E. S.	1	10	0
Escott, Rev. H. Sibeh.	1	0	0
Gimblett, Capt.	10	0	0
Gimblett, Robt. Esq.	10	0	0
Gimblett, Wm. Esq.	5	0	0
Halliday, Jno. Esq.	1	0	0
Hawkes, Thos. Esq.	10	0	0
Heatboote, Rev. S. J.	10	0	0
Hood, Sir A. A. Bt.	2	0	0
*Horne, A. V. Esq.	10	0	0
Luttrell, G. F. Esq.	2	0	0
Luttrell, Rev. A. F.	2	0	0
Luttrell, Mrs. A. H. F.	1	0	0
Martineau, J. P. Esq.	5	0	0
Nichols, Rev. W. L.	10	0	0
Norton Brewery	2	0	0
Notley, M. Esq.	1	0	0
Paramore, Mrs.	5	0	0
*Poole, Rev. R.	1	1	0
Robinson, Henry	10	0	0
Siderin, John, Esq.	5	0	0
Somes, Mrs.	1	1	0
Stanley, E. J. Esq.	1	1	0
*Stoate and Sons, Messrs.	1	0	0
*Thorne and Son, Messrs.	10	0	0
Vernon, Rev. J. R.	10	0	0
Wansbrough and Brooke, Messrs.	2	2	0
*White, W. H. Esq.	5	0	0
Williams, J. W. Esq.	5	0	0
Sums under 5s.	15	0	0
Total	34	16	0

Donations.
Battersby, W. Esq. 1 0 0
Bland, Mrs. 5 0 0

	£.	s.	d.
Collins, W. J. Esq.	10	0	0
Gatchell, Jos. Esq.	10	0	0
Leslee, Miss	5	0	0
Trevelyan, Miss	1	0	0
Total Dons.	3	10	0
Total Subs.	34	16	0
	£38	6	0

WESTON-SUPER-MARE BRANCH.

Honorary Secretary—
W. E. HILLIER, Esq.

Annual Subscriptions.

Armstrong, Mrs. L.	10	0	0
Ash, Wm.	10	0	0
Ash, Henry	10	0	0
Atkins, Mrs.	5	0	0
Baker, S. E. Esq.	5	0	0
Battiscombe, Capt. A.	5	0	0
Birkett, Rev. T.	5	0	0
Blyth, E. H. Esq.	10	0	0
Buckle, Rev. G.	5	0	0
Burdett, Rev. W.	5	0	0
Campbell, Rev. Colin	5	0	0
Cavan, Lord.	5	0	0
Charrington, Miss	5	0	0
Cookson, Colonel	5	0	0
Cuiley, R. S. Esq.	10	0	0
Davidson, General	10	0	0
Drake, J. Esq.	10	0	0
Dunn, Misses	5	0	0
Edwards, Mrs. Owen	5	0	0
Foxwell, T. S., Esq.	5	0	0
Girdlestone, Mrs. C.	5	0	0
Granger, Miss	5	0	0
Hall, Miss	5	0	0
Hart, G. C. B.	5	0	0
Hartley, Mrs.	5	0	0
Hawkes, Mrs.	5	0	0
Hazelwood, Mrs.	5	0	0
Holland, Genl.	5	0	0
Hunt, Rev. W.	5	0	0
Huxtable, Rev. Preb.	5	0	0
Hyde, Misses	5	0	0
Kirkpatrick, Rev. F. Leeston-Smith, Mrs.	10	0	0
McAdam, Miss	5	0	0
Mansford, Miss	5	0	0
Marshall, Miss	10	0	0
Matheson, Mrs. H.	5	0	0
Morton, The Misses	5	0	0
Moore, R.	5	0	0
Mullings, Mrs.	5	0	0
Murley, Mr.	5	0	0
Murray, Mrs.	10	0	0
Newman, Rev. Prof. F. W.	5	0	0
Paterson, A. H. Gen.	5	0	0
Peyton, Mrs.	5	0	0
Phillipson, R.	5	0	0
Phillott, R. Esq.	5	0	0
Poole, J. Ruscombe, Esq.	5	0	0
Poole, Miss	10	0	0
Pruen, Mrs. G. A.	5	0	0
Rossiter, E.	10	0	0
Rossiter, G. F.	5	0	0
Smith, Miss, Grey-stone	5	0	0
Smith, Rev. T.	5	0	0
Stayner, The Misses	5	0	0
T. Miss, 3 Park Villas	5	0	0
Tulloch, Mrs.	5	0	0
Theobald, Surgeon-General	5	0	0
Tomkins, Rev. H. G.	5	0	0
Tomkins, W. S.	5	0	0
Wilson, Miss	5	0	0
Wood, Mrs. Stenson	5	0	0
Woodsman, Mrs.	5	0	0
Sums under 5s.	9	15	3
Total	25	10	3

Donations.
Trinity Church, Collected after Sermon, by Rev. W. Hunt 48 15 0

Total Dons.	48	15	0
Total Subs.	26	10	3
	£74	5	3

Staffordshire.

BURTON-ON-TRENT BRANCH.

President—
M. A. BASS, Esq. M.P.
Treasurer and Hon. Sec.—
Mr. E. MADRELY.

Annual Subscriptions.

	£.	s.	d.
Abbotts, R. W.	1	1	0
*Allsopp and Sons	5	0	0
Bass and Co.	10	0	0
*Bass, Abram	1	1	0
Brown, Edwin A.	10	0	0
Cardidge, E.	5	0	0
Deaville, S. R.	10	0	0
Douglas, G. W. & Co.	5	0	0
Drewry, J. & W. J.	1	1	0
Eadie, James	1	1	0
Elliott, R. S.	1	1	0
Evans, William	5	0	0
*Evershed, Sydney	1	1	0
Flint, Mrs.	10	6	0
Goodger, Henry	10	6	0
Gretton, Misses	1	1	0
Hallam, C. M.	5	0	0
Hallam, F.	5	0	0
Harrison, Charles	10	6	0
Hill, Charles & Sons	1	1	0
Howarth, W.	5	0	0
Hunt, William	5	0	0
Ind, Coope, and Co.	5	0	0
Isitt, Benjamin	5	0	0
Jackson, Charles	5	0	0
Jackson, Thomas A.	10	6	0
Lea, H. S.	10	6	0
Lovecock, William	5	0	0
Low, Thos. & Sons	1	1	0
Marshall, William	5	0	0
Marston, John, & Son	5	0	0
Matthews, John	1	1	0
*Morris, John	5	0	0
Mudie, James	10	6	0
Owen, W. C.	5	0	0
Parsons, F. J.	1	1	0
Payne, Mrs.	10	0	0
Ratcliff, Misses	10	6	0
Ratcliff, Robert	1	1	0
Robinson and Co.	2	2	0
Robinson, R.	5	0	0
Salt, Miss	10	6	0
*Salt, Thomas, & Co.	5	0	0
Salt, W. D.	5	0	0
Stanley, C. & W.	1	1	0
Thompson and Son	2	2	0
Thornewill, Mrs.	1	1	0
Thornewill, Rev. C.	10	0	0
Tresise, J. N.	5	0	0
Wardle, William	5	0	0
Warham, Charles	5	0	0
Whitehead, T. N.	10	6	0
Wilson, Mrs.	10	6	0
Woodroffe, Henry	5	0	0
Worsey, F. J.	5	0	0
Worthington & Co.	3	3	0
Wright and Son	1	1	0
Yeomans, John	1	1	0
Sums under 5s.	8	7	6
Total	62	0	6

BRANCHES—LIST OF ANNUAL SUBSCRIPTIONS AND DONATIONS. 591

Donations.	
£.	s. d.
Pillar Box, Recreation Ground.....	19 5
Box, George Hotel... ..	5 0
" White Hart Hotel.....	12 3
Sums under 5s.....	6 1
<hr/>	
Total Dons.....	2 2 9
Total Subs.....	62 0 6
<hr/>	
	264 3 3

LEEK BRANCH.

Annual Subscriptions.	
£.	s. d.
Bradshaw, Mrs., E.	10 6
Brealey, John, Esq.	1 1 0
Brough, Edwin Esq.	1 1 0
Brough, John, Esq.	1 1 0
Brough, Joshua, Esq.	1 1 0
Brough, Wm. S. Esq.	1 1 0
Challinor, Jos. Esq.	4 4 0
Challinor, Wm. Esq.	1 1 0
Cruso, Mrs. A.	1 1 0
Deacon, Rev. G. E.	1 1 0
Goodwin, Stephen, Esq.	1 1 0
Hall, John, Esq.	1 1 0
Heaton, Edwin, Esq.	1 1 0
Johnson, Hy. L. Esq.	1 1 0
Nicholson, Arthur, Esq.	1 1 0
Nicholson, Joshua, Esq.	5 5 0
Nixon, Benj. B. Esq.	1 1 0
Smith, Miss Margt.	1 1 0
Worthington, E. A. Esq.	1 1 0
<hr/>	
Total.....	226 15 6

STAFFORDSHIRE POTTERIES BRANCH.

Annual Subscriptions.	
£.	s. d.
Alcock, John, Esq.	1 1 0
Alcock, Joseph, Esq.	1 1 0
Alcock, Richard, Esq.	1 1 0
Baker, C. G. Esq.	1 1 0
Bates, Gildea and Walker	1 1 0
Bodley, E. F. Esq.	1 1 0
Boote, Messrs. T. and R.	1 1 0
Bostock, Thos. Esq.	10 6
Boulton, Wm.	10 6
Davenport, Hy. Esq.	1 1 0
Davenport, H. T. Esq.	1 1 0
Dean, Arthur	1 1 0
Edge, Stephen	1 1 0
Edge, Malkin, & Co.	1 1 0
Emery, J. P. Esq.	10 6
Emery, Robt. Esq.	10 6
Garlick, G. W. Esq.	1 1 0
Goodwin, George, Esq.	1 1 0
Hulme, Thos. Esq., Endon	10 6

BURSLEM.

Annual Subscriptions.	
£.	s. d.
Alcock, John, Esq.	1 1 0
Alcock, Joseph, Esq.	1 1 0
Alcock, Richard, Esq.	1 1 0
Baker, C. G. Esq.	1 1 0
Bates, Gildea and Walker	1 1 0
Bodley, E. F. Esq.	1 1 0
Boote, Messrs. T. and R.	1 1 0
Bostock, Thos. Esq.	10 6
Boulton, Wm.	10 6
Davenport, Hy. Esq.	1 1 0
Davenport, H. T. Esq.	1 1 0
Dean, Arthur	1 1 0
Edge, Stephen	1 1 0
Edge, Malkin, & Co.	1 1 0
Emery, J. P. Esq.	10 6
Emery, Robt. Esq.	10 6
Garlick, G. W. Esq.	1 1 0
Goodwin, George, Esq.	1 1 0
Hulme, Thos. Esq., Endon	10 6

Annual Subscriptions.	
£.	s. d.
Hulme, Thos. Esq., Wolstanton.....	1 1 0
Maddock, J. and Sons	1 1 0
Parker, Henry, Esq.	1 1 0
Shaw, A. Esq.	1 1 0
Tennant, F. Esq.	1 1 0
Till, T. and Sons.	1 1 0
Vernon, J. & G.	1 1 0
Wood, Edward, Esq.	1 1 0
Wood, Reginald N.	1 1 0
Woodall, Wm. Esq., M.P.	1 1 0
<hr/>	
	27 16 6

HANLEY.

Annual Subscriptions.	
£.	s. d.
Baxter, Edward, Esq.	10 6
Clementson Brothers, Messrs.	1 1 0
Dudson, James, Esq.	1 1 0
Hope, J. and Co. (2 years)	2 2 0
Keeling, Sam. Esq.	1 1 0
Meakin, J. & G.	2 2 0
Narramore, R.E. Esq.	10 6
Ridgway, Sparks, and Ridgway, Messrs.	1 1 0
Sherwin, Robt. Esq.	1 1 0
Stubbs, W.	1 1 0
Walker, J. G. Esq.	1 1 0

LONDON.

Annual Subscriptions.	
£.	s. d.
Adderley, W. A. Esq.	10 6
Allerton and Sons, C.	1 1 0
Asbury, E. Esq.	1 1 0
Aynsley, J. Esq.	1 1 0
Bennion, Geo. Esq.	10 6
Bridgwood and Son, S.	1 1 0
Carrier Bros.	1 1 0
Clarke and Hawley	1 1 0
Copeland and Sons, T. W.	1 1 0
Dale, Page, and Goodwin	1 1 0
Daves, W. J. Esq.	10 6
Glover, C. Esq.	1 1 0
Hawley, Felix, Esq.	1 1 0
Hudden, J. T. Esq.	10 6
Hulse, J. Esq.	1 1 0
Lockett and Co. J.	1 1 0
Mier, Stephen, Esq.	10 6
Kent and Son, John.	10 6
Robinson and Co. W.	1 1 0
Steele and Co.	1 1 0
Stirrup and Pye	1 1 0
Weberley, W. Esq.	1 1 0
Wright, F. S. Esq.	1 1 0
Wileman, W. F. Esq.	10 6

NEWCASTLE.

Annual Subscriptions.	
£.	s. d.
Coghill, H. Esq.	1 1 0
Keeling, Chas. Esq.	1 1 0

TUNSTALL.

Annual Subscriptions.	
£.	s. d.
Beech, James, Esq.	1 1 0
Elsmore, T. & Son.	1 1 0
Ford and Challinor, Messrs	1 1 0
Hollinshead, E. W. Esq.	1 1 0
Turner and Sons, Messrs. G. W.	1 1 0
<hr/>	
Total.....	269 6 0

WOLVERHAMPTON BRANCH.

Annual Subscriptions.	
£.	s. d.
Allen, E. F.	5 0
Anslow, H.	5 0
Armstrong, G.	10 0
Baker and Crockett	1 1 0
Barker, J. W.	5 0
Bate, W. and Henry.	1 1 0
Bayliss, Jones, and Bayliss	1 1 0
Birch, Wm.	5 0
Bissell, W.	1 0 0
Briscoe and Son, W.	5 0
Brotherton, John	10 0
Broughton, B. & Sons	5 0
Burns, Thos.	5 0
Cartwright, S.	1 1 0
Clarke, T. & C. & Co.	10 6
Clarke, Mrs. C. S.	5 0
Colebourne, W. H.	5 0
Coleman, John	5 0
Cooley, W. B.	5 0
Cooper, John.	5 0
Cope, Captain T. B.	10 0
Crane, G. H.	10 0
Davis, E.	5 0
Edwards, W.	10 6
Evans & Son, J.	5 0
Evans, Jas.	5 0
Evart, T. J. M.	5 0
Fisher, Thomas.	10 6
Fleming, Wm.	10 0
Forsyth, J.	10 0
Gibbons, James.	5 0
Graham, Thos.	5 0
Gospel Oak Iron Co.	1 1 0
Gough, Major F.	10 0
Harper, H. G.	1 1 0
Hickman, E.	10 0
Horsman, P.	2 2 0
Hunter, E.	5 0
Ironmonger, M.	10 6
Jenks, Isaac, Esq.	10 0
Jones, Jos.	1 0 0
Langman, Mrs. F.	10 6
Lea, Messrs.	10 0
Lees and Sons, W.	1 1 0
Lee, P. J.	10 0
Loveridge, H. & Co.	1 1 0
*Meanley, George.	5 0
Meynell and Inman.	5 0
Miller, Jos. N.	1 0 0
Mills, Mrs. S.	1 1 0
Moore, Mrs.	1 0 0
Moreton, J. and Co.	1 1 0
Newnham, Dr.	10 0
Owen and Fendelow	1 1 0
Paddy, Hy.	5 0
Peck, Mrs. W.	10 0
Perks, Jno. and Son.	1 1 0
Perry, Capt. T. J.	1 1 0
Plant, W. & J.	5 0
Read & Son	10 0
Reynolds, W. B.	5 0
Riley, John	5 0
Rogers and Sons, H.	1 1 0
Shaw and Son, John	1 1 0
Shelton, R.	10 6
*Skidmore, Thomas.	10 0
*Stewart, John & Son	10 0
Stokes, Miss	1 1 0
*Tatlow, M.	10 0
Thomas, W. Esq.	5 0
Underhill, J. E.	10 0
Walker, R. P.	5 0
Ward, G. Esq.	1 1 0
Waterhouse, Thomas	10 0
Weaver, W. H.	10 0
Wheeler, C.	5 0
Whitehouse, J.	1 1 0
Wilkes, M.	10 0
Wood, H.	5 0
Other Sums	5 0
<hr/>	
Total.....	250 18 0

Suffolk.

ALDBOROUGH AND THORPE BRANCH.

Annual Subscriptions.	
£.	s. d.
Aldboro' Corporation	5 0 0
Attwood, Rev.	1 0 0
Austin, Mrs.	1 1 0
Berners, J. Esq.	5 0 0
Bloomfield, Mrs.	1 1 0
Crampain, Mrs.	1 1 0
Crisp, Miss	10 6
Crisp, Miss E.	10 6
Ferrand, Capt.	1 0 0
Gurney & Co. Messrs.	1 0 0
Harper, G. Esq.	1 0 0
Holland, Rev. E.	2 0 0
Johnson, Miss	5 5 0
Long, Col.	1 1 0
Lynn, Miss	1 0 0
Middleton, Sir G.N.B.	10 0 0
*Ogilvie, A. Esq.	2 10 0
Ogilvie, Mrs.	2 10 0
*Osborne, Mr. J.	10 0
Rope, George, Esq.	1 0 0
Rose, Sir W. Bart.	1 1 0
Rose, Lady	1 1 0
Rowley, Sir C. Bart.	1 0 0
*Thellusson, Col.	1 0 0
Wallace, Sir R. Bart.	10 0 0
Waveney, Lord	1 0 0
Wentworth, F. T. P. Esq.	2 2 0
Wiltshire, R. Esq.	1 1 0
<hr/>	
Total.....	62 5 0

Donations.

Leach, Miss.	1 1 0
Mottey, Rev. Le	10 0 0
Robinson, Mrs.	1 9 0
Smith, Mrs. Wilton.	1 1 0
Smyth, Rev. M. H.	10 0 0
Aldboro Boat House Box	14 7
Aldboro Church, per Rev. H. Thompson	4 16 7
Aldboro Pillar Box	2 17 2
<hr/>	
Total Dons.	12 10 4
Total Subs.	62 5 0
<hr/>	
	274 15 4

DUNWICH BRANCH.

Annual Subscriptions.	
£.	s. d.
Barne, F. Esq.	4 4 0
Barne, Mrs.	2 2 0
Barne, Col., M.P.	4 4 0
Bowater, Lady	1 1 0
Cotton, Miss	1 1 0
Loynes, Miss.	10 6
Noot, Rev. J. F.	10 6
Scrivener, Mrs.	1 1 0
Sotterley Collecting Box	16 6
Boat-house Box	9 0
<hr/>	
Total.....	215 19 6

GORLESTON BRANCH.

Chairman—
Capt. W. G. ALDRICH, R.N.
Honorary Secretary—
J. P. BAUMGARTNER, Esq.

Annual Subscriptions.

£.	s.	d.
*Aldrich, Capt. R.N.	10	0
Bateley, John	5	0
*Baumgartner, J. P.	1	0
*Blake, Arthur Wm.	10	6
*Combe, Ed. H. H.	10	0
Dendy, Mrs.	5	0
Elwin, Hastings	10	0
George, Hy. Harvey	1	0
Hammond, John	5	0
Hewett, Fleming	10	0
Palmer, Garwood	10	0
Salmon, Mrs.	1	0
Tillard, P. E.	1	0
*Tomlinson, Jos.	10	0
*Willis, W. H.	10	0
Total	£8	16 6

IPSWICH BRANCH.

President—
J. C. COBBOLD, Esq.
Vice-President—
F. ALEXANDER, Esq.
Chairman—
E. GRIMWADE, Esq.
Treasurer—

Honorary Secretary—
J. F. TITCHMARSH, Esq.

Annual Subscriptions.

Alexander, E. and Son	10	0
*Alexander, F. Esq.	1	0
Alexander, W. Esq.	10	6
Alexander, S. Esq.	1	0
Anstruther, Col. J. H. L.	1	0
Bantoft, W. Esq.	10	6
Bayley, Messrs. W. and Sons	1	0
Bell, A. Esq.	10	0
Biddell, G. A. Esq.	1	0
Booth, D. H. Esq.	10	6
Brown, W. Esq.	1	0
Burley, D. Esq.	10	0
Byles, Mrs.	1	0
Churchman, H. Esq.	5	0
*Cobbold, J. C. Esq.	2	0
Cobbold, Mrs. J. P.	1	0
Cobbold, T. C. Esq. M.P.	1	0
Colchester, W. Esq.	10	0
Collins, Mr. W. H.	5	0
Cornell and Cornell, Messrs.	5	0
Cuckow, Mr. W.	10	0
Fish, F. Esq.	1	0
Fison, J. O. Esq.	10	0
Fosdick, F. H. Esq.	10	6
Footman, Pretty, and Nicolson, Messrs.	1	0
Goddard, E. Esq.	10	0
Gower, Mrs.	1	0
*Grimwade, E. Esq.	1	0
*Ipswich Journal	5	0
Jeffery, Rev. Alex.	5	0
Josselyn, Miss	5	0
Kemp, Mr. J. O.	5	0
Limmer, Mr. John	5	0
Mason, Admiral	1	0
Maw, S. A. Esq.	1	0
May, John, Esq.	10	0
Miller, Mr. R. M.	10	0
National Provincial Bank, per E. Nicklin, Esq.	10	0

£.	s.	d.
Packard, E. Esq.	1	0
Packard, E., Jun., Esq.	1	0
Paul and Co., Messrs. R.	10	0
Ransome, R. C. Esq.	1	0
Ransomes & Rapier	1	0
Reeve, Mrs.	1	0
Ridley, F. Esq.	10	0
Ridley, Messrs. G. and O.	1	0
Schulen and Boby, Messrs.	10	0
Sims, W. D. Esq.	1	0
Titchmarsh, J. F.	10	0
Turner, Messrs. E. R. and F.	1	0
Turner, Messrs. W. and A. J.	1	0
Tidbury, H. Esq.	10	0
Vulliamy, F. Esq.	1	0
Westhorp, S. Esq.	10	0
Wright, C. Esq.	10	0
Wrinch, Mr. A.	10	0
Total	£41	9 0

Donations.
Fox, Master Walter, Collected by Foresters' and Odd Fellows' Amalgamated Fête Committee, 1880, per Wm. B. Jeffries, Esq. (Total contributions from this Committee, 1867-81, 295 15s.)

Vulliamy, F. Esq.	5	5	0
	1	1	0
Total	£48	0 2	

LOWESTOFT AND PAKEFIELD BRANCH.

Chairman—
J. J. COLMAN, Esq., M.P.
Honorary Secretaries—
FREDERICK MORSE, Esq.
Lowestoft.
W. F. LARKINS, Esq.
Pakefield.
Hon. Superintendent of Life-boats—
Mr. JOHN HENDERSON.
Collector—
Mr. J. E. COOK.

Annual Subscriptions.

Ayerst, Mrs.	10	0
Balls, W. T. Esq.	10	6
Barne, Fred. Esq.	1	0
Basse, Sam. Esq.	1	0
Birbeck, H. Esq.	1	0
Birbeck, Wm. Esq.	1	0
Bradbeer, B. M. Esq.	10	0
Buxton, H. E. Esq.	2	0
Clemence, J. L. Esq.	5	0
Clinbe, W. H. Esq.	10	6
*Colman, J. J. Esq. M.P.	2	0
Crake, Mr. E. F.	10	6
Croft, G. Esq.	1	0
Crossley, Lady	1	0
Crossley, Sir S. Bart.	1	0
Cubitt, Rev. F. W.	1	0
Davey, Miss M.	1	0
*Deny, Rev. R. C.	1	0
Eden, Adm. Henry	1	0
*Edwards, Geo. Esq.	1	0
Everitt, William, Esq.	1	0
Fisher, James, Esq.	5	0
Fiske, Edward B. Esq.	10	6

£.	s.	d.
Fiske, Rev. R. W.	10	6
*Fowler, E. W. Esq.	1	0
Fowler, G. G. Esq.	1	0
Gowing, J. J. W. Esq.	1	0
Gurneys and Co.	2	0
*Harvey, E. K. Esq.	1	0
Henderson, Mr. John	5	0
Howett, Samuel, Esq.	1	0
Hurst, Mrs.	10	0
*Jodrell, Rev. Hy.	10	0
Johnson, Mr. W.	5	0
Johnson, Mrs.	1	0
*Larkins, Capt. W. F.	2	0
*Leathes, Lt.-Col. H. M.	1	0
Lucas, A. G. Esq.	1	0
Lucas, C. T. Esq.	1	0
Lucas, Thomas, Esq.	1	0
Massingham, Capt. R. W.	10	6
*Morse, Frederick, Esq.	1	0
Mummary, E.	5	0
*Peto, James, Esq.	1	0
*Preston, Benj. Esq.	10	6
Preston, Capt. R.N.	10	0
Price, Rev. L.	1	0
*Reeve, Rev. J. F.	1	0
Roddam, Mrs.	1	0
Rounce, J. Esq.	1	0
Seppings, Henry, Esq.	10	6
Spashett, Mr. A.	10	6
Stebbins, Mr. A.	5	0
*Steward, Rev. Chas. J.	1	0
Thirle, Mr. T. E.	5	0
Watson, J. T. Esq.	10	6
*Warman, Wm. Esq.	10	6
Wilkinson, Mrs.	5	0
Wingfield, Mrs.	1	0
Woods, Henry G. Esq.	10	6
Woods, T. R. Esq.	1	0
Worthington, F. S. Esq.	1	0
Worthington, J. C. Esq.	1	0
Worthington, W. C. Esq.	10	6
Wynne, A. S. Esq.	1	0
Youngman, W. Esq.	10	6
Total	£56	14 0

Donations.
Mrs. Marten's Legacy

Collecting Boxes	12	5	4
Total Dons.	22	5 4	
Total Subs.	£56	14 0	
Total	£78	19 4	

SOUTHWOLD BRANCH.

Chairman—
J. L. EWEN, Esq.
Treasurer—
Mr. H. J. DEBNEY.
Honorary Secretary—
Mr. JOHN SINCLAIR.

Annual Subscriptions.

Allen, H. R. Esq.	10	0
Blacket, J., Esq.	1	0
Bosanquet, Miss	1	0
Brook, J. K. Esq.	10	0
Burleigh, R. W. Esq.	10	6
Cautley, Rev. P. L.	10	0
Chester, Colonel	1	0
*Crabtree, Misses	2	0
Crowfoot, Mrs.	1	0
*Debney, Mr. H. J.	10	6
Eeles, Miss	10	0
Ellis, Colonel	1	0
*Ewen, J. L. Esq.	1	0

£.	s.	d.
Ewen, Rev. F.	10	0
Foster, Charles, Esq.	2	0
Gannon, E. M. Esq.	1	0
Gausson, Mrs.	1	0
Girling, R. C. Esq.	10	0
Grubbe, E. W. Esq.	1	0
*Grubbe, J. E. Esq.	2	0
Grubbe, R. Esq.	1	0
Hollad, Rev. E.	2	0
*Marshall, Geo. Esq.	10	0
Marsden, Mrs.	10	6
Middleton, Adm. Sir G. N. Broke, Bart.	5	0
Payne, R. T. Esq.	5	0
*Powell, Capt.	10	0
Rant, T. Esq.	1	0
*Remnant, F. W. Esq.	2	0
Sawyer, Mr. John	2	6
Steele, T. D. Esq.	10	0
Symonds, Rev. N.	1	0
Thompson, Henry, Esq.	1	0
Vincent, J. L. Esq.	10	6
Whitaker, Herbert, Esq.	1	0
Wilmer, B. W. Esq.	1	0
Total	£37	6 6

Donations.
Crabtree, Misses, in consideration of the late disaster

Shaw, Mrs.	5	0	
Visitor	5	0	
Collecting Boxes, Gun Hill	2	4	6
Life-boat Door	2	5	4
Post Office	1	2	4
Railway Station	7	0	0
Swan Hotel	13	0	0
Total Dons.	9	2 2	
Total Subs.	£37	6 6	
Total	£46	8 8	

SUSSEX.

BRIGHTON BRANCH.

Chairman—
Mr. Alderman COX, J.P.
Treasurer—
WILLIAM JOHNSTON, Esq.
Honorary Secretary—
W. R. WOOD, Jun., Esq.
Annual Subscriptions.

£.	s.	d.
Ashbury, J. Esq., M.P.	10	0
Ashby & Co. Messrs.	1	0
Ashton, Mrs.	1	0
Attree, Geo. Esq.	10	6
Barnston, Miss	1	0
Beaumont, Rev. H., D.D.	10	6
Bell, Mrs. Jno.	1	0
Bellingham, —, Esq.	10	0
Bevis & Co. Messrs.	1	0
*Booth, E. Esq.	1	0
Bouverie, Miss	5	0
Bowen, Exors. of	1	0
Boys, Jacob, Esq.	10	0
Clarke, Somers, Esq.	10	6
Cobbett, Derby, Esq.	3	0
*Cox, Alderman	1	0
Crabbe, Miss	1	0
Etridge, Lieut.-Col.	1	0
*Forster, Capt. R.N.	1	0
Gadsby, J. Esq.	1	0

£.	s.	d.	£.	s.	d.	£.	s.	d.	£.	s.	d.
Morris, Mr. E. C.	10	0	Stephens, Rev.	10	6	Peckham, the Misses,			*Holman, Capt.	5	0
Newland, Miss	5	0	Warren, Mrs. H.	10	0	Chichester	10	0	Homewood, Mr.	5	0
Nicolls, Miss L.	10	0	Weakes, Mrs.	10	0	Sadler, Mr. W. H.,			Hood, W. Esq.	10	0
Norman, Mr. W.	1	0				West Hamnett	5	0	Hurst, Mr. Alex. & Co.	1	0
Olden, Mr.	5	0	MUNDHAM, per Rev. T. J.			Spencer, Mr. W. H.,			*Insol, R. Esq.	5	0
Parnell, Mr. J. C.	5	0	TORK:			Chichester	5	0	*Lawrence, G. H. Esq.	1	0
Partington, Mr.	5	0	Andrews, Mr. T.	5	0	Vignoles, Rev. O. J.,			Lippencott, R. C. C.		
Pasco, Mr.	5	0	Caldwell, Mr.	5	0	Littlehampton	5	0	Esq.	10	6
Paul, Mr. G.	5	0	Covert-Freund, Mrs.	5	0	Sums under 5s.	4	10	London and County		
Paxton, Dr.	5	0	Dusautoy, Miss	5	0	COLLECTED IN BOXES:—					
Peachey, Mr. E.	5	0	Hodson, Mr. F. F.	5	0	Box at the Norfolk			Lothian, —		
Percival, Mr.	1	0	Hobgen, Mr. F. N.	5	0	Hotel, Arundel	6	6	Low, Rev. T.		
Phipps, Colonel	5	0	Hodson, Mrs.	5	0	Do. Norfolk Hotel,			Manby, Colonel	1	0
Pinnix, Miss	5	0	Kerwood, Mr. W.	5	0	Littlehampton	4	5	*Maxse, Admiral	1	0
Powles, Rev. Cowley	10	0	Mount Carmel, the			Do. at the Pilot-house	5	8	Mitchell, Mr. R.		
Pratt, Capt.	10	0	Rev. Mother of the			Do. at the Railway			*Molineux, Whitfield,		
Purchase, Mr. R.	5	0	Convent of	5	0	Station	9	8	& Co. Bankers	5	0
Raper, Mr. R. G.	5	0	Nunns, Rev. R. A.			Do. at Mr. Smart's	3	7	*Morison, J. G. Esq.	10	0
Riadore, Rev. J.	5	0	L.	5	0	Do. at the Surrey			Morris & Son, Messrs.	5	0
Richardson, Mr. J.	5	0	Peachey, Mr. James	5	0	House Boy's School	11	8	Morrison, W. E.	5	0
Russell, Mr. G.	5	0	Phillips, Mr. F.	6	0	Two Boxes at the			Mures, Miss		
Royds and Maraden,			Teeddale, Mr. C. L.	10	0	Terminus Hotel	10	10	Palmer, Rev. J. H.	5	0
Messrs.	10	0	Torr, Rev. T. J.	5	0	Box on the Steamboat			Pennell, Mrs. C.	10	0
Sayers, Mr. J.	5	0	Two Friends	1	0	Ida and Steward	3	6	Percival, —, Esq.	1	0
Shippam, Mr. C.	5	0	Sums under 5s.	12	6				Phipps, Mrs. Jane	5	0
Silverlock, Miss	5	0	SELSEY, per Mr. JAMES			Total Dons.	15	15	Pitman, Rev. T.	5	0
Smith, Mr. G.	5	0	LAWRENCE:—			Total Subs.	160	12	Podmore, Rev. T.	10	0
Smith, Mrs. H.	5	0	Bateman, Mr. E. H.	5	0				*Provost, J. A.	5	0
Smith, Mr. T.	5	0	Foster, Rev. H.	5	0	£176 7 11					
Smith, Messrs. W.			Foster, Rev. Herbert			EASTBOURNE					
and T.	5	0	C.	5	0	BRANCH.					
Sowton, Mr. M. J.	5	0	Penfold, Mr. H.	5	0	Chairman—					
Swainson, Rev. Dr.	5	0	Pulling, Mr. C.	5	0	A. B. WRANGHAM, Esq.					
Temple, Mr.	10	0	Woodman, Mr. W.	5	0	Treasurer—					
Tenlon, Rev. J. S.	5	0	Yeatman, Capt.	10	0	G. MOLINEUX, Esq.					
Tyacke, Dr.	5	0	SINGLETON, per Rev. F. A.			Honorary Secretary—					
Vick, Mr. F. M.	5	0	BOWLES:—			Mr. H. M. EMARY.					
Walker, Ven. Arch-			Bower, Mr. F., West	1	1	Annual Subscriptions.					
deacon	5	0	Dean House	1	0	A Friend					
Wilmshurst, Mr.	5	0	Bowles, Rev. F. A.,	10	0	Adams, Rev. E.					
Wilson, Mr. T.	5	0	Singleton	10	0	Alder, the Rev. Dean					
Wright and Son,			Bulbeck, Mr. Charl-	5	0	*Allen, Rev. R.					
Messrs.	5	0	ton	5	0	Allpress, Mr. F.					
Sums under 5s.	9	6	Deedes, Miss, Single-	10	6	Angell, Mrs.					
			ton.	10	6	*Bacon, Capt.					
EMSWORTH, per Mr. BULL:—			Legge, Mr. C. E.,	10	0	*Bathurst, Rev. W. A.					
Allen, Rev. P.	10	0	Lavant (2 years)	10	0	Bindon, Mr. S. Esq.					
Aylward, Miss W.	5	0	WEST WITTERING, per Mr.			Blackburn, J. J. Esq.					
Boyd, Capt. C. P.	10	0	J. TRUST:—			Bradley, Miss					
Castle, Mr.	5	0	Andrews, Mr. John	5	0	Brodie, Wm. Esq.					
Cox, Mr. J. E.	5	0	Aylmore, Mr. Thos.	5	0	Brodie, Miss					
De Kantzoe, Mr. W. S.	5	0	Combes, Mr. Charles	10	0	Bromley, G. F.					
Dixon, Mr. H. W.	5	0	Gorham, Mr. J.	10	0	Brown, G.					
Fellowes, Mrs.	5	0	Sargent, Rev. H. J.	5	0	Brown, Mr. J.					
Heseldine, Mrs.	1	0	East Wittering	5	0	Brown, Mr. H. R.					
Hipkin, Mrs.	5	0	Sparkes, Mr. R. H.	5	0	Cardwell, Mrs. D. A.					
Hood, Mr. F. Jacourt	5	0	East Wittering Mill	5	0	C. H.					
King, Mr. W.	5	0	Underwood, Rev. W.	5	0	*Climpson, Mr. R.					
Lett, Mr.	5	0	D.	5	0	*Coles, J. H. C. Esq.					
Lyon, Miss	5	0	Wilson, Mr. T. L.	5	0	*Colgate, R. Esq.					
Mackie, Mrs.	5	0	Birdham	5	0	Colville, E. Esq.					
Matson, Miss North.	5	0	Sums under 5s.	9	6	Crake, Rev. E.					
Martin, Mr. G. P.	5	0	Total	160	12	Devonshire, His Grace					
March, Mr. J. O.	5	0				the Duke of					
Munday, Lady	5	0	Donations.			Dexter, Mrs.					
Norris, Rev. W.	10	0	Admiral of the Fleet,			Earp, Wm. Esq.					
Norris, Rev. W. B.	5	0	Sir Provo Wallis,			E. R.					
Oldfield, Miss Lumley	5	0	G.C.B., Funtington			Edwards, James, Esq.					
Orsborn, Mr. J.	5	0	House	10	0	Ellis, John, Esq.					
Padwick, Mr. H.	1	0	Buckell, Mrs. L.,			Evenden, H.					
Rawson, Mr.	5	0	Colchester	5	0	Finlay, Mrs.					
Rawson, Mrs.	5	0	Davis, Miss, Chi-			Foran, J. C. Esq.					
Sainthill, Mr.	5	0	chester	5	0	Frare, J. H. Esq.					
Scale, Mr. G. T.	10	0	Dawes, Mr. B., New			Gage, Hon. Miss.					
Shawe, Mrs. R.	5	0	Fishbourne	5	0	Gilbert, C. D. Esq.					
Shean, Rev. H.	5	0	Deedes, Mr. H. Bin-			Gould, Dr. G.					
Sheppard, Rev. H. W.	10	0	derton House	2	0	Green, Rev. G. R.					
Smith, Mrs. E.	5	0	Le Marchant, Rev.			Gurney, G. Esq.					
Spencer, Capt.	1	0	Mr., Littlehampton	1	0	Hagger, Mrs.					
Thomson, Mrs.	5	0	Norman, Mr. J. M.,			Hart, Miss					
Wilde, Rev. R.	5	0	Dencombe, Craw-			Hedley, Capt. G.					
Wilder, Mr. G.	1	0	ley	1	0	Henderson, R. H.					
Sums under 5s.	3	0	Offortary at St. John's	1	14	Esq.					
			Church	1	14						
MIDHURST, per			Paxton, Dr. Chi-	5	0						
Godson, Mr. J.	5	0	chester	5	0						
Hilton, Rev. M. F.	5	0									
Johnson, Mr. Thomas	5	0									
Robinson, Mr. John,	5	0									
M. D.	5	0									
Stapley, Rev. F. A.	5	0									

BRANCHES—LIST OF ANNUAL SUBSCRIPTIONS AND DONATIONS. 595

HASTINGS AND ST. LEONARDS BRANCH.

Secretary—
Geo. HUTCHINGS.

Annual Subscriptions.	
£.	s. d.
Abergavenny, Countess of.....	1 0 0
Abud, Miss.....	5 0 0
Addison, Mr. W. S.....	5 0 0
Adey, Dr.....	10 0 0
Anderson, Mrs.....	5 0 0
Anstruther, Mrs.....	5 0 0
Anstey, Mrs. (the late).....	10 0 0
Atkey, Mr.....	5 0 0
Austen, Mrs. Henry.....	10 0 0
Bacchus, Mrs.....	10 0 0
Back, Miss.....	1 1 0
Backhouse, Miss.....	5 0 0
Baker, Mr. H. M.....	5 0 0
Baker, W. Esq.....	5 0 0
Baker, Mr. H.....	5 0 0
Barlow, Capt.....	10 0 0
Beaumont, Mrs.....	1 1 0
Bechling and Co., Messrs.....	1 1 0
Birkett, J. Esq.....	5 0 0
Bishop, Miss.....	1 1 0
Boger, G. O. Esq.....	5 0 0
Bolding, Miss.....	10 0 0
Bolding, Miss (Friend).....	10 0 0
Boning and Small, Messrs.....	5 0 0
Bostock, Mrs.....	1 1 0
Boyson, Mrs.....	5 0 0
Braham, Mrs.....	5 0 0
Brassey, Sir T., K.C.B., M.P.....	1 1 0
Brisco, Miss.....	1 1 0
Broadwood, Mrs.....	10 0 0
Brocklebank, E. M. Esq.....	1 0 0
Bromhead, Mrs. A. L.....	5 0 0
Brown, H. A. Esq.....	10 0 0
Browne, Miss.....	5 0 0
Burfield, Messrs. J. and C.....	5 0 0
Burgoyne, J. C. Esq.....	10 0 0
Bushnell, The Misses.....	5 0 0
Burton, A. H. Esq.....	1 1 0
Cameron, J. Esq.....	1 1 0
Carter, C. P. Esq.....	1 1 0
Caulfield, H. C. Esq.....	5 0 0
Cayley, The Misses.....	5 0 0
Chester, Mr. S.....	5 0 0
Chester, Mrs.....	5 0 0
Christopherson, Miss.....	5 0 0
Christopherson, Miss (1880).....	5 0 0
Clarke, Mrs.....	5 0 0
Coles, J. R. Esq.....	5 0 0
Coles, T. H. Esq.....	1 1 0
Collins, Mrs. H.....	10 0 0
Combermere, Viscountess.....	5 0 0
Convent, The.....	1 1 0
Cooke, Dr.....	5 0 0
Corporation of Hastings.....	20 0 0
Crake, V. B. Esq.....	1 1 0
Cripps, Miss.....	5 0 0
Crothers, Dr.....	1 0 0
Croucher, Dr.....	10 0 0
Cumberlege, Mrs.....	5 0 0
Dawes, Rev. G. D.....	5 0 0
Dawson, Mrs. W. H.....	1 1 0
Denyssen, Hon. Justice.....	10 0 0
Dickinson, Mrs.....	5 0 0
Dixon, J. Esq.....	1 0 0
Dockray, Mrs.....	5 0 0
Dods, Mrs.....	10 0 0
Dods, Miss.....	5 0 0
Edridge, Mrs.....	5 0 0
Elkin, C. M. Esq.....	5 0 0
Emerson, Mrs.....	5 0 0
Emerson, Miss.....	5 0 0
Erskine, Mrs. Kennedy.....	5 0 0
Evans, A. Esq.....	5 0 0

Eversfield, C. I. Esq. (1880).....	1 0 0
Eyre, Rev. C. J. P.....	10 0 0
Fisk, Rev. J. H.....	5 0 0
Ford, Fras.....	10 0 0
Forster, A. Esq.....	1 0 0
Forster, A. Esq. (1880).....	1 0 0
Foskett, Miss.....	10 0 0
Foyster, Rev. G. A.....	10 0 0
Foyster, Rev. H. B.....	1 0 0
Fulford, Mrs. C. M.....	5 0 0
Gant, Mrs.....	10 0 0
Gardiner, Rev. G. G.....	10 0 0
Gea, Mrs. E. J.....	5 0 0
Ginner and Son, Messrs.....	5 0 0
Glenside, Misses.....	5 0 0
Gore, Hon. Mrs. A.....	5 0 0
Gotlieb, Mrs.....	5 0 0
Gray, Mrs. J.....	1 1 0
Green, Rev. W.....	10 0 0
Greenhill, Dr.....	5 0 0
Griffin, Mrs. N.....	1 1 0
Guillebaud, Rev. H.....	10 0 0
H. C. A.....	5 0 0
Haggar, Mrs. J. B.....	5 0 0
Hamilton, Miss.....	10 0 0
Hancock, Miss.....	10 0 0
Haviland, P. G. Esq.....	1 0 0
Hay, Lady.....	10 0 0
Heathcote, U. Esq.....	5 0 0
Holley, Mrs. Hunt.....	10 0 0
Hornor, Mrs.....	5 0 0
Horton, Sir G. W.....	10 0 0
How and Co. Messrs.....	5 0 0
Howell, Sir Thomas.....	5 0 0
Howell, Mrs.....	10 0 0
Hume, Rev. W. W.....	1 1 0
Huxtable, Archdeacon I. L. S.....	5 0 0
Irby, Hon. Mrs.....	10 0 0
Johnstone, Mrs.....	5 0 0
Kennedy, Mr.....	5 0 0
Keyser, A. Esq.....	10 0 0
Kirkup, Mrs.....	5 0 0
Kingsbury, Miss.....	5 0 0
Kitson, Mrs.....	5 0 0
Langdon, A. W. Esq.....	10 0 0
Law, Miss.....	10 0 0
Lee, Miss.....	10 0 0
Leish, Mrs.....	1 0 0
Littlehales, W. L. Esq.....	5 0 0
Litzow, Countess.....	10 0 0
Macbraine, Mrs.....	1 0 0
Mackay, Miss.....	10 0 0
Marsden, T. M. Esq.....	5 0 0
Marine Parade, Thanksgiving.....	10 0 0
Martin, Charles, Esq.....	10 0 0
Martin, Horace, Esq.....	1 1 0
Mason, T. Esq.....	1 1 0
McKinnell, Mr.....	5 0 0
Medwin, Mr.....	5 0 0
Micklethwaite, Mrs.....	5 0 0
Molyneux, Miss.....	5 0 0
Monkhouse, Miss.....	5 0 0
Murray, C. J. Esq., M.P.....	1 1 0
Nicholl, Miss.....	10 0 0
Nicholson, Miss.....	10 0 0
Nicholson, Miss.....	10 0 0
North, Miss.....	10 0 0
Norcott, Sir W.....	5 0 0
Ogle, Major.....	5 0 0
Orlebar, Admiral.....	1 0 0
Parkin, Rev. J. (1880).....	5 0 0
Parkin, Rev. J. (1881).....	5 0 0
Perkins, Mrs.....	1 0 0
Peel, Lady A.....	5 0 0
Peyton, J. E. H. Esq.....	1 1 0
Pikington, Mrs.....	5 0 0
Plummer, Mr. E.....	5 0 0
Pott, Mrs. Sidney.....	10 0 0
Prichard, Mrs.....	10 0 0
Randall, Mr.....	10 0 0
Rawlins, Rev. J.....	10 0 0
Rock, J. Esq.....	1 0 0
Roddiss and Goldsmith, Messrs.....	5 0 0
Roe, H. Esq. (the late, 1880).....	5 0 0

Rosher, Miss.....	5 0 0
Ross, T. Esq. (the late).....	10 0 0
Sandoz, Mrs.....	5 0 0
Sawyer, Mr.....	10 0 0
Sayer, Miss.....	1 1 0
Scott, Miss.....	5 0 0
Scrivens, S. Esq.....	10 0 0
Sedgewick, Mrs.....	10 0 0
Shaw, Dr.....	5 0 0
Shoubridge, Mr.....	5 0 0
Sidway, Mr.....	10 0 0
Smith, Mrs. Masters (1880).....	5 0 0
Smith, Mr. Masters (1881).....	5 0 0
Stacey, Mrs. B.....	10 0 0
Stainton, Miss.....	10 0 0
Stewart, R. Esq.....	5 0 0
Stielhel, Miss.....	10 0 0
Strachan, Mr.....	10 0 0
Sutton, Rev. R. S., Rype Rectory.....	1 1 0
Tanner, Mrs.....	10 0 0
Thrupp, Mr. L. W.....	5 0 0
Tolley, Miss.....	5 0 0
Tottenham, Rev. J.....	10 0 0
Treacher, H. Esq.....	10 0 0
Turner, Rev. W. T.....	10 0 0
Turner, Mrs.....	5 0 0
Turner, Miss.....	10 0 0
VonRoemer, Baroness.....	1 0 0
Vorea, S. Esq.....	10 0 0
Waldegrave, Lady M.....	5 0 0
Waterfield, Mrs.....	5 0 0
Wickham, Miss.....	5 0 0
Wiggins, Miss.....	5 0 0
Williams, Miss.....	5 0 0
Winthrop, Mrs.....	5 0 0
Young, W. B. Esq.....	1 1 0
Youngusband, Mrs.....	10 0 0
Total.....	129 6 6

Donations.	
Small Sums.....	11 18 7
Boxes.....	30 12 2
Total.....	£171 17 3

NEW HAVEN BRANCH.

Chairman—

Honorary Secretary—
J. W. NOEL, Esq.
Collector—
MR. JOHN B. ROBERTS.

Annual Subscriptions.	
Blencowe, J. Esq.....	1 0 0
Brown, T. Esq.....	1 1 0
*Bull, J. Esq.....	10 0 0
Burfield, Mr.....	1 1 0
Bushby, G. Esq.....	10 0 0
Catt & Son, Messrs. W. I.....	10 0 0
Chatfield, E. Esq.....	10 0 0
Chichester, Earl of.....	2 0 0
Cook & Sons, Messrs. 2.....	2 0 0
Eastwood, Mr.....	10 0 0
Elmsley and Co.....	5 0 0
Every, J. Esq.....	5 0 0
Farncombe, J. Esq.....	5 0 0
Gage, Viscount.....	2 0 0
Godlee, B. Esq.....	10 0 0
Gorringe, Mrs.....	10 0 0
Hannam, J. Esq.....	5 0 0
Harrison, Major.....	10 0 0
L. B. & S. C. Railway and Harbour Co. 1879-80.....	10 0 0
Lambe, R. Esq.....	5 0 0
*Love, T. H. Esq.....	10 0 0
Lowdell and Co. Messrs.....	10 0 0
Lowndes, A. Esq.....	10 0 0
Madgwick and Son, Messrs.....	5 0 0

Martin, James, Esq.....	5 0 0
Molyneux and Co. Messrs. or Whitfield & Co. Messrs.....	1 1 0 0
Monk & Son, Messrs.....	10 0 6
Morris & Son, Messrs.....	10 0 6
Newington and Co. Messrs.....	10 0 0
Pann, A. Esq.....	5 0 0
Pannett, W. Esq.....	1 1 0
Parsons Bros. Messrs.....	10 0 0
*Payne, Capt.....	10 0 6
Simmons, H. Esq.....	10 0 0
Simmons, T. R. Esq.....	10 0 0
Sheffield, Earl of.....	2 0 0
Smith, J. Maxfield, Esq.....	1 1 0
*Stone and Tower, Messrs.....	10 0 6
*Stevens, Mr. Z.....	5 0 0
Sydenham, Hunt, & Co.....	10 0 6
*White, Capt.....	5 0 0
Total.....	37 12 0

Donations.	
A Friend.....	10 0 6
Atkinson, Mr. H.....	5 0 0
Bance, E. J.....	5 0 0
Bancroft, Mr.....	5 0 0
Buck, Rev.....	5 0 0
C. H.....	5 0 0
Clarridge, J. B. J. Esq.....	5 0 0
Deane, E. Esq.....	5 0 0
Farncombe, Miss E.....	5 0 0
Herbert, T. S. Esq.....	7 6 0
Hilman, A. Esq.....	5 0 0
Isard, Rev. T. Esq.....	5 0 0
Lewis, W. P. Esq.....	5 0 0
Mannington, Mr.....	10 0 0
Martin, F. Esq.....	5 0 0
Menier, Mons. H.....	1 8 0
Munro, C. H. Esq.....	5 0 0
Oloroyd, E. Esq.....	5 0 0
Round, E. Esq.....	5 0 0
Thorne, J. Esq.....	5 0 0
Turner, R. Esq.....	5 0 0
Willan, F. Esq.....	5 0 0
Willan, Mrs. A.....	8 0 0
Yacht Heron.....	5 6 0
Sums under 5s.....	3 16 8

Box Contributions—	
Custom House Box.....	5 9
Iron Pillar.....	17 8
J. & N. C. Bull's Office Box.....	2 10 0
Life-boat Ho. Box.....	1 8 0
SS. Brighton.....	11 10 0
SS. Marseilles.....	18 10 0
SS. Paris.....	7 11 0
SS. Victoria.....	7 0 0
Steam Packet Co. Box.....	2 11 0
Other Boxes.....	5 3
Total Dons.....	21 10 4
Total Subs.....	37 12 0
Total.....	£59 2 4

RYE AND WINCHELSEA BRANCH.

President—
T. S. PIX, Esq.
Honorary Secretary—
J. S. VIDLER, Esq.

Annual Subscriptions.	
Adamson, E. Esq.....	10 0 0
Bellingham, F. Esq.....	10 0 6
Bloomfield, Mrs.....	1 1 0
Burra, H. Esq.....	10 0 0
Churton, Rev. H. B. W.....	10 0 0
Dawes, Walter, Esq.....	10 0 0
Gladstone, Rev. D. T. 1.....	1 0 0
Hilder, Mr. George.....	2 2 0
Inderwick, F. A. Esq., M.P., Q.C.....	1 1 0
Lord, Rev. J. O.....	10 0 0

	£.	s.	d.
Mayor of Rye.....	10	0	0
Meryon, Mrs.....	10	0	0
Pix, Thomas S. Esq. 1 1 0	1	1	0
Skinner, R. V. Esq....	1	0	0
Stileman, Major.....	1	1	0
Stileman, Miss.....	10	0	0
Vidler, Mr. J. S.	10	6	
Total	12	18	0

Donations.

Mr. Cooper's box ...	1	2	0
Sums under 5s.....	2	6	
£14 2 6			

SHOREHAM BRANCH.

Chairman—
HUGH GOUGHAN, Esq.

Treasurer—
ROBERT HENDERSON, Esq.

Honorary Secretary—
THOS. FULLER, Esq. M.D.

Honorary Collector—
D. FILMORE.

Annual Subscriptions.

Beves and Co.....	1	0	0
*Brown, J. E. Esq....	10	6	
Burrell, Sir W. W.			
Bart, M.P.	1	1	0
*Fuller, Thos. Esq....	10	6	
*Gorringe, H. Esq. ...	2	2	0
*Henderson, R. Esq. -	10	6	
Ingram, Colonel (1880 and 1881) ...	2	2	0
Loder, Robert, Esq. M.P.	1	1	0
Penney, R. H. Esq. ...	1	0	0
*Milmore, D. Esq....	10	6	
Stapledon, T. L. Esq. -	10	0	0
*Wales, Captain ...	10	6	
Vallance, Capt. & Co. 1 0 0	1	0	0
Willett, G. W. Esq. ...	1	1	0
Total£13 9 6			

WORTHING BRANCH.

Patron—
Sir W. W. BURRELL, Bart. M.P.

Chairman—
H. HARGOOD, Esq.

Honorary Secretary—
MELVILL GREEN, Esq.

Annual Subscriptions.

Attree, — Esq.....	5	0	0
Austin, C. Esq.....	5	0	0
Beckett, Miss.....	5	0	0
Blaker, Ernest H. Esq.	5	0	0
Blaker, Mr. F.....	5	0	0
Brewer, Mrs.....	5	0	0
Brooker, W. H. Esq. -	5	0	0
Burnand, Capt. A. ...	10	0	0
Burnand, G. Esq....	10	6	
Butcher, Mrs.....	5	0	0
Butler, Mrs.....	10	6	
Cameron, N. Pryce, Esq.....	5	0	0
Capron, Rev. C. H. ...	5	0	0
Chaplin, Messrs.....	5	0	0
Chapman, Mr. H.....	10	6	
Cholmeley, the Misses -	5	0	0
*Coffin, E. Esq.....	10	0	0
*Collet, A. H. Esq. ...	5	0	0
Collet, G. B. Esq....	5	0	0
Convent	10	0	0
Cooksey, Mr.....	5	0	0
Cortis, Mr. A.....	5	0	0
Cragg, Mr.....	5	0	0
Cripps, Mr. F.....	5	0	0
Cruse, Rev. F.....	5	0	0

	£.	s.	d.
Currey, Mrs.....	1	0	0
Davey, Mrs.....	5	0	0
Dawes, R. Esq.	1	1	0
Dawes, Mrs. (the Cottage).....	5	0	0
Dixon, F. Esq.....	5	0	0
Dodd, Mrs.....	10	0	0
Edmunds, R. Esq....	5	0	0
E. I. R.	10	0	0
Elliott, Rev. E. K....	5	0	0
Ferguson, Miss.....	5	0	0
Goldsmith, Dr.....	5	0	0
Graham, T. G. Esq. -	10	6	
Green, F. Esq.....	5	0	0
*Green, M. Esq.....	1	1	0
*Gresson, Rev. J. G. -	10	6	
Grevett, Mr. R.....	5	0	0
H. M.	5	0	0
Hargood, Admiral. 1 1 0	1	1	0
*Hargood, H. Esq. ...	1	1	0
*Harris, W. J. Esq. ...	1	1	0
Harrison, Mrs.....	10	6	
Hatherly, W. Esq....	5	0	0
Elde Brothers, & Co. Messrs.....	5	0	0
Hill, J. Rowland, Esq. -	5	0	0
Holmes, G. P. Esq. ...	10	6	
Hooton, — Esq.....	5	0	0
Hopkins, H. Esq....	10	0	0
Kaye, Gen.....	1	1	0
Kelly, Dr.....	5	0	0
Loder, R. Esq. M.P. 1 1 0	1	1	0
Lumsdale, A. Esq. ...	5	0	0
Matveill, — Esq....	5	0	0
Maxwell, General ...	10	0	0
McLurcher, — Esq. ...	5	0	0
Morris, T. Esq.....	5	0	0
Morton, Mrs.....	5	0	0
Newland, the Misses. 1 0 0	1	0	0
Nicholls, Mrs.....	10	0	0
Paive, F. Esq.....	5	0	0
Parker, Rev. I.....	5	0	0
Parr, Rev. J. O.....	5	0	0
Parry, Major.....	5	0	0
Patching, Mr. E. C. -	10	6	
*Patching, W. Esq. -	10	6	
Paul, H. Esq.....	10	6	
Potter, Mr. W.....	5	0	0
Potts, Mrs.....	5	0	0
Pryce, T. D. Esq. ...	5	0	0
Puckle, Mrs. R.....	10	0	0
Purdon, Rev. J.....	5	0	0
Roberts, Chas. Esq. -	10	6	
Roberts, John, Esq. -	5	0	0
Rumford, Mrs.....	5	0	0
Simpson, W. S. Esq. -	5	0	0
Skindle, Mr. W.....	10	6	
Smart, H. Esq.....	10	6	
Smith, J. C. T. Esq. -	5	0	0
Smith, Messrs. G. H. and Son	5	0	0
Stocker, Misses.....	10	0	0
Taylor, Mrs. C. B.....	10	0	0
Thornton, A. J. Esq. -	10	6	
Trail, Miss.....	10	0	0
Tribe, W. F. Esq....	10	6	
Vansittart, Vice-Ad- miral, C.B.....	10	6	
Verrall, W. Esq....	5	0	0
Verrall, W. F. Esq. -	10	0	0
Watson, J. L. Esq. ...	7	6	
Watson, Rev. W. G. -	5	0	0
West, Mrs. P.....	10	6	
Wickham, A. Esq....	5	0	0
W. I. D. per J. P. ...	1	0	0
Wisden, Colonel.....	10	0	0
Wood, Major M.....	10	0	0
Young, A. Esq.....	1	1	0
Sums under 5s,	7	3	0
Total	49	12	6

Donations.

Pillar and Wall Boxes	6	13	0
Total Dons.	6	13	0
Total Subs.	49	12	6
£56 5 6			

Warwickshire.

BIRMINGHAM BRANCH.

Chairman—
J. H. CHANCE, Esq.

Honorary Secretaries—
MESSRS. CHARLES and WILLIAM BARWELL.

Annual Subscriptions.

	£.	s.	d.
Avery, Mrs.....	1	1	0
Baldwin, J. and Sons, Messrs.....	2	2	0
Barclay, Hanbury, Esq.....	1	1	0
Barwell Chas. Esq. ...	1	1	0
Barwell, James, Esq. 1 1 0	1	1	0
Barwell, Wm, Esq....	1	1	0
Barwell, Miss.....	10	6	
Cadbury, Joel, Esq. ...	1	1	0
Chamberlain, King, and Jones, Messrs. 1 1 0	1	1	0
Chance, J. H. Esq....	5	5	0
Chance, R. L. Esq....	5	5	0
Clay, John, Esq.....	10	6	
Colmore, Mrs.....	1	1	0
Corbett, Jno. Esq. M.P. 1 1 0	1	1	0
Crosbee and Sons, Messrs.....	1	1	0
Cutler, Mrs.....	1	1	0
Davis, E. May, Esq. ...	10	6	
Dew, Mrs.....	1	1	0
Dugard, W.....	1	1	0
Ellis, & Sons, Messrs. 2 2 0	2	2	0
Finnemore, J. B. Esq. 1 1 0	1	1	0
Fitter, M. A. Esq. ...	1	1	0
Gilbert, J. Esq.....	10	6	
Gilbert, Mrs.....	10	6	
Griffiths & Browett, Messrs.....	1	1	0
Heaton, A.....	1	1	0
Heaton and Taylor, Messrs.....	1	1	0
Heaton, G. Esq., J.P.....	1	1	0
Heaton, G. (Solihull) 1 1 0	1	1	0
Heaton, H. Esq.....	1	1	0
Hoerner, M. U. Esq. ...	1	1	0
Huggins, W. Esq....	1	1	0
Jones, Miss (1880 & 1881).....	2	0	0
Jutson and Sons, Messrs.....	1	1	0
Manton, H. Esq. J.P. 2 2 0	2	2	0
Oeler, Mrs. C.....	1	0	0
Padmore, J. Esq....	1	1	0
Price, Robt. & Co. ...	1	1	0
Simpson, F. R. & Co. Messrs.....	1	1	0
Stevens, James, Esq. 1 1 0	1	1	0
Stokes, J. Esq.....	1	1	0
Tangye Bros.	1	1	0
Tyndall, E. L. Esq. ...	1	1	0
Walker, S. Esq.....	1	1	0
Walker, Miss (1880 & 1881).....	2	0	0
Whitfield, S. Esq....	1	1	0
Whitehouse, J. Esq. ...	1	1	0
Wilkes, G. Esq.....	1	1	0
Wilkes, J. Esq.....	1	1	0
Wilkes, John, Esq., Darlaston.....	10	6	
Williams, J. Esq....	1	1	0
Williams, Mrs. J. ...	1	1	0
Williams, J. A. Esq. 1 1 0	1	1	0
Wood, Miss.....	1	1	0
Total.....	66	18	0

Donations.

Briggs, Mrs. (the late) 1 1 0	1	1	0
Downing, Mr. S.....	1	1	0
Mott, Mr. J. R.....	10	0	0

Box, per Mr. C.....			
Houghton.....	1	3	7
Do. Mr. H. G. Wallace	1	5	0
Do. Mrs. W. Bar- well's children ...	1	11	6

Total Dons.....	6	12	1
Total Subs.	66	18	0
£73 10 1			

Worcestershire.

ACOCK'S GREEN, YARDLEY, AND OLTON BRANCH.

Chairman—
J. BARROWS, Esq., J.P.

*Treasurer and
Honorary Secretary—*
Rev. A. BUTLER, LL.D.

Annual Subscriptions.

	£.	s.	d.
Ash, Mr. A. J.	10	0	0
Ash, Mrs.....	5	0	0
Atkin, Mrs.....	5	0	0
Bach, Mr.....	5	0	0
Barker, Mr. J.....	10	6	
Barker, Mrs.....	10	0	0
Barker, Mr. H.....	5	0	0
Barker, Mr. T. B.....	5	0	0
Boston, Mr.....	10	0	0
Butler, Rev. Dr.....	5	0	0
Dixon, Mrs.....	5	0	0
Dudley, Mrs.....	5	0	0
Duke, Mr.....	5	0	0
Duke, Mrs.....	5	0	0
Fletcher, Mrs.....	5	0	0
Handley, Mr.....	5	0	0
Handley, Mrs.....	5	0	0
Hodgkins, Mr.	1	1	0
Holroyd, Mr. E. B.....	5	0	0
Hoskins, Mrs.....	10	0	0
Jefferys, Mr.....	5	0	0
Kimpton, Mrs.....	10	0	0
King, Mrs.....	5	0	0
Kiss, Mr.....	5	0	0
Marrion, Mr.....	5	0	0
Mellor, Mrs.....	5	0	0
Neale, Mrs.....	5	0	0
Newey's, Mrs. Child- ren	5	0	0
Pattison, Mr.....	5	0	0
Phillips, Mrs.....	5	0	0
Truth	5	0	0
Walker, Mr. A.....	10	0	0
Ward, Mrs.....	5	0	0
Watts, Mr.....	5	0	0
Whitfield, Mr. A.....	5	0	0
Whitfield, Mrs. A.....	5	0	0
Whitfield, Mrs. H.....	10	0	0
Wilkins, Mrs.....	5	0	0
Yardley, Miss.....	5	0	0
Yenour, Mr.....	1	1	0
Sums under 5s.....	17	0	0

Per Miss CLAYWORTH—

Fordred, Mr. J.....	5	0	0
Peak, Mrs.....	10	0	0
Sums under 5s.....	8	0	0

*YARDLEY,
per Miss WHITAKER—*

Aiston, Mrs. Elmdon Hall	1	0	0
Barrows, Mr., J.P. ...	1	1	0
Barrows, Mr. Jun... 1 1 0	1	1	0
Biddle, Mr.....	5	0	0
Bullivant, Mrs.....	5	0	0

	£.	s.	d.
Cox, Mrs.	5	0	0
Dalman, Mrs.	5	0	0
Dodd, Rev. F. S.	5	0	0
Fenton, Mr.	10	0	0
Hackett, Mr.	10	0	0
Hedgcs, Mrs.	5	0	0
Lichfield, Mrs.	5	0	0
Lovckin, Mr.	5	0	0
Madeley, Mrs.	10	0	0
Onions, Mrs.	5	0	0
Pollack, Mrs.	5	0	0
Ransome, Mr.	5	0	0
Rosenberg, Mr.	5	0	0
Shakespeare, Mr. W.	5	0	0
Simons, Rev. G. H.	5	0	0
Tangye, Mr., J.P.	1	0	0
Whitaker, Mrs.	1	0	0
Whitaker, Miss	5	0	0
Whitaker, Miss A.	5	0	0
Sums under 6s.	7	6	0

OLTON, per Miss MIDDLETON.

Arnold, Mrs.	5	0	0
Evans, Mrs.	5	0	0
Hunt, Mrs.	5	0	0
Manley, Mr.	5	0	0
Sums under 6s.	1	9	0
Total	29	6	0

Donations.

YARDLEY,

per Miss WHITAKER—

Chinn, Miss Life-boat	8	1	0
Box	2	11	10
Fenton, Mr. Life-boat	12	0	0
Box	14	6	0
Harvey, Mr. Life-boat	14	6	0
Box	1	4	0
Whitaker, Miss, Life-boat	1	4	0
Box	5	10	5

Collecting Cards.

ACOCK'S GREEN,

per Miss BARKEN—

Holroyd, Mast. Victor	3	9	0
Jefferys, Mr. B.	8	6	0
Middleton, Mast. G.	5	9	0
Richards, Mast. W.	1	6	3

YARDLEY,

per Miss HOSKINS—

Biddle, Miss	2	14	8
Grice, Miss	5	2	0
Hoskins, Miss	16	6	0
Hoskins, Mr. J.	5	9	0
Rowlands, Miss	6	8	0
Total	6	12	10
Total Subs.	29	6	0
Total Dons.	5	10	5
Collecting Cards	6	12	10
£41	9	3	

BLOCKLEY BRANCH.

Honorary Secretary—
Rev. ALFRED J. SODEN.

Annual Subscriptions.

Bearcroft, Mrs.	5	0	0
Clifford, Mr. G. S.	5	0	0
Clarke, Rev. J. W.	5	0	0
Herbert, Mr. Fredk.	5	0	0
Houghton, Rev. E. J.	5	0	0
Peebles, Mr. C. J.	5	0	0
Smith, Mr. G. P.	5	0	0
Scovell, Mr. J.	5	0	0
Soden, Rev. A. J.	5	0	0
Wake, Mr. A.	5	0	0
Total	£2	10	0

STECHFORD BRANCH.

Treasurer and Hon. Sec.—
Mr. WILLIAM MORGAN.

Annual Subscriptions.

	£.	s.	d.
Archer, Mr., Edg- baston	10	6	0
Baird, Miss, Dover.	5	0	0
Bower, Miss, Knowle	5	0	0
Chirrn, Mr. J., Edg- baston	5	0	0
Clarke, Mr.	10	0	0
Davis, Mrs., Swere- ford Park.	1	0	0
Icke, Mrs.	10	6	0
Lloyd, Miss, Lea- mington, collected by (7l. 3s. 6d.):—	4	0	0
A. M. D.	4	0	0
Grimsdick, Mr. W. C.	5	0	0
Goode, Mr. W.	10	6	0
Hardy, Mrs.	10	0	0
Heathcote, Miss	5	0	0
Inglall, Mr. W. G.	1	0	0
Lloyd, Mrs.	5	0	0
Lloyd, Mrs. E.	2	6	0
Lloyd, Miss (don.)	10	6	0
Lloyd, Miss K.	10	6	0
L. W. H.	5	0	0
L. H. C.	3	6	0
Mactavish, Miss	10	0	0
Matthews, Rev. J. E.	5	0	0
Metcalfe, the Misses	1	0	0
M. S.	5	0	0
Tritton, Col. & Mrs.	10	0	0
Maxwell, Miss, Bir- mingham	5	0	0
Morgan, Miss, Quar- ndon	10	6	0
*Morgan, Mr. W.	10	6	0
Neal, Mr. J. R., Torquay	5	0	0
Pollack, Mrs.	5	0	0
Ramsden, Mr.	5	0	0
Smallwood, Mr.	10	6	0
Total	13	1	0

Donations.

Brittain, Mr. A. col-
lected by 12s. 5d.,
L.-B. Box 19s. 1d.,
Don. 17s. 6d.

2	10	0	
Cooke, Miss, col- lected by	1	0	0
Fleld, Mr. Broms- grove, Life-boat	5	0	0
Box	5	0	0
Greig, Miss, Enderby, Life-boat Box	1	9	0
Hemus, Mr. Life-Boat	10	6	0
Box	10	6	0
Morgan, Miss, and Newbold, Miss, Quarndon, Life- boat Box	1	11	5
Annual Meeting, Readings, &c., by Mr. W. Morgan	1	18	5
Total	9	4	4

Collecting Cards.

Aston, Miss, Bir- mingham	10	6	0
Ball, Mast-r Howard	6	6	0
Baker, Master Tom	8	0	0
Bradney, Miss Ada	3	3	0
Brown, Miss & Mast.	7	0	0
Gwyther, Mrs. Shen- stone	10	6	0
Gwyther, Miss	8	8	0
Gwyther, Miss P.	8	8	0
Gwyther, Miss M. F.	8	8	0
Heiges, Miss	1	0	0
Ingram, Miss	6	0	0

Kempson, Miss F.	10	0	0
Driff, Miss, Weston- super-Mare	10	0	0
Rogers, Master Tom	5	1	0
Smith, Miss Eva	5	0	0
Street, Miss G.	3	9	0
Tomlinson, Miss	5	3	0
Tomlinson, Master	5	3	0
Turner, Mast. Tyson	14	6	0
Viney, Miss Nellie	7	8	0
Woodward, Mast. Jas.	1	9	0

QUARNDON.

Newbold, Miss	5	0	0
Benson, Miss Jessie	9	6	0
Brasher, Miss	12	0	0
Coleman, Miss F.	6	0	0
Ellin, Miss E.	8	0	0
Hargreaves, Miss A. M.	8	0	0
Hunt, Miss May	5	3	0
Hutton, Miss	5	11	0
Marrlott, Miss	1	0	0
Newbold, Miss Rose	13	0	0
Swingler, Miss A.	9	0	0
Taylor, Miss	8	6	0
Welby, Miss	1	16	0
Total	14	16	8

Total Subscriptions 13 1 0
Donations 9 4 4
Col. Cards 14 16 8
£37 2 0

WORCESTER BRANCH.

Chairman—
FRAS. SPOONER, Esq.
Treasurer—
FRAS. SPOONER, Esq.
Honorary Secretary—
F. W. SEAMAN, Esq.

Annual Subscriptions.

Allsopp, Sir Hy.	1	1	0
Ames, Frederick	1	1	0
Amphlett, Rev.	10	6	0
Bearcroft, Rev. J.	1	1	0
Binyon, Mrs.	1	0	0
Cheshire, Rev. J. S.	10	0	0
Clarke, Erlin, Esq.	1	0	0
Clarke, Geo. Esq.	1	0	0
Cooper, J. D.	5	0	0
Cox & Painter, Messrs.	10	6	0
Dodd, Rev. Thomas.	5	0	0
Dorville, Admiral	1	1	0
Evans, E. B.	1	1	0
Evans, E. W. Esq.	1	1	0
Gresley, R. A. D.	1	0	0
Hadley, E., Newport	10	6	0
Hall, Joseph, Esq.	10	0	0
Heaton, W. H. Esq.	1	0	0
Holden, Mrs. Hyla.	10	0	0
Holland, Walter, Esq.	10	6	0
Hopkins, T. M. Esq.	5	0	0
J. J. Miss	5	0	0
Jefferis, B. Esq.	5	0	0
Jones, Henry, Esq.	1	1	0
Lea, C. Wheelcy, Esq.	2	2	0
Lechmere, Sir E. A. H.	1	1	0
Lugard, Rev. F. G.	10	6	0
McNaught and Smith	10	0	0
Martin, Miss	2	0	0
Mellor, Wm. Esq.	10	0	0
Nicholas, Mrs.	10	6	0
Perrins, J. D. Esq.	1	1	0
Pidcock, Chas. Esq.	1	1	0
Piercy & Co. Messrs.	1	1	0
Reid, John, Esq.	1	1	0
Rowlands, Rev.	10	6	0
Rutland, Jos. Esq.	10	6	0
Scott & Oram	10	6	0
Seaman, F. W.	5	0	0
Shaw, David	10	6	0
Spooner, Fras. Esq.	10	6	0

Stallard, Josh.	1	0	0
Stallard, Lieut.-Col.	1	0	0
Temple, Mrs. P.	1	1	0
Turley & Co. Messrs.	10	6	0
Walker, Hy. Esq.	1	1	0
Williamson & Son	10	0	0
Box at the Hop Mar- ket Hotel	1	14	0
Box at the Bell Hotel	17	0	0
Total	39	4	0

Donations.

Jefferis, B. Esq.	10	0	0
Lea, C. W. Esq.	100	0	0
Thorn, Rev.	1	1	0
Total Dons	101	11	0
Total Subs	39	4	0
£140	15	0	

Yorkshire.
BRADFORD BRANCH

Chairman—
FREDK. PRIESTMAN, Esq.
Honorary Secretary—
J. A. GODWIN, Esq.

Annual Subscriptions.

Ackroyd, W. & Co. Messrs.	2	2	0
Albrecht & Albrecht, Messrs.	2	2	0
Alexander, E. & Son, Messrs.	1	1	0
Ambler, J. and Son, Messrs.	1	1	0
Ambler, Thos. & Son, Messrs.	1	1	0
Anderton, Swithen, & Sons, Messrs.	2	2	0
Anonymous	10	0	0
Armitage, J. R. Esq.	1	1	0
Aykroyd, Chas. Esq.	1	1	0
J.P.	1	1	0
Aykroyd, Jon. Sen. Esq.	1	1	0
Aykroyd, Jon. Jun. Esq.	1	1	0
Bairstow, T. & M. Messrs.	1	1	0
Beckenbach and Co. Messrs.	1	1	0
Bell, E. & Co. Messrs.	2	2	0
Berendt and Réé, Messrs.	3	3	0
Best, A. & Son, Messrs.	10	6	0
Bottomley, M. Jun. and Co. Messrs.	1	1	0
Bottomley, S. & Bros. Messrs.	2	2	0
Briggs, Arthur, Esq. J.P.	1	1	0
Brown, George, Esq.	10	6	0
Busfield, J. A. Esq.	1	1	0
Chamberlin, Donner and Co. Mes-rs.	1	1	0
Clifton, E. Esq.	1	1	0
Cockerham, Ed. Esq., J.P.	1	1	0
Cohen, B. Esq.	1	1	0
Collins, William, Esq.	1	1	0
Cordingley, Arm- strong, and Co. Messrs.	1	1	0
Craven, Joseph, Esq. Ashfield, Thornton	2	2	0
Delius, D. & R. Messrs.	1	1	0
Drake, N. Esq.	1	1	0

£.	s.	d.	£.	s.	d.		
Drummond, Jas. Esq.	1	1	0	Popplewell, J.B. Esq.	1	1	0
Drummond, Jno. Esq.	1	1	0	Posselt, E. and Co.			
Fawcett, Richard, Esq.	1	1	0	Messrs.	1	1	0
Firth, T. A. Esq.	1	1	0	Povel, L. Esq.	10	6	
Firth, William & Sons, Messrs.	1	1	0	Priestley, Briggs, and Co. Messrs.	1	1	0
Forster, Rt. Hon. W. E., M.P.	1	1	0	Priestman, A. Esq.	10	6	
Foster, John & Son, Messrs.	5	5	0	*Priestman, John & Co.	10	0	0
Fox and Whitley, Messrs.	1	1	0	Quitowz and Co.			
*Garnett, Wm. & Co. Messrs.	1	1	0	Messrs.	1	1	0
Getz and Co. Messrs.	2	2	0	Ramsden, Wm. Esq.	1	1	0
Gillies, Garnett, & Co. Messrs.	1	1	0	Rand and Son, J. Messrs.	1	1	0
Godwin, J. V. Esq. J.P.	1	1	0	Reichenhelm, N. Sons, & Co. Messrs.	2	2	0
Goldsmith, P. & Co. Messrs.	1	1	0	Reiss Bros. Messrs.	1	1	0
Haggas & Sons, Jas. Messrs.	2	2	0	*Renton, T. L. Esq.	1	1	0
Halstead, H. R. & Co. Messrs.	1	1	0	Richardson, Geo. Esq.	10	6	
Hargreaves, G. & Co. Messrs.	1	1	0	Ripley, Sir H. W., Bart.	3	3	0
Harrison and Singleton, Messrs.	1	1	0	Robertshaw & Sons, Messrs.	1	0	0
Heilborn, Ferdinand, Esq.	1	1	0	Rothenstein and Co. Messrs.	1	1	0
Henry & Co. Messrs. A. and S.	3	3	0	Sachs, H. W. Esq.	1	1	0
Hertz, M. and Co. Messrs.	1	1	0	Salmood, David, Esq. J.P.	1	1	0
Hertz, W. D. and Co. Messrs.	1	1	0	Salt, Titus, Esq., J.P.	2	2	0
Heyn, Franc, & Co. Messrs.	1	1	0	Samson and Lepoc, Messrs.	2	2	0
Heyneman, Edw. Esq.	1	1	0	Sawdon & Co. G. E. Messrs.	1	1	0
Hodgson, Geo. & Co. Messrs.	2	2	0	Schaub, Wm. & Co. Messrs.	1	1	0
Hoffman and Co. Messrs.	1	1	0	Schlesinger & Wechmar, Messrs.	1	1	0
Holden, Angus, Esq. J.P.	5	5	0	Schuster, Fulda, and Co. Messrs.	1	1	0
Holden, Isaac, Esq. J.P.	3	3	0	Scott, Silas, and Son, Messrs.	1	0	0
Hyne, Rev. C. W. Bierley	1	1	0	Sharp, Jonas, & Sons, Messrs.	1	1	0
Illingworth, J. Esq.	10	6		Simon, Israel, & Co. Messrs.	2	2	0
Jacobs, Adolph & Co. Messrs.	1	1	0	Smith, John, & Sons, Messrs.	1	1	0
Jonas, Simonson, & Co. Messrs.	1	1	0	Stansfeld, Brown, and Co. Messrs.	1	1	0
Kell & Co. Messrs.	1	1	0	Stavert, Zigomala, and Co. Messrs.	1	1	0
Kessler & Co. Messrs.	1	1	0	Steinthal, C. G. Esq.	1	1	0
Knowles, Cooke, and Co. Messrs.	1	1	0	*Steinthal and Co. Messrs.	2	2	0
*Lassen, A. W. Esq.	1	1	0	Studen and Briggs, Messrs.	1	1	0
Lassen, Mrs. (1880-1)	2	2	0	Sussmann, A. Esq.	1	1	0
Law, Russell, & Co. Messrs.	2	2	0	Tafel, C. & Co. Messrs.	1	1	0
Leather, G. H. & Co. Messrs.	1	1	0	Thwaites & Garbutt, Messrs.	1	1	0
Leather, S. Esq. (1880-1)	2	2	0	Thistlethwaite, J. & Co. Messrs.	1	1	0
Lee, A. Esq.	10	6		Thompson, James, Esq. (1881-2)	2	2	0
Leeming, John & Son, Messrs.	1	1	0	Thompson, M. W. Esq. J.P.	3	3	0
Lewis & Co. Messrs.	1	1	0	Todd, John, & Sons, Messrs.	1	1	0
Lord, W. G. Esq.	10	6		Townend Brothers, Messrs.	1	1	0
Lund, Charles, Esq.	10	6		Turner, Geo. & Co. Messrs.	3	3	0
*Lupton, G. W. Esq.	1	1	0	Wade, E. H. Esq. J.P.	1	1	0
Mahler, Sichel & Co. Messrs.	10	6		Wade, J. H., J.P.	1	1	0
Mason, Henry, Esq.	2	2	0	West, Edw. Esq.	1	1	0
*McGowen, T. W. Esq.	1	1	0	Wilckham, L. W. Esq.	1	1	0
Mitchell Bros. Messrs.	2	2	0	Wiley and Brother, Messrs.	1	1	0
Mitchell & Shepherd, Messrs.	1	1	0	Wood, B. & Co. Messrs.	1	1	0
Muff, T. P. Esq.	10	6		Yates, Robert, Esq.	1	1	0
Müller, George, Esq.	10	6					
*Muller, H. Esq.	10	6					
Oates, Ingham, & Co. Messrs.	1	1	0				
Oddy, Jas. C. Esq.	1	1	0				
Philipp, J. and Co. Messrs.	2	2	0				
Pickles, Joseph & Co. Messrs.	1	1	0				

Fraser, J. W. Esq.	5	0	0
Holdsworth, J. Esq.			
collected by	4	15	0
Honeymann, E. Esq.	1	1	0
Knight, J. P. Esq.	1	1	0
Müller, H. Esq.	10	10	0
Ormerod, Th. Esq.	1	1	0
Rayner, J. Esq.	10	10	0
Rawson, Miss	100	0	0
Scharff, Ed. Esq.	1	1	0
Steinschen, — Esq.	10	10	0
Stubbins, J. K. Esq.	10	10	0
Tennant, J. B. Esq.	5	0	0
Wood, Jas. Esq.	1	0	0
Woodrow, — Esq.	10	10	0
Total Dons	122	7	0
Total Subs.	187	6	6
	£309	13	6

BRIDLINGTON BRANCH.

£.	s.	d.
Chairman—		
E. R. HARDING, Esq.		
Honorary Secretary—		
ALFRED WEST, Esq.		
Annual Subscriptions.		
Barnby, Mrs. H.	10	0
Bedwell, F. A.	10	0
Blakeney, Rev. R. P.	10	0
Blundell, H. S.	10	0
Brett, F. C.	10	0
Broadley, W. H. H.	1	0
Broomhead, T.	1	0
Chapman, Rev. C. J.	5	0
Cooper, J. R.	10	6
Crathorne, J., Beverley	10	0
*Creyke, Capt. R.N.	1	0
Crompton, Mrs.	5	0
Deane, Mrs.	5	0
Fisher, Rev. R.	5	0
Fletcher, Mrs.	10	0
Garton, Mrs.	5	0
Greame, Rev. Y. L.	2	0
*Harding, E. R.	10	0
Harrison, Mrs.	5	0
Hudson, Rev. C.	10	0
Hull Trinity House	5	0
Hutchinson, C. F.	5	0
Jameson, J. A.	1	0
Jarratt, W. O.	10	0
Lee, M. C.	10	0
Marshall, H.	10	0
Medforth & Hutchinson	5	0
Morris, Miss	10	0
Neale, F.	5	0
Nicholson, W.	5	0
Owston, D.	5	0
Pease & Co. Beverley	10	0
Pollard, Mrs. W.	5	0
Preston, R. D.	10	0
Prickett, Colonel.	10	0
Richardson, George	5	0
Richardson, M.	5	0
*Rickaby, J.	10	0
Savage, Miss	5	0
Storrs, Rev. G. Noel	5	0
Thompson, Rev. J.	10	0
Travis, J.	5	0
Walton, Rev. N.	10	0
Wentworth, J.	5	0
Williamson, J.	10	0
York Union Bank	5	0
Sums under 5s.	3	18
	£37	0

£.	s.	d.
Collecting Box	6	15
Total	£37	0

FILEY BRANCH.

£.	s.	d.
Chairman—		
HENRY DARLEY, Esq., J.P.		
Honorary Secretary—		
W. HANKES, Esq.		
Annual Subscriptions.		
A Friend	10	0
Alderson, Miss	5	0
A. P.	5	0
Beswick, Wm. J.P.	1	0
Beswick, Thos.	1	0
*Birch, M.	1	0
Blyth, N.	5	0
Clarke, Miss	15	0
*Cooper, Rev. A. N.	10	0
C. R.	5	0
Curry, H.	10	0
*Darley, Henry, J.P.	2	2
Dawes, Geo.	1	0
Dehhurst,	1	0
Ellis, Edward.	5	0
*Green, E. H.	1	0
Guy, J. P.	10	0
Harrison, Miss	1	0
Head, Mrs.	5	0
Hincks, Mrs.	5	0
Hobson, Mrs.	5	0
Hurt, Miss E.	1	0
Hurt, Miss F.	2	2
Hurt, Miss S.	1	0
Laycock, Wm.	5	0
Liddell, D. G.	5	0
Liepman, J.	5	0
Little, F. C.	5	0
Lowther, Geo.	1	0
Mallesson, Wm.	10	0
Mapney, C.	5	0
Mathews, F. C.	10	0
Mitford, Col.	3	3
Nicholson, Mrs.	1	0
*Phillips, J.	2	2
P. W.	5	0
Quilter, Miss	10	0
Stratford, Mrs.	1	0
Sullivan, H. N.	7	6
Taylor, J. W.	5	0
Waterwren, Mrs.	5	0
Wheelhouse, C. G. M.D.	1	0
York, the Archbishop of.	1	0
Sums under 5s.	4	19
Total	£42	6

£.	s.	d.
Half Net proceeds of Concert presented to Institution by Miss Long	3	3
Contribution Boxes—		
Pillar box	3	15
Pease & Co. Beverley	10	6
Crescent Hotel Do.	16	0
Railway Station Do.	11	0
	£51	2

FLAMBOROUGH BRANCH.

£.	s.	d.
Honorary Secretary—		
Rev. J. F. WILKINSON, M.A.		
Annual Subscriptions.		
Childers, C. H. Esq.	1	0
Harding, Messrs	1	0
Total	£2	0

BRANCHES—LIST OF ANNUAL SUBSCRIPTIONS AND DONATIONS. 599

HORNSEA BRANCH.

Chairman— WILLIAM DYSON, Jun., Esq.	
Honorary Secretary— GEORGE MILNER, Esq.	
Annual Subscriptions.	£. s. d.
*Bateson, H.	5 0
Boden, W. H.	10 0
Bolton, Edward	1 1 0
Broadley, W. H. Esq.	
M.P.	1 0 0
Brodrick, H. W.	1 1 0
Clark, George	1 0 0
Constable, H. S.	1 1 0
Dalton, Holmes & Co.	10 0
Dock Company, The	
Hull	3 3 0
*Dyson, W. Jun.	10 6
Earle, G. H.	10 0
*Foster, Heaton	10 0
French, E.	10 0
*Gibson, H. H.	5 0
Haller, —	10 6
Henson, W. K.	10 6
*Heslop, George	5 0
*Heslop, John	5 0
Hodson, F., M.D.	10 6
Holmes, T. B.	2 2 0
Hudson, M. C., 1880—	
1881	1 0 0
Jones, J. T.	5 0
Jones, G.	
Laking, C.	5 0
Loft, Mrs.	5 0
Loten, R. P.	5 0
Maw, A.	10 0
Marshall, Mrs.	10 0
Meyer, Julius	5 0
*Mittler, Geo.	2 6
Montgomery & Son	10 0
*Samman, H.	10 6
Shackles, C. F.	1 1 0
Shackles, G. L.	1 1 0
*Smithson, C. F.	1 1 0
Sollitt, W.	1 1 0
Spaulding, Miss	10 0
*Spink, Geo.	5 0
Spence, J. S.	10 0
*Todd, C. J.	10 0
Trinity House	5 0 0
Twamley, Rev. J.	5 0
*Wells, B. L.	10 6
Whateley, Rev. Canon—	10 0
Total.....	32 12 6

Donations.	
Mr. G. Milner, proceeds of Concert.	4 2 4
Collection, Hornsea Church, per Rev. E. L. H. Tew	3 2 3
J. Shaw, Esq. London 1 0 0	
Sale of Photos, per Rev. R. Y. Whitehead	8 0
Collecting Boxes	1 5 2
Total Dons.	9 17 9
Total Subs.	32 12 6
£42 10 3	

Huddersfield BRANCH.

Honorary Secretary— J. A. HARRISON, Esq.	
Annual Subscriptions.	
Barker, Henry (Sol.)	1 1 0
Barnicot, John	2 2 0
Bibby, L. R. (Sol.)	1 1 0
Botomley, Mrs. J. (Gledhoit)	1 1 0

Bradbury, T. H. (Bradley)	1 1 0
Brigg, J. F., J.P.	1 1 0
Brook, Jonas, & Bros.	5 0 0
Brook, Freeman, and Batley	2 2 0
Brook, George (Dundas Street)	5 0 0
Brook, Henry (Field-house)	1 1 0
Brooke, E., J.P. (Edgerton)	1 1 0
Brooke, John, & Sons	5 0 0
Clegg, Jesse	1 1 0
Cresswell, Miss	1 1 0
Crosland, J. W. (the late)	2 2 0
Crowther, Henry & Sons (the late)	2 2 0
Day, John, and Sons	2 2 0
Drury, Wm.	1 1 0
Dyson, Geo. (Sol.)	1 1 0
Dyson, Jos., and Sons	1 1 0
Dyson, Law & Son	1 1 0
Eastwood, Fredk.	1 1 0
Foster (Surgeon)	1 1 0
Fryer, Hy (the late)	1 1 0
Gledhill, L., and Co.	1 1 0
Graham, Major	1 1 0
Haigh, Allen	1 1 0
Haigh, W. R., J.P.	1 1 0
Hale, Thomas	1 1 0
Harrop, John (Hornbury)	1 1 0
Heron, Charles	1 1 0
Hirst, Ben.	1 1 0
Hirst, T. E. (Edgerton)	1 1 0
Holliday, R. & Sons	2 2 0
Hughes, Edward, F.R.I.B.A.	1 1 0
Huth and Fischer	1 1 0
Kaye, John, J.P.	1 1 0
Keighley, C. W.	1 1 0
Keighley, T. B.	1 1 0
King, Wm.	1 1 0
Laycock, J. C.	1 1 0
Learoyd, C. W.	1 1 0
Learoyd, S. (Sol.)	1 1 0
Leibreich & Beardsell	1 1 0
Lockwood, Ben.	1 1 0
Lockwood, Brothers (1880 & 1881)	2 2 0
Lowenthal Bros.	2 2 0
Mallinson, W.	1 1 0
Martin, Sons and Co.	2 2 0
Midgley, D. & Sons	2 2 0
Norton, Thos., J.P.	1 1 0
Robinson and Brewer	1 1 0
Savery, F. P.	1 1 0
Schofield, B.	1 1 0
Scott, Wm., M.D. (Melbourne House)	1 1 0
Shaw, J. W. and H.	1 1 0
Skilbeck, R., J.P.	1 1 0
Starkey, Bros.	5 0 0
Sykes, E., & Sons (Gosport)	1 1 0
Sykes, Jas. Nield, J.P.	1 1 0
Sykes, John & Sons (Turnbridge)	1 1 0
Sykes, John (Sol.)	1 1 0
Sykes, Jos (the late) (Woodhouse)	1 1 0
Taylor, H. B.	1 1 0
Taylor, John, & Sons	2 2 0
Taylor & Littlewood	1 1 0
Terry, Henry, & Co.	1 1 0
Thompson, George	1 1 0
Tinker, C. S. (Hepworth)	1 1 0
Tinker, Henry	1 1 0
Turner, John (Fitzwilliam Terrace)	1 1 0
Tomlinson, Mrs. G. W.	1 1 0
Vickerman, B. and Sons	1 1 0
Walker, Alfred, J.P.	1 1 0
Watkinson, James, & Sons	2 2 0

Wrigley, John, and Sons	1 1 0
Wilkinson, John, & Son	1 1 0
Wilson and Price	1 1 0
Woodhead, Mrs. E.B.	1 1 0
Total.....	111 7 0
Donations.	
"Frederick"	2 0 0
Marsden, R.	10 0
Webb, T. R.	10 0
Total Dons.	3 0 0
Total Subs.	111 7 0
£114 7 0	

HULL BRANCH.

Chairman— Dr. LAMB.	
Honorary Secretary— WILLIAM DYSON, Esq.	
Annual Subscriptions.	
Allison Bros. Messrs.	10 6
Atkinson, H. J. Esq.	10 6
Bach & Co. Messrs. T.	10 6
Baxter & Tall, Messrs.	1 1 0
Bedell, Benj. Esq.	1 1 0
Bitton and Co. Messrs. J.	1 1 0
Boden & Co. Messrs. J.	10 6
Briggs, Henry, Esq.	10 6
Broadley, W. H. H., M.P.	1 1 0
Brochner and Co. Messrs. C. C.	2 2 0
Buckton and Sons, Messrs. Geo.	10 6
Butner and Field, Messrs.	10 6
Burstall and Huffam, Messrs.	10 6
Burwell and Co. Messrs. E.	10 6
Burwell, W.	1 1 0
Carrick, Theo. Esq.	10 6
Carver & Co. Messrs.	10 6
Chambers and Fargus, Messrs.	10 0
Cooke, Miss	10 0
Coulthard, J. Esq.	10 6
Davis, E. and Co.	2 2 0
Des Forges & Sons, Messrs.	10 6
Dossor, Capt.	1 1 0
Dyson, W. Esq., Hon. Sec.	10 6
Earle, Messrs. G. & T.	10 0
Earle and Haller, Messrs.	1 1 0
Easton & Sons, Messrs. John	10 0
England, Saxelbyes, & Sharpe, Messrs.	1 1 0
English, Miss	10 6
Eyre & Co. Messrs.	10 6
Foster & Co. Messrs. John	10 6
Gibson and Son	1 1 0
Gleadow and Dibb	1 1 0
Good, Flodman, & Co.	1 1 0
Grotrian, F. B. Esq.	10 6
Hall & Co. Messrs. J.	1 1 0
Hammond, Ems, and Co. Messrs.	10 6
Hardy, George, Esq.	10 6
Harrison Brothers	1 1 0
Hart, G. W. Esq.	10 6
Helmsing and Son	10 6
Hewetson, Misses	10 6
Hill, J. H. Esq.	10 6
Hill, Messrs. James T. and N.	1 1 0
Hirst and Cooke	10 6
Holmes, T. B. Esq.	10 6

Hornsted and Garthorne, Messrs.	1 1 0
Horsley, Smith, & Co.	1 1 0
Jameson, Robt. Esq.	1 1 0
Joy and Sons, Messrs. Wm.	1 1 0
Keighly, Maxsted, & Co. Messrs.	1 1 0
King & Co. Messrs.	10 6
King, W. R. Esq.	2 2 0
Kuypers, Ostler, and Scott	10 6
Lambert, S. Esq.	10 6
Londesborough, Lord, The Right Hon.	10 10 0
Malcolm and Son, Messrs. George	10 6
Marillier, R. A. Esq.	10 6
Marris, Willows, and Smith, Messrs.	10 6
Marshall, W. T.	10 6
Martin, R. Esq.	10 6
Mason, B. E. Esq.	10 6
Mason, Capt. W. S.	10 6
Mason, Mr. Wright	10 6
Massey and Sawyer	10 6
Maw, Tull, Kirke & Co., Messrs.	1 1 0
Moss, J. S. Esq.	10 6
Newton Bros. Messrs.	10 6
Norwood, C. M. Esq.	
M.P.	2 2 0
Pauling, A. Esq.	10 6
Peasegood, W. Esq.	10 6
Pease and Sons, Messrs.	2 2 0
Pope and Pearson	1 1 0
Rayment & Sharpe	10 6
Rawson, W. and J. Robinson, Messrs.	10 6
Reckitt and Sons, Messrs. Isaac	1 1 0
Ripon, Right Hon. the Marquis of	2 2 0
Seaton, J. L. Esq.	10 0
Shaw and Pearson	10 6
Sisson's Brothers and Co. Messrs.	1 1 0
Smith Brothers and Co. Messrs. S.	2 2 0
Smith, Hill, and Co.	1 1 0
Smith, H. Esq.	1 11 6
Smith, Miss	10 6
Smith, W. N. Esq.	10 6
Storry, Smithson, & Co. Messrs.	1 1 0
Storry, Witty, & Co.	10 6
Tealy & Co. Messrs.	1 1 0
The Minerva Lodge (No. 250) of Ancient Free and Accepted Masons	2 2 0
Tholander, Capt. O.	10 6
Thorney, J. J. Esq.	10 6
Tudor, S. and Sons	10 6
Veltmann and Co. Messrs. N.	1 1 0
Wade, Sons, and Co. Messrs. Richard	2 2 0
Walker, Joseph, Esq.	10 6
Walliker, S. Esq.	10 6
White, Son, & Stratton, Messrs.	1 1 0
Wilson, E. S. Esq.	1 1 0
Wilson, David, Esq.	1 1 0
Wilson, Sons, & Co. Messrs. Thomas	10 10 0
Winkley and Co., Messrs. J.	1 1 0
Woods Bros. Messrs.	1 1 0
Sums under 10s.	3 10 0
Sums under 5s.	7 6
Total.....	109 5 0

Donations.	
Box at E. Davis & Co's.	6 0
£109 11 0	

KEIGHLEY BRANCH.

Treasurer—	
JOHN BRIGG, Esq., J.P.	
Honorary Secretary—	
EDMUND LAYCOCK, Esq.	
Annual Subscriptions.	
£.	s. d.
Bailey, Isaac.....	10 0
Bairstow, W. & J... 1	1 0
*Brigg, John, & Co. Messrs.....	2 2 0
Burton, Charles....	5 0
Cattle, John.....	5 0
Clapham Brothers, Messrs.....	1 1 0
Clough, Mr. Robert. 2	2 0
Dixon, Joseph.....	5 0
Foulds, Israel.....	5 0
Graham, Mrs. Ikley 1	0 0
Hall & Steel, Messrs. 1	1 0
Hattersley, Geo. and Sons, Messrs....	1 1 0
Jennings, Mr. Jon. 1	1 0
Keighley, Mr. S.....	1 1 0
Laycock, Wm. & Sons, (Currier).....	5 0
Laycock, John Wm. 1	1 0
Laycock, Miss.....	10 0
Lund, Wm. and Son, Messrs.....	2 2 0
Marriner, B. and W. Messrs.....	1 1 0
Rhodes, Mr. John....	5 0
Rhodes, Mrs.....	5 0
Rushworth Brothers, Messrs.....	1 1 0
Smith and Sons, Messrs.....	10 6
Smith, John.....	5 0
Smith, Jonas.....	5 0
*Smith and McLaren 1	1 0
Smith, P. and Son....	2 2 0
Spencer, G. E.....	1 1 0
*Sugden Jonas, Bros. 1	1 0
Sugden, Wm.....	5 0
Summerscales, W. & Son, Messrs.....	2 2 0
Sunderland, John....	5 0
Wall, Thos.....	10 0
Waterhouse, Wm....	5 0
Waterworth, Wm....	5 0
Weatherhead and W. and G. Burr, Messrs. 1	1 0
Weatherhead, Wm....	10 6
Whitley, Mr. J.....	5 0
Wilkinson, Mr. C. H..	5 0
Total.....£31 9 0	

LEEDS BRANCH.

President—	
W. BECKETT DENISON, Esq.	
Honorary Secretary—	
HERMAN LUDOLF, Esq.	
Annual Subscriptions.	
Appleyard, T. Esq....	1 1 0
Ashworth, S. P. Esq. 1	1 0
Atkinson, D. H. Esq..	10 0
Baines, Sir E.....	1 1 0
Baines, M. Esq.....	10 6
Barran, J. Esq.....	1 1 0
Bedford, James, Esq..	5 0
Beverly, Mrs. Wm....	10 0
Bilbrough, Miss.....	0 10
Briggs & Co. Messrs. 1	1 0
Briscall, Henry, Esq..	10 6
Brown, S. J. Esq.....	2 2 0
Browne, Rev. R.....	10 6
Buckley and Sons....	2 2 0
Buckton, R. & Sons. 1	1 0
Burkhill, J. H. Esq... 1	1 0
Cattanock & Co. Messrs.	10 6
Charlesworth, Miss C.	10 6

Conder, Rev. E. R....	10 6
Conyers, Messrs.	
Josh. & Sons.....	5 0 0
Craven, H. Esq.....	1 1 0
Croft, Samuel, Esq... 1	1 0
Crothwaite, Rev. B..	10 6
Darwin, F. Esq.....	1 1 0
Dawson, Thos. Esq... 10	6
Dayson, J. O. Esq....	10 6
Denison, W. B., Esq. 2	2 0
Denny, Mr. C. E.....	5 0
Dixon, J. Esq.....	10 6
Douglas, John, Esq.. 1	1 0
Flitch, J. J. & Son, Messrs.....	1 1 0
Fraser, J. B. Esq....	10 6
Gaines, Thomas, Esq.	5 0
Galsworthy, R. Esq..	10 6
Gaunt, Isaac.....	1 1 0
Gladstone, Herbert, Esq. M.P.....	1 0 0
Granger, Chas. Esq..	5 0
Greenwood & Batley, Messrs.....	1 1 0
Hall, William, Esq... 10	0
Harrison and Co. Messrs. R.....	1 1 0
Harvey & Reynolds. 1	1 0
Hathorn, Davey & Co., Messrs.....	10 6
Heaton, Miss E.....	10 0
Hebblichwaite Bros. Messrs.....	1 1 0
Hepper and Sons, Messrs.....	1 1 0
Hotham & Whiting, Messrs.....	10 6
Howitt & Pemberton, Messrs.....	1 1 0
Hudswell, Clark, & Rodgers.....	10 6
Hyam & Co. Messrs. 1	1 0
Ingham, Wm. Esq... 1	1 0
Jackson, W. L. Esq. M.P.....	1 1 0
Jowitt, John, Esq... 1	1 0
Joy, W. H. Esq.....	10 6
Kitson, Messrs. Jas. and Co.....	2 2 0
Lambert, Wm. Esq... 10	6
Lawson, Messrs. S. and Sons.....	1 0 0
Ludolf, Herman.... 1	1 0
McConnell, Messrs. A. and J.....	10 6
Maclea and March, Messrs.....	1 1 0
Manning, Wardle, & Co. Messrs.....	1 1 0
Marcan & Co. Messrs.	10 6
Marshall & Snelgrove, Messrs.....	1 1 0
Marshall, A. Esq....	2 2 0
Megeson, Geo. Esq... 10	6
Metcalfe, G. Esq....	1 1 0
Middleton, Wm. Esq. 1	1 0
Milling (Partners)... 1	1 0
Moorhouse & Co. Messrs.....	1 1 0
Newstead, J. S. Esq.. 10	6
North, William, Esq. 1	1 0
Nusse, Thomas.... 10	6
Nusse, O. Esq.....	10 6
Oxley, Henry, Esq... 1	1 0
Patent Woollen Cloth Co.....	1 0 0
Pearson, J. T. Esq... 10	6
Rayner, John, Esq... 1	1 0
Reimayne, Jno. Esq.. 10	6
Riley, H. W. Esq.... 10	6
Robinson, Joshua, Esq.....	1 1 0
Schmitz, H. Esq....	5 0
Shackleton, J. Esq.. 10	6
Simpson, J. W. Esq. 1	0 0
Smeeton, W. Esq... 10	0
Smeeton & Butler. 1	1 0
Smith, Albert, Esq.. 10	6
Taylor, Bros. Messrs. 2	2 0
Taylor, Henry, Esq. 1	1 0
Taylor and Sons, Messrs. Joshua... 3	3 0

Thrippleton, J. W. Esq.....	1 10 0
Town and Sons, Messrs. J.....	1 1 0
Turner, R. B. Esq... 1	1 0
Turton, W. Esq.....	5 0
Urquhart, Mrs.....	1 1 0
Walker, I. D. Esq... 10	6
Wharnciffe, Right Hon. Lord.....	1 0 0
Wilson, Walker, and Co. Messrs.....	1 1 0
Wood, T. M. Esq.... 10	6
Yorke, John, Esq... 2	0 0
Boxes.....	8 4
Total.....£92 19 4	

ROBIN HOOD'S BAY BRANCH.

Hon. Secretary—	
Rev. R. JERMYN COOPER.	
Annual Subscriptions.	
*Barry, J. W. Esq... 2	2 0
*Bedlington, Mr. Mat. 1	1 0
*Bedlington, Mr. Wm. 1	0 0
*Cooper, Rev. R. J. 2	2 0
*Gibson, Captain... 1	0 0
*Grainger, Mr. Benj. 1	0 0
*Houghton, Captain. 1	1 0
*Storm, Mr. Edward 1	0 0
*Storm, Mr. Matthew 1	1 0
*Wellburn, Mr. Mat. 1	0 0
Total.....12 7 0	
Donations.	
Beddoes, Miss, Clifton Blandford, Mrs. 5	0 0
Sponden, Derby... 1	1 0
By Harbour Master, Whitley.....	3 0 0
Fisher, Charles, Esq. Whitley.....	5 0 0
Hammond, W. H. Esq.....	1 1 0
Total Dons.....15 2 0	
Total Subs.....12 7 0	
£27 9 0	

RUNSWICK BRANCH.

Patron—	
The Most Noble the MARQUIS OF NORMANBY.	
President—	
C. M. PALMER, Esq.	
Honorary Secretary—	
Dr. J. V. LAVERICK.	
Annual Subscriptions.	
Chaloner, Admiral... 2	2 0
Chomley, Mrs. H.... 1	1 0
Hilyard, Rev. H.S... 1	0 0
Kerr, John, Esq.... 10	6
Laverick, Dr. J. V... 10	6
Logan, W. Esq..... 1	1 0
Palmer, C. M. Esq... 3	3 0
Stephens, Capt. D. W.	10 6
*Webster, Robt. Esq. 10	6
Total.....10 9 0	

SCARBOROUGH BRANCH.

Chairman—	
PRESIDENT OF TRINITY HOUSE.	
Treasurer—	
J. W. WOODALL, Esq.	
Honorary Secretaries—	
JOHN STEPHENSON, Esq. A. E. HUCK, Esq.	
Annual Subscriptions.	
£.	s. d.
Blunt, Ven. Archdeacon, D.D.....	5 0
Bottomley, Miss.....	5 0
Bright & Sons.....	5 0
Burland, Miss.....	1 0 0
Caine, W. S. Esq. M.P. 2	0 0
Calvert, F. W. Esq... 5	0
Cankrien, Miss.....	5 0
Cathcart, Earl.....	1 0 0
Collinson, R. Esq... 5	0
Craven, Miss Mary... 5	0
Cross, Dr.....	5 0
Denby, Jesse, Esq.. 5	0
Derwent, the Rt. Hon. Lord.....	2 2 0
Ellershaw, R. J. Esq. 1	1 0
Finch, Esq.....	1 1 0
Forster, H. H. Esq... 1	1 0
Forster, R. Esq.... 5	0
*Fowler, Benj. Esq.. 5	0
Gratton, Colonel.... 5	0
Hall, Mrs. Sidney... 10	0
Hamerton, Rev. C... 10	0
Harrison, Mrs.....	10 0
Hebden, E. H. Esq... 1	1 0
Hebden, Wm. Esq... 1	1 0
Hemsworth, B. Esq.. 10	0
Hick, M. Esq.....	5 0
*Hick, P. Esq.....	5 0
*Hick, T. Esq.....	5 0
Holroyd, Miss Eliz. 1	1 0
Holroyd, Miss Emma 1	0 0
Hudson, G. and H., & Co.....	5 0
Hugill, Thos. Esq... 1	1 0
*Inglis, Col.....	10 0
Inglis, Miss, per R. H. D. Mahon, Esq. 1	0 0
Jackson, Geo. Esq... 1	0 0
Lea, George, Esq.... 5	0
Leigh, Hon. Augusta 5	0
Mahon, R. H. D. Esq. 2	0 0
Mahon, Mrs.....	2 0 0
Marshall, Mrs.....	10 0
Morris, R. M. & Co. 5	0
Newton, E. H. Esq.. 10	0
Owen, R. Esq.....	10 0
Parkinson, A. Esq... 1	1 0
Peacock, C. J. Esq... 10	6
Petrie, Mrs.....	5 0
Porrett, G. Esq.... 5	0
Reed, Mr.....	5 0
Robinson, Colonel... 5	0
Rodham, Mrs.....	10 6
Rowntree, J. Esq... 10	6
Rowntree, W. Esq... 10	6
Sitwell, Lady.....	5 0
*Smith, Geo. Alderson, Esq.....	10 0
Stead, Samuel, Esq.. 5	0
Stephen, Miss.....	10 6
Teale, J. W. Esq... 5	0
Theakstone, S. W. & Co.....	5 0
Tindall, Mrs.....	10 6
Tindall, Mrs. R. H.. 10	0
Tindall, John, Esq.. 1	1 0
Uppley, Mrs. (the late).....	10 0
Vassalli, Mr. J.....	5 0
Wales, Miss.....	5 0
Walker, H. Esq.... 5	0
Ward, Rev. G. A.....	5 0
Whittaker, Thos. Esq.	5 0
Wintle, Miss.....	5 0
Woodall, Chas. W. Esq.....	1 1 0

BRANCHES—LIST OF ANNUAL SUBSCRIPTIONS AND DONATIONS. 601

	£.	s.	d.
*Woodall, J. W. Esq.	1	1	0
Wortley, Hon. F. D.			
M. Stuart	10	0	0
Wray, Mrs.	5	0	0
Sums under 5s.	1	17	6
Total	44	4	6

Donations.			
	£.	s.	d.
Abbotts, Mrs.	5	0	0
Allan, Alex. Esq.	10	0	0
Armitage, R. E.-q.	5	0	0
A Visitor	5	0	0
Banks, Mrs.	5	0	0
Bousefield, Col., Coin- ston.	1	0	0
Cattley, Thomas, Esq.	2	0	0
Crompton, Miss	10	0	0
Dale, Mrs.	5	0	0
Dawes, T. Esq.	10	0	0
Denby, Mrs.	5	0	0
D. M. D.	5	0	0
E. A.	5	0	0
Foster, Rev. C. G.	5	0	0
"General Havelock" s.s., owners of	3	3	0
Haddon, F. J. Esq.	1	0	0
Hamilton, Mr. E., 1, Esplanade	10	0	0
Harris, Mr. Wm.			
Leeds	5	0	0
Holt, G. H. Esq.	5	0	0
Hutchinson, Miss	5	0	0
James, Mrs.	5	0	0
Kendall, Col.	5	0	0
King, J.	5	0	0
Langdale, E.	5	0	0
Milne, Miss.	10	0	0
Moseley, Sir Tomman, Bart.	5	0	0
Preston, Miss	5	0	0
R. C.	10	0	0
Rudgard, R. Esq.	10	0	0
Seager, Lieut.-Gen.	5	0	0
Taylor, T. E.	5	0	0
Travis, W. R. Esq.	5	0	0
Wailes, Miss	5	0	0
Walker, Mrs.	5	0	0
Waterhouse, Miss	5	0	0
Watkins, Miss H.	5	0	0
Willink, W. N. Esq.	5	0	0
Woolley, Miss.	5	0	0
Wright, J. F. Esq.	5	0	0
Small sums.	26	2	1

Boats.			
	£.	s.	d.
Life-boat House	6	13	6
Pillar Box, Esplanade	6	13	7
" Old Cliff	3	7	0
Railway Station	3	10	2
Dolphin Hotel	6	7	
Prince of Wales Hotel	5	1	
Small sums	6	11	

Hotels.			
	£.	s.	d.
Bull Hotel	1	10	0
Cambridge Hotel	3	18	9
Crown Hotel	9	5	0
Prince of Wales Hotel	2	3	0
Swift's Hotel	4	9	3
George Hotel	13	0	
Royal Hotel	2	8	11
Queen Hotel	3	14	9
Edward's Hotel	16	0	
Total Dons.	98	2	3
Total Subs.	44	4	6
£142	6	9	

SETTLE BRANCH.

President—
WALT. MORRISON, Esq.
Honorary Secretary—
C. BROWN, Esq.

Annual Subscriptions.

	£.	s.	d.
Abbotsen, Chas. Esq.	1	1	0
Abbott, Mr. Thos.	5	0	0
A Friend	10	0	0
A Friend	5	0	0
A Friend	5	0	0
Airey, Miss.	5	0	0
Alcock, Wm. Esq.	1	1	0
Ambley, Mr.	5	0	0
Armistead, Mr. H.	5	0	0
Banks, Mr. John	5	0	0
Batten, Mrs.	10	0	0
Battersby, Miss	5	0	0
Birkbeck, John, Esq.	1	1	0
Birkbeck, J. Jun. Esq.	1	0	0
Birkbeck, Jos. Esq.	1	1	0
Birkbeck, Capt. E. S.	1	1	0
Boyd, Rev. Canon	10	0	0
Brayshaw, Miss	10	0	0
Brayshaw, Mrs.	10	6	
Brayshaw, T. Esq.	1	1	0
Brennan, Mrs.	5	0	0
Brockbank, Mr. E.	5	0	0
Bromley, Mr. John	10	0	0
Brown, Chris. Esq.	2	2	0
Bryning, Miss E. M.	5	0	0
Bryning, Miss M.	5	0	0
Burrow, Mrs. the late	10	6	
Bury, Mrs. the late	10	0	0
Butterfield, Mr. John	5	0	0
Chamley, Mr. W.	5	0	0
Charlesworth, C. H. Esq.	1	1	0
Christie, Hector, Esq.	2	2	0
Clapham, T. R. Esq.	1	1	0
Clark, Mr.	10	0	0
Clayton, Miss	1	0	0
Clayton, Mrs.	1	1	0
Coulthurst, Rev. W. H.	10	0	0
Crosley, Mrs.	1	1	0
Davis, Mr. T.	10	0	0
Dawson, W. M. Esq.	1	1	0
Delves, Mr. G.	5	0	0
Ducket, Mr. R.	10	0	0
Ellis, Mr. Francis.	10	0	0
Foster, John, Esq.	10	0	0
Foster, Miss M. H.	1	1	0
Foster, Miss, Settle	10	0	0
Foster, Mrs. E. T.	10	0	0
Foster, Mrs. J. W.	1	1	0
Foster, W. Esq., Nash Court.	1	0	0
Gibson, Mr. G. H.	5	0	0
Gill, Mrs.	1	1	0
Golland, Mrs.	1	0	0
Gore, Mr. H.	5	0	0
Grime, Mr. R.	1	0	0
Grisedale, Mrs.	5	0	0
Hamerton, John, Esq.	1	0	0
Hammond, J. Esq.	1	1	0
Hammond, Miss.	10	0	0
Hammond, Mrs.	5	0	0
Handby, Mr. John	5	0	0
Hargraves, John, Esq.	5	0	0
Hartley, James, Esq.	10	0	0
Hartley, Mr. Jas.	5	0	0
Hartley, J. Esq. (A.)	10	0	0
Hartley, J. Esq. (C.)	10	0	0
Hartley, Robt. Esq.	10	0	0
Harvey, Mr. Thos.	5	0	0
Hawkins, Mr.	10	0	0
Hick, Edw. Esq.	10	6	
Hird, Mr. A.	5	0	0
Holgate, Miss	10	0	0
Holgate, T. Esq. (B.)	10	0	0
Holgate, T. Esq. (N.H.).	1	0	0
Hook, Sergeant.	5	0	0
Horner, Mr. Thos.	5	0	0
Howarth, Mr. Jas.	5	0	0
Howarth, Mr. Wm.	5	0	0
Hubble, Mrs.	10	6	
Hunter, Mr. Wm.	5	0	0

	£.	s.	d.
Ingham, Mr. W.	5	0	0
Ingleby, Chris. Esq.	1	1	0
Ingleby, John, Esq.	1	1	0
Ingleby, Mrs. R.	10	6	
Ingleby, Mrs. Thos.	10	6	
Jackson, Mr. C.	5	0	0
Jackson, Mr. J., Sd.	5	0	0
Jackson, Mr. T.	5	0	0
Jarry, Misses	5	0	0
King, Mr. Hy.	5	0	0
Knowles, Mrs.	1	1	0
Knowles, T. F. Esq.	2	2	0
Laycock, Mr. James	5	0	0
Leeming, Mr. Thos.	5	0	0
Lister, Mr. John	5	0	0
Lister, Mrs. (L. P.)	5	0	0
Marshall, Mrs.	10	0	0
Marshall, T. and J.	10	0	0
Metcalfe, Mr. F.	5	0	0
Metcalfe, Mr. J.	5	0	0
Metcalfe, Mr. R.	5	0	0
Metcalfe, Wm. Esq.	10	0	0
Morley, R. Esq.	2	2	0
Morrison, Walt. Esq.	5	0	0
Moser, Mrs.	1	1	0
Nock, Mrs.	10	0	0
Nowell, Mr. M.	5	0	0
Parkinson, A. Esq.	1	1	0
Parkinson, J. Esq.	1	0	0
Perfect, Mrs.	1	1	0
Peters, Capt. & Mrs.	1	0	0
Pierson, Rev. W. F.	10	0	0
Preston, J. Esq.	1	0	0
Ralph, Mr. Wm.	5	0	0
Ray, Mr. R.	5	0	0
Ray, Mr. W. B.	1	1	0
Robinson, Mrs. D.	1	0	0
Robinson, Rev. Jno.	1	0	0
Robinson, Thos. Esq.	5	0	0
Robinson, Wm. Esq. (the late)	1	1	0
Sdgwick, Miss.	1	0	0
Sdgwick, Mrs. C.	10	0	0
Sdgwick, Mrs. L.	1	1	0
Shepherd, Mrs.	5	0	0
Slinger, Jonath. Esq.	5	0	0
Slinger, Miss, Studf. H.	5	0	0
Smith, Mrs. A.	12	6	
Smith, Mr. Joseph.	5	0	0
Stackhouse, Mrs.	10	0	0
Stackhouse, Mrs.	10	0	0
Stansfeld, Miss	1	2	0
Stansfeld, Mrs.	5	0	0
Starkie, Rev. H. A.	1	1	0
Style, Rev. George.	1	1	0
Sutcliffe, Miss.	1	1	0
Swinbank, Mr. T.	6	0	0
Tatham, Mrs.	10	0	0
Tattersall, W. Esq.	2	2	0
Taylor, Edward, Esq.	10	0	0
Thompson, Jno. Esq.	5	0	0
Thornton, Mrs.	2	2	0
Titterton, T. Esq.	10	0	0
Towler, Wm. Esq.	10	6	
Turner, Mr. Joseph.	5	0	0
Vant, Mr. J. Henry.	5	0	0
Waddington, Mr.	5	0	0
Wilkinson, J. R.	1	1	0
Willis, J. J. Esq.	1	1	0
Winder, Mr. J.	5	0	0
Winskill, Mr.	5	0	0
Yorke, T. E. Esq.	1	1	0
56 Annuals at 2s. 6d.	7	0	0
Sums under 5s.	9	6	
Total	106	1	6

Donations, 1891.

A Friend	5	0	0
A Friend	5	0	0
Arrowsmith, James	10	0	0
Bateson, Giles	5	0	0
Bellamy, J. H. de C. per T. H.	1	1	0
Brown, John, Settle.	7	6	
Buck, Charles W.	5	0	0
Christie, Lorenzo.	10	0	0
Clapham, T. R., Col. Box 1890-1.	1	0	0
Clark, George.	5	0	0

	£.	s.	d.
Commercial Hotel, Harrogate, Col. Box 1890-1.	16	6	
Crabtree, Samuel, per T. H.	1	1	0
Craven Bank Co. (Limited) Interest	3	1	4
Davis, George, per T. H.	1	1	0
Donations, 11 at 2s. 6d.	1	7	6
Eaton, Jas. per T. H.	1	1	0
Estcourt, C.	1	1	0
Evans, D. O.	1	1	0
Farrer, Rev. M. T.	5	0	0
Foster, Miss, M. H.	10	0	0
Gerrard, Miss, col- lecting box, 1890-1	3	1	1
Glover, Frank, per T. H.	1	1	0
Hargreaves, John	5	0	0
Harker, Thomas	1	1	0
Holmes, T. (the late)	10	0	0
Jackson, C. H.-in-R.	5	0	0
Jackson, George	1	6	0
Just, Miss	10	0	0
Kenderdine, F. per T. H.	2	2	0
Kincaid, J. per T. H.	1	1	0
Knowles, T. F.	10	10	0
Mackenzie, J. O. per T. H.	1	1	0
Reid, David, per T. H.	1	1	0
Robinson, Stephen.	6	5	0
Sedgwick, George.	10	0	0
Sidebottom, H. per T. H.	1	1	0
Simpson, E. G.	1	1	0
Simpson, Dr. H.	1	1	0
Simpson, Robert	5	0	0
Slinger, John	5	0	0
Slinger, Miss M. M.	5	0	0
Small Sums, per J. W. E.	6	6	
Stackhouse, Miss B. E.	10	0	0
Sums under 5s.	6	11	
Thwaites, Josh. per T. H.	1	1	0
Vannan, H. per T. H.	1	1	0
Waller, Thomas, London.	2	1	0
Wilson, Rev. R. W. Off. at Sutton-in- Craven Ch.	13	9	6
Wimpenny, A. B. per T. H.	1	1	0
Woolley, G.S. per T. H.	2	2	0
Woolley, Harold	1	1	0
Wrecks	14	3	
Yorke, T. Edward.	1	0	0
Total Dons	86	18	1
Total Subs.	106	1	6
£192	19	7	

Earlier Donations.

A Friend (1875)	20	0	0
Atkinson, Miss (Legacy 1879)	19	19	0
Brown, C. Esq. (1869- 70)	12	1	

SHEFFIELD BRANCH.

President—
The EARL FITZWILLIAM.
Secretaries—
Messrs. NEWMAN H. HUNT & SON.

Annual Subscriptions.

	£.	s.	d.
*Bembridge, J.K. Esq.	1	1	0
*Brown, Sir John	2	2	0
*Burridge, Stephen, Esq.	1	1	0
Chadburn Brothers	1	1	0
Chapman, Samuel	1	1	0
Chesterman and Co.	1	1	0
*Clegg, Alderman W. J.	1	1	0
*Clegg, Councillor J. C.	1	1	0
*Cole Brothers	1	1	0
*Dixon and Sons	2	0	0
Fawcett, Mr.	2	0	0
Firth, C. H.	2	0	0
*Firth, T. and Sons	2	0	0
Fisher, Richard	2	6	
Fowler, Fred	10	0	
Fox, S. & Co. (Lim.)	5	0	
Gilmour, D. and Co.	1	1	0
Hunt, Newman H.	1	1	0
*Jessop, T., two years	2	2	0
Kenyon and Co.	1	1	0
Law, Mr.	10	6	
Marrin, Thomas	1	1	0
Marsh Brothers & Co.	1	1	0
Martin, Hall, and Co.	1	1	0
Newbold, Rev. J. K.	1	1	0
Newton, F. and Sons	1	1	0
Roberts and Belk	1	1	0
Roberts, Miss	1	1	0
Roberts, S. Esq.	1	1	0
Rodgers and Sons	2	0	0
Rossell, H.	1	1	0
Rowley, J. J. Esq.	1	1	6
Sorby and Sons	1	1	0
Spar and Jackson	1	1	0
Stephenson, J. and S.	10	6	
Tennant Brothers	1	1	0
*Thomas, Arthur, Esq.	1	1	0
*Turton, T. and Sons	1	1	0
*Vickers, Sons, & Co.	2	2	0
Walker and Hall	1	1	0
Watson and Sons	1	1	0
Wilks, Miss	1	1	0
Wilson, Hawksworth, Ellison, and Co.	1	1	0
Wilson, Thomas	1	1	0
Wostenhelm, Mrs. G.	2	2	0
Wright, John	10	6	
Donation.			
Webster, Wm.	2	2	0
Total	55	4	0

STAITHES BRANCH.

President—
C. M. PALMER, Esq., M.P.
Chairman—
ГЕОРГЕ ВРОТЧЕР, Esq.
Honorary Secretary—
Dr. J. V. LAVERICK.

Annual Subscriptions.

*Brotchie, George, Esq.	10	6	
Hon. Secretary	10	6	
*Laverick, Capt. G.D.	10	6	
*Palmer, C. M. Esq., M.P.	3	3	0
*Ryder, Mr. William	10	6	
Robinson, Capt. J. J.	10	6	
*Spinks, Mr. Jas.	10	6	
*Verrill, Mr. Josh.	10	6	
Total	6	16	6

Donations.

Collected by Miss Nowell—			
Lady Lowther	1	0	0
Jas. Nowell	10	6	
Small sums	9	6	
Total Dons.	2	0	0
Total Subs.	6	16	6

TEES BAY (NOW MIDDLESBOROUGH AND REDCAR) BRANCH.

Patron—
The EARL OF ZETLAND.
President—
JOSEPH W. PEASE, Esq., M.P.
Honorary Secretaries—
A. O. COCHRANE, Esq.
J. M. MEER, Esq.
Annual Subscriptions.

Backhouse, E. Esq.	1	1	0
Bell Brothers & Co.	6	6	0
Boicrow, Carl.	1	1	0
Boicrow, Vaughan, & Co.	2	2	0
Burger, Mrs.	5	0	0
Chaloner, Admiral	2	2	0
Cradock, J. Esq.	1	1	0
Dodds, Joseph, M.P.	1	1	0
Dorman, Long, & Co.	1	1	0
Fallows, W. Esq.	1	1	0
Lowther, Sir C. H., Bt.	2	2	0
Owners of Middleborough Estate	2	2	0
Pearse & Co. Messrs.	1	1	0
Pease, J. N. Esq., M.P.	2	2	0
Richardson, Duck, & Co., Messrs.	1	1	0
Samuelson, B. & Co.	2	2	0
Swan, J. E. & Bros.	2	2	0
Tees Conservancy Commissioners	3	3	0
Trevor, W. C. Esq.	1	0	0
Walker, D. H. & Co.	1	1	0
Watson & Co. James	1	1	0
Watson, R. Exors.	1	1	0
Wharton, J. T. Esq.	2	2	0
Whitwell, W. & Co.	1	1	0
Total	40	2	0

Donations.

Middlesbro' shipping	37	12	6
Stockton shipping	12	12	3
Total Dons.	50	4	9
Total Subs.	40	2	0
	£90	6	9

SALTBURN BRANCH.

Honorary Secretary—
MR. T. G. PEARSON.
Annual Subscriptions.

*Bell, Bros., Messrs.	2	2	0
Cass, W. E. Esq.	10	0	0
Colledge, Mr. G.	10	0	0
Clayton, Mr. D., Marske	5	0	0
Dickinson, Mr. T.	5	0	0
Frankel, Rev. E. B.	2	0	0
Gilbertson, Mr. R.	10	0	0
Hudson, — Esq., Leeds	10	0	0
Holland, R. Esq.	10	6	0
Hornby, Mr. M.	5	0	0
Irvin, Rev. B.	10	6	0
*P'Anson, J. C. Esq.	1	1	0
P'Anson, W. Esq.	5	0	0
Lazenby, Mr. G.	10	0	0

Melliship, Mr. W.	10	6	
Ollevent, Mr. C.	10	0	
Pease, A. Esq., M.P.	1	0	0
Marske	1	0	0
Pearson, Mr. T. G.	10	0	0
Peacock, Mr. J.	5	0	0
Rhodes, Dr.	10	0	0
Rapp & Son, Messrs.	10	0	0
Robinson, Mr. Watson	5	0	0
Sauby, Mr. A. H.	10	0	0
Scruton, R. Esq.	5	0	0
Simpson, J. C. Esq.	5	0	0
Smith, Mr. W. A.	1	0	0
Stowbart, Mrs.	1	1	0
*Swan, Captain J. G., Upsall Hall	1	1	0
*Trotter, John, Esq., J.P.	1	1	0
Turnbull, Mr. J.	5	0	0
Thubron, Mr. W.	5	0	0
Whitwell, W. Esq., J.P.	1	1	0
Walton, Joseph, Esq.	1	0	0
Walker, William, Esq.	10	0	0
Wilson, Mr. E. W.	10	0	0
Yeoman, Rev. Canon Marske	1	0	0
Zetland, The Earl of	5	0	0
Sums under 5s.	18	0	0
Total	26	9	6

Donations.

Hodgson, S. H. Esq., London	10	0	
Robertson, G.S. Esq., London	5	0	
Pillar Box at Hoist	6	1	9
Life-boat House	1	7	9
Zetland Hotel	10	5	0
Alexandra Hotel	3	8	
Mr. G. Gilbertson's Box	10	8	
Convalescent Home	2	3	
Box	2	3	
Sums under 5s.	2	0	
Total Dons.	9	13	6
Total Subs.	26	9	6
	£36	3	0

WAKEFIELD BRANCH.

Honorary Secretary—
HENRY ROBINSON, Esq.
Annual Subscriptions.

Alder, Thos. and Son	1	0	0
Baker, William	10	0	0
Barker, Major	1	1	0
Binks, John	10	6	
Boston, Broughton	10	6	
Briggs, Archibald	2	2	0
Briggs, Mrs. Marianne	2	0	0
Brown, John	5	0	0
Bruce, Samuel	10	6	
Charlesworth, J. Barff	1	1	0
Childe, Rowland	10	0	0
Clarkson, Henry	10	0	0
Coates, J. H.	10	0	0
Crowther, Mary Anne	1	0	0
Dixon, J. H.	10	6	
Dunns and Co.	1	1	0
Fernandes, J. L.	1	1	0
Grace, William	1	0	0
Graham, C. E.	10	0	0
Green, Edward	1	1	0
Hall, J. T.	5	0	0
Holdsworth, Richard	1	0	0
Holdsworth, J. Hulme	1	1	0
Holdsworth, S. M.D.	10	6	
Leatham, S. G.	1	0	0
Leatham, Claude	1	1	0
Lee, Geo. and Sons	1	1	0
Mackie, B. Bownas	1	1	0
Mackie, Mrs. John	1	1	0

Mander, George	10	0	
Masterman, John	10	0	
Micklethwaite, Mrs. Painthorp	1	0	0
Micklethwaite, Mrs. James	5	0	
Robinson, Henry	1	0	0
Rogers, Rev. S.	5	0	
Shaw, Mrs. Isaac	10	0	
Smith, Henry	1	1	0
Stanfield, A. W.	10	6	
Stewart, William	1	1	0
Tew, Percy	1	0	0
Tew, Herbert S.	2	2	0
Tomlinson, W. H. B.	1	1	0
Willis, Alan	10	0	
Total	36	0	0

Donations.

Kirkgate Station Collecting Box	1	3	8
Total Dons.	1	3	8
Total Subs.	36	0	0
	£37	3	8

WHITBY AND UP-GANG BRANCHES.

Honorary Secretaries—
E. W. CHAPMAN, Esq.
MR. ROBERT GIBSON.
Annual Subscriptions.

Atkinson, Mr. Thos.	2	6	
Anstee, Rev. Geo.	5	0	
Barker, J. Esq.	5	0	
Barrick, H. Esq.	10	0	
*Barry, Capt. J. H.	5	0	
Belcher, T. W. Esq.	10	0	
Brewster, Mrs. John	10	0	
Booth, Mrs.	1	0	0
Boulby, Rev. A.	5	0	
Brown, Mrs.	5	0	
Buchanan and Son	5	0	
Chapman, E. W. Esq.	1	0	0
Cholmley, Mrs.	1	0	0
Clarkson, Jas. & Son	5	0	
Collier & Son, Messrs.	5	0	
Corner & Marr, Messrs.	5	0	
Corney, Mr.	5	0	
Ellerby, Mrs.	5	0	
English, A. W. Esq., J.P.	1	1	0
Fisher, Mr. Charles	5	0	
*Foster, Capt. Jno.	5	0	
Gibson, Mr. Robt.	5	0	
Gray & Partners	10	0	
Harrison, C. Esq.	5	0	
Harrowing, Mr. Robt.	5	0	
Harrowing & Co., Messrs.	2	2	0
Hayes & Falkingbridge, Messrs.	5	0	
Hewson, Miss	5	0	
Holder, J. W. Esq.	1	1	0
Horne & Son, Messrs.	5	0	
Jameson, Miss	5	0	
*Jones, Capt. Thos.	5	0	
Knaggs, G. T. Esq.	5	0	
Langborne, Misses	5	0	
Langdale and Sons	5	0	
Laycock, Rev. J. A.	5	0	
Leng, J. H.	5	0	
*Marwood and Sons	10	6	
Maule, Mr. J. D.	5	0	
Maw, Mr. N.	5	0	
Mead, Dr.	5	0	
Mennel, Thos.	5	0	
Mitchel, Mr. J.	5	0	
Moorsom, Mrs.	1	1	0
Nicholson, Mr. J. B.	5	0	
Pannett, R. E. Esq.	5	0	
*Pearson, B. Esq.	5	0	
Pearson, Mr. Thos.	5	0	
Pease, A., M.P.	1	1	0
Reade, G. Esq.	5	0	

BRANCHES—LIST OF ANNUAL SUBSCRIPTIONS AND DONATIONS. 603

	£.	s.	d.
Richardson, C. Esq.	5	0	0
Richardson, F. Esq.	10	6	0
Richardson, Mrs. C.	10	0	0
Rothwell, Mrs.	5	0	0
*Sanderson, Capt. W.	5	0	0
Sewell, Mr.	5	0	0
Simpson, Chapman, & Co.	10	0	0
*Smalles, Capt. Thos.	5	0	0
Smalles Bros. Messrs.	10	0	0
Smalles, G. W.	1	0	0
Smalles, E. H. Esq.	5	0	0
Smallwood, D.	5	0	0
*Smith, Mr. W. B.	5	0	0
Snowdon, Mr. Math.	5	0	0
Stevenson, Mr. J.	5	0	0
Stewart, Mr. John.	5	0	0
*Summerston, Capt.	5	0	0
Taylor, Mrs. H.	5	0	0
Tinley, Dr.	5	0	0
Thistlewaite, L.	5	0	0
*Turnbull and Son	10	6	0
Turnbull Bros.	1	0	0
Usherwood, W. Esq.	5	0	0
Walker, Lieut. H.	10	6	0
Walker, J.C. Esq. J.P.	5	0	0
Walker, Rev. Canon	5	0	0
Weighill, John & Son	5	0	0
*Wharton, Capt.	5	0	0
White, Mr. John	5	0	0
*Wright, Capt. Chas.	5	0	0
Wright, W. Esq.	10	0	0
Yeoman, Dr.	5	0	0
Yeoman, Mr. T. P.	5	0	0
Sums under 5s.	18	0	0
Total	33	8	6

Donations.

*Clayhill, Lieut.-Col., J.P.	10	10	0
In Memoriam	10	0	0
Stephenson, Mr. Jno.	5	0	0
Adamson, Mr.	1	0	0
Brooks, Mr. James	1	10	0
Muir, Mr. R.	1	10	0
Burdett, Baroness	1	10	0
Anderson's, Misses	1	6	0
McClellan, Miss Mary E.	1	10	0
Hays, Mr. Hays	7	0	0
West Cliff Saloon	2	10	0
Box 2	15	1	0
Pillar and Collecting Boxes	8	2	3
Life-boat Sunday Collection	8	2	3
Total Dons.	44	3	2
Total Subs.	33	8	6
£77 11 8			

WITHERNSEA BRANCH.

Honorary Secretary—
H. H. AYBE, Esq.

Annual Subscriptions.

Allison, E.	5	0	0
Allison, Henry	5	0	0
Atkinson, J.	10	0	0
Ayre, H. H.	10	0	0
Bailey and Leatham	1	10	0
Broadley, W. H. H.	1	10	0
Brochner, C. C.	1	10	0
Chambers, W.	10	0	0
Champney, R.	1	10	0
Davis, Mrs.	1	10	0
Hewitson, Miss	1	10	0
Hildyard, J. G. B. T.	1	10	0
Holden, Thomas	1	10	0
Hutchinson and Son	1	10	0
Jackson, R.	1	0	0
Pease and Sons	1	10	0
Pugh, William	10	0	0
Smith Bros. and Co.	1	10	0

	£.	s.	d.
Straker, J. B.	10	0	0
Stephenson, Laurence	10	0	0
Swann, Capt.	1	10	0
Thompson, Edw.	10	0	0
Trinity House, Hull	5	0	0
White, T. W.	10	6	0
Wilson, D.	1	10	0
Wilson, T., Sons, & Co.	1	10	0
Young, James	1	10	0
Young, James, Jun.	10	0	0
Total	26	15	6
Donations	1	0	1
Total	£27	15	7

YORK BRANCH.

Treasurer and
Honorary Secretary—
DR. DUNHILL.

Annual Subscriptions.

Acton, Geo. Esq.	10	6	0
*Agar, Joseph, the Right Hon. (Lord Mayor)	1	0	0
Barnes, Mrs.	1	10	0
Bateman, Sam. Esq.	1	0	0
Bennet, Mrs.	1	0	0
Cabry, Mrs.	10	6	0
Cartwright, Miss S.	2	2	0
Catton, Mrs.	10	0	0
Champney, Miss	7	6	0
*City Sheriff, The	10	6	0
Clarke, Rev. A. J., M.A.	5	0	0
Clayton, Mrs.	1	10	0
Clutton, Wm. J. Esq., J.P.	1	10	0
Cowling, Henry, Esq.	5	0	0
Creyke, Ralph, Esq., M.P.	1	10	0
Crossley, W. E. Esq.	10	6	0
*Dean of York, The Very Rev.	1	10	0
*Dimsdale, Miss Eliz.	1	10	0
*Dunhill, C. H. Esq., M.D.	1	10	0
Dyson, Mrs. Alice E.	1	10	0
Elsley, Chas. Esq.	1	0	0
Farrar, Robert, Esq.	1	0	0
Feltoe, R. H. Esq.	10	6	0
Fenwick, R. H. Esq., J.P.	1	10	0
Fowler, Thos. N. Esq.	10	0	0
Gardner, G. Esq.	10	0	0
Gray, Miss	10	0	0
Gutch, Mrs.	10	0	0
Harcourt, Egerton Vernon, Esq.	1	0	0
Hill, Edward, Esq.	1	10	0
Hill, John R. Esq.	1	10	0
Hodgson, Jos. Esq.	1	10	0
Hodgson, Mrs. Capt.	10	6	0
Hollou, R. W. Esq.	1	10	0
Hotham, Mrs.	10	6	0
Jeffries, Julius, Esq.	5	0	0
Johnson, Rich. Esq.	10	0	0
Lascelles, the Hon. Mrs. Egremont	10	6	0
Leak, Wm. Esq.	2	2	0
Leake, F. Esq.	1	10	0
Leeman, J. J. Esq., M.P.	1	10	0
Leatham, Henry, Esq.	1	0	0
Longridge, Mrs.	2	2	0
Malcolm, Col. E. D.	1	10	0
Mason, Mrs. Sarah	1	10	0
Meek, Sir James, J.P.	10	0	0
Melrose, James, Esq.	10	0	0
Monkhouse, T. Esq.	10	0	0
Morrill, W. W. Esq.	5	0	0
Nettleton, Mrs.	10	0	0
Pierson, Mrs. John	10	0	0
Rawdon, W. F. Esq.	1	10	0
Read, W. H. Hudson, Esq., J.P.	2	2	0

	£.	s.	d.
Richardson, Hen. Esq.	1	5	0
Robinson, Mrs. E. A.	2	0	0
*Robinson, Miss	5	0	0
Rose, Rev. C. M.A.	5	0	0
Rowntree, Mrs. Sarah	1	0	0
Sellers, Messrs. G. and J. G.	10	0	0
Spence, Alfred. Esq.	1	13	0
Starkle, Capt. Ed. C.	1	10	0
Taylor, J. F. Esq.	10	6	0
Terry, Joseph, Esq., J.P.	10	6	0
Thompson, Luke, Esq.	5	0	0
Thorp, H. B. Esq.	1	10	0
Umpleby, G. W. Esq.	1	10	0
Wade, Jno. Esq.	5	0	0
Walker, Thos. Esq.	1	10	0
Walker, Wm. Tomlinson, Esq., J.P.	1	10	0
Ware, Henry J. Esq.	10	0	0
Whitehead, George, Esq., J.P.	1	10	0
Whythead, W. Esq.	10	6	0
Wilberforce, W. W. Esq., J.P.	1	10	0
Wilkinson, Jos. Esq.	10	0	0
Williams, Mrs.	5	0	0
Wilson, G. Esq. J.P.	1	10	0
Wood, Thos. F. Esq.	1	10	0
Yorke, Miss	1	0	0
Total	66	0	6

Donations.

Anonymous	1	10	0
Bellerby, John, Esq.	5	0	0
Brown, the Misses	10	0	0
Cameron, Maj.-Gen., C.B.	5	0	0
Close, Capt. John	2	2	0
*Dunhill, Dr.	5	0	0
Dunhill, Mrs.	5	0	0
Ellis, Mrs. Mary	2	0	0
Fausset, Rev. A. L.	1	0	0
Lindberg, G. H. Esq.	5	0	0
Mennell, Mr. Wm.	10	6	0
Spence, Mrs. J. (9th Donation)	5	0	0
Wilson, Walter, Esq.	1	0	0
Wilson, Mrs. Walter	1	0	0
Sums under 5s.	7	6	0
Total Dons.	69	11	0
Total Subs.	66	0	6
£135 11 6			

Special Life-boat Gifts.

Ellis, Mrs. M. A. for endowment of Robert and Mary Ellis life-boat, 1200	0	0	0
Middlewood, George, Esq., of Rufforth Hall, for the <i>Matthew Middlewood</i> Life-boat, in memory of his son, who died and was buried at sea...	1065	0	0
£2265 0 0			

SCOTLAND.

Aberdeenshire.

ABERDEEN BRANCH.

Chairman—
The LORD PROVOST OF
ABERDEEN.

Honorary Secretary—
A. D. MILNE, Esq.

Annual Subscriptions.

	£.	s.	d.
Aberdeen Steam Navigation Company	5	5	0
Adam, J. B.	1	10	0
Adam, Thos., Jun.	1	10	0
*Aiken, James, Jun.	10	6	0
Begg, John	1	10	0
Cook, John (Banker)	10	6	0
Davidson, George	10	0	0
Davidson, J. and A.	1	10	0
Duthie, Alex.	1	0	0
*Duthie, Wm.	1	10	0
Duthie, Robt.	1	0	0
Fiddes, Edward	10	0	0
Edmond, Alex.	1	10	0
*Edmond, Francis	2	0	0
Esslemont and Macintosh	1	10	0
Gibson, Wm.	1	0	0
Gordon, Wm.	10	6	0
Grant, Wm.	10	0	0
Hall, Alex. and Co.	1	10	0
*Henderson, Wm.	2	2	0
Horne, R. B.	1	10	0
Jamieson, George	1	10	0
Leslie, Wm. & Co.	10	6	0
Ludwig, Chas. & Co.	10	6	0
*Lumsden, Robt.	1	0	0
Macqueen, J. O.	1	10	0
Miller, John	1	0	0
Milne, John D.	1	0	0
Milne, Wm. (C. A.)	10	6	0
*Nicol, Alex. & Co.	1	10	0
Pratt and Keith	1	10	0
Reid, John	1	10	0
Riddel, Peter	10	6	0
*Rorie, George L.	1	10	0
Rust, John, and Son	1	10	0
Shipmaster's Society	3	3	0
Smith, Neil, Jun., and Co.	1	0	0
Stephen, Alex.	10	6	0
*Thompson, Cornelius	2	2	0
Thompson, Geo. Jun.	3	3	0
*Walker, Alex.	1	10	0
*Webster, John, M.P.	1	10	0
*Wilson, Alex. H.	1	10	0
*Yeats, Wm.	1	0	0
Small Sons	—	—	—
Total	50	18	9

Legacy.
Tower, Miss, the late

Total Dons.	11	0	0
Total Legacies	10	0	10
Total Subs.	60	18	9
£71 19 7			

Donations.

*Aberdeen, Rt. Hon. the Earl of (1880)	10	0	0
Black, Wm.	10	0	0
Copland, A.	10	0	0

CRUDEN BAY BRANCH.
 Patron—
 The Right Hon. the EARL OF ERROLL.
 Treasurer—
 G. I. FRASER, Esq., M.D.
 Honorary Secretary—
 Mr. JAMES BODDIE.

Annual Subscriptions.

	£.	s.	d.
Alcock, Mr.	2	6	
Brown, Rev. Geo.	10	0	
*Earl of Erroll	2	10	0
Countess of Erroll	2	10	0
Brand, Mr.	5	0	
*Forbes, Keith, Esq.	10	0	
*Murdoch, Rev. P. J.	5	0	
Phillip, Mr.	10	0	
*Ross, Rev. R.	10	0	
Russel Trust	5	0	0
Shepherd, Jas. Esq.	10	0	
Walker, Rev. Mr.	5	0	
Will, Misses	7	6	
Young, Mr.	5	0	
Sums under 5s.	5	13	6
Total	19	13	6

FRASERBURGH BRANCH.
 Patron—
 The Right Hon. the LORD SALTOUN.
 Treasurer & Hon. Sec.—
 ANDREW TARRAS, Esq.

Annual Subscriptions.

Anderson, Sir Alex.	1	0	0
Baird's Trustees	1	0	0
Clinton, Rt. Hn. Lord	2	0	0
Cordiner, W. F. Esq.	1	0	0
Forbes, Dr. O.	1	0	0
Fordyce, Mrs.	1	0	0
Fraserburgh Harbour Commissioners	16	0	0
Gordon, Rear-Admiral, A.C.	1	0	0
Gordon, Wm. Esq.	2	0	0
Calrness	2	0	0
Henderson, C. P. Esq.	1	1	0
Saltoun, Rt. Hn. Lord	5	5	0
Total	32	7	0

Donation.
 Russel Trust 5 0 0
£37 7 0

NEWBURGH BRANCH.
 President—
 JOHN H. UDNY, Esq.
 Hon. Secretary—
 Mr. P. MURRAY.

Annual Subscriptions.

*Anderson, Mr. F.	10	0	0
Gordon, H. W.	1	0	0
*Lontil, Rev. J. S.	10	0	0
Turner, Misses	1	0	0
*Udny, J. H.	5	0	0
Udny, Mrs.	2	2	0
Total	10	2	0

Donations.
 *Pirie, James M. 10 0
 Moir, George 8 0

	£.	s.	d.
Catto, Mrs.	5	0	0
Findlay, John	5	0	0
Collecting Box Boat House	6	9	
Do. do. Hotel	3	10	
Bank Interest	2	6	
Russel Trust	5	0	0
Old rope sold	7	0	0
Total Dons	7	8	1
Total Subs.	10	2	0
Total	£17	10	1

PETERHEAD BRANCH.
 Treasurer—
 WM. BAXTER, Esq.
 Honorary Secretary—
 WILLIAM BOYD, Esq., F.R.S.E.

Annual Subscriptions.

Alexander, Mrs., Edinburgh	10	6	
*Alexander, W. & W. A.	10	0	
Belt, James	5	0	
*Boyd, A. and W.	1	1	0
Cumine, Jas. Esq. of Rattray	2	2	0
Ferguson, Colonel, of Pitfour	2	0	0
J. S.	5	0	0
Kidd, Robert, & Sons	10	0	0
*McCombie, James, and Co.	5	0	
Merchant Maiden Hospital of Edinburgh	3	3	0
Mitchell, William	5	0	0
*Napier, John	5	0	0
R. R.	5	0	0
Russel, Misses, Trustees	5	0	0
Stephen and Hay	7	6	
Sums under 5s.	4	17	0
Total	£21	11	0

WHITELINK BAY BRANCH.
 President—
 Rev. W. WILLIAMSON.
 Honorary Secretary—
 Mr. A. J. BERNIE.

Annual Subscription.

Cordiner, W. F. Esq.	1	0	0
Lawrence, W. J. Esq.	10	0	0
Total	£12	4	0

Donations.
 A. J. B. 5 0
 Duthie, Mrs. Matilda 1 1 0
 Laurence, Geo. Esq. 5 0
 Russel Trust 5 0 0
 Inverallochy Villagers 2 18 0
 Strachan, John 0 5 0
 Small Sums 1 0 0
Total £12 4 0

Argyllshire.
CAMPBELTOWN AND SOUTHEND (CANTYRE) BRANCH.

Patron—
 His Grace the DUKE OF ARGYLL, K.T., V.P.
 President—
 PROVOST COLVILLE.
 Honorary Secretary—
 Mr. A. MITCHELL,
 H. M. Customs.

Annual Subscriptions.

	£.	s.	d.
Ardlussa, Dy. Co.	5	0	0
Argyll, His Grace the Duke of, K.T., V.P.	5	0	0
Boyd, Mr. J. C.	5	0	0
Brown & Co. Messrs.	10	0	0
T.	10	0	0
Buchanan, Col. R.A., C.B.	2	0	0
Campbell, Capt. J. C. R.N.	1	0	0
Campbell, Miss McNeill	1	0	0
Campbeltown Harbour Trustees	5	0	0
Clemiston, V. Esq.	5	0	0
Colville and Son, Messrs. A.	5	0	0
Colville, David, Esq.	5	0	0
*Colville, Duncan Esq.	1	0	0
Provost	1	0	0
Cunningham, Dr.	5	0	0
*Dundas, Sheriff	10	0	0
*Dunlop, James, Esq.	5	0	0
Galbraith & Cochrane	5	0	0
Galbraith, John, Esq.	1	0	0
Gibson, Dr. M.D.	10	0	0
Greenlees, Alex. Esq.	5	0	0
*Greenlees, C. C. Esq.	1	0	0
Greenlees, Dan. Esq.	10	0	0
Greenlees, J. W. Esq.	5	0	0
Greenlees, Robt. Esq.	10	0	0
Greenlees, Sam. Esq.	10	0	0
Hall, James M. Esq.	1	0	0
Lord, Stimson	5	0	0
Love, Mrs.	10	0	0
*Mackay, Major	1	0	0
Mackinnon, P. Esq., Devaar	1	0	0
Mackinnon, P. Esq., Rosemount	1	0	0
*Mactaggart, C. Esq.	10	0	0
M*Alister, Keith Esq.	1	0	0
M*Alister, Mrs. K.	1	0	0
*M*Callum, Duncan, Esq.	5	0	0
*M*Donald, D. W. Esq.	5	0	0
*M*Gibbon, D. Esq.	10	0	0
*M*Kersie, John, Esq.	5	0	0
M*Kersie, W. Esq.	5	0	0
M*Nair, W. Esq.	5	0	0
M*Queen & M*Kay	5	0	0
M*Sporrnan, A. & Co.	5	0	0
Mitchell, Alex. Esq.	5	0	0
Mitchell, Wm. Esq.	5	0	0
*Muir, John, Esq.	10	0	0
Murray, John, Esq.	5	0	0
*Russell, Rev. Dr.	10	0	0
Scarlett, J. W. Esq.	1	0	0
Spinks, Mr. John	5	0	0
*Stewart, James, Esq.	10	0	0
26 sums under 5s.	3	1	0
Total	38	11	0

Donations.
 Custom House Box .. 11 2
 Southend Boat-house Box 0 6 7
 Sums under 5s. 6 5
 Steamers 10 4
Total £40 5 6

Ayrshire.
ARDROSSAN BRANCH.
 Treasurer and Honorary Secretary—
 JOHN CRAIG, Esq.

Annual Subscriptions.

	£.	s.	d.
Eglinton and Winton, The Earl of	15	0	0
Anderson, Jno. Esq.	5	0	0
Anderson, Jno. Esq.	5	0	0
*Bailey, Jas. L. Esq.	5	0	0
Baird, W. and Co.	5	0	0
Barr and Shearer	1	1	0
*Craig, John, Esq.	5	0	0
*Emslie, John, Esq.	10	0	0
Finnie, A. and Son	2	2	0
Gardner, Mrs.	1	1	0
Goodwin, Jas. and Co.	1	1	0
Goodwin Brothers	5	0	0
Guthrie, Alex. Esq.	5	0	0
*Halkett, J. G. Esq.	10	6	0
Logan, John, Esq.	5	0	0
M*Isaac, James, Esq.	10	6	0
*Mack, D. J. Esq.	10	6	0
Merry and Cuninghame	5	0	0
Moffat, John, Esq. (the late)	2	2	0
*Muir, W. Esq.	5	0	0
Robertson, Dr.	10	6	0
Russell & Fullarton	1	1	0
*Steel, Captain	5	0	0
Vernon, Hon. G. R.	1	1	0
Sums under 5s.	39	11	0
Sundry Donations	3	8	9
Total	£42	19	9

AYR BRANCH.
 Chairman—
 THOMAS STEELE, Esq.
 Provost of Ayr.
 Honorary Secretary—
 JOHN POLLOCK, Esq.

Annual Subscriptions.

Alexander, Colonel	3	3	0
Baird, John	2	0	0
Baird, W.	2	0	0
Baird, Mrs.	1	0	0
Bell, John	1	0	0
Campbell, R. F. F. of Craigie	1	0	0
Coats, Sir Peter	5	0	0
Cowan, Hugh	1	0	0
Dixon, Mrs. Bellisle subscription for last year	2	0	0
ditto for this year	5	0	0
Dykes, Rev. Dr.	10	0	0
Flint & Son, William	5	0	0
Gairdner, W.	1	0	0
Gemmell, T. M.	5	0	0
Girdwood, Gavin	1	0	0
Hamilton, John	2	0	0
Higbet & Son, Wm.	10	0	0
Houldsworth, J. M.	1	0	0
Houldsworth, Wm.	2	0	0
Hunter, John	1	0	0
M*Gavin, Mrs.	1	0	0
Mellwrath, John, Son & Co.	10	0	0
Mitchell, John	10	0	0
Morton, J. M. M.	1	0	0
Oswald, R. A.	5	0	0
Paton & Sons, James	1	0	0
Smith & Son, Andrew	5	0	0
Steele, Provost	10	0	0

BRANCHES—LIST OF ANNUAL SUBSCRIPTIONS AND DONATIONS. 605

	£.	s.	d.
Stewart, William ...	10	0	0
Taylor, J. and A.	10	0	0
Templeton and Son, James	10	0	0
Young, J. and T. ...	10	0	0
Total	44	8	0
<i>Donation.</i>			
John A. Steele	10	0	0
£44 18 0			

BALLANTRAE BRANCH.

	£.	s.	d.
<i>Patron—</i>			
JAMES HUNTER, Esq., Glenapp.			
<i>President—</i>			
Rev. F. J. WILLIAMSON.			
<i>Honorary Secretary—</i>			
Mr. JAMES WASON.			
<i>Annual Subscriptions.</i>			
Hunter, James, Esq. 2	2	0	0
McConnel, W. Esq. 1	1	0	0
Stair, The Earl of ... 2	2	0	0
Total	5	5	0
<i>Donations.</i>			
Box contributions ...	10	0	0
Sums under 5s.	5	3	6
£10 18 6			

GIRVAN BRANCH.

	£.	s.	d.
<i>Patron—</i>			
The Right Hon. the EARL OF STAIR, K.T.			
<i>Treasurer—</i>			
ALEXANDER MARTIN, Esq.			
<i>Honorary Secretary—</i>			
WILLIAM FORSYTH, Esq.			
<i>Annual Subscriptions.</i>			
Alexander, Col., M.P. 2	2	0	0
McConnel, William ...	1	1	0
of Knockdolian 1	1	0	0
Hamilton, Hugh, of Pinmore	1	0	0
Stair, the Right Hon. Earl of (two years) 2	2	0	0
Smith, Mrs., Lady- bank	1	0	0
Total	£7	5	0

IRVINE BRANCH.

	£.	s.	d.
<i>President—</i>			
JOHN WRIGHT, Jun., Esq. Provost.			
<i>Vice-Presidents—</i>			
Capt. DAVID BOYLE, R.N., of Shewalton, &c.			
JOHN PATTERSON, Esq., of Knowhead.			
<i>Honorary Secretary—</i>			
JAMES DICKIE, Esq.			
<i>Annual Subscriptions.</i>			
Alexander, Hugh... ..	10	0	0
Alston, Chas. H.	1	0	0
Armour James	5	0	0
Begg, J. S.	5	0	0
*Boyle, Capt. R.N. ...	2	0	0
Boyd, H. F.	1	1	0
Bremner, Mrs.	5	0	0
*Brown, Geo.	1	1	0
*Brown, Capt. James ...	5	0	0
Brown, J. C.	1	1	0

	£.	s.	d.
Calderwood, Hugh... ..	5	0	0
Christie, Wm.	5	0	0
Consar and Miller ...	5	0	0
Dickie, Rev. W. S. ...	5	0	0
Drummond, J.	5	0	0
Eglinton, Earl of ...	3	3	0
Eglinton Chemical Co., Limited.	3	3	0
Finnie, Archibald, Springhill	1	1	0
Galloway, Andw. C.E. ...	10	0	0
*Gilmour, Alexander ...	10	0	0
*Gorman, C. S.	10	0	0
*Goudie, James.	5	0	0
Green, Mrs.	5	0	0
Hamilton, Alexander ...	5	0	0
Henderson and Co. Wm.	3	3	0
Highet, H. M.	5	0	0
Holmes, Miss	5	0	0
Irvine Forge Comp. ...	5	0	0
Jaffrey, Mrs.	1	1	0
Johnston, John.	5	0	0
Lindsay, J. B.	5	0	0
*Longmuir, Alex. ...	10	6	0
Macredie, Mrs. Mure, of Perceton	10	0	0
Marr, Capt.	5	0	0
*McGivray, James ...	5	0	0
McKinlay, William ...	5	0	0
*Morris, Capt. A. F. ...	10	0	0
*Paterson, John, Knowhead	10	6	0
*Pipe, James.	5	0	0
Robertson, Miss ...	5	0	0
Rose, Mrs.	5	0	0
Ross, Z. M. H.	10	0	0
Sommerville, Rev. Jas. ...	5	0	0
*Stewart, James ...	10	0	0
Thomson, Wm.	5	0	0
Walker, Alex.	5	0	0
*Wright, John, Jun. ...	10	0	0
Young, Capt.	5	0	0
Sums under 5s.	9	14	2
Total	£39	14	2

TROON BRANCH.

	£.	s.	d.
<i>Honorary Secretary—</i>			
ALEXANDER WYLLIE, Esq.			
<i>Annual Subscriptions.</i>			
Alexander, Col., M.P. 2	2	0	0
Alexander, W., M.D. ...	10	0	0
Craig, J. & M.	1	0	0
Cook, Duncan	10	0	0
Cunningham, W. S. ...	1	0	0
Eglinton Iron Coy. ...	2	0	0
Finnie, Archd.	2	0	0
Finnie, Miss	10	0	0
Galloway, John ...	1	0	0
Gilmour, Allan.	1	0	0
Houldsworth, W. H. ...	1	0	0
Portland Duke of ...	2	2	0
Troon Shipbuilding Company	1	0	0
Wood, James.	1	0	0
Total	£16	14	0
<i>Donations.</i>			
A Friend	1	0	0
Cowan, Rev. A. H. ...	10	0	0
Dickie, Jas.	1	1	0
Easton, Robt.	1	1	0
Fleming, Rev. Jas. ...	10	0	0
Kirkwood, Rev. J. ...	10	0	0
Logan, Jno.	10	0	0
Services to "Flora" ...	10	0	0
Boxes in Custom House &c.	4	4	0
Total	5	16	0
Total Subs. 16 14 0			
Total Dons. 5 16 0			
£22 10 0			

Banffshire.
**BANFF AND
MACDUFF BRANCH.**

	£.	s.	d.
<i>President—</i>			
The EARL OF FIFE, K.T.			
<i>Chairman—</i>			
WILLIAM COURTS, Esq., Pro- vost of Banff.			
<i>Deputy Chairman—</i>			
JAMES MARTIN, Esq., Provost of Macduff.			
<i>Treasurer and Hon. Sec.—</i>			
JAMES WATT, Esq.			
<i>Annual Subscriptions.</i>			
Fife, Earl of.	10	0	0
Seafield, Earl of. ...	1	0	0
Abercromby, Sir R. Bt. 1	0	0	0
Allan, John, Esq. ...	5	0	0
Banff Shipping.	4	4	0
*Bow, Alex. Esq. ...	5	0	0
Bryson, W. G. Esq. ...	5	0	0
Campbell, Colonel ...	1	0	0
*Coutts, Provost. ...	5	0	0
Cumming, Geo. Esq. ...	5	0	0
Cumming, Colonel Gordon	1	0	0
Diggens, Mrs.	5	0	0
Duff, Hon. G. Skene. ...	1	0	0
Duff, R. W. Esq. M.P. 1	0	0	0
Duff, Major Gordon ...	1	0	0
Forbes, Colonel.	1	1	0
Geddie, Rev. J. W. ...	5	0	0
George, Alex. Esq. ...	5	0	0
Gordon, W. and C. ...	5	0	0
Hannay, John, Esq. ...	5	0	0
Harvey, John, Esq. ...	1	1	0
*Hodge, Capt.	5	0	0
Hunter, Rev. Wm. ...	5	0	0
McConnachie & Iron- side	5	0	0
McDonald, D. Esq. ...	5	0	0
Macduff, Cmercl. Co. ...	5	0	0
Macduff Shipping ...	4	14	0
*Maclarlane, Alex. Esq.	5	0	0
Manson, Dr.	5	0	0
*Martin, Provost ...	5	0	0
Milne, Dr.	5	0	0
Moncrieff, Sheriff Scott	5	0	0
Morison, Mrs. of Bog- nie.	2	0	0
Murray, G. W. & Co. ...	5	0	0
Nisbet and Co.	5	0	0
Pirle, Geo. Esq.	5	0	0
Russell, Trustees of late Misses.	5	0	0
Scott, Alex. Esq. ...	1	0	0
Simpson, J. Esq. ...	5	0	0
Sinclair, Arthur, Esq. ...	10	0	0
Stronach, Wm. Esq. ...	1	0	0
Taylor, W. J. Esq. ...	1	0	0
Walker, Rev. George ...	5	0	0
Watt, Alex. Esq. ...	5	0	0
*Watt, Capt. James. ...	5	0	0
*Watt, G. N. Esq. ...	5	0	0
Webster, D. Esq. ...	1	0	0
<i>Donations.</i>			
Chivas, Mrs. (Aber- deen), Legacy ...	5	0	0
Macduff, Half pro- ceeds of Concert at Boxes at Boat-house, &c.	2	1	8
Sums under 5s.	2	10	0
Bank Interest	5	10	0
Total	£58	5	6

BUCKIE BRANCH.

	£.	s.	d.
<i>President—</i>			
The Right Hon. the EARL OF SEAFIELD.			
<i>Chairman—</i>			
W. R. DUGUID, Esq., M.D.			
<i>Honorary Secretary—</i>			
JOHN SHEARER, Esq.			
<i>Donations.</i>			
Gordon, J. P.	1	1	0
Proceeds of Concert. 6	0	0	0
Russell's Trust, Misses, Aberdeen.	5	0	0
£12 1 0			

Berwickshire.

**EYEMOUTH
BRANCH.**

	£.	s.	d.
<i>President—</i>			
Lieut.-Col. MILNE HOME, of Wedderburn, M.P.			
<i>Vice-President—</i>			
JAMES GIBSON, Esq., of Gunsgreen.			
<i>Treasurer—</i>			
Mr. JOHN DICKSON, Fish Curer.			
<i>Honorary Secretary—</i>			
Mr. ANDREW WHITLIE, Commercial Bank.			
<i>Annual Subscriptions.</i>			
*Cairns, John, Esq. ...	10	0	0
*Gibson, James, Esq. ...	10	0	0
Hamilton, The Hon. R. Baillie.	5	0	0
*Home, Col. Milne, M.P.	5	5	0
Home, Miss.	1	1	0
Mack, J. S., Esq. ...	1	1	0
Marjoribanks, Hon. E., M.P.	5	0	0
Marjoribanks, Lady. ...	1	0	0
Total	19	7	0

	£.	s.	d.
<i>Donations.</i>			
Home, Earl of (1880) ...	5	0	0
Home, Major (1880) ...	10	0	0
Do. (1881)	10	0	0
Home, D. M., Esq., of Milne Graden ...	1	0	0
Murray, George, Esq. (1881)	1	0	0
Do. (1881)	1	0	0
Romanes, Robt., Esq. (1880)	1	1	0
Do. (1881)	1	1	0
Swinton, A. Campbell, Esq. (1880)	2	0	0
Do. (1881)	2	0	0
Interest from Bank ...	4	10	0
Boxes and Sums under 5s.	10	8	0
Total Dons.	15	17	6
Total Subs.	19	7	0
£25 4 6			

Buteshire.

ISLE OF ARRAN BRANCH.

Honorary Secretary—
PATRICK MURRAY, Esq.

Annual Subscriptions.

	£.	s.	d.
*Campbell, Rev. Colin			
F.	10	0	0
*Paterson, James...	1	0	0
Total	1	10	0

Donations.

Allan, James	10	0
Balfour, J. W.	5	0
Balfour, Misses	5	0
Balland, Thos. J.	5	0
Bannerman, W.	5	0
Bonar, Mr.	5	0
C. H. W.	5	0
Clark, Mrs. R. M.	5	0
Craig, Mrs.	5	0
Davidson, Robt.	5	0
Dickie, Wm. M.	5	0
Fullarton, Alex, Glasgow	10	0
Fullarton, R. W. Mac Leod	1	1
G., Wm.	5	0
Goodier, Misses	5	0
Haitton, Agnes	5	0
Jack, Mrs.	5	0
MacDonald, Peter	10	0
*Mackintosh, Jas.	5	0
MacNelsah, D. & Son	10	0
McDougall, D. Jun.	5	0
McLean, Rev. M., B.D.	5	0
Middlemass, Mrs.	5	0
Muir, A.	5	0
*Robertson, Jas.	5	0
Sandeman, Robt. J.	5	0
Steamer <i>Joanhoe</i>	10	0
Stewart, A.	10	0
Paterson, Mrs., Ardin- Steamer <i>Brodick</i>	10	0
Castle	1	0
Stewart, D. M.	5	0
T. G. A.	10	0
W. A. C.	1	0
Wallace, John	5	0
Westlands, Misses	5	0
Whytt, Alex. H.	5	0
Wooley, Mrs.	5	0
Wyd, Robert S., L.L.D.	5	0
Corrie Hotel Col. Box	15	8
Boat-house	17	2
Shedog Hotel	4	0
Lochranza	14	6
Sums under 5s.	16	12
Total Dons.	32	19
Total Subs.	1	10
£34	9	8

Caithness-shire.

HUNA BRANCH.

President—
PETER KEITH, Esq.
Barrogill Castle.

Honorary Secretary—
MR. D. DUNNETT.

Annual Subscriptions.

	£.	s.	d.
*Caithness, The Rt. Hon. the Earl of...	2	2	0
*Keith, Peter, Esq.	10	0	
*McGregor, Rev. R.	5	0	
Sums under 5s.	7	6	

Donations.

Box at Huna Hotel	1	6
Box at Life-boat		
House	1	3
Total	£3	7

THURSO BRANCH.

Patron—
SIR J. G. T. SINCLAIR, BART.,
M.P.

Treasurer—
JAMES BRIMS, Esq.

Honorary Secretary—
JOHN COGHILL, Esq.

Annual Subscriptions.

*Brims, James, Esq.	5	0
Cameron, Duncan, Esq.	5	0
*Coghill, John, Esq.	5	0
*Craig, D. B. Esq.	5	0
*Galloway, J. W., Esq.	5	0
Henderson, A. Esq., of Stemster	10	0
Henderson, Donald, Esq.	2	6
Henderson, John, Esq.	10	0
Miller, Mrs. George	10	0
*Miller, Rev. J. S.	5	0
Russell, Miss	2	6
*Sinclair, David, Esq.	5	0
*Sinclair, Hugh, Esq.	5	0
Sinclair, Sir J. G. T., Bart. M.P.	2	2
Sinclair, Sir R. C. Bt.	1	0
Sutherland, David, Esq.	5	0
*Swanson, John, Esq.	10	0
Tait, W. R. Esq.	5	0
Trall, J. C. Esq.	1	0
Williamson, Capt.	5	0
Total	9	3

Donations.

Contribution Box in Royal Hotel	6	1
Ditto at Scrabster	12	0
Total Dons	18	1
Total Subs.	9	3
£10	1	1

**WICK AND ACKER-
GILL BRANCH.**

President—
G. DUFF DUNBAR, Esq.

Honorary Secretary—
GEORGE M. SUTHERLAND.

Annual Subscriptions.

	£.	s.	d.
Brenner and Green	5	0	
Bremner, Mr. James	5	0	
Bruce, Mr. Chas.	5	0	
Campbell, E.	5	0	
Clyne, A.	5	0	
Corke, B.	5	0	
*Davidson, J.	5	0	
Donaldson, R.	5	0	
Dunbar, G. Duff, Esq.	3	0	
Duncan, J. G.	5	0	
Geddes, W. and A.	5	0	
Gilchrist, Mr. James	10	6	
Gow and Son	5	0	
Gunn, Mr. Jas.	5	0	
Gunn and Co., Messrs. D.	1	0	
Harper, W.	5	0	
Henderson, A. W.	10	6	
Loag, H.	5	0	
Mackay, Eric S.	5	0	
MacAdee, G. and Co.	5	0	
McHugh, F. H.	5	0	
McIntosh	5	0	
McLennan, Mr. M.	10	6	
Miller, Cormack and Mackay, Messrs.	10	6	
Nicol, Mr. Jas.	5	0	
Nicolson, Mr. W.	5	0	
Nicolson, A.	5	0	
Pender, J. Esq., M.P.	2	0	
Reid, Donald	5	0	
Reid, Peter, Esq.	5	0	
Reid, William	5	0	
Robertson, Mr. R.	5	0	
Rae, A.	5	0	
Rae, Provost	5	0	
Ross, Mr. D.	5	0	
Ross, Mr. Chas.	5	0	
Sandison, J.	5	0	
Scott, Mr. A. R.	5	0	
Sinclair, Mr. A.	5	0	
Sinclair, Mr. Alex.	5	0	
Sinclair, Mr. R.	5	0	
Sinclair, W. S., Thomson	1	0	
Smith, Mr. W. P.	5	0	
Sutherland, Mr. G. M.	5	0	
Sutherland, M. J.	5	0	
Tait, D.	5	0	
Wares, Mr. Alex.	5	0	
Sums under 5s.	4	5	

Donations.

Box at Custom House	11	0
Do. at Commercial Bank	6	6
Total	£24	6

£. s. d.

Archibald, Son, & Co. Messrs. Wm	10	6
Bailey, W. & J. A. Messrs.	1	0
Balfour, James, Esq.	1	0
Balfour of Burleigh, Lord	1	0
Brinkmann, H. Esq.	10	6
Brown, Charles, Esq.	5	0
Calder, Jas. and Co. Messrs.	1	0
Carmichael and Sons, Messrs. R.	10	0
Duncanson, Misses	2	0
Elphinstone, Lady W. Osborne (2 yrs.)	2	0
Fischer, Morton, Esq.	10	6
Haig, W. J. Esq.	10	0
Hunter & Donaldson, Messrs.	10	0
Knox, Robert, Esq.	1	0
Klovborg, J. J. Esq.	5	0
Laing, Richard, Esq.	7	6
Laurie, Rev. J. W.	5	0
Leishman, Jas. Esq.	1	0
Mar and Kellie, The Earl of	3	0
McEwan, Miss	1	0
McNab, Alex. Esq.	2	0
Melvin, Mrs. John	10	0
Meiklejohn and Son, Messrs. R.	1	0
Mitchell, Messrs. A. and A.	2	0
Moir, A. Esq.	1	0
Mowbray, J. J. Esq.	1	0
Orr, James, Esq.	2	0
Osborne, Lady W. G.	1	0
Paton, A. Forrester, Esq.	3	0
Paton, Miss	15	0
Paton, David, Esq.	5	0
Paton, J. Son & Co. Messrs.	1	0
Phillip, John, Esq.	5	0
Porteous, Archd. Esq.	5	0
Porteous, Jas. Esq.	10	6
Rintoul, Robt. Esq.	5	0
Ross & Sons, Messrs. Wm.	1	0
Sewall, Dr.	5	0
Smeaton, Rev. J.	5	0
Strang, Miss	1	2
The Carron Co.	5	5
Thomson Brothers, Messrs.	1	0
Turcan, Wm. Esq.	1	0
Walker, Dr.	10	0
Willison, Robt. Esq.	10	6
Wingate, Miss	1	0
Weir, J. A. Esq.	1	0
Younger and Co. Messrs. Geo.	1	0
Subscriptions under 5s.	6	4
Total	£64	8

Clackmannanshire

ALLOA BRANCH.

Honorary Secretary—
DAVID BARRY, Esq.

Honorary Collector—
MR. ALEX. GARDEN.

Annual Subscriptions.

Aberdeen, Dowager Countess of	1	0
Adam, George, W.	1	0
Alloa Coal Comp.	1	0
Archibald and Son, Messrs. R.	1	0

BRANCHES—LIST OF ANNUAL SUBSCRIPTIONS AND DONATIONS. 607

Edinburgh.

DALKEITH BRANCH.

President—
ALEXANDER MITCHELL.
Vice-President—
WILLIAM PORTEOUS.
Treasurer—
JOHN CRAIG.
Secretary—
ALEX. BALLANTYNE, M.D.

Annual Subscriptions.

	£.	s.	d.
A Friend	5	0	0
Ballantyne, Alex. M.D.	10	0	0
Bishop, John	5	0	0
Chisholm, John	5	0	0
Dennis, John	5	0	0
Fods, Archibald	5	0	0
Douglas, A. and W.	10	0	0
Douglas, George, and Son	5	0	0
Dove, David	5	0	0
Dun, J. R.	5	0	0
Gray, James	10	6	0
Hewatt, Misses	5	0	0
Metcalfe & Co.	5	0	0
Mitchell, Alexander	10	0	0
Mutter, Misses	5	0	0
Porteous, William	5	0	0
Rough, John	5	0	0
Todd, J. and J.	16	0	0
Wilson, Miss	5	0	0
Sums under 5s.	2	3	6
Total	£	89	0

EDINBURGH, LEITH AND GRANTON BRANCH.

Chairman—
ADM. SIR ALEXANDER MILNE, BART., G.C.B.
Honorary Secretary—
ROBERT SINCLAIR, Esq., 16 Waterloo Place.

Annual Subscriptions.

A. B.	5	0	0
A. H.	10	0	0
A. P. N.	5	0	0
Abbot, F. Esq.	1	0	0
Abercrombie, Misses	1	0	0
Adams, Sons, and Co.	1	0	0
Messrs.	1	0	0
Addie, Alex. Esq.	1	0	0
Addie, G., Esq.	10	0	0
Agnew, Capt. R.N.	10	0	0
Aitken, Arch. & Co.	10	6	0
Ainslie, Colonel	5	0	0
Aitchison and Co.	10	0	0
Messrs. John	10	0	0
Aitken, Gray, and Co.	1	1	0
Messrs.	1	1	0
Aitken and Wright	10	6	0
Messrs.	10	6	0
Aitken and Co. Messrs.	5	0	0
James	5	0	0
Aitken, A. Esq., Jun.	5	0	0
Aitken, Mrs.	10	0	0
Aitken, Mrs.	5	0	0
Allison, Mrs. A.	5	0	0
Allan, Mrs.	5	0	0
Anderson, David, Esq.	1	0	0
Anderson, Misses	1	0	0
Anderson, Mrs.	10	0	0
Anderson, Mrs.	5	0	0
Anderson, Mrs.	5	0	0
Anderson, Mrs. John	5	0	0
Anderson and Williamson, Messrs.	5	0	0
Annandale, Mrs.	5	0	0

	£.	s.	d.		£.	s.	d.		£.	s.	d.
Anstey, Mrs.	10	0	0	Brown, Mrs.	5	0	0	Cruikshanks & Son, Messrs.	5	0	0
Anval, Lady	5	0	0	Bruce, Boyd, and Co. Messrs.	1	0	0	Crystal, Mrs.	5	0	0
Austin, Mrs.	7	6	0	Bruce, Geo. Esq.	5	0	0	Cumming and Sons, Messrs.	7	6	0
Baldon, H. C. Esq.	5	0	0	Bruce, Miss	10	0	0	Cumming, Miss	5	0	0
Baillie & Co. Messrs.	5	0	0	Bruce, Miss	5	0	0	Cunningham, George, Esq.	2	2	0
T.	5	0	0	Bryden and Son, Messrs. W.	5	0	0	Cunningham, Messrs. J. and J.	10	0	0
Baillie and Son, Messrs. W.	10	6	0	Bryson and Son, Messrs. R.	5	0	0	Cunningham, R. W. Esq.	5	0	0
Baillie, J. M. Esq., C.A.	10	0	0	Burges, Mrs.	5	0	0	Currie and Co. Messrs. James	1	1	0
Bain, G. Esq.	5	0	0	Burn and Son, Messrs. G.	5	0	0	Curriehill, The Hon. Lord	1	0	0
*Baird, Sir Jas. G.	1	0	0	Burnley, W. F. Esq.	1	0	0	Cuthbert, Miss	5	0	0
Baird, Miss	5	0	0	Burns, Geo. Esq.	5	0	0	Dalglish, Mrs.	5	0	0
Balfour, J. H. Esq.	5	0	0	Caird, Mrs.	5	0	0	Dalziel, Misses	5	0	0
Balfour, Dr. A. G. Thomas	5	0	0	Callander and Sons, Messrs. David	1	1	0	Dalziel, George, Esq.	10	0	0
Ballantyne, Hanson, and Co. Messrs.	5	0	0	Cameron, C. Esq.	5	0	0	*Davidson, Lieut., Col. H.E.I.C.S.	10	0	0
Ballantine and Son, Messrs. Geo.	5	0	0	Campbell, A. Esq.	1	0	0	Davidson, Pirrie, and Co., Messrs.	5	0	0
*Barbour, G. F. Esq.	1	0	0	Campbell, John, Esq.	10	0	0	Davis and Primrose, Messrs.	5	0	0
Barclay, Rev. J.	5	0	0	Campbell, Mrs.	5	0	0	Dempster, Mrs.	5	0	0
Barclay, Mrs.	5	0	0	Capper, J. J. Esq.	1	0	0	Denchar, David, Esq.	1	0	0
Barnhill, Mrs.	5	0	0	Carron Iron Co.	5	0	0	Dick, John, Esq.	5	0	0
Barret, Miss	5	0	0	Carruthers, P. Esq.	1	0	0	Dickson, D. S. Esq.	10	6	0
Barry, Mr. John	5	0	0	Cathcart, Mrs.	5	0	0	*Dickson and Co. Messrs. James	10	0	0
Barstow, C. M. Esq.	5	0	0	C. E. M.	5	0	0	Dickson and Walker, Messrs.	5	0	0
Barton, Mrs. D.	10	0	0	Chalmers, Mrs.	5	0	0	Dickson, Sam. Esq.	1	0	0
Baxter, E. Esq.	1	0	0	Chalmers & Co. Messrs. Thomas	5	0	0	Dickson, Wm. Esq.	5	0	0
Bayley, Mrs.	5	0	0	Chambers, Messrs. W. and R.	2	2	0	Dicksons and Co. Messrs.	5	0	0
Beattie and Sons, Messrs. W. H.	5	0	0	Chapman, Mrs.	5	0	0	Donaldson, A. Esq.	5	0	0
Beilby, J. H. Esq., per the Association for Improving the Condition of the Poor	1	0	0	Cheape, Hon. Mrs.	5	0	0	Douglas, Francis Brown, Esq.	10	0	0
Beith, Rev. Dr.	5	0	0	Cheape, Misses	5	0	0	Douglas, Mrs.	5	0	0
Bell, A. M. Esq.	5	0	0	Chiene, George Todd, Esq.	5	0	0	Douglas, Miss	10	0	0
Bell, Mrs. Glassford, & Miss Sandeman	10	0	0	Chisholm, David, Esq.	5	0	0	Dowden, Mrs.	5	0	0
Bell, W. Esq.	1	1	0	Chisholm, Mrs.	5	0	0	Dowell, Alex. Esq.	5	0	0
Bell, Rannie, and Co. Messrs.	1	1	0	Christie and Kilpatrick, Messrs.	5	0	0	Downie and Laird, Messrs.	5	0	0
Bell, James & Co., Messrs.	5	0	0	Christie, W. Esq.	5	0	0	Drummond Brothers, Messrs.	5	0	0
Bernard and Co. Messrs.	10	6	0	Christie, Mrs. S.	5	0	0	Drummond, James, Esq.	5	0	0
Bernard, Messrs. T. and J.	10	0	0	Christison, David, Esq., M.D.	1	0	0	Drummond, Mrs. D. Esq.	5	0	0
Berry, Barclay, and Co. Messrs.	1	1	0	Christison, John, Esq., W.S.	10	0	0	Drybrough, John, Esq.	5	0	0
Berry, Mrs. G.	10	0	0	Church, Dr.	5	0	0	Drybrough and Co. Messrs. N. B.	5	0	0
Bertram, Geo. & Wm. Messrs.	10	0	0	*Clapperton, John, Esq.	1	0	0	Dudgeon, Mrs.	5	0	0
Bertram & Son, Messrs. James.	5	0	0	Clark, Alexander, Esq., Hon. Lord	2	0	0	Duncan, Flockhart, and Co. Messrs.	10	0	0
Bevan, Mrs.	10	0	0	Clark, Hon. Lord Rutherford	2	0	0	Duncan and Co. Messrs. James	5	0	0
Beveridge, J. A. Esq.	1	0	0	Clark and Pinkerton, Messrs.	5	0	0	Duncan, Miss	5	0	0
Beveridge, Miss	10	0	0	Clerk, Lady	5	0	0	Duncan, H. Macduff, Esq.	5	0	0
Bishop, John, Esq.	5	0	0	Clunes, James, Esq.	10	0	0	Duncanson, Dr. Kirk	5	0	0
*Black, Messrs. A. & C.	10	0	0	Cockburn, Alexander, Esq.	10	0	0	Dunn, J. W. Esq.	5	0	0
Black, Mrs.	5	0	0	Cockburn and Campbell, Messrs.	2	0	0	Dunsinure, Dr.	5	0	0
Blackhall Brothers, Messrs.	10	0	0	Cockburn and Co. Messrs.	1	1	0	Dymock and Guthrie, Messrs.	5	0	0
Blackwood, Mrs.	5	0	0	Collie, Mrs.	5	0	0	Dymock, Jas. R. Esq.	10	0	0
Blackwood, Miss	5	0	0	Colquhoun, John, Esq.	5	0	0	D. C., Redhall	5	0	0
Blair, A. Esq.	5	0	0	Cook, Misses	10	0	0	Edinburgh Roperie Co., Messrs. the	1	1	0
*Blyth, E. L. I. Esq.	10	0	0	Constable, Messrs. T. and A.	5	0	0	Edinburgh and Leith Brewery Co.	5	0	0
Bolton, David, Esq.	5	0	0	Corawall, Misses	5	0	0	Edmonston, Thomas, Esq.	10	0	0
Bonar, Mrs. Thomas	5	0	0	Corrie, Hanson, & Co. Messrs.	1	1	0	Edmonstone, Sir Wm. Bart., M.P.	1	0	0
Bow, R. H. Esq.	10	0	0	Cousin, Mrs.	5	0	0	Edwards, H. C. Esq.	10	0	0
*Boyd, Sir Thomas J. Lord Provost.	1	1	0	Cowan and Co.	5	0	0	Ellis, W. M. Esq.	10	0	0
Boyd, Thomas, Esq.	1	1	0	Cowan and Strachan, Messrs.	10	0	0	E. M. B.	5	0	0
Braidwood & Fowler, Messrs.	5	0	0	Cowan, John, Esq.	1	0	0	E. T.	5	0	0
Brakenridge, Mrs.	5	0	0	Cowan, Miss	5	0	0	Faithfull, Mrs.	5	0	0
Bramwell, Byrom, Esq. M.D.	5	0	0	Cowan, J., Esq., W.S.	5	0	0	Fairbairn, Mrs.	5	0	0
Bringloe, Francis A. Esq.	5	0	0	Cowper, Mrs.	5	0	0	Falconer, Miss	1	0	0
Brodie, Hamilton, and Co. Messrs.	5	0	0	Cowper, Mrs. C. M.	5	0	0	Farmer, Mr. John	5	0	0
Brodie, J. Clerk, Esq.	1	0	0	Cowper, W. H. Esq.	5	0	0	Fenwick, Bruce, Esq.	5	0	0
Brodie, T. D. Esq.	10	0	0	Cox, Mrs. J.	5	0	0	Fergus, Mr. William	5	0	0
Brotchie & Co. Messrs. R.	1	1	0	Craig & Rose, Messrs.	5	0	0	Ferguson, Davidson, and Co. Messrs.	1	1	0
Brown, Dr. Crum	5	0	0	Crawford, Messrs. A. and A.	10	6	0				
Brown & Son, Messrs. H.	5	0	0	Crichton, Mrs. G. H.	5	0	0				
Brown, Miss	5	0	0	Crudellus, Hirst, and Co. Messrs.	10	0	0				
Brown, Mrs.	1	0	0	Cruikshank and Son, Messrs.	5	0	0				

£. s. d.		£. s. d.		£. s. d.		£. s. d.	
Ferguson and Co.		Hill, W. Scott, Esq.	10 0	Mackay & Co. Messrs.		Morton, Mr.	5 0
Messrs. Thomas	5 0	Hill, Mrs.	5 0	George	5 0	Mowbray, Robt. Esq.	1 1 0
Ferguson, Mrs.	5 0	Hodge, Mrs. Charles	5 0	Mackenzie, Colin		Muir, & Son, Messrs.	
Finlay, J. R. Esq.	1 1 0	Hodge, Mrs. T.	5 0	Esq.	5 0	J., N.B.	5 0
Finlay, William, Esq.	5 0	Hog, Mrs.	10 0	Mackenzie, John Ord		Munro, J. Esq.	10 0
Finnie, Mrs.	5 0	Honeyman & Wilson,		Esq.	10 0	Murdoch, A. B. Esq.	5 0
Finnie, Miss	5 0	Messrs.	10 0	Mackenzie, Miss	10 6	Murdoch, Dr. Burn.	5 0
Fleming, J. Esq.	5 0	Hope, James, Esq.	1 0 0	Mackenzie, Miss	5 0	Mure, Lord	5 0 0
Flett, Mrs.	5 0	Hope, Mrs. James	10 0	Mackie, T. W. and		Mure, Miss	5 0
Forrest & Turnbull,		Hope, John, Esq.	1 0 0	Sons, Messrs.	5 0	Mure, Miss S.	5 0
Messrs.	5 0	Horn, Mrs. Robert	10 0	Mackinlay and Co.		Murray, George, Esq.	
Forbes, Misses	10 0	Horne, T. E. O. Esq.	5 0	Messrs. C.	10 6	C.A.	5 0
Forbes, Mrs.	5 0	Howden, Miss	3 0 0	MacLagan, Mrs. D.	5 0	Murray, Miss	5 0
Ford & Co., Messrs.		Howden, J. A. Esq.	5 0	Macleod, Wm. Bow-		Murray, Miss	5 0
John	5 0	Howe, Alex. Esq.	1 0 0	mon, Esq.	10 0	Murray, Mrs.	5 0
Ford & Sons, Messrs.		*Hawkings, John, Esq.	1 0 0	Macnair, John, Esq.	1 0 0	Murray, Mts.	5 0
W.	1 1 0	Hoyes, John, Esq.	1 0 0	Macnee, D. Esq.	5 0	Murray, R. Esq.	5 0
Forsyth, Mrs.	10 0	Hunter, J. A. Esq.	5 0	McCandlish, J. M.		Murray, Sir Patrick	
Fraser, Mrs.	10 0	Hunter, Miss	5 0	Esq.	10 0	Keith, Bar.	2 0 0
Fraser, Mrs.	5 0	Hunter, Robert, Esq.	1 0 0	M'Diarmid, W. R.		Murray, T. G. Esq.	5 0 0
Fraser, Mrs.	5 0	Hutchinson Brothers,		Esq.	5 0	Myle, Mrs. J.	5 0
Friend, A.	5 0	Messrs.	5 0	M'Dowall, Mrs.	10 0	Napier, G. Esq.	1 0 0
Friend, A.	5 0	Innes, Mrs.	5 0	M'Ewan, Wm. Esq.	1 1 0	Nelson and Sons,	
Friend, A.	5 0	Inglis, H. M. Esq.	1 0 0	M'Farlane & Son,		Messrs. Thomas	1 0 0
Friend, A.	5 0	Ivory, Thomas, Esq.	5 0	Messrs.	5 0	Newton, James, Esq.	5 0
Friend, A.	1 0 0	Ivory, Miss	1 0 0	M'Gibbon, Mrs.	5 0	Nicolson, D. Esq.	10 0
Friends	5 0	Jack, J. H. H. Esq.	5 0	M'Gregor, Douglas,		Nimmo, W. Esq.	10 6
Fulton & Co. Messrs.		Jamieson, Mrs.	5 0	Esq.	5 0	Ogilvie, G. Moncreiff,	
J.	1 1 0	Jamieson and Co.		McGregor & Pringle,		Esq.	5 0
Gallie, Laird, and Co.		Messrs. Robert	5 0	Messrs.	1 1 0	Othpant, Mr. School	5 0
Messrs.	5 0	Jeffrey, Mrs.	10 0	M'Intosh, J. B. Esq.	5 0	Padon, Messrs. A. & D.	5 0
Galloway, Mrs. John	1 0 0	Jenner and Co. Messrs.		M'Pherson, Professor	5 0	Pagan, Mrs.	10 0
Geddes, Mrs.	5 0	Charles	1 2 0	M'Laren, D. & Co.		Pairman Brothers,	
Gibson, Messrs. R.		J. H.	1 0 0	Messrs.	10 0	Messrs.	5 0
and T.	10 6	J. H.	5 0	M'Laren, Duncan,		Pairman, Mrs.	5 0
Gibson and Walker,		Johnson, Robt. Esq.	5 5 0	Jun. Esq.	10 0	Paterson and Sons,	
Messrs.	1 1 0	Johnstone, Messrs.		M'Laren, Messrs. D.		Messrs.	1 1 0
Gibson's Heirs, H. C.	5 0	W. and A. K.	1 1 0	and G.	1 1 0	Paterson, Miss	5 0
Gibson, Thomas, Esq.	10 0	Jopp, Mrs. Charles	10 0	M'Laren, Mrs.	5 0	Paterson, J. N., and	
Gillanders, Mrs.	5 0	Justice-General, The		M'Laren, D. Esq.,		Miss	10 0
Gillespie, Dr.	5 0	Lord	1 0 0	per the Association		Paterson, Jas. Esq.	5 0
Gillespie and Cathcart,		Kemp, Hislop, & Co.		for Improving the		Paton, Lady	10 0
Messrs.	2 2 0	Messrs.	5 0	Condition of the		Pattison, P. Esq.	5 0
Gillon & Co. Messrs.		Kennedy, John, Esq.	1 0 0	Poor	10 0	Pearson, Charles, Esq.	1 0 0
John	10 6	Kirkpatrick, Dr.	5 0	Maitland, Miss	5 0	Peddie, A. Esq. M.D.	5 0
Gilroy, G. Esq.	5 0	Knoblauch, Hugo, Esq.	5 0	Maitland, Mrs.	5 0	Pendrigh, W. Esq.	5 0
Glegg, Mrs.	5 0	Laing, W. and Co.		Marshall and Co.		Penny, Mrs.	10 0
Gordon, Robert, Esq.	5 0	Messrs.	1 1 0	Messrs. W.	10 0	Pentland, Y. Esq.	5 0
Gordon, Mr.	5 0	Lancaster, Mrs.	5 0	Marshall, F. Esq.	10 0	Petrie and Co. Messrs.	
Gordon, Mrs.	5 0	Laurie, Jas. D. Esq.	1 1 0	Marshall, Mrs.	10 0	Phillip	5 0
Gow, Alex. Esq.	5 0	Law, Messrs. W. & G.	10 0	Marshall, Mrs.	10 0	Philip and Son,	
Gray, Robert, Esq.	5 0	Leadbeater, Mrs.	5 0	Marshall, Mrs.	5 0	Messrs. John	10 0
Gray, Mrs. A.	5 0	Learmonth, Mrs.	5 0	Marshall, Mrs.	5 0	Pitman, F. Esq.	5 0
Gray and Son, Messrs.		Learmonth, Mrs. L.	5 0	Marshall, Miss	5 0	Playfair, Dr.	5 0
James	5 0	Leask, J. B. Esq.	10 0	Martin, John, Esq.	5 0	Pollock, Mrs.	5 0
Gunn, Miss	5 0	Lees and Co. Messrs.		Mathieson, Mrs.	1 0 0	Prevost, Colonel	10 0
G. B.	5 0	John	10 0	Melrose and Co.		Pringle, Robert, Esq.	10 0
Hadden and Son,		Lennie, E. Esq.	5 0	Messrs. A.	1 0 0	Raeburn, Messrs. W.	
Messrs. R.	5 0	Leslie, James, Esq.	5 0	Melville, Miss	5 0	and J.	10 0
Hagart, T. C. Esq.	5 0	Leslie, Miss	10 0	Melvin, Alex. & Co.		Ramsay, Geo. Esq.	1 0 0
Haldane, Mrs.	10 0	Lewis, John, Esq.	1 0 0	Messrs.	5 0	Rankin, Miss	5 0
Haldane, Mrs.	5 0	Lewis, Mrs.	5 0	Menzies & Co. Messrs.	5 0	Hankin, George	5 0
Halkett, Lady	5 0	Lindsay, Colonel	1 0 0	Menzies, John R.		R. C.	10 0
Hamilton, Claud H.		Lindsay and Son,		Esq.	10 6	Redpath, Brown, and	
Esq. per the Assoc-		Messrs. James	5 0	Miller, Mrs. John	5 0	Co. Messrs.	10 6
iation for Im-		Livingstone & Weir,		Miller and Sons,		Reid, William, Esq.	10 0
proving the Con-		Messrs.	1 1 0	Messrs. James	1 1 0	Renny, Chas. Esq.	10 0
dition of the Poor.	10 0 0	Lockhart, Mrs.	5 0	Miller, John, Esq.	1 0 0	Renton, W. Esq.	5 0
Hamilton, H. Esq.	5 0	London & Edinburgh		Miller, R. Esq.	1 1 0	Rhind, D. A. & Co.	
Harrison and Co.		Shipping Co.	1 1 0	Miller, Mrs. H.	5 0	Messrs.	5 0
Messrs.	10 6	Lord Advocate	5 0	Mihue & Sons, Messrs.		Richardson and Co.	
Harvey, R. E. Esq.	10 6	Lorimer, J. Campbell,		J.	10 0	Messrs. Francis	5 0
Harvey, Mrs. G. M.	5 0	Esq.	5 0	Mitroy, John, Esq.	10 0	Richardson, Mrs.	5 0
Hawthorns and Co.,		Lothian, E. Esq.	10 0	Mitchell, and Co.		Richardson, P. Esq.	10 0
Messrs.	1 1 0	Lothian, Miss	5 0	Messrs. J.	5 0	Richardson, Mrs.	5 0
*Hay, Admiral	5 0	Low, Robertson, and		Moir, Mrs.	5 0	Richardson, Rob. Esq.	1 0 0
Hay, and Co. Messrs.		Co. Messrs.	5 0	Moncreiff, J. Scott,		Ritchie, A. Esq.	5 0
James	10 0	Lumsden, Mrs.	5 0	Esq.	5 0	Ritchie, A. Esq.	5 0
Hay, D. Esq.	10 0	Lyon and Turnbull,		Moncreiff, W. Esq.	5 0	Ritchie, George, Esq.	10 0
Hay, H. S. A. Esq.	10 0	Messrs.	10 0	Moncreiff, Lady	5 0	Ritchie and Sons,	
Hayward, Robt. Esq.	5 0	M. A. H. C.	5 0	Montgomery, The		Messrs. James	5 0
Henderson, Miss.	5 0	M. B.	10 0	Very Rev. J. F.	5 0	Ritchie, Simon, Esq.	5 0
Henderson, Miss.	5 0	Macandrew, Jas. Esq.	5 0	Moore, Lady Elizabeth	1 0 0	Robertson Brothers,	
Henderson, Mrs.	10 0	Macdonald Robertson,		Moore, Mrs.	5 0	Messrs.	1 1 0
Henry, John, Esq.,		Misses	5 0	Mooreland Lodge	5 0	Robertson, C.S. Esq.	1 1 0
S.S.C.	1 0 0	Macduff, Mrs.	5 0	Morison, Patrick G.		Robertson, Messrs.	
Hewit, Peden & Co.		Macfarlane and Co.		Esq.	5 0	J. and D.	5 0
Messrs.	5 0	Messrs. J. F.	10 0	Morrison, Messrs. J.		Robertson, Miss	5 0
Hewit & Sons, Messrs.		Macfarlane, M. Esq.	10 0	and G.	10 6	Robertson, Sanderson	
Hill, Miss.	5 0	Macfarlane and Co.		Morrison, Messrs. J.		and Co. Messrs.	5 0
Hill, Thomson, and		Messrs. D.	5 0	and J.	5 0	Robinow, Majoribanks,	
Co. Messrs.	5 0	Macfarlane, John, Esq.	1 0 0	Morrison, R. M. Esq.	5 0	and Co. Messrs.	1 1 0

BRANCHES—LIST OF ANNUAL SUBSCRIPTIONS AND DONATIONS. 609

£. s. d.			£. s. d.			£. s. d.			£. s. d.						
Rodger, Miss.....	-	10	0	Stewart, Mrs. Robert-	-	5	0	Williamson, Charles,	-	10	6	Thomson, Mrs. C. J.	-	5	0
Rollo, H. J. Esq.	-	5	0	son	-	5	0	Esq.	-	10	6	Whitelaw, Mr. David ..	-	5	0
Romanes & Paterson,				Stirling, Mrs.	-	5	0	Wilson, Miss.	-	10	0	Wilkie, Messrs. J. & A. ..	-	10	0
Messrs.	-	5	0	Straton, Mrs.	-	5	0	Wilson, W. S. Esq.	-	10	0	Contributions under			
Romanes, Mrs.	-	10	0	Stuart, R. L. Esq.	1	0	0	Wingate, Miss.	2	0	0	5s.	2	19	6
Ross, Mrs. George	-	5	0	Stuart, R. L. Esq.	1	0	0	Wishart and Sons,				Total	£215	5	6
Ross, Mrs. Ker	-	10	0	Swan & Son, Messrs.				Messrs. James.	1	1	0				
Roughhead, Mrs., Sen.	-	5	0	J.	-	5	0	Wishart, D. F. Esq.	1	0	0				
Rusell, Mrs.	-	5	0	Syme, Miss.	-	10	6	Wood & Co. Messrs.	-	5	0				
Rutherford and Co.				Syme, Mrs.	-	5	0	Wood, John A. Esq.	-	5	0				
Messrs.	-	10	0	Syme, Mrs., "Waver-				Wood, Misses.	-	5	0				
Salveson, Mrs. T.	-	5	0	ley"	-	5	0	Wood, W. Esq.	1	0	0				
Sampson, Miss.	-	5	0	Sums under 6s.	43	6	6	Wood, J. P. Esq.	1	0	0				
Sanderson, William,				Tainsh, James, Esq.	-	10	6	Wren, George, Esq.	-	5	0				
Esq.	-	5	0	Taylor & Co. Messrs.				Wright, Messrs. P.							
Sandersou and Co.,				W.	1	1	0	and R.	-	5	0				
Messrs.	-	5	0	Taylor, William, Esq.	-	5	0	Wright, H. Guthrie,							
Sandford, D. F. Esq.	-	5	0	Taylor, Arch., Esq.	-	5	0	Esq.	-	10	0				
Sands, Miss.	1	0	0	Teigamouth, Lord.	-	5	0	Wright, John P. Esq.	-	5	0				
Sang and Barker,				Tennant, R. Esq.	-	10	0	Young, James, Esq.							
Messrs.	-	10	0	The Singer Machine				M. A.	-	5	0				
Scott & Allan, Messrs.	1	0	0	Manufacturing Co.	-	5	0	Young, J. W. Esq.	1	0	0				
Scott and Anderson,				Thomas, Capt. F. W.				Young, Mrs. R.	-	5	0				
Messrs.	-	10	6	L., R.N.	-	10	0	Younger, Robt. Esq.	-	10	0				
Scott, A. W. Esq.	-	5	0	Thomson, A. Esq.	-	5	0	Younger and Co.							
Scott Bros., Messrs.	5	0	0	Thomson, Chas. W.				Messrs. W.	1	1	0				
Scott, T. Esq.	-	5	0	Esq.	-	5	0	Total.....	403	12	0				
Scott, A. Esq.	-	5	0	Thomson and Co.											
Scott, James, Esq.	-	5	0	Messrs. R. H.	-	10	6								
Scott, Mrs.	-	5	0	Thomson and Co.											
Scottish Iron S.S. In-	5	5	0	Messrs. W.	-	10	6								
surance Association				Thomson, J. G. Esq.	-	10	0								
Scater, White, & Co.,				Thomson, Miss.	-	5	0								
Messrs.	1	1	0	Thomson, W. T. Esq.	-	10	0								
Shand, Hon. Lord,				Thomson and Co.											
per the Association				Messrs. D. J.	-	10	6								
for Improving the				Tod Bros., Messrs.	-	5	0								
Condition of the				Tod, Henry, Esq. W.S.	-	5	0								
Poor	1	1	0	Tod, J. H., Esq.	-	10	0								
Shand, Mrs.	-	5	0	Tod, J. W. Esq.	-	5	0								
Shepherd, Mrs.	-	5	0	Torry, John, Esq.	-	5	0								
Shiels, J. S. and Sons,				Trinity House, The.	2	0	0								
Messrs.	1	1	0	Trinity, Contribu-											
Shields, Robert &				tion Box	-	19	0								
Son, Messrs.	-	5	0	Trotter, Miss.	-	5	0								
Sidley, Charles, Esq.	-	5	0	Turnbull, Miss.	-	5	0								
Sim and Barclay,				Turnbull, Mr. & Mrs.											
Messrs.	-	5	0	A. H., per Associa-											
Sim, M. R. Esq.	-	5	0	tion for Improving											
Simpson, Jno. A.				the Condition of											
Esq.	1	1	0	the Poor	-	10	0								
Simpson, Mrs.	1	0	0	Turnbull and Wilson,											
Simpson, Mrs.	-	5	0	Messrs.	-	5	0								
Simson, David, Esq.	-	5	0	Tytler, G. M. Fraser,											
Simson, Mrs.	-	10	0	Esq.	1	0	0								
Simson, Mrs.	-	5	0	Tytler, J. S. Esq.	-	10	0								
*Sinclair, R.	-	10	6	Usher and Co. Messrs.											
Simon, Messrs. R.				Andrew	1	1	0								
and D.	-	5	0	Usher, Messrs. J. & T.	2	2	0								
Smith and Son,				Urmiston, Mrs.	-	10	0								
Messrs. John.	-	10	6	Waddell, Mrs. Peddie											
Smith, J. Esq.	-	5	0	Waddie & Co. Messrs.	-	5	0								
Smith, Messrs. T. and				Waddilove, Miss.	-	5	0								
H.	-	10	0	Walker, James, Esq.	1	0	0								
Smith, Miss C. R.	1	0	0	Walker, Mr.	-	5	0								
Smith, Mrs.	-	5	0	Walker, Mrs.	-	5	0								
Smith, Messrs. D. &				Walker, Messrs. G.											
Co.	-	5	0	and J.	-	10	0								
Smith, Maj.-General				Warden and Co.											
T. N.	-	10	0	Messrs. William.	-	5	0								
Smith, W. Esq.	-	5	0	Warrack and Co.											
Smith, John A., M.D.	-	5	0	Messrs. John.	1	1	0								
Sommerville and Co.				Waterson and Sons,											
Messrs. John.	-	10	6	Messrs.	1	1	0								
Somerville, Miss.	-	5	0	Watson, Mrs. D.	-	5	0								
Spence, Mrs.	-	5	0	Watson, John, Esq.	1	1	0								
Sprague, T. B. Esq.	-	5	0	Watt, James, Esq.	-	10	6								
Sprot, Misses.	-	5	0	Wauchope, Moodie,											
Steen, J. C. Esq.	-	5	0	and Hope, Messrs.	1	1	0								
Stevenson, Miss.	-	10	0	Webster, Mrs.	-	5	0								
Stevenson, Rev. Dr.	-	5	0	Weir, Mrs. G.	-	5	0								
Stevenson, Mrs.	-	5	0	Wenley, James A.											
Stevenson, Miss.	-	10	0	Esq.	1	0	0								
Stewart, Clapperton,				White, Burns, & Co.											
& Co. Messrs., S.B.	-	5	0	Messrs.	-	10	0								
Stewart, Chas. Esq.	-	5	0	White & Co. Messrs.											
Stewart, Messrs. J.				R.	-	5	0								
and G.	-	5	0	White, John, Esq.	-	5	0								
Stewart, James, Esq.	-	5	0	White, John, Esq.	-	5	0								
Stewart, John, Esq.	-	5	0	White, John, Esq.	-	5	0								
Stewart, Mrs. Grainger-				White, John, Esq.	-	5	0								
Stewart, Mrs.	-	5	0	White, Mrs.	-	5	0								
				White, Mrs.	-	5	0								
				Whitten, J. C. Esq.	-	5	0								
				Whyte and Son,											
				Messrs. A.	-	5	0								

Elginshire.

LOSSEMOUTH
BRANCH.

Chairman—
Capt. J. B. DUNBAR BRANDER
of Pitgaveny.

Honorary Secretary—
Mr. JOHN FERGUSON.

Annual Subscriptions.

£. s. d.			
Adam, Dr.	-	5	0
Allan and Co.	-	5	0
Allan, James.	-	5	0
*Anderson, Capt.	-	10	0
Anderson, Wm. Esq.	1	0	0
Bennet, James.	-	5	0
Black, Provost.	-	5	0
*Brander, Robert.	-	5	0
Cameron, Alex.	-	10	6
*Clark, Charles.	-	5	0
Cooper and Wink.	-	5	0
Culhard, William.	-	5	0
Duff, General.	-	5	0
Edgar, James.	-	5	0
Ettles, James.	-	5	0
Forsyth, David.	-	5	0
Gatherer, George.	-	5	0
Gordon, John.	-	5	0
Gordon, W. R.	-	5	0
Grigor and Young.	-	5	0
Jamieson, James.	-	5	0
Johnston, Major.	-	5	0
Macdonald, William.	-	5	0
Maclean, Hugh, of			
Westfold.	-	5	0
Morrison, Alex.	-	5	0
Munro, John.	-	5	0

	£.	s.	d.
Forbes, R. Esq.	7	6	
*Fowler, G. S. Esq. . .	1	0	0
Fowler, Miss s.	5	0	
Irvine, W. D. Esq. . .	1	0	0
Jamieson, W. T. Esq. .	7	6	
Lloyd, Rev. F. K. . .	5	0	
*Mackintosh, H.B. Esq.	10	6	
Martin, John & Co. . .	5	0	
*Murray, W. Esq.	10	6	
*Olyphant, P. Esq. . .	10	6	
Sea Box Society . . .	1	1	0
Sharp and Murray . .	10	6	
*Watson, Provost . . .	5	0	
Williamson, Mrs. . . .	10	0	
Williamson, Millie-			
gan, and Co.	2	0	0
Williamson, S. Esq. . .			
M.P.	1	0	0
Woodcock, Dr. R.N. . .	5	0	
Contribution Box . . .	12	5	
Sums under 5s.	5	3	9
Total	£19	0	8

DUNFERMLINE BRANCH.

President—			
Ex-PROVOST MATHIESON.			
Honorary Secretary—			
ROBERT STEEDMAN, Esq.			
Annual Subscriptions.			
A Lady Friend	1	0	0
Alexander, Daniel . . .	5	0	
*Alexander, Thomas 1	0	0	
Alexander, Thomas,			
Jun.	10	0	
Barclay, John	5	0	
Bardner, Henry	5	0	
*Beveridge, Erskine. .	10	0	
Beveridge, H.	10	0	
*Donald, Robert	1	0	0
Dunbar, Rev. J. W. . . .	5	0	
Hay, James	5	0	
Hay, Mrs.	5	0	
Hay and Robertson . .	1	0	0
Ingils, William	5	0	
Landale, John	10	0	
*Macfarlane, James. 1	0	0	
*Laren, John and			
William	10	0	
Mathieson, K.	5	0	
Mathewson, James . . .	10	0	
*Mathewson, William 1	0	0	
Morris, Dr.	5	0	
Nicholson, W.	5	0	
Reid, George	10	0	
Reid, Robert	5	0	
Reid, William	5	0	
*Romance, Archibald .	5	0	
Ross, John	5	0	
Rutherford, D. G. . . .	5	0	
Sampson, John	5	0	
Seath, Alexander	5	0	
Scobie, Andrew	5	0	
Smith, Adam	5	0	
*Spowart, Thomas,			
V.P.	1	0	0
Stalker, John	5	0	
Steedman, Robt.	5	0	
Stevenson, Robert . . .	5	0	
Stewart, R. W.	5	0	
Taylor, Mrs. Peter . . .	5	0	
*Walker, Thomas	1	0	0
*Wallace, Andrew . . .	1	0	0
*Walls, James	5	0	
Wardlaw, Jas. L.	5	0	
Westwood, Wm.	5	0	
Wilson, John	5	0	
Wilson, Robert M. . . .	10	0	
Sums under 5s.	7	15	6
Total	£27	15	6

ST. ANDREW'S BRANCH.

Chairman—			
Treasurer—			
ANDREW STRE, Esq.			
Honorary Secretary—			
Annual Subscriptions.			
	£.	s.	d.
Brown, Misses	5	0	
Chrystie, Mrs.	1	0	0
City of St. Andrews. 5	0	0	
Gordon, T. C.	5	0	
McGregor, Gregor . . .	5	0	
Ochterlony, Sir C. M.			
Bart.	5	0	
Oliphant, T. T.	10	6	
Patton, Maj. Malcolm . .	10	0	
*Purdie, Thomas	10	0	
Stirling, T. M.	10	0	
Welch, Baillie	10	0	
Whyte-Melville, J. . . .	10	0	
Sums under 5s.	5	0	
Total	10	5	6
Donations.			
Carnegie, Major	1	0	0
Duncan, Mrs.	5	0	
Total Dons.	1	5	0
Total Subs.	10	5	6
£11	10	6	
Annual Subscriptions			
in aid of "Ladies'			
Own" Life-boat,			
perMissSmithers—			
A Friend, per Mrs.			
Prince	1	1	0
Clegg, E. A.	1	1	0
Kershaw, J. S.	1	1	0
Law, A.	1	1	0
Law, W.	1	1	0
Major, Miss	5	0	
Parr, B.	5	0	
Prince, Miss	5	0	
Smithers, Miss.	5	0	
Stevenson, J. S. Esq. 1	1	0	0
Total	7	6	0

Forfarshire.

ARBROATH BRANCH.

Chairman—			
ALEX. REID, Esq., Provost of Arbroath.			
Honorary Secretary—			
WM. CARRILL, Esq.			
Annual Subscriptions.			
	£.	s.	d.
Aitken, Mr.	5	0	
Anderson, Mr. David . .	5	0	
Balfour & Cummings,			
Messrs.	10	0	
Binney, Mr. Andrew . .	10	0	
*Boyd, Mr. James	5	0	
Briggs, W.	5	0	
Burnet, Mr. William . .	5	0	
Cargill, Mr. David . . .	5	0	
Carnegie, H. F. Lind-			
say, Esq.	10	0	
Chapel, Mr. David	5	0	
Christie, Miss	5	0	

*Corsar, Mr. Chas. W. . .			
10 0			
*Corsar, Mr. Wm. H. . . .			
10 0			
*Corsar Bros. Messrs. . .			
10 0			
Dalhousie, Rt. Hon.			
the Earl of			
1 0 0			
*Dickson, Mr. Jas. A. . .			
10 0			
Dickson, Mr. J. F.			
5 0			
Donaldson, Mr. Robt. . .			
5 0			
Duncan, Mr. John			
10 0			
*Ferguson, Messrs. J.			
and A.			
5 0			
Forbes, Mr. Thos.			
5 0			
Fraser and Sons,			
Messrs. D.			
10 0			
Fraser, Mr. Pat. A.			
1 0 0			
Gordon, A.			
10 0			
Guthrie and McCor-			
quodale			
5 0			
Jamieson, J.			
5 0			
Laird, Mr. George			
10 0			
*Lowson, Mr. Andrew . .			
10 0			
Macdonald, J. & W. . . .			
10 0			
Miln, Mr. George			
5 0			
*Muir, Mr. James			
10 0			
Nicol & Co. Messrs. A. . .			
5 0			
Pierson, Mrs.			
1 0 0			
*Raitt, Mr. Jonathan . . .			
5 0			
*Reid, Mr. Alex.			
5 0			
Robertson, George. . . .			
5 0			
Roy, Messrs. Adam			
& Sons			
5 0			
Salmond and Son,			
Messrs. W.			
10 0			
Salmond, Mr. Jos.			
5 0			
Shanks, Mr. James			
5 0			
Smart and Ogg			
5 0			
Webster, Messrs. F.			
and Sons.			
10 0			
Webster, Mr. Wm.			
10 0			
Weir, Mr. James			
5 0			
Sums under 5s.			
3 17 6			
Total	21	7	6
Donations.			
A Friend	2	6	
Erskine Church Mis-			
sion School	11	0	
Thackeray, Lady Eliza-			
beth	100	0	0
Weir, Mr. James.	19	4	
Collected at Shore			
Dues Office.	6	13	0
Collected in Box at			
Life-boat House	1	1	6
Do. in Box at Pier . . .	1	8	6
Total Dons.	110	15	10
Total Subs.	21	7	6
£132	3	4	

DUNDEE BRANCH.

Chairman—			
WM. O. DALGLEISH, Esq.			
Treasurer—			
JAS. MUDIE, Esq.			
Honorary Secretary—			
JAMES HUNTER, Jun., Esq.			
Annual Subscriptions.			
Banks, A. M.	5	0	
Barrie, Joseph J.	1	0	0
Baxter, W. E. and			
Company	2	2	0
Bink, W. and H.	5	0	
*Bruce and Co. David 1	0	0	
Carmichael, James,			
and Co.	2	2	0
Cunningham, David 1	1	0	0
Dalglish, Mrs. Ogilvy 1	1	0	0
Dalhousie, Earl	1	1	0
Duncan & Son, P. M. 1	0	0	
Dundee, Loch Line . . .	2	2	0
Shipping Comp.	2	2	0
Feathers, P. A. & Son . .	10	6	

Gilroy, Alex. Jun.			
1 1 0			
Henderson, Alex.			
2 2 0			
Henderson, H. & Sons 2			
2 0 0			
Henderson, John, Jun. 1			
1 0 0			
*Ireland, Leitch, & Co. 1			
1 0 0			
Kennedy and Rae			
10 0			
Kinmond, Luke, & Co. 1			
1 1 0			
Leng, John			
1 1 0			
Lipman and Co.			
1 1 0			
Logie, James.			
10 0			
Low, James P.			
1 1 0			
Low, Samuel M.			
1 1 0			
Miller, James			
1 1 0			
Mitchell, James			
1 1 0			
*Mudie & Sons, R. A. 2			
2 2 0			
Mudie, R. A.			
1 1 0			
Pearce, Alfred W.			
1 1 0			
Popham, Mrs. B.			
1 0 0			
Rhinds, John			
1 1 0			
Scott, William			
1 0 0			
Stephen, William			
1 1 0			
Strong, William.			
1 1 0			
Taylor, Andrew			
1 1 0			
Taylor, Robert			
10 6			
*Taylor, W. O. & Co. 1			
1 0 0			
Thornton, Thos.			
2 2 0			
*Walker, Harry, and			
Son			
2 2 0			
Weinberg, J. J.			
1 1 0			
Total	46	9	0
Donations.			
Beach, A. C. W.			
Broughty Ferry			
2 4 0			
Harbour Treasurer			
sums levied on			
Shipping			
19 2 6			
Harbour Treasurer			
sums levied on			
Shipping for Half			
Year to 31st May,			
1881			
17 15 5			
Machan, John, Con-			
tributions from			
Seamen frequent-			
ing the Port.			
7 8 0			
Whiston, T. H. Blair-			
gowrie			
50 0 0			
Total Dons.	96	9	11
Total Subs.	46	9	0
£142	18	11	

MONTROSE BRANCH.

Chairman—			
PROVOST MITCHELL.			
Honorary Secretary—			
JAS. WARRACK, Esq.			
Annual Subscriptions.			
Aberdeen, F. Esq.	1	0	0
Arkiay, R. H. (2 yrs.) 4	0	0	
Baxter, David, Esq. . . .	5	0	
Burrell, Geo. Esq.	5	0	
C. S.	10	6	
Carnegy, Miss Eliza-			
beth	2	0	0
Chalmers, Geo. C. Esq. . .	5	0	
Dickson, Arthur, Esq. . .	10	6	
Davidson, Capt. D. C. . .	5	0	
Farfor, Capt.	5	0	
Findlay, J. R.	5	0	
Gibbons, R. Esq.	5	0	
Gordon, Mrs. W.	1	0	0
Greig, A. Esq.	10	6	
Interest from Har-			
bour Trustees	30	0	0
*Japp, J. and F.	5	0	
*Johnston, J. & Sons 5	0	0	
Key, Dr. Andrew	10	0	
Largie, George	10	0	
Lindsay and Son,			
Messrs. John	10	6	

BRANCHES—LIST OF ANNUAL SUBSCRIPTIONS AND DONATIONS. 611

	£.	s.	d.
Lawrence, Dr. S.	-	5	0
Mackenzie & Sons, Messrs. J.	-	5	0
*Mearns, Alex. Esq.	1	0	0
Middletou, Thos. Esq.	-	5	0
Millar, R. & Sons, Messrs.	2	2	0
Milne, John, Esq.	-	5	0
*Mitchell, Wm. Esq.	1	0	0
Moir & Son, Messrs. Wm.	-	5	0
Montrose Lime Co.	-	10	0
Murray & Co. Messrs.	-	10	6
Myers, Geo. C. Esq.	-	10	6
*Reid, Capt. Henry.	-	5	0
Reid, John, Esq.	-	5	0
Renny, Miss.	1	0	0
Ross, Oliver, Esq.	-	5	0
Samson, James, Esq.	-	5	0
Savage, James, Esq.	-	10	6
Stansfield, Capt.	2	0	0
Steele, Dr. H.	-	5	0
Walker, George, Esq.	-	5	0
*Warrack, J. & Co.	1	1	0
Watson, Dr.	-	5	0
*Watt, Alex. Esq.	-	5	0
Whimster, W. S. and Son.	-	5	0
Small Subscriptions	3	5	2
Cash in Collecting Boxes.	1	14	4
Total	£67	1	0
Donations.			
Anonymous, per W. D. Johnston, Esq.	2	0	0
Dalhousie, Rt. Hon. the Earl of.	1	0	0
Davidson, Messrs. J. & A., Aberdeen, Special.	5	5	0
Hardie, J. W. Esq.	1	0	0
Two Friends.	15	0	0
Total Dons.	24	5	0
Total Subs.	£67	1	0
Total	£91	6	0

Haddingtonshire.

DUNBAR BRANCH.

President—
THE DUKE OF ROXBURGH.

Chairman—
Colonel PURVES,
of Edenholm.

Honorary Secretary—
G. R. SCOTT, Esq.

Annual Subscriptions.

	£.	s.	d.
*Anderson, W.	-	10	0
*Brand, Provost.	-	10	0
Donations.			
A Friend.	-	10	0
*Brodie, A.	-	10	0
Buchanan, Rev. R.	-	10	0
Bryant, J. Ardglas, Ireland.	1	0	0
Roxburgh, Duke of.	1	0	0
*Scott, W. R.	-	10	0
Total	£5	0	0

NORTH BERWICK BRANCH.

President—
The Right Hon. LADY MARY
HAMILTON.

Chairman—
SIR HEW DALRYMPLE, BART.

Honorary Secretary—
DAVID McCULLOCH, Esq.

Annual Subscriptions.

	£.	s.	d.
Beveridge, W.	-	10	0
*Cree, James, Esq.	1	0	0
Jeffrey, David.	1	0	0
Lauderdale, Earl of.	5	0	0
*Malcolme, Walter, Esq.	1	0	0
*Suttie, Capt., R.N.	1	0	0
*McCulloch, D. Esq.	-	10	6
McIntyre, Mrs. per Capt. Suttie.	1	0	0
Wedderburn, Sir David.	1	0	0
*Woodrow, T. Esq.	-	10	0
Total	12	10	6

Donations.

Bloxson, W.	-	10	0
Campbell, George.	2	0	0
Cecil, Lady S.	1	1	0
Collected at annual exercise of Life- boat, including £5 from the Right Hon. Lady Mary Hamilton.	41	6	8
Duncan, Hon. Mrs.	1	0	0
Duncan, Lady E.	-	5	0
Haddingtonshire Ad- vertiser.	1	0	0
Laurie, W. Portobello.	-	12	6
Peploe, R. L.	-	5	0
Whitecross, J. R.	-	10	0
From Boxes.	3	0	2
Total Dons.	51	10	4
Total Subs.	12	10	6
Total	£64	0	10

Wincardineshire.

GOURDON BRANCH.

President—
JAMES FARQUHAR, Esq.,
Hallgreen.

Chairman—
HERCULES SCOTT, Esq.,
Brotherton.

Honorary Secretary—
Rev. JOHN BROWN,
Bervie.

	£.	s.	d.
Dickson, Patrick, Esq.	-	10	0
*Farquhar, James, Esq.	5	0	0
Farquhar, Major.	3	3	0
*Scott, Hercules, Esq.	10	10	0
Sums under 5s.	-	7	10
Total	19	15	10

STONEHAVEN BRANCH.

Patron—
SIR THOS. GLADSTONE, BART.,
Lord-Lieut. of the County.

President—
JAMES WOOD, Esq.,

Treasurer & Hon. Secretary—
DAVID GARR, Esq.

Annual Subscriptions.

	£.	s.	d.
Allan, James.	-	5	0
Baird, Alex. of Ury.	2	2	0
Davidson, late Mrs., interest on legacy.	-	16	11
Duff, R. W. Esq.	1	1	0
*Falconer, Robert.	-	5	0
Grieg, George A.	-	5	0
Innes, Major.	1	0	0
*Jack, James.	-	5	0
Kinnear, A. W.	-	10	0
Knowles, James.	-	5	0
*Martin, Thomas.	-	5	0
M'Inroy, Colonel.	2	0	0
Mowat, Wm.	-	5	0
Reddie, Captain J. G.	1	0	0
Ritchie, Wm.	1	0	0
Scott, James.	-	10	0
Smith, Thomas.	-	5	0
*Tindal, Robert.	-	10	0
Watt, Rev. John.	-	5	0
*Wood, Alexander.	-	5	0
Wyllie, George.	-	5	0
Sums under 5s.	5	9	0
Total	13	13	11

Donations.

Sir George Balfour, M.P.	2	0	0
Collection Box at Boat-house.	-	9	2
Total	£21	3	1

Kirkcudbright.

KIRKCUDBRIGHT BRANCH.

Patron—
THE EARL OF SELKIRK.

President—
Wm. MARTIN, Esq.

Treasurer and Hon. Sec.—
JAMES McMULLDROW, Esq.

Annual Subscriptions.

	£.	s.	d.
Selkirk, Right Hon. the Earl of.	3	3	0
Barbour, William, Esq.	1	1	0
Cowan, John, Esq.	1	0	0
*Gordon, A. J. Esq.	-	5	0
Hughan, Major Hor- ton.	1	1	0
Johnson, Mrs.	-	5	0
Kennedy, J. L. Esq.	1	0	0
*Kenworthy, James, Esq.	-	5	0
Kirkcudbright, Burgh of.	5	0	0
*Martin, Wm. Presi- dent.	-	5	0
Maxwell, Sir Wm., Bart.	2	0	0
Maxwell, W. H. Esq.	1	0	0
Mackie, J. G. Esq.	2	2	0
*McLellan, David, Esq.	-	5	0

McMuldrow, James, Esq.	-	5	0
Murray-Stewart, H. G. Esq.	1	1	0
Oswald, R. A. Esq.	1	0	0
Robinson - Douglas, W. D. Esq.	1	0	0
Skirving, Adam, Esq.	1	0	0
Wigram, Loftus J., Esq., Berkeley Square, London.	1	1	0
Sums under 5s.	1	2	0
Total	25	1	0

Donations.

Bean, Thomas.	-	5	0
Craig, Bailie.	-	5	0
Gordon, William, Esq., of Threave.	1	0	0
Box, SS. Tuskar, per Capt. Sinclair.	-	6	0
Total	£26	17	0

Wanarkshire.

GLASGOW BRANCH.

Treasurer—
JAMES A. SMALL, Esq.

Honorary Secretary—
R. HOPE ROBERTSON, Esq.

Annual Subscriptions.

	£.	s.	d.
Addie, Robert, and Sons.	2	2	0
Aitken and Waddell.	2	2	0
Aitkin, Libburn, and Co. Messrs.	1	1	0
Alexander Brothers.	1	1	0
Alexander, Fergus- son, & Co. Messrs.	1	1	0
Alexander, E. Len- nox & Co.	-	10	6
Alexander and John Messrs. R. F. & J.	1	1	0
Alston, J. Carfrae.	-	10	0
Amigo.	-	10	0
Andersons and Pat- tison.	-	10	6
Anderson, Messrs. D. and J.	2	2	0
Anderson and Co. Messrs. Geo.	1	1	0
Anderson and Co. Messrs. James.	-	10	0
Arnott & Co. Messrs.	1	1	0
Arthur & Co. (Limited) Messrs.	1	1	0
Arthur and Hinshaw, Messrs.	-	10	6
Auld & Guild, Messrs.	2	2	0
Austin and McAslan, Messrs.	1	1	0
Baird & Brown, Messrs.	1	1	0
Baird and Son, Messrs. Hugh.	-	10	6
Baird, Frank.	-	10	6
Balloch, Robt. & Co.	-	10	6
Bannatynes, Kirk- wood, and M'Janet.	2	2	0
Barclay & M'Gregor, Messrs.	1	0	0
Barclay, Curle, and Co. Messrs.	4	4	0
Barr, W. B.	1	1	0
Bell & Sons, Messrs. John.	1	1	0
Bell, Edmund.	-	10	0
Bennett, Browne, and Co. Messrs.	1	1	0

	£.	s.	d.		£.	s.	d.		£.	s.	d.		£.	s.	d.
Berry, Barclay & Co.	1	0	0	Denniston and Co.				Hatfield, Cameron,				MacLaren, Crum and			
Bisland Brothers	1	1	0	Messrs. Peter	1	1	0	and Co.	10	0	0	Co.	1	1	0
Binnie, Thomas	10	6		Denny and Co.	2	2	0	Hedderwick, James,				Maclay, Murray, and			
Black & Co. Messrs.				Denny, Wm. Brothers,				Esq.	10	6		Spens, Messrs.	2	2	0
James	1	1	0	Messrs.	2	2	0	Henderson and Co.				MacLellan, Messrs.			
Black & Co. Messrs.				Dick, R. and J.	2	2	0	Messrs. Patrick	2	2	0	P. and W.	2	2	0
John	2	2	0	Dick, W. B. and Co.	10	0		Henderson, Bros.	3	3	0	Macleod, Rev. D.,			
Blackie and Sons,				Dill, Wilson, & Muir-				Henderson, Miss.	10	6		D. D.	10	6	
Messrs.	1	1	0	head	10	6		Henderson and Co.				Macpherson, H. S. and			
Blanesfield Printing				Donald, Mr. Thos.	10	6		Messrs. D. and W.	2	2	0	Co.	1	1	0
Company	1	0	0	Donaldson Brothers,				Henry and Co.				M'Call and Son,			
Bost and Turner	1	1	0	Messrs.	1	1	0	Messrs. A. and S.	1	1	0	Messrs. James.	1	1	0
Boyd, W. and Co.	10	6		Douglas, R. & Son,				Hertz, Theodore	1	1	0	M'Clure, Naismith,			
Boyle, Miss E. C.	1	0	0	Messrs.	10	6		Hertz, Theodore (Add.)	1	1	0	Brodie & Co. Messrs.	1	1	0
Boyd, Thos. and Co.	10	6		Dow, Archd. Esq.	1	1	0	Hill, R. and J. M.				M'Gowan, David,			
Braby, Fred. & Co.				Dunlop, Thos. Esq.	15	0		Brown, and Co.	2	2	0	Esq.	1	1	0
(Limited)	10	6		Dunn & Son, Messrs.				Hinshelwood, J. and				M'Dowall, Steven,			
British and African				D.	1	1	0	Co. Messrs.	10	6		and Co. Messrs.	2	2	0
Steam Navigation				Dunn Brothers	10	6		Holmes, Kerr, and				M'Ewan, Stevenson,			
Co.	2	2	0	Dunn, Jas.	1	1	0	Hidderwick	10	6		and Leask, Messrs.	1	0	0
British India Steam				Dunn, Jas. and Sons	1	1	0	Hondsworth and Co.				M'Gregor, Alex. Esq.	1	1	0
Navigation Com-				Edington and Sons,				Messrs. J.	2	2	0	M'Grigor, Donald &			
pany (Limited)	2	2	0	Messrs. T.	2	2	0	Howat, Messrs. D. G.				Co.	2	2	0
Brown & Co. Messrs.				Edmiston and Mit-				Howat and Sons,				M'Laren Sons, & Co.			
J. and T.	1	1	0	chells Messrs.	1	1	0	Messrs. Jas.	10	6		Messrs. William,	1	1	0
Brown & Co. Messrs.				Edmiston, J. and R.	10	6		Hurler and Campsie				Alum Co.	1	1	0
W. and A.	1	1	0	Elder & Co. Messrs.	2	2	0	Alum Co.	1	1	0	Hutchison, Messrs.			
Brown and Polson	2	2	0	Ellis, Thomas	1	1	0	J. and P.	1	1	0	J. and P.	1	1	0
Brown, Downs, and				Ewing & Co. Messrs.				Hydepark Foundry				Company	10	6	
Co. Messrs.	1	1	0	A. Orr	2	2	0	Incorporation of				Skinner (per Mr.			
Brown, James, Esq.	2	2	0	Ewing & Co. Messrs.				Osborne)	1	1	0	Irving, Messrs. A.			
Brown, Junr., Davies				J.	2	2	0	and J.	2	2	0	Irvin and Co. Messrs.			
& Tait, Messrs.	10	6		Ewing & Co. Messrs.				Samuel	1	1	0	McCall and Stephen,	10	6	
Brown, Sons, & Co.				J. Orr	2	2	0	Jackson and Co.				and Blyth,			
Messrs. Wm.	2	2	0	Farquhar & Rox-				Messrs. John	10	6		Messrs.	1	1	0
Browne and Watson	1	1	0	burgh, Messrs.	10	6		Jameson, R. Esq.	1	1	0	McMillan, Arch. and			
Browne, Easton, &				Ferguson and Sons,				Jeffrey, R. and Sons	10	6		Son	2	2	0
Co. Messrs.	2	2	0	Messrs. James	10	6		Johnston, James, Mr.	1	1	0	McEwan, Robt. D.			
Brownlie and Co.	1	1	0	Ferguson and Bros.				Kelly & Co. Messrs.	1	1	0	Esq.	10	6	
Browns & Co.	1	1	0	Messrs. J.	2	2	0	Kerr, Anderson, Muir				and J.	10	6	
Bryce and Rumpf.	10	6		Ferguson and For-				and Main, Messrs.	2	2	0	Mann, Byars, and			
Bryce, J. D. Esq.	1	1	0	rester	10	6		Kerr, Newton, & Co.				Co. Messrs.	1	1	0
Buchanan, Watson,				Ferguson and Reid,				Messrs.	1	1	0	Martin, John, Esq.	10	6	
and Co. Messrs.	1	1	0	Messrs.	10	6		Kettle and Co. Messrs.				Martin, Turner, and			
Bulloch, Lade, & Co.				Finlay & Co. Messrs.				R.	1	1	0	Co. Messrs.	1	1	0
Messrs.	2	0	0	James	2	2	0	Keydens, Strang and				Mason, G. and R.	1	1	0
Burnley and Co.				Fisher and Watt,				Girvin, Messrs.	1	1	0	Middleton and Kirk-			
Messrs. W. F.	2	2	0	Messrs.	1	1	0	Kidston & Co. A. G.	1	1	0	patrick, Messrs.	10	6	
Burns, Messrs. G. and				Forbes, Peter	2	2	0	Kidston & Co. Messrs.				Miller & Son, Messrs.			
J.	2	0	0	Forsyth, Miller, and				A. G.	2	2	0	John	1	1	0
Burrell and Son,				Co.	1	1	0	Kidston and Sons,				Miller, James, Son,			
Messrs.	1	1	0	*Frame, Thos.	10	6		Messrs. Wm.	1	0	0	& Co. Messrs.	1	1	0
Caiton Spinning Co.	1	1	0	Fraser and Sons,				Laing and Co. Messrs.				Milligen, John, & Co.	10	6	
Campbell and Co.				Messrs. John	1	1	0	J.	1	1	0	Mirreles, Tait, and			
Messrs. J. and W.	3	3	0	Fraser, Gordon, & Co.	1	1	0	Laird, Alex. A. & Co.	1	1	0	Watson, Messrs.	2	2	0
Campbell, Jas. A.				Fraser, Kirkpatrick,				Lamont & Co. Messrs.				Mitchell, A., Jun.			
Esq., M.P., LL.D.	1	1	0	and Smith	2	2	0	Henry	1	1	0	and Sons	10	6	
Campbell, Rivers, and				Fyfe and Morton,				Langlands and Sons,				Mitchell, D.	1	1	0
Co. Messrs.	2	2	0	Messrs.	10	6		Messrs. M.	1	1	0	Watson,			
Cargill, David S.	10	6		Gairdner, James, & Co.	1	1	0	Law, David	1	1	0	and Wink, Messrs.	2	2	0
Caw, David	10	6		Gairdner, Chas. Esq.	1	1	0	Law, Thos. & Co.	10	6		Mitchells, Cowan, &			
Chaplin and Co.				Galbraith, Messrs. A.				Lecky, F. B. & Co.	1	1	0	Johnston, Messrs.	1	1	0
Messrs. Alexander	10	6		and A.	2	0	0	Leisler, Louis	2	2	0	Moncreiff, Barr, Pater-			
Chrystal, Robert, Esq.	1	1	0	Garroay, Messrs.				Leisler, Bock, and Co.				son, and Comp.			
Clark and Co.	2	2	0	R. and J.	1	0	0	Messrs.	2	2	0	Messrs.	2	2	0
Clark, Messrs. J. Jun.				Gibb, Elias, Esq.	10	6		Liepmann, Lehmann,				Moore and Browne,			
and Co.	2	2	0	Gilbert, Mrs. Crerar	2	0	0	and Co. Messrs.	1	1	0	Messrs.	10	6	
Clyde Shipping Co.	2	2	0	Gillfillan, J. and T.	10	6		Lietke & Co. Messrs.	1	1	0	Co. Messrs.	1	1	0
Clyde Yacht Club	2	2	0	Gourlay, Robt.	1	1	0	Little, James, & Co.	1	1	0	Mossend Iron Co.	1	1	0
Coatbridge Tin Plate				Gourlie and Son,				Lorimer & Moyes.	1	1	0	Munsie, Geo.	1	1	0
Comp. (Limited)	1	1	0	Messrs. William	1	1	0	Lumsden, Geo. Esq.	2	2	0	Murdoch and Co.			
Coats, Messrs. J. & P.	2	2	0	Govan, Wm.	1	0	0	MacArthur and Farie	10	0		Messrs. Robt.	1	1	0
Cochran, A. and R.	1	1	0	Gow & Co. Messrs.				McAulay and Co.				Napier and Co.	1	0	0
Cochrane, J. R.	1	0	0	Allan C.	1	1	0	Messrs. James	10	0		Napier and M'Intyre,			
Collins, Sons, and Co.,				Graham, John, Esq.	1	1	0	MacBean and Co.				Messrs.	3	3	0
Messrs. William	2	2	0	Graham & Co. Messrs.				Messrs. H.	10	6		Neilson & Co. Messrs.	2	2	0
Connal & Co. Messrs.	1	1	0	William	2	2	0	MacBrayne, D.	1	1	0	Neilson & Maxwell,	1	1	0
Connal & Co. Messrs.				Graham, Messrs. A.				Macdonald, Hood, &				Nimmo, Jas. & Co.	1	1	0
William	1	1	0	J. and A.	2	2	0	Co. Messrs.	1	1	0	Nisbet, Messrs. A. &			
Connell and Co.				Grant & Son Messrs.				MacKenzie & Aitken	1	1	0	J.	1	1	0
Messrs. Charles	1	1	0	G.	1	1	0	Mackenzie, Gardner,				Nitabill and Leama-			
Craigsheim and Her-				Gray, Dunn, and Co.				and Alexander,				bagow Coal Co.	2	2	0
man, Messrs.	1	1	0	Messrs.	1	1	0	Messrs.	1	1	0	Owners of Barque			
Crawford, Cree, and				Gray & Co. Messrs. J.	1	1	0	MacBrayne, D.	1	1	0	Minnie Browne, per			
Co. Messrs.	1	1	0	Gray, J. H.	10	6		Macdonald, Hood, &				Messrs. Brown &			
Cruikshank, R. and				Grischothi, Fleming,				MacKenzie & Aitken	1	1	0	Watson	5	0	0
Son	1	1	0	and Co.	10	6		Mackenzie, Gardner,							
Cruikshank, W. and				Gumprecht & Stewart	1	1	0	and Alexander,							
Co.	10	6		Harrington, J. P.	1	1	0	Messrs.	1	1	0				
Crum, Alex., M.P.	1	1	0	Hart, Arthur	10	6		Mackinnon and Co.							
Cunning, J. Esq.	2	2	0	Hart, John	1	1	0	Messrs. William	2	2	0				
Davidson, W. J. Esq.	2	2	0	Hay, Jas. and Sons	1	1	0	MacLae, A. Crum, Esq.	1	1	0				

BRANCHES—LIST OF ANNUAL SUBSCRIPTIONS AND DONATIONS. 613

	£.	s.	d.
Owners of barque <i>Jane Ure</i> , per Messrs. Browne & Watson.....	5	0	0
Owners of barque <i>Annie</i> , per Messrs. Browne & Watson.....	5	0	0
Do. <i>Bina Campbell</i> , per do.....	5	0	0
Do. <i>Dalhousie</i> , per do.....	5	0	0
Do. <i>Elisa Campbell</i> , per do.....	5	0	0
Do. <i>Janet McNicol</i> , per do.....	5	0	0
Do. <i>Maggie Browne</i> , per do.....	5	0	0
Do. <i>Martha Reid</i> , per do.....	5	0	0
Do. <i>Mary</i> , per do.....	5	0	0
Do. <i>Marg. Mitchell</i> , per do.....	5	0	0
<i>Ada Browne</i>	5	0	0
Pasley, Jardine, and Co. Messrs.....	1	1	0
Paterson and Son, Messrs. Wm.....	1	1	0
Paterson, Andrew, Esq.....	1	1	0
Pearson, Adam, and Co.....	2	2	0
Pirrie, Foote, and Co. Messrs.....	1	1	0
Pitkethly, Jas. Esq. 1 1 0	1	1	0
Phillips, John, & Co. Messrs.....	10	6	0
Raatte, Jacques van & Co.....	1	1	0
Raeburn and Veril.....	10	6	0
Ralston, Goodwin & Co. Messrs.....	1	1	0
Ramsay, John, Esq.....	10	6	0
Rankin and Sons, Messrs. W.....	10	6	0
Rankine and Son, Messrs. James.....	1	1	0
Ratray Brothers, & Smith, Messrs.....	10	6	0
Reid and Son, Messrs. Alex.....	1	1	0
Retchmann and Co. Successors.....	1	1	0
Rintoul, Son, and Co. Messrs. Peter.....	1	1	0
Ritchie and Co. Messrs. Jas.....	1	1	0
Robb, Moore, & Co. Messrs.....	10	6	0
Robertson, John, Esq. 1 1 0	1	1	0
Robertson & Baxter, Messrs.....	1	1	0
Robertson, Messrs. L. and R. H.....	1	1	0
Robertson, Hugh, & Co. Messrs.....	10	6	0
Rodger, James, Esq. 1 1 0	1	1	0
Rodger, Mrs.....	1	1	0
Rose, Murison, and Thomson, Messrs.....	1	1	0
Ross & Co. Messrs. W. Ross, Malcolm, and Co., Messrs.....	10	6	0
Rowley and Dick, Messrs.....	10	6	0
Russell, Miss J. G.....	1	1	0
Sandeman and Co. Messrs. D.....	10	6	0
Sandeman, David, & Son.....	1	1	0
Sandeman, J. G.....	1	1	0
Semple, McLean, & Reid, Messrs.....	1	1	0
Shaughnessy, J.....	5	0	0
Simpson, Hunter, & Young, Messrs.....	1	1	0
Simons, Jacobs and Co. Messrs.....	10	6	0
Skinner and Co. Messrs. Thomas.....	1	1	0
Skinner and Sons, Messrs. W.....	1	1	0
Sloan & Co. Messrs. William.....	2	2	0
Smith & Co. Messrs. A. and W.....	10	6	0
Smith and Sharp, Messrs.....	2	2	0
Smith and Sons, Messrs. George.....	2	2	0
Smith and Wellstood, Messrs.....	10	6	0
Smith, George, & Co. Messrs.....	1	1	0
Snodgrass, Messrs. J. and R.....	1	1	0
Steel, Coulson, and Co. Messrs.....	1	1	0
Stephen and Son, Messrs. Alexander.....	2	2	0
Stevenson, J. Esq.....	2	2	0
Stewart, Messrs. Andrew and James.....	1	1	0
Stewart and Co. Messrs. John.....	1	1	0
Stewart & McDonald, Messrs.....	3	3	0
Stewart, R.....	1	1	0
Stewart, D. Y. & Co. 2 2 0	2	2	0
Stonelaw Colliery.....	10	6	0
Stirling, Wm. & Sons 2 2 0	2	2	0
Strang & Kirkwood. 1 1 0	1	1	0
Summerlee Iron Co. 2 2 0	2	2	0
Tasler, John.....	10	6	0
Tatlock, Robert R.....	10	6	0
Taylor, Laughland, and Co. Messrs.....	1	1	0
Teacher and Sons, Messrs. William.....	2	2	0
Templeton and Co. Messrs. James.....	2	2	0
Tennant and Co. Messrs. Charles.....	3	3	0
Thomson, Aikman, and Co.....	10	6	0
Thomson and Gray.....	10	6	0
Thomson, Henry.....	10	6	0
Thomson, Jas. & Geo. 1 1 0	1	1	0
Thomson, John and James.....	1	1	0
Thomson, Neale.....	1	1	0
Thomson, Sir Wm.....	1	1	0
Thomson, Dickie, & Co. for Barques <i>Blairhoyle</i> , 21s. <i>Florence</i> , 21s. <i>Tamerlane</i> , 21s.....	3	3	0
Tillie & Henderson. 1 1 0	1	1	0
Train & Co. Messrs. Thomas.....	10	6	0
Turnbull, Martin, & Co.....	1	1	0
Ure, John, Lord Provost.....	2	2	0
Walker & Co. Messrs. John.....	10	6	0
Walker & Hamilton, Messrs.....	10	6	0
Watson, Gow, and Co. Messrs.....	1	1	0
Watson and Smith, Messrs. James.....	2	2	0
Watson and Co. Messrs. James.....	1	1	0
Watson Bros.....	1	1	0
Wharrie, Colledge & Brand, Messrs.....	10	6	0
White, Messrs. James and John.....	3	3	0
Wilkie, Wm. Esq.....	1	1	0
Williamson, T.....	1	1	0
Wilson and Son, Messrs. Jas.....	1	1	0
Wilson, Mathison, & Co. Messrs.....	10	6	0
Woodrow, Alexander, & Sons, Messrs.....	10	6	0
Wurdie and Co.....	1	1	0
Wotherspoon and Co. Messrs. R.....	1	1	0
Wright, J. Brooks, Esq. 1 1 0	1	1	0
Wright, Johnstone, and Mackenzie, Messrs.....	2	2	0
Total.....	420	3	0

	£.	s.	d.
<i>Donations.</i>			
Association of Underwriters.....	6	9	3
Collected by Berkeley St. W. P. Mission Sab. School, Paterson Street.....	12	0	0
Gourlay, Mrs.....	5	0	0
Monteith, Mrs. Helen.....	100	0	0
Passengers and Crew of SS. <i>Granadilly</i> , per Capt. Wilson.....	1	0	0
Townhall Sab. Sch.....	1	10	0
Total Dons.....	114	11	3
Total Subs.....	420	3	0
£534 14 3			

Orkney Islands.
LONGHOPE BRANCH.

Chairman—
J. G. MOODIE HEDDLE, Esq.
Honorary Secretary—
EDWARD E. CORRIGALL, Esq.

Annual Subscriptions.

	£.	s.	d.
Corrigall, Edward E. Esq.....	5	0	0
Heddle, J. G. Moodie 2 2 0	2	2	0
Sums under 5s.....	3	5	6
Total.....	£5 12 6		

STROMNESS BRANCH.

Honorary Secretary—
Capt. G. BILSON.

Annual Subscriptions.

	£.	s.	d.
Zetland, Lord.....	5	0	0
*Copland, J. S. Esq.....	5	0	0
Hon. Secretary.....	5	0	0
*Miller, Capt.....	5	0	0
Shearer, Coxswain.....	5	0	0
*Spence, James.....	10	0	0
Sums under 5s.....	2	6	0
Total.....	£3 16 0		

Linlithgowshire.

KIRKLISTON BRANCH.

President—
Rev. J. C. BURNS.
Honorary Secretary—
MR. JOHN GARDINER.

Annual Subscriptions.

	£.	s.	d.
Blair, Miss.....	7	6	0
Burns, Rev. J. C.....	10	0	0
Burns, Mrs.....	10	0	0
Duncan, Miss.....	1	0	0
Hog, T. A. Esq.....	10	0	0
McQueen, — Esq.....	10	0	0
Ogilvie, Miss.....	5	0	0
Stewart and Co., Messrs.....	10	0	0
Stewart, R. Esq.....	10	0	0
Sums under 5s.....	10	0	0
Total.....	£5 2 6		

Peeblesshire.

PEEBLES BRANCH.

President—
T. H. ORPHOOT, Esq.,
Sheriff-Substitute.
Honorary Secretary—
DR. CONNELL.

Annual Subscriptions.

	£.	s.	d.
Alexander, Miss.....	5	0	0
Ballantine, Rev. W.....	5	0	0
Black, Capt., Kailzie 1 1 0	1	1	0
Blackwood, Mr.....	5	0	0
*Buchan, Mr. W.....	5	0	0
Buchan, Miss.....	5	0	0
*Burgess, Rev. R.....	5	0	0
*Currie, Rev. D.....	5	0	0
Hunter, Mrs.....	5	0	0
Jeffrey, Mr.....	5	0	0
Lindsay, Miss.....	5	0	0
Linton, Mr.....	5	0	0
Lorraine, Rev. J. B.....	5	0	0
Macgregor, D.....	10	6	0
Mackenzie, Mr.....	1	1	0
McLrose, Mr.....	5	0	0
*Orphoot, Mr.....	10	6	0
Panton, Mr.....	10	6	0
Reuton, Miss.....	5	0	0
Riddell, Mr.....	5	0	0
Scott, Mr., Milkiston 6 0	6	0	0
*Secretary.....	10	6	0
*Stirling, Mr.....	5	0	0
Tennant, Mr.....	2	2	0
Thorburn, Mr. M.....	10	6	0
Thorburn, Mr. R.....	10	6	0
Thorburn, Walter.....	10	6	0
Thorburn, William.....	10	6	0

Nairnshire.

MORAY FIRTH BRANCH.

Chairman—
Provost LESLIE, Nairn.
Treasurer & Hon. Secretary—
H. T. DONALDSON, Esq.,
Solicitor, Nairn.

Annual Subscriptions.

	£.	s.	d.
*Dunbar, Sir James Alexander.....	10	0	0
*Mackintosh, Hugh, Esq.....	10	6	0
Forres, Town of.....	2	2	0
Nairn, Town of.....	3	3	0
Donations.			
Town of Inverness.....	5	0	0
Sundry Donations.....	5	1	0
Total.....	£16 6 6		

	£.	s.	d.
*Tod, Mr., St. Mary's Mount.....	2	2	0
Todd, Provost.....	5	0	0
Wallace, Mr.....	1	1	0
Williamson, Mr. R.....	5	0	0
*Wyer, Rev. T.....	10	6	0
Sums under 5s.....	3	17	0
Total.....	£20	14	6

Renfrewshire.

GREENOCK BRANCH.

Chairman—
JAMES STEWART, Esq., M.P.
Honorary Secretary—
E. MAXWELL, Esq., H.M.'s Customs.

Annual Subscriptions.

	£.	s.	d.
Baine & Johnstone, Messrs.....	2	2	0
Blackwood & Gordon, Messrs., Port Glasgow.....	1	1	0
*Brymner, G. Esq.....	10	6	0
Caird, C. S. Esq.....	1	0	0
*Caird, J. T. Esq.....	2	2	0
Carmichael and Co. Messrs, J. H. & A. Carmichael, T. Esq.....	1	1	0
Cartsburn Sugar Refining Co.....	1	0	0
Clapperton, J. Esq.....	10	6	0
Crawford, Messrs, W. and J.....	1	1	0
Cuthbert, Robert, Esq.....	1	1	0
Davie, Robert, Esq.....	10	0	0
*Duncan and Co. Messrs., Port Glasgow.....	1	1	0
Greive, W. Esq.....	2	0	0
Greenock, St. John, per R. Urie, Esq.....	2	2	0
Hamilton and Co. Messrs. Port Glasgow.....	1	1	0
Hogg, Wallace, & Co. Messrs.....	1	1	0
Kerr & Co. Messrs. John.....	2	2	0
Lamont, Jas. Esq.....	1	0	0
Lindsay and Co. Messrs. W.....	1	1	0
Low, Messrs. L. & Co.....	5	0	0
Lyle, Abram, Esq.....	2	2	0
Lyle, John, Esq.....	10	0	0
Macgregor and Son, Messrs. John.....	1	0	0
McArthur, Wm. Esq.....	1	0	0
McIver, W. and Co. Messrs.....	10	6	0
Morton, James, Esq.....	1	1	0
Neill, Dempster and Neill, Messrs.....	2	0	0
Neill, R. & S. Messrs.....	10	6	0
Orr, Hunter and Co. Messrs.....	1	1	0
Reid & Co. Messrs. J. Port Glasgow.....	1	1	0
Richardson and Co. Messrs. James.....	2	2	0
Robertson and McDougall, Messrs.....	10	6	0
Russell and Co. Messrs. Port Glasgow.....	1	1	0
Scott, Alexander, and Sons, Messrs.....	2	2	0

	£.	s.	d.
Shankland, Messrs. D. and R.....	2	2	0
Spiers, Lady.....	2	2	0
Steele and MacGaskill, Messrs.....	10	6	0
Steele & Co. Messrs. Robert.....	2	2	0
*Stewart, Messrs. J. and W.....	2	2	0
*Swinburne, Capt. R.N.2 Thorne and Sons, Messrs. R.....	1	1	0
Walker and Co. Messrs. John.....	1	1	0
Total.....	54	7	0

Donations.

Gamble, Mrs.....	10	0	0
Munn, Miss.....	25	0	0
St. John's Lodge, per R. Urie, Esq.....	1	0	0
Pillar Boxes—Princess Pier Box.....	1	9	4
Customs Quay.....	3	2	0
Total Donos.....	37	12	6
Total Subs.....	54	7	0
Total.....	£91	19	6

Roxburghshire.

KELSO BRANCH.

President—
Rev. D. HUNTER, B.D.
Honorary Secretary—
ALEXANDER MUIRHEAD, Esq.

Annual Subscriptions.

	£.	s.	d.
Aitchison, Mrs. W. W.....	5	6	0
Beveridge, J. Esq.....	10	0	0
Brown, J. J. E. Esq.....	1	0	0
Cunningham, Mrs.....	5	0	0
Darling, J. F. Stirmonth, Esq.....	5	0	0
Douglas, Dr. F.....	10	0	0
Douglas, Dr. C.....	10	0	0
Douglas, Misses.....	10	0	0
Dunn and Sons, A.....	5	0	0
Hogg, John, Esq.....	5	0	0
Hunter, Rev. David, B.D.....	5	0	0
Johnston, Edward, Esq.....	10	0	0
Johnston, Messrs. J. and J.....	5	0	0
Johnston, Misses.....	5	0	0
Logan, P. Esq.....	5	0	0
Lugton and Porteous, Main, A. Woodman, Esq.....	5	0	0
Makdougall, Miss Scott.....	2	0	0
Milne Brothers.....	5	0	0
Purves & Muirhead.....	5	0	0
Purves, Mrs.....	10	0	0
Robertson, Mrs.....	5	0	0
Robertson, Mrs. Shaw.....	5	0	0
Robertson, Miss.....	5	0	0
Robson, Wm. Esq.....	5	0	0
Robertson, P. Esq.....	5	0	0
Scott, Rev. Hill.....	1	1	0
Smith, James, Esq.....	5	0	0
Stewart, Miss.....	1	0	0
Stuart and Mein.....	5	0	0
Tait, James, Esq.....	10	0	0
Turnbull, G. H., M.D.....	5	0	0
Sums under 5s.....	8	6	0
Total.....	£22	2	6

MELROSE BRANCH.

President—
Admiral the Hon. T. BAILLIE.
Honorary Secretary—
JOHN BROAD, Esq.
Annual Subscriptions.

	£.	s.	d.
Amos, Miss.....	5	0	0
*Baillie, Admiral the Hon. T.....	1	0	0
Baillie, Lady Grisell.....	10	0	0
*Baillie, Major the Hon. R.....	10	0	0
Baillie, Miss.....	5	0	0
Baillie, Miss M. T.....	5	0	0
*Broad, John, Esq.....	10	0	0
*Curle, Alex. Esq.....	1	0	0
Curle, James, Esq.....	1	0	0
Curle, Mrs.....	5	0	0
Dunn, Ralph, Esq.....	5	0	0
Elliot, Miss.....	5	0	0
Erskine, Mrs., Chiefswood.....	10	0	0
Erskine, Charles Esq., Friar's Hall.....	5	0	0
Freer, John, Esq.....	10	0	0
Grierson, Dr.....	10	0	0
Polwarth, Lord and Lady.....	2	0	0
Robertson, A. Esq.....	10	0	0
Scott, the Misses.....	5	0	0
Small, A. M. Esq.....	5	0	0
Smith, Mrs., Darnlee.....	5	0	0
Smith, Miss E. M.....	5	0	0
Tod, the Misses.....	1	0	0
Sums under 5s.....	3	16	0
Total.....	£16	1	0

Stirlingshire.

BANNOCKBURN BRANCH.

Treasurer—
Ed. L. WILSON, Esq.
Annual Subscriptions.

	£.	s.	d.
Coll. by Miss Currie—Wilson, Mrs. Col.....	10	0	0
Wilson, Rev. John.....	5	0	0
Wilson's, Jas., Academy, pupils.....	6	11	0
Sums under 5s.....	2	1	6
Total.....	3	3	5
Coll. by Miss Euchar—Wilson, Mrs. W.....	1	1	0
Sums under 5s.....	1	1	0
Total.....	2	2	0
Collected by Miss Learmonth—Wilson, Mrs. Ed. L.....	10	6	0
Wilson, Mrs. J.....	5	0	0
Ronald, Mr.....	5	0	0
Sums under 5s.....	11	0	0
Total.....	11	6	0
Coll. by Miss Mercer—Sums under 5s.....	1	16	9
Galbraith, Mrs. W. R., London.....	1	1	0
Wilson, Alex. Esq.....	1	1	0
Wilson, Ed. L.....	1	1	0
Total.....	£11	16	8

STIRLING BRANCH.

Chairman—
HENRY DRUMMOND, Esq.
Hon. Treasurer—
DANIEL FERGUSON, Esq.
Honorary Secretary—
JOHN JENKINS, Esq.
Annual Subscriptions.

	£.	s.	d.
Drummond, Miss, collected by—			
Aitken, J. G. Esq.....	10	6	0
Carson, Mrs.....	5	0	0
Cordis, Miss.....	5	0	0
Chalmers, Rev. J.....	5	0	0
Howat, Mrs.....	5	0	0
Kemp & Nicholson, Messrs.....	10	6	0
Oliphant, Mrs.....	5	0	0
Millar, Mrs.....	5	0	0
Robertson, Miss.....	5	0	0
Speirs, Miss.....	10	0	0
Whyte, Robt. Esq.....	5	0	0
Sums under 5s.....	2	9	0
Gentleman and Ferguson, Misses, collected by—			
*Ferguson, Daniel, Esq.....	5	0	0
Gentleman, Eben, Esq.....	5	0	0
Mitchell, Mr. Thos.....	5	0	0
Morton, Mr. Robt.....	5	0	0
Lumsden, Mrs.....	5	0	0
Robertson Bros, Messrs.....	10	0	0
Wilson, Mrs.....	5	0	0
Sums under 5s.....	5	13	3

Johuston, Miss Jane, collected by—			
Anderson, Mr.....	5	0	0
Anderson, Mrs.....	5	0	0
Burden, Mrs. P.....	5	0	0
Colquhoun, Miss.....	5	0	0
Drysdale, Mr. Wm.....	5	0	0
Frew, Rev. Dr.....	10	0	0
Gray, Mr. Jas.....	5	0	0
Kirkwood, Dr. Anderson.....	10	0	0
*Lauder, Mungo, Esq.....	1	0	0
Monteith, Mrs.....	5	0	0
Munnock, Mrs.....	5	0	0
McEwen, Mrs.....	5	0	0
McKenzie, Rev. C.....	5	0	0
Paterson, Robt. Esq.....	5	0	0
Paton, Mrs., of Viewforth.....	1	0	0
Reid, Mrs. Wm., of Randolphfield.....	5	0	0
Smith, Mrs., of Brentham Park.....	1	0	0
Steel, Mrs.....	5	0	0
Todd, T. H. Esq.....	5	0	0
Walker, Mrs.....	1	0	0
Wright, Misses, of Clifford Park.....	2	0	0
Sums under 5s.....	1	17	0
Anderson, Miss, collected by—			
Baird, Miss.....	5	0	0
Annan, Mrs.....	5	0	0
Bell, Mrs.....	5	0	0
Bell, Mrs.....	5	0	0
Christie, Mrs.....	5	0	0
Craigie, Miss.....	5	0	0
Cunliff, Mrs.....	1	0	0
Cuthbertson, Dr.....	5	0	0
Cuthbertson, Mrs.....	5	0	0
Forrester, Misses.....	5	0	0
Galbraith, Misses.....	5	0	0
*Galbraith, Dr.....	5	0	0
Makgill, Miss.....	5	0	0
McAlpine, Mrs.....	5	0	0
McInnes, R. Esq.....	5	0	0
McMath, Jno. Esq.....	5	0	0
Monteath, Mrs. A.....	5	0	0
Morison, Miss.....	5	0	0
Rae, Mrs.....	5	0	0

BRANCHES—LIST OF ANNUAL SUBSCRIPTIONS AND DONATIONS. 615

£.	s.	d.	£.	s.	d.
Reid, Mrs. James.	1	0	0		
Richardson, J. B., Esq.	1	1	0		
Smith, Mrs. J. T.	5	0	0		
Stevenson, Mrs. J. S.	5	0	0		
Sums under 5s.	3	13	0		
Treasurer, Hon. Collected by—					
Ritson, Wm. Esq.	1	0	0		
Goldie, Miss, Collected by—					
*Anderson, Provost	5	0	0		
Adam, Mr. R.	5	0	0		
Carson, Mr. D. R.	10	0	0		
Cowbrough and Mercer, Messrs.	5	0	0		
Dowdy, Mr. Wm.	5	0	0		
*Drummond, Henry, Esq.	1	10	6		
Duncanson, Mr. Wm.	5	0	0		
Graham, Wm. Esq.	5	0	0		
*Jenkins, Messrs. A. & J.	7	6	0		
Menzies, Mr. T.	5	0	0		
Millar, Jas. & Sons, Messrs.	7	6	0		
M'Ewen, John, Esq.	5	0	0		
Macfarlane, Mr. John	5	0	0		
Morton, Mr.	5	0	0		
Muir, Mr. A. L.	5	0	0		
McLuekie, Robt. Esq.	5	0	0		
Philp, J. L. Esq.	5	0	0		
Simpson, Mr. Wm.	5	0	0		
*Shearer, Dean of Guild	5	0	0		
Smith, Mr. J.	5	0	0		
Taylor, Robt., Esq.	5	0	0		
Walls, Mr. R.	10	0	0		
Thomson, Mr. Jas.	5	0	0		
Ormond, Rev. D. D.	5	0	0		
Sums under 5s.	9	9	0		
Total	£56	4	9		

Highlandshire.

ISLE OF WHITHORN AND BAY OF WIGTOWN BRANCH.

£.	s.	d.
*Galloway, Right Hon. the Earl of	5	0
Bute, The Most Noble the Marquis of	1	0
Stair, Right Hon. the Earl of, K. T.	1	1
Borthwick, Right Hon. Lord, Ravenstone	2	2
Black, E. S. Esq.	10	0
Blair, E. Stopford, Esq.	2	2
Broadhurst, Henry Tootal, Esq.	2	0

PORT LOGAN AND BAY OF LUCE BRANCH.

£.	s.	d.
Baird, John, Esq.	10	0
*Cavan, Rev. Jas.	10	0
Cochrane, Quintin	10	0
Cowan, George, Esq.	10	0
Dodd, G. Ashley, Esq.	10	0
*Frederick, David, Esq.	10	0
*McDonald, Jas. Esq.	5	0
*McMaster, Jas. Esq.	10	0
M'Taggart, Mrs. O.	1	1
Mitchell, Alex. Esq.	1	0
Moore, J. Carrick, Esq.	2	2
Stair, The Earl of, K. T.	5	0
*Stewart, Mark J. Esq.	1	0
Taylor, Alex. Esq.	10	0
Young, Robert, Esq.	10	0
Sums under 5s.	2	15
Total	£22	19

PORTPATRICK BRANCH.

£.	s.	d.
Hunter Blair, David, Esq.	10	0
*McCaig, Alexander	1	0
*McClew, John	2	2
*McCracken, J. Esq.	1	0
Hunter Blair, David, Esq.	10	0
*McCraig, Alexander	1	0
*McClew, John	2	2
*McCraekren, J. Esq.	1	0
From Subscription Boxes on Boathouse door, &c.	2	1
Total	£16	3

IRELAND. Co. Antrim. BELFAST AND GROOMSPORT BRANCH.

£.	s.	d.
Adair, Mr. Hugh	5	0
Alexander, Messrs. J. & Co.	10	0
Archer, Messrs. and Sons	5	0
Arnott & Co. Messrs.	10	0
Barkie, Mr. W. M.	5	0
Belfast Harbour Commissioners	10	0
Belfast Steamship Co.	2	2
Bell, Messrs. R. & Co.	10	0
Blackstaff Spinning Company	10	0
Boag, Robert, Esq.	5	0
Bristow, E. J. Esq.	10	0
Brown and Sons, Messrs. John S.	1	0
Campbell and Co. Messrs. H.	10	0
Carlisle, Jas. Esq.	10	0
Cartér, Wm. Esq.	1	0
Clarke and M'Mullan, Messrs.	5	0
Clarke, Geo. Esq.	10	0
Coates, John, Esq.	10	0
Coates, A. Hill, Esq.	1	0
Coates, Victor & Co., Messrs.	1	0
*Coe, Sir Edward	1	0
Combe, Barbour, & Combe, Messrs.	10	0

£.	s.	d.
*Corry & Co. Messrs. J. P.	1	0
Cramer, Wood & Co. Messrs.	10	0
Crawford, J. Sharman, Esq.	1	0
Crawford and Lockhart, Messrs.	1	0
Currell & Co. Messrs. Daniel, Jun.	1	0
Dixon, Daniel, Esq.	5	0
Donegall, The Marquis of	2	2
Duffin, The Earl of	1	0
Duffin, Adam, Esq.	5	0
Dunville and Co. Messrs. (Limited)	10	0
Edgar and Lowry, Messrs.	5	0
Emerson, Wm. Esq.	5	0
Ewart and Son, Messrs. W.	1	0
Ewing, Son, and Co. Messrs.	5	0
Finlay Brothers and Co. Messrs.	10	0
Gordon & Co. Messrs.	5	0
Green, Forster, Esq.	1	10
Grimshaw Brothers, Messrs.	5	0
*Hamilton, Megaw, & Thomson, Messrs.	1	0
Hanson, J. Esq.	10	0
Harland and Wolff, Messrs.	2	0
Hart and Churchill, Messrs.	10	0
Hartley, A. H. Esq.	5	0
Henderson, J. A. Esq.	10	0
Henderson and Son, Messrs. R.	10	0
Henry, Messrs. A. & S.	5	0
Higginson, J. M. Esq.	5	0
Hind and Sons, Messrs. John	1	0
Houston, John B. Esq.	1	0
Hughes, Edward, Esq.	5	0
Jaffé Brothers, Messrs.	1	0
Johnston, and Thompson, Messrs. W. J.	5	0
Kyle, Mrs.	5	0
Lernon, A. D. Esq.	10	0
Lindsay Bros. Messrs. (Limited)	10	0
Lipman & Co. Messrs.	5	0
Little & Co., Messrs. Jas.	10	0
Lytle and Sons, Messrs. John	5	0
Mateer & Co. Messrs. H.	10	0
Maxwell, R. P. Esq.	1	0
Maxwell, Mrs. P.	1	0
McCasland, Saml. Esq.	10	0
*McClure, Sir Thomas, Bart. M. P.	5	0
McGee, John G. Esq.	5	0
McNeill, H. H. Esq.	5	0
McNeill, Wm. Esq.	1	0
McNeill, Malcm. Esq.	10	0
Millar, Boyd & Reid, Messrs.	10	0
Moore, Bns. Messrs.	5	0
Moore and Winberg, Messrs.	10	0
Moore, James, Esq.	10	0
Murphy & Orr, Messrs.	5	0
Northern Spinning & Weaving Co.	5	0
Orr, Robert H. Esq.	1	0
D. C. P.	10	0
Patterson, Rich. Esq.	10	0
Patterson, R. L. Esq.	10	0
Pim, Messrs. E. & W.	5	0
Pim, Messrs. J. & Son	10	0
Purdon, H. S. Esq., M. D.	5	0
Richardson Brothers, Messrs.	1	0

	£.	s.	d.
Richardson, Sons, and			
Owden, Messrs.	1	0	0
Riddell, Saml. Esq.	1	0	0
Ritchie, W. B. Esq.	10	0	0
Robertson, Ledlie,			
Ferguson & Co.	1	0	0
Robinson, W. A. Esq.	5	0	0
Royal Ulster Yacht			
Club	2	0	0
Seeds, Messrs. H. & W.	5	0	0
Shaw, Alex. F.	5	0	0
Smith, Messrs. J.			
and T.	10	0	0
Stelfox, James, Esq.	5	0	0
Stewart, Chas. Esq.	5	0	0
Tate, Alex. Esq.	10	0	0
Torrens, Jas. Esq.	1	0	0
Trimble, Mr. Saml.	5	0	0
W. C. F. D., Esq.	10	0	0
Wallace, Sir Richard,			
Bart., M.P.	5	0	0
Ward, Marcus, & Co.			
Messrs.	10	0	0
Ward, Robert E. Esq.	1	0	0
Workman, Messrs.			
J. and R.	10	0	0
Workman, Mrs. R.			
Sen.	1	0	0
Workman, Mrs. Robt.	1	0	0
Workman, Wm. Esq.	1	0	0
Workman, T. Esq.	1	0	0
Workman, F. Esq.	5	0	0
Workman, Rev. Bbt.			
Jun.	1	0	0
Young & Mackenzie,			
Messrs.	10	0	0
Sums under 5s.	7	6	
Total	87	7	6

Donations.

Pillar Box at Northern	
Counties Railway	
Station	2 6 2
Small Box	3 0 0
Total	£89 16 8

PORTRUSH BRANCH.

President—
Major-General
J. BRADFORD SMYLY.

Vice-President—
Rev. H. FROLOTT, M.A.

Treasurer—
THOMAS BELLAS, Esq.

Honorary Secretaries—
Rev. JONATHAN SIMPSON.
W. E. CARVER, Esq., J.P.

Assistant Secretary—
Mr. SAMUEL PATTON.

Annual Subscriptions.

Adams, J. Esq. J.P.	10	0
Anderson, James S.	5	0
Antrim, L. Countess of	3	0
Armstrong, Rev. W.	5	0
*Bellas, H. and T.	1	0
Bevington, J. B. Esq.	10	6
Bevington, S. B. Esq.	10	6
Cameron, W. J. Esq.	5	0
Carr, John, Esq.	10	0
*Carson, A. T. Esq. M.D.	5	0
*Carver, W. E. Esq. J.P.		
(two years)	1	0
Chaine, Major	1	0
Cox, Mrs. S. L.	1	0
*Crookshank, R. Esq.	10	0
Denham, Mrs. Dr.	5	0
*Fall, Daniel	10	0
Finlayson, Rev. Jno.	5	0
*Ffolliott, Rev. H. M.A.	10	0
Gordon, Joseph	5	0
Grant, P. Drummond	5	0
Greer, T. M. Esq.	5	0
Hannay, Lt.-Col. J.P.	10	6
Huey, John	10	0

	£.	s.	d.
Hunter, Stewart	10	0	
*Knox, Capt. W. B.			
J.P. (two years)	2	0	0
Leach, H. W. Esq.	5	0	0
Lestie, Col. E. D., J.P.	1	0	0
Lusk, John, Esq.	5	0	0
McCleery, J. O.	10	0	0
McElderry, T.	5	0	0
Montgomery, Capt.			
R. J., J.P.	1	0	0
Moore, J. S. Esq. J.P.	1	0	0
Moore, Miss.	5	0	0
Murray, Major, J.P.	1	0	0
O'Neill, Hon. E., D.L.			
(two years)	1	0	0
Orr, Rev. R. Holmes	10	6	
Patrick, J. Esq. J.P.	10	6	
Portrush Harbour			
Commissioners	2	2	0
*Smyley, Major-Gen.			
John Beresford	1	0	0
*Simpson, Rev. J.	1	0	0
Stannus, Miss.	10	0	0
Taylor, D. Esq. J.P.	10	0	0
Taylor, Robert	1	0	0
Templeton, General,			
Rt. Hon. Id. Visc.	1	0	0
Thompson, J.	5	0	0
Troughton, James	5	0	0
Turnly, J. Esq. J.P.	10	0	0
Watt, Capt.	1	0	0
Waveney, Lord, Rt.			
Hon.	1	0	0
Wilson, Chas. Esq.	1	0	0
Young, Mrs. Jas.	10	0	0
Young, Miss	10	0	0
Young, J. Esq. J.P.,			
D.L.	10	0	0
Young, Wm. A. Esq.	10	0	0
Total	36	19	0

Donations.

Antrim Arms Hotel	
Box	7 7
Coleman's Hotel Box	2 7
Hutcheson, Miss	
Amelia	10 0
Life-boat House Box	18 6
The following, per Miss	
Stannus	
Fitzgerald, Hon.	
Miss G. V.	5 0
Gidlow, Mrs.	5 0
Wayne, Miss	10 0
Wayne, Miss A.	10 0
Total Dons.	3 6 8
Total Subs.	36 19 0
Total	£40 5 8

Co. Caban.

CAVAN BRANCH.

President—
The LORD FARNHAM.

Chairman—
Major E. J. SAUNDERSON.

Treasurer—
JOHN BOYD, Esq.

Secretary and Collector—
Mr. T. J. SMYTH.

Annual Subscriptions.

Farnham, the Lord	
(Don.)	2 0 0
Saunderson, Capt. L.	
T.B. (Annual Sub.)	2 0 0
Saunderson, Llewellyn,	
Esq.	1 0 0
Stone, Rev. W. H.	
(Don.)	10 0
Total	£5 10 0

Co. Cork.

BALLYCOTTON BRANCH.

Patron—
The Right Rev. the LORD
BISHOP OF CORK, CLOYNE,
AND ROSS.

President—
E. F. LITTON, Esq., Q.C.

Honorary Secretary—
T. W. STRANGMAN, Esq.

Annual Subscriptions.

	£.	s.	d.
Beale, Alfred, Esq.	5	0	0
Beale, Henry H. Esq.	5	0	0
Bristol General Steam			
Navigation Co.	1	0	0
Clyde Shipping Comp.	3	3	0
Cork Harbour Com.	5	0	0
Cork, Lord Bishop of	1	0	0
City of Cork Steam			
Packet Company	5	0	0
Cunard Company per			
Messrs. MacIver.	2	2	0
Evans, Archdeacon	10	0	0
*Gaggin, Geo. Esq.	5	0	0
Hatchett, Mrs. J.			
Goldsmith	1	1	0
Henderson Brothers,			
Messrs. "Anchor			
Line of Steam			
Ships	2	2	0
Inman Company, per			
Messrs. Seymour	2	2	0
*Litchfield, W. Esq.	5	0	0
Litton, E. F. Esq. Q.C.	1	1	0
Longfield, Montifort,			
J. C. Esq.	2	0	0
Strangman, T. W. Esq.	10	0	0
Total	27	11	0

Donations.

Collection Boxes on	
board Steamers of	
City of Cork S.S.	
Co., per W. de	
Foubert, Esq.	2 19 3
Total	£30 10 3

CORK AND QUEENS-TOWN BRANCH.

President—
Rear-Admiral RICHARD
VESEY HAMILTON, C.B.,
Commanding the Irish
Station, Queenstown.

Treasurer—
HENRY HARDY, Esq., Knock-
even, Queenstown.

Honorary Secretary—
Capt. N. SUTTON, Queenstown.

Annual Subscriptions.

Barry, A. H. Smith,	
D.L.	2 2 0
Barry, R. H. Smith,	
D.L.	2 2 0
Beamish and Craw-	
ford	2 2 0
Beamish, Capt. J. C.	1 1 0
Bogan, J.	5 0 0
Bristol Steam Navi-	
gation Co.	2 2 0
Buckle, Capt., R.N.	1 0 0
Byrne, Capt.	1 1 0
City of Cork Steam	
Packet Co.	5 5 0
Clyde Shipping Com.	2 2 0
Cork Harbour Com-	
missioners	10 0 0

	£.	s.	d.
Calligan, P.	5	0	0
Currey, P.	1	0	0
Daly, M. C.	5	0	0
Delany, J.	1	1	0
Dolan, R. J. Collector			
of Customs	1	1	0
Fitzgerald, R. U. F.	1	0	0
Guion Company	1	1	0
Hamilton, Rear-Adm.	1	0	0
Hardy, Henry	1	0	0
Harvey and Sons,			
G. N.	1	1	0
Hynes, J. T.	10	0	0
Inman, W.	2	2	0
Ismyr, Imrie, & Co.	5	0	0
Lyons, T. S.	5	0	0
Mahony, J.	5	0	0
M'Carthy, J.	5	0	0
M'Ever, C. and D.	2	2	0
Murphy, James J.			
& Co.	5	0	0
Newson, J. C.	1	0	0
National Steam Ship			
Co.	1	1	0
O'Hea, Cussen & Co.	10	0	0
Queenstown Towing			
Company	1	1	0
Rushbrook, Miss	5	0	0
Savage French	10	0	0
Scott, James, & Co.	1	1	0
Sharpe, Capt., R.N.			
H.M.S. <i>Revenge</i>	1	0	0
Wintz, Lieut., R.N.			
Flag Lieutenant.	1	0	0
Wise, James, Ros-			
tellan	2	0	0
Woodford & Bourne	1	1	0
Total	68	9	0

Donations.

Hodder, Capt. R., R.N.	5 0 0
Mazzini Brothers	15 0 0
Small Sums under 5s.	
collected by R. J.	
Dolan, Esq.	1 10 0
In Life-boat Box at	
Messrs. Helberg's	6 2
Do. Morrovich Bros.	1 0 4
Do. Jas. Scott & Co's.	1 2 9
Do. Harbour Com-	
missioners, Queens-	
town	1 2 1
Do. Great Southern	
and Western Rail-	
way, Cork	7 8
Do. Mercantile Ma-	
rine Board, Cork	5 4
Do. do. Queenstown	2 2 0
Sums under 5s.	5 8
Total Dons.	13 17 0
Total Subs.	68 9 0
Total	£82 6 0

COURTMACSHERRY BRANCH.

Chairman—
The Right Hon. the EARL OF
SHANNON.

Honorary Secretary—
Captain TOWNSHEND.

Annual Subscriptions.

Boyle, Ladies	5 0 0
Cork Steam Ship Co.	5 0 0
Cunard Company	2 10 0
*Foster, A. Esq.	10 0
*Leslie, W. B. Esq.	10 0
*Shannon, Earl of	5 0 0
*Stawell, Col. Alcock,	
J.P.	2 0 0
*Townshend, Captain	10 0
Total	£21 0 0

BRANCHES—LIST OF ANNUAL SUBSCRIPTIONS AND DONATIONS. 617

YOUGHAL BRANCH.

Honorary Secretary—	
J. W. PIM, Esq.	
Annual Subscriptions.	
£.	s. d.
Allan, Mrs.	5 0
Duke of Devonshire	5 0
*Drury & Sons, Messrs.	10 0
*Farrall, Mr. Richard	5 0
Fitzgerald, Rev. L.	5 0
*Fleming, Mr. Michael	10 0
*Gorman, Mr. Patrick	10 0
Green, Miss C.	10 0
Green, Rev. Mr.	10 0
Lloyde, G. W. Esq.	3 0 0
Ponsonby, C.W. Esq.	1 1 0
J.P.	1 19 2
Boxes under 5s.	5 0
Total.....	£14 10 2

Co. Down.
BALLYWALTER
BRANCH.

Honorary Secretary—	
Rev. J. O'REILLY BLACKWOOD.	
Annual Subscriptions.	
£.	s. d.
Atkinson, Mrs.	5 0
Belfast Steam Shipping Co., per John McKea, Esq.	2 2 0
Carmichael, Messrs.	10 0
D. and W.	10 0
Cleland, Mrs. (Ballywalter)	5 0
Dunbar, Capt. J. G.	1 1 0
Dunbar, Miss	1 0 0
*Glover, Jas. B. Jun.	5 0
Greer, Rev. Geo.	5 0
Houston, J. B. Esq.	1 0 0
Lyle, Rev. Edward	5 0
*Mullholland, J. Esq., M.P.	2 0 0
Sinclair and Boyd, Messrs.	1 0 0
Stewart, Major D. Hamill	2 0 0
Walker, Geo. Esq.	10 0
Ward, John, Esq.	1 0 0
Total.....	£13 8 0

Donations.	
Chevalier	5 7 8
English Congregation at Croix, Nord, France, per Mast. Hy. Falkner (1880)	10 0 0
Total.....	£28 15 8

NEWCASTLE (DUNDRUM) BRANCH.

President—	
The EARL OF RODEN.	
Chairman—	
Rev. J. H. SHYMOUR, M.A.	
Honorary Secretary—	
Mr. WM. HAYWARD.	
Annual Subscriptions.	
£.	s. d.
Andrews, Thos. Esq.	5 0 0
Annesley, The Earl.	5 0 0
Annesley, Countess.	1 0 0
Brush, Geo. Esq.	10 0 0
Brush, Richd. Esq.	1 0 0

£.	s. d.
*Clarendon, S. Esq.	10 0
*Creery, C. Esq.	5 0
Gray, Dr.	5 0
Gray, Mrs. Graymount	5 0
Hamilton, Mrs. Killeahandra (7th don.)	3 0 6
*Hayward, Mr. W.	5 0 0
Humphrys, Mrs.	1 0 0
Kilmorey, The Earl of	5 0 0
*Kingscote, J.B. Esq.	1 0 0
Knox, Mrs.	5 0 0
Murland, J. Esq.	1 0 0
Murphy, J. Esq.	5 0 0
Porter, Mr.	5 0 0
*Roden, Earl of	4 0 0
*Seymour, Rev. J. H.	1 0 0
Shaw, W. Esq.	5 0 0
*Smith, Rev. S. J.	5 0 0
*Smyth, H. Esq., C.E.	10 0 0
Spankie, Lieut.	10 0 0
Stannus, Miss.	5 0 0
Stewart, Mrs.	5 0 0
*Waring, Wm. Esq.	1 0 0
Wright, J. Esq.	10 0 0
Collection Boxes.	1 14 2
Collected by Mrs. Robinson	13 6
Do. Miss Hutchings.	7 6
Sums under 5s.	1 6 0
Total	£33 11 8

TYRELLA BRANCH.

Honorary Secretary—	
D. McCANN, Esq.	
Annual Subscriptions.	
£.	s. d.
The Marquis of Downshire	5 0 0
The Dowager Marchioness of Downshire	1 0 0
The Lady Amelia Montgomery	1 0 0
Viscount Bangor	2 0 0
The Lady Matilda Montgomery	1 1 0
Lord de Ros	2 0 0
Atkinson, J. Brooke, Esq.	10 0 0
*Bingham, Rev. J.	5 0 0
Binney, Mrs., Oakley Deacon, Rev. John J.	10 0 0
*Digney, Mr. P.	5 0 0
East Downshire S. S. Co. Dundrum, per Mr. E. G. Henesey	2 2 0
Montgomery, Hugh, Esq.	2 10 0
Nugent, Col. Andrew	1 0 0
Pos, William T. Esq.	1 0 0
Reid, J. Esq.	5 0 0
*Smyth, Rev. G. Gordon	10 0 0
*Stephenson, S. S. Esq. M.D.	5 0 0
Total	£21 13 0

Donations and Collections.	
Brown, Rev. J. P.	10 0
Balance from Dinner to Crew	1 10 0
*Collection by Mr. C. Creese	2 6 0
Collection by Miss Nesbitt	4 0 0
*Collection by Mr. T. K. Carson	3 5 0
Other Boxes (Small Sums)	2 10 0
Total Dons.,	4 16 3
Total Subs.,	21 13 0
Total	£26 9 3

Co. Dublin.

DUBLIN BRANCH

Patron—
His Excellency EARL COWPER.
Lord-Lieutenant of Ireland.

Honorary Secretary—
THOMAS EDMONDSON, Esq.

Secretary and Collector—
Mr. J. PINK

Annual Subscriptions.

£.	s. d.
His Excellency Earl Cowper	10 0 0
Allen, Richard, Esq.	1 0 0
Ardilaun, The Lord.	2 0 0
Arnott & Co. Limited, Messrs.	3 3 0
Baker & Sons, Messrs. Wm.	5 0 0
Baker, Wardell & Co. Ballantine, Alex.	1 0 0
Bewley & Co. Messrs. S. Boyle, Low, Murray, and Co. Messrs.	2 0 0
British & Irish Steam-packet Company.	2 2 0
Brooke & Son, Messrs. G. F.	1 0 0
Brown, Thomas, and Co. Messrs.	1 0 0
Cantrell & Cochrane.	1 0 0
City of Dublin Steam-packet Company.	2 2 0
Clibborn, Jas.	5 0 0
Colquhoun, D. Esq.	1 0 0
Cowan and Co.	1 0 0
Crowe, Wilson, & Co. Messrs. Limited.	1 0 0
D'Arcy and Son, Messrs. John	2 0 0
Deering, A. Esq.	1 0 0
De Vesce, Lord	2 0 0
Dixon, Jas.	10 0 0
Drummond & Sons, Messrs. Wm.	1 0 0
Dublin and Glasgow Steam-packet Co.	2 2 0
Dublin and Liverpool Screw Steam-ship Company	2 0 0
Dublin Steam Printing Co.	1 0 0
Edmundson and Co. Messrs. J.	10 0 0
Egan, A. W. Esq.	10 0 0
Ferrier, Pollock, and Co. Messrs.	2 0 0
Findlater, J. Esq.	2 2 0
Fisher, Thomas, Esq.	10 0 0
Forster & Co. Messrs.	1 0 0
Garratt, J. Esq.	1 0 0
Gilbey, Messrs. W. and A.	1 1 0
Green Bros. Messrs.	1 0 0
Handcock, W. D.	10 0 0
Hazleton Connor and Co. Messrs.	10 0 0
Heiton & Co. Messrs. T.	1 1 0
Hogg & Co. Messrs. W.	1 0 0
Howell, P. Esq.	1 0 0
Jacob, R. S. Esq.	5 0 0
Jameson and Son, Messrs. John	2 0 0
Jameson, Pim, and Co. Messrs.	1 1 0
Jameson and Co., Messrs. William.	1 0 0
Kenny and Owens, Messrs.	10 6 0
Kildare, Lord	2 0 0
Kinahan and Sons, Messrs.	2 0 0

£.	s. d.
Lambert, Brien, and Co. Messrs.	10 0 0
Leitch, Thos. Esq., J.P.	10 0 0
McCullagh, Son, & Co. Messrs. James.	2 2 0
*McDonnell & Co., Messrs. Thomas.	10 0 0
McKea, W. C. Esq.	1 0 0
MacMullen, Shaw, & Co. Messrs.	1 0 0
McSwiney & Co. (Limited)	2 0 0
Manders, Robt. & Co.	2 0 0
Martin, Messrs. T. and C.	1 0 0
Millar, Adam, and Co.	1 0 6
Moses, M. T. for 1880	10 0 0
Ogilvy, Alex. Esq.	1 0 0
Palgrave, Murphy, and Co. Messrs.	2 2 0
Pease, Mrs.	2 0 0
Perrin, Rd. and Son.	1 0 0
Pim, Bros. and Co. (Limited) Messrs.	3 0 0
Powerscourt, Lord.	2 2 0
Roe, Henry, Jun.	2 2 0
Ross and Walpole, Messrs.	1 0 0
Scott, Bell, and Co. Messrs.	10 0 0
Shackleton and Sons, George	1 0 0
Switzer, Fergusson, and Co. Messrs.	1 0 0
Taylor, Messrs. W. and M.	1 0 0
Tedcastle and Co. Messrs. R.	1 10 0
Todd, Burns, and Co. Messrs.	3 3 0
Turbett, Messrs. Rbt. & Jas.	1 0 0
Watkins & Co. Joseph Messrs.	2 0 0
Webb, J. H. & Co. (Limited)	10 0 0
Webb, J. Esq.	1 0 0
Weir, James and Co.	1 0 0
Westby, Edward Percival, Esq., J.P.	5 0 0
White, Joshua, Esq.	1 0 0
Wilson, Wm. Esq.	5 0 0
Woods, Webb, and Phenix, Messrs.	1 6 0
Wynyard, Maj.-Gen.	1 0 0
Total	107 13 6

Donations.	
Cane, Miss C. F.	5 0 0
Collecting Box Prince of Wales	14 4
Collecting Boxes at Custom House—	
Inland Revenue	7 0
Long Room	1 19 0
Dividend on Clifford's Bequest	44 11 4
Dublin and Glasgow Steam-packet Co.'s Fleet	17 6
Imperial Hotel, Dublin.	6 2
Leinster Club, Collected by O.O.'Brien, Esq.—	
Alexander, Geo. J. Esq.	1 0 0
Bloxham, Hy. C. Esq.	1 0 0
Chamberlain, M. H. Esq.	1 0 0
Larking, Michael, Esq.	1 0 0
McDermott, John, Esq.	1 0 0
Smith, Patk. A. Esq.	1 0 0
St. Wolstans, Servants and other friends at, Collected by John Helyer	2 0 0

	£.	s.	d.
s.s. <i>Countess of Dub-</i>			
<i>lin</i>	7	2	1
s.s. <i>Lady Olive</i>	2	11	4
s.s. <i>Lady Wodehouse</i>	1	3	10
Sums under 5s.....	-	7	10
Pillar Boxes.....	-	17	4
Total Dons....	73	17	9
Total Subs....	107	13	6
	£181	11	3

KINGSTOWN BRANCH.

President—
The Most Noble the MARQUIS OF ORMONDE.
Honorary Secretary—
Commander the Hon. F. G. CROFTON, R.N.

	£.	s.	d.
<i>Annual Subscriptions.</i>			
Barton, H. L., D.L.	5	0	0
Barton, Miss	3	0	0
Browne, Mrs. R. F.	1	0	0
Bruce, Miss	-	5	0
Burroughs, Rev. W. E.	-	10	0
Chatterton, the Vice-Chancellor	2	0	0
Close, S. H. Esq.	1	0	0
Coghill, Sir J. J. Bart.	1	0	0
*Dalton, Rev. G. W.	-	10	0
*Dalton, G. E. R. Esq.	-	5	0
Daly, Hon. Skeffington	2	0	0
*Delap, J. B.	1	0	0
Dillon, Hon. L. G.	-	10	0
Dudgeon, J. Hume, Esq.	2	2	0
Elliott, Mrs.	-	10	0
Gilmore, Mrs. J. S.	-	5	0
Elwood, Miss	-	5	0
Hogan, W. O. Esq.	-	10	0
*Hone, Brindley	1	0	0
Hogan, J. F. Esq.	-	10	0
Houghton, J. T. Esq.	1	0	0
Lodge, Miss	1	0	0
Lyle, J. A. Esq.	1	0	0
Magee, Miss	1	0	0
Moorewood, Misses	1	0	0
O'Hara, Mrs. Hamilton	1	0	0
Ormonde, Marquis of, Yacht <i>Mirage</i>	5	0	0
Reid, J. Hamilton, Esq.	1	0	0
Royal Alfred Yacht Club	2	2	0
Royal Irish Yacht Club, per Committee	2	0	0
Royal St. George's Yacht Club	3	0	0
Wolf, Mrs.	-	5	0
Total.....	42	9	0

	£.	s.	d.
<i>Donations.</i>			
Collecting Boxes on Mail Steamers—			
<i>Conynright</i>	1	5	8
<i>Munster</i>	-	15	6
<i>Ulster</i>	-	10	7
<i>Leinster</i>	1	8	8
Bray Collecting Box	1	7	6
Kingstown do. B. Stat.	4	4	3
Seapoint do.....	1	17	10
Salthill do.....	1	18	10
Kingstown do. Pier	2	9	4
R. Irish Yacht Club do.	1	0	4
Boat-House Box....	-	2	11
Total Dons....	17	1	5
Total Subs....	42	9	0
	£59	10	5

BALBRIGGAN BRANCH.

Chairman—
EDWARD HAMILTON WOODS, Esq., J.P.

Honorary Secretaries—
H. A. HAMILTON, Esq., J.P.
W. J. CUMISKY, Esq.

	£.	s.	d.
<i>Annual Subscriptions.</i>			
Cumisky, W. Esq.	1	0	0
*Fildgate, Capt. Townley M.	1	1	0
Grogan, Rev. John	1	0	0
*Hamilton, R. A. Esq.	1	1	0
Jameson, R. D. Esq.	1	1	0
Moore, R. Tunstall, Esq.	1	1	0
Taylor, Col. E. T., M.P.	1	0	0
Woods, E. H. Esq.	1	0	0
*Woods, W. St. L. Esq.	1	0	0
*Whyte, Wm. Esq.	1	0	0
Total.....	£10	4	0

ROGERSTOWN BRANCH.

President—
Maj.-Gen. SIR ROGER PALMER, BART.

Chairman—
CHARLES COBBE, Esq., D.L.

Honorary Secretaries—
WM. C. TOWNSEND, Esq., J.P.
R. BUTLER, Esq.

	£.	s.	d.
<i>Annual Subscriptions.</i>			
Brooke, The Misses	1	0	0
*Butler, R. Esq.	1	0	0
*Cobbe, C. Esq.	3	0	0
*Palmer, Major-Gen. Sir Roger, Bart.	5	0	0
*Perrin, M. Esq.	1	0	0
Total.....	£11	0	0

SKERRIES BRANCH.

Chairman—
ION TRANT HAMILTON Esq., M.P.

Honorary Secretaries—
HENRY A. HAMILTON, Esq., J.P., Balbriggan.
HENRY H. FOSTER, Esq., Skerries.

	£.	s.	d.
<i>Annual Subscriptions.</i>			
B—, Miss, per C.	1	0	0
Cobbe, Esq.	1	0	0
Cobbe, Charles, Esq.	2	1	0
Foster, H. H.	1	0	0
Gowan, Francis, Esq.	1	0	0
Hamilton, H. A. Esq.	1	1	0
Hamilton, Ion T. Esq. M.P.	2	0	0
Hamilton, Mrs.	1	1	0
Hutchinson, Hon. Mrs. C. Hely	1	1	0
Palmer, Sir R. Bart.	2	0	0
Pepper, J. St. George, Esq.	1	1	0
Scriven, Dr.	1	1	0
Talbot de Malahide, Lord	1	1	0
Taylor, Col. Rt. Hon. T. E., M.P.	2	0	0
Woods, Edward H. Esq.	2	0	0
Collection in Box...	-	5	7
Total.....	£19	12	7

Co. Fermanagh.

ENNISKILLEN BRANCH.

President—
The Right Hon. The EARL OF BELMORE.

Chairman—
Rev. Dr. STEELE.

Honorary Secretary—
Hon. Mrs. POMEROY

	£.	s.	d.
<i>Annual Subscriptions.</i>			
Archdale, Col.	-	10	0
Archdale, W. Esq., M.P.	1	0	0
Bagot, Dr., M.D.	-	5	0
*Belmore, Earl of	1	0	0
Brooke, Mrs. Butler	1	0	0
Burnside, Dr., D.D.	-	5	0
Chapman, Thomas, Esq.	1	0	0
Colley, Miss Pomeroy	-	10	0
Crichton, Hon. Capt. H.	2	0	0
Crichton, Lady C.	1	0	0
Erne, Countess of	1	0	0
Glen, Robt. Esq.	-	5	0
Greer, Rev. S.	1	0	0
Jones, Mrs.	-	5	0
Knox, Miss Emily	-	10	0
Knox, Mrs.	1	0	0
Ormsby, Mrs.	-	10	0
Pomeroy, Hon. Mrs. A. D.	12	3	0
Pomeroy, John A. Esq.	1	0	0
Pomeroy, Mrs. J. A.	5	0	0
Pomeroy, W. K. Esq.	1	0	0
Stewart, C. Esq.	1	0	0
Stirling, Mrs. of Gardin	1	0	0
Tennant, Lady	-	5	0
Tipping, Lieut. H. Gartside, R.N.	1	0	0
Wigram, Francis, Esq.	1	0	0
Williams, W. Esq.	-	5	0
Wood, Mrs.	-	11	6
Sums under 5s.....	-	5	0
£23	3	9	

	£.	s.	d.
<i>Annual Subscriptions.</i>			
Archdale, Col.	-	10	0
Archdale, W. Esq., M.P.	1	0	0
Bagot, Dr., M.D.	-	5	0
*Belmore, Earl of	1	0	0
Brooke, Mrs. Butler	1	0	0
Burnside, Dr., D.D.	-	5	0
Chapman, Thomas, Esq.	1	0	0
Colley, Miss Pomeroy	-	10	0
Crichton, Hon. Capt. H.	2	0	0
Crichton, Lady C.	1	0	0
Erne, Countess of	1	0	0
Glen, Robt. Esq.	-	5	0
Greer, Rev. S.	1	0	0
Jones, Mrs.	-	5	0
Knox, Miss Emily	-	10	0
Knox, Mrs.	1	0	0
Ormsby, Mrs.	-	10	0
Pomeroy, Hon. Mrs. A. D.	12	3	0
Pomeroy, John A. Esq.	1	0	0
Pomeroy, Mrs. J. A.	5	0	0
Pomeroy, W. K. Esq.	1	0	0
Stewart, C. Esq.	1	0	0
Stirling, Mrs. of Gardin	1	0	0
Tennant, Lady	-	5	0
Tipping, Lieut. H. Gartside, R.N.	1	0	0
Wigram, Francis, Esq.	1	0	0
Williams, W. Esq.	-	5	0
Wood, Mrs.	-	11	6
Sums under 5s.....	-	5	0
£23	3	9	

Co. Kerry.

TRALEE BAY BRANCH.

President—
The Rt. Hon. LORD VENTRY.

Vice-President—
Lieut.-Col. CROSBY.

Honorary Secretary—
MR. ROBERT McCOWEN,
Lloyd's Agent.

	£.	s.	d.
<i>Annual Subscriptions.</i>			
Listowel, Lord	2	0	0
Hawkey, Capt. R.N.	1	1	0
McCowen, R. Esq.	1	0	0
Total.....	4	1	0

	£.	s.	d.
<i>Donations.</i>			
Contribution Boxes, &c.....	2	14	0
£6	15	0	

VALENTIA BRANCH.

Hon. Secretary—
MR. JOHN O'DRISCOLL.

	£.	s.	d.
<i>Annual Subscriptions.</i>			
Butler, James, Esq.	1	0	0
Crosby, W. T. Esq. (two years)	2	0	0
Dunraven, The Earl of	1	1	0
Fitzgerald, J. F. Esq.	-	10	0
Hartopp, E. B. Esq.	1	0	0
Kerry, The Knight of Lansdowne, The Marquis of	2	0	0
Leahy, John White, Esq.	1	0	0
Mahony, Richd. Esq. Dromore	1	0	0
O'Donnell, Dan. Esq. Derrynane	1	0	0
Slaughton, T. A. Esq.	1	0	0
Trinity Col. Dublin	3	0	0
Total.....	£15	14	0

Co. Limerick.

LIMERICK BRANCH.

Secretary and Collector—
MR. J. PIKE.

	£.	s.	d.
<i>Annual Subscriptions.</i>			
Alexander, Jas. Esq.	1	1	0
Bannatyne, J. & Son	1	0	0
Boyd, J. and G.	1	0	0
Clarina, Lady	1	0	0
Cochrane, William.. Daly and Co. Limited, Messrs. John	-	10	0
Fitt, Edward	-	10	0
Harris, Messrs., and Sons	5	0	0
Limerick Harbour Commissioners	5	0	0
Matterson and Sons, Messrs.	1	0	0
Russell, Arthur	1	0	0
Russell Jno. N.	1	0	0
Shaw & Sons, Messrs. W. J.	1	0	0
Spaight and Sons, Messrs. F.	1	0	0
Todd and Co. Messrs.	1	0	0
Wallace, Richard	-	5	0
Total.....	£15	16	0

BRANCHES—LIST OF ANNUAL SUBSCRIPTIONS AND DONATIONS. 619

Co. Londonderry.

LONDONDERRY AND GREENCASTLE BRANCH.

President—
JOHN COOKE, Esq.
Honorary Secretaries—
PIERCE, CROSSIE, Esq.
THOMAS LLOYD, Esq.

Annual Subscriptions.

	£.	s.	d.
Londonderry Harbour Commissioners	10	0	0
Hon. Irish Society	5	0	0
Lord Bishop of Derry	1	1	0
Lord Donegall	2	0	0
*Rev. Thos. McClellan	10	0	0
*Mr. Lepper	5	0	0
*Major Irvine	2	6	0
Total	£18	18	6

Coz. Louth and Meath.

DROGHEDA BRANCH.

Patron—
THE MARQUIS OF CONYNGHAM.
Honorary Secretary at Baltray—
NICHOLAS HALLIGAN, Esq.
Honorary Secretary for Mornington—
H. T. CANNON, Esq.
Secretary and Collector—
MR. J. McNAMARA.

Annual Subscriptions.

	£.	s.	d.
The Harbour Board	5	0	0
Steam Packet Co.	5	0	0
Balfour, B. T., J.P.	1	0	0
Bank of Ireland	1	0	0
Belfast Banking Co.	1	0	0
Brodigan, Francis, Colonel 28th Regiment	1	0	0
Cairnes, T. T., J.P.	10	0	0
Chadwick, Messrs. J. and F.	10	0	0
Clinton, Robert	5	0	0
Coddington, H. B., J.P.	10	0	0
Conyngnam, Marquis of (Patron)	2	0	0
Corbally, Hon. Mrs.	2	0	0
Cullen, Alderman	5	0	0
Daly, Alderman, J.P.	10	0	0
Darney, Earl of	2	0	0
Davis & Co. Messrs.	10	0	0
Dean, Joseph	10	0	0
Donagh, Francis, J.P.	1	0	0
Eccles, Rev. Mr. (Rector)	5	0	0
Greene, J. J. F. Messrs.	5	0	0
Grendon & Co. Messrs.	10	0	0
Halligan, N.	5	0	0
Hibernian Bank	10	0	0
Hughes, John	5	0	0
Jameson, James, J.P.	1	0	0
M'Donogh, Edward	5	0	0
Montgomery, Richard T., J.P.	10	0	0

	£.	s.	d.
Morton, Messrs. J. and R.	10	0	0
Murdoch, Alexander	5	0	0
Provincial Bank	10	0	0
Saw Mills Company	10	0	0
Smyth, Miss	5	0	0
Smyth, Miss Anna	1	0	0
Smyth, Miss Ethel	1	0	0
Toker, Capt. Edw., s.s. <i>Norak Creina</i>	5	0	0
Wetherill and Co. Messrs.	10	0	0
Whitworth, Wm., J.P.	10	0	0
Whitworth, Nicholas	10	0	0
Woolsey, Jameson, & Co. Messrs.	10	0	0
Custom House Box	4	0	0
Bank of Ireland Box	5	10	0
Total	£33	1	10

DUNDALK BRANCH.

Chairman—
MICHAEL KELLY, Esq. J.P.
Honorary Secretary—
J. F. FARRELL, Esq.
Annual Subscriptions.
Kelly, Mr. 1 0 0
Robson, Wm. 1 0 0
Tempest, Wm. 1 0 0
Total ... 3 0 0

Donations.
Dundalk Harbour Commissioners ... 25 14 0
£28 14 0

Co. Waterford.

ARDMORE BRANCH.

Chairman—
Rev. THOMAS R. ROTHWELL.
Honorary Secretary—
W. C. POOLE, Esq., M.D., J.P.
Annual Subscriptions.
1881.
Cotton, Charles P. Esq., C.E. 1 0 0
*Cooper, Mr. Henry ... 5 0 0
Cotton, Major ... 10 0 0
Cotton, R. W. Esq. ... 10 0 0
Cotton, Miss ... 10 0 0
Cotton, Miss Mary ... 10 0 0
Donoughmore, Earl of ... 10 0 0
*Dawson, Capt. ... 10 0 0
*Douglas, Mr. Arthur ... 5 0 0
*Foley, Thomas, Esq. J.P. 10 0 0
*Foley, Richard, Esq. C.E. 10 0 0
*Foley, Edmund, Esq. ... 10 0 0
*Keane, Col. C. B. ... 10 0 0
*Musgrave, Sir Rich. Bart. 2 0 0
*McKenna, Sir J. Neale, M.P. 1 0 0
Paul, Sir Robert J., Bart. 1 0 0
*Poole, Wm. C. Esq. J.P. 10 0 0
*Rothwell, Rev. Thos. R. 10 0 0
Total £12 0 0

DUNGARVAN BRANCH.

Patron—
His Grace the DUKE OF DEVONSHIRE, K.G.
President—
Lord STUART DE DECRES.
Treasurers—
NATIONAL BANK.
Honorary Secretary—
MR. JAMES W. SHAW.
Annual Subscriptions.
Ardagh, W. M. 5 0 0
Gibbons, Capt. Wm. ... 10 0 0
Harbour Commissioners, The ... 3 0 0
Hudson, R. G. Esq. ... 10 0 0
Humble, Sir J. Nugent, Bart. 2 0 0
Hunt, John, Esq. 10 0 0
McO'neil, Mrs. 5 0 0
McGwire, S. E. Esq. ... 1 0 0
Merry, Robert A. Esq. ... 5 0 0
Power, Sir R. Bart. ... 1 0 0
Ussher, R. J. Esq. ... 1 0 0
Waterford, Lord ... 2 0 0
Sums under 5s. 3 13 0
Total £15 18 0
Donations.
Hily, William 1 0 0
Stuart, H. Villiers ... 2 0 0
£18 18 0

TRAMORE BRANCH.

Chairman—
The Hon. D. FORTESCUE.
Honorary Secretary—
EDWARD JACOB, Esq.
Annual Subscriptions.
*Ambrose, Charles ... 10 0 0
Ardagh, Robert, Esq. ... 10 0 0
Bessborough, Earl of ... 1 0 0
*Budd, James, Esq. ... 10 0 0
Christy, Wakefield ... 1 0 0
Clibborn, Edw. Esq. ... 10 0 0
*Denny and Sons, Messrs. Henry ... 2 0 0
*Denny, Charles, Esq. ... 10 0 0
Donerale, Lord ... 3 0 0
Dorner, Thos. P. Esq. ... 10 0 0
*Fisher, Joseph, Esq. ... 10 0 0
Fortescue, Earl ... 2 0 0
*Fortescue, Hon. D. ... 2 0 0
Galway, Henry ... 5 0 0
Goft, Strangman D. ... 2 0 0
Goft, William D. ... 10 0 0
Graves, J. P. Esq. ... 10 0 0
Grubb, Miss H. ... 1 0 0
Grubb, Misses L. & S. ... 1 0 0
Hallows, Rev. R. ... 1 1 0
*Harrahan, P. F. Esq. ... 5 0 0
Harbour Board of Waterford ... 10 0 0
*Jacob, Edward ... 10 0 0
Jacob, Francis ... 10 0 0
Jacob, T. W. Esq. J.P. ... 10 0 0
Kavanagh, Lady Harlet. 1 0 0
Kent, David, Esq. ... 5 0 0
Murray, H. Esq. ... 10 0 0
O'Shea, Lady G. ... 1 0 0
*Peet, Edward G. Esq. ... 10 0 0
Pim, Mrs. 5 0 0
Power, E. H. Esq. ... 10 0 0
Power, P. W. Esq. J.P. ... 1 0 0
*Power, Rev. R. P.P. ... 10 0 0
*Power, James, Esq. Jun. 10 0 0
Pope, Messrs. H. & W. ... 10 0 0
Riall, J. Esq. 10 0 0

	£.	s.	d.
Riall, Miss	10	0	0
*Rochford, Capt. R.N.	10	0	0
Ryan, Lawrence, Esq.	10	0	0
Slatery, Messrs.	10	0	0
Strangman, S. Esq.	1	0	0
Strangman, Miss C.M.	5	0	0
*Toppin, Rev. R.	10	0	0
Tottenham, Mrs. W. D.	1	1	0
Ward Brothers	10	0	0
Wark, John, Esq.	10	0	0
Waterford Steam Ship Co.	5	0	0
White Brothers, Messrs.	1	0	0
*White, Edwin, Esq.	5	0	0
White, George, Esq.	5	0	0
White, William Esq.	5	0	0
Wilson, John, Esq.	1	0	0
Coll. by Mrs. Davis Kinnescorthy	3	0	0
Collection Box at O. Veiaava, Italian Consular Agent, Waterford	1	0	0
Total	57	2	0

Donations.
T. W. Anderson, Esq. J.P. 5 0 0
Mrs. Jacob, Kansas, United States ... 1 0 0
In thankful remembrance of safely landing 7th July, 1881 2 0 0
£65 2 0

Co. Wexford.

CAHORE BRANCH.

Honorary Secretary—
Capt. RICHARD D'OLIER GROGUE.
Assistant Hon. Secretary—
MR. JOHN SINNOTT.
Annual Subscriptions.
Bates, Mr. James ... 10 0 0
Bolton, Wm. Esq. ... 1 0 0
Bond, E. C. Esq. 10 0 0
Brooke, G. Esq. 1 0 0
Bryan, L. A. Esq. ... 2 0 0
Burkitt, T. H. Esq. ... 5 0 0
Chambers, Rev. J.W., D.D. 10 0 0
City of Dublin Steam-packet Company ... 1 1 0
Collins, Capt. R.N. ... 1 0 0
Corcoran, John, Esq. ... 10 0 0
Courtown, Earl of ... 1 0 0
Day, Rev. A. B. ... 10 0 0
Donovan, Rich. Esq. ... 5 0 0
Doyno, C. M. Esq. ... 1 0 0
Eaton, Messrs. M. & S. ... 10 0 0
Foster, W. O. Esq. ... 1 0 0
Furlong, Rev. J. L., P.P. 1 0 0
George, Mrs. Mary, Sen. 10 0 0
*George, Capt. R. D'O. ... 1 0 0
Godkin, Mr. J. 10 0 0
Graves, E. Esq. 1 0 0
Hinds, Rev. C. 5 0 0
Hogan, J. A. Esq. ... 1 1 0
Hughes, Sir F. 1 0 0
Lee, Lieut.-Colonel W. H. 10 0 0
Lloyd, M. Esq. 10 0 0

	£.	s.	d.
Murdock, Rev. J. C.	1	0	0
Murphy, J., Esq.	10	0	0
Murphy, Michael, Esq.	10	0	0
Murphy, Rev. P., C.C.	10	0	0
O'Brien, Rev. J., P.P.	10	0	0
Pounden, J. C. Esq.	7	6	0
Power, Sir Jno. Bart.	1	0	0
Richards, Mrs.	1	0	0
Richards, Mrs.	10	0	0
Roche, Mrs.	1	0	0
Scott, J. S. Esq.	1	0	0
*Sinnott, Mr. John	10	0	0
Symes, Miss.	1	0	0
Warren, G. W. Esq.	10	0	0
Whitcroft, Jno. Esq.	1	0	0
Sums under 5s.	5	0	0
Total	£30	19	6

CARNSORE BRANCH.

Chairman—
Hon. J. A. KEANE, D.L.

Honorary Secretary—
E. A. GIBBON, Esq.

Annual Subscriptions.

Alexander, (Capt. R.E.)			
A. C.	1	1	0
Alexander (Major)			
The Buffs G. A.	1	0	0
Alexander, Rev. J.	3	0	0
Alexander, Miss	10	0	0
Blacker, Mrs. John R.	1	0	0
Everett, Miss Burns	10	0	0
Fitzgerald, Lord			
Maurice	2	0	0
Furlong, Mr. B.	10	0	0
Garvey, Miss J. M.	1	0	0
Gibbon, E. Acton,			
Esq.	1	0	0
Gilbert, John, Esq.	5	0	0
Hatton, Mrs.	5	0	0
Irvine, H. Esq.	1	1	0
Keane, Hon. Colonel,			
D.L.	1	0	0
Keane, Hon. Mrs.			
(the late)	1	0	0
Lett, B. Esq.	1	0	0
Lett, Mrs.	1	0	0
Little, Miss	10	0	0
Mahony, W. A. Esq.	1	0	0
Morgan-Deane, Hon.			
Mrs.	1	0	0
McKinnell, Joa. Esq.	5	0	0
Palmer, Mrs. Ricardo	1	1	0
Segrave, Mrs.	1	0	0
Steele, R. B. Esq.	5	0	0
Total	19	6	0

Donations.

Irving, E. Tottenham,			
Esq., J.P. D.L.	1	0	0
Lloyd, John, Esq.			
M.D.	5	0	0
Total	£20	11	0

COURTOWN BRANCH.

Patron—
Rt. Hon. Earl of COURTOWN.

Treasurer and Hon. Sec.—
JAMES S. SCOTT, Esq., J.P.

Annual Subscriptions.

Allen, John B. M.D.	1	0	0
*Arthur, Rev. Canon	1	0	0
*Courtown, Earl of.	2	0	0
Courtown, Countess.	1	0	0
Cox, Lieut.-Col. C.			
Wolsley	1	0	0

	£.	s.	d.
Davis, Messrs. S. & A. G.	1	0	0
Doyle, C. M. Esq.	1	0	0
Doyle, J. W. C. Esq.	1	0	0
Eckersall, Mrs.	1	0	0
Edwards, Thos. Esq.	1	0	0
Ellis, T. C. Esq.	10	0	0
Esmonde, Sir Thos. Bt.	1	0	0
Foster, W. O. Esq.	1	0	0
*Furlong, Rev. John,			
for 1880 & 1881	1	0	0
George, Captain R.			
d'Olier	1	0	0
Gibbon, J. G. Esq.			
LL.D.	1	0	0
*Guise, Major-General			
John C., V.C.	1	0	0
Hamilton, Rev. Chas.	1	0	0
Hatton, Colonel	1	0	0
Little, Simon, Esq.	1	0	0
Montgomery, Mrs. A.			
Shirley	1	0	0
Nixon, Mrs.	10	0	0
Pelan, Mrs. Eliza	5	0	0
Power, Sir John			
Talbot, Bt.	1	0	0
Ram, Rev. Canon	1	0	0
Richards, Arthur W.			
M. Esq.	1	0	0
*Scott, Jas. S. Esq.	1	0	0
Sinnott, Rev. Robert,			
P.P.	10	0	0
Stopford, Hon. E. S.	1	0	0
Ward, Mrs. Bernard	1	0	0
Ward, Capt. T. Le			
Hunte, R.N.	1	0	0
Sums under 5s.	1	10	0
Total	31	5	0

Donations.

Col. H. E. Watson,			
22 Regiment	5	0	0
Collecting Boxes	2	11	1
Total	£34	1	1

DUNCANNON AND WATERFORD HARBOUR BRANCH.

Chairman—
Sir ROBERT PAUL, Bart.

Honorary Secretary—
Mr. J. MCGONAGH.

Annual Subscriptions.

Chichester, Hon. Capt.	1	0	0
Denny, A. Esq.	1	0	0
Gough, S. D. Esq.	1	0	0
Graves, Rev. James	5	0	0
McGonagil, J.	5	0	0
Supple, Rev. Mr.	5	0	0
Templemore, Lord.	3	3	0
Waterford, Marq. of	2	0	0
Waterford S. S. Co.	5	0	0
*White Brothers	2	0	0
Total	£15	18	0

WEXFORD AND ROSSLARE BRANCH.

Chairman—
R. J. DEVEREUX, Esq.

Honorary Secretary—
WILLIAM COGHLAN, Esq. J.P.

Annual Subscriptions.

Armstrong, Mrs.	10	0	0
Armstrong, W. Esq.	5	0	0
Bacon, John, Esq.	1	0	0
Barrington, J. Esq.	5	0	0
Barry & Co. John E.	1	0	0
Boxwell, Harvy, Esq.,			
J.P.	1	0	0

	£.	s.	d.
Bristol Steam Navigation Company	1	1	0
Brown, W. Esq.	1	0	0
Codd, Capt. Sallee	5	0	0
Devereux, John Thos., Esq., D.L.	1	0	0
Devereux, J. P. Esq.	1	0	0
Devereux, R. Esq.	1	0	0
Donoughmore, Earl of	1	0	0
Ennis, Michael, Esq.	5	0	0
Faris, David, Esq.	5	0	0
Fitzgerald, Lord			
Maurice	1	0	0
Gafney, W. J. Esq.	1	0	0
Gibbons, Doctor	10	0	0
Goff, S. D. Esq., J.P.	2	0	0
Hatton, Colonel, D.L.	1	0	0
Hutchinson, Thos., manager for <i>Maidie Annie, J. P. Taylor, British Queen, Seaflower, &c.</i>	1	0	0
Leigh, Miss	1	0	0
Leigh, Miss M. A.	1	0	0
Little, S. Esq.	1	0	0
Morgan, Hon. Mrs. D.	1	0	0
Peacock, Chas. H. Esq., J.P.	1	0	0
Power, Sir John T. Bart. D.L.	1	0	0
Richards, Mrs.	1	0	0
Templemore, The Rt. Hon. Lord.	2	2	0
Walker, Capt. D. L.	1	0	0
Walker, Mrs.	1	0	0
Walker, Miss	1	0	0
Walker, Robt. D. Esq.	10	0	0
Warry, Capt., R.N.	1	0	0
Wexford Harbour Commissioners.	5	0	0
Contribution Box,			
Custom House	17	6	0
Total	£36	15	6

Co. Wicklow.

ARKLOW BRANCH.

Chairman—
The EARL OF CARYSFORT.

Treasurer—
PETER J. BLAKE, Esq.

Honorary Secretary—
The EARL OF WICKLOW.

Assistant Hon. Sec.—
Dr. HALPIN.

Annual Subscriptions.

	£.	s.	d.
*Bayly, Col. D. L., J.P.	1	0	0
Beauman, Miss	1	0	0
Bryan, Rev. W. B.	5	0	0
*The Earl of Carysfort	10	0	0
Daly, Rev. Wm.	5	0	0
Dowl, Mrs.	5	0	0
Doyle, Mrs. John	5	0	0
Hall, Mr. Job	5	0	0
*Halpin, Dr.	5	0	0
*Keaton, Mr. Edward	5	0	0
*Keaton, Mr. Richard	5	0	0
*Maher, Mr. Patrick	5	0	0
O'Grady, Hon. Mrs.	10	0	0
Ormsby, Rev. W. G.	1	0	0
*Robinson, Hen. Esq.	10	0	0
Sums under 5s.	6	6	0
Total	£22	11	0

Collected from Out-Pensioners at the undermentioned Stations on behalf of this Life-boat.

Donations.

	£.	s.	d.
Chatham, per Capt. H. G. Rogers	12	0	3
Exeter District, per Lt.-Col. Brockman	3	0	0
Southampton, per Lt.-Col. D. Beere	4	12	11
Total Dons.	19	13	2
Total Subs.	22	11	0
Total	£42	4	2

GREYSTONES BRANCH.

President—
The EARL OF MEATH.

Chairman—
WM. R. LA TOUCHE, Esq.

Honorary Secretary—
PATRICK REID, Esq.

Annual Subscriptions.

Burnaby, Mrs.	2	0	0
Connor, Mrs.	2	6	0
*Corbet, William J. Esq. M.P.	1	0	0
*Doyle, Mr. John	5	0	0
Furlong, Miss	10	0	0
Hodson, Sir Geo. Bt.	1	0	0
*La Touche, W.R. Esq.	3	0	0
Lunel, Misses	1	0	0
Macfarlane, Colonel	10	0	0
Maziers, Miss	5	0	0
McClelland, R. Esq. M.D.	1	1	0
Meade, J. F. Esq.	10	0	0
Meath, The Rt. Hon. the Earl of	3	0	0
Newton, Misses	1	0	0
Pennick, Robt. Esq.	5	0	0
*Price, Jas., Esq. C.E.I	0	0	0
*Reid, Patrick, Esq.	2	0	0
Rutherford, Mrs.	2	6	0
Scott, J. W. Esq.	10	0	0
Streane, Ven. Archdeacon H.	10	0	0
Tombe, G. E. Esq.	1	0	0
Total	20	11	0

Donations.

Collecting Box in Life-boat House	3	3	0
Total	£20	14	3

WICKLOW BRANCH.

Patrons—
The Right Hon. the EARL FITZWILLIAM and W. W. FITZWILLIAM DICK, Esq. M.P.

Chairman—
Capt. A. J. S. COLLINS, R.N.

Treasurer and Hon. Sec.—
S. E. PEM, Esq.

Annual Subscriptions.

Atkinson, Lieut.-Col.	1	0	0
Bilbrough, B. P. Esq.	1	0	0
Collins, Capt. A. J. S., R.N.	1	0	0
Doolittle, Capt. E.	5	0	0
Drought, Rev. J. W.	1	0	0
Drought, Captain R.R., J.P.	1	0	0
Dublin, Archbishop of	1	0	0

BRANCHES—LIST OF ANNUAL SUBSCRIPTIONS AND DONATIONS. 621

	£.	s.	d.
Edwards and Sons,			
Messrs. John.....	1	0	0
Ellis, R. F. Esq. J.P.	1	0	0
Evans, Capt. E. B.,			
R. A.....	1	0	0
Fitzwilliam, Earl.....	2	0	0
Gregg, Mr. W.....	10	0	0
Nolan, John, Esq.....	10	0	0
Pim, S. E. Esq.....	10	0	0
Rooke, Rev. Henry.....	5	0	0
Segreve, Capt. of Kill-			
timon.....	1	0	0
Spinner, Mrs.....	10	0	0
Tighe, Lt.-Col. J. S.,			
J.P., D.L.....	1	1	0
Tottenham, Lt.-Col.			
of Ballycurry, D.L.	1	1	0
Truett, H. P. Esq.....	10	0	0
M.B., J.P.....	1	1	0
Total.....	£17	13	0

Isle of Man.

CASTLETOWN BRANCH.

Chairman—
J. M. JEFFCOCK, Esq., High Bailiff.

Honorary Secretary—
GEORGE H. QUAYLE, Esq.

Annual Subscriptions.

	£.	s.	d.
The Lieut.-Governor	2	0	0
Cary, Lieut.-Colonel.....	10	0	0
Clague, Mrs.....	5	0	0
*Crellin, R. Q. Esq.....	10	0	0
Cudd, W. H. Esq.....	10	0	0
Dodd, Tom M.....	5	0	0
Drinkwater, Sir W.			
L. Deemster.....	1	0	0
*Ferrier, Rev. E.....	5	0	0
Gawne, Mrs.....	1	0	0
Geneste, Captain.....	5	0	0
Gill, Sir James,			
Attorney-General.....	10	0	0
Gill, Fred I.....	5	0	0
Gill, Mrs.....	5	0	0
Hughes-Games, Rev.			
J., D.C.L.....	5	0	0
Isle of Man Steam-			
packet Company.....	2	0	0
McClellan, Miss.....	5	0	0
Moore, Thos. Esq.....	5	0	0
Moore, W. F. Esq.....	10	0	0
Newton, Miss.....	10	0	0
Quayle, Geo. P. Esq.....	5	0	0
Quayle, Mrs.....	10	0	0
Stevenson, W. B.....	10	0	0
The Archdeacon Moore			
The Clerk of the Rolls	5	0	0
*The High Bailiff.....	5	0	0
Trafford, Rev. W.....	5	0	0

	£.	s.	d.
Woodhouse, Mrs.....	5	0	0
Sums under 5s.....	3	17	6
Amount in Life-boat			
Boxes.....	16	4	0
Total.....	18	15	10

Donation.

Capt. Thomson.....	1	1	0
Total.....	£19	16	10

DOUGLAS BRANCH.

Patron—
His Excellency the LIEUT.-GOVERNOR.

President—
THE HIGH BAILIFF OF DOUGLAS.

Treasurer and Hon. Sec.—
THOMAS BAWDEN, Esq.

Annual Subscriptions.

	£.	s.	d.
His Excellency the			
Lieut.-Governor.....	3	3	0
Archer, R. Esq.....	5	0	0
*Bawden, T. Esq.....	5	0	0
Bowman, E.....	5	0	0
*Brown, J.....	5	0	0
Callow, T. C. Esq.....	5	0	0
Cannell, Mrs.....	1	0	0
Cannell, Mrs.....	6	0	0
Clarke, Sam. Esq.....	10	6	0
Clituch, J. W. Esq.....	5	0	0
Cleucas, Miss.....	2	0	0
Coole, James, Esq.....	5	0	0
*Corlett, Capt. T.....	5	0	0
Cowell, J. Esq.....	5	0	0
Cubbon, Joseph, Esq.....	5	0	0
Cubbon, Thos. Esq.....	5	0	0
Dutton, John.....	1	0	0
Edwards, Miss.....	5	0	0
*Gill, Capt. P.....	10	0	0
Gill, Miss.....	5	0	0
Great Laxey Mining			
Co. (Limited).....	2	0	0
Greensill, T. S. Esq.....	5	0	0
Hales, James, Esq.....	5	0	0
Hall, Mrs. Cecil.....	5	0	0
Harris, S. Esq., High			
Bailiff.....	1	0	0
Harrison, Ridgway,			
Esq.....	5	0	0
Harrison, Mrs.....	1	0	0
Ince, W.....	2	0	0
James, Mr.....	5	0	0
Johnson, Mr.....	5	0	0
Karran, J. J. Esq.....	10	0	0
Kermode and Kellett			
*Killely, Philip, Esq.....	10	0	0
*Lomas, Sam. Esq.....	10	0	0
Mackay, Miss.....	10	0	0
Moore, W. F. and Son			
1.....	10	0	0
*O'Keel, Dr.....	5	0	0
*Quine, Thos. Esq.....	10	6	0
Scottowe, W. W.....	5	0	0
Sodor and Man, Lord			
Bishop of.....	1	0	0
Seam Packet Co.....	5	0	0
Tothunter & Elliot,			
Messrs.....	5	0	0

	£.	s.	d.
Torrance and Co.			
Messrs. G.....	5	0	0
Whiteside, Hy. Esq.....	5	0	0
Wilson, Col.....	1	0	0
Wilson, Miss.....	5	0	0
Sums under 5s.....	2	4	0
Total.....	£38	16	0

RAMSEY BRANCH.

President—
His Excellency the LIEUT.-GOVERNOR.

Chairman—
Rev. G. PATON, Vicar of S. Paul's.

Honorary Secretary—
E. C. KERR, Esq.

Annual Subscriptions.

	£.	s.	d.
His Excellency the			
Lieut.-Governor.....	2	2	0
His Honor Deemster			
Dumbell.....	2	2	0
Allen and Faubman.....	5	0	0
Archdeacon the Vener-			
able.....	1	1	0
Brereton, Gen.....	5	0	0
*Brown, Capt. R.....	5	0	0
*Brown, Capt. W.....	10	0	0
Clarke, Mr. R. R.....	5	0	0
*Cleator, Mr. Robt.....	5	0	0
Cleucas, Dr.....	5	0	0
Corkill, Mr. Thos.....	5	0	0
Crennell, Mr. W.....	5	0	0
*Cruickshank, J. M.....	10	0	0
*Farrant, Mr. E. C.,			
H.K., J.P.....	1	0	0
Fletcher, Mrs.....	5	0	0
Gibb, Mrs.....	1	0	0
Gilmour, Mrs.....	5	0	0
Goldsmith & Cowley			
Isle of Man Steam			
Packet Company.....	2	2	0
Kayle, A. C., H.K.....	5	0	0
Kermode, Rev. W.....	10	0	0
Kerr, E. C.....	10	0	0
Lamothe, Mr. J. C.,			
H. B.....	5	0	0
*Lucas, Mr. K.....	1	1	0
Martin, Mr. Thos.....	5	0	0
Paterson, Mr. A. C.....	5	0	0
*Paton, Rev. G.....	1	0	0
Roose, Mr. W. D.....	5	0	0
Rudd, Mr. T. B.....	5	0	0
Scott, Mrs.....	1	0	0
Tean and Co.....	5	0	0
Thellusson, Colonel,			
J.P.....	1	0	0
*Thellusson, Mr. E.			
J.P.....	1	0	0
Williams, Mr. A.....	5	0	0
Wood, Dr.....	5	0	0
Sums under 5s.....	2	12	0
Total.....	24	0	0

Donations.

Ryder, J. Esq. Man-			
chester.....	5	0	0

	£.	s.	d.
Smith, Edward, Esq.			
Liverpool.....	1	0	0
Boat House Box.....	1	12	5
Mrs. Lucas's do.....	17	2	0
Mitre Hotel do.....	11	4	0
Swan Hotel do.....	8	1	0
Sums under 5s.....	15	11	0

Total Dons.....10 4 11

Total Subs.....24 0 0

£34 4 11

CHANNEL ISLANDS.

ALDERNEY BRANCH.

President—
T. N. BARBENSON, Esq.
Judge of Alderney.

Honorary Secretary—
NICOLAS BARBENSON, Esq.

Donations. £. s. d.

*Barbenson, T. N. Esq.....	10	0	0
*Barbenson, N. Esq.....	5	0	0
*Cottle, Mr. F. J.....	5	0	0
Le Mesurier, Rev.			
John.....	1	0	0
*Ross, Rev. Wm.....	5	0	0
Total.....	£2	5	0

GUERNSEY BRANCH.

Chairman—
Capt. P. DE SAUSMAREZ, R.N.

Honorary Secretary—
Capt. CARR, R.N.

Annual Subscriptions.

States of Guernsey.....	30	0	0
Lockett, Mrs. and			
Misses.....	5	0	0
Donation for Life-			
boat.....	1	1	0
Pillars and Collecting			
Boxes.....	2	3	5
Total.....	£38	4	5

TREATMENT OF THE APPARENTLY DROWNED.

As it is considered that the cause of Science would be greatly benefited if the results of the Treatment in cases of Apparently Drowned Persons were collected for comparison and future consideration, it is requested that Answers to the following Questions on the subject may be immediately forwarded to the ROYAL NATIONAL LIFE-BOAT INSTITUTION :—

QUERIES.	ANSWERS.
1. Date and place of occurrence ?	1.
2. Sex, name, and age of person ?	2.
3. Length of time immersed ?	3.
4. Time from rescue to first sign of life ?	4.
5. Time from rescue to recovery ?	5.
6. State of the weather, if warm or cold ?	6.
7. State of the water ?	7.
8. What mode of treatment adopted, whether the rules of the NATIONAL LIFE-BOAT INSTITUTION or those of others—if the former, whether the “Marshall Hall” system or the “Silvester” was adopted, or a combination of both ?	8.
9. If treatment successful or not ?	9.
10. Length of time persevered with ?	10.
11. How long were the efforts to restore respiration continued ?	11.
12. Was much fluid discharged from the mouth, and at what intervals ?	12.
13. Was a medical man in attendance ?	13.
14. Remarks, if any ?	14.

Date.....188

Signature.....

To the Secretary of the
ROYAL NATIONAL LIFE-BOAT INSTITUTION,
John Street, Adelphi, London, W.C.

Of.....
County of.....

*** If practicable, it would be desirable to have these Questions answered by the Medical Practitioner who attended the case.*

Royal National Life-boat Institution.

DIRECTIONS FOR RESTORING THE APPARENTLY DROWNED.

THE leading principles of the following Directions for the Restoration of the apparently Dead from Drowning are founded on those of the late Dr. MARSHALL HALL, combined with those of Dr. H. R. SILVESTER, and are the result of extensive inquiries which were made by the Institution in 1863-4 amongst Medical Men, Medical Bodies, and Coroners throughout the United Kingdom. These Directions have been extensively circulated by the Institution throughout the United Kingdom and in the Colonies. They are also in use in Her Majesty's Fleet; in the Coast-guard Service; at all the Stations of the British Army at home and abroad; in the Light Houses and Vessels of the Corporation of the Trinity House; the Metropolitan and Provincial Police Forces; the Metropolitan School Board Schools; and the St. John Ambulance Association.

I.

Send immediately for medical assistance, blankets, and dry clothing, but proceed to treat the Patient *instantly* on the spot, in the open air, with the face downward, whether on shore or afloat; exposing the face, neck, and chest to the wind, except in severe weather, and removing all tight clothing from the neck and chest, especially the braces.

The points to be aimed at are—first and *immediately*, the RESTORATION OF BREATHING; and secondly, after breathing is restored, the PROMOTION OF WARMTH AND CIRCULATION.

The efforts to *restore Breathing* must be commenced immediately and energetically, and persevered in for one or two hours, or until a medical man has pronounced that life is extinct. Efforts to promote *Warmth* and *Circulation*, beyond removing the wet clothes, and drying the skin, must not be made until the first appearance of natural breathing; for if circulation of the blood be induced before breathing has recommenced, the restoration to life will be endangered.

II.—TO RESTORE BREATHING.

TO CLEAR THE THROAT.—Place the patient on the floor or ground, with the face downwards, and one of the arms under the forehead, in which position all fluids will more readily escape by the mouth, and the tongue itself will fall forward, leaving the entrance into the windpipe free. Assist this operation by wiping and cleansing the mouth.

If satisfactory breathing commences, use the treatment described below to promote Warmth. If there be only slight breathing—or no breathing—or if the breathing fail, then—

TO EXCITE BREATHING.—Turn the patient well and instantly on the side, supporting the head, and—

1.—INSPIRATION.



Excite the nostrils with snuff, hartshorn, and smelting salts, or tickle the throat with a feather, &c., if they are at hand. Rub the chest and face warm, and dash cold water, or cold and hot water alternately on them. If there be no success, lose not a moment, but instantly—

TO IMITATE BREATHING.—Replace the patient on the face, raising and supporting the chest well on a folded coat or other article of dress.

Turn the body very gently on the side and a little beyond, and then briskly on the face, back again, repeating these measures cautiously, efficiently, and perseveringly, about fifteen times in the minute, or once every four or five seconds, occasionally varying the side.

[By placing the patient on the chest, the weight of the body forces the air out; when turned on the side, this pressure is removed, and air enters the chest.]

On each occasion that the body is replaced on the face, make uniform but efficient pressure with brisk movement, on the back between and below the shoulder-blades or bones on each side, removing the pressure immediately before turning the body on the side.

During the whole of the operations let one person attend solely to the movements of the head and of the arm placed under it.

[The first measure increases the expiration—the second commences inspiration.]

** The Result is *Respiration* or *Natural Breathing*;—and if not too late, *Life*.

2.—EXPIRATION.

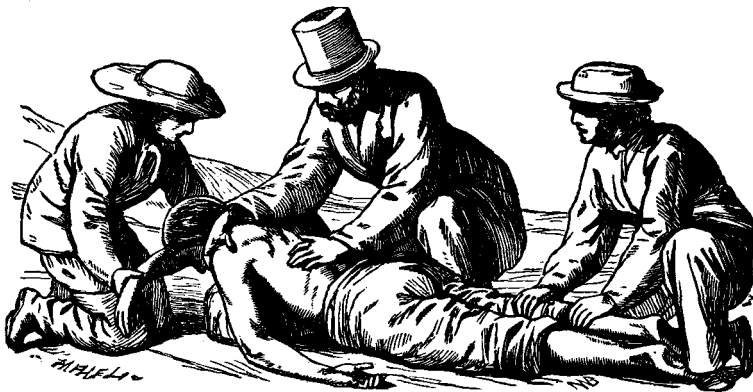

The foregoing two Illustrations show the position of the Body during the employment of Dr. Marshall Hall's Method of Inducing Respiration.

Whilst the above operations are being proceeded with, dry the hands and feet, and as soon as dry clothing or blankets can be procured, strip the body, and cover or gradually reclothe it, but taking care not to interfere with the efforts to restore breathing.

III.

Should these efforts not prove successful in the course of from two to five minutes, proceed to imitate breathing by Dr. SILVESTER'S method, as follows:—

Place the patient on the back on a flat surface, inclined a little upwards from the feet; raise and support the head and shoulders on a small firm cushion or folded article of dress placed under the shoulder-blades.

Draw forward the patient's tongue, and keep it projecting beyond the lips; an elastic band over the tongue and under the chin will answer this purpose, or a piece of string or tape may be tied round them, or by raising the lower jaw, the teeth may be made to retain the tongue in that position. Remove all tight clothing from about the neck and chest, especially the braces.

TO IMITATE THE MOVEMENTS OF BREATHING.—Standing at the patient's head, grasp the arms just above the elbows, and draw the arms gently and steadily upwards above the head, and keep them stretched upwards for two seconds. (*By this means air is drawn into the lungs.*) Then turn down the patient's arms, and press them gently and firmly for two seconds against the sides of the chest. (*By this means air is pressed out of the lungs.*)

Repeat these measures alternately, deliberately, and perseveringly, about fifteen times in a minute, until a spontaneous effort to respire is perceived, immediately upon which cease to imitate the movements of breathing, and proceed to INDUCE CIRCULATION AND WARMTH.

IV.—TREATMENT AFTER NATURAL BREATHING HAS BEEN RESTORED.

TO PROMOTE WARMTH AND CIRCULATION.—Commence rubbing the limbs upwards, with firm grasping pressure and energy, using handkerchiefs, flannels, &c. [*By this measure the blood is propelled along the veins towards the heart.*]

The friction must be continued under the blanket or over the dry clothing.

Promote the warmth of the body by the application of hot flannels, bottles, or bladders of hot water, heated bricks, &c., to the pit of the stomach, the arm-pits, between the thighs, and to the soles of the feet.

If the patient has been carried to a house after respiration has been restored, be careful to let the air play freely about the room.

On the restoration of life, a teaspoonful of warm water should be given; and then, if the power of swallowing have returned, small quantities of wine, warm brandy-and-water, or coffee should be administered. The patient should be kept in bed, and a disposition to sleep encouraged.

GENERAL OBSERVATIONS.

The above treatment should be persevered in for some hours, as it is an erroneous opinion that persons are irrecoverable because life does not soon make its appearance, persons having been restored after persevering for many hours.

APPEARANCES WHICH GENERALLY ACCOMPANY DEATH.

Breathing and the heart's action cease entirely; the eyelids are generally half closed; the pupils dilated; the tongue approaches to the under edges of the lips, and these, as well as the nostrils, are covered with a frothy mucus. Coldness and pallor of surface increase.

CAUTIONS.

Prevent unnecessary crowding of persons round the body, especially if in an apartment.

Avoid rough usage, and do not allow the body to remain on the back unless the tongue is secured.

Under no circumstances hold the body up by the feet.

On no account place the body in a warm bath unless under medical direction, and even then it should only be employed as a momentary excitant.

ROYAL NATIONAL LIFE-BOAT INSTITUTION, LONDON, 1st May, 1832.