

# THE LIFE-BOAT,

OR

## JOURNAL OF THE NATIONAL LIFE-BOAT INSTITUTION.

(ISSUED QUARTERLY.)

VOL. XI.—No. 120.]

MAY 2, 1881.

[PRICE 1s.

The ANNUAL GENERAL MEETING of the ROYAL NATIONAL LIFE-BOAT INSTITUTION, was held at Willis's Rooms, King Street, St. James's Square, on Thursday, the 17th day of March 1881. In the absence of His Grace THE DUKE OF NORTHUMBERLAND, P.C., D.C.L., *President of the Institution*, the Chair was occupied by the Right Hon. EARL PERCY, M.P. The following Report of the Committee was read by the Secretary :—

### ANNUAL REPORT.

THE ROYAL NATIONAL LIFE-BOAT INSTITUTION has now been in existence fifty-seven years, and it is a source of satisfaction to its Managing Committee to feel that at no period since its foundation has it more entirely possessed the confidence of the British public than now, as shown by the noble support it continues to receive—a support which the Committee feel would not have been afforded unless the necessity for its existence had been recognised and its system of management approved.

In truth, at no time has the need of such an Institution been more strikingly exemplified than during the past twelve months, more especially in the fierce gales and blinding snowstorms of January last, on our Eastern coast, which witnessed some of the most daring exploits of our Life-boatmen that have ever been recorded—exploits which not only testified to their humanity and courage, but to their wonderful physical endurance. In evidence of the same it will suffice to state, that on several occasions during those storms the Life-boats' crews were at sea from fifteen to twenty-four hours,

and in one instance (that of the Ramsgate Life-boat), for twenty-six hours—exposed to the full fury of the storm, in the bitterest cold, in some cases without food throughout those long hours, and with their clothes stiffened with ice.

The transactions of the Society during the year may be epitomised as follows :—

*Life-boats.*—Since the last Annual Report seventeen new Life-boats have been sent to the coast, one of them to a new Station, and sixteen to replace other boats. Sixteen boats have been provided with new carriages, and three new boathouses have been built. On the other hand one station, viz., that at Chapman's Pool in Dorsetshire, has been discontinued.

The following are the Stations to which new Life-boats have been sent :—

#### ENGLAND AND WALES.

DURHAM . . . .	Whitburn.
YORKSHIRE . . . .	Saltburn.
NORFOLK . . . .	Wells.
KENT . . . . .	Kingsgate.
SUSSEX . . . . .	Rye.
" . . . . .	Hastings.
CORNWALL . . . .	Sennen Cove.
NORTH DEVON . . .	Braunton.
CARDIGANSHIRE . .	Aberystwith.
LANCASHIRE . . . .	St. Anne's.

SCOTLAND.

ATYRSHIRE . . . . . Ardrrossan.  
 ABERDEENSHIRE . . . . . Fraserburgh.

IRELAND.

Co. DOWN . . . . . Newcastle.  
 " LOUTH . . . . . Giles' Quay.  
 " WATERFORD . . . . . Tramore.  
 " " . . . . . Ardmore.  
 " CORK . . . . . Ballycotton.

The Life-boats of the Institution have been the means of saving *five hundred and seventy-seven* lives during the past year from wrecked or endangered vessels, most of them under perilous circumstances,

when ordinary boats could not with safety have been employed. Unhappily the Committee are not able to report that these invaluable services were performed without loss of life amongst the brave men by whom they have been accomplished, no less than five of the Institution's Life-boats having capsized, with a total loss of eighteen of their crews—a number unprecedented within one year in the history of the Institution. The following is a summary of these painful evidences of the dangerous character of the work which the Institution has undertaken to supervise:—

STATION.	Date.	Number of Lives lost.	Number of Widows.	Number of Orphans.
	1880			
PORT ISAAC . . . . .	March 25	nil	nil	nil
ABERYSTWITH . . . . .	October 7	nil	nil	nil
WELLS . . . . .	" 29	11	10	30
	1881			
HARWICH . . . . .	January 18	1	1	2
YARMOUTH . . . . .	" "	6	4	22
Totals . . . . .		18	15	54

Towards the maintenance of the widows, and of their children until able to support themselves, the Institution has subscribed 1,800*l.*, to be added to the local contributions raised in their behalf.

*Shipwrecks.*—The storms of the past year were unusually violent, and most destructive to life and property.

The services of the Life-boats of the Institution during each month of the year were as follows:—

1880.	Number of Life-boat Launches.	Vessels Saved.	Lives Saved.
January . . . . .	13	2	8
February . . . . .	34	4	81
March . . . . .	17	2	46
April . . . . .	13	1	13
May, June, and July . . . . .	17	3	46
August . . . . .	12	—	13
September . . . . .	17	—	50
October . . . . .	61	7	137
November . . . . .	39	5	120
December . . . . .	22	3	63
Total . . . . .	245	27	577

In addition to these Life-boat services, 120 lives were saved from shipwreck by shore-boats and other means, making a total of 697 lives preserved in 1880, for which honorary or pecuniary rewards were made by the Institution.

Happily about 430 lives were also saved last year by means of the Rocket Apparatus belonging to the BOARD OF TRADE, which is worked so efficiently by the Coastguard and the Rocket Volunteer Brigades.

The services of the Life-boats during the heavy storms of January last were most conspicuous; they were as follows:—

<i>Annie Marie</i> , schooner, of Krageroe . . . . .	3	Lives saved.
<i>Attila</i> , ship, of Newcastle—rendered assistance.		
Berwick-upon-Tweed fishing-boats—saved two boats and crews . . . . .	9	

	Lives saved.	In the Year	No. of Lives Saved.	In the Year	No. of Lives Saved.
<i>Brazilian</i> , S.S. of Barrow—rendered assistance.		1824	124	1854	355
Brixham pilot gig—remained alongside.		1825	218	1855	406
<i>Claremont</i> , steamer, of Newcastle . . . . .	6	1826	175	1856	473
<i>Fishguard Lass</i> , smack, of Abersoch . . . . .	3	1827	163	1857	374
<i>Gyda</i> , brig, of Swensdale . . . . .	4	1828	301	1858	427
<i>Hasselo</i> , brigantine, of Haguesund . . . . .	8	1829	463	1859	499
<i>Hertha</i> , barque, of Christiansund—rendered assistance.		1830	372	1860	455
<i>Indian Chief</i> , ship, of Liverpool . . . . .	12	1831	287	1861	424
<i>Ingerid</i> , Dutch steamer . . . . .	7	1832	310	1862	574
<i>Lively</i> , fishing coble, of Redcar . . . . .	2	1833	449	1863	714
<i>Magdalen</i> and <i>Star of Peace</i> , fishing-boats . . . . .	12	1834	214	1864	698
<i>Manne de Ceil</i> , French ketch . . . . .	4	1835	364	1865	714
<i>Matilda</i> , brig, of Gothenberg—rendered assistance.		1836	225	1866	921
<i>Minnie Coles</i> , schooner, of Southampton—saved vessel and . . . . .	5	1837	272	1867	1,086
<i>Miss Beck</i> , schooner, of Carnarvon . . . . .	5	1838	456	1868	862
<i>North Wales</i> , barque, of London . . . . .	21	1839	279	1869	1,231
<i>Rosa Josephs</i> , schooner . . . . .	5	1840	353	1870	784
<i>Rosita</i> , Spanish brigantine . . . . .	11	1841	128	1871	882
<i>Ruby</i> , sloop, of Goole—assisted to save vessel and . . . . .	2	1842	276	1872	739
Staithes and Cullercoats fishing cobbles—rendered assistance.		1843	236	1873	668
Teignmouth fishing-boats—saved two boats and . . . . .	2	1844	193	1874	713
<i>Trafalgar</i> , screw steamer, of London . . . . .	23	1845	235	1875	921
<i>Visitor</i> , brig, of Whitby . . . . .	6	1846	134	1876	600
Total lives saved in January, in addition to six vessels . . . . .	150	1847	157	1877	1,048
		1848	123	1878	616
		1849	209	1879	855
		1850	470	1880	697
		1851	230	Total	27,603
		1852	773		
		1853	678		

In view of facts like these the Life-boat Institution cannot fail to maintain its hold on the support of the British public.

*Rewards.*—In the Appendix a summary is given of the cases where honorary and other rewards have been voted last year. In that period 1 Gold, 6 Silver Medals and Clasps, 14 Votes of Thanks inscribed on vellum, and 4,287 $\frac{1}{2}$  were granted for saving the lives of 697 persons by Life-boats, shore and fishing boats, and by other means, on the shores and outlying sandbanks of our coasts.

The Committee continue to devote much time and consideration to the investigation and granting of these awards; but they are rewarded by the assurance that their decisions usually give universal satisfaction, and encourage our coast population to put forth their utmost exertions to save—often at the peril of their own lives—the lives of others.

The Institution continues to receive the cordial and prompt co-operation of H.R.H. the Admiral-Superintendent of

On some of these occasions the hardships of the Life-boat men were fearful; but all were borne, and borne bravely, their only anxiety often being that their sufferings might not ultimately interfere with their timely succour to the shipwrecked sailors. The latter again were often found so benumbed by the frost, snow, and wind, as to be all but dead; and frequently they also had to be carried ashore from the Life-boat.

The number of lives saved during the fifty-seven years from the establishment of the Institution, to the end of the year 1880, either by its Life-boats or by special exertions for which it has granted rewards, is 27,603, as shown in the following Table:—

Naval Reserves, and of the officers and men of the Coastguard service, to whom the Committee tender their best thanks. And they desire especially to refer to His Royal Highness' courtesy in presenting, on their behalf, the Medals and Votes of Thanks awarded by the Institution to the crews of the Ramsgate Harbour Life-boat and steamer in acknowledgment of their bravery and long exposure, extending over twenty-six hours, on the 5th and 6th January last, in rescuing the survivors of the crew of the barque *Indian Chief* wrecked on the Long Sands.

Since the establishment of the Institution, it has expended on Life-boat Stations, and other means for saving life from shipwreck, on the coasts of the United Kingdom, upwards of 540,000*l.*, and has voted 95 Gold Medals, 931 Silver Medals, and 66,500*l.* in pecuniary rewards for saving life from shipwreck.

*Local Committees.*—The Committee again tender their best acknowledgments for the valuable and prompt co-operation afforded by the Local Branch Committees and their Honorary Secretaries, which constitutes so important and inseparable a part of the work and supervision of the Institution's numerous Life-boat Establishments, and of the collection of funds for their support.

*Finances.*—The donations, subscriptions, and dividends during the year 1880 have been 38,507*l.* 10*s.* 4*d.*, of which sum 7,550*l.* were special gifts to defray the cost of the following eight Life-boats:—

	£.	s.	d.
Blyth, No. 2—Mr. and Mrs. T. Jones			
Gibb . . . . .	900	0	0
Fleetwood—Colonel W. B. . . . .	900	0	0
Fraserburgh—Captain Gordon of Fyvie . . . . .	650	0	0
Hastings—Charles Arkcoll, Esq. . . . .	2,000	0	0
St. Anne's—James Chadwick, Esq. . . . .	1,000	0	0
Saltburn—Mrs. Ann Townsend, per Manchester Branch . . . . .	1,000	0	0
Tramore—Henry Trower, Esq., and Friends . . . . .	500	0	0
Whitburn—A Lady . . . . .	600	0	0

The Committee have likewise the gratification to acknowledge the receipt, since the last Report, of the following other special contributions:—

	£.	s.	d.
HER MAJESTY THE QUEEN (annual subscription) . . . . .	50	0	0
"A Well-Wisher and Regular Subscriber" . . . . .	50	0	0
Carswell, Morris, Esq., Pollokshields, N.B., in memory of his Wife . . . . .	15	0	0
Clevedon Life-boat Fund, per Mrs. Lavington (additional) . . . . .	39	13	4
Clothworkers, Worshipful Company of . . . . .	21	0	0
"Covent Garden" Life-boat Fund, Stewards of the, per Mr. J. Webber Cromer Church, moiety of Collection on Sunday, 10th October, per Rev. F. Fitch . . . . .	13	3	6
Dalston Junction Sunday Schools, per Mr. F. Clements . . . . .	1	1	0
Fothergill, Mrs., a gift from her late Husband . . . . .	50	0	0
Himalaya, H.M.S., Canteen Fund, per Lieut. Neate, R.N. . . . .	17	0	0
H. S. C. . . . .	100	0	0
Hovenden, F. P., Esq. . . . .	200	0	0
Hunter, the Misses Harriott and Isabella, in Memory of their late Mother. . . . .	100	0	0
In Memoriam by "T. J. M." . . . . .	40	0	0
Jumna, H.M.S., Canteen Fund, per Lieut. Kelham, R.N. . . . .	5	0	0
Land, Philemon, Esq. . . . .	100	0	0
Lytham Parish Church, collected at the Harvest Thanksgiving Service at, on 23rd September, per Rev. H. B. Hawkins . . . . .	38	16	1
Main, Hugh, Esq., H.B.M. Consulate, Alexandria, Collected by . . . . .	44	0	6
Readers of <i>The Christian</i> , per Messrs. Morgan and Scott (additional) . . . . .	6	12	0

The Institution has been informed of the following Legacies left to it during the past twelve months:—

	£.	s.	d.
Adams, Miss Eliza, Eltham (stock) . . . . .	500	0	0
Bartram, Miss Ann, Hull . . . . .	19	19	0
Best, Mrs. Eleanor, Kelston Milbrook, Southampton . . . . .	200	0	0
Bradshaw, Mrs. S. H., Reading (stock) . . . . .	1,500	0	0
Brown, Peter, Esq., Castle Douglas . . . . .	100	0	0
Cohen, Miss Matilda, Inverness Terrace . . . . .	100	0	0
Dance, Miss Ann, Kelso . . . . .	300	0	0
Deighton, Miss Sarah, Peckham Rye . . . . .	200	0	0
Dobson, Mrs. A. M., Pall Mall . . . . .	19	19	0
Ferguson, Joseph, Esq., Carlisle . . . . .	5	0	0
Forbes, W., Esq., Glasgow . . . . .	20	0	0
Hamilton, Adam, Esq., Glasgow . . . . .	19	19	0

	£.	s.	d.
Hargrave, Charles, Esq., Bayswater.	4,000	0	0
Harris, Henry, Esq., Streatham . .	1,000	0	0
Harris, Mrs. Frances, Streatham. .	1,000	0	0
Henniker, Aldborough, Esq., Catcott	100	0	0
Holt, Colonel W. J., Bangor . . .	500	0	0
Jones, Mrs. Lucy, Woburn . . .	10	0	0
Landseer, Miss Jessie, Kensington Park Gardens. . . . .	100	0	0
Luard, General John Kynaston, Gloucester Gardens . . . . .	50	0	0
Monk, Capt. John, R.N., Neston . .	500	0	0
Nicholls, Miss Charlotte, Finsbury Park (stock) . . . . .	800	0	0
Parmeter, R. W., Esq., Aylsham . .	19	19	0
Robinson, Mr. A., Whitcombe St., S.W.	0	10	0
Saunders, Miss Ellen, for Irish Life- boats . . . . .	23	18	1
Stanford, J. F., Esq., Regent's Park .	5,000	0	0
Sutherland, Mrs. Annie, Gipsy Hill .	10	0	0
Tomlinson, John, Esq., Lincoln . .	15	0	0
Wedgwood, Miss Sarah E., Down, Kent . . . . .	100	0	0
Wilson, Lieut.-Colonel J. D., Chel- tenham. . . . .	1,000	0	0
Woodward, Miss Mary, Sproughton.	1,500	0	0

There were expended during the past year 11,097*l.* 9*s.* 11*d.* on additional Life-boats, Transporting-carriages, Boat-houses, and necessary gear; 13,349*l.* 0*s.* 4*d.* in

repairs, painting, refitting, and sundry charges on Life-boat Establishments, and on the Store-yard at Poplar; and 13,130*l.* 18*s.* 8*d.* in rewards for services to shipwrecked crews, coxswains' salaries, quarterly practice of the Life-boats' crews, and other expenses; making altogether a total of 37,577*l.* 8*s.* 11*d.* against receipts amounting to 38,507*l.* 10*s.* 4*d.*

The items of receipt and expenditure are fully detailed in the financial statement, which has been audited as usual by Mr. LOVELOCK, public accountant.

In conclusion it is only necessary to state that the Institution now has 271 Life-boats under its immediate control, many of which, under the blessing of God, rendered such signal services to shipwrecked crews during the storms of last winter; and that each Life-boat station of this great and unparalleled Life-saving Fleet continues to appeal with confidence to a generous and discriminating public for sympathy and support.



## RESOLUTIONS PASSED AT THE ANNUAL MEETING FOR 1881.

THE RIGHT HON. EARL PERCY, M.P., IN THE CHAIR.

1.—Moved by the CHAIRMAN:—

1.—That the following Noblemen and Gentlemen be the Officers of the Institution for the current year:—(*Vide* next page for this list.)

2.—Moved by The Right Hon. the EARL of SELKIRK.

Seconded by Sir W. T. CHARLEY, Q.C., D.C.L., Common Serjeant of the City of London.

Supported by EDWARD BIRKBECK, Esq., M.P., *V.P.*

2.—That the Report now read be adopted, printed, and circulated.

3.—Moved by the Right Hon. the EARL of SHAFTESBURY, K.G.

Seconded by the Right Hon. W. H. SMITH, M.P., ex-First Lord of the Admiralty.

3.—That this Meeting desires to testify anew its appreciation of the great and national work of the Life-boat Institution, and of the continued success which attends its extensive and perilous operations; and therefore considers that it has, and must continue to have, the strongest claim to the support and sympathy of the Public, particularly when it is remembered that the Institution has contributed, since its first establishment, to the saving of more than twenty-seven thousand persons from Shipwreck.

4.—Moved by the Right Hon. the EARL of COURTTOWN.

Seconded by the Right Hon. LORD SUFFIELD, K.C.B.

4.—That this Meeting offers its best thanks to THOMAS CHAPMAN, Esq., F.R.S., *V.P.*, Chairman; to the Committee of Management, and to the Officers of the Institution, for their continued services and able management of the affairs of the Institution.

Also to the Honorary Local Committees and Secretaries of the several Branches, for their earnest and active co-operation with the parent Institution.

5.—Moved by Admiral Sir RICHARD COLLINSON, K.C.B., Deputy Master of the Trinity House.

Seconded by Vice-Admiral AUGUSTUS PHILLIMORE, late Admiral Superintendent of Naval Reserves.

Supported by Colonel FITZROY CLAYTON.

5.—That this Meeting acknowledges the brave spirit which continues to animate the Coxswains and Crews of the Life-boats, which was never more conspicuous than during the storms of October and January last—when they were instrumental in saving two hundred and eighty-seven Lives—being frequently subjected to most severe and prolonged exposure in the performance of their dangerous services.

6.—Moved by Sir EDWARD G. L. PERBOTT, Bart., *V.P.*

Seconded by GEORGE LYALL, Esq., *V.P.*

6.—That the best thanks of this Meeting be given to the Right Hon. EARL PERCY, M.P., for so ably presiding over this fifty-seventh Annual Meeting of the ROYAL NATIONAL LIFE-BOAT INSTITUTION, and for the kind interest he takes in its welfare.



# ROYAL NATIONAL LIFE-BOAT INSTITUTION.

For the Preservation of Life from Shipwreck.

(Incorporated by Royal Charter.)

FOUNDED IN 1824.—SUPPORTED SOLELY BY VOLUNTARY CONTRIBUTIONS.

## PATRONESS.

Her Most Gracious Majesty the Queen.

## VICE-PATRON.

HIS ROYAL HIGHNESS THE PRINCE OF WALES, K.G.

## PRESIDENT.

HIS GRACE THE DUKE OF NORTHUMBERLAND, P.C., D.C.L.

## VICE-PRESIDENTS.

His Grace the ARCHBISHOP of CANTERBURY, F.R.S.  
His Grace the DUKE of ARGYLL, K.T., F.R.S.  
The Most Noble the MARQUIS of CHOLMONDELEY.  
The Right Hon. the EARL of LEICESTER, K.G.  
The Right Hon. LORD HATHERLEY, F.R.S., late Lord Chancellor of England.  
The Right Hon. LORD ROBERTS.  
Admiral Sir GEORGE BROKE-MIDDLETON, Bart., C.B.

Sir EDWARD G. L. PERROTT, Bart.  
THOMAS CHAPMAN, Esq., F.R.S.  
EDWARD BIRKBECK, Esq., M.P.  
Colonel TALBOT CLIFTON.  
W. H. HARTON, Esq.  
GEORGE LYALL, Esq., late Governor of the Bank of England.  
T. B. POTTER, Esq., M.P.  
ROBERT WHITWORTH, Esq.

## COMMITTEE OF MANAGEMENT.

THOMAS CHAPMAN, Esq., F.R.S., V.P., *Chairman.*  
GEORGE LYALL, Esq., V.P., *Deputy Chairman.*

Rear-Admiral H.R.H. THE DUKE OF EDINBURGH, K.G.,  
Admiral Superintendent of Naval Reserves.  
EDWARD BIRKBECK, Esq., M.P., V.P.  
THE MARQUIS OF CHOLMONDELEY, V.P.  
L. T. CLAVE, Esq., F.R.G.S.  
Sir WILLIAM R. CLAYTON, Bart.  
Colonel FITZ-ROY CLAYTON.  
Admiral Sir RICHARD COLLINSON, K.C.B., Deputy Master of the Trinity House.  
Colonel the Hon. G. F. ORCHTON, [to the Admiralty.  
Capt. Sir F. J. O. EVANS, R.N., K.C.B., F.R.S., Hydrographer  
The Right Hon. G. J. GOSCHEN, M.P.  
JOHN GRIFFITH, Esq.  
WILLIAM H. HARTON, Esq., V.P.  
The Right Hon. JOHN GELLIBRAND HUBBARD, M.P.  
Admiral J. B. B. MCHARDY.

EUGENE F. NOEL, Esq.  
Sir FRANCIS BOYD OUTRAM, Bart.  
LORD ALFRED H. PAGET.  
Colonel GEORGE PALMER.  
GEORGE PALMER, Esq.  
The Right Hon. EARL PERCY, M.P.  
Sir EDWARD G. L. PERROTT, Bart., V.P.  
Vice-Admiral AUGUSTUS PHILLIMORE.  
The Hon. T. C. AGAR-BOBARTS, M.P.  
Admiral A. P. RYDER, Commander-in-Chief at Portsmouth.  
Admiral of the Fleet Sir GEORGE B. SARTORIUS, G.C.B.  
Major-General TULLOCH, R.A., C.B.  
The Right Hon. the EARL WALDEGRAVE.  
Vice-Admiral J. B. WARD.  
T. M. WEGURLIN, Esq.

## TRUSTEES.

THOMAS CHAPMAN, Esq., F.R.S., V.P.

GEORGE LYALL, Esq., V.P.

EDWARD BIRKBECK, Esq., M.P., V.P.

**BANKERS**—Messrs. COUTTS and Co., 59 Strand.

**TREASURER**—HUGH LINDSAY ANTROBUS, Esq.

**SECRETARY**—RICHARD LEWIS, of the Inner Temple, Esq., Barrister-at-Law.

**CHIEF LIFE-BOAT INSPECTOR**—Vice-Admiral J. B. WARD.

## DISTRICT LIFE-BOAT INSPECTORS.

Captain the Hon. H. W. CHETWIND, R.N.—London.  
Commander ST. VINCENT NEFEAN, R.N.—Hull.

Commander C. LAPRIMAUDAIE, R.N.—Bristol.  
Lieutenant GERALD E. MALTBY, R.N.—Edinburgh.  
Lieutenant H. T. G. TIPPING, R.N.—Dublin.

**ARCHITECT**—C. H. COOKE, Esq., F.S.A.

**SOLICITORS**—Messrs. CLAYTON, SONS, and FARGUS.

**AUDITOR**—SAMUEL LOVELOCK, Esq., Public Accountant, F.C.A.

The object of this Institution, as declared in its title, and in its Charter of Incorporation, is to afford assistance to every shipwrecked person around the Coasts of the United Kingdom.

The chief means by which the Society hopes to carry this object into effect are:—

To build, station, and maintain in repair, Life-boats of the most perfect description; to furnish them with all necessary Appurtenances, including Houses to preserve them in, and Carriages for their conveyance to the spots where their Services are called for; and further, to provide, through the instrumentality of Local Committees, for their proper Management and the occasional Exercise of their Crews.

To confer Honorary Rewards in the form of Medals and Votes of Thanks, and also to make liberal grants of money to all persons who, at the risk of their own lives, save, or attempt to save, those of others on board vessels wrecked, or in distress, upon any part of the Coasts of the United Kingdom.

As an index of the necessity for the provision of such a machinery as the above, it may be stated that the average loss of lives from shipwreck annually on the shores of the United Kingdom is 700.

Dr.

## INCOME AND EXPENDITURE.—1st Jan. to 31st Dec. 1880.

Cr.

	£.	s.	d.	£.	s.	d.
To LIFE-BOATS, viz.:						
Aberystwith . . . . .	397	0	0			
Ardrossan . . . . .	363	0	0			
Braunton . . . . .	363	0	0			
Caister No. 1 (Repairs) . . . . .	154	8	4			
Fraserburgh . . . . .	363	0	0			
Hastings . . . . .	363	0	0			
Kingsgate . . . . .	265	0	0			
Newcastle (Dundrum) . . . . .	363	0	0			
Rye . . . . .	363	0	0			
St. Anne's . . . . .	363	0	0			
Saltburn . . . . .	363	0	0			
Sennen Cove (Land's End) . . . . .	363	0	0			
Whitburn . . . . .	363	0	0			
Spare Life-boat . . . . .	363	0	0			
Alterations and repairs of Life- boats and Sundry Expenses on the 271 Life-boat Stations	7,740	4	4			
Salaries to Inspectors of Life- boats . . . . .	2,339	0	1			
Travelling Expenses, &c., of ditto . . . . .	1,273	0	3			
				16,161	13	0

## To LIFE-BOAT HOUSES AND SLIPWAYS, viz.:

Brighstone Grange . . . . .	190	0	0			
Cardigan . . . . .	210	0	0			
Fishguard (balance) . . . . .	86	18	0			
Fleetwood (ditto) . . . . .	122	9	0			
Gorleston . . . . .	329	0	0			
Kimeridge . . . . .	165	0	0			
Newcastle (Dundrum) . . . . .	413	0	0			
Penmon . . . . .	700	0	0			
Plymouth . . . . .	325	0	0			
St. Anne's . . . . .	606	0	0			
Sunderland . . . . .	101	0	0			
Tramore . . . . .	117	0	0			
Alterations and repairs of Life- boat Houses, &c. . . . .	529	4	7			
				3,894	11	7

## To LIFE-BOAT CARRIAGES, viz.:

Aberystwith . . . . .	129	0	0			
Braunton . . . . .	129	0	0			
Fraserburgh . . . . .	115	10	0			
Hastings . . . . .	131	0	0			
Kingsgate . . . . .	123	5	0			
Newcastle (Dundrum) . . . . .	134	0	0			
Rye . . . . .	129	0	0			
St. Anne's . . . . .	131	0	0			
Saltburn . . . . .	129	0	0			
Theddlethorpe . . . . .	131	0	0			
Whitburn . . . . .	129	0	0			
Alterations and Repairs of Life-boat Carriages, &c. . . . .	313	0	0			
				1,723	15	0

Carried forward . 21,779 19 7

	£.	s.	d.	£.	s.	d.
By Donations .12,708	15	5				
By Subscrip- tions . . . . .	3,365	9	0			
				16,074	4	5

By Special Gifts, amounting  
to £7,550, for the follow-  
ing Life-boats:—

Blyth, No. 2.—Mr. and Mrs. T. Jones Gibb . . . . .	900	0	0			
Fleetwood—Colonel W. B. . . . .	900	0	0			
Fraserburgh—Captain Gor- don of Fyvie . . . . .	650	0	0			
Hastings—Charles Arkcoll, Esq. . . . .	2,000	0	0			

St. Anne's—James Chad-  
wick, Esq. . . . . 1,000 0 0Saltburn—Mrs. Ann Town-  
end, per Manchester  
Branch . . . . . 1,000 0 0Tramore—Henry Trower,  
Esq. and Friends . . . . . 500 0 0

Whitburn — A Lady . . . . . 600 0 0

By Contributions from  
Branches . . . . . 5,616 8 7

By Dividends and Interest 9,266 17 4

Carried forward £38,507 10 4



Dr. INCOME AND EXPENDITURE.—1st Jan. to 31st Dec. 1880—continued. Cr.

	£.	s.	d.		£.	s.	d.
	Brought forward			£21,779	19	7	
To Rewards, Medals, &c., for saving Life,							
Coxswains' Salaries, and Life-boat Crews,							
for exercising the Boats quarterly . . .	10,061	6	7				
Life-boat Stores and Life-belts . . . . .	1,511	19	7				
Life-boat Store Yard and depôt at Poplar . . .	1,154	11	1				
Printing <i>Life-boat Journal</i> , Annual Report,							
Stationery, Books, &c. . . . .	287	4	5				
Advertisements, Postages, and Parcels . . .	342	8	0				
Salaries to Secretary and Clerks . . . . .	1,777	0	4				
Auditors' Fee . . . . .	52	10	0				
Law Expenses on Leases and Bequests . . .	117	16	0				
Repairs and Alterations at the House of the							
Institution, Rent, Taxes, Housekeeper,							
Fuel, &c. . . . .	457	14	6				
Annual Meeting, Messengers, &c. . . . .	34	18	10				
Balance carried forward to Balance Sheet . .	930	1	5				
	<u>£38,507</u>						
		10	4				
					<u>£38,507 10 4</u>		

Examined and found correct, 8th January, 1881.

(Signed) SAMUEL LOVELOCK,  
Auditor.



No.	STATION.	Length.	Breadth.	No. of Oars.	When Stationed or Named.
<b>ENGLAND.</b>					
		Ft. In.	Ft. In.		
1	NORTHUMBERLAND BERWICK-ON-TWEED - - -	33 0	8 0	10	1864
2	HOLY ISLAND—No. 1 - - -	32 0	7 4	10	1865
3	" " No. 2 - - -	32 0	7 4	10	1868
4	NORTH SUNDERLAND - - -	33 0	8 0	10	1865
5	BOULMER - - -	33 0	8 0	10	1866
6	ALNMOUTH - - -	32 0	7 5	10	1865
7	HAUXLEY - - -	34 0	8 4	10	1866
8	CRESSWELL - - -	30 0	8 0	8	1875
9	NEWBIGGIN - - -	34 0	8 4	10	1866
10	BLYTH—No. 1 - - -	33 0	8 0	10	1867
11	" " No. 2 - - -	30 0	8 0	8	1880
12	CULLERCOATS - - -	33 0	8 0	10	1866
13	TYNEMOUTH—No. 1 - - -	37 0	9 0	12	1875
14	" " No. 2 - - -	33 0	8 1	10	1872
15	DURHAM - - - WHITBURN - - -	34 0	8 0	10	1881
16	SUNDERLAND—No. 1 - - -	30 0	8 0	8	1876
17	" " No. 2 - - -	30 3	8 7	10	1866
18	" " No. 3 - - -	33 0	8 2	10	1865
19	" " No. 4 - - -	36 0	9 0	12	1872
20	SEAHAM - - -	33 0	8 6	10	1870
21	HARTLEPOOL—No. 1 - - -	33 0	8 6	10	1876
22	" " No. 2 - - -	35 0	9 0	10	1876
23	" " No. 3 - - -	33 0	8 6	10	1878
24	WEST HARTLEPOOL—No. 1 - - -	33 0	8 6	10	1869
25	" " No. 2 - - -	34 0	8 9	10	1874
26	SEATON CAREW - - -	33 0	8 6	10	1873
27	YORKSHIRE - - - MIDDLESBOROUGH - - -	33 0	8 0	10	1864
28	REDCAR - - -	36 0	9 6	10	1867
29	SALTBURN - - -	34 0	8 3	10	1880
30	STAITHES - - -	32 0	8 0	10	1875
31	RUNSWICK - - -	34 0	8 0	10	1880
32	UPGANG - - -	32 0	7 6	10	1879
33	WHITBY—No. 1 - - -	32 0	7 7	10	1870
34	" " No. 2 - - -	32 0	7 6	10	1879
35	ROBIN HOOD'S BAY - - -	32 0	8 0	10	1881
36	SCARBOROUGH - - -	35 0	9 0	10	1872
37	FILEY - - -	33 0	8 0	10	1863
38	FLAMBOROUGH—No. 1 - - -	33 0	8 6	10	1871
39	" " No. 2 - - -	33 0	8 0	10	1879
40	BRIDLINGTON - - -	34 0	7 7	10	1871
41	HORNSEA - - -	32 0	7 6	10	1875
42	WITHERNSEA - - -	30 0	8 0	8	1878
43	LINCOLNSHIRE - - - CLEETHORPES - - -	33 0	8 6	10	1868
44	DONNA NOOK - - -	34 0	8 0	10	1878
45	THEDDLETHORPE - - -	30 0	8 11	12	1871
46	SUTTON - - -	30 0	8 0	8	1876
47	CHAPEL - - -	30 0	8 0	8	1876
48	SKEGNESS - - -	33 0	8 0	10	1874
49	NORFOLK - - - HUNSTANTON - - -	32 0	7 6	10	1867
50	BRANCASTER - - -	33 0	8 0	10	1879
51	WELLS - - -	37 0	9 0	12	1881
52	BLAKENEY - - -	37 0	9 5	12	1873
53	SHERINGHAM - - -	36 0	9 0	12	1867
54	CROMER - - -	34 0	8 8	10	1868
55	MUNDESLEY - - -	33 0	8 3	10	1866
56	BACTON - - -	33 0	8 1	10	1865
57	HASBOROUGH - - -	32 0	7 6	10	1866
58	PALLING—No. 1 - - -	36 0	8 0	12	1864
59	" " No. 2 - - -	40 0	11 6	14	1870
60	WINTERTON—No. 1 - - -	32 0	10 0	12	1878
61	" " No. 2 - - -	36 0	10 6	14	1879
62	CAISTER—No. 1 - - -	42 0	11 6	14	1878
63	" " No. 2 - - -	33 7	10 0	12	1875

No.	NAME OF BOAT AND DONOR.	NAME AND ADDRESS OF HONORARY SECRETARY.
1	<i>Albert Victor</i> —Manchester Branch . . . . .	B. G. Sinclair, Esq., Berwick-on-Tweed.
2	<i>Grace Darling</i> —The late Lady Watson . . . . .	} Rev. W. W. F. Keeling, Holy Island, Beal, R.S.O.
3	<i>Bombay</i> —The late Mr. J. G., and Mrs. Frith . . . . .	
4	<i>Joseph Anstice</i> —The late Mrs. Anstice . . . . .	
5	<i>Robin Hood of Nottingham</i> —Nottingham . . . . .	
6	<i>John Atkinson</i> —Miss Wardell . . . . .	
7	<i>Algernon &amp; Eleanor</i> —Her Grace the Dowager Duchess of Northumberland . . . . .	H. Smith, Esq., Alnmouth, R.S.O., Northumberland.
8	<i>Old Potter</i> —Thos. Hackwood, Esq. . . . .	Rev. A. O. Medd, Amble, Acklington.
9	<i>W. Hopkinson, of Brighouse</i> —The late Miss Hopkinson . . . . .	Mr. John Robson, Cresswell, Morpeth.
10	<i>Salford</i> —Manchester Branch . . . . .	Rev. Edward Shortt, M.A., Woodhorn Vicarage, Morpeth.
11	<i>Tom and Marion</i> —Mr. & Mrs. T. Jones Gibb . . . . .	Mr. James Darling, Blyth, Northumberland.
12	<i>Palmerston</i> —Peter Reid, Esq. . . . .	Major Adamson, Cullercoats, Newcastle-on-Tyne.
13	<i>Charles Dibdin</i> —Civil Service No. 2 Fund . . . . .	P. J. Messent, Esq., C.E., Tynemouth, North Shields.
14	<i>Forester</i> —A. O. of Foresters . . . . .	W. H. Williamson, Esq., Whitburn, nr. Sunderland.
15	<i>William and Charles</i> —A Lady . . . . .	} William Milburn, Esq., 5 Nile Street, Sunderland.
16	<i>Good Templar</i> —That Life-boat Fund . . . . .	
17	Royal National Life-boat Institution . . . . .	
18	<i>Florence Nightingale</i> —Town of Derby . . . . .	
19	<i>John Foulston</i> —The late Mrs. Foulston . . . . .	
20	<i>Sisters Carter, of Harrogate</i> —Misses Carter . . . . .	William Warham, Esq., Londonderry Offices, Seaham, [R.S.O.]
21	<i>Charles Mather</i> —Mrs. Annie Mather . . . . .	} S. Herbert Belk, Esq., Hartlepool.
22	<i>Charles Ingleby</i> —Trust Fund, per G. P. Wragge, Esq. . . . .	
23	<i>John Clay Barlow</i> —Miss Barlow . . . . .	
24	<i>Rochdale</i> —Collected in Rochdale . . . . .	
25	<i>Foresters' Pride</i> —A. O. of Foresters . . . . .	
26	<i>Job Hindley</i> —The late Mr. Hindley, per Manchester Branch . . . . .	C. A. Baker, Esq., North Eastern Railway, West Hartlepool.
27	<i>Crossley</i> —Messrs. J. Crossley and Sons . . . . .	Rev. John Lawson, M.A., Seaton Carew, West Hartlepool.
28	<i>Burton-on-Trent</i> —Town of Burton-on-Trent . . . . .	M. Murray, Esq., Exchange Place, Middlesborough.
29	<i>Charles and Ann</i> —Mrs. Townend, per Manchester Branch . . . . .	Captain Chaytor, Redcar.
30	<i>Hannah Somerset</i> —Mrs. Yates' Legacy . . . . .	Mr. T. G. Pearson, Saltburn-by-the-Sea.
31	<i>Margaret and Edward</i> —A Lady . . . . .	} Dr. J. V. Laverick, Hinderwell, Staithes.
32	<i>Joseph Sykes</i> —Mrs. A. E. Sykes' Legacy . . . . .	
33	<i>Robert Whitworth</i> —Manchester Branch . . . . .	
34	<i>Harriott Forteath</i> —Late Mrs. Forteath . . . . .	
35	<i>Ephraim and Hannah Fox</i> —Mr. and Mrs. Fox's Children . . . . .	
36	<i>Lady Leigh</i> —Warwickshire Freemasons . . . . .	E. W. Chapman, Esq., Whitby.
37	<i>Hollon</i> —Mr. and Mrs. Hollon . . . . .	Mr. Robert Gibson, Harbour Master, Whitby.
38	<i>Gertrude</i> —Legacy of John Beckett, Esq. . . . .	} Rev. R. Jermyn Cooper, Fylingdales Vicarage, Whitby.
39	Royal National Life-boat Institution . . . . .	
40	<i>John Abbott</i> —Mr. Abbott's Legacy . . . . .	
41	<i>Ellen and Margaret of Settle</i> —Settle Fund . . . . .	
42	<i>Admiral Rous</i> —That Life-boat Fund . . . . .	
43	<i>Manchester Unity</i> —I. O. of Odd Fels. (M.U.) . . . . .	John Stephenson, Esq., Scarborough.
44	<i>Richard</i> —Miss Dixon . . . . .	A. E. Hick, Esq., St. Thomas Street, Scarborough.
45	<i>Dorinda and Barbara</i> —Mrs. B. Caslake . . . . .	W. Hanks, Esq., Filey, R.S.O., Yorkshire.
46	<i>Caroline</i> —N. R. . . . .	} Rev. J. F. Wilkinson, M.A., Flamborough, Hull.
47	<i>Land-seer</i> —Miss Landseer . . . . .	
48	<i>Herbert Ingram</i> —Mr. Ingram's Friends . . . . .	
49	<i>Licensed Victualler</i> —Licensed Victuallers . . . . .	
50	<i>Lily Bird</i> —Samuel Bird, Esq. . . . .	
51	Royal National Life-boat Institution . . . . .	Alfred West, Esq., Garrison St., Bridlington Quay.
52	<i>Hettie</i> —A Friend at Bradford . . . . .	Mr. George Milner, Southgate, Hornsea, near Hull.
53	<i>Duncan</i> —Mrs. Fraser . . . . .	Horatio H. Ayre, Esq., Withernsea, near Hull.
54	<i>Benjamin Bond Cabell</i> . . . . .	F. Dawson, Esq., Victoria Chambers, Grimsby.
55	<i>Grocers</i> —Grocers of England . . . . .	Mr. Gilbert Houlden, North Somercotes, Grimsby.
56	<i>Recompense</i> —A Lady, per T. J. Gibb, Esq. . . . .	Rev. L. D. Kennedy, M.A., Theddlethorpe, Louth.
57	<i>Huddersfield</i> —Huddersfield . . . . .	Lieut. E. J. V. Pritchard, R.N., Coastg., Mablethorpe, R. Bradshaw, Esq., Hogsthorpe, Alford. [Alford.]
58	<i>Parsee</i> —Messrs. Cama & Co. . . . .	William Everington, Esq. [Skegness, R.S.O.,
59	<i>British Workman</i> —That Magazine . . . . .	Mr. W. H. Colbeck, Ch. Officer, C. G. [Lincolnshire.]
60	<i>Edward Birkbeck</i> —R. N. L. B. Institution . . . . .	Rev. A. Waller, M.A., Hunstanton, Norfolk. [Lynn.]
61	<i>Husband</i> —Late Mrs. Davis . . . . .	Rev. E. K. Kerslake, M.A., Deepdale Rectory, King's Lynn.
62	<i>Covent Garden</i> —That Life-boat Fund . . . . .	E. Dewing, Esq., Burnham Overy, King's Lynn.
63	<i>Godsend</i> —Lady Bourchier . . . . .	Rev. J. R. Pilling, Wells, Norfolk.
		Rev. R. H. Tillard, M.A., Blakeney, Dereham.
		Rev. Lethbridge Moore, Sheringham, Cromer.
		W. G. Sandford, Esq., Cromer.
		Mr. G. Gordon, Mundesley, North Walsham, Norfolk.
		The Hon. Sec., Bacton, North Walsham, Norfolk.
		Rev. J. Slater, M.A., Hasborough, Norwich.
		Mr. E. French, Chief Officer C. G., Palling, Norwich.
		Rev. Wm. Green, M.A., Winterton, Great Yarmouth.
		Rev. E. G. H. Murrell, Caister, Great Yarmouth.

No.	STATION.	Length.		Breadth.		No. of Oars.	When Stationed or Named.
		Ft.	in.	Ft.	in.		
64	NORFOLK - - - YARMOUTH—No. 1 - - -	42	3	11	9	12	1861
65	" " " " No. 2 - - -	28	0	9	0	10	1875
66	SUFFOLK - - - GORLESTON - - -	30	0	10	0	10	1870
67	" " " " LOWESTOFT—No. 1 - - -	44	0	12	3	14	1876
68	" " " " " " " " No. 2 - - -	32	0	10	0	12	1870
69	" " " " PAKEFIELD—No. 1 - - -	46	3	12	0	14	1872
70	" " " " " " " " No. 2 - - -	30	0	9	0	12	1871
71	" " " " KESSINGLAND—No. 1 - - -	42	0	12	0	14	1870
72	" " " " " " " " No. 2 - - -	32	0	10	0	12	1879
73	" " " " SOUTHWOLD—No. 1 - - -	40	0	11	6	12	1855
74	" " " " " " " " No. 2 - - -	33	0	8	0	10	1866
75	" " " " DUNWICH - - -	30	0	7	8	8	1873
76	" " " " THORPENESS - - -	37	0	9	4	12	1873
77	" " " " ALDBOROUGH - - -	40	0	10	5	12	1870
78	ESSEX - - - HARWICH - - -	35	0	9	0	10	1876
79	" " " " CLACTON-ON-SEA - - -	34	0	8	3	10	1873
80	" " " " SOUTHEND - - -	25	0	7	3	8	1879
81	KENT - - - MARGATE - - -	34	0	8	3	10	1866
82	" " " " KINGSGATE - - -	28	0	7	3	8	1880
83	" " " " BROADSTAIRS - - -	36	0	9	2	12	1868
84	" " " " RAMSGATE - - -	44	0	11	1	12	1877
85	" " " " NORTH DEAL - - -	40	0	10	0	12	1881
86	" " " " WALMER - - -	36	0	9	4	12	1871
87	" " " " KINGSDOWNE - - -	36	0	9	0	12	1871
88	" " " " DOVER - - -	35	0	9	0	10	1873
89	" " " " " " " " HYTHE - - -	35	0	9	0	10	1876
90	" " " " " " " " NEW ROMNEY - - -	32	0	7	6	10	1871
91	" " " " " " " " LYDD, DUNGENESS - - -	33	0	7	9	10	1874
92	SUSSEX - - - RYE - - -	34	0	7	9	10	1881
93	" " " " " " " " WINCHELSEA - - -	33	0	8	2	10	1867
94	" " " " " " " " HASTINGS - - -	34	0	8	3	10	1880
95	" " " " " " " " EASTBOURNE - - -	34	0	8	3	10	1880
96	" " " " " " " " NEWHAVEN - - -	37	0	8	2	12	1877
97	" " " " " " " " BRIGHTON, - - -	32	0	7	8	10	1874
98	" " " " " " " " SHOREHAM - - -	33	0	8	1	10	1865
99	" " " " " " " " WORTHING - - -	32	0	7	6	10	1880
100	" " " " " " " " SELSEY - - -	32	0	7	6	10	1865
101	" " " " " " " " CHICHESTER HARBOUR - - -	32	0	7	5	10	1873
102	HAMPSHIRE - - - HAYLING ISLAND - - -	32	0	7	5	10	1865
103	ISLE OF WIGHT - - - BEMBRIDGE - - -	32	0	7	7	10	1867
104	" " " " " " " " BRIGHSTONE GRANGE - - -	34	0	8	0	10	1880
105	" " " " " " " " BROOKE - - -	32	0	7	6	10	1867
106	ALDERNEY - - - ST. ANNE - - -	33	0	8	6	10	1869
107	GUERNSEY - - - ST. PETER'S - - -	32	0	7	8	10	1875
108	DORSET - - - POOLE - - -	34	0	8	3	10	1880
109	" " " " " " " " SWANAGE - - -	35	0	9	0	10	1875
110	" " " " " " " " KIMBRIDGE - - -	32	0	7	6	10	1881
111	" " " " " " " " WEYMOUTH - - -	33	0	8	6	10	1869
112	" " " " " " " " LYME REGIS - - -	33	0	8	0	10	1866
113	SOUTH DEVON - - - SIDMOUTH - - -	33	0	8	6	10	1869
114	" " " " " " " " EXMOUTH - - -	32	0	7	6	10	1867
115	" " " " " " " " TEIGNMOUTH - - -	32	0	7	4	10	1880
116	" " " " " " " " TORQUAY - - -	33	0	8	6	10	1876
117	" " " " " " " " BRILHAM - - -	34	0	8	6	10	1866
118	" " " " " " " " DARTMOUTH - - -	33	0	8	6	10	1878
119	" " " " " " " " SALCOMBE - - -	33	0	8	6	10	1869
120	" " " " " " " " HOPE COVE - - -	35	0	9	0	10	1878
121	" " " " " " " " YEALM RIVER - - -	35	0	9	0	10	1878
122	" " " " " " " " PLYMOUTH - - -	34	0	7	9	10	1873

No.	NAME OF BOAT AND DONOR.	NAME AND ADDRESS OF HONORARY SECRETARY.
64	<i>Mark Lane</i> —London Corn Exchange . . . . .	Mr. J. Petts, 23 Queen's Road, Great Yarmouth.
65	<i>Abraham Thomas</i> —M. B. . . . .	
66	<i>Leicester</i> —Town of Leicester . . . . .	J. P. Baumgartner, Esq., Gorleston, Great Yarmouth.
67	<i>Samuel Plimsoll</i> —Plimsoll Life-boat Funds	Frederick Morse, Esq., Lowestoft.
68	<i>George</i> —Miss Leicester . . . . .	
69	<i>The Two Sisters, Mary and Hannah</i> —The late Mr. Thomas Parkin . . . . .	Mr. J. Henderson, Lowestoft.
70	<i>Henry Burford, R.N.</i> —Legacy of J. L. . . . .	W. F. Larkins, Esq., Holm View, near Lowestoft.
71	<i>Bolton</i> —Town of Bolton . . . . . [Fund	Wm. Warman, Esq., Pakefield, Lowestoft.
72	<i>St. Michael's, Paddington</i> —That Life-boat	
73	<i>London Coal Exchange</i> —London Coal Exchange . . . . .	Mr. C. Rashley, Chief Officer of C. G <sup>d</sup> ., Kessingland, Wangford.
74	<i>Quiver No. 2</i> —Quiver Magazine . . . . .	Mr. J. Sinclair, East Cliff, Southwold, Wangford.
75	<i>John Keble</i> —Rev. T. Keble . . . . .	Rev. J. F. Noott, Frostenden Hermitage, Wangford.
76	<i>Ipswich</i> —Town of Ipswich . . . . .	
77	<i>George Hounsfeld</i> —Mrs. Hounsfeld . . . . .	James Osborne, Esq., Aldborough, Suffolk.
78	<i>Springwell</i> —Miss Burmester . . . . .	Lucas T. Cobbold, Esq., Harwich.
79	<i>Albert Edward</i> —Freemasons of England . . . . .	Mr. F. Mann, Clacton-on-Sea, Colchester.
80	<i>Boys of England and Edwin J. Brett</i> —That Life-boat Fund . . . . .	Thomas Smith, Esq., 11 Royal Terr., Southend, Essex.
81	<i>Quiver No. 1</i> —Quiver Magazine . . . . .	E. Isaacson, Esq., Margate.
82	<i>Thomas Chapman</i> —R. N. L. B. Institution.	Capt. Isacke, North Foreland Lodge, Broadstairs.
83	<i>Samuel Morrison Collins</i> —A Lady . . . . .	Mr. Thomas Jackson, H.M. Coastguard, Broadstairs.
84	<i>Bradford</i> —Town of Bradford . . . . .	Capt. Richard Braine, Harbour Master, Ramsgate.
85	<i>Mary Somerville</i> —Miss Somerville's legacy	Rev. T. S. Treanor, Upper Deal.
86	<i>Centurion</i> —A Friend . . . . .	
87	<i>Sabrina</i> —Mr. and Mrs. Ferguson . . . . .	Mr. W. Bailey, H.M. C. G <sup>d</sup> ., Kingsdowne, near Dover.
88	<i>Henry William Pickersgill, R.A.</i> —His Legacy . . . . .	Lieut.-General Bruce, C.B., 1 East Cliff, Dover.
89	<i>Mayer de Rothschild</i> —Lady Rosebery . . . . .	George Wilks, Esq., Hythe, Kent.
90	<i>Dr. Hatton</i> —Mrs. Hatton . . . . .	Henry Stringer, Esq., New Romney, S.O., Kent.
91	<i>David Hulett</i> —D. Hulett, Esq. . . . .	E. T. Bass, Esq., J.P., Lydd, New Romney, S.O., Kent.
92	Royal National Life-boat Institution . . . . .	Henry Burra, Esq., Rye, S.O., Sussex.
93	<i>Storm Sprite</i> —Solicitors and Proctors . . . . .	
94	<i>Charles Arkcoll</i> —Charles Arkcoll, Esq. . . . .	Mr. G. Hutchings, 7 Wellington Place, Hastings.
95	<i>William and Mary</i> —Friends at Manchester	Mr. H. M. Emary, 64 Pevensy Road, Eastbourne.
96	<i>Michael Henry</i> —Jewish Scholars' Life-boat Fund . . . . .	The Hon. Sec., Newhaven, S.O., Sussex.
97	<i>Robert Raikes</i> —London Sunday Schools . . . . .	W. R. Wood, Jun., Esq., 124 Western Road, Brighton.
98	<i>Ramonet</i> —Miss Robertson . . . . .	Thos. Fuller, Esq. M.D., Longcroft, Shoreham.
99	<i>Henry Harris</i> —Mr. Harris' Legacy . . . . .	Melvill Green, Esq., Worthing.
100	<i>Four Sisters</i> —Misses Hallam and Mrs. Birt	Rev. H. Mitchell, M.A., Bosham, near Chichester.
101	<i>Undaunted</i> —The late Richard Thornton West, Esq., and Mrs. West . . . . .	Rev. H. Chas. Foster, Selsey Rectory, near Chichester.
102	<i>Olive Leaf</i> —Messrs. Leaf, Sons, and Co. . . . .	J. Gorham, Esq., Cackham, Chichester.
103	<i>City of Worcester</i> . . . . .	Wm. Payne, Esq., National Provincial Bank of England, Portsea, Hants.
104	<i>Worcester Cadet</i> —That Life-boat Fund . . . . .	Admiral Wilmshurst, Bembridge, Brading, R.S.O., I.W.
105	<i>George and Anne</i> —Mr. and Miss Marten . . . . .	Rev. W. E. Heygate, M.A., Brighthelm, Newport, I.W.
106	<i>Mary and Victoria</i> —The Earl of Strafford . . . . .	Rev. Reginald Broughton, Shorwell, Newport, I.W.
107	<i>John Lockett</i> —Mrs. and the Misses Lockett . . . . .	Mr. W. Selby, Brooke Farm, Isle of Wight.
108	<i>Joseph and Mary</i> —The late Mrs. Boetefeuer	Nicholas Barbenson, Esq., Alderney, Guernsey.
109	<i>Charlotte Mary</i> —S. J. Wilde, Esq., for late Miss M. R. Wilde . . . . .	Capt. Carré, R.N., Valnord, Guernsey.
110	<i>Mary Heape</i> —Benjamin Heape, Esq. . . . .	Mr. Richard Penney, Poole.
111	<i>Agnes Harriet</i> —The Earl of Strafford . . . . .	Mr. Henry Hixson, Swanage, Wareham.
112	<i>Wm. Woodcock</i> —H. W., Manchester Branch . . . . .	George H. Bond, Esq., Creech Grange, Wareham.
113	<i>Rimington</i> —Mrs. Rimington . . . . .	G. H. Price, Esq., Collector H.M. Customs, Weymouth.
114	<i>Victoria</i> —Lady Rolle . . . . .	Mr. Wm. Bennett, Lyme Regis.
115	<i>Arnold</i> —Teignmouth Bazaar . . . . .	W. M. Floyd, Esq., Sidmouth.
116	<i>Mary Brundret</i> —Mrs. Brundret, per Manchester Branch . . . . .	Capt. Squire, 1 Louisa Terrace, Exmouth.
117	<i>City of Exeter</i> —Collected in Exeter . . . . .	J. W. Beater, Esq., Teignmouth, Devon.
118	<i>Maud Hargreaves</i> —Mrs. Hargreaves . . . . .	Mr. R. G. Cove, Clifton Villa, Warren Road, Torquay.
119	<i>Rescue</i> —The late Richard Durant, Esq. . . . .	Rev. R. F. Elrington, M.A., Lower Brixham, Devon.
120	<i>Alexandra</i> —Freemasons of England . . . . .	Percy Hockin, Esq., Dartmouth.
121	<i>Bowman</i> —"A. B. S." . . . . .	W. H. Webb, Esq., Salcombe, Kingsbridge.
122	<i>Clemency</i> —Hon. Mrs. Hubbard . . . . .	R. Dawson, Esq., Wembury House, near Plymouth.
		James Rooney, Esq., Great Western Docks, Plymouth.

[Continued.]

No.	STATION.	Length.		Breadth.		No. of Oars.	When Stationed or Named.
		Ft.	in.	Ft.	in.		
123	CORNWALL - - - LOOE - - -	32	0	7	6	10	1867
124	FOWEY - - -	32	0	7	5	10	1879
125	MEVAGISSEY - - -	33	0	8	1	10	1869
126	PORTLOE - - -	33	0	8	1	10	1870
127	FALMOUTH - - -	33	0	8	6	10	1867
128	PORHOUSTOCK - - -	33	0	8	0	10	1869
129	CADGWITH - - -	33	0	8	1	10	1878
130	LIZARD - - -	30	0	7	2	10	1873
131	MULLION - - -	33	0	8	6	10	1867
132	PORHLEVEN - - -	30	0	7	0	10	1863
133	PENZANCE - - -	32	0	7	4	10	1865
134	SENNEN COVE - - -	34	0	8	3	10	1880
135	SCILLY ISLANDS - ST. MARY'S - - -	37	0	9	0	12	1874
136	CORNWALL - - - ST. IVES - - -	32	0	7	6	10	1878
137	HAYLE - - -	32	0	7	6	10	1866
138	NEW QUAY - - -	33	0	8	1	10	1873
139	PADSTOW - - -	32	0	7	4	10	1864
140	PORT ISAAC - - -	32	0	7	7	10	1869
141	BUDE - - -	33	0	8	0	10	1863
142	NORTH DEVON - - CLOVELLY - - -	33	0	8	1	10	1870
143	APPLEDORE—No. 1 - - -	34	0	7	1	12	1862
144	” No. 2 - - -	30	0	6	7	6	1875
145	BRAUNTON - - -	34	0	8	0	10	1881
146	MORTE BAY - - -	33	0	7	11	10	1871
147	ILFRACOMBE - - -	32	0	7	6	10	1866
148	LYMOUTH - - -	30	0	7	7	8	1869
149	SOMERSET - - - WATCHET - - -	33	0	8	6	10	1875
150	BURNHAM - - -	32	0	7	5	10	1866
SOUTH WALES.							
151	GLAMORGANSHIRE PENARTH - - -	30	0	8	0	8	1875
152	PORHCRAWL - - -	32	0	7	9	10	1872
153	SWANSEA - - -	33	0	8	1	10	1866
154	CARMARTHENSHIRE PEMBREY - - -	32	0	7	6	10	1871
155	CARMARTHEN BAY - - -	32	0	7	6	10	1879
156	PEMBROKESHIRE - TENBY - - -	33	0	8	0	10	1863
157	MILFORD - - -	33	0	8	6	10	1868
158	SOLVA - - -	33	0	8	1	10	1869
159	ST. DAVID'S - - -	32	0	7	6	10	1869
160	FISRGUARD—No. 1 - - -	30	0	6	8	6	1863
161	” No. 2 - - -	36	0	8	3	12	1878
162	CARDIGANSHIRE - CARDIGAN - - -	32	0	7	4	10	1864
163	NEWQUAY - - -	35	0	8	0	12	1864
164	ABERYSTWTH - - -	35	0	9	0	10	1881
NORTH WALES.							
165	MERIONETHSHIRE - ABERDOVEY - - -	32	0	7	4	10	1865
166	BARMOUTH - - -	34	0	8	4	10	1867
167	CARNARVONSHIRE - PORTMADOC - - -	34	0	8	0	10	1867
168	ABERSOCH - - -	33	0	8	1	10	1869
169	PORHDINLLAEN - - -	37	0	9	0	12	1877
170	ANGLESEY - - - LLANDDWYN - - -	32	0	7	6	10	1866
171	RHOSNEIGR - - -	30	0	7	6	10	1872
172	RHOSCOLYN - - -	33	0	8	0	10	1878
173	HOLYHEAD - - -	37	0	9	1	12	1875

No.	NAME OF BOAT AND DONOR.	NAME AND ADDRESS OF HONORARY SECRETARY.
123	<i>Oxfordshire</i> —Late Sir J. P. Willoughby, Bt.	R. Thomas, Esq., Looe, R.S.O., Cornwall. [Cornwall.
124	<i>Arthur Hill</i> —Arthur Hill, Esq. . . . .	W. E. Geach, Esq., Penellick, Par Station, R.S.O.,
125	<i>South Warwickshire</i> —Collected by Sir R. N. Hamilton, Bt.	Capt. J. Ball Farran, Mevagissey, St. Austell.
126	<i>Gorfenkle</i> —Legacy of J. Gorfenkle, Esq. . .	Rev. Canon Cornish, M.A., Veryan Vicarage, Grampound
127	<i>City of Gloucester</i> —Gloucester City . . . .	Charles Clift, Esq., Falmouth. [Road.
128	<i>Mary Ann Story</i> —Mrs. Story's Legacy . . .	Mr. E. P. Roskrug, St. Keverne, Helston.
129	<i>Joseph Armstrong</i> —That Life-boat Fund . .	Rev. F. C. Jackson, St. Ruan Rectory, Helston.
130	<i>Anna Maria</i> —Lord Robartes . . . . .	Rev. P. Vyvyan Robinson, The Lizard, Cornwall.
131	<i>Daniel J. Draper</i> —Wesleyan Methodists . .	Rev. E. G. Harvey, Mullion, Helston.
132	<i>Agar-Robartes</i> —Lord Robartes . . . . .	R. Sedgman James, Esq., Porthleven, Helston.
133	<i>Richard Lewis</i> —J. C. . . . .	} John Mathews, Esq., Lloyd's Agency Office, Penzance.
134	<i>The Denzil and Maria Onslow</i> —Miss Onslow	
135	<i>Henry Dundas</i> —Mrs. Dundas Drummond's Legacy.	John Banfield, Esq., Scilly, R.S.O., Cornwall.
136	<i>Exeter</i> —Mr. W. Kendall's Legacy . . . . .	T. B. Williams, Jun., Esq., St. Ives, R.S.O., Cornwall.
137	<i>Isis</i> —Oxford University . . . . .	John Poole, Esq., Riviere, Hayle.
138	<i>Pendock Neale</i> —Late Miss Neale and Miss Herring.	Mr. Rd. Hicks, New Quay, R.S.O., Cornwall.
139	<i>Albert Edward</i> —City of Bristol . . . . .	Rev. Richard Tyacke, Padstow, R.S.O., Cornwall.
140	<i>Richard and Sarah</i> —The late Richard Thornton West, Esq., and Mrs. West.	W. Guy, Esq., Port Isaac, Wadebridge, R.S.O.
141	<i>Elizabeth Moore Garden</i> —Family of the late R. T. Garden, Esq.	Wm. Rowe, Esq., Stratton, "North Devon Mail."
142	<i>Alexander and Matilda Boetefeur</i> —The late Mrs. Boetefeur.	Mr. J. Bumby, Chief Officer C. G <sup>d</sup> , Clovelly, Bideford.
143	<i>Hope</i> —The late Rev. F. W. Hope . . . . .	} Rev. I. H. Gosset, M.A., The Priory, Westward Ho! Bideford.
144	<i>Mary Ann</i> —The late Mrs. M. A. Walker . .	
145	Royal National Life-boat Institution . . . .	Mr. W. Nicol, H.M. Customs, Appledore, R.S.O., Devon.
146	<i>Grace Woodbury</i> —Mr. Robt. Atton's Legacy	H. C. Guppy, Esq., National Provincial Bank, Barnstaple.
147	<i>Broadwater</i> —Late R. Broadwater, Esq. . . .	} N. Vye, Esq., J.P., Ilfracombe.
148	<i>Henry</i> —A Lady . . . . .	
149	<i>Joseph Somes</i> —Mrs. Somes . . . . .	Mr. John Crook, Valley of Rocks Hotel, Lynton, Barnstaple.
150	<i>Cheltenham</i> —Town of Cheltenham . . . . .	R. J. Gimblett, Esq., Williton, Taunton. Cuthbert Ritson, Esq., Burnham, Bridgwater.
151	<i>Joseph Denman</i> —Hon. Mrs. Joseph Denman	Capt. Pengelley, H.M.I.N., Dock Master, Penarth.
152	<i>Chafyn Grove</i> —Miss J. E. Chafyn Grove . . .	Rev. W. Jones, Newton Nottage, Bridgend. [Cardiff.
153	<i>Wolverhampton</i> —Town of Wolverhampton.	T. W. Islay Young, Esq., West Cross, Oystermouth, near Swansea.
154	<i>Stanton Meyrick, of Pimlico</i> —His Legacy . .	Gerard Elkington, Esq., Pembrey, Llanelly.
155	<i>City of Manchester</i> —Manchester Branch . .	John Risley, Esq., Brondeg, Ferryside, R.S.O.
156	<i>Carolina Morris's Divine Rescue</i> —Mrs. Morris's Legacy.	J. R. Rowlands, Esq., Nat. Provincial Bank, Tenby.
157	<i>Katharine</i> —Titus Salt, Esq. . . . .	Henry Pattison, Esq., Collector H.M. Customs, Milford.
158	<i>Charles and Margaret Egerton</i> —Widow of Capt. Egerton, R.N.	The Honorary Secretary, Solva, R.S.O., Pembrokeshire.
159	<i>Augusta</i> —Earl of Dartmouth and Tenantry	Capt. John Davies, St. David's, R.S.O., Pembrokeshire.
160	<i>Sir Edward Perrott</i> —R. N. L. B. Institution	} Mr. W. Vaughan, Fishguard, R.S.O., Pembrokeshire.
161	<i>John of Foxley</i> —Miss Harrison's Legacy . .	
162	<i>John Stuart</i> —Manchester Branch . . . . .	John Morgan, Esq., Collector H.M. Customs, Cardigan.
163	<i>Nelson</i> —A Lady . . . . .	Capt. David James, 2 High Terrace, New Quay, Llandys.
164	<i>Lady Haberfield</i> —Her Legacy . . . . .	Rev. J. Williams, Bridge Street, Aberystwith. [sil.
165	<i>Royal Berkshire</i> —Berkshire . . . . .	} [North Wales.
166	<i>Ellen</i> —"E. P. S." . . . . .	
167	<i>John Ashbury</i> —James Ashbury, Esq., per Manchester Branch.	Dr. F. H. V. Grosholz, Pier House, Aberdovey, R.S.O., Mr. J. Jenkins, H.M. Customs, Barmouth, R.S.O.,
168	<i>Mabel Louisa</i> —Late R. Barnes, Esq., ditto	} [North Wales.
169	<i>George Moore</i> —That Life-Boat Fund . . . .	
170	<i>John Gray Bell</i> —H. W., Manchester Branch	Rev. O. Lloyd Williams, Bodfean, Pwllheli.
171	<i>Thomas Lingham</i> —Mrs. Lingham . . . . .	John Jackson, Esq., Harbour Office, Carnarvon.
172	<i>Ramon Cabrera</i> —The Countess de Morella .	Mr. J. W. Huws, Brynteg, Llanfaelog, Holyhead.
173	<i>Thomas Fielden</i> —Samuel, John, and Joshua Fielden, Esqrs.	J. H. Platt, Esq., Bodior, Holyhead. William P. Elliott, Esq., Holyhead.

No.	STATION.	Length.	Breadth.	No. of cars.	When Stationed or Named.
174	ANGLESEY - - - CEMLYN - - - - -	Ft. in. 32 0	Ft. in. 7 6	10	1877
175	CEMAES - - - - -	30 0	8 0	8	1876
176	BULL BAY - - - - -	32 0	7 7	10	1868
177	MOELFRE - - - - -	32 0	7 5	10	1874
178	PENMON - - - - -	34 0	8 0	10	1880
179	CARNARVONSHIRE ORME'S HEAD - - - - -	33 0	8 7	10	1867
180	DENBIGHSHIRE - LLANDDULAS - - - - -	33 0	8 6	10	1868
181	FLINTSHIRE - - RHYL (TUBULAR) - - - - -	32 0	8 4	12	1856
182	„ No. 2 - - - - -	33 0	8 6	10	1878
183	CHESHIRE - - - NEW BRIGHTON, No. 1 (TUBULAR)	45 0	10 2	14	1876
184	„ No. 2 (Ditto) - - - - -	40 0	8 10	12	1878
185	LANCASHIRE - - SOUTHPORT - - - - -	34 0	8 6	10	1874
186	LYTHAM - - - - -	35 0	8 0	10	1878
187	ST. ANNE'S - - - - -	34 0	8 3	10	1881
188	BLACKPOOL - - - - -	33 0	8 0	10	1864
189	FLEETWOOD - - - - -	34 0	8 6	10	1879
190	PIEL - - - - -	36 0	8 1	12	1878
191	CUMBERLAND - - SEASCALE - - - - -	32 0	7 9	10	1875
192	WHITEHAVEN - - - - -	33 0	8 0	10	1866
193	MARYPORT - - - - -	32 0	7 4	10	1865
194	ISLE OF MAN - - SILLOTH - - - - -	32 0	7 6	10	1867
195	RAMSEY - - - - -	33 0	8 6	10	1868
196	DOUGLAS No. 1 - - - - -	32 0	7 6	10	1868
197	„ No. 2 - - - - -	35 0	9 0	10	1874
198	CASTLETOWN - - - - -	32 0	7 6	10	1865
<b>SCOTLAND.</b>					
199	KIRKCUDBRIGHT - KIRKCUDBRIGHT - - - - -	32 0	7 6	10	1879
200	WIGTOWNSHIRE - WHITHORN - - - - -	33 0	8 6	10	1869
201	PORT LOGAN - - - - -	30 0	7 1	10	1866
202	AYRSHIRE - - - PORT PATRICK - - - - -	37 0	8 6	12	1877
203	BALLANTRAE - - - - -	33 0	8 1	10	1871
204	GIRVAN - - - - -	32 0	7 5	10	1865
205	AYR - - - - -	32 0	7 5	10	1867
206	TROON - - - - -	32 0	7 6	10	1871
207	IRVINE - - - - -	33 0	7 6	10	1874
208	ARDROSSAN - - - - -	34 0	8 3	10	1880
209	ISLE OF ARRAN - KILDONAN - - - - -	32 0	7 6	10	1881
210	ARGYLLSHIRE - - CAMPBELTOWN - - - - -	32 0	7 6	10	1876
211	SOUTHEND - - - - -	32 0	7 6	10	1869
212	ORKNEYS - - - STROMNESS - - - - -	33 0	8 0	10	1867
213	LONGHOPE - - - - -	37 0	9 2	12	1874
214	CAITHNESS-SHIRE - THURSO - - - - -	33 0	8 0	10	1871
215	HUNA - - - - -	34 0	8 3	10	1877
216	ACKERGILL - - - - -	30 0	8 0	8	1878
217	NAIRNSHIRE - - MORAY FIRTH - - - - -	34 0	8 3	10	1878
218	ELGINSHIRE - - LOSSIEMOUTH - - - - -	32 0	7 6	10	1866
219	BANFFSHIRE - - BUCKIE - - - - -	33 0	8 1	10	1871
220	BANFF - - - - -	32 0	7 6	10	1870
221	ABERDEENSHIRE - FRASERBURGH - - - - -	34 0	8 3	10	1880
222	WHITELINK BAY - - - - -	33 0	8 6	10	1878
223	PETERHEAD - - - - -	33 0	8 1	10	1865



No.	NAME OF BOAT AND DONOR.	NAME AND ADDRESS OF HONORARY SECRETARY.
174	<i>Good Shepherd</i> —Loyal Order of Ancient Shepherds.	Mr. W. Williams, Fronddu, near Cemaes, Amlwch, R.S.O., Anglesey.
175	<i>Ashonian</i> —The late George Heginbottom, Esq.	Rev. T. Lloyd Kyffin, Llanbadrig Vicarage, Amlwch, R.S.O., Anglesey.
176	<i>Eleanor</i> —A Lady in Wales . . . . .	T. F. Evans, Esq., Amlwch, R.S.O., Anglesey.
177	<i>Lady Vivian</i> —Her collection . . . . .	Rev. J. W. Evans, Llanallgo, Pentraeth, Anglesey.
178	<i>Christopher Brown</i> —Settle fund . . . . .	William Preston, Esq., Lleiniog Castle, Beaumaris.
179	<i>Sisters' Memorial</i> —Two Sisters . . . . .	G. F. Felton, Esq., Mostyn Estate Office, Llandudno.
180	<i>Henry Nixson, No. 2</i> —The late Henry Nixson, Esq., per Manchester Branch.	Rev. John Davies, M.A., Llanddulas Rectory, Abergele, R.S.O., Denbighshire.
181	<i>Morgan</i> —Miss Ellen Hodgson . . . . .	} Mr. Robert Hughes, Rhyl, North Wales.
182	<i>Jane Dalton</i> —"D." . . . . .	
183	<i>Willie and Arthur</i> —Joseph Leather, Esq. . . . .	} Charles H. Beloe, Esq., 13 Harrington Street, Liverpool.
184	<i>Stuart Hay</i> —Messrs. John Hay & Co. . . . .	
185	<i>Eliza Fernley</i> —Mr. Fernley's Legacy . . . . .	J. A. Robinson, Esq., Southport.
186	<i>Charles Biggs</i> —Miss Biggs's Legacy . . . . .	John Edmondson, Esq., Lytham, Preston.
187	—Jas. Chadwick, Esq. . . . .	W. A. Lloyd, Esq., St. Anne's-on-the-Sea, Preston.
188	<i>Robert William</i> —Mrs. and Miss Hopkins . . . . .	A. M. Viener, Esq., Blackpool.
189	<i>Child of Hale</i> —Colonel W. B. . . . .	Rev. Henry Lings, Queen's Terrace, Fleetwood.
190	<i>William Birkett</i> —Mr. Birkett's Legacy . . . . .	Capt. E. P. Stokes, Barrow-in-Furness, Lancashire.
191	<i>William Tomlinson</i> —Misses Tomlinson . . . . .	} Capt. David Borrowdale, Scotch Street, Whitehaven.
192	<i>Elizabeth</i> —Miss Leicester . . . . .	
193	<i>Henry Nixson, No. 1</i> —The late H. Nixson, Esq., per Manchester Branch.	W. H. Eckersley, Esq., Maryport.
194	<i>Mary Louisa</i> —Miss Browne's Legacy . . . . .	John Stronach, Esq., Silloth, R.S.O., Cumberland.
195	<i>Two Sisters</i> —J. Ryder, Esq., per Manchester Branch.	E. C. Kerr, Esq., Bank, Ramsey, Isle of Man.
196	<i>Manchester and Salford Sunday Schools</i> —per Manchester Branch . . . . .	} Thos. Bawden, Esq., North Quay, Douglas, Isle of Man.
197	<i>John Turner-Turner</i> —Mrs. Turner-Turner and Family . . . . .	
198	<i>Commercial Traveller</i> . . . . .	G. H. Quayle, Esq., Castletown, Isle of Man.
199	<i>Mackie</i> —Dr. Mackie's Bequest . . . . .	James M <sup>c</sup> Muldrov, Esq., Kirkcudbright.
200	<i>Charlie Peek</i> —A Lady, per the late N. Griffith, Esq.	Alex. Macfie, Esq., Clydesdale Bank, Whithorn, R.S.O., Wigtownshire.
201	<i>Edinburgh and R. M. Ballantyne</i> —Edinburgh Workpeople, and Edinburgh Ladies' Endowment Fund.	Quintin Cochrane, Esq., Port Logan, R.S.O., Wigtownshire.
202	<i>Civil Service, No. 3</i> —Civil Service Fund . . . . .	[Wigtownshire. David A. M <sup>c</sup> Clew, Esq., Dinvin, Port Patrick, R.S.O.,
203	<i>William and Harriot</i> —Mrs. Richardson's Legacy.	Mr. Jas. Wason, Postmaster, Ballantrae, Girvan.
204	<i>Earl of Carrick</i> —The late A. Kay, Esq. . . . .	Wm. Forsyth, Esq., Girvan.
205	<i>Glasgow Workman</i> —Glasgow Workpeople . . . . .	John Pollock, Esq., Town Clerk's Office, Ayr.
206	<i>Mary Sinclair</i> —Mrs. Sinclair . . . . .	Alexander Wylie, Esq., Troon.
207	<i>Isabella Frew</i> —William Somerville, Esq. . . . .	James Dickie, Esq., Council Chambers, Irvine.
208	<i>Fair Maid of Perth</i> —Peter Reid, Esq. . . . .	John Moffat, Esq., Ardrossan.
209	<i>Emily Dewar</i> —Mrs. Dewar's Legacy . . . . .	James Paterson, Esq., Lamish, R.S.O., Isle of Arran.
210	<i>Princess Louise</i> —Life-boat Fund . . . . .	} Mr. Alexander Mitchell, H.M. Customs, Campbeltown.
211	<i>John R. Ker</i> —Robert Ker, Esq. . . . .	
212	<i>Saltire</i> —The late Sir Titus Salt, Bart. . . . .	Capt. G. Bilton, Stromness, S.O., Orkney.
213	<i>Dickinson Edleston</i> —D. Edleston, Esq. . . . .	Edward E. Corrigan, Esq., Longhope, Kirkwall.
214	<i>Charley Lloyd</i> —Mr. Lloyd's Legacy . . . . .	J. Coghill, Esq., Thurso.
215	<i>W. M. C.</i> —"X. Y. Z." . . . . .	Mr. David Dunnett, Quoys, Canisbay-by-Wick.
216	<i>George and Isabella</i> —Miss Bower . . . . .	G. M. Sutherland, Esq., Bridge Street, Wick.
217	<i>Caulfield and Ann</i> —Mr. Lloyd Williams' Legacy.	H. T. Donaldson, Esq., Nairn.
218	<i>Bristol &amp; Clifton</i> —Bristol Histrionic Club . . . . .	[Elgin. Mr. John Ferguson, Harbour Master, Lossiemouth,
219	<i>James Sturm</i> —Mr. Sturm's Legacy . . . . .	John Shearer, Esq., Bank, Buckie, Fochabers.
220	<i>John and Sarah</i> —J. E. Lightfoot, Esq. . . . .	James Watt, Esq., National Bank of Scotland, Banff.
221	<i>Cosmo &amp; Charles</i> —Capt. Gordon . . . . .	Andrew Tarras, Esq., Towns House, Fraserburgh.
222	<i>Robert Adamson</i> —Miss Adamson . . . . .	Mr. A. J. Birnie, Cairnedeny, Inverallochy, by Lonmay,
223	<i>People's Journal</i> —No. 1—Subscribers to Dundee "People's Journal."	William Boyd, Esq., F.R.S.E., Peterhead. [Aberdeen.

[Continued.]

No.	STATION.	Length.		Breadth.		No. of Oars.	When Stationed or Named.
		Ft.	in.	Ft.	in.		
224	ABERDEENSHIRE - CRUDEN - - - - -	33	0	8	6	10	1877
225	NEWBURGH - - - - -	30	0	8	0	8	1877
226	KINCARDINESHIRE STONEHAVEN - - - - -	33	0	8	6	10	1874
227	GOURDON - - - - -	33	0	8	0	10	1878
228	FORFAR - - - - - MONTROSE—No. 1 - - - - -	33	0	8	6	10	1869
229	” No. 2 - - - - -	30	0	8	0	8	1874
230	ARBROATH - - - - -	32	0	7	6	10	1866
231	BUDDON NESS	33	0	8	6	10	1870
232	BROUGHTY FERRY } DUNDEE {	33	0	8	6	10	1876
233	FIFESHIRE - - - - - ST. ANDREW'S	33	0	8	0	10	1873
234	ANSTRUTHER - - - - -	32	0	7	4	10	1865
235	HADDINGTONSHIRE NORTH BERWICK - - - - -	30	0	7	7	10	1871
236	DUNBAR - - - - -	33	0	8	0	10	1865
237	BERWICKSHIRE - EYEMOUTH - - - - -	30	0	8	0	8	1876
<b>IRELAND.</b>							
238	Co. LONDONDERRY - GREENCASTLE - - - - -	33	0	8	0	10	1880
239	ANTRIM - - - - - PORTRUSH - - - - -	32	0	7	6	10	1876
240	DOWN - - - - - GROOMSPORT - - - - -	32	0	7	6	10	1867
241	BALLYWALTER - - - - -	32	0	7	6	10	1866
242	TYRELLA - - - - -	30	0	8	0	8	1875
243	NEWCASTLE - - - - -	34	0	8	0	10	1881
244	LOUTH - - - - - DUNDALK No. 1.—GILES' QUAY	34	0	8	3	10	1880
245	” No. 2.—BLACKROCK - - - - -	32	0	7	6	10	1867
246	DROGHEDA—No. 1 - - - - -	34	0	7	6	10	1879
247	” No. 2 - - - - -	32	0	7	6	10	1872
248	DUBLIN - - - - - BALBRIGGAN - - - - -	30	0	6	7	6	1875
249	SKERRIES - - - - -	33	0	8	6	10	1873
250	ROGERSTOWN - - - - -	32	0	7	6	10	1874
251	HOWTH - - - - -	33	0	8	0	10	1872
252	POOLBEG - - - - -	32	0	7	6	10	1866
253	KINGSTOWN - - - - -	37	0	8	6	12	1879
254	GREYSTONES - - - - -	33	0	8	0	10	1872
255	WICKLOW - - - - - WICKLOW - - - - -	33	0	8	0	10	1866
256	ARKLOW - - - - -	37	0	9	0	12	1873
257	WEXFORD - - - - - COURTOWN - - - - -	36	0	8	4	12	1876
258	CAHORE - - - - -	34	0	8	0	10	1879
259	WEXFORD—No. 1 - - - - -	40	0	10	6	12	1871
260	” No. 2 - - - - -	34	0	8	3	10	1878
261	CARNSORE - - - - -	32	0	7	4	10	1874
262	DUNCANNON - - - - -	33	0	8	6	10	1869
263	WATERFORD - TRAMORE - - - - -	34	0	8	0	10	1880
264	DUNGARVAN - - - - -	32	0	7	7	10	1871
265	ARDMORE - - - - -	34	0	8	0	10	1880
266	CORK - - - - - YOUGHAL - - - - -	32	0	7	6	10	1867
267	BALLYCOTTON - - - - -	34	0	8	0	10	1880
268	QUEENSTOWN - - - - -	34	0	8	0	10	1866
269	COURTMACSHERRY - - - - -	32	0	7	6	10	1867
270	KERRY - - - - - VALENTIA - - - - -	32	0	7	4	10	1880
271	TRALEE BAY - - - - -	34	0	8	3	10	1879

NOTE.—The Life-boat builders of the Institution

No.	NAME OF BOAT AND DONOR.	NAME AND ADDRESS OF HONORARY SECRETARY.
224	<i>Peep-o'-day</i> —"A Scot Abroad" . . . . .	Mr. James Boddie, Porthhead, Cruden, Ellon, N.B.
225	<i>Alexander Charles, and William Aird</i> —Miss Birtwhistle's Legacy.	Mr. P. Murray, Newburgh-by-Aberdeen.
226	<i>Star</i> —Mrs. Henry Hearn . . . . .	David Carr, Esq., Stonehaven.
227	<i>Young George Irlam</i> —Mr. Irlam's Legacy . . . . .	Rev. John Brown, Bervie, Fordoun.
228	<i>Mincing Lane</i> —Merchants of Mincing Lane	James Warrack, Esq., Montrose.
229	<i>Roman Governor of Caer Hün</i>	
230	<i>People's Journal</i> —No. 2—Subscribers to Dundee "People's Journal."	
231	<i>May</i> —"D." . . . .	William Cargill, Esq., Arbroath.
232	<i>English Mechanic</i> —Life-boat Fund . . . . .	
233	<i>Ladies' Own</i> —Miss Smithers' Life-boat Fund	James Hunter, jun., Esq., 69 Reform Street, Dundee.
234	<i>Admiral FitzRoy</i> —A Lady (H. H.) . . . . .	Mr. G. Murray, Postmaster, St. Andrew's.
235	<i>Freemason</i> —Freemasons of England . . . . .	H. B. Mackintosh, Esq., Anstruther.
236	<i>Wallace</i> —The late Lady Cuninghame Fairlie	D. McCulloch, Esq., British Linen Co., North Berwick.
237	<i>James and Rachel Grindlay</i> —Mr. T. Grindlay's Legacy.	G. R. Scott, Esq., Bank, Dunbar.
		Andrew Whitlie, Esq., Bank, Eyemouth, Ayton.
238	<i>Mary Beckwith</i> —Mrs. Beckwith's Legacy . . . . .	Rev. T. McClellan, Greencastle, Merville.
239	<i>John Whitaker</i> —Late Mr. Whitaker's Trust Fund, per E. Absalom, Esq.	Rev. J. Simpson,
240	<i>Florence</i> —A Friend . . . . .	{ W. E. Carver, Esq., J.P., } Portrush, R.S.O., Co., Antrim.
241	<i>Admiral Henry Meynell</i> —Misses Meynell Ingram.	Rev. F. J. Hearne, Groomsport, Belfast.
242	<i>Memorial</i> —Misses Frances and Kate Peach	Rev. J. O'Reilly Blackwood, Ballywalter, Newtownards.
243	<i>Farnley</i> —E. Armitage, Esq., R.A. . . . .	Rev. John Bingham, Tyrella Rectory, Clough, S.O., [Co. Down.
244	<i>James Thomas</i> —Miss Thomas's Legacy . . . . .	Mr. W. Hayward, Newcastle, S.O., Co. Down.
245	<i>Stockport Sunday School</i> —Life-boat Fund . . . . .	J. F. Farrell, Esq., Harbour Office, Dundalk.
246	<i>Old George Irlam, of Liverpool</i> —Miss Irlam's Legacy . . . . .	Mr. N. Halligan, Banktown, Drogheda.
247	<i>John Rutter Chorley</i> —Mr. H. F. Chorley's Legacy . . . . .	Tandy Cannon, Esq., Mornington House, Drogheda.
248	<i>Maid of Annan</i> —Mrs. Langworthy . . . . .	Mr. J. McNamara, Harbour Office, Drogheda.
249	<i>Laura Platt</i> —Mr. Thos. Platt . . . . .	H. A. Hamilton, Esq., Balbriggan, R.S.O., Co. Dublin.
250	<i>Tilerias, Tunstall</i> —Thos. Peake, Esq. . . . .	H. H. Foster, Esq., Skerries, S.O., Co. Dublin. [Dublin.
251	<i>Clara Baker</i> —A Friend, per Miss Baker	W. C. Townshend, Esq., Rogerstown, Rush, R.S.O., Co. Dublin.
252	<i>G. V. Brooke</i> —Brooke Life-boat Fund . . . . .	Mr. E. D'Alton, C.O.C.G. <sup>d</sup> , Howth, R.S.O., Co. Dublin.
253	<i>Hector</i> —Late Miss Anderson and Niece . . . . .	Mr. S. Carr, C.O.C.G. <sup>d</sup> , Ring's End, near Dublin.
254	<i>Sarah Tancred</i> —Mr. Tancred's Legacy . . . . .	Capt. the Hon. F. G. Crofton, R.N., Harbour Master, Kingstown.
255	<i>Robert T. Garden</i> —Late R. T. Garden, Esq.	P. Reid, Esq., Glencarrig, Delgany, Greystones.
256	<i>Out-Pensioner</i> —Out-Pensioners . . . . .	S. E. Pim, Esq., Wicklow.
257	<i>Alfred and Ernest</i> —Manchester Branch . . . . .	{ The Earl of Wicklow, Shelton Abbey, Co. Wicklow.
258	<i>John Brooke</i> —The Misses Brooke, per J. Richardson, Esq., Q.C. . . . .	Dr. Stopford Halpin, Arklow.
259	<i>Ethel Eveleen</i> —J. M. S. . . . .	J. S. Scott, Esq., J.P., Levuka, Gorey, Co. Wexford.
260	<i>Civil Service</i> —No. 1—Civil Service Fund . . . . .	Capt. R. D'Olier George, Cahore, Gorey, Co. Wexford.
261	<i>Iris</i> —Mrs. A. M. Burdon . . . . .	Mr. J. S. Sinnott, Cahore, Gorey, Co. Wexford.
262	<i>Richard and Anne</i> —The late Mrs. and Miss Warner.	Wm. Coghlan, Esq., Collector H.M. Customs, Wexford.
263	<i>Alfred Trower</i> —Henry Trower, Esq., and Friends.	Rev. T. W. Manning, Kilsoran Rectory, Tagoat, Wex-[ford.
264	<i>Christopher Ludlow</i> —Dr. Ludlow's Trustees	Mr. J. McGonagil, Duncannon, Waterford.
265	<i>Hooper</i> —Miss Hooper . . . . .	Edward Jacob, Esq., Ardview, Tramore, Waterford.
266	<i>Wm. Beckett of Leeds</i> —A Leeds Gentleman	Mr. James W. Shaw, Dungarvan.
267	<i>Oliver Goldsmith</i> —That Life-boat Fund . . . . .	William C. Poole, Esq., M.D., J.P., Ardmore, Youghal.
268	<i>Quiver</i> —No. 3—"Quiver" Magazine . . . . .	J. W. Pim, Esq., Youghal.
269	<i>City of Dublin</i> —Collected in Dublin . . . . .	T. W. Strangman, Esq., Shanagarry, Middleton.
270	<i>Crosby Leonard</i> —Late Crosby Leonard, Esq.	Capt. Nathaniel Sutton, Harbour Office, Queenstown.
271	<i>Admiral L'utcher</i> —R. G. Butcher, Esq. . . . .	Capt. Townshend, Courtmacsherry, Bandon.
		J. A. O'Driscoll, Esq., Valentia, Killarney.
		Robert McCowen, Esq., Lloyd's Agent, Tralee.

are Messrs. Woolfe and Son, of Shadwell, London, E.

# INDEX TO THE GIFT LIFE-BOATS OF THE ROYAL NATIONAL LIFE-BOAT INSTITUTION.

(The figures refer to the numbers of the Life-boats detailed on the ten preceding Pages.)

- A. B. S., 121.  
 A Friend, 240.  
 A Friend at Bradford, 52.  
 A Friend, per G. H. Aston, 86.  
 A Friend, per Miss Baker, 251.  
 A Lady, 15.  
 A Lady, 31.  
 A Lady (H. H.), 234.  
 A Lady, per T. Jones Gibb, Esq., 56.  
 A Lady, per Capt. Fishbourne, R.N., C.B., 83.  
 A Lady, "in memory of a very dear brother," 148.  
 A Lady, 163.  
 A Lady in Wales, 176.  
 A Lady, per the late N. Griffith, Esq., 200.  
 Anderson, Miss, the late, and Niece, 253.  
 "A Scot abroad," 224.  
 A Townsman of Leeds, 266.  
 Abbott, the late John, Esq., 40.  
 Adamson, Miss, 222.  
 Ancient Shepherds, Loyal Order of (A.U.), 174.  
 Anstice, Mrs., the late, 4.  
 Arkcoll, Chas., Esq., 94.  
 Armitage, E., Esq., R.A., 243.  
 Ashbury, Jas., Esq., 167.  
 Atton, Rob., Esq., the late, 146.  
 Barlow, Miss, 23.  
 Barnes, Robt., Esq., D.L., the late, 168.  
 Beckett, the late John, Esq., 38.  
 Beckwith, the late Mrs., 238.  
 Berkshire, collected in, 165.  
 Biggs, Miss, the late, 186.  
 Bird, Samuel, Esq., 50.  
 Birkett, Wm., the late, 190.  
 Birtwhistle, Miss, the late, 225.  
 Boetefeur, the late Mrs., 108, 142.  
 Bolton, collected in, 71.  
 Bouchier, Lady, 63.  
 Bower, Miss, 216.  
 Boys of England, 80.  
 Bradford, 84.  
 Bristol, Collected in, 139.  
 Bristol Historic Club, 218.  
 "British Workman" Magazine, collected from the readers thereof, 59.  
 Broadwater, Robert, Esq., the late, and Friends, 147.  
 Brooke, G. V., Life-boat Fund, 252.  
 Brooke, the Misses, 258.  
 Browne, Miss, the late, 194.  
 Brundret, Mrs., 116.  
 Burdon, Mrs. A. M., 261.  
 Burmester, Miss, 78.  
 Burton-on-Trent, Coll. in, 28.  
 Butcher, R. G., Esq., 271.  
 Cama and Co., Messrs., 58.  
 Carter, Misses, 20.  
 Caslake, Mrs. B., 45.  
 Chadwick, Jas., Esq., 187.  
 Cheltenham, collected in, 150.  
 Chorley, the late H. F., Esq., 247.  
 Civil Service, 13, 202, 260.  
 Coal Exchange, London, Members of, 73.  
 Commercial Travellers, 198.  
 Corn Exchange, Mark Lane, Members of, 64.  
 Covent Garden Life-boat Fund, 62.  
 Crossley & Sons, Messrs., J., 27.  
 Cunningham Fairlie, Lady, the late, 236.  
 D., 182, 237.  
 Dartmouth, the Earl of, and his Tenantry, 159.  
 Davis, Mrs. George, 81.  
 Denman, Hon. Mrs. Jos., 151.  
 Derby, collected in, 18.  
 Dewar, the late Mrs., 209.  
 Dixon, Miss, 44.  
 Draper, Daniel J., Life-boat Fund, 131.  
 Drummond, Mrs. Dundas, the late, 135.  
 Dublin, collected in, 269.  
 Dundee People's Journal, 223, 230.  
 Durant, Richard, Esq., the late, 119.  
 E. P. S., 166. [201.  
 Edinburgh Working Men's, Edinburgh Ladies' Endowment Fund, 201.  
 Edleston Dickinson, Esq., 213.  
 "English Mechanic" Life-boat Fund, 232.  
 Egerton, Capt. C. R., R.N., widow of, 158.  
 Exeter, collected in, 117.  
 Ferguson, Mr. and Mrs., 87.  
 Fernley, J., Esq., the late, 185.  
 Fielden, Samuel, John, and Joshua, Esqs., 173.  
 Foresters, Ancient Order of, 14, 25. [late, 34.  
 Fortea, Mrs. Harriott, the Foulston, Mrs. Eliza, the late, 19.  
 Fox, Children of Mr. and Mrs. Fraser, Mrs., 53.  
 Freemasons of England, 79, 120, 235. [36.  
 Freemasons of Warwickshire, Friends at Manchester, 95.  
 Frith, J. G., Esq., the late, and Mrs. Frith, 3.  
 Garden, the late R. T., Esq., 141, 255. [Mrs., 11.  
 Gibb, T. Jones, Esq., and Glasgow Workmen's, 205.  
 Gloucester, collected in, 127.  
 Good Templars, Independent Order of, 16.  
 Gordon, Capt., 221.  
 Gorfenkle, the late Jacob, Esq., 126.  
 Grindlay, Thomas, Esq., the late, 237.  
 Grocers of England, 55.  
 Grove, Miss J. E. Chafyn, 152.  
 H. W., 112, 170.  
 Haberfield, Lady, the late, 164.  
 Hackwood, Thos., Esq., 3.  
 Hallam, the Misses and Mrs. Margaret Birt, 100.  
 Hargreaves, Mrs., 118. [99.  
 Harris, the late Henry, Esq., Harrison, Miss, the late, 161.  
 Hatton, Mrs. Jane, 90.  
 Hay, John, & Co., 184.  
 Heape, Benjamin, Esq., 110.  
 Hearn, Mrs. Henry, 226.  
 Heginbottom, Geo., Esq., the late, 175.  
 Hill, Arthur, Esq., 124.  
 Hindley, Job, Mr., the late, 26.  
 Hodson, Miss Ellen, 181.  
 Holton, R. W., Esq., and Mrs. Holton, 37.  
 Hope, Rev. F. W., the late, 143.  
 Hooper, Miss, 265.  
 Hopkins, Mrs. and Miss, 188.  
 Hopkinson, Miss, the late, 9.  
 Hounsfeld, Mrs., 77.  
 Hubbard, Hon. Mrs., 122.  
 Huddersfield, collected in, 57.  
 Hulett, David, Esq., 91.  
 Ingleby, Rev. Chas., the late, per G. P. Wragge, Esq., 22.  
 Ingram, Herbert, Esq., M.P., Friends of the late, 48.  
 Ingram, Misses Meynell, 241.  
 Ipswich, collected in, 76.  
 Iriam, Geo. Esq., the late, 227.  
 Iriam, the late Miss, 246.  
 J. C., 133.  
 J. L., the late, 70.  
 J. M. S., 259.  
 Jewish Scholars' Life-boat Fund, 96.  
 Joseph Armstrong Life-boat Fund, 129.  
 Kay, the late Alex., Esq., 204.  
 Keble, Rev. T., 75.  
 Kendall, W., Esq., 136.  
 Ker, Robert, Esq., 211.  
 Ladies' Own Life-boat Fund, Landseer, Miss, 47. [233.  
 Langworthy, Mrs., 248.  
 Leaf, Sons & Co., Messrs., 102.  
 Leonard, C., Esq., the late, 270.  
 Leather, Jos., Esq., 183.  
 Leeds, Town of, presented in the name of, 266.  
 Leicester, collected in, 66.  
 Leicester, Miss, 68, 192.  
 Licensed Victuallers, collected from, 49.  
 Lightfoot, J. E., Esq., 220.  
 Lingham, Mrs., 171.  
 Lloyd, the late Chas., Esq., 214.  
 Lockett, Mrs. & the Misses, 107.  
 London Sunday Schools, 97.  
 Louise, the Princess, Life-boat Fund, 210.  
 Ludlow, the late Dr., 264.  
 Mackie, Dr., the late, 199.  
 M. B., 65.  
 Manchester Branch, 1, 10, 26, 29, 33, 112, 116, 155, 162, 167, 168, 170, 180, 193, 195, 196, 257.  
 Manchester and Salford Sunday Schools, 198.  
 Marten, G., Esq., and Miss Marten, 105.  
 Mather, Mrs. Annie, 21.  
 Meyrick, Stanton, the late, 154.  
 Mincing Lane Merchants, 228.  
 Moore, the late Geo., Esq., Life-boat Fund, 169.  
 Morella, the Countess de, 172.  
 Morris, the late Mrs., 156.  
 N. R., 46.  
 Neale, Miss, the late, and Miss Herring, 138.  
 Nixon, the late Henry, Esq., 180, 193.  
 Northumberland, The Dowager Duchess of, 7.  
 Nottingham, collected in, 5.  
 Odd Fellows (Manchester Unity), 43.  
 Oliver Goldsmith, the, 267.  
 Onstow, Miss, 134.  
 Out-Pensioners, 256.  
 Oxford University, 137. [69.  
 Parkin, Thos., Esq., the late, Peach, Misses Frances and Kate, 242.  
 Peake, Thomas, Esq., 250.  
 Pickersgill, the late H. W., Esq., R.A., 88.  
 Platt, Mr. Thomas, 249.  
 Plimsoll Life-boat Funds, 67.  
 "Quiver" Magazine, collected from the readers thereof, 74, 81, 268.  
 Reid, Peter, Esq., 12, 208.  
 Richardson, the late Mrs. Harriot, 203.  
 Rimgton, Mrs., 113.  
 Robartes, Lord, 130, 132.  
 Robertson, Miss, 98.  
 Rochdale, collected in, 24.  
 Roman Governor of Caer Hfn, the late, 229.  
 Rosebery, Lady, 89.  
 Rous, Admiral, Life-boat Fund, 42.  
 Ryder, James, Esq., 195.  
 St. Michael's, Paddington, Life-boat Fund, 72.  
 Sait, Sir Titus, Bart., the late, 212.  
 Sait, Titus, Esq., 157.  
 Settle, collected in, 41, 178.  
 Sinclair, Mrs., 206.  
 Sister's Memorial, 179.  
 Solicitors and Proctors, 93.  
 Somes, Mrs., 149.  
 Sommersville, W. Esq., 207.  
 Somerville, Miss, the late, 85.  
 South Warwickshire Life-boat Fund, 125.  
 Stockport Sunday Schools, 245.  
 Story, the late Mrs. M. A., 128.  
 Stratford, the Earl of, P.C., 106, 111.  
 Sturm, the late Jas. Esq., 219.  
 Sykes, the late Mrs. A. E., 32.  
 Tancred, the late J. Esq., 254.  
 Teignmouth Bazaar, 115.  
 Thomas, Miss, the late, 244.  
 Tomlinson, the Misses, 191.  
 Townsend, Mrs., 29.  
 Trower, Henry, Esq., and friends, 263.  
 Turner-Turner, Mrs. and Family, 197.  
 Vivian, Lady, coll. by, 177.  
 W., Lady, 2.  
 W. B., Colonel, 189.  
 Walker, the late Mrs. Mary Wardell, Miss, 6. [Ann, 144.  
 Warner, the late Mrs. and Miss, 262.  
 Wesleyan Methodists, 131.  
 West, R. Thornton, Esq., the late, and Mrs. West, 101, 140.  
 Whitaker, the late John, Esq., trust of the, per E. Absalom, Esq., 239.  
 Wilde, S. J., Esq., for the late Miss M. E. Wilde, 109.  
 Williams, Mr. Lloyd, the late, 217.  
 Willoughby, the late Sir J. P., Bart., 123.  
 Wolverhampton, coll. in, 153.  
 Worcester Cadets Life-boat Fund, 104.  
 Worcester, collected in, 103.  
 X. Y. Z., 215.  
 Yates, Mrs., the late, 30.

## THE EXPENSE OF A LIFE-BOAT STATION IS £1,000. ITS COST IS MADE UP AS FOLLOWS:—

Life-boat and her equipment, including Life-belts for the Crew	
and Transporting-carriage for the Life-boat . . . . .	£650
Boat-house (average cost) . . . . .	350
Total . . . . .	£1,000

The average annual expense of maintaining a Life-boat Station is £70, and the benefactions and contributions of Donors of Life-boats are earnestly solicited in aid of that fund.

GOD HELP OUR MEN AT SEA.



### List of the Rewards

FOR SAVING LIFE FROM WRECKS

VOTED BY THE ROYAL NATIONAL LIFE-BOAT INSTITUTION

TO THE CREWS OF ITS LIFE-BOATS, TO SHORE AND FISHING-BOATS' CREWS, AND TO OTHER PERSONS,

FROM THE 1ST JANUARY TO THE 31ST DECEMBER, 1880.

Jan. 1.—The *Newquay*, Cardiganshire, Life-boat, *Nelson*, put off to the aid of the barque *Pacific*, of Swansea, which was in a dangerous position near the shoals in the bay during a fresh W. gale and hazy weather. One of the Life-boatmen was put on board the vessel and piloted her out of danger.

Jan. 2.—Early in the morning, during a strong W.S.W. breeze and heavy sea, large flare lights were seen in the direction of the Cross Sand, and the lightships fired guns and rockets. The Caister No. 1 Life-boat *Covent Garden* thereupon proceeded to the Middle Cross Sand, and found the s.s. *Ancott*, of West Hartlepool, bound from London to the Tyne in ballast, ashore there, in the midst of heavy breakers.

The Life-boat let go her anchor, veered down under the lee of the steamer, and boarded her, when the crew were engaged by the master to assist to get his ship off the sand. Fortunately their efforts were successful, and the steamer was eventually enabled to proceed on her voyage.

Voted the thanks of the Institution, inscribed on vellum, and 1*l.*, to Mr. DENNIS CONNOR, Chief Officer H.M. Coastguard, at Rosslare, Ireland, in acknowledgment of his arduous and zealous services on the occasion of the launch of the Carnsore Life-boat, in reply to signals of distress shown from the Tuskar lighthouse on the 28th November.

Also a binocular glass, with a suitable

inscription, to Mr. PHILIP JEFFERSON, late coxswain of the Newbiggin Life-boat, in remembrance of his former good services in the boat in saving life from shipwreck.

Also a binocular glass, with a suitable inscription, and 10*l.*, to Mr. WILLIAM GRANT, on his retirement from the office of coxswain of the Institution's Life-boat at Margate, which appointment he had held seventeen years, in which period he had assisted to save 98 lives from various wrecks. He had previously received the Silver Medal and Second Service Clasp of the Institution.

Also 5*l.* to a man who had been injured while assisting to haul up the Theddlethorpe Life-boat.

Jan. 21.—During a moderate breeze from the N.W., and in cloudy and misty weather, guns were heard from the direction of the Goodwin Sands. The Ramsgate steam-tug *Aid*, and the Life-boat *Bradford* were at once manned, and left the harbour at 12.30. On arriving near the N.W. spit of the Goodwin Sands, a barque and a brigantine were observed ashore. The Life-boat was slipped and rowed alongside the brigantine, which proved to be the *Black Diamond*, of Guernsey, bound from Shields to St. Brieuc, France, with a cargo of coal. The master engaged the services of the Life-boat and tug. At the same time a lugger was seen alongside the barque. On the tide flowing, the steamer backed in, and towed the brigantine's anchor out in a N.W. direction; a large hawser was then passed to the vessel, and the tug commenced towing, and continued doing so for about two hours, the crew of the Life-boat meanwhile assisting to heave on the windlass, and also helping at the pumps. Eventually the vessel's head was moved, but, the tide falling, they failed to get her afloat, and the master then requested them to remain and try again on the following tide. At about 6 o'clock on the next morning, just before high water, the tug again backed in and commenced towing, the crew, as before, heaving at the windlass. They continued for two hours, but, the tide again falling, they were unable to move her, and the tow-rope was then slipped and hauled on board. The master of the barque, which was lying near the edge of the sand, her anchor having been taken out by the lugger, then hailed the steam-tug to tow his vessel into a place of safety. Accordingly her tow-rope was hauled on board, and the steamer commenced towing; the barque's anchor was hove up, and she was taken to a safe anchorage in the Downs. She was the *Karoon*, of Truro, U.S., 447 tons, bound from Yarmouth to New York, with a put cargo of scrap iron.

The steamer then returned to the brigantine, the Life-boat in the meantime having remained alongside. On the tide again flowing, the wind and sea increased, causing the vessel to strain and leak badly, and although the pumps were kept constantly at work, they were unable to keep the water under. At about 5 p.m., there being six feet of water in the hold, and the water still rising and gaining on the pumps, it was decided to abandon her, and the crew, consisting of six men, were then taken into the Life-boat, which proceeded, in tow of the steamer, to Ramsgate Harbour, where they

arrived at about 5.30 p.m. on the 22nd January. On the following morning the brigantine had sunk in the sands, her masts alone being visible.

Jan. 22.—The fishing-smack *Temperance Star*, of Redcar, was driven near the rocks during a strong gale from N.N.E., accompanied by a rough sea. On observing her perilous position, the Life-boat *Burton-on-Trent*, stationed at Redcar, was launched, proceeded to her, took the crew of two men out, and then brought the smack into a safe position.

Jan. 25.—Signals of distress having been shown from some vessels in Carnarvon Bay, the crew of the Porthdinllaen Life-boat *George Moore* quickly assembled, launched the boat, and proceeded in the direction of the light, when they were enabled to render assistance to two fishing smacks, the *James*, and the *Atkins*, both belonging to Liverpool, which had been in collision about nine miles N.E. of Porthdinllaen.—Expense of service, 13*l.* 5*s.*

Feb. 5.—The coxswain of the *Centurion* Life-boat, stationed at Walmer, was informed by a boat's crew that they had seen a vessel on the Goodwin Sands; but as the wind and sea were nearly calm at the time, he did not think it necessary to launch the Life-boat until he found that four of the vessel's crew were left on board, and could not be rescued on account of the surf on the Sands, the remainder of the men having been taken off by some galleys. He then returned to the station, and, having assembled the Life-boat crew, the boat proceeded to the vessel and rescued the four men, who were brought safely ashore. Their vessel was the barque *Shannon*, of London, bound from Shields to Leghorn with a cargo of coal.—Expense of service, 17*l.*

Feb. 5.—Voted 242*l.* 13*s.* to pay the expenses of the Clacton-on-Sea, New Romney, Kingsdowne, Deal, Walmer, Mullion, Porthdinllaen, Banff, Cullercoats, Portrush, Great Yarmouth, Holyhead, Bacton, and Buckie Life-boats, in assembling their crews, or putting off in reply to signals of distress shown by vessels not ultimately needing the aid of the boats.

Voted the Gold Medal of the Institution, and a copy of the vote inscribed on vellum, to Mr. WILLIAM PARTRIDGE CUBITT, Jun., in acknowledgment of his very brave conduct in plunging, at the peril of his life, into the sea from the Bacton Life-boat, in the midst of a heavy surf, after the upsetting of that boat, on the 20th January, and cutting a rope which had entangled her rudder. By this means she was released from a very perilous position, and was enabled to reach the shore with those on board her.

The thanks of the Institution, inscribed on vellum, and 1*l.*, were voted to Mr. WILLIAM WENN, and 6*l.*, to six other men, for putting off in a yawl, and rescuing some of the crew on the above-named occasion.

Also the thanks of the Institution to W. E. CARVER, Esq., J.P., in acknowledgment of his kind and valuable co-operation in taking an oar in the Portrush Life-boat, on the occasion of her launch to the stranded schooner *Graham*, of Dumfries, on the 29th December, 1879.

Feb. 9.—The Plymouth Life-boat *Clemency*

put off during a heavy S. gale, and rendered valuable assistance to the s.s. *Hankou*, of London, which was in a perilous position outside Plymouth Breakwater. The Life-boat conveyed hawsers from the Government steam-tug *Trusty* to the vessel, at the imminent risk of the men's lives, and she was then extricated from her dangerous situation and towed inside the Breakwater by the *Trusty* and two other steamers. The sea was so heavy outside that it would have been impossible, in the absence of the Life-boat, to have passed the towing hawsers to the endangered vessel.

Feb. 9.—During a strong gale from W.N.W. and a heavy sea, the ketch *Louisa*, of Bideford, bound to that port from Newport, with coal, was at anchor off Clovelly, when she showed a signal of distress. The Clovelly Life-boat *Alexander and Matilda Boctefeur* immediately proceeded to her, and on arriving alongside found that she was riding heavily at her anchors. The crew of three men and a female passenger were anxious to be taken ashore, and they were therefore taken into the Life-boat and safely landed. A few hours afterwards the weather moderated, and the men went on board their vessel again, got her under weigh, and proceeded on their voyage.—Expense of service, 7l. 3s.

Feb. 9.—At about 11 o'clock in the morning the brigantine *Andover*, of Dublin, which had lost her mainsail and had become unmanageable, stranded about one mile from Dundalk Lighthouse, during rough weather, and showed signals of distress. The Giles' Quay Life-boat proceeded to her, took off the crew of six men, and landed them at Dundalk Quay. The wind was then blowing strongly from the E., and the sea running high; the Life-boat therefore remained at Dundalk until the weather moderated.—Expense of first service, 10l. 13s.

While on her way back to her station, on the following morning, she was asked to try to tow the *Andover* off the bank. The Life-boat crew rendered the required assistance, and succeeded, with the aid of another boat's crew, in getting her afloat. The coxswain of the Life-boat, who is a pilot, then took charge of the vessel, signalled for a tug, and had her towed up to the Quay. She was on a voyage from Limerick to Liverpool, with a cargo of bones.

Feb. 9.—At 7.30 a.m. the *Two Sisters* Life-boat, stationed at Ramsey, went out during a moderate gale from the E. and a heavy sea, and rescued the crew, numbering five men, from the schooner *John Wesley*, of Aberystwith, which, while on a voyage from Workington to Newport with a cargo of pig-iron, had missed stays and been driven ashore about two miles to the north of Ramsey Harbour.—Expense of service, 12l. 7s.

Feb. 10.—During a strong gale from S.S.E., veering to S.W., with a very heavy sea, signals of distress were shown by the barque *Corea*, of Boston, U.S., which had stranded on the "Greengrounds" in Swansea Bay. The Swansea Life-boat *Wolverhampton* went to her assistance, and on arriving alongside found that she was striking heavily; her false keel had been beaten off, and she was dragging her anchors. The crew of thirteen men, and one woman, had proposed to leave in the ship's boats, but the boats were swamped and lost. On the arrival

of the Life-boat some of her crew went on board, and, with the assistance of a steam-tug which just then arrived, the barque was taken to Swansea.

Feb. 12.—A steam-tug came to the New Brighton landing-stage at 4 o'clock in the morning for the Life-boat, as there was a steamer ashore on the Askew Bank. The wind was blowing strongly from the S., and the weather was cloudy. The *Stuart Hay* tubular Life-boat was quickly manned, and proceeded in tow of the steamer to the aid of the stranded vessel. She proved to be the s.s. *Anatolian*, of Liverpool, bound thence to the Mediterranean with a general cargo. The Life-boat remained by her for some hours, and eventually transferred twenty-six of the crew to the tug, which took them to Liverpool; the captain and the pilot remained on board the *Anatolian*, trusting that she would not become a wreck.—Expense of service, 12l. 5s.

Feb. 12.—At about 5.30 p.m. the fishing schooner *Kate*, of Wexford, was seen to be running for the harbour. The wind was blowing moderately from the S.W., but the sea was rolling furiously in consequence of a strong gale on the previous night. Immediately on entering the bar she was struck by a heavy breaking sea, which completely capsized her. Her crew, consisting of four men, succeeded in getting upon the bottom of the boat, but were instantly swept off by the sea. By this time the Life-boat *Civil Service* had put off from Wexford to render assistance; but unfortunately nothing could be seen except some small portions of wreckage. After cruising about for a short time, the Life-boat picked up a man who had drifted in, clinging to a small piece of board. The poor fellow was in a most exhausted state; he was at once landed at Rosslare, and every effort was made to restore animation, but unfortunately without success, and he expired about an hour after being landed. The Life-boat again went out, but was unable to find any trace of the rest of the crew.—Expense of service, 6l. 9s.

Feb. 14.—Information was brought to the Cemaes, Anglesey, Life-boat Station of a wreck on Skerries Island. The wind was blowing half a gale from S.W. at the time. The Life-boat *Ashtonian* was immediately launched and proceeded to the vessel, which proved to be the barque *Guiding Star*, of Salcombe, bound to that port from Liverpool, with coal. The captain, his wife, and the crew, consisting of eight men, had succeeded in getting on the rocks by means of ropes from the jib-boom end. The Life-boat stayed several hours at the island, and eventually seven of the shipwrecked people were, with great difficulty on account of the tremendous sea, taken into the Life-boat and landed at Cemaes. Three of the vessel's crew remained on the island, so as to be able to save anything that might be washed ashore. On the 17th inst. the Life-boat again went to the island and brought them ashore.—Expense of first service, 6l. 11s.

Feb. 15.—At 6 p.m. the Caister No. 2 Life-boat, the *Godsend*, proceeded to the barque *Orion*, which had stranded on the south side of the North Scroby Sand. A fresh S. by E.

breeze was blowing at the time, the weather was foggy, and the sea was moderate at first; but the wind and sea afterwards increased very much, and the Life-boat accordingly remained by the vessel until she fortunately floated at about 12.30, when the boat returned to her station. The barque was bound to London with a cargo of wood—Expense of service, 18*l*.

Feb. 16.—The Great Yarmouth Life-boat *Mark Lane* was launched and proceeded through a heavy sea to the ketch *Duquesclin*, of Newcastle, which had shown a signal of distress while riding in the roads. She was found to be leaking, and the crew, consisting of four men, proposed to leave her. The Life-boat crew, however, worked at the pumps, and, with the aid of a steam-tug, the ketch was taken safely into harbour.

Feb. 23.—The ketch *Forager*, of Portsmouth, from Seaham to Chichester, with coal, with a crew of four men, stranded near Kingsgate Castle, Kent, on the 22nd February. A Coast-guard boat proceeded to her assistance, and endeavoured to get her afloat, but the tide fell before this could be accomplished. On the following morning the wind blew strongly from the E.N.E., and the sea was heavy, and it was therefore considered advisable to take the Kingsgate Life-boat *Thomas Chapman* out to the vessel, the lives of the crew being in danger. The Life-boat proceeded to her at about 6.30 A.M., and in three hours' time she was got afloat and, with the assistance of a steam-tug, was taken to Ramsgate Harbour, the Life-boat accompanying her to assist in steering, and to be in readiness in case her services were required to save life, as the vessel was leaking badly.

Feb. 26.—At 7.30 A.M. the coxswain of the Blackpool Life-boat was informed that a vessel had just been seen on the Salthouse Bank with a signal of distress flying. The wind was blowing a gale from the N.W., and the sea was very heavy at the time. He at once went down the pier, and, finding the report to be correct, the *Robert William* Life-boat was got out immediately, and placed in position for launching. It was found that only seven of the crew had arrived, and the coxswain then selected three landmen whom he knew could pull pretty well, and as no time was to be lost, the boat was launched, even now under-manned, her proper complement being ten oarsmen in addition to the two coxswains and a bowman. She proceeded under sail as near to the wreck as was possible, shipping heavy seas nearly the whole of the time. The oars were then got out, and after two hours' very hard pulling, she got alongside. Great danger was incurred in approaching the vessel, as her spars were adrift and working about. The Life-boat was therefore hauled to within ten yards or so of the rigging, and a line was passed on board, by means of which the crew were dragged one by one through the sea and into the boat; they were in a most exhausted condition, and almost unable to assist themselves. Having safely got the four men into the boat, the grapnel line was cut, the anchor weighed, and her head put for the shore, which was about four miles away. Being close on to the bank, she was obliged to run over it, the sea being terrific, but the drogue

was got out and put in charge of the bowman, the sub-coxswain not being on board. One great sea broke right over the boat's stern, filling her completely, and driving her like an arrow for about a quarter of a mile. At last, despite all efforts, she broached to and was thrown on her beam ends, one man being washed overboard, and the remainder hurled to the side of the boat. The crew, however, by direction of the coxswain, quickly sprang to the weather side, which manœuvre brought her almost to an even keel, and prevented a capsizing. Her head was once more put before the sea, and the man who had been thrown overboard and had held on to the life-lines, was pulled into the boat. They, however, still had a critical time, for when the boat had been struck by this heavy sea the bowman had been knocked over, and had lost his hold of the drogue line, and the drogue was consequently lost. The coxswain then got out the bucket, and having attached lines to it, extemporised a drogue. At 12 o'clock at noon the Life-boat safely landed at St. Ann's, and was rapturously received by an immense crowd. The vessel proved to be the schooner *Bessie Jones*, of Fleetwood, bound from Glasgow to Liverpool with steel railway metals. One of the shipwrecked crew (the cook) had unfortunately been washed overboard from the vessel and drowned before the Life-boat arrived.—Expense of service, 15*l*. 13*s*. 9*d*.

The Silver Medal of the Institution was voted to Mr. ROBERT BICKERSTAFFE, the coxswain of the Life-boat, in acknowledgment of his general gallant exertions in the boat, and particularly for his good services on this occasion. A double reward was also granted to the crew of the Life-boat, in addition to the local presentation of a special Silver Medal commemorative of the occasion, accompanied by a sum of money, amounting to nearly 5*l*., which was paid into the Post Office Savings Bank to the account of each man.

March 2.—The Southend, Essex, Life-boat rendered assistance to a fishing-smack which was in distress.

March 4.—Voted 262*l*. 4*s*. 6*d*. to pay the expenses of the Life-boats at Broadstairs, Deal, Kingsdowne, Drogheda, Rye, Winchelsea, Porthdillan, Cresswell, Great Yarmouth, Carmarthen Bay, Fowey, Mewagissey, Sulcombe, Scarborough, Ardrossan, Whitehaven, Queenstown, and Piel, in assembling their crews or going out to the assistance of vessels which did not ultimately need their aid.

The Ramsgate Life-boat had proceeded to the aid of a vessel in distress, but her services were found not to be required.

Voted a binocular glass and 10*l*. to Mr. ED. TUPMAN, on his resignation of the office of Coxswain of the Exmouth Life-boat, which office he had held for more than twenty years.

March 7.—A rocket was fired from a vessel near Rhoscolyn Landmark, Anglesey, early in the morning, while the weather was foggy, and a heavy sea was running, the wind being S.W. The *Thomas Lingham* Life-boat, stationed at Rhosneigr, proceeded to her assistance, and found that she had struck on a rock. She was the barque *Orient*, of Liverpool, bound to that port from San Francisco, with a cargo of wheat.



Fortunately the wind shifted to the N., and aided by the advice of the coxswain of the Life-boat, the ship was extricated from her perilous position and was enabled to complete her voyage in safety.

March 11.—The Lydd, Dungeness, Life-boat *David Hulett* was launched in reply to signals of distress, and proceeded to the ship *Livingstone*, of Yarmouth, N.S., which had stranded near No. 2 Battery, East Bay, Dungeness, during a strong wind from E.S.E. and thick fog, accompanied by a rough sea. The boat remained by the vessel several hours, until she was got off with the assistance of three steam tugs.—Expense of service, 16l. 12s.

March 12.—On the 11th March, at midnight, signals of distress were shown from a ship ashore on the Long Rock opposite Ballywater, co. Down, and in response thereto the Life-boat *Admiral Henry Meynell*, stationed at Ballywater, was promptly launched and proceeded to the spot; but the night being very dark, with a gale blowing from the S.E., and a heavy sea running on the rocks, upon which there was not much water, the boat was compelled to wait for daybreak before going alongside the stranded vessel. During the time of waiting the tide fell, which rendered the task somewhat easier. The night was a very severe one, with tremendous rain squalls, to which the Life-boatmen were exposed for about six hours. However, they at last had the satisfaction to save the shipwrecked crew of five men, arriving back with them at Ballywater at about 7 A.M. Expense of service, 17l. 6s.

March 14.—In reply to signal guns from the East Goodwin Lightship, at 3.30 A.M., the *Samuel Morrison Collins* Life-boat, of Broadstairs, proceeded to the Goodwin Sands, and found the s.s. *Mabel*, of Hartlepool, ashore on the eastern part of the Sands. She had a crew of twenty-two men and two passengers, and forty-seven Deal and Broadstairs boatmen were on board rendering assistance, and, as she was in a most dangerous position, the Life-boat remained by her until 3 P.M. on the 16th, in case her services should be required to save those on board, should the weather become stormy. Fortunately, after throwing overboard 800 tons of cargo (iron ore), she came off the sand at 2 P.M. on the 18th March.

March 14.—At 3.30 A.M., during a fresh breeze from N.E., the Ramsgate Harbour Life-boat *Bradford*, and steam-tug *Vulcan*, proceeded to the Goodwin Sands in response to guns and rockets from the Gull Lightship, and found the barque *Surinam*, of Amsterdam, ashore there. The services of the Life-boat and tug were at once engaged by the master to try to get the vessel off, and the steamer attached her hawser and commenced towing; but the tide was falling fast, and after trying for about an hour it was seen that it could not then be accomplished. The starboard anchor was, however, got ready, and the steamer took it out a distance of seventy-five fathoms, and on the tide flowing she once more backed in, attached her hawser to the starboard quarter, and again commenced towing. After towing for some time, the tide forced the vessel round, when the tow-rope was slipped and made fast to the starboard bow. Again the

steamer commenced towing, the crew heaving on the windlass. The vessel bumped heavily on the sand, but in about half an hour she came afloat, and was taken to a safe anchorage in the Downs. She had a general cargo and a crew of ten men, and was bound from Amsterdam to Surinam, Dutch Guiana.

March 17.—At 6.30 A.M., during a fresh breeze from the E., the *Vulcan* tug and *Bradford* Life-boat, of Ramsgate, went to the aid of a large brig which was seen ashore on the N.E. part of Goodwin Sands. On arriving alongside, the Life-boat found the crews of two Ramsgate luggers on board. The master engaged the services of all the men to assist to get the vessel off. The deck cargo of rough timber was thrown overboard, the pumps were manned, and the water pumped out. On the tide flowing, the *Vulcan* backed in and attached her hawser, and eventually the steam-tug *Wanderer*, which had been lying near, was also engaged to try to get the vessel off the sands; but the heavy sea caused her to pitch so heavily that the tow ropes constantly parted, and further attempts had to be suspended for a time. At 1 o'clock on the following morning the vessel's sails were set, to endeavour to force her over the sand, and she was moved about three lengths ahead, when the tide again fell and she remained fast. At 1 P.M. the whole of her canvas was again set, and both of the steamers' hawsers were attached to her, and after towing until about 4 P.M., it being the top of high water, she moved ahead, and was eventually got afloat and towed into Ramsgate Harbour, arriving at 5.30 P.M., the salvors' persevering attempts to save the vessel and crew being thus rewarded by success, after upwards of thirty hours of toil and exposure. She proved to be the brig *Heroen*, of Porsgrund, Norway, bound thence to Cardiff with a cargo of timber, and having a crew of nine men.

March 30.—It was reported by the master of a fishing smack that a barque had grounded on the Arklow Bank. The *Out-Pensioner* Life-boat, stationed at Arklow, proceeded to her assistance, and found she was the barque *Pater*, of Sundswall, Sweden, bound from Liverpool to New York with a cargo of salt. The Life-boatmen were requested to assist in throwing the cargo overboard or into hookers if they arrived. This work was persevered in for six or seven hours, when a heavy breeze sprang up from the S.S.W., accompanied by rain, and the sea rose so rapidly and so high that it was considered advisable to get away from the vessel as soon as possible. The Life-boat therefore returned ashore, bringing eleven of the crew and the captain's wife, the remaining three men of the crew having previously been taken off by a fishing boat. The Life-boat arrived at Arklow at about midnight, after crossing the Bank, where she shipped a great quantity of water. Prior to leaving the barque, one of the seamen fell overboard; his cries were heard from the Life-boat, which was pulled in that direction, and happily they were successful in picking the man up, after he had floated some distance. Before noon the next day the vessel had entirely disappeared.—Expense of service, 23l. 9s.

Voted the thanks of the Institution, inscribed on vellum, to the Rev. J. O'REILLY BLACKWOOD,

in acknowledgment of his arduous and praiseworthy services in the Ballywalter Life-boat, on the occasion of the rescue of the crew of five men of the brigantine *John and Mary*, of Belfast, which was wrecked on the Long Rock off Ballywalter, Co. Down, during a heavy S.E. gale on the night of the 11th March.

Also the thanks of the Institution, inscribed on vellum, to JOHN CRAIG, Esq., in acknowledgment of his most assiduous and valuable co-operation at Ardrossan, on the occasion of the wreck of the barque *Matilda Hilliard*, of Yarmouth, N.S., on the 1st March.

Voted also 38l. 3s. to pay the expenses of the Life-boats at Cemlyn, Bude, and Dundalk, in either assembling their crews or putting off to vessels not ultimately needing their aid.

The Ramsgate and Southend (Essex) Life-boats had also been taken out with the view of assisting distressed vessels.

April 2.—The Runswick Life-boat *Margaret and Edward* put off to the aid of several of the fishing-cobles belonging to that port which had been overtaken by a gale. The Life-boat remained out two hours, and rendered important service to the boats in assisting them to get safely ashore.

April 2.—While fourteen of the Newbiggin cobles were out fishing, at about 11 A.M., the sea suddenly rose to a great height, and considerable anxiety was felt for the safety of the boats and their crews. The Newbiggin Life-boat went to their assistance, and after some hours' exertion eleven of the cobles were brought in safety to the shore. The other three boats were out of sight, and as the sea was very high, and there was but little wind, it was evident that they required assistance. The Life-boat therefore proceeded in the direction of the fishing-ground, fell in with the boats, and towed them into the bay, one of the boats being towed three miles. The Life-boatmen were engaged six hours in rendering these services.

April 9.—The ketch *Rival*, of London, bound there from Newcastle with fire-bricks, went ashore at Ostend, about a mile and a quarter N. of the Hasborough Life-boat Station, during a strong E.N.E. wind and a thick fog, on the night of the 8th April. A rocket was fired to her, but the line got entangled in the wreck of another vessel which was near, and was rendered useless. The Hasborough Life-boat *Huddersfield* then put off and succeeded in rescuing the persons on board the ketch, consisting of the master, his wife, and crew of three men.—Expense of service, 18l. 10s.

April 11.—At 4 A.M., during a strong wind from the E.N.E., and a heavy sea, the *British Workman* Life-boat, stationed at Palling, Norfolk, was launched to the aid of the brig *Betty*, of Tonsberg, Norway, which had grounded on the Hasborough Bank, and had floated off in a very damaged condition. With the assistance of a yawl the vessel was beached at Palling, her crew of eight men being landed by the Life-boat.

April 15.—Two fishing-cobles, with three men in each, were observed making for Whitby Harbour at 2.30 P.M. A strong E. gale had suddenly sprung up, causing a heavy sea on the bar, and the boats were in great danger of being swamped. The Life-boat *Harriott Fortearth*

went to their assistance, supplied each of the men in the cobles with a cork life-belt, and remained by the boats until they were safely beached.

April 26.—About 9 A.M. several of the fishing cobles were observed running for Cullercoats harbour. As a strong breeze was blowing, and the sea had risen very much, it was feared that they might meet with accident in crossing the bar. The Cullercoats Life-boat, *Palmerston*, was therefore pulled out to their aid. The first coble which arrived got in with difficulty; and as the sea was very heavy on the bar, and the tide was low, the Life-boatmen persuaded the crews of the other boats to make for Shields, rather than run the risk of losing their boats.

May 4.—At 11.30 P.M. guns were fired by the St. Nicholas Lightship, in response to which the Gorleston Life-boat *Leicester* immediately put off and proceeded to the Scroby Sand. The weather at the time was thick, with rain; the wind was not heavy, but there was a considerable swell. It was found that the schooner *Pride of the Isles*, of Bridport, had gone ashore on the south part of the sand. She had lost her rudder, and as she had more than four feet of water in her hold, her crew, consisting of six men, were taken into the Life-boat and safely landed. The vessel rolled over and sank almost immediately after the Life-boat had left her.—Expense of service, 15l.

May 5.—At about 2.20 A.M., during a fresh wind from the N.N.W., signal guns and rockets were fired from the North Sand Head and Gull Lightships. The Ramsgate Harbour steam-tug *Vulcan* and Life-boat *Bradford* were manned as quickly as possible, and at 2.50 the Life-boat left the harbour. The tide at that time being low, the tug was aground, but soon floated, overtook the Life-boat before she arrived at the sand, and took her in tow. On nearing the N.W. buoy a large flare light was seen, and the boat was then slipped and made sail for the vessel, which proved to be the sloop *Nimrod*, of Jersey, 36 tons register, bound from London to Bideford; she had a crew of two men and a boy, and the master's wife was also on board. The sea was breaking over the stern of the vessel, and the master stated that the water was up over the cabin floor. Some of the Life-boatmen went on board, and assisted the master's wife into the Life-boat, and then commenced pumping the vessel, while others ran out her large keedge anchor. The steamer then backed in, and her tow-ropes were hauled on board and attached. After towing about half an hour the sloop, after striking heavily again on the sand, came afloat, and was towed into Ramsgate Harbour at about 7.30 A.M., the Life-boatmen continuing at the pumps until the vessel was moored in a safe position.

May 6.—Voted 169l. 7s. 9d. to pay the expenses of the Life-boats at Broadstairs, Montrose, Palling, Solva, St. David's, Brooke, Brightstone Grange, and Great Yarmouth, in assembling their crews or putting off in reply to signals of distress shown from vessels which did not ultimately require the aid of the boats.

May 9.—Signals of distress were observed at midnight on the 8th May from a vessel which had stranded on the Dogger Bank. The wind

was blowing from the E.N.E. at the time, and the sea was rough. The *Ethel Eveleen* Life-boat, stationed at Wexford, promptly proceeded to render assistance, and on arriving alongside the vessel, found she was the schooner *Jonah*, of Wexford, bound for that port from Dublin with a cargo of wheat. As she was full of water, her crew of four men, and two passengers, were taken into the Life-boat and brought safely to land.—Expense of service, 15*l*.

May 20.—An exciting scene took place off Blackpool this day, owing to the steamer *Columbus* taking the ground with three hundred passengers on board. Every effort was at once made to get her out of her dangerous position, but without success. The heavy seas meanwhile continued to roll over the steamer as she lay broadside on to them. All this time the passengers on board were in a terrible state of confusion, and a good many of them were under no little apprehension as to their personal safety, for almost without an exception they were drenched to the skin with the sea, which found its way on board. The captain, seeing that there was no chance of getting his vessel afloat until the turn of the tide, hoisted a flag of distress, whereupon the Life-boat bell was rung by Mr. Robert Bickerstaffe, the coxswain, and the boatmen ran with all speed to the boat-house. Their zeal and anxiety to get a place in the *Robert William* Life-boat were so marked that, in their eagerness to get hold of a cork jacket, which enables him who gets it to have an oar during the rescue, the coxswain was hustled up to the far end of the boat. Four horses were stopped on the road and attached to the Life-boat carriage. The force supplied by the efforts of the willing horses was immediately augmented by literally hundreds of strong arms dragging away at the ropes, so that the sands presented a most animated aspect as the Life-boat and the accompanying crowd hurried along under the south pier and on to the north, where the living freight of the *Columbus* were eagerly awaiting delivery from their unpleasant if not perilous, position. At about twenty minutes past one the Life-boat was shot off her carriage and dashed into the broken surf, amid the lusty cheers of the crowds of bystanders. Once afloat, she was very soon alongside the stranded steamer. By this time several sailing and rowing boats had also got alongside, and in half an hour all the three hundred passengers were once more safe on land again, to their inexpressible satisfaction. The Life-boat made two trips, and brought off sixty-two passengers the first time and seventy-one the second. The large sailing boats brought off about forty passengers each time. After all the passengers were safely landed, the Life-boat returned to the steamer, and remained alongside her until she floated again, at about 4 o'clock in the afternoon.—Expense of service, 9*l*. 18*s*.

June 3.—Voted 35*l*. 10*s*. to pay the expenses of the Life-boats at Donna Nook and Lizard, in assembling their crews or putting off to the aid of vessels showing signals of distress, but not ultimately requiring assistance.

The Ramsgate Life-boat had also been out in reply to distress signals, but her services were not eventually needed.

June 4.—At 4 A.M., during a fresh breeze from the N. and misty rain, the Ramsgate Life-boat *Bradford* and steam-tug *Aid* went out in reply to signal guns from the Gull Lightship. They proceeded through the Old Cudd Channel, and round to the eastward of the North Sand Head, when they observed a schooner ashore on the N.E. part of the sand. On arriving abreast of the vessel, the Life-boat was slipped, and proceeded under sail towards her. The anchor was let go about thirty fathoms to windward of her, and the boat was veered as near as possible; all the time a heavy sea was breaking over the vessel and occasionally filling the Life-boat. Two of the Life-boatmen jumped on board, and the boat was hauled off again, to avoid being damaged alongside. The master at once engaged the services of the Life-boat to assist to get his vessel off. As the tide flowed, the sea made, breaking completely over her and causing her to strike heavily on the sand. The canvas, which had been clewed up, was again set, to try to force her over the sand. There was not sufficient water for the steamer to get near in the heavy sea; but as the tide made, the vessel lifted with the sea, and the current setting her to the eastward, she beat over into deep water, and was then sailed round the North Sand Head into Ramsgate Harbour, where she arrived at 10.15 A.M. The pumps had been continually at work from the time the men went on board the vessel, which proved to be the schooner *Isabella*, of Beaumaris, 79 tons, bound from London to Dublin, with cement; her crew consisted of four men.

June 28.—At about 3.15 A.M. it was reported that a ship was ashore on the Goodwin Sands. The Walmer Life-boat *Centurion* accordingly proceeded to the inner part of the South Sand Head, and found the ship *Colombo*, of Greenock, ashore there. She was bound from Bassein, India, to Bremen, with a cargo of rice; her crew consisted of twenty-four men, and the master's wife and child were also on board. The captain engaged the services of the Life-boatmen and others to lighten the ship. After throwing over about 250 tons of cargo, they succeeded in removing her from her perilous position, and took her into the Downs. There was a fresh W.S.W. wind at the time, and the weather was hazy.

July 1.—Voted 43*l*. 7*s*. to pay the expenses of the North Deal, Walmer, Wexford No. 1, and Carnsore Life-boats, in putting off in reply to signals of distress exhibited by vessels not ultimately requiring the services of the boats.

July 4.—The Sutton Life-boat *Caroline* proceeded to the assistance of the yawl *Wave*, of Goole, which was showing a signal of distress. On arriving alongside it was found that her foretopmast and foremast-head rigging and head gear had been carried away in a squall, and as the sea was running too high to allow the crew to get the wreckage on board, she had brought up off Sutton and made signals of distress. The Life-boatmen stowed the wreckage, got the vessel under weigh, took her into Boston Deepes and anchored her in safety off the Scull Rig Buoy, remaining by her during the night until a tug from Boston arrived and took her in tow for Grimsby. The yawl was on a voyage from

London to Middlesborough with a cargo of scrap iron.

July 19.—On the morning of the 18th July, during a thick fog, the s.s. *Red Rose*, of Cardiff, grounded on the Hasborough Sand. Some yawls went to her assistance, but finding that these boats did not return, and that the vessel still remained fast, at 3 A.M. on the following day the *British Workman* Life-boat, stationed at Palling, Norfolk, was launched, and with the combined efforts of the boats and steam-tugs the steamer was got off and taken into Yarmouth Roads. She was bound from the Tyne to Alexandria with coal, and had a crew of twenty-two men and two passengers.

Aug. 5.—Voted 9*l.* 18*s.* to pay the expenses of the Lizard Life-boat in putting off in reply to signals of distress to a vessel which did not eventually require assistance.

The Cemlyn and Winterton Life-boats had also been launched to the aid of vessels in distress, but their services were not ultimately needed.

Aug. 7.—Soon after 7 P.M. the coxswain of the Burnham Life-boat saw that the schooner *Brune*, of Bridgwater, had stranded near Highbridge Pill, and that the crew had been compelled to take to the rigging. The wind was blowing a hurricane from W.N.W. at the time. The Life-boat *Cheltenham* was immediately launched, proceeded as quickly as possible to the sunken vessel, and took seven men from the rigging, two of them being in a most exhausted state. The men were safely landed at Highbridge at 9.30 P.M.—Expense of service, 14*l.* 18*s.*

Aug. 7.—A sudden gale of wind sprang up at about 4 P.M., accompanied by a heavy cross sea, and four schooners were observed with signals of distress flying. The Porthdinllaen Life-boat *George Moore* was immediately launched, and proceeded to the *Thetis*, of Pwllheli, when it was found that she had struck the ground and was leaking, there being four feet of water in her hold. Two of the Life-boatmen were put on board to assist in keeping her afloat, and the Boat then proceeded to the *James*, of Nefyn, and found that she only required assistance to come to the quay. She then went to the *Jane Eliza*, of Nefyn, but she did not require any help. Finally the Life-boat proceeded to the *Sarah Jane*, of Chester, and as the captain's wife was very ill and wished to be taken ashore, she was taken into the boat and safely landed at Porthdinllaen.—Expense of service, 8*l.*

Aug. 8.—The Porthdinllaen Life-boat put off again, and rendered assistance to the schooner *Thetis*.

Aug. 8.—The Newquay, Cornwall, Life-boat *Pendock Neale* rescued the crew, consisting of two men, of the smack *Harriette*, of Barnstaple, bound from Swansea for Hayle with coal. The vessel had gone ashore on the rocks at the east end of Crantock Beach, about three miles from Newquay, and became a total wreck in a very few minutes. The two men took to their boat, and remained under the shelter of a large rock called the Goose until rescued by the Life-boat. The wind was blowing a fresh N.N.W. gale, and the sea was very heavy at the time.—Expense of service, 16*l.* 6*s.*

Aug. 14.—Information was received at 6 A.M.

that the smack *Excel*, of Grimsby, was on shore off Waxholme Mill. The *Admiral Rous* Life-boat, stationed at Withernsea, Yorkshire, was launched, but was driven back by the heavy surf. After considerable difficulty, the crew and launchers having to go up to their waists in the water to push the boat out, she was at last got off, and succeeded in rescuing four men. One of the crew, against the advice of his shipmates, had tried to get ashore in the smack's boat: but it was filled by the heavy sea, and the man with very great difficulty reached the shore by swimming.—Expense of service, 10*l.*

Sept. 2.—Voted also 120*l.* 7*s.* to pay the expenses of the West Wittering, Pembrey, Fishguard, Padstow, Deal, Broadstairs, and Kessingland Life-boats, in assembling their crews or putting off, in reply to signals of distress, to vessels which did not after all require their assistance.

Sept. 15.—The schooner *Jane Smith*, of Plymouth, bound from Llanelly to Ipswich with coal, was observed running for St. Ives Harbour at about 8 A.M., during a strong gale from the N. and heavy sea, with a signal of distress flying. The St. Ives Life-boat *Exeter* was at once launched, and proceeded to her assistance, but in the meantime the vessel struck on the "Ridge," and it was with considerable difficulty that the boat managed to get alongside and rescue the crew, consisting of six men. She then returned ashore against the gale, a strong tide setting to the eastward, and reached the harbour at about 9.30, when the men were safely landed in an exhausted state.—Expense of service, 8*l.* 15*s.*

Sept. 15.—The Clovelly Life-boat was launched during a heavy gale from the N., and rescued the crew, consisting of three men, from the smack *Delabole*, of Fowey, bound from Par to Swansea with a cargo of granite blocks. The vessel had lost her main sheet, mainboom and gaff, and her cargo had shifted; she subsequently sprang a leak, and sank during the following night. At the time of launching the Life-boat the tide was half ebb, with a heavy sea, and the crew were completely drenched before the boat could be got afloat.—Expense of service, 11*l.* 3*s.*

Sept. 15.—A very strong gale from the N.N.E., accompanied by a heavy sea, prevailed at Fishguard, South Wales. The smack *Catherine*, of Cardigan, bound thence to Swansea, in ballast, and the brigantine *Osnabrick*, of Papenberg, Hanover, bound from Sundsvall, Sweden, to Cardigan, with timber, were at anchor in the roadstead, and, as both were riding very heavily, a sharp look-out was kept on them during the day, as it was fully expected that the services of the Life-boat would be required. At about 5.45 P.M. a signal of distress was hoisted by the smack, and the Fishguard No. 1 Life-boat, *Sir Edward Perrott*, was at once launched, and went out splendidly through the broken sea. She took off the smack's crew of two men, and then proceeded to the brigantine to ascertain whether any aid was required; the master, however, declined any help, as he was in hopes that the gale was breaking up, and he thought that his vessel would be able to ride it out, as she had three anchors ahead. The boat then

returned ashore and landed the smack's crew in safety. At 10 o'clock, just as the Life-boat had been placed in her house, the brigantine burnt signal lights, having parted her principal chain. The boat was immediately taken out again and proceeded to the vessel; but before she reached her the two remaining chains had given way, and she rapidly drifted on the sands, where a fearful sea was washing over her. As she had stranded in the midst of the broken water, considerable difficulty was experienced by the Life-boatmen in taking off her crew, the boat being several times completely filled; however, this was eventually accomplished, and the crew, consisting of six men and the captain's wife, were brought ashore in safety.—Expense of services, 18*l.* 19*s.*

Sept. 16.—The schooner *Bonne Adele*, of Isigny, France, bound to that port from Llanelly, with coal, parted her cables and drove ashore about a quarter of a mile west of Hayle Bar during a strong N. gale and heavy sea, at about 3 P.M. The Hayle Life-boat *Isis* was launched, and after a hard pull against the gale and heavy sea, succeeded in reaching the vessel, took off her crew of five men and landed them safely at Hayle at about 5.15.—Expense of service, 7*l.* 5*s.*

Sept. 20.—At about 12.30 A.M., the ship *Paul Boyton*, of Yarmouth, N.S., 1097 tons, bound from Baltimore to Hamburg with a cargo of maize, went ashore on the Goodwin Sands during a fresh wind from the W. and heavy sea. The Ramsgate Life-boat *Bradford* proceeded to the vessel in tow of the harbour steam-tug *Aid*, and the North Deal Life-boat also went to her assistance. Two steam-tugs, the Walmer Life-boat, and some other boats also arrived, and efforts were made by means of towing, pumping, and throwing part of the cargo overboard, to get the ship afloat; but all were in vain, and as it was found that the water was gaining on her, all hopes of saving her had to be abandoned, and the crew determined to leave for the shore. Thirteen of the crew and nine boatmen were then taken into the Deal Life-boat and safely landed at Deal. The Ramsgate Life-boat took three of the crew on board, but the master and mate refused to leave the vessel. The boat then sheered off to her anchor, where she remained until after high water. The master and mate still refusing to leave the vessel, although she had by this time fourteen feet of water in her hold, the boat made sail for the tug. The master then hailed her to come alongside to take the mate and himself off; but owing to the heavy sea the boat was unable to get alongside; she was, however, dropped under the vessel's stern, and the two men lowered themselves from the end of the spanker-boom into the Life-boat, and were thus saved at great peril to the Life-boat and to themselves. The boat then proceeded to the steamer, was taken in tow, and arrived in Ramsgate Harbour at 3 P.M.—Expense of Deal service, 17*l.* 12*s.* 6*d.*

Oct. 1.—At 4 P.M. the Whitby Life-boat *Harriott Forteach* was launched and put four of the crew of a Cornish fishing-boat, the *Matchless*, on board their vessel, which was riding at anchor near Whitby Rock, and was in great danger in consequence of a very strong wind and heavy sea having suddenly sprung up.

The Life-boat also brought ashore a man from a coble which was unable to make the harbour or to land on the beach.

Oct. 5.—At about 9 A.M. the brig *Frannaes*, of Brevig, Norway, was observed to be making for Hartlepool, in tow of a steam-tug, during an easterly gale and in a heavy sea. She grounded on Middleton Beach and filled with water, and signals of distress were shown from her, whereupon the *John Clay Barlow* Life-boat, stationed at Hartlepool, proceeded to her assistance, and took off the crew of seven men and the pilot. The vessel afterwards broke up. She was bound from Brevig to West Hartlepool, with a cargo of pit props and mining timber.—Expense of service, 6*l.* 10*s.*

Oct. 7.—Voted 147*l.* 11*s.* 6*d.* to pay the expenses of the Life-boats at Courtown, Exmouth, Teignmouth, Skegness, Burnham, Carmarthen Bay, St. Ives, Walmer, Appledore, Saltburn, Penarth, and Caister, in putting off in reply to signals of distress shown by vessels which did not ultimately require the aid of the boats.

Also the Second Service Clasp of the Institution to JAMES MURPHY, Assistant Coxswain of the St. Ives Life-boat, in acknowledgment of his skilful and intrepid services in the boat on the occasion of the rescue of the crew of the schooner *Jane Smith*, of Plymouth, on the 15th of September.

Also the thanks of the Institution, inscribed on vellum, to Mr. T. B. WILLIAMS, Honorary Secretary of the St. Ives branch, and to Captain JOHN HODGE, a member of the St. Ives Life-boat Committee, both of whom went out in the Life-boat on the above-named occasion.

Also the thanks of the Institution, inscribed on vellum, to Captain D. GEORGE, Lloyd's sub-agent at Fishguard, for taking command of the Fishguard Life-boat twice on the 15th September, when she saved the crews, numbering in all nine persons, from the smack *Catherine*, of Cardigan, and brigantine *Osnabrick*, of Papenburg, Hanover.

Also the thanks of the Institution, inscribed on vellum, to Mr. T. G. PEARSON, Honorary Secretary of the Saltburn branch of the Institution, who went out in the Saltburn Life-boat on the 1st of October, with the view of assisting some fishing-cobles.

Oct. 7.—The Aberystwith Life-boat *Lady Haberfield* put off at about 8 A.M. to the aid of the Danish brig *Julia*, which was showing a signal of distress in the bay during a strong E.N.E. wind. On reaching her it was found that she had lost her course, and one of the Life-boatmen was therefore put on board to pilot her. She was on a voyage from the Baltic to Aberdovey with timber, and carried a crew of seven men.—Expense of service, 9*l.* 13*s.*

Oct. 9.—In the morning a heavy sea rose up off Cullercoats, and as several cobles had gone out early, either fishing or piloting, it was feared that some accident might occur to them in coming in over the bar. The Life-boat *Palmerston* was therefore launched, and accompanied each of the boats, as they arrived, safely over the bar. In two instances the danger was considered to be so great that the crews were taken into the Life-boat, and the cobles were towed ashore. These services occupied some

hours, and the Life-boatmen being exhausted by the repeated rowing about in the heavy sea, a fresh crew were taken in the boat, when she again went out and took the crew of another coble on board, and towed the boat safely ashore. Fourteen boats in all were thus assisted by the Life-boat, and eleven men of their crews were taken on board her.—Expense of service, 10*l.* 10*s.*

Oct. 10.—On the 6th October the trawler *Dr. Kenealy*, of Hull, when about 150 miles from the Humber, found the Russian schooner *Eva*, of Abo, dismantled, and abandoned by her crew. She took her in tow, and two of the trawler's crew were put on board. When abreast of Spurn Lighthouse on the 10th October the tow-rope became detached, and the schooner ultimately became a total wreck near Tetney Haven. Signals of distress were exhibited by the two fishermen on board, and the Life-boat *Richard*, stationed at Donna Nook, went to their assistance, and rescued them. The weather at the time was very stormy, a strong gale of wind blowing from the N.E., accompanied by a rough sea.—Expense of service, 17*l.* 16*s.*

Oct. 11.—The *Parsee* Life-boat, stationed at Palling, Norfolk, was launched to the aid of the barque *Saga*, of Carlshamn, Sweden, which had stranded on the Hasborough Sand during a strong N.E. wind and heavy sea. She had previously grounded on the Leman and Ower Sands, but had floated off in a very damaged condition, and had then been abandoned by her crew. The Life-boat remained alongside the vessel until she again floated, when, with the aid of steam-tugs, she was taken to Harwich.

Oct. 22.—In the morning, during rough weather, the Looe Life-boat was launched and proceeded through a heavy ground sea to a small fishing-boat named the *Ada*, of Devonport, which had lost her foresail, jib, and mizen, and had become unmanageable. She was fast drifting on to a dangerous reef of rocks, and would undoubtedly have been wrecked had not the Life-boat promptly moored her in a safe position, after which she took her crew of two men safely ashore, amidst the cheers of the spectators. The two men were quite benumbed with the cold, and they expressed their deep gratitude for the help they had received, stating that they had given up all hope of being saved.—Expense of service, 9*l.*

Oct. 22.—The Pakefield Life-boat *Two Sisters, Mary and Hannah*, put off to the assistance of the schooner *Effigo*, of Goole, which had stranded on the Newcome Sand during a strong E. breeze. The vessel had floated off, and was riding at anchor when the Life-boat arrived. Some of the Life-boatmen boarded her, and found that she was leaking, and that her rudder was unshipped. The Lowestoft tug, which was alongside, took her in tow, and with the assistance of the Life-boat in steering her, she was taken safely into harbour. She was bound from London to Goole, with wheat, and had seven persons on board.

Oct. 26.—The brigantine *Victoire*, of Irvine, bound thence to Dublin with a cargo of coal, showed signals of distress when about two miles east of Ramsey Harbour. The wind was blowing from the E.N.E. at the time, and the sea

was very heavy. The Ramsey Life-boat *Two Sisters* was with much difficulty launched, and succeeded in bringing the vessel, which had a crew of five men on board, safely into harbour.

Oct. 27.—The same Life-boat went, in a heavy sea, to the assistance of the brig *William Hill*, of Dundalk, which had shown signals of distress while lying in the bay about two miles from the shore. It was found that the vessel's cable had given way, and that she was rolling heavily. With the aid of the Life-boat this vessel was also brought safely into harbour. She was on a voyage from Dundalk to Ardrossan, in ballast, and carried a crew of five men.

Oct. 27.—About 7 p.m. the brig *Naiad*, of Whitby, bound from London to Hartlepool, in ballast, was endeavouring to enter Hartlepool Harbour, but owing to the easterly gale blowing at the time, and a very heavy sea, she stranded on Middleton Beach. The Life-boat *John Clay Barlow*, stationed at Hartlepool, put off and remained by her for about two hours, when steam-tugs succeeded in getting her off, and towed her safely into harbour.—Expense of service, 8*l.* 15*s.* 6*d.*

Oct. 27-8.—On the night of the 27th October the schooner *Robert Brown*, coal-laden, and with a crew of four men, was overtaken by a gale from E.N.E., with a heavy sea and, becoming unmanageable, was driven ashore near the Pigeonhouse Fort in Dublin Bay. Before striking the ground, one of the crew was washed overboard by a heavy sea and drowned, and immediately after her grounding another was swept away and lost, the two survivors securing themselves to the rigging. Without any means of making known their perilous condition, they were undiscovered until after daylight on the morning of the 28th, when they were first seen by a Coastguardman from the shore.

Unfortunately, the Coastguardmen who form the usual crew of the Poolbeg Life-boat were absent on board H.M.S. *Belleisle*, the Coastguard ship at Kingstown, undergoing their periodical drill.

Thus considerable time was lost before a sufficient number of seafaring men, or practical boatmen, could be found. Fortunately, however, though "blue jackets" were scarce, "red-jackets" were at hand, and quickly a number of soldiers from the Fort, led by Lieutenant J. A. W. O'Neil Torrens, of the Second Dragoons (Royal Scots Greys), and Dr. H. L. Cox, of the Army Medical Department, together with a few boatmen, dragged the Life-boat from its house to the shore, where, with great difficulty and some risk of life, it was launched, Lieutenant Torrens taking the helm and command, and three private soldiers, viz., Wm. Smith, bombardier Royal Artillery; P. Howard, private 57th Regiment, and F. Reilly, private Army Service Corps, together with five fishermen and three seamen, forming the crew.

Before leaving the shore the boat was badly stove, the spot where it was necessary to launch being thickly strewed with boulder-stones, and abounding with stumps of broken piles projecting through the beach. In fact, the mere getting it afloat and clear of the shore was a most dangerous work, not only to those in it,

but to the large number of soldiers and others who, under the guidance of Dr. Cox and Mr. B. W. Jackson, chief engineer of the Government hired steamer *Stanley*, strenuously worked, often up to their waists in water. The boat, at one moment floated high by the sea, was the next dashed again on the stones, and only saved from destruction by its great strength and peculiar build, whilst those who stuck manfully to it ran serious risk of losing their lives by being drowned or crushed beneath it.

But, through indomitable pluck and energy all round, the boat was got at last afloat, and, after half an hour's severe struggle with the waves, reached the sunken craft and rescued the two survivors of her crew, who, half dead from exposure and cold, were safely landed and carried by the soldiers to their barracks, where they received every possible attention, and were so far recovered on the following day as to be able to proceed on their way.

Voted the Society's Gold Medal to Lieutenant Torrens, and its Silver Medal to the three soldiers who accompanied him, and to Dr. Cox; also the thanks of the Institution, inscribed on vellum, to Mr. Jackson, and thanks and 24l. 13s. 6d. to the non-commissioned officers and private soldiers who launched the boat.

Oct. 28.—The brigantine *Folkestone*, of Folkestone, was seen to be making for Hartlepool at about 8 P.M., during a hurricane from the E.N.E. As she showed signals of distress, the *Charles Ingleby* Life-boat, stationed at Hartlepool, put off to her assistance, and finding that all her sails had been blown away, and that she was unmanageable, her crew of seven men were taken on board the Life-boat, and were safely landed. The vessel, which was bound from Folkestone to Sunderland, in ballast, afterwards drifted ashore near Middleton.—Expense of service, 13l. 12s.

Oct. 28.—About noon a vessel was observed to be fast drifting on Whitby Rocks. She, however, succeeded in clearing the rocks, and was driven with tremendous force on the beach. The wind was then blowing a hurricane from the E.N.E., and the sea was extremely high. The Whitby Life-boat *Robert Whitworth* put off to her assistance, and with great difficulty and danger succeeded in rescuing her crew, consisting of four men. She proved to be the schooner *Reaper*, of Douglas, bound from Ostend to Sunderland, in ballast.—Expense of service, 15l. 0s. 10d.

At 1.30 P.M. a large fishing yawl, the *Good Intent*, of Staithes, was observed running for Whitby Sands, and as it was evident that she was in great distress, the Life-boat again put off through a fearful sea, and, with great danger and difficulty, saved the crew, consisting of eight men.—Expense of service 16l. 10s. 9d.

At 4.30 P.M. the schooner *John Snell*, of Great Yarmouth, bound thence to Newcastle, with a cargo of wheat, was also seen to be making for the beach. It was feared that she would not succeed in reaching the shore, as the tremendous seas continually swept over her, completely hiding her from view at times. She fortunately, however, kept her steerage-way, and eventually struck the beach. The same Life-boat, after being pulled for some distance through the

seething mass of broken water, ultimately reached the vessel, and succeeded in landing her crew, consisting of five men.—Expense of service, 16l. 10s. 9d.

At 3.15 P.M. the schooner *Elizabeth Austin*, of Rye, bound thence to Sunderland, in ballast, was seen to be drifting rapidly towards the beach. The second Life-boat at Whitby, the *Harriott Forteath*, was immediately launched, and, upon the vessel stranding, her crew of five men were with difficulty taken into the Life-boat and brought safely ashore.—Expense of service, 15l. 0s. 9d.

Oct. 28.—At about 1.30 A.M. it was reported that a vessel was ashore on the Langhorne Sands, about eight miles west of Ferryside, Carmarthen Bay. The wind was blowing a gale from the S.W., with heavy squalls, and the sea was heavy. The Ferryside Life-boat *City of Manchester* was launched, and after a severe pull against the wind and sea, she succeeded in reaching the vessel, which proved to be the schooner *Magdalen Esther*, of New Quay, bound from New Ross to Cardiff with pitwood. She had carried away both her anchors, and had stranded on the sands. She had lost her bulwarks and foremast, and the sea was breaking completely over her. Her crew of four men were taken into the Life-boat and brought safely to land.—Expense of service, 15l. 15s.

Oct. 28.—Rockets were sent up from Batten Coastguard Station, Plymouth, during a very heavy gale from S.W. to W.S.W. The Plymouth Life-boat *Clemency* went out to render assistance to any vessel in distress, and found four vessels ashore. The crews of three of them had been taken off by the rocket apparatus, but the fourth, the schooner *Fortuna*, of Grimsby, was found sunk about a mile and a half from Batten, with her crew, consisting of three men, lashed in the rigging. The Life-boat succeeded in taking the men off the wreck, and brought them safely ashore. The schooner was bound from Wales to London with a cargo of paving-stones.—Expense of service, 13l. 5s.

Oct. 28.—The schooner *City of Bangor*, of Bangor, was seen riding heavily at her anchors in Porthdinllaen Bay during a heavy N.E. gale, at about 9 A.M. In reply to her signals of distress the *George Moore* Life-boat, stationed at Porthdinllaen, put off to her, and found that she had just parted one of her chains, and as there was a likelihood of her parting the other, the crew, four in number, wished to be brought ashore. With considerable difficulty they were taken into the Life-boat and landed at Porthdinllaen.—Expense of service, 7l. 17s. 6d.

On the following day the Life-boat again went off, and rendered assistance to the same vessel.

Oct. 28.—During a severe storm, at about 9.30 A.M., the brig *Mary*, of South Shields, in trying to make Scarborough Harbour, was driven on shore by the wind and heavy sea. The Life-boat *Lady Leigh* was launched, and, after a severe struggle, reached the vessel, and saved her crew of six men and a boy. A minute or two after the crew had been taken off, the vessel's mainmast broke close by the deck, and fell overboard with a crash, taking with it the foretopmast. The crew, and also

the Life-boat, had a very narrow escape.—Expense of service, 11l. 3s.

At 11 A.M. the Life-boat again went out, and rescued the crew of five men from the schooner *Black-Eyed Susan*, of Bideford, which had also gone ashore, and subsequently broke up. The Life-boat had to be pulled with great difficulty along the front of the Spa, being amongst heavy breakers the whole of the time.—Expense of service, 11l. 3s.

At about 3 P.M., the brig *Jeune Adolphe*, of Nantes, went ashore on the South Sands, and the Life-boat immediately went to her assistance, and saved her crew, consisting of eight men.—Expense of service, 11l. 13s.

At about 8.30 P.M., the Life-boat was launched for the fourth time this day, and rescued the crew, consisting of four men and the master's wife, from the sloop *J. Prizeman*, of Plymouth, which had also stranded. This service was even more difficult and dangerous than the previous ones, as it was now dark, and the gale had, if possible, increased in its fury.—Expense of service, 20l. 1s.

On the following morning the gale had somewhat moderated, after a terrible night; but the sea was still very rough. At about noon the Dutch galliot *Herbruder* went ashore, and the Life-boat was again promptly manned, and brought safely ashore the crew of three men.—Expense of service, 11l. 13s.

Oct. 28.—During the night of the 27th October the wind blew a very heavy gale from the W.S.W., and early on the morning of the 28th signals of distress were observed from the direction of Trescoe. The Scilly Islands Life-boat *Henry Dundas*, went out, and found the brig *Messenger*, of Salcombe, lying on the reef. The rocket apparatus had just established communication, but the hawser had fouled. Five of the crew were taken off by the Life-boat, the captain and two men remaining by the vessel. The Life-boat stayed by her until daylight, and then returned to the shore. The vessel afterwards floated; she was bound from Cardiff to Portsmouth, with steam coal.—Expense of service, 14l. 6s.

Oct. 28.—A schooner was observed at daylight in a dangerous position midway between Piel and Fleetwood; she had a signal of distress flying, and was apparently drifting helplessly in the heavy gale which was then blowing from the E.N.E. The *William Birkett* Life-boat, stationed at Piel, proceeded to her, and found that although she had three anchors down, she was dragging them fast, and was drifting to leeward. At the master's request the Life-boat remained alongside the vessel until a steam-tug arrived, and towed her and the Life-boat safely into Piel. She was the schooner *Jane Hughes*, of Carnarvon, from Morecambe to Duddon.—Expense of service, 8l. 5s.

Oct. 28.—The West Hartlepool Life-boat *Rochdale* proceeded to the assistance of the schooner *Royal Albert*, of Maldon, which was in imminent danger during a hurricane from the E.N.E. The vessel's crew of five men were taken into the Life-boat, and the schooner afterwards beat up alongside the pier and became a total wreck.—Expense of service, 22l. 11s. 6d.

Oct. 28.—In the afternoon of this day the North Sunderland Life-boat *Joseph Anstice* put off in a very heavy sea, and rescued the crew, consisting of nine men, from the Swedish brig *Alice*, which was totally wrecked under Bamborough Castle.—Expense of service, 12l. 7s.

Oct. 28.—It was reported in the morning that a vessel was ashore about a mile south of Redcar pier. The Redcar Life-boat *Burton-on-Trent* was launched, and succeeded in rescuing the crew, consisting of seven men. She proved to be the brig *Emanuel Butcher*, of Whitby, bound to that port from Rotterdam, in ballast. Her sails had been blown away, and she ultimately became a total wreck.—Expense of service, 19l. 17s.

Oct. 29.—The brig *Hazard*, of Grimstead, bound from that port to Dover, in ballast, showed signals of distress off Redcar. She appeared to be trying to work off the land, but could not do so, owing to the heavy wind and sea. When close in shore, and near the breakers, she was headed to the land and run ashore. The Life-boat went to her, rescued the crew, numbering nine men, and landed them at Marske.—Expense of service, 19l. 4s.

Oct. 29.—The brig *Sharon's Rose*, of Whitby, bound from Shields to Dieppe, with coal, was seen to run on the beach at Holkham during a strong breeze from N.N.E. and a very heavy sea, at about 1 P.M. The *Eliza Adams* Life-boat, stationed at Wells, Norfolk, proceeded to her aid, and succeeded in rescuing the crew, numbering seven men. The boat was then taken in tow by the steam-tug *Promise*, of Wells, and the shipwrecked men were safely landed at Wells Quay.—Expense of service, 7l. 10s.

Nov. 1.—At about 3 A.M. signals of distress were observed off Caister, Norfolk, and the Life-boat *Covent Garden* put off. She proceeded in the direction of the signals, across the Scroby Sand, and found the fishing smack *Iron Duke*, of London, drifting with her cable paid out, but no anchor, close to the Middle Cross Sand; she had also lost her mainmast. The Life-boatmen boarded her, hove in her cable, and, with the aid of a steam-tug, took her, with her crew of six men, safely into harbour. The vessel had been in tow of another smack, but had got adrift during the night.

Nov. 4.—Voted also 426l. 19s. to pay the expenses of the Life-boats at North Berwick, Piel, Penarth, Giles's Quay, Penzance, Cleethorpes, Wells, Kessingland, Falmouth, Poole, Caister, Donna Nook, Barmouth, Cahore, Bridlington, Fleetwood, Holy Island, Hope Cove, Newbiggin, Courtown Middlesborough, Humstanton, Seaton Carew, Gorleston, Winterton, Palling, Skegness, Theddlethorpe, Cresswell, Montrose, Drogheda, and Chapel, in assembling their crews or putting off to the aid of vessels not ultimately needing the assistance of the boats.

The Ramsgate Lifeboat had also been out in reply to distress signals, but her services were not eventually needed.

Voted the Silver Medal of the Institution, and a copy of the vote inscribed on vellum, to JOHN OWSTON, coxswain of the Scarborough Life-boat, in acknowledgment of his general gallant services in that boat, and particularly



for going out four times in the Life-boat during the severe gale of the 28th and 29th October, and assisting to rescue the crews, numbering in all twenty-eight persons, from five different wrecks.

Extra rewards were also granted to the crew of the Life-boat for their gallant exertions on these occasions.

Also the Second Service Clasp of the Institution to HENRY FREEMAN, coxswain of the Whitby Life-boats, in acknowledgment of his gallant services in taking command of the Life-boats on four occasions on the 28th October, and assisting to save the crews, numbering in all twenty-two men, from four distressed vessels.

Extra rewards were also granted to the crews of the Life-boats for their gallant conduct on these occasions.

Nov. 6.—At 7 P.M. the Caister Life-boat *Covent Garden* put off to the s.s. *Swan*, of Liverpool, which had gone on Hasborough Sand. With the aid of two steam-tugs the vessel, which was leaking badly, was taken to Harwich.

Nov. 14.—At about 5.30 P.M. an easterly gale sprang up, accompanied by a heavy sea. The schooner *Ada*, of Beaumaris, bound from Plymouth to Runcorn, with china clay, had taken refuge in Ramsey Bay, as she was leaking badly, and her crew had been for forty-eight hours at the pumps. As the gale increased she slipped her cable and ran for the harbour, but missed it and went ashore. The *Two Sisters* Life-boat, stationed at Ramsey, proceeded to her assistance, and safely landed her crew of four men, who were in a very exhausted condition.—Expense of service, 15*l.* 6*s.*

Nov. 14.—At 11 P.M. signals of distress were shown by the schooner *Queen of the Isles*, of Carnarvon. The wind was blowing a whole gale from the N.N.E., and a heavy sea was running. The *George Moore* Life-boat, stationed at Portdinllaen, proceeded to her, and brought ashore her crew of three men.—Expense of service, 14*l.* 7*s.* 6*d.*

Nov. 16.—At about 1 P.M. the gale again sprang up, accompanied by a very heavy sea, and the schooner's crew, who had meanwhile gone back to her, were afraid that she would part her chains. They therefore made signals of distress, in response to which the Life-boat went out and again brought them ashore.—Expense of service, 7*l.* 12*s.* 6*d.*

Nov. 16.—The *Ladies' Own* Life-boat, stationed at St. Andrews, N.B., put off on the morning of the 16th November to the assistance of the schooner *Roseneath*, of Hull, which was near the breakers on the sandbanks off St. Andrews during a strong E. gale and very heavy sea, accompanied by heavy showers of sleet. It was found that the master had lost his reckoning. His real position was explained to him, and as the wind had then veered round to the N. he made sail to the eastward, and proceeded out of the bay.—Expense of service, 12*l.* 8*s.* 6*d.*

Nov. 16.—At about 5 A.M., in reply to signals of distress, the Caister Life-boat *Covent Garden* proceeded to the Middle Scroby Sand, and found the s.s. *Ringdove*, of Liverpool, ashore there in the midst of the breakers. With great difficulty and risk the Life-boat succeeded in getting near

the vessel, and communication having been effected, some of the shipwrecked men were hauled on board the Life-boat by means of lines, and as the stern of the Life-boat sheered to the ship, others of the crew came down the mizzen rigging, and eventually sixteen men were got on board. Only one seaman remained; he was lowering himself down by a rope, when he was unfortunately crushed between the boat and the ship, and perished. Heavy seas were breaking over the boat and ship all the time. The vessel was on a voyage from Riga to Newport, Mon.—Expense of service, 25*l.*

Nov. 16.—At 12.30 P.M. the schooner *Jane Louisa*, of Londonderry, bound from Liverpool to Dublin, with a cargo of coal, was seen in distress outside Holyhead breakwater during a heavy N. gale and very high sea. The Life-boat *Thomas Fielden* went to her assistance in tow of a steam-tug, and with great difficulty put six men on board the vessel to assist, and eventually she was towed safely into the old harbour. She had a crew of five men.

Nov. 20.—During a fresh gale from the E.N.E., with snow and hail, signals were fired by the Goodwin Sands Lightships, and a barque was seen ashore on the Sands. The Ramsgate Life-boat *Bradford* proceeded to her assistance, in tow of the harbour steam-tug *Vulcan*, and when nearing her the masts were seen to fall over. The Life-boat was then slipped from the tug, and made sail for the vessel. On arriving near, the boat's anchor was let go, and she was veered in to leeward among the wreckage, but could not get alongside. The crew of the barque then watching their opportunity between the heavy seas, which were breaking completely over the vessel, climbed along the broken masts to the Life-boat, and thus the whole of the men, eleven in number, were rescued. The barque was the *Freden*, of Krageroe, Norway, with a cargo of deals.

Nov. 22.—At about 10 A.M. a strong E.S.E. wind sprang up, and the sea became very heavy off Montrose, N.B. About thirty of the Ferryden fishing-boats had proceeded to sea earlier in the morning, and several of them ran back, some of them losing their lines. At about noon some of the boats were seen to be in considerable danger, and the Montrose Life-boat *Mincing Lane* went out and attended about twenty of them safely over the bar. The last one—the *Nautilus*—a large decked herring boat, went broadside on to the sea, in a lull, when approaching the bar, and would have been driven on to the rocks and lost, had not the Life-boat got a line from her and towed her clear of the rocks and safely over the bar. She had a crew of six men.

Nov. 22.—The *Thomas Wilson* Life-boat, stationed at Whitburu, brought ashore eight men from the steam-tug *Crusader*, of Sunderland, which had stranded on Whitburn Rocks during foggy weather. The eight men had gone on board to try to get her afloat, but towards high water a very strong sea rose, and they were compelled to make signals for the Life-boat.—Expense of service, 14*l.* 10*s.*

Nov. 23.—The *Flamborough* No. 2 Life-boat went out at about 10.45 P.M., and rescued the crew, consisting of eight men, from the brig

*Tartar*, of Salcombe, which was wrecked on the rocks off Flamborough during a S. by E. gale and very heavy sea. The vessel was on a voyage from Whitstable to Shields with a cargo of chalk.—Expense of service, 18l.

Nov. 23.—At about 3 A.M. the Montrose Life-boat *Mincing Lane* put off to the aid of a schooner which was reported to be showing signals southward of Montrose. With great difficulty and danger the Life-boat was forced over the bar, on which the sea was breaking very heavily, and went alongside the vessel. She proved to be the *Morton Castle*, of Montrose, bound to that port from Sunderland, with coal. She was waiting for a tug, but was in a very perilous position near the rocks, and in much danger of being driven on to them. The master, on account of the foggy haze, was not aware that he was so near them, and on being informed of his position, all sail was made, and a light breeze from the N.W. springing up, the vessel was enabled to stand off. Had it not been for the Life-boat there is little doubt that the vessel would have gone on the rocks, and that her crew of five men would have been lost.

Nov. 23.—In the evening a steamer was reported to be ashore about a mile northward of Staithes, Yorkshire. The Staithes Life-boat *Hannah Somersel* put off to her assistance, and found she was the s.s. *Madeline*, of West Hartlepool, bound from the Baltic to Grimsby. The Life-boat remained by the vessel during the night, at the request of the master, in readiness to land the crew if necessary; but fortunately her services were not further needed.

Nov. 23.—The St. Andrew's Life-boat put off and rendered assistance to two fishing-boats which were in danger while making for the harbour.

Nov. 25.—In the morning during a fresh gale from the W.S.W., and a heavy sea, the barque *Haab*, of Moss, Norway, bound from New York to Rotterdam, with a cargo of grain, grounded on the outer end of the Roar Bank off this part of the coast, and commenced to strike heavily on the sand. After a time she hoisted a signal of distress, in response to which the Lydd Life-boat *David Hullett*, and the New Romney Life-boat *Dr. Hatton*, promptly proceeded to her assistance. She was found to be in a leaky state when the Life-boatmen boarded her, but in the course of an hour or so she was got afloat and proceeded to Dover, which, with the help of steam-tugs, was reached in safety, the Life-boats keeping in company in case of accident, and some men of their crews helping at the pumps.

Nov. 26.—The schooner *Braes of Moray*, of Peterhead, was observed ashore on the Out Cars rocks, at about 6 A.M., on the 26th November. The Newbiggin Life-boat *William Hopkinson of Brighthouse*, was at once got out, several of the fishermen's wives assisting to launch her, and the boat then proceeded through a very heavy sea, to the vessel. The wind was blowing a strong gale from the S.E. On reaching her it was found that she was fast filling with water; the crew of five men were then taken into the Life-boat, and safely landed. Before the boat regained the shore, nothing could be seen of the vessel except a small portion of her topmast.—Expense of service 18l. 15s. 6d.

Nov. 26.—During a gale of wind from the W.S.W., with rain, the schooners *Caroline* and *Phœnician*, at anchor in Scrabster Roads, exhibited signals of distress, in response to which the Thurso Life-boat *Charley Lloyd* was launched, and brought ashore their crews, numbering eight men.—Expense of service, 9l. 12s.

Nov. 26.—On the night of the 26th November intelligence reached the Carnsore, Co. Wexford, Life-boat station that a ship was in distress about two miles and a half to the westward of Kilmore, which is twelve miles from Carnsore. Without loss of time the coxswain procured horses, and the Life-boat started on its carriage by land, arriving at Kilmore about 7 o'clock on the following morning. The coxswain, however, thought it would not be desirable to launch the boat there, so he took her to Ballyhealy, where, after some delay, a volunteer crew was mustered and the boat launched. All efforts to make the wreck were, however, unsuccessful, principally on account of the very heavy seas and the wreckage floating about in the vicinity. Ultimately the boat returned to the shore, and remained there until the next morning, when her crew manned her and proceeded out. She was then happily the means of saving all on the stranded ship, consisting of the master, mate, fourteen seamen, a boy, and two women. The barque was the *John A. Harvie*, of Windsor, N.S., bound from New York to Dublin, with a cargo of Indian corn.—Expense of services, 40l. 11s.

Nov. 27.—At about 9 A.M. the *Robert William* Life-boat, stationed at Blackpool, proceeded to the aid of the barque *Medora*, of Laurvig, which was observed to be drifting into a dangerous position. One of the Life-boatmen was put on board the vessel and piloted her to Fleetwood, to which port she was bound with a cargo of timber.

Dec. 1.—The coxswain of the Swansea Life-boat received a telegram from the harbour-master at Port Talbot shortly before 5 P.M., stating that a vessel was ashore on Port Talbot bar. The wind was blowing from the N., with a heavy ground swell. The Life-boat *Wolverhampton* at once put off and proceeded to the vessel, which proved to be the schooner *Pet*, of Falmouth, bound thence to Port Talbot, with copper ore. Her crew of five men were clinging to the foretopmast rigging, and were in a most exhausted state. They were taken into the Life-boat, and landed safely at Port Talbot. The vessel became a total wreck. Expense of service, 14l. 4s.

Dec. 1.—The Thurso Life-boat went out in response to signals of distress shown from the schooner *Catherine and Ellen*, which had been overtaken by a strong gale from the N.N.W., and which had brought up far out in the bay. The crew of six men were taken into the boat and safely landed at Scrabster.—Expense of service, 6l. 12s.

Dec. 2.—Voted 261l. to pay the expenses of the Life-boats at Hornsea, Solva, Suttou, Kingstown, Tyrella, Newcastle Co. Down, Broadstairs, North Deal, Tenby, Holy Island, New Brighton, Broughty Ferry, Nairn, Kingsdowne, Brightstone Grange, and Longhope, in assembling their crews, or putting off to the aid of vessels which did not ultimately need their assistance.

The Ramsgate Life-boat had also been taken out, but her services had not been eventually needed.

Dec. 9.—The wind suddenly became squally, increasing to a gale from the W. off Ballywalter, Co. Down. A large open boat, manned by two men and a boy, and having but one broken oar on board, was swept some distance out to sea, as she was unable to stand up to her sail. As the gale was increasing, and the boat was in great danger and showing signals of distress, the Ballywalter Life-boat *Admiral Henry Meynell* put off to her assistance, and brought her safely ashore.—Expense of service, 5*l.* 16*s.*

Dec. 10.—The Thurso Life-boat brought ashore the crews, numbering in all eighteen men, of the schooners *Caroline*, *Seaward*, *Phœnicium*, and *Reaper*. A very severe gale from the W.N.W. had suddenly sprung up, causing a tremendous sea in the bay, and had the wind gone a little more to the northward the sea would have been driven into Scrabster Roads, and the four vessels would have been in imminent peril of being wrecked.—Expense of service, 6*l.* 14*s.* 6*d.*

Dec. 13.—At noon a mounted messenger came to Exmouth from Budleigh Salterton, and reported a fishing-boat in great danger about three miles east of the former place. The *Victoria* Life-boat was speedily launched, and proceeded to the boat, which was found to be in danger of being driven on to the rocks, her crew being totally exhausted. The Life-boat took the boat in tow, and brought her and the four men on board safely to Exmouth.—Expense of service, 9*l.* 9*s.*

Dec. 18.—In the afternoon the brig *Warkworth Castle*, of Amble, bound to that port from Gloucester in ballast, drove ashore in a snow-storm on Bondicar Rocks, near the Hauxley, Northumberland, Life-boat station. Her signals of distress were observed, and the Coastguard, by means of the rocket apparatus, sent a line on board; the Life-boat *Algernon* and *Eleanor* also proceeded to the wreck through a rough sea. She soon reached the spot, and saved the crew of nine men, who were landed about 8 o'clock in the evening. On this occasion the women helped to launch the Life-boat, as many of the men were engaged with the Rocket Brigade.—Expense of service, 15*l.*

Dec. 9.—About 10 o'clock in the morning the brig *William Hill*, of Dundalk, was seen making for Ayr Harbour, during a S.W. gale.

She was unmanageable, from loss of greater part of her canvas and weakness of her crew from long exposure. In approaching the harbour, she struck the North Pier with considerable force, and drifted on to the gravel bank on the N. side of the harbour, where she was totally wrecked. The *Glasgow Workman* Life-boat, stationed at Ayr, was launched, and, after two attempts, reached the wreck and rescued three of the crew. The vessel carried a crew of five men. One of them had been washed overboard, and another died before he was brought ashore.—Expense of service, 26*l.* 1*s.* 3*d.*

Dec. 19.—During a very heavy gale from the W.N.W., the Ardrossan Life-boat *Fair Maid* of Perth, was launched, at 3.50 p.m., and rescued the crew, consisting of eight men, from the Swedish brig *Clio*, which had stranded at the back of the Montgomerie Street Breakwater while making for Ardrossan Harbour. The brig was bound from Troon to Demerara with coal.—Expense of service, 7*l.* 15*s.*

Dec. 23.—At 5.30 a.m., the *British Workman* Life-boat stationed at Palling, Norfolk, proceeded to the Hasborough Sand, in reply to signals of distress, during a strong W.N.W. wind and heavy sea. On arriving there, she found the s.s. *Earl Percy*, of Newcastle, ashore, having on board fifty passengers, a crew of twenty-one, and a general cargo. The Life-boat remained by her and rendered assistance, and after a time she came off the sand, with loss of rudder. A steam-tug then arrived and took her in tow, some of the Life-boatmen going on board her, and the Life-boat steering; but they had not gone far when the Life-boat broke adrift, and had to return to her station. The steamer completed her voyage in safety.

Dec. 24.—At 1 o'clock in the morning a flare was observed about a mile north of Winterton. The crew of the Life-boat *Husband* assembled, and the boat went out and found the schooner *Barbara*, of Carnarvon, stranded on the beach. She remained by her until 10 p.m., and then got her afloat and took her to Yarmouth. She was bound from Newcastle to London, with fire-bricks, tiles, and clay, and had a crew of four men.

Dec. 28.—The Theddlethorpe Life-boat brought ashore three men from the Danish schooner *Fortuna*, which had sunk near Saltfleet Haven. The Donna Nook Life-boat also put off to the aid of the vessel, and remained by her for some time.—Expense of services, 40*l.* 19*s.* 6*d.*

#### SHORE-BOAT SERVICES REWARDED IN 1880.

Jan. 1.—Voted the Silver Medal of the Institution, with a copy of the vote inscribed on vellum, to the EARL of DUNMORE, and 5*l.* to three fishermen, in acknowledgment of their gallant services in putting off in an open boat, and proceeding, at one o'clock in the morning, a distance of eleven miles through a very heavy sea, and bringing ashore the passengers, seven in number, of the yacht *Astarte*, of Glasgow, which vessel had sunk in the Sound of Harris, N.B., during a hurricane from the S.W., on the 22nd

September, 1879, those on board her having to take refuge on a small island.

Jan. 27.—Two men put off in a boat and assisted to save sixteen seamen belonging to H.M.S. *Hecla*, from a wherry which had been run into by a steamer off Portsmouth.—Reward, 2*l.*

Jan. 29.—Five men put off in a boat and saved four men from the boat of the schooner *Viscata*, of New Quay, Cardiganshire, which had sunk about twelve miles W. of Bardsey. The

men had been in the boat about twelve hours, and were much exhausted, having been pulling all night, and the weather being intensely cold.—Reward, 2*l*.

Feb. 5.—Voted 1*l*. to Mr. JOHN BYNOW, chief boatman in charge of H.M. Coastguard at Clontarf, Dublin, and 2*l*. to his crew of four men, for putting off in the Coastguard boat, at some risk, and saving the crew of seven men from the brigantine *Alice Woods*, of Ardrossan, which was wrecked on the North Bull, Clontarf, during a moderate easterly gale on the 20th November.

Feb. 11.—Mr. KENEALY, Coastguard Officer, and his crew of five men, put off in the Coastguard whale-boat, and saved, at some risk, the crew of four men from the smack *Ann*, of Dover, which had stranded off No. 2 Battery, Dungeness, Kent, during a strong E. breeze.—Reward, 7*l*.

Feb. 12.—Two men rescued two Coastguard-men, whose boat, while returning ashore from the Coastguard cutter *Stag*, had been capsized by a heavy sea in Skerries Roads.—Reward, 1*l*.

Feb. 15 & 16.—Thirteen fishermen put off in their boats from Blackrock, Co. Louth, and rescued the crews, numbering in all thirteen men, from the brigantine *Parkside*, of Whitehaven, brigantine *Stella*, of Drogheda, and schooner *Mary Ann*, of Annagasson, which had stranded at Blackrock during a gale from S.E.—Reward 9*l*.

April 4.—Mr. WILLIAM FYNES, Chief Boatman of H.M. Coastguard, and five other men, put off in the Coastguard boat from Ringsend, Dublin, and saved two men from a boat which was in distress off Pigeonhouse Point, during a fresh westerly gale.—Reward, 6*l*.

April 21.—Four men rescued two other men from a yawl which had been upset while boarding the Norwegian barque *Nora*, off Arthurstown, Co. Waterford, during a gale of wind from S.S.W.—Reward, 2*l*.

May 2.—Two men rescued two other men from a hooker which, while proceeding from Halfmace to Kinwarra, Co. Galway, with seaweed, had been struck by a sudden squall from the N.W., and capsized about a quarter of a mile S. of Mace Head.—Reward, 15*s*.

May 8.—Three men rescued four persons from a boat laden with seaweed, which was in a sinking condition at Island Crone, Co. Donegal, during a fresh N.E. gale.—Reward, 1*l*. 10*s*.

May 18.—Three men saved three persons from a skiff which, while crossing Carlingford Bar during a S.E. wind, had sunk, the boat being leaky, and a strong flood tide running at the time.—Reward, 1*l*. 2*s*. 6*d*.

June 11.—Three men put off in a curragh and saved two other men from a boat which had been capsized in Ballinakill Bay, Co. Galway, during a fresh S.W. wind.—Reward, 1*l*. 10*s*.

June 16.—The master and crew of the schooner *Margaret*, of Fleetwood, saved the crew of three men of the schooner *Salus*, of Wig-

town, which had caught fire in Wigtown Bay.—Reward, 5*l*.

July 9.—Three men went out in a boat and saved four persons whose boat, while passing through Elbow Sound, Slyne Head, had missed stays and grounded during a N. wind.—Reward, 1*l*. 10*s*.

Sept. 15.—Mr. R. MILLER, Coxswain of the North Berwick Life-boat, three of the crew of that boat, and nine other men, waded into the sea and rescued the crew of the schooner *Stella*, of Drogheda, which was totally wrecked near Sealcliffe during a N.E. gale and heavy sea.—Reward, 8*l*. 10*s*.

Oct. 10.—Twenty men put off from Corton, in the salvage boat *Refuge*, and, at much risk, saved the crew of seven men from the brigantine *Hope*, of Portsmouth, which foundered suddenly off Corton during squally weather.—Reward, 10*l*.

Oct. 28.—Twenty-three Whitby men rescued, by means of a hawser, the crew, consisting of five men, from the schooner *Sarah*, of Portsmouth, which was wrecked at Uppang, Yorkshire, during a hurricane from the E.N.E.—Reward, 7*l*. 15*s*.

Oct. 29.—Eleven men saved, by means of lines, the crew, consisting of six men, from the brig *Violet*, of Whitby, which was wrecked on Holkham Beach, Norfolk, during a heavy gale from the E.N.E.—Reward, 6*l*.

Nov. 4.—Voted the Silver Medal of the Institution, and a copy of the vote inscribed on vellum, to Mr. N. G. HATCH, mate of the ship *Berkshire*, of London, and 4*l*. to four of the crew of that vessel, for putting off in a boat and saving two of the crew of the brig *Marys*, of Whitby, which was wrecked on the Black Rock, at the entrance to Falmouth Harbour, during a heavy E.N.E. gale and high sea on the 22nd October.

Also the thanks of the Institution, inscribed on vellum, to Captain RICHARD SHERRIS, harbour-master at Falmouth, and 1*l*. 10*s*. to the crew of three men of his steam launch, for rescuing the master of the above-named vessel.

Also 1*l*. to three men for rescuing the crew of two men from the schooner *Esther Mary*, of Cardigan, which was wrecked near Balbriggan, Co. Dublin, during stormy weather on the 9th of May.

Nov. 16.—Four men put off in a boat and rescued four men from a punt which was in danger off Kessingland, during a moderate breeze from the E.—Reward, 1*l*.

Nov. 25.—Eleven men put off in a coble and rescued the crew of two men from the ketch *Isabella*, of Lynn, which was wrecked on the rocks off Redcar, Yorkshire, during a strong S.W. gale.—Reward, 5*l*. 10*s*.

Dec. 2.—Voted the thanks of the Institution to Mr. WILLIAM PREVIL, of Redcar, for assisting to save, by means of a rope, the crew of the German barque *Minna*, which had stranded off Redcar, on the 28th November.

*List of the Services of the Life-boats of the National Life-boat Institution during the Storms of January last.*

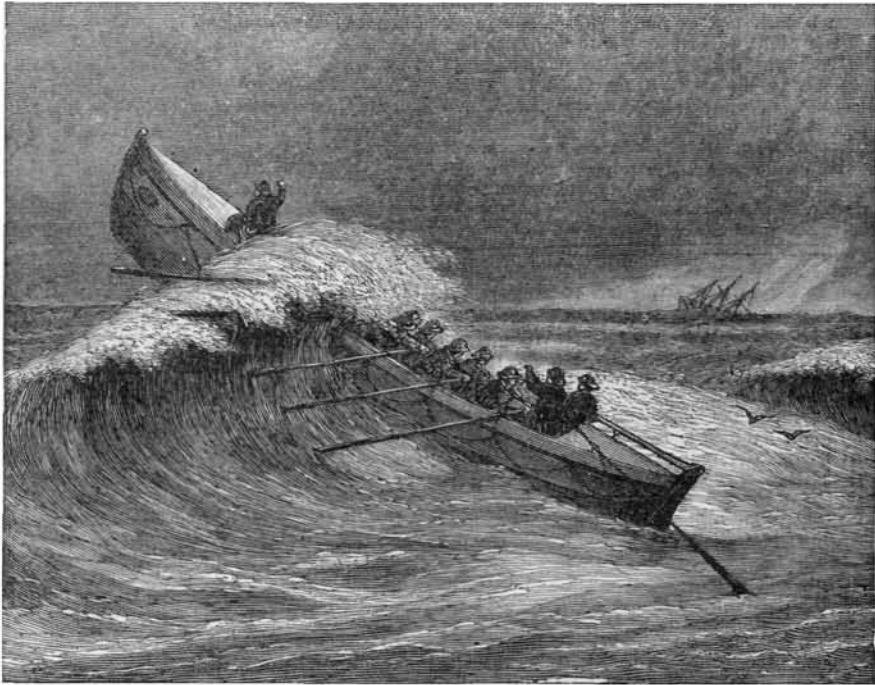

NEW BRIGHTON.—On the 4th January, 1881, at 3.45 A.M., in reply to signals of distress, the Life-boat *Willie and Arthur* proceeded to the Asque Spit and found the s.s. *Brazilian*, of Barrow, ashore there. After the boat's arrival the steamer broke in two and filled with water, and her crew were then taken off by the Life-boat and put on board the Dock Board tender *Vigilant*. The steamer was bound from Boston to Liverpool, and had on board between seven hundred and eight hundred head of cattle.

MONTROSE, N.B.—At about midnight on the 4th January it was reported that two of the large fishing-boats were ashore on the Annat Bank. The *Mincing Lane* Life-boat was at once manned by a crew of fishermen, and proceeded to their aid. The fishing-boat *Magdalen* was found full of water, with the sea breaking over her, and the crew (two of whom were sons of the coxswain of the Life-Boat) had taken refuge on board the other boat, the *Star of Peace*, which was farther up on the bank, and partly sheltered by the *Magdalen*, but would have been in considerable danger as the tide flowed. Both the

crews, numbering in all twelve men, were taken into the Life-boat and safely landed.

HARWICH.—On the 6th January, at about 7.30 A.M., a brigantine was seen ashore on the Halliday Sands with a flag of distress flying. In a short time she drifted on to Pye Sand, where the masts were cut away. The Life-boat *Springwell* proceeded to her aid and found her to be sinking. Seven of the crew and a woman were taken into the Life-boat, but the master, mate, and boatswain, refused to leave. These eight persons were landed at midday, and as the weather continued exceedingly rough the boat returned for the others. The sea was then making clean breaches over the vessel, and the three men therefore left her and were brought safely ashore by the Life-boat. The vessel proved to be the Spanish schooner *Rosita*, bound from Hamburg to Porto Rico, with a general cargo.

The service of the same Life-boat on the 20th January, is thus reported in *The East Anglian Daily Times*:—

“Those who were on Harwich pier between nine and ten on the morning of the 21st January, will not readily forget the scene presented on

the return of the Life-boat *Springwell* from the errand of mercy on which she left port about seven o'clock last evening. When our parcel left last night we were just able to report that the boat was getting ready to put to sea in response to signals from the Cork Lightship. The brave men were all too anxious to go, and more volunteers came forward than could be taken. A few minutes before seven a crew of twelve hands were fully equipped, and the boat started under the command of the second coxswain, WILLIAM BRITTON, Captain NEFEAN, R.N., the Institution's district inspector also being on board. The work of getting out of the harbour, however, was long and tedious. The frost had been so severe that a way had to be cut right to the harbour's mouth. Britton then turned the head of the boat to the Cork Light, when he was told that a smack had spoken with the mate and informed him that there was a steamship on the Sunk Sand with her crew lashed to the rigging. The Life-boat was put about for the Sunk, and at the Swin fell in with the smack *Albatross*, which took them in tow for some distance, and gave them directions where to find the wreck. The master of the *Albatross*, in answer to questions by Britton, said he had seen men in the rigging of the wreck, and he had left them at dark. After leaving the smack sail was got on to the Life-boat, and between four and five this morning the wreck was sighted. On approaching nearer seven men were seen lashed to the foremast. The hull of the vessel was completely under water. Britton hailed to know if any of the poor fellows were alive, and, getting a moan in reply, anchor was let go, and grappings thrown out. A life-line was made fast to the wreck, and the boat hauled up, but the strain was too much for the line, which parted. The poor fellows in the rigging, seeing the Life-boat receding from them, cried out in their fear, 'Don't leave us, or we shall fall into the sea directly. Come this moment, or we shall drop off. We can't hold out any longer.' A second life-line was made fast, and with this the gallant Life-boat was hauled close up. Her crew boarded the wreck and helped the poor fellows down from where they were lashed, and assisted them into the boat, which at once headed back for Harwich. The vessel turned out to be the screw steamship *Ingerid*, of Rotterdam, 438 tons, laden with fish from Norway for Naples. Her crew all told consisted of sixteen hands. She struck the sands on Monday, and on Tuesday morning a boat with seven of the crew on board left the wreck to try and reach land, whilst two more were lost overboard—one when the boat left, and another in attempting to get a second boat out. That night the captain and six men left on board had to seek refuge in the foremast, lashing themselves to it for fear of falling into the boiling sea beneath them. In this position they remained until rescued by the Life-boat on Friday morning. What their sufferings were none can tell during the four nights and three days they were on the sands in the searching wind and biting frost, without any possibility of getting either food or drink. Just off the Gork the Life-boat met the Lowestoft tug *Despatch*, which was leaving Harwich with the Lowestoft Life-boat in tow,

having come over on Thursday in response to a telegram asking for assistance in consequence of the *Springwell* having been damaged during Tuesday's gale. Finding that the Life-boat had seven poor fellows on board, the tug turned back, and towed her into harbour, reaching the pier about a quarter before ten. The appearance of the Life-boat was greeted with a loud cheer from the crowd assembled awaiting the return of the *Springwell*. On coming alongside the pier the occupants of the boat presented a frightful spectacle. The faces of the poor shipwrecked sailors were so blackened with frost that they looked as if they had all been in a horrible fighting affray, whilst their limbs were stiff and useless. They were at once taken into the restaurant at the pier hotel, the Dutch Consul, and the hon. secretary of the Harwich Life-boat Branch, Mr. A. P. BRAY, giving the necessary directions for attention to their wants. When stripped, it was discovered that the legs and feet of all seven men were severely frost-bitten, being black and red from the exposure to the cold, whilst the flesh under the nails of their hands and part of their fingers were also blackened. Mr. MORGAN, surgeon, who had been summoned by Mr. BRAY, did everything possible to relieve the sufferers, and as quickly as possible five of the men were got upstairs to bed, when they were supplied with hot coffee and meat. Dr. EVANS attended shortly after. The captain, VAN DER STOOK, and the mate POPPINGA, however, declined to go to bed, the former, whose legs were the worst from frost, preferring to sit up and have his limbs rubbed with snow, whilst the latter, a hardy old salt of sixty-two years, who had gone through former shipwrecks, and in 1836 lost part of the little toe of the right foot from frost-bite, called for a bath of cold brine, in which he placed his feet. The names of those saved are the captain, Van der Stook; the mate, Poppinga; the chief engineer, Steerard, the stoker, Andersen; and three seamen, Bokker, Goedgeluk, and A. Vos. There can be no doubt that the seven men who got away in the boat are lost. The boat was all right so long as it could be seen by those left behind, but it is impossible to believe that it could have lived long in such a sea as that of Tuesday morning. There were two tugs in the harbour last night when the *Springwell* started—the *Despatch*, of Lowestoft, and the *Harwich*, owned by Mr. J. H. VAUX, but they were unable to render assistance, not having any coal on board. After the rescued men were taken care of, Mr. BOLTON, manager of the Great Eastern Hotel, called the Life-boat crew in, and with a thoughtfulness fully appreciated by the men, set a hot meat breakfast before them, which was most heartily accepted. The service of the Life-boat lasted sixteen hours, half of which time the crew were at the oars at one stretch.

"About two o'clock this morning the smack *Increase* entered the harbour, and gave information of the wreck on the Sunk, not having fallen in with the Life-boat as she ran for the port.

"The chief engineer, Steerard, who has suffered greatly from frost-bite, says:—'We were on our way from Norway to Naples with a cargo of fish. On Monday the weather came

over hazy, with a strong wind east-north-east, during which we struck on the Sunk, about two miles below the Sunk Lightship. We were unable to get off, and all that night we were in the fore-castle, praying to our Great Creator. Shortly before noon on Tuesday, a boat was lowered, and eight men got into her to try and reach land, but the second engineer, one of the number, fell overboard and was drowned. The seven men left in the boat parted from us, and we have heard nothing more of them. Whether they reached the shore or perished at sea we do not know. We attempted to get a second boat out, but failed, the second fireman being lost overboard in the confusion. That night we had to take to the foremast, to which we lashed ourselves, the deck being completely swept by the waves, which were running with terrible force. The cold was horrible, and we hardly knew how to bear it. During that day I saw several steamers pass us, but the sea was too high for them to be able to do anything for us. On the next day the wind went down, and the weather became calmer, continuing so throughout Thursday. On both these days I saw vessels passing, and thought it hard that none should attempt to get near and lend us a hand to get away from our terrible position. The deck was under water, and we could not leave our places on the mast to get food or drink. As Thursday night closed in we saw a smack pass, and at half-past four this morning we were overjoyed to see the Life-boat approaching. We had throughout said our grace to our Maker, but had well nigh given up all hopes of being saved. Our limbs were frozen, and we could not have held out much longer. I am sure that if the boat had not come when she did we must all have died from cold and starvation."

**RAMSGATE.**—Captain BRAINE, the harbour-master of Ramsgate, in reporting the noble service rendered by the Ramsgate Life-boat on the 6th January, on the occasion of the wreck of the ship *Indian Chief*, on the Long Sands, states that the vessel struck on the Sands at 2.30 A.M. on the 5th of January, but that nothing was known on shore of the wreck until nearly noon that day. In a quarter of an hour after the intelligence had reached Ramsgate, the harbour steamer *Vulcan* and the Life-boat *Bradford* were on their way to the Sands, notwithstanding that they were nearly thirty miles away from the port. Having such a long distance to traverse, in a fresh gale from the E.N.E., and a very heavy sea, they did not reach the Kentish Knock Lightship until 5 P.M. on that day, by which time it was nearly dark, and although they were given the bearings of the wreck, they were unable to find it in the darkness. With great courage and determination, the Life-boatmen then resolved to stay by

the Sands until daybreak, involving their further exposure for fourteen hours in an open boat in a tremendous sea, the weather at the time being extremely cold. The steamer and Life-boat, therefore, cruised about between the Sands throughout the night, exposed to the whole fury of the storm. The steamer had her sponsons washed away, and one of the deck-houses damaged by the heavy seas, but happily no further casualty occurred. The suffering the Life-boatmen endured during that bitter night was, if anything, in excess of what was experienced by those on the ill-fated ship; but with the dawn of day their reward came, for they then caught sight of the wreck. There was only the foremast standing, the main and mizzen masts having given way and gone overboard during the night, carrying with them the master and sixteen of the crew, all of whom were lost. With infinite risk and difficulty the Life-boat was then taken as near as possible to the wreck, and the survivors of the ship's crew, twelve in number, were got into the boat, one by one making their way along the rail of the vessel between the seas which were continually breaking over her. The Life-boat's cable was then slipped, sail was made, and she sailed across the Sands, through the heavy broken water, to the steamer, which took her in tow and proceeded for the harbour, which was safely reached soon after 2 P.M., after an absence of twenty-six hours. It may be added that three other Life-boats, stationed respectively at Harwich and Clacton (Essex), and Aldborough (Suffolk), also proceeded to the succour of the shipwrecked crew, but they were unable to render any service, notwithstanding that some of them remained out many hours, in the hope that they might be able to help the unfortunate seamen. The ship *Indian Chief* belonged to Liverpool, and was outward bound from Middlesborough to Japan, with a general cargo.

Captain Braine added: "Of all the meritorious services performed by the Ramsgate tug and Life-boat, I consider this is one of the best. The decision the coxswain and crew arrived at to remain till daylight, which was in effect to continue for fourteen hours cruising about, with the sea continually breaking over them, in a heavy gale and tremendous sea, proves, I consider, their gallantry and

determination to do their duty. The coxswain and crew of the Life-boat speak in the highest terms of her good qualities. They state that when sailing across the Long Sand, after leaving the wreck, the seas were tremendous, and the boat behaved most admirably. Some of the shipwrecked crew have since stated that they were fearful, on seeing the frightful-looking seas they were passing through, that they were in more danger in the Life-boat than when lashed to the mast of their sunken ship, as they thought it impossible for any boat to live through such a sea."

On the 14th January, at 5.30 A.M., during a moderate breeze from the N.N.E., with snow squalls, the *Bradford* Life-boat and harbour steam-tug *Vulcan*, went out in response to signals of distress, and brought the schooner *Minnie Coles*, of Southampton, safely into harbour, that vessel having gone ashore on the N.E. part of the Goodwin Sands. She was on a voyage from London to Belfast, with a cargo of superphosphate and two and a half tons of gunpowder, and had a crew of five men. In going out to the vessel, the snow squalls were so thick that it was occasionally necessary to stop the tug's engines.

Again on the 19th January, at 10.15 P.M., during a moderate gale from the N.E., the Life-boat *Bradford* and harbour steam-tug *Aid* proceeded to the assistance of the ship *Attila*, of Newcastle, which had lost her fore and main masts, and was riding near the Long Sand with a signal of distress flying. Four of the Life-boatmen went on board the vessel to render assistance, and the Life-boat returned to the tug to request her to take the ship in tow. The steamer, however, had not sufficient coal on board to enable her to take the vessel to a place of safety. The tug and Life-boat therefore returned to Ramsgate and obtained a supply. At 12.30 A.M. the Life-boat and tug again went out, having on board eleven of the crew of the *Attila*, who had been landed at Ramsgate by a fishing vessel. At daylight they reached the ship, put the eleven men on board her, and eventually towed her towards the North Foreland. The Life-boat then proceeded ashore to obtain the service of a pilot and another tug, arriving in the harbour at 9.15 P.M. A pilot having been obtained, and another steam-tug having been engaged, the ship was ultimately taken to Gravesend. The

*Attila* was bound from Shields to Spezzia with a cargo of coal and coke, is 1,146 tons register, and carried a crew of twenty-two men.

CLACTON-ON-SEA.—The Life-boat *Albert Edward* put off at about 5.30 P.M. on the 6th January, in reply to signals of distress from the Swin Middle Lightship. The wind was blowing a gale from the E., and the sea was very heavy. On reaching the Lightship they learnt that a barque was ashore on the Maplin Sands. The Life-boat sighted her at 8 P.M., but she could not get alongside until the flood tide made, when she boarded her, and brought the master ashore to telegraph for instructions, arriving at Clacton at 11 A.M. The Life-boat afterwards, at the request of the captain, took him back to the vessel, which was the barque *Hertha*, of Christiansund in ballast.

Signals of distress from the Middle Lightship were observed on the morning of the 19th January. The same Life-boat was launched and proceeded to a schooner which was found to be sunk with the lower masts' heads out of water. As no one was on the masts the Life-boat made for the Gunfleet, but did not find any vessel in distress; she then crossed the sand at the West Buoy and stood toward the Heaps, and spoke a steamer steering E.N.E., which waved for them to go to the westward. Seeing nothing on the Heaps or Barrows she steered for the Middle Lightship, which reported three sailing vessels and a steamer on the Maplin Sands. On reaching the first vessel she was found to be abandoned. A signal was then made from the Maplin Lighthouse, the boat therefore steered in that direction and soon sighted a dismasted ship. On nearing her, at about 2 P.M., a group of people were seen standing on one of the deck-houses waving a flag. The Life-boat made for her lee bow, the loaded cane was thrown to the crew, who seized it and hauled the boat's cable on board. The sea was making a clean breach over the vessel, and some difficulty was experienced in transferring the crew from her to the Life-boat; eventually, however, this was safely accomplished. The vessel proved to be the brigantine *Hasselo*, of Hague-sund, bound from Riga to London with oats. The crew, eight in number, had been on the deck-house since noon on the



previous day, and had not tasted anything for thirty-three hours. The Life-boat fortunately had some spirits and biscuits on board, which were distributed amongst the men and for which they were very grateful. On returning to shore the Life-boat saw two other vessels, but it was evident that their crews had been able to get ashore. When about three miles below the Middle Lightship signals were seen going up from the Mouse Lightship; but as the cold was so intense and the crew of the brigantine were in such an exhausted state that they would probably not have lived through the night if the boat had gone to the Mouse, it was considered best that the boat should make for Clacton. The Life-boatmen had great difficulty in keeping life in the rescued men by constantly rubbing their limbs, and were much afraid that they would not reach the land alive. They were, however, all safely landed at Clacton at about 4 o'clock on the following morning, and were taken to an hotel, where their wants were attended to.

**BERWICK-ON-TWEED.**—On the 8th January, about 2.15 p.m., the *Albert Victor* Life-boat was launched to render assistance to several distressed fishing-boats. The boats went over the bar four times, and accompanied the boats in, taking two of them, having nine men on board, in tow. But for the assistance rendered by the Life-boat the boats would in all probability have been swamped in crossing the bar.

**CULLERCOATS.**—On the 10th January the *Palmerston* Life-boat put off to the aid of a fishing-coble which had been caught in a very high sea, rendering it dangerous for her to cross the bar. With the assistance of the Life-boat the coble safely reached the land.

**REDCAR.**—On the 10th January the *Burton-on-Trent* Life-boat rescued two men from the fishing-coble *Lively*, of Redcar, which was in danger about a quarter of a mile off Redcar Beach, and unable to land on account of the very heavy surf, the wind blowing strongly from the N.E.

**RUNSWICK.**—On the 11th January the *Margaret and Edward* Life-boat was launched and rendered good service in

assisting some Staithes fishing-cobles safely to land.

Again on the 20th January the Staithes fishing-cobles went out to their usual fishing-ground. During the day the sea became very strong, with heavy snow-showers, and when the boats returned at about 4 p.m. they found it was impossible to land at Staithes, and they then made for Runswick. The *Margaret and Edward* Life-boat thereupon proceeded to their assistance, and remained afloat three hours, assisting the boats to land.

**STAITHES.**—On the 11th January, about fifty of the Staithes cobles were out, when a gale from the N. suddenly sprang up, accompanied by a heavy sea. The *Hannah Somerset* Life-boat went off to their aid, and accompanied most of them to the shore. The sea, however, increased, and as it was considered dangerous for the remaining seven cobles to attempt to land at Staithes they were advised to run for Runswick, and they therefore made for that place.

**KESSINGLAND, SUFFOLK.**—On the 13th January the Life-boat *Bolton* proceeded to the aid of the sloop *Ruby*, of Goole, which had been overtaken by a snow squall, and had been dismasted while passing through Pakefield Gap. Seeing that her position was one of much peril, on account of the proximity of dangerous sandbanks, the Life-boat *Bolton* was quickly launched, and, with the help of a steam-tug, took the vessel safely into Lowestoft Harbour. She was bound from Goole to St. Helens, with coal, and carried a crew of two men.

**PALLING, NORFOLK.**—On the 15th January, during a moderate gale from the W.N.W., accompanied by heavy snow showers, the *British Workman* Life-boat was launched in reply to signals of distress, and found the s.s. *Trafalgar*, of London, ashore on the Hasborough Sand. The Life-boat remained by her for some hours, and finally rescued the crew, twenty-three in number, all of whom were safely landed at Palling, though in a very benumbed condition. The steamer was on a voyage from Shields to Bombay, with a cargo of coal.

**CAISTER, NORFOLK.**—On the evening of Sunday, 16th January, a letter was re-

ceived by a messenger from Palling, stating that two ships were on the Hasborough Sand. A steam-tug was obtained from Great Yarmouth, and the Caister No. 2 Life-boat, *Godsend*, started at about four o'clock on the following morning. On arriving at the Sand the barque *North Wales*, of London, bound from Newcastle to Java with coal, was found ashore there. The steam-tug endeavoured to tow her off at the flood tide, but could not succeed. At ebb tide the vessel filled, and, as the sea was increasing, her crew of twenty men and a pilot were taken off by the Life-boat and put on board the steamer.

**BRIXHAM, DEVON.**—At 10.45 A.M. on the 18th January, on the urgent solicitation of a number of experienced master mariners, sailors and seamen, the *City of Exeter* Life-boat was launched to render assistance to a pilot gig proceeding to put crews on board their vessels then riding in a strong gale from E.S.E. and very heavy sea in Brixham Roads. The crews in the gig were in great danger owing to the heavy sea and the number of vessels. The Life-boat was out nearly five hours in driving snow and a very heavy gale.

**PORTHDLINLLAEN, NORTH WALES.**—On the 18th January fearful weather was experienced here, and the Life-boat *George Moore* was twice launched to the assistance of the crews of distressed vessels. The wind was blowing a very heavy gale from the E.N.E., and it was freezing hard when the boat was first launched at half-past one o'clock in the afternoon, and it was only with difficulty that she was enabled to rescue the crew of three men from the smack *Fishguard Lass*, of Abersoch, which was then at anchor in the bay in a dangerous position, and which shortly afterwards parted her second chain and drove ashore. At about 7.30 in the evening, the gale still blowing very hard from the same direction, the schooner *Miss Beck*, of Carnarvon, parted her anchors and drove on a rock called Carreg Oysters. The Life-boat quickly proceeded to her assistance, but the vessel was in such an awkward position that the greatest difficulty was experienced in rescuing the crew of five men, the boat being out nearly five hours before she was enabled to accomplish the rescue, and sustaining some damage on the occa-

sion. The Life-boatmen had at last the satisfaction of landing the shipwrecked crew in safety soon after midnight.

**WINTERTON, NORFOLK.**—The brig *Gyda*, of Swendsale, Norway, stranded half a mile north of this place on the 18th January. In consequence of the snow-drift it was found impossible to take the *Edward Birbeck* Life-boat to the scene of the wreck on her carriage. She was then dragged along the shore on her launching-skids by the crew, assisted by a large number of men. When abreast of the wreck she was launched, and was successful in saving four of the crew. The remainder, five in number, had previously been rescued by the rocket apparatus.

**ST. IVES, CORNWALL.**—On the 18th January a heavy N.E. gale was experienced here, accompanied by snow. During the height of the storm the crew of the Life-boat *Exeter*, in response to signals, launched their boat to the help of the crew of a vessel which was riding in the bay on a dead lee shore, and which it was seen must inevitably strike. The Life-boat, which is one of the smaller class, 32 feet long, made gallant attempts to get off in the teeth of the storm, and against a tremendous sea, but she was driven back into harbour, the sea knocking several of the oars out of the men's hands. At about 10 A.M. she again proceeded out, and after a severe struggle got alongside, and was successful in saving the crew of five men—not a moment too soon, for the vessel soon afterwards drove on the rocks. She was the schooner *Rosa Josephs*, of St. Vaast, France, bound from Britonferry to Cherbourg with a cargo of coal.

**GREAT YARMOUTH.**—At 11.30 A.M. on the 18th January, a ketch was observed on shore on the North Beach. The Life-boat *Abraham Thomas* immediately proceeded to the spot, and succeeded in rescuing the crew, consisting of four men. The wind at the time was blowing a heavy gale, and the sea was breaking heavily on the beach. The ketch was the *Manne de Ciel*, a French vessel.

**WHITBY.**—A telegram was received at about 10.30 A.M. on the 19th January stating that a ship had sunk about six

miles southward of this port, and that the crew had been compelled to take to their boat and come to an anchor. A message was sent in reply to say that the Life-boat *Robert Whitworth* should at once proceed there by road, and requesting that she might be met by men and horses, a gang of men being also despatched to cut the snow in front, which in places was six or seven feet deep. With the help jointly rendered by horses and men from both directions, the Life-boat was got to the scene of the disaster in little more than two hours, and was immediately launched. After pulling for an hour the steer oar and six other oars were broken, and she had to return to shore for a fresh supply. A double crew then manned the boat, and with a cheer she was again launched through terrific seas. After struggling for an hour and a half, the shipwrecked crew of six men were reached, and safely landed at four o'clock. The poor fellows were thoroughly exhausted and benumbed, and it was only with great difficulty that they were brought back to consciousness, with the help of the medical men who were at hand ready to receive them. The Life-boat crew also suffered severely; one of them was so exhausted that he could not for some time return home. The vessel proved to be the brig *Visitor*, belonging to Whitby. She was bound from Shields to London, with coal.

NAIRN, N.B.—At about noon on the 20th January, information was received that a ship had gone ashore at Fort George, about seven miles W. of Nairn. The *Caulfield* and *Ann* Life-boat went to

her assistance, and on reaching the scene of the wreck it was found that the sea was very high, and that the ship must soon go to pieces. Lines were hove aboard her, but the crew were too exhausted to make use of them, and it then became necessary for the Life-boat to go alongside. This was done, and with great difficulty the men, three in number, were rescued from their perilous position in an almost helpless state. The vessel proved to be the schooner *Annie Marie*, of Krageroe, Norway, bound thence to Wick with a cargo of billet wood.

SKEGNESS, LINCOLNSHIRE.—On the 20th January the *Herbert Ingram* Life-boat rendered some assistance to the brig *Matilda*, of Gothenburg. Two of the Life-boatmen were put on board the vessel and assisted in taking her to Lynn.

BRIGHSTONE GRANGE, ISLE OF WIGHT.—The steamer *Claremont*, of Newcastle, was wrecked at Whale Chine, Isle of Wight, on the 27th January. Intelligence of the wreck was received at the Brighstone Grange Life-boat Station, and at about 11.40 P.M. the Life-boat *Worcester Cadet* proceeded to her assistance. Before this, voices had been heard at sea, and the Coxswain of the Life-boat therefore burnt a light and fired a gun to warn the ship's crew against landing, there being a heavy ground swell. As the tide was ebbing, the Life-boat rowed three miles W.S.W., and then picked up one of the ship's boats containing the mate and five men, who were safely landed at 3.40 on the following morning.

Summary of the Life-boat Services during the Storms of January, 1881.

	Lives saved.		Lives saved.
<i>Annie Marie</i> , schooner, of Krageroe . . . . .	3	<i>Matilda</i> , brig, of Gothenberg—rendered assistance.	
<i>Attila</i> , ship, of Newcastle—rendered assistance.		<i>Minnie Coles</i> , schooner, of Southampton—saved vessel and . . . . .	5
Berwick-upon-Tweed fishing-boats—saved two boats and crews . . . . .	9	<i>Miss Beck</i> , schooner, of Carnarvon . . . . .	5
<i>Brazilian</i> , s.s., of Barrow—rendered assistance.		<i>North Wales</i> , barque, of London . . . . .	21
Brixham pilot gig—remained alongside.		<i>Rosa Josephs</i> , schooner . . . . .	5
<i>Claremont</i> , steamer, of Newcastle . . . . .	6	<i>Rosita</i> , Spanish brigantine . . . . .	11
<i>Fishguard Lass</i> , smack, of Abersoch . . . . .	3	<i>Ruby</i> , sloop, of Goole—assisted to save vessel and . . . . .	2
<i>Gyda</i> , brig, of Swensdale . . . . .	4	Staithees and Cullercoats fishing cobsles—rendered assistance.	
<i>Hasselo</i> , brigantine, of Haguesund . . . . .	8	<i>Trafalgar</i> , screw steamer, of London . . . . .	23
<i>Hertha</i> , barque, of Christiansund—rendered assistance.		<i>Visitor</i> , brig, of Whitby . . . . .	6
<i>Indian Chief</i> , ship, of Liverpool . . . . .	12	Total lives saved in January, in addition to four vessels . . . . .	148
<i>Ingerid</i> , Dutch steamer . . . . .	7		
<i>Lively</i> , fishing coble, of Redcar . . . . .	2		
<i>Magdalen</i> and <i>Star of Peace</i> , fishing-boats . . . . .	12		
<i>Manne de Ceil</i> , French ketch . . . . .	4		

THE  
**MEDAL OF THE ROYAL NATIONAL LIFE-BOAT INSTITUTION,**  
 FOR THE PRESERVATION OF LIFE FROM SHIPWRECK.



*Obverse.*—Bust of Her Majesty Queen Victoria; beneath, in minute letters, "L. C. Wyon." Double legend, "Royal National Life-boat Institution. Founded in 1824. Incorporated 1860. Victoria, Patroness."  
*Reverse.*—Three sailors in a Life-boat,—one of whom is in the act of rescuing an exhausted mariner from the waves on a fragment of the wreck. "W. Wyon, Mint." Inscription, "Let not the deep swallow me up."

THE beautiful obverse of this medal, executed by L. C. WYON, Esq., represents the bust of QUEEN VICTORIA, Her Majesty's locks gracefully waving and gathered in a knot behind, from which issues a wreath of oak clustering over the forehead. This life-like portrait of the QUEEN, in high relief, conveys a truly pleasing and faithful likeness of HER MAJESTY at that period (1862), combining the dignity of aspect and benevolence which have always characterised the Queen throughout her long and prosperous reign.

The reverse, representing the Life-boat, in which there are three Seamen, rescuing a fourth from the sea, is a work of great merit. Two of the men are steadying the boat, while the other, stooping, draws in the Shipwrecked Sailor, whose figure is given so as to show the form in the most natural manner; and the expression thrown into his countenance looking up to his preserver is supplicating in the extreme, while the easy flowing lines of this sailor are finely contrasted by those of his companions: the whole displaying a perfect knowledge of the human frame, and a command of the graver to embody what he had shadowed out to himself.

But there is another pleasing motive for admiration of this beautiful Medal, as the figure who is so humanely extending his relief to the drowning Mariner is a portrait of the Artist, the late WILLIAM WYON, Esq., R.A., himself.

The following is a List of the GOLD and SILVER MEDALS that have been voted by the Committee of the Institution, since its establishment in 1824, to persons whose humane and intrepid exertions in saving Life from Shipwreck on our Coasts have been deemed sufficiently conspicuous to merit that honourable distinction. The Cases will be found recorded in detail in the several Annual Reports of the Institution.

The total number of Medals granted by the Institution up to the present time is 1,028, 95 of which were in Gold, and 933 in Silver.

*Note.*—The asterisk (\*) after the name denotes the reception of a Gold Medal. The figure after the name signifies the number of honorary distinctions received from the Institution. Abbreviations.—C<sup>t</sup>. G<sup>d</sup>.—Coast Guard. R. C.—Revenue Cruiser. M. M.—Master Mariner.

Acraman, Mr. J., Fishguard.	Alexander, W., Coxswain of the Thorpeess Life-boat.	Armstrong, R., Newbiggin.	Bacon, Henry, Harwich.
Adair, Mr. W., C <sup>t</sup> . G <sup>d</sup> , Dundrum.	Allen, Jas., Holy Island.	Armstrong, Mr. W., Blyth.	Bacon, Mr. James, M. M.
Adam, Mr. J., C <sup>t</sup> . G <sup>d</sup> , New-castle. (2)	Allen, Mr. Luke Jas., M. M., Wivenhoe.	Armstrong, W., Newbiggin.	Bailey, Jas., Boatman, Deal.
Adams, Mr. Thomas, M. M.	Amis, Edward, late Coxswain of the Palling Life-boat.	Askin, J., C <sup>t</sup> . G <sup>d</sup> , Ballywalter.	Baillie, Lieut. Henry, R.N.
Agar, J., C <sup>t</sup> . G <sup>d</sup> , Morris Castle.	Anderson, Mr. John G., R.N.	Atkins, T., C <sup>t</sup> . G <sup>d</sup> , Wainfleet.	Baillie, Lieut. H., R.N.
Agnes, Samuel, Wivenhoe.	Annis, Mr. M., C <sup>t</sup> . G <sup>d</sup> , (2)	Austen, Wm., Seaman, Ramsgate Steamer <i>Vulcan</i> .	Bain, Alex., Seaman, Skerries.
Ahern, John, C <sup>t</sup> . G <sup>d</sup> , Kilmore.	Anthony, Mr. Owen, M.M., Holyhead.	Autridge, Lieut. R.N., Doonbeg.	Bake, Lieut., R.N., C <sup>t</sup> . G <sup>d</sup> .
Aikin, J., C <sup>t</sup> . G <sup>d</sup> , Cushendall.		Avisse, Mr. J. N., M. M., Boulogne.	Baker, Lt. G. S., R.N., C <sup>t</sup> . G <sup>d</sup> .
			Baker, Mr. T., C <sup>t</sup> . G <sup>d</sup> , Brooke.
			Banyard, Mr. John, C <sup>t</sup> . G <sup>d</sup> .

- Barlach, Mr. Henry, M. M.  
Barnard, A., C. G.<sup>d</sup>. (2)  
Barnes, George, Christchurch.  
Barrett, Mr. J., C. G.<sup>d</sup>.  
Carnsora. (2)  
Barrett, W., C. G.<sup>d</sup>.  
Barrett, W., jun., ditto.  
Barron, R. N., Esq.  
Barry, Lt. G., R.N., Kinsale.  
Bartholomew, R. J., Esq.,  
Rothsay, N.B.  
Bapt, Samuel, Second Coxswain of Padstow Life-boat.  
Bate, Thomas, Coxswain of the Bude Life-boat.  
Bates, Mr. Thos., C. G.<sup>d</sup>.  
Batist, J., C. G.<sup>d</sup>. Dymchurch.  
Beaton, G. B. M., Esq., C. G.<sup>d</sup>. (2)  
Beaulcher, The late Lord Charles.  
Beck, Robert, Point of Ayr.  
Beddoe, D., Fishguard.  
Bedwell, Mr. Wm., M. M.  
Begg, Mr., M. M.  
Belsey, Hy., Life-boatman, Ramsgate.  
Bennett, Capt. C. C., R.N.\*  
Berriman, Mr. James, M.M.  
Berry, David, Life-boatman, Ramsgate.  
Bevan, Mr. John, M. M.  
Bickerstaffe, Mr. R., Coxswain Blackpool Lifeboat.  
Billet, Mr. R., C. G.<sup>d</sup>, Coxswain of Lydd Life-boat.  
Bingham, Mr. Wm. [ter.  
Bishop, Mr. S., C. G.<sup>d</sup>, Cais-Black, A., C. G.<sup>d</sup>, Strangford.  
Blackmore, Mr. Wm., Chief Officer C. G.<sup>d</sup>, Penzance. (2)  
Blackwood, Rev. J. O'Reilly, Ballywalter.  
Blair, Lt. Horatio, R.N., C. G.<sup>d</sup>.  
Blampped, Mr. C., Jersey.  
Blance, John, Shetland.  
Blissendon, William M.  
Blois, Capt. J. R., R.N.\*  
Boltho, Simon, C. G.<sup>d</sup>, Bude.  
Bonner, G., Pilot, Guernsey.  
Bonner, G., C. G.<sup>d</sup>, Collieston.  
Bouchard, John, St. Martin's.  
Bowen, Lieut. C. H., R.N.\*  
Boyd, Henry, C. G.<sup>d</sup>.  
Boyd, Mrs. Captain, R.N.  
Boyle, Marcus, Coxswain of Wexford Life-boat.  
Boyle, Lieut. Hon. R. F., R.N. B. Brice, W., C. G.<sup>d</sup>, Greencastle.  
Bridle, Mr. W., M. M., Lyme.  
Brine, Thos., Esq., Douglas.  
Brinkmead, Mr. W., M. M.  
Brittain, Lieut. G. S., R.N., C. G.<sup>d</sup>. (2)\*  
Britton, Mr. J., Master of the American Ship *Rochester*.  
Britton, Mr. Wm., Coxswain of the Harwich Life-boat.  
Broad, W., Esq., Falmouth.\*  
Brooks, A., C. G.<sup>d</sup>, Dungeness.  
Brown, Henry, Newbiggin.  
Brown, James, Dunbar.  
Brown, Thos. Crosswell.  
Browne, Mr. P. R. M. (2)\*  
Brune, Miss B. M. Pridcaux.  
Brune, Miss E. F. Pridcaux.  
Brune, Miss G. R. Pridcaux.  
Brune, Miss M. K. Pridcaux.  
Brunton, Lt. J., R.N. (2)\*  
Buck, W. C., Esq., R.N., C. G.<sup>d</sup>.  
Buckett, J., Coxswain Brighton Grange Life-boat.  
Budd, James, Esq., Ramore.  
Bulkeley, J. B., Coxswain of Teignmouth Life-boat.  
Bulley, Lieut. J., R.N. (4)\*  
Bumby, Mr. J., C. G.<sup>d</sup>, Clovelly.  
Bunt, Mr. John, C. G.<sup>d</sup>.  
Burnard, Mr. T., Bideford. (2)  
Burne, J., C. G.<sup>d</sup>, Penzance.  
Burne, John, Sen., Shields.  
Barney, Mr. R., C. G.<sup>d</sup>, Banff.
- Bury, Lt. Viscount, P.C., M.P.  
Butcher, James, Lowestoft.  
Butcher, Rich., Lowestoft.  
Byrne, Mr. Lawrence, C. G.<sup>d</sup>.
- Cahill, D. F. S., Esq., M.D.  
Cain, Wm., Isle of Man.  
Callaway, W., Seaman, Lyme.  
Campbell, James, Leestona.  
Campbell, Miss J., Drogheda.  
Campbell, Mr. Angus, Cutter *Princess Royal*.  
Cameron, Capt. Orford S., R.N., C. G.<sup>d</sup>.  
Candlish, J., Coxswain of the Lytham Life-boat.  
Cannell, T., Isle of Man.  
Carberry, Patrick, Wexford.  
Carbis, Thos., Coxswain of the Penzance Life-boat. (2)  
Carey, H., Esq., Shrove Head.  
Carr, C.S., Gunner R.C. *Sylvia*.  
Carr, Mr. Henry, H.M. Customs Wexford.  
Carr, John, C. G.<sup>d</sup>, Dunmannus.  
Carrington, Mr. J., Master of Steam-tug *Liverpool*, of Harwich.  
Carrington, Lieut., R.N.  
Carrington, W. H., Esq.  
Carter, Mr. J., C. G.<sup>d</sup>.  
Casey, M., Newcastle, Ireland.  
Castel, G., Broadstairs.  
Cay, Capt. R. B., R.N. C. G.<sup>d</sup>.  
Chaddock, J., C. G.<sup>d</sup>.  
Chaplin, Mr. M. M.  
Chappell, Mr. T., Bideford.  
Chappell, Capt. W., Bideford.  
Chard, J., Boatman, Thorpe.  
Chesnut, George, Skegness.  
Chittenden, E., Broadstairs.  
Clark, George, Seaman.  
Clark, Lieut. Joseph, R.N.\*  
Clayburn, T., Scarboro'. (2)  
Clayton, Lt., R.N., C. G.<sup>d</sup>.  
Cleave, Mr. R. M., M., Wivenhoe.  
Clove, W., Pilot, Mevagissey.  
Cobb, Rev. C., M.A., Dymchurch.\*  
Cockrom, W., H.M.S. *Eagle*.  
Coffee, P., Tramore, Waterford.  
Colby, Nathaniel, Coxswain of the Pakefield Life-boat.  
Cole, J., Seaman, Wivenhoe.  
Collard, Mr. S., Pilot.  
Collins, Mr. J., Master of the American ship *Roscus*.  
Collison, Mr. R., M. M.  
Collopy, J., C. G.<sup>d</sup>, Portcawl.  
Combe, Lt. M., R.N.  
Coneys, Mr. Anthony, Clifden.  
Connick, Mr. J., Dundalk.  
Cooper, Mr. Hugh, C. G.<sup>d</sup>, Cromaine Point.  
Cooper, Thomas, Sen., Life-boatman, Ramsgate.  
Cooper, Thomas, Jun., Life-boatman, Ramsgate.  
Coppin, Lt. F., R.N., C. G.<sup>d</sup>.  
Corbert, W., Coxswain of the Ardore Life-boat.  
Corbet, P., Pilot, Guernsey.  
Corbett, W., Esq., Isle of Man.  
Cork, W., C. G.<sup>d</sup>, Fort George.  
Corkhill, W., Coxswain of the Padstow Life-boat. (2)  
Cornish, Lt. J., R.N., Bovis.  
Costello, M., Esq., Rosslare.  
Coul, Alexander, Montrose.  
Coul, Charles, Montrose.  
Cowan, J., Isle of Man.  
Cox, H. L., Esq., Surgeon, Army Medical Department.  
Cox, Lt. H., R.N., C. G.<sup>d</sup>. (2)\*  
Cox, Joseph, Coxswain of the Appledore Life-boat. (3)  
Cox, J., Jun., Second Coxswain, Appledore Life-boat.  
Cox, W., Kilmore.  
Craggs, J., C. G.<sup>d</sup>, Devonport.
- Cragie, J., Coxswain of the Southwold Life-boat.  
Cronne, Dennis, Ballycotton.  
Cropper, Peter, Liverpool.  
Crosby, Nicholas, Dundalk.  
Crosswell, Mr. T., Fowey.  
Crouch, J., Broadstairs.  
Crouch, R., Broadstairs.  
Crowden, Mr. J., Chief-Officer of C. G.<sup>d</sup>, at Muchals, N.B.  
Cubitt, Mr. W., Bacton. (2)  
Cubitt, Mr. W., jun., Bacton.\*  
Culmer, Mr. C. G.<sup>d</sup>, Leigh.  
Cummins, Mr. J., Coxswain of the Arklow Life-boat.  
Cunningham, Mr. J., New-castle.  
Curnow, Mr. Paul, Coxswain of the St. Ives Life-boat.  
Curteis, Mr. W., C. G.<sup>d</sup>.  
Curtis, Steph., Christchurch.
- Dabine, Lieut., R.N., C. G.<sup>d</sup>.  
Dand, M. H., Esq., Hauxley. (3)  
Dark, Mr. William, M. M.  
Darling, Wm., Light-house keeper, Fern Islands.  
Darling, Grace, his daughter.  
Darragh, H., C. G.<sup>d</sup>, Innis Bofin.  
Davies, the late Vice-Admiral George. (4)\*  
Davies, Capt. Thomas, R.N.  
Davies, George, Hoyleake.  
Davison, W., Sunderland.  
Dawson, Mr. T., Hartlepool.  
Day, Chr., Middlesborough.  
Day, Mr. Thomas, Bideford.  
Deane, Mr. Henry, C. G.<sup>d</sup>.  
Delpierre, Jean A., Boulogne.  
Dent, J., Newbiggin.  
Desmond, John, Limerick.  
De St. Croix, Mr. F., Jersey.\*  
De St. Croix, Mr. J., Jersey.\*  
De St. Croix, Mr. F., Jersey.\*  
Devereux, M., Master Pilot, Rosslare. (3)  
Dillon, Jas. C. G.<sup>d</sup>, Arklow.  
Dobson, T., Coxswain of the Donna Nook Life-boat.  
Donkin, A., Cullercoats. (2)  
Donovan, Dennis, C. G.<sup>d</sup>. (2)  
Donovan, J., C. G.<sup>d</sup>, Boatman.  
Dooley, Lt. D., R.N., C. G.<sup>d</sup>.  
Douglas, Alexander, C. G.<sup>d</sup>.  
Dower, Capt. A., Dunganvar.  
Downing, Nicholas B., Esq.  
Draydon, D., C. G.<sup>d</sup>.  
Ouffy, M., Mullaghmore.  
Dunmore, The Right Hon. The Earl of.  
Dunn, Mr. William, M. M.  
Durban, John, Walmer.  
Dyer, B., Seaman, Wivenhoe.  
Dyer, B., Seaman, Wivenhoe.  
Dyer, Lt. H. McNeill, R.N.  
Dyer, Mr. John, Stratton.
- Earle, Lt. E. C., R.N., Rve.\*  
Eastaway, R., Boatman, C. G.<sup>d</sup>.  
Eddy, R., Pilot, Plymouth. (3)  
Edington, Mr. Chas., C. G.<sup>d</sup>.  
Edwards, Mr. D., Montrose.  
Ellis, Henry, C. G.<sup>d</sup>, Bude.  
Elphinstone, Geo., Dundalk.  
Else, Lieut., R.N., Fowey.\*  
Elton, Lt. W. H., R.N., C. G.<sup>d</sup>.  
Elwin, Lt., R.N., Lymington.  
Elyard, Major J., 2nd Royal Surrey Militia. (2)\*  
Erridge, E., Boatman, Deal.  
Essell, Lieut. Wm. F., R.N.\*  
Evans, Capt. Thomas.  
Evans, Mr. J., M. M., Fish-guard.  
Evans, Lieut. Thomas, R.N.  
Evans, T., sen., New Brighton. (2)\*  
Evans, T., jun., New Brighton.
- Evans, Wm., New Brighton.  
Evans, Wm., Pilot, Neath.  
Evison, Lt. J. C., R.N., C. G.<sup>d</sup>.
- Farmer, David, Hayling.  
Farrin, Mr. G., H.M.S. *Ajax*.  
Fellowes, Capt. T. H. B., R.N.  
Festing, Lieut., R.N.  
Festing, Colonel Sir F. W., C.B., K.C.M.G., R.M.A.  
Field, Lieut. Wm. Geo., R.N.  
Field, Mr. W., Milford Haven.  
Finlay, G., C. G.<sup>d</sup>, Lambay.  
Finlay, William, Montrose.  
Fish, Chas. E., Coxswain of the Ramsgate Life-boat. (2)\*  
Fish, John, Southwold.  
Fisher, Mr. S., Horseferry-rd.  
Fisher, Mrs., North Feroe Islands.  
Fitzjames, Mr., R.N., Euphrates Expedition.  
Fitzpatrick, J., C. G.<sup>d</sup>, Malin Head.  
Flann, Wm., Portland.  
Fleming, George, Gorleston.  
Fletcher, T., C. G.<sup>d</sup>, Rosslare.  
Flynn, P., C. G.<sup>d</sup>, Kyrush.  
Foley, Mr., M. M.  
Foley, Mr. J., Port Talbot.  
Forbes, Mr. A., Peterhead.  
Formby, Joseph, Formby.  
Forward, Mr. T. R., Commander R.C. *Sylvia*.  
Foster, J., C., G.<sup>d</sup>, Aldboro'.  
Found, Mr. W., M. M.  
Fowell, John, Seaman.  
Fowler, Mr. James, M. M.  
Fox, Mr. John, Fleetwood.  
Foy, Thomas, Rossglass.  
Frankish, T. H., Bridlington.  
Franklin, Lt. E., R.N., Hove.  
Franklyn, Lieut. G., R.N.  
Freeman, Mr. Henry, Coxswain of the Whitley Life-boat. (2)  
Freeman, John, Seaman.  
Freeman, James, Helston.  
Freemantle, Capt. C. W., R.N.\*  
Freney, John, Killiney.  
French, Mr. Charles, C. G.<sup>d</sup>.  
Friend, Thos., Life-boatman, Ramsgate.  
Fulton, Mr. Robert, R.N.  
Furlong, A., Fishguard.
- Galbraith, Mrs. E., Whitney.  
Gale, Mr. W., M. M., Barking.  
Gallagher, P., Co. Down.  
George, Philip, Coxswain of Caister Life-boat.  
Gerrard, Mr. R., Pilot, Fleetwood.  
Giles, Mr. W. M. M., Padstow.  
Gillespie, Andrew, Gunner.  
Gilmer, Mr. Wm., Dundalk.  
Gimser, Lt. T. A., R.N., C. G.<sup>d</sup>.  
Gimar, Mr. E., Master of the French brig *Le Normas*.  
Gin, N. Francois, Boulogne.  
Gleason, R. F., Wexford.  
Glover, Mr. J., M.M. Gunfleet Sand.  
Goldring, Mr. W., M.M., Hayling.  
Goldsmith, John, Life-boatman, Ramsgate.  
Goldsmith, Richard, Life-boatman, Ramsgate.  
Goldsmith, Stephen, Life-boatman, Ramsgate.  
Gordon, Mr. John, Second Coxswain of the Tyrella Life-boat.  
Goss, Capt. T., R.N., C. G.<sup>d</sup>. (2)\*  
Gough, J., Fisherman, Waterford.

- Gould, Lt. Wm., R.N., C. G.<sup>d</sup>.  
 Graham, G., Lt. R.N., C. G.<sup>d</sup>.  
 Graham, Capt. Philip, R.N.\*  
 Granby, Mr. Charles, M. M.  
 Grandy, Mr., of the R. C.  
*Harpy.*  
 Grandy, Lieut. S., R.N. (2)\*  
 Grant, Mr. W., Coxswain of the Margate Life-boat. (2)  
 Graves, Mr. J., M. M., Carlisle.  
 Gray, A., C. G.<sup>d</sup>, Fort George.  
 Gray, I., C. G.<sup>d</sup>, Kilmore.  
 Gray, Mr. Geo. Bridlington.  
 Gray, Mr. J., M. M., Peterhead.  
 Gray, E. W. D., Esq., Dublin.  
 Gregory, J., C. G.<sup>d</sup>, St. Andrews.  
 Grey, George, Hartlepool.  
 Griffith, David, Beaumaris.  
 Griffith, Robert, Anglesey.  
 Griffiths, Mr. B., M. M., Portmadoc.  
 Griffiths, G., Pilot, Anglesey.  
 Griffiths, T., C. G.<sup>d</sup>, Mulbay.  
 Gruer, Wm., C. G.<sup>d</sup>, Lloesmouth.  
 Guy Mr. Philip, Bideford.
- Halse, Mr. R., C. G.<sup>d</sup>, Ardmore.  
 Hamilton, Mr. Geo., C. G.<sup>d</sup>.  
 Hamilton, H. A., Esq. (3)\*  
 Hamono, Mr. A., M. M.  
 Hauning, N., C. G.<sup>d</sup>, Dingle.  
 Hansell, P. S., Broadstairs.  
 Hansford, John, Weymouth.  
 Harrington, Mr. Dennis, Bere Island, Cork.  
 Harrington, Mr. Jas., Bridlington Quay.  
 Harrington, T., C. G.<sup>d</sup>.  
 Harris, F., Esq., Inspecting Officer, C. G.<sup>d</sup>, Seafield.  
 Harrison, Jacob, Shields.  
 Hatch, Mr. N. G., 1st Mate Ship *Berkshire*.  
 Hayden, Mr. F., Sandown.  
 Heal, J., Fisherman, Athersfield.  
 Heard, Rich., Esq., C. G.<sup>d</sup>.  
 Heath, Mr. Joshua, Coxswain of the Fowey Life-boat.  
 Heavly, P., Constable, Knock.  
 Hein, Mr. F. J., M. M.  
 Henin, P., Boulogne-sur-Mer.  
 Hennessy, J., C. G.<sup>d</sup>.  
 Henry, Lieut., R.N., C. G.<sup>d</sup>.  
 Henslow, Lt., R.N., C. G.<sup>d</sup>.  
 Henwood, T., C. G.<sup>d</sup>, Fowey.  
 Herbert, The Hon. Auberon.  
 Herrington, B., Southwold. (2)  
 Hick, Mr. M., Scarborough.  
 Hicks, Bernard, Scilly.  
 Hicks, Geo., C. G.<sup>d</sup>, Tyrella.  
 Hicks, Samuel, Seaman.  
 Higgs, S., Jun., Esq., Penzance. (2)  
 Higgins, W., Second Coxswain Penzance Life-boat.  
 Highland, Owen, Anglesey.  
 Hildebrand, H., Esq. Clifden. (2)  
 Hill, Mr. J., Coxswain, Newcastle, Dundrum, Life-boat.  
 Hill, Mr. W., Mate.  
 Hillary, Sir A. Wm., Bart.  
 Hillary, Sir Wm., Bt. (4)\*  
 Hills, W., late Coxswain of the Padstow Life-boat. (2)  
 Hipplewhite, Mr. T., M. M., Warkworth.  
 Hodgson, J., Carver, Sunderland.  
 Hoed, Mr. F. P., M. M., ship *Phenomené*.  
 Hogben, J., late Coxswain of Ramsgate Life-boat.  
 Hogg, Mr. William, C. G.<sup>d</sup>.
- Holborn, S., Broadstairs.  
 Holland, Lieut. John, R.N.  
 Holman, Lieut. T., R.N.  
 Hood, R., Coxswain of the Seaton Carew Life-boat.  
 Hook, Mr. W., Seaton Carew.  
 Hook, R., Coxswain of Lowestoft Life-boat. (2)  
 Houghton, H., Hartlepool.  
 Howard, Francis, Private, 57th Regiment.  
 Howe, R., C. G.<sup>d</sup>, Ballygerig.  
 Howell, Mr. J., Port Talbot.  
 Howarth, Capt. Wm., R.N.  
 Hughes, E., Sen., Cwmernan.  
 Hughes, G., Pilot, Guernsey.  
 Hughes, Mr. John, Liverpool.  
 Hughes, T., Pilot, Holyhead.  
 Hughes, Mr. W., Fisherman, Pittenween, N.B.  
 Humphreys, Mr. D., Liverpool.  
 Hurry, Mr. Stephen, M. M.  
 Huss, Mr. T., H.M.S. *Rover*.  
 Hutchinson, Mr. H., C. G.<sup>d</sup>.  
 Hutchison, Lt., Kingstown.  
 Hutchison, Lieut. W., R.N.\*  
 Hyde, James, Scilly.  
 Hynds, Mr. John Dundalk.  
 Hynes, B., C. G.<sup>d</sup>, Galway.
- Iles, The late Mr. John, Scarborough.  
 Inkster, Mr. Peter, M. M., Shetland.
- James, Lieut. Horatio, R.N.\*  
 James, Lieut. Wm., R.N.\*  
 Japp, Robert, Montrose.  
 Jarman, Isaac, late Coxswain of Ramsgate Life-boat. (2)  
 Jeffers, Rich., C. G.<sup>d</sup>, Dingle.  
 Jefferson, P., Newbiggin. (2)  
 Jellard, Mr. John, M. M.\*  
 Jenkins, L., Pilot, Port Talbot.  
 Jenkins, Mr. W., Fishguard.  
 Jennings, Mr. Wm., M. M., Harwich.  
 Jennings, W., C. G.<sup>d</sup>, Looe.  
 Jesse, Commander R., R.N.  
 Jinks, Mr. R., Chief Officer of Coast Guard, Cardigan.  
 Joachim, Capt., R.N. (4)  
 Jobson, Lt. C., R.N. (2)\*\*  
 John, Mr. W., Breakeas.  
 Johns, Mr. Rich., Mevagissey.  
 Johns, Rich., Seaman, Fowey.  
 Johns, R. O., Coxswain of the Tramore Life-boat. (3)  
 Johns, Mr. W., M. M.  
 Johnson, Admiral W. W. P., the late. (2)  
 Johnson, Wm., Yarmouth.  
 Johnston, Mr. B., M. M.  
 Jones, Capt. C. Gray, R.N., the late. (2)  
 Jones, Mr., C. G.<sup>d</sup>, Wicklow.  
 Jones, Mr., C. G.<sup>d</sup>, Swords.  
 Jones, Mr. E., M. M.  
 Jones, Henry, Penzance.  
 Jones, J., Pilot, Porthcawl.  
 Jones, Owen, Anglesey.  
 Jones, Lt. R., R.N., C. G.<sup>d</sup>. (3)\*  
 Jones, Mr. T., M. M., Port Talbot.  
 Jones, Mr. T., M. M., Cardiff.  
 Jones, Mr. Thos., Holyhead.  
 Joy, Mr. George, M. M.\*  
 Juniper, Wm., Mundesley.
- Kavanagh, Peter, Coxswain of the Arklow Life-boat.  
 Kearon, Capt. Edw., Arklow.  
 Kelly, Lieut. E., R.N.  
 Kelly, J. M., Appledore.  
 Kendall, W., C. G.<sup>d</sup>.  
 Kennedy, Inspecting-Lt. A., R.N., C. G.<sup>d</sup>, Ballyheige. (2)
- Kennedy, E., C. G.<sup>d</sup>.  
 Kennedy, Mr. H., Belfast.  
 Kennedy, Master J., Belfast.  
 Kerley, T., C. G.<sup>d</sup>, Penzance.  
 Kerruish, Mr. John, C. G.<sup>d</sup>.  
 Kidd, D., Fisherman, Dundee.  
 Kinch, H., Newcastle.  
 King, Mr. T., M. M., Harwich.  
 King, Lt. S., R.N., Southend.  
 Kisbee, Com. Thos., R.N.  
 Knight, Mr. Charles, Mate, Ramsgate Steamer *Vulcan*.  
 Knight, J. T., C. G.<sup>d</sup>, Sunderland.  
 Kyle, Geo., Assis. Coxswain Holy Island Life-boat.  
 Kyle, Matthew, Coxswain Holy Island Life-boat.
- Lake, Mr. A., Chief Officer of C. G.<sup>d</sup>, Wick, N.B.  
 Lambert, John, Harwich.  
 Lambeth, Benj., Harwich.  
 Landells, Mr. Thos., Milford.  
 Lane, Lt., R.N., Dartmouth.  
 Langan, Mr. Michael, First Officer of Steamer *Princess Alexandra*.  
 Langton, Lieut. T. W., R.N., C. G.<sup>d</sup>.  
 Large, Mr. J., Master Gunner, R.A.  
 Larkin, Thomas, Seaman.  
 Lavington, Lt. Thos., R.N.  
 Lazoix, Lieut. of the French Marine at Dieppe.  
 Leask, Mr. Robert, jun., Ireland, near Stromness.  
 Leese, Charles, Gunner, R.A.  
 Le Geyt, Miss A. B., Bath.  
 Leggett, Edw., Gunner.  
 Leigh, Lt. T., R.N., C. G.<sup>d</sup>. (3)\*\*  
 Leslie, Mr. J., M. M., Stonehaven, N.B.  
 Lett, Lt. S. J., R.N., C. G.<sup>d</sup>.  
 Levett, Mr. N., late Coxswain of the St. Ives Life-boat.  
 Lewis, E., Seaman, Barmouth.  
 Lewis, Mr. G., C. G.<sup>d</sup>, Newport, Pembroke.  
 Lewis, J., Seaman, Harwich.  
 Lewis, Mr. Thos., Dundalk.  
 Lewis, W., Seaman. (2)  
 Lewis, W., Aberystwith.  
 Ley, J., Pilot, Mevagissey.  
 Liffen, Thomas, Lowestoft.  
 Likely, Henry, Limerick.  
 Linaker, Mr. Hiram, New Brighton.  
 Lindsay, Lieut. Jas., R.N.\*  
 Lingard, Lieut. J., R.N., Whitby.\*  
 Lithaby, P., C. G.<sup>d</sup>, Boatman.  
 Llewellyn, Mr. David, C. G.<sup>d</sup>.  
 Llewellyn, M., Fishguard.  
 Llewellyn, Martha, ditto.  
 Lloyd, O., C. G.<sup>d</sup>, Lulworth.  
 Lloyd, Lt. S., R.N., C. G.<sup>d</sup>.  
 Lose, Mr. John, C. O., C. G.<sup>d</sup>, Swanage.  
 Louchet, L. P. A. B., Anthie.  
 Loughor, Rees, Monkash.  
 Love, Private Robert, 63rd Regiment.  
 Lovell, Patrick, Belmullett.  
 Ludlow, Mr. I., Master of the American ship, *Mosmouth*.  
 Lusk, Mr. A., Raeberry, N.B.  
 Lyons, Lieut. Wm., R.N. (2)
- Macalister, Mr. Robt., Wick.  
 Macdonald, George, C. G.<sup>d</sup>.  
 Mackay, Mr. James.  
 Mackell, Mr. Patrick, C. G.<sup>d</sup>.  
 Mackintosh, Mr. Alex., M. M.  
 MacMahon, Capt. H., M. M., East Clare Militia.  
 Macnamara, Lt. T., R.N., C. G.<sup>d</sup>.
- McArdle, Thomas, Dundalk.  
 McCarthy, J., C. G.<sup>d</sup>, Dundrum.  
 McCarthy, Jas., C. G.<sup>d</sup>, Kilrush.  
 McCombie, Mr. Thomas, Second Officer of Steamer *Princess Alexandra*.  
 McCulloch, K., C. G.<sup>d</sup>, Eife. (2)  
 McDonald, Mr. Wm., Irvine.  
 McGenis, G., barque *Abany*.  
 McGladery, Lt. J., R.N., C. G.<sup>d</sup>.  
 McKenzie, J., C. G.<sup>d</sup>, Galway.  
 McKinnon, Mr. J., M. M., Greenock.  
 McMillan, J., Kintyre.  
 McNamee, P., C. G.<sup>d</sup>, Dunmanus.  
 McNaughten, Neil, C. G.<sup>d</sup>.  
 McQueen, Alex., Seaman.  
 Maddick, Mr. H., M. M.  
 Manby, Capt. G. W.\*  
 Manifold, Mr. William, Assis. Coxswain of the Arklow Life-boat.  
 Mann, Lieut., R.N., C. G.<sup>d</sup>.  
 Mariole, J. E., French Pilot.  
 Mark, Wm., C. G.<sup>d</sup>, Dingle.  
 Markwell, George, Holy Island.  
 Marsh, Capt. D., R.N., C. G.<sup>d</sup>.  
 Marshall, Capt. J., Bideford.  
 Marshall, Mr. John, Jun., Second Coxswain of the Seaham Life-boat.  
 Martin, Mr. Chas., C. G.<sup>d</sup>, St. Ives, Cornwall.  
 Mason, J., C. G.<sup>d</sup>, Eife.  
 Matthews, Lt. R. B., R.N.\*  
 May, Mr. A. C., H.M.S. *Rover*.  
 May, W. R., C. G.<sup>d</sup>, Boscastle.  
 Meader, Henry, Life-boatman, Ramsgate.  
 Mearns, Wm., Coxswain of Montrose No. 1 Life-boat.  
 Mearns, Wm. Jun., Coxswain of Montrose No. 2 Life-boat.  
 Mearns, Mr. R., jun., M. M., Montrose.  
 Metherell, Lt. R. E., R.N., C. G.<sup>d</sup>.  
 Mewse, A., Boatman, Lowestoft.  
 Middleton, John, Deal.  
 Milburn, John, Shields.  
 Milburn, Wm., Isle of Man.  
 Miller, J., C. G.<sup>d</sup>, Devonport.  
 Miller, W., Ramsgate.  
 Milligan, Mr. G., Yarmouth.  
 Mills, C., C. G.<sup>d</sup>, Clifden.  
 Minter, O., Boatman, Deal.  
 Mitchel, J., Pilot, Guernsey.  
 Mitchell, C., Port Isaac. (2)  
 Mittin, Philip, Wexford.  
 Moar, Mrs., Burra Ness.  
 Monger, Mr. Thomas, Coxswain of Tenby Life-boat.  
 Moody, Samuel, Skegness.  
 Moody, Samuel, Coxswain of Skegness Life-boat. (2)  
 Moore, Gunner Jas., Coast Brigade, Royal Artillery.  
 Moreno, Mr. Master of the Austrian Barque *Eva*.  
 Morgan, John, Thurso, N.B.  
 Morgan, Lt. R., R.N., C. G.<sup>d</sup>.  
 Morgan, Mr. T., R.C., *Stork*.  
 Morris, Capt. J. Row, E.N.\*  
 Morris, R., Seaman, Holyhead.  
 Morris, Mr. W. E., Port Madoc.  
 Morrison, Lt., R.N., C. G.<sup>d</sup>.  
 Morrison, W., Ballywalter.  
 Morrison, Mr. Silvester, C. G.<sup>d</sup>, Sennen Cove.  
 Mortley, Mr., C. G.<sup>d</sup>, Padstow.  
 Moss, J., Boatman, Walmer.  
 Mudl, Wm., Harwich.

- Mulligan, James, Sligo.  
 Murphy, James, C. G<sup>d</sup>, St. Ives, Cornwall (2).  
 Murphy, Mr. Adam, Coxswain of Tyrella Life-boat.  
 Murphy, Mr. Michael, C. G<sup>d</sup>, Coxswain of New Romney Life-boat.  
 Murray, A., C. G<sup>d</sup>, Elic.  
 Nelson, Mr. W., R.N., C. G<sup>d</sup>.  
 Nepean, Capt. St. Vincent, R.N.  
 Newnham, Lt. N., R.N., C. G<sup>d</sup>.  
 Newsom, Mr. W., M. M., Harwich.  
 Nichol, Mr. J., M. M., Montrose.  
 Nicholas, Matt., Coxswain of the Sennen Cove Life-boat.  
 Nicholson, M., Knock.  
 Nicole, Mr. Philip, Jersey.  
 Norcock, Capt. G. L., R.N.  
 Norris, Benj., Boatman, Deal.  
 Norris, Mr. James, M. M.  
 Norris, Martin, R.N.R.  
 Nott, Capt. E. B., R.N. (2)  
 O'Neill, Patrick, Scilly.  
 Orr, Mr. Robt., Irvine, N.B.  
 O'Shaughnessy, Miss Nora.  
 O'Sullivan, Mr. M., Bere.  
 O'Sullivan, D., C. G<sup>d</sup>.  
 Owen, Capt. Wm., Holyhead.  
 Owen, Mr. William, M. M.\*  
 Owen, Richard, Anglesey.  
 Owston, Mr. John, Coxswain of the Scarborough Life-boat.  
 Page, Mr. Alfred, Master, Ramsgate Steamer *Fulcan*.  
 Palmer, G., Esq., M.P. (2)\*\*  
 Parker, Mr. Edwin, C. G<sup>d</sup>, Mothecombe.  
 Parker, Mr. J., Flamboro'.  
 Parker, Mr. Wm., M. M.  
 Parrott, Mr. R., C. G<sup>d</sup>, Tenby. (2)  
 Parry, Lieut., R.N.\*  
 Parry, Mr. Henry, Anglesey.  
 Parry, Mr. R., M. M., Portmadoc.  
 Parsons, Lieut. Thos., R.N.  
 Parsons, Lieut. Rich., H.M. 35th Regiment.  
 Parsons, Lt. W., R.N., C. G<sup>d</sup>.  
 Partridge, Capt. W. L., R.N., C. G<sup>d</sup>.  
 Pascoe, Peter, Porthleven.  
 Paul, Thos., C. G<sup>d</sup>, Bude.  
 Payne, Mr. John, C. O., C. G<sup>d</sup>, Skerries.  
 Paynter, Capt. Richard.  
 Peake, Admiral T. L.\*  
 Peake, James, Esq., H.M. Dockyard, Devonport.\*  
 Pearce, Rich., Esq., Penzance.  
 Pearce, Jas., Pilot, Porthcawl.  
 Pearce, T., Pilot, Porthcawl.  
 Peart, John, Montrose.  
 Pedder, Lt. W., R.N., C. G<sup>d</sup>.  
 Peebles, Mr. John, Irvine.  
 Peebles, Mr. T., M. M., Irvine.  
 Peirson, S. H., C. G<sup>d</sup>, Ballygeris.  
 Penny, Robert, Ramsgate Life-boatman.  
 Pepper, J., C. G<sup>d</sup>, Lymington.  
 Perkins, Jas., C. G<sup>d</sup>, Bude.  
 Perrott, Sir Edward G. L., Bart., V.P.\*  
 Petrie, Ellen, Shetland.  
 Phillips, J., Newcastle, Ireland.  
 Pizard, Mr. P., French M. M.  
 Pilcher, Mr. Stephen, Coxswain Tramore Life-boat.  
 Pillar, W., Gunner, H.M.S. *Eagle*.  
 Pincomb, T., Pilot, Exmouth.  
 Pitt, E., C. G<sup>d</sup>, Atherfield.  
 Pomeroy, H., C. G<sup>d</sup>, Mevagissey.  
 Porter, William, Seaman.  
 Powell, Mr. John, M. M.  
 Pratt, Lt. Jas., R.N., C. G<sup>d</sup>.  
 Prattent, Lieut. John, R.N.\*  
 Preston, Mr. C. G<sup>d</sup>, Newton.  
 Prewel, R., C. G<sup>d</sup>, Kilrush.  
 Price, Thos., Beammaris.  
 Pride, C. C. G<sup>d</sup>, Christchurch.  
 Prior, Lt. H. R.N., C. G<sup>d</sup>.  
 Prosser, Mr. H., C. G<sup>d</sup>.  
 Purdy, H., C. G<sup>d</sup>, Tyrella.  
 Puxley, H., Esq., Dunboy.  
 Pym, Lt. R. E., R.N., Whitby.\*  
 Quaid, Mr. B. E., C. G<sup>d</sup>, (2)\*  
 Quayle, Capt. E., Isle of Man. (2)  
 Quigley, Mr. W. T., C. G<sup>d</sup>.  
 Quirke, G., Esq., Douglas.  
 Rae, Wm., Whitburn.  
 Randall, Lt. H., R.N., C. G<sup>d</sup>, (2)\*\*  
 Randle, Mr. J., Bristol.  
 Rawstone, Lt. R.N., C. G<sup>d</sup>.  
 Ray, J., Boatman, Tenby.  
 Raye, Lieut. H. R., R. M.  
 Read, Lieut. J., R.N., C. G<sup>d</sup>.  
 Reade, W. M., Esq., Tramore.  
 Reading, Mr. Daniel, Master of Ramsgate Har. str. tug.  
 Redford, J., Cullercoats.  
 Rees, Mr. A., Port Talbot.  
 Rees, Mr. T. M., St. David's.  
 Rees, Mr. W., Fishguard.  
 Reeve, Mr. J., Swansea.  
 Reilly, Patrick, Private, A.S.C.  
 Regan, D., C. G<sup>d</sup>, Kilmore.  
 Renowden, J., C. G<sup>d</sup>, Dingle.  
 Revell, Edw., Seaman, Ramsgate Steamer *Fulcan*.  
 Richards, Mr. E., M. M.  
 Richards, Mr. T., M. M.  
 Richards, James, Penzance.  
 Richards, Henry, Penzance.  
 Richardson, Mr. A., M. M.  
 Richardson, W., Esq., Coleraine.  
 Ridge, Capt. G. A. E., R.N.  
 Ridge, Mr. J., Mate of R.C. *Kiie*.  
 Ridge, Mr. J., C. G<sup>d</sup>, Cadgwith.  
 Rioch, R., C. G<sup>d</sup>, Colleston.  
 Ritchie, Mr., Sanda.  
 Rivers, T., C. G<sup>d</sup>, Lydd.  
 Roberts, Mr. John, Clogwyn.  
 Roberts, Mr. R., Carnarvon.  
 Roberts, O., Pilot, Anglesey.  
 Robertson-Macdonald, Vice-Admiral D.  
 Robertson, Lieut. R., R.N.\*  
 Robertson, Lt. J. H. M., R.N.  
 Robins, Mr. J. Gunn, C. G<sup>d</sup>.  
 Robinson, Mr. J., Aberdeen.  
 Robinson, Lieut., R.N.  
 Robinson, T., Whitby.  
 Rockcliffe, W., Southport.  
 Roderick, E., C. G<sup>d</sup>, Dunmanus.  
 Roderick, J. S., Esq., Ardmore.  
 Rodgers, J., *Royal Charter*.  
 Roe, R., Esq., J.P., Lynnmouth.  
 Rose, W., Boatman, Lowestoft.  
 Ross, Capt. Sir Thos., R.N.\*  
 Ross, R., C. G<sup>d</sup>, Curracloe.  
 Ross, R., C. G<sup>d</sup>, Dunmore.  
 Rossiter, T., Wexford.  
 Rothery, Lieut. J., R.N.  
 Rowe, W., C. G<sup>d</sup>, Dingle.  
 Rowe, W., Scilly.  
 Rowe, W., Seaman, Helston.  
 Rowlands, Mr. T., M. M., Newport, Pembroke.  
 Rowlands, Mr. W., Coxswain, Holyhead Life-boat. (2)  
 Ruddock, J., Boatman, Ffley.  
 Russell, R., Esq., J.P.  
 Rutter, Mr. J., Scarborough.  
 Rymer, Lt. D., R.N., C. G<sup>d</sup>.  
 Salmon, C., Fisherman, Gorseston.  
 Sanderson, Lieut. J. P., R.N., C. G<sup>d</sup>, Bridge of Don.  
 Sands, Mr. R., M. M., Bahamas.  
 Sarony, Mr. O., Scarborough.  
 Sauvage, Mr., French Fishing-boat *Isabelle*.  
 Sawtell, Mr. Edwin, C. G<sup>d</sup>.  
 Scarlett, R., Harwich.  
 Scott, Mr. G. R., *Beethoven*.  
 Scott, Mr. J., M. M.  
 Selly, W. H., C. G<sup>d</sup>, Penzance. (2)  
 Sergeant, Lt. J., R.N., C. G<sup>d</sup>.  
 Sewell, Lt. H. F., R.N., C. G<sup>d</sup>.  
 Sewell, Master John, Belfast.  
 Shanahan, Mr. Michael, Bere Island, Cork.  
 Shankey, R., C. G<sup>d</sup>, (2)  
 Shannon, P., C. G<sup>d</sup>, Kilrush.  
 Sharrock, J. P., C. G<sup>d</sup>, Boscawle.  
 Shaw, Lt. C., R.N., C. G<sup>d</sup>.  
 Shea, D., Coxswain of the Padstow Life-boat. (3)  
 Shea, D., C. G<sup>d</sup>, Porthcawl.  
 Sheldon, Robt., Redcar.  
 Simpson, Mr. Jas., late Mate of Ramsgate H. Steamtugs.  
 Sims, J., C. G<sup>d</sup>, Dungeness.  
 Sims, Lt. And., R.N. (2)  
 Sinclair, Mr. B., Thurso, N.B.  
 Sirmott, R., C. G<sup>d</sup>, Mullagmore.  
 Smallridge, Mr. J. H., Coxswain Braunton Life-boat.  
 Smith, F., Boatman, Lowestoft.  
 Smith, Hy., Pilot, Gloucester.  
 Smith, J., Shields.  
 Smith, Mr. J., Thurso.  
 Smith, Mr. Owen, Bideford.  
 Smith, Peter, C. G<sup>d</sup>, Lydd.  
 Smith, T., C. G<sup>d</sup>, Ballina.  
 Smith, Wm., Bombardier, R.A.  
 Smith, Mr. W., Aldborough.  
 Smyth, H., C. G<sup>d</sup>, Kilmore.  
 Snell, Lt. G., R.N., C. G<sup>d</sup>.  
 Somerville, Lt. J., R.N., C. G<sup>d</sup>, (2)\*  
 Southey, Lt., R.N., C. G<sup>d</sup>.  
 Spark, Mr. A., M. M.  
 Spraggs, J., Seaman, Hayling.  
 Stables, R., Holyhead.  
 Stannard, Mr. F., M.M., Southwold.  
 Stap, Mr. R., C. G<sup>d</sup>, Dunbar.  
 Stark, Lt. P., R.N., C. G<sup>d</sup>, (2)\*  
 Starke, Mr. J., C. G<sup>d</sup>, Queens-town.  
 Steane, Lt. J., R.N., Rye.\*  
 Steel, Mr. C., C. G<sup>d</sup>.  
 Stephens, A., Tramore.  
 Stephenson, Mr. B., Coxswain of the Boulmer Life-boat.  
 Stevens, Henry, Gunner R.A.  
 Stewart, W., C. G<sup>d</sup>, Ardmore.  
 Storr, J., Whitby.  
 Stone, J., C. G<sup>d</sup>, Boscawle.  
 Stragnell, Lt., R.N.  
 Strahan, Mr. H., Pilot.  
 Strains, Mr. J., C. G<sup>d</sup>.  
 Streader, Mr. W. T., H.M. Customs, Shoreham.  
 Strong, Mr. Fran. F. M.  
 Stuart, Lt. J., R.N., C. G<sup>d</sup>.  
 Stuart, Lt. T., R.N., C. G<sup>d</sup>, (2)  
 Stubbs, C., Seaman.  
 Stubbs, H., Atherfield.  
 Stuggins, Mr. W., Second Coxswain of Teignmouth Life-boat.  
 Sullivan, J., Newhaven.  
 Sumner, Mr. R., Forrby.\*  
 Superville, Mr., M. M., Bordeaux.  
 Surry, W., Penzance.  
 Sutherland, D., C. G<sup>d</sup>, Katerline.  
 Sutter, Mr. J., M. M.  
 Sutton, Mr. C., Port Talbot, M. M.  
 Swarbrick, Mr. W., M. M.  
 Symmes, Lt. H. A. S., R.N., C. G<sup>d</sup>.  
 Syngé, The Rev. A., Balbriggan.  
 Taft, Grace, Shetland.  
 Talbot, C. R. M., Esq., M.P.  
 Taylor, J., C. G<sup>d</sup>, Dandrum.  
 Taylor, Mr. W. C. O., C. G<sup>d</sup>, Dunny Cove. (3)  
 Tegg, Mr. T., M. M., Cornwall.  
 Terrett, T., Constable, Knock.  
 Thomas, J., C. G<sup>d</sup>, Atherfield.  
 Thomas, J., C. G<sup>d</sup>, Rocken, Isle of Wight.  
 Thomas, R. J., Coxswain of New Brighton Life-boat.  
 Thompson, D., Thurso, N.B.  
 Thompson, Mr. G., Annalong.  
 Thompson, Mr. E. Kirkpatrick, C. O., C. G<sup>d</sup>, (3)\*  
 Thompson, W., Apprentice, Smack *Ruby* of Hull.  
 Thorp, Mr. T., Newcastle.  
 Tindall, Mr. Smith, M. M., Scarborough.  
 Tindall, The late W., Esq., Scarborough.  
 Toole, Capt. W., Curracloe.  
 Toomey, J., Kingstown.  
 Torrens, Lieut. John A. W.  
 O'N., Royal Scots Greys.\*  
 Town, J., C. G<sup>d</sup>, Folkestone. (2)  
 Town, J., C. G<sup>d</sup>, Castle-gregory.  
 Tredwen, Mr. R., Padstow.  
 Tregidgo, Mr. W. H., C. G<sup>d</sup>, Newquay. (3)  
 Trent, J., Atherfield.  
 Trestlan, Mr. R.  
 Tripbock, Mr. R., R. C. *Hamilton*, Duunworldly.  
 Trot, T., Boatman, Deal.  
 Tucker, Mr. T., Bideford.  
 Tudor, Capt. J., R.N., Wick. (2)  
 Tully, W., Newcastle. (bar. Turnbull, R., Fisherman, Dun-Turner, Lt. C., R.N.  
 Turpin, Mr. J., C. G<sup>d</sup>, Salcombe.  
 Tutt, E., C. G<sup>d</sup>, Dunmanus.  
 Tuvache, Mr. M. M. French.  
 Urell, Mr. Joseph, C. O., C. G<sup>d</sup>, Hope Cove.  
 Usher, Mr. J., Bridlington.  
 Van Houten, Mr. W., Rotterdam. (2)  
 Verion, Chas., Life-boatman, Ramsgate.  
 Vicary, Lt. W., R.N., Atherfield.\*  
 Vondy, I., Isle of Man. (3)  
 Waddy, Dr., Churchtown.  
 Wade, Mr. M. M., Padstow.  
 Wake, Mr. Baldwin Arden, Mid. H.M.S. *Forester*.  
 Wales, G., Broadstairs.  
 Wales, J., ditto, ditto.  
 Walker, Lieut., R.N.  
 Walker, Mr. J., Brigg.  
 Walker, Mr. W. Lewis, Beaumaris. (2)  
 Wallace, Mr. J., M. M.  
 Walsh, J., Esq., Lloyd's Agent, Dublin.  
 Walsh, Mr. Martin, M. M.\*  
 Ward, J., R. C. *Sylvia*.  
 Ward, Vice-Admiral J. E.

Warder, D. T., C. G <sup>d</sup> .	Welsh, Mr. M., M. M.	Wilds, Mr. Robert, Coxswain of the Deal Life-boat.	Wilson, W., Pilot, Holy Island.
Warn, W., sen., Atherfield.	West, Mr. Wm., C. G <sup>d</sup> , Dymchurch.	Wilkie, Mr. C., M. M.	Wishart, J., Wick, N.B.
Warn, W., jun., ditto.	Westbrook, Lieut., R.N.	Willcox, J., C. G <sup>d</sup> , Lydd.	Wood, Mr. T. L., C. G <sup>d</sup> . (2)
Warren, Lt. C. D., R.N.	Wharrier, Mr. William, En- gineer of Ramsgate Har- bour Steam-tug. (2)	Williams, Mr. D., Aberdovey.	Woodham, Lt., R.N., Banff.
Wasey, Capt. E. F.N.K., R.N. (3)	Wheeler, C., Atherfield.	Williams, Mr. J., Swansea.	Woodward, Geo., Stoker, Ramsgate Steamer <i>Vulcan</i> .
Waters, Wm., Southwold.	Wheeler, J., ditto. (2)	Williams, Owen, Cemlyn.	Wordley, S., Harwich.
Watt, A., Montrose.	Wheeler, R., ditto.	Williams, Rev. O. Lloyd. (2)	Wright, John, Seaman.
Watts, Lieut. W. S., R.N.*	Wheeler, W., Pilot.	Williams, Rev. J., Anglesey.*	Wright, Mr. J., M. M.
Watts, Mr. Charles, M. M.	White, Jas., Coxswain of the Fishguard Life-boat. (3)	Williams, Mr. J. M., Padstow.	Wyatt, G., Seaman, Harwich.
Watts, Mr. William, M. M.	White, John, Coxswain of Howth Life-boat.	Williamson, Mr. R., M.M. (2)	Wylde, Lt. S., R.N., C. G <sup>d</sup> .
Waugh, E., C. G <sup>d</sup> , Wexford.	White, Joseph, Portland.	Williamson, Robert, Thurso.	Wyrill, H., Boat <sup>s</sup> , Scarboro'.
Webbin, J., C. G <sup>d</sup> , Tramore.	White, J. Kearney, Esq., C. G <sup>d</sup> . (2)	Williamson, W., Pilot, Wick.	
Webster, Mr. John, Cox- swain of Maryport Life- boat.	Whitley, Mr. Elias, Jersey.	Wilson, J., Pilot, St. Andrew's.	Yare, Richd., Stoker, Rams- gate Steamer <i>Vulcan</i> .
Wedge, W., C. G <sup>d</sup> , Salcombe.		Wilson, Mr. J., M. M.	Young, A., C. G <sup>d</sup> , Shoreham.
Weekes, Wm. Wall, Seaman.		Wilson, Ralph, Holy Island.	Young, A. H., C. G <sup>d</sup> , Blatch- ington.
Weldrake, E., Spurn Point.		Wilson, T., Esq., M.P.*	Young, Lt. T., R.N., C. G <sup>d</sup> .
		Wilson, T., Pilot, Holy Island.	

*The following is a copy of a Handbill circulated on the Coasts of the United Kingdom by the Institution, for the purpose of informing Boatmen and others that it encourages laudable exertions to save Life from Shipwrecks:—*

### TO BOATMEN AND OTHERS.

To encourage prompt and energetic exertions in time of Danger on the part of Boatmen and Others, by quickly putting off to save Life in CASES of WRECKS on the Coasts of the British Isles, either by

#### SHORE-BOATS OR OTHER MEANS,

### The Royal National Life-boat Institution

#### GRANTS

Rewards of Money or Medals. In all cases the Rewards are given without further delay than is necessary to obtain proof of the merits of each case, and to ensure their being paid to the right parties.

Application to be made to the Secretary.

By Order of the Committee.



## THE LIFE-BOAT STATION.

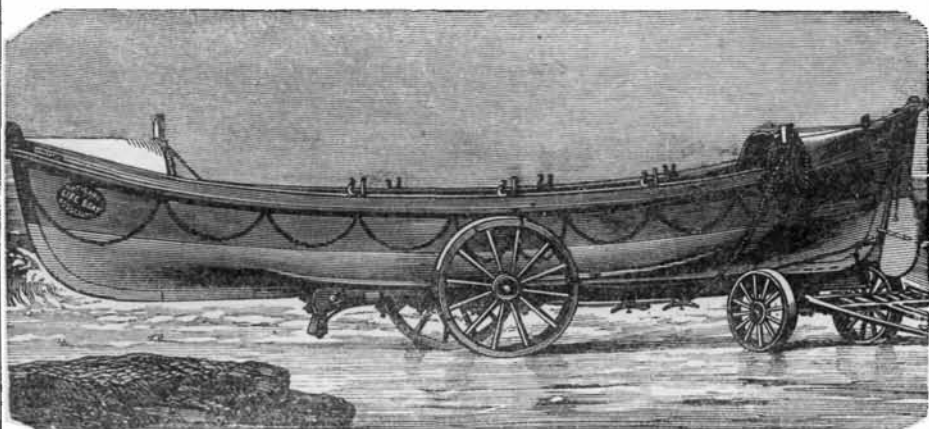

THE following brief description and diagrams illustrative of a complete Life-boat Establishment, including the House for the protection of the boat, will serve to convey an idea of the general character of one of the 271 Life-boat Stations of the NATIONAL LIFE-BOAT INSTITUTION.

It will be seen that it is a work of a costly nature, and that not only in the first instance, but that a large permanent expense is entailed in keeping the whole machinery in an efficient state, in the re-supply of any part of it which may be destroyed or worn out, in the exercise of the boats' crews, in launching and working the boats, and in remunerating them for their services in saving their fellow-creatures. Yet, looking to the vast importance of the result effected, and the responsibility of calling on men to risk their lives in effecting the same, it is felt that few if any persons will be found who will consider that expense to be incurred in vain.

### THE LIFE-BOAT.

(See Diagrams on next page.)

The following figures show the general form, the nature of the fittings and air-chambers of one of these boats, 33 feet in length and 8 feet in breadth. In figs. 1 and 2, the elevation and deck plans, the general exterior form of the boat is shown with the sheer of gunwale, length of keel, and rake of stem and stern-posts. The dotted lines of fig. 1 show the position and dimensions of the air-chambers within board, the relieving-tubes, and ballast. In fig 2, A represents the deck, B the relieving-tubes (6 inches in diameter), C the side air-cases, D the end air-chambers, E ballast, F scuttles to admit of a free current of air under the water-tight deck, G scuttle for air, and to receive pump. In fig. 3, the exterior form of transverse sections, at different distances from stem to stern, is shown. Fig. 4 represents a

midship transverse section, A being sections of the side air-cases, B the relieving-tubes, of the same depth as the space between the deck and the boat's floor. C, C, C, C, are spaces beneath the deck, placed longitudinally, at the midship part of the boat, with cases packed with cork, forming a portion of the ballast; *d* scuttle for ventilation, having a pump fixed in it, by which any leakage beneath the deck can be pumped out by one of the crew whilst afloat. The festooned lines in fig. 1 represent exterior life-lines attached round the entire length of the boat, to which persons in the water may cling till they can be got into the boat; the two central lines are festooned lower than the others, to be used as stirrups, so that a person in the water, by stepping on them, may climb into the boat without assistance.

[Fig. 1.

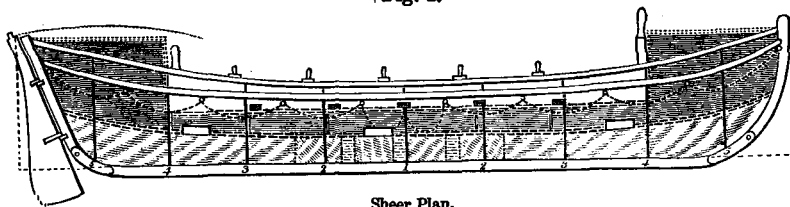

Sheer Plan.

Fig. 2.

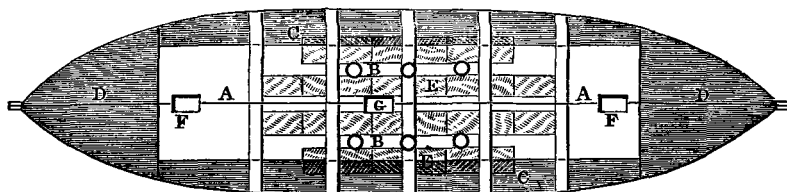

Deck Plan.

Fig. 3.

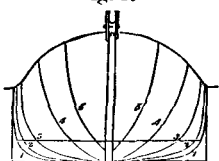

Body Plan.

Fig. 4.

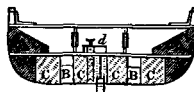

Midship Section.

This Life-boat possesses in the highest degree all the qualities which it is desirable that a Life-boat should possess:—

1. Great lateral stability, or resistance to upsetting.
2. Speed against a heavy sea.
3. Facility for launching and taking the shore.
4. Immediate self-discharge of any water breaking into her.
5. The important advantage of self-righting if upset.
6. Strength.
7. Stowage room for a large number of passengers.

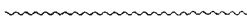

## THE LIFE-BOAT TRANSPORTING-CARRIAGE.

The Life-boat transporting-carriage is a very important auxiliary to the boat. Every Life-boat, except a few of the larger size, is provided with a carriage, on which she is kept in the boat-house ready for immediate transportation to the most favourable position for launching to a wreck. A Life-boat is thus made available for a greater extent of coast than she otherwise would be; and even when launched from abreast of the boat-house, can be much quicker conveyed to the water's edge than she could be if not on a carriage. In addition to this ordinary use, a carriage is of immense service in launching a boat from a beach, to that extent, indeed, that one can be readily launched from a carriage through a high surf, when without one she could not be got off the beach.

The carriage consists of a fore and main body. The latter is formed of a keelway, and of side or bilgeways attached to the keelway, and resting on the main axle, the

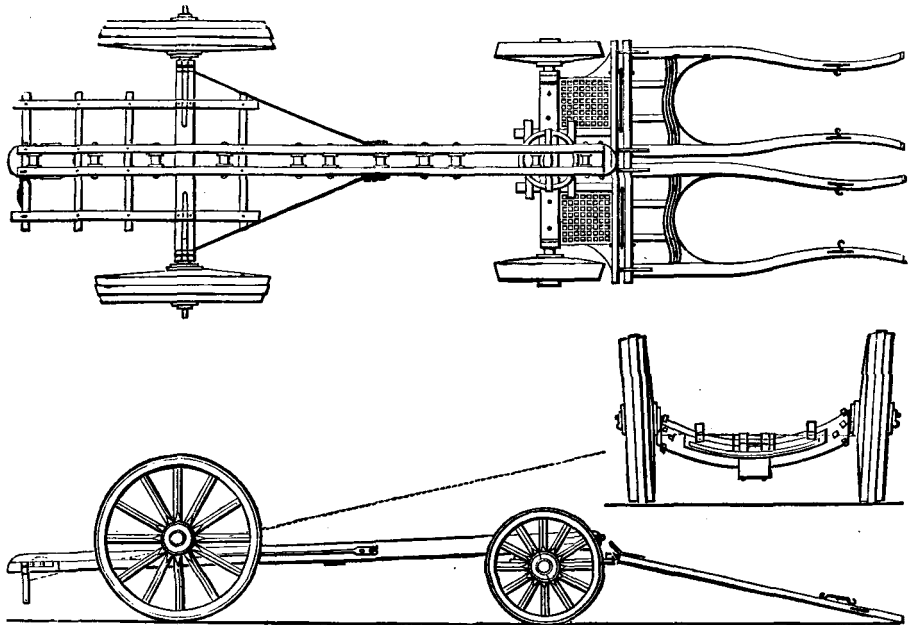

boat's weight being entirely on the rollers of the keelway. Its leading characteristic is that, on the withdrawal of a forelock pin, the fore and main bodies can be detached from each other. The advantages of this arrangement are that, whilst on the one hand the weight of the boat when she is launched from the rear end forms an inclined plane by elevating the keelway and fore-carriage; on the other hand, to replace her on the carriage she can be hauled bow foremost up the fore end or longer incline, by disconnecting the fore-carriage, and letting the end of the keelway rest on the ground, thus forming an inclined plane up which the boat is easily drawn. The bilgeways are needed at the rear end, that the boat may be launched in an upright position, with her crew on board, but they are not required at the fore end of the carriage.

A very full equipment of stores is supplied to the Life-boats of the Institution—such as cork life-belts, anchors and cables, grapnels and lines, life-buoys, lanterns, rockets, and many other articles, together with portable or launching-skids.

## THE LIFE-BOAT HOUSE.

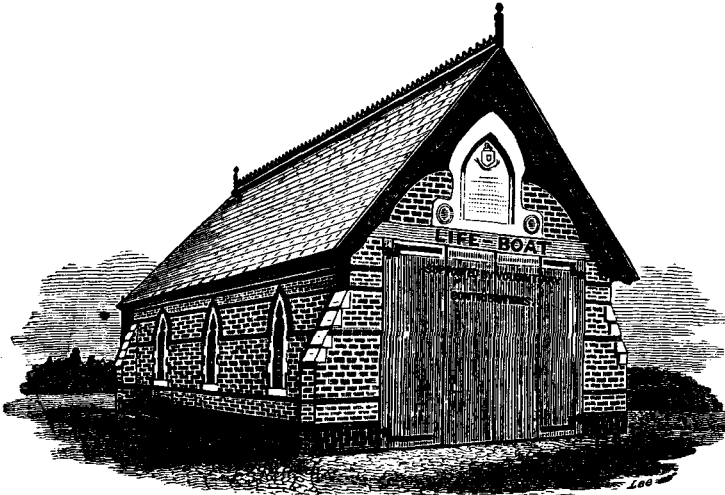

The boats of the NATIONAL LIFE-BOAT INSTITUTION, and all belonging to them, are kept in roomy and substantial boat-houses, under lock and key, in charge of paid coxswains, under the general superintendence of local honorary committees of residents in the several localities. Each boat has its appointed coxswain at a salary of 8*l.*, and an assistant at 2*l.* a year. The crew consists, in addition, of a bowman, and as many boatmen as the boat pulls oars. The members of the volunteer crews are registered, and wherever practicable, at least double the number of men required are entered on the register. Such men are mostly resident boatmen, fishermen, or Coastguardmen. On every occasion of going afloat to save life, the coxswain and each of the crew receive alike from the funds of the Institution (whether successful or not) 10*s.*, if by day, and 1*l.*, if by night; and 4*s.* each for every time of going afloat for exercise.

A reward of 7*s.* is given to the man who first brings intelligence of a wreck at such a distance along the coast as not to be in sight of the Coastguard Station or other look-out.

A flag hoisted by day, and the firing of a carronade (or other alarm signal) by night, are the well-known signals for calling the crew together.

On boarding wrecks, the preservation of life is the sole consideration. Should any goods or merchandise be brought into the Life-boat, contrary to the coxswain's remonstrance, he is authorised to throw them overboard.

The expense of a Life-boat Station averages 1,000*l.*, and is made up as follows:—

Life-boat and her equipment, including Life-belts for the Crew,	
Skids, and Transporting-carriage	£650
Boat-house (average cost)	350
Total	£1,000

The average Annual Expense of maintaining a Life-boat Station is 70*l.*

Such is a brief summary of the chief of the Regulations under which the Life-boats are worked. How faithfully and with what result they are carried out let the journals of each Life-boat Station and the annals of the Institution tell.

The NATIONAL LIFE-BOAT INSTITUTION has now 271 Life-boats under its charge. Every one of these has been specially presented to it, and they save every year from 600 to 700 shipwrecked sailors. Altogether, the Institution has contributed to the saving of 27,603 lives.

Despite, however, this fleet of 271 Life-boats, and of 30 others locally provided and supported, and despite the numerous rocket and mortar stations on our coast, there remains the melancholy fact that an average of 700 lives are lost annually on and around our own shores alone, proclaiming solemnly, though silently, that, for humanity's sake, and for the national credit, no exertions should be spared in providing every possible means for the conveyance of succour to the shipwrecked.

The Institution needs a permanent income of about 40,000*l.* to maintain its great Life-saving Fleet; and the Committee feel assured that it will never lack it so long as it maintains its boats in the state of thorough efficiency that they are in at the present time, and manned as they are on every emergency by as fearless and noble a class of men as ever our Nelsons and Collingwoods led to battle to uphold our country's honour and glory.

# LIST OF LEGACIES

PAID TO THE

## ROYAL NATIONAL LIFE-BOAT INSTITUTION.

*[Legacies of £50 and under are omitted after having been published two years.]*

	<i>Amount received.</i>	
	£	s. d.
1871—ABBOTT, JOHN, Esq., Halifax (Free of Duty) . . . . .	2,078	13 4
1879—ADOLPHE, Mrs. MARGARET, Dublin . . . . .	42	14 2
1868—ALDRED, Dr. G. E., Richmond (Free of Duty) . . . . .	100	0 0
1880—ALLAN, ROBERT, Esq., Glenhouse, N.B. (Ditto) . . . . .	500	0 0
1877—ANDERSON, Miss MARGARET, Leamington . . . . .	450	0 0
1874—ANNANDALE, ALEXANDER, Esq., Bolton, Lasswade, N.B. (Free of Duty) . . . . .	199	7 6
1866—ANSTICE, GEORGE, Esq., Chipping Norton . . . . .	90	0 0
1870—ANSTICE, Mrs. ELEANOR, Tynemouth (Free of Duty) . . . . .	700	0 0
1865—APPLEYARD, JOHN, Esq., Halifax . . . . .	1,800	0 0
1878—ARMSTRONG, THOMAS, Esq., Ore, near Hastings (Free of Duty) . . . . .	200	0 0
1877—ARNOLD, Miss ANN, Tavistock Hotel, Covent Garden . . . . .	1,118	1 11
1872—ATTON, ROBERT, Esq., Taunton (Free of Duty) . . . . .	800	0 0
1878—BACK, Admiral Sir GEORGE, F.R.S. . . . .	90	0 0
Ditto (Special Bequest) . . . . .	180	0 0
1880—BAGLEY, WILLIAM, Esq., Leicester (Free of Duty) . . . . .	200	0 0
1872—BAKER, Miss ELIZABETH, Stutton, Suffolk (Ditto) . . . . .	100	0 0
1872—BAKER, Miss HARRIET, Stutton, Suffolk (Ditto) . . . . .	100	0 0
1879—BAKER, Mrs. C. H., Acton . . . . .	19	0 0
1879—BALL, JAMES, Esq., Reading (Free of Duty) . . . . .	50	0 0
1875—BARKER, ALEXANDER, Esq., Piccadilly . . . . .	1,800	0 0
1880—BARNARD, ROBT., Esq., Painswick, Gloucester . . . . .	100	0 0
1879—BARNICOT, RICHARD, Esq., Dorking (Free of Duty) . . . . .	200	0 0
1868—BARROW, ROGER, Esq., Newcastle-on-Tyne . . . . .	90	0 0
1879—BATHO, JOSEPH ALEXANDER, Esq., Brighton . . . . .	90	0 0
1867—BEBB, Miss MARTHA, Bootham, York . . . . .	1,570	16 0
1869—BECKETT, J. S., Esq., Tormoham, Devon . . . . .	625	10 3
1880—BECKETT JAMES, Esq., Dublin . . . . .	10	0 0
1877—BECKETT, Miss A., Forham-St.-Martin (Free of Duty) . . . . .	600	0 0
1879—BECKWITH, Mrs. MARY, Tynemouth (Ditto) . . . . .	800	0 0
1870—BELL, MATTHEW, Esq., Glasgow (Ditto) . . . . .	200	0 0
1865—BENNETT, Miss JEMIMA, Sloane Street, Chelsea (Ditto) . . . . .	90	0 0
1875—BENTINCK, Lady CHARLES CAVENDISH . . . . .	339	6 0
1871-9—BERGER, Mr. GEORGE, Newcastle Street, Strand . . . . .	5	1 11
1875—BERGONZI, Madame, Boulogne (Free of Duty) . . . . .	200	0 0
1871—BERRY, ARTHUR, Esq., Liverpool (Ditto) . . . . .	100	0 0
1880—BEST, Mrs. ELEANOR, Kelston Millbrook, Southampton (Ditto) . . . . .	200	0 0
1874—BEWLEY, JOHN, Esq., Kingsland Road . . . . .	118	18 4
1880—BIGG, Mrs. ELIZA, Clifton . . . . .	109	9 7
1859—BIGGS, GEO., Esq., Strand (Free of Duty) . . . . .	100	0 0
1877—BIGGS, Miss L. M., St. John's Wood (Ditto) . . . . .	1,000	0 0
1877—BIRKETT, WILLIAM, Esq., Newton-in-Cartmell . . . . .	720	0 0
1876—BIRTWHISTLE, Miss M. A., Cheltenham . . . . .	900	0 0
1879—BOETEFEUR, ALEX., Esq., Bayswater . . . . .	8,020	6 2
1879—BOLT, ROBT., Esq., Poulton, Gloucester (Free of Duty) . . . . .	100	0 0
1868—BOLTON, Miss ELIZABETH, Chelsea . . . . .	415	2 6
1880—BOND, CHARLES, Esq., Potton, Bedford . . . . .	19	19 0
1860—BOWERBANK, Captain, R.N. . . . .	90	0 0
1876-8—BOWLES, Admiral Sir WILLIAM, K.C.B., Hill Street . . . . .	180	12 0
1877—BOYS, THOMAS, Esq., Hove . . . . .	5,447	14 9
1879—BRADBERRY, THOS., Esq., Finsbury Park (Free of Duty) . . . . .	500	0 0
1880—BROADHURST, Hon. Mrs. H. M., Richmond (Ditto) . . . . .	300	0 0
1865—BRODIE, Miss, York Place, Portman Square (Ditto) . . . . .	400	0 0
1869—BRODIE, Mrs. MARY ANN, Harley Street . . . . .	90	0 0
1868—BROMEHEAD, E. A., Esq., Thornthwaite, Cumberland (Free of Duty) . . . . .	100	0 0
1879—BROOKES, J. M., Esq., M.D., St. John's Wood . . . . .	90	0 0
1864—BROWN, Capt. HUGH, Kilmarnock, N.B. (Free of Duty) . . . . .	99	18 6
1869—BROWN, THOMAS, Esq., Ludgate Hill (Ditto) . . . . .	500	0 0
1877—BROWNE, Miss MARY, Liverpool (Ditto) . . . . .	250	0 0
1867—BROWNRIGG, Dr. THOMAS, Keighley, York . . . . .	180	0 0
1880-1—BRUCE, Miss JANE ISABELLA, Haddington . . . . .	1,237	8 0
1871—BURD, Mrs. MARY, Wantage (Free of Duty) . . . . .	1,500	0 0
1878—BURRELL, Miss F. A., Durham (Ditto) . . . . .	100	0 0
1877—BURY, CHARLES, Esq., Nazing (Ditto) . . . . .	500	0 0

*[Continued.]*

LIST OF PAID LEGACIES—*continued.*

	<i>Amount received.</i>		
	£	s	d.
1876-8—CAMERON, Miss E. . . . .	1,330	8	10
1877—CAMERON, Miss MARGARET . . . . .	356	19	11
1864—CAMPBELL, DAVID, Esq., Rothesay, N.B. . . . .	107	18	11
1877—CARLILE, Miss H. E., Clifton, Bristol . . . . .	90	0	0
1880—CAVE, the Right Hon. Sir STEPHEN, G.C.B. . . . .	4	4	0
1868—CHAPMAN, Mrs. MARY, Aldborough (Free of Duty) . . . . .	60	0	0
1876—CHELLINGWORTH, Miss A. W., Upton Bishop (Ditto) . . . . .	103	19	0
1872—CHORLEY, HENRY F., Esq., Eaton Place West (Ditto) . . . . .	600	0	0
1858—CHURCH, Miss, Berkeley . . . . .	90	0	0
1869—CLARK, Mrs. M. E., Addison Road, Kensington . . . . .	450	0	0
1868—CLAYTON, THOMAS, Esq., Wakefield (Free of Duty) . . . . .	250	0	0
1877—COATES, P. E. Esq., Stanton Court, Somerset . . . . .	450	0	0
1881—COHEN, Miss MATILDA, Inverness Terr., Bayswater (Free of Duty) . . . . .	100	0	0
1855—COLES, B., Esq., Tunbridge Wells . . . . .	155	18	0
1878—CORKER, C. J., Esq., Ramsgate . . . . .	449	10	0
1872—COSENS, WILLIAM, Esq., Langdon, Dawlish (Free of Duty) . . . . .	200	0	0
1870—COSTELLO, DUDLEY, Esq., Acacia Road, St. John's Wood . . . . .	399	17	3
1876—CRANHAM, CHARLES, Esq., Audlem, Chester . . . . .	450	0	0
1879—CROSSE, ROBERT, Esq., Southsea . . . . .	10	10	0
1872—CROYDEN, Mrs. LUCY, Portswood, Southampton . . . . .	69	10	8
1863—CURRIE, WILLIAM, Esq., Cornhill . . . . .	180	0	0
1862—CUTTO, Mrs. ANN, Old Kent Road (Free of Duty) . . . . .	1,000	0	0
1866—DALTON, RICHARD, Esq., Wigton (Ditto) . . . . .	100	0	0
1881—DANCE, Miss ANN, Kelso, N.B. . . . .	270	0	0
1873—DANFORD, WILLIAM, Esq., Highweek, Devon (Free of Duty) . . . . .	100	0	0
1868—DANGAR, WILLIAM, Esq., Cheltenham (Ditto) . . . . .	200	0	0
1872—DAVIDSON, Mrs. ISABELLA, Conway (Ditto) . . . . .	100	0	0
1857—DAVIES, Miss JANE, Clapham . . . . .	90	0	0
1872-9—DEAN, W. H., Esq., Stratford . . . . .	355	10	9
1867—DEANE, Mrs. MARIA, Cheltenham (Free of Duty) . . . . .	100	0	0
1880—DEIGHTON, Miss SARAH, Peckham . . . . .	180	0	0
1874—DEWAR, EBENEZER, Esq., Leith, N.B. . . . .	89	8	0
1876—DEWAR, Mrs., Vogrie, N.B. (Free of Duty) . . . . .	500	0	0
1875—DICKMAN, Captain W. H., R.N., Holloway . . . . .	368	16	1
1881—DOBSON, Mrs. A. M., Pall Mall . . . . .	19	19	0
1875—DOLLING, Miss, Shrewsbury . . . . .	90	0	0
1869—DONCASTER, Mrs. ELIZA, Winthorpe, Nottingham (Free of Duty) . . . . .	100	0	0
1870—DORSET, Miss SARAH, Reading (Ditto) . . . . .	100	0	0
1873—DOUGLAS, Miss E. HOUSTON, Eaton Place (Ditto) . . . . .	250	0	0
1878—DOUGLAS, Mr. JOHN, Skirbeck, near Boston . . . . .	1,343	6	3
1872—DRUMMOND, Mrs. S. J. DUNDAS, Kensington (Free of Duty) . . . . .	2,500	0	0
1832—DUPPA, Mrs., Homerton, Middlesex . . . . .	1,000	0	0
1873—EDISON, Mrs. H. M. ADEL, Leeds (Free of Duty) . . . . .	200	0	0
1879—EDMONDS, Admiral CHARLES, Worthing . . . . .	19	19	0
1873—ELWOOD, Mrs. A. K., Clayton Priory, Hurstpierpoint . . . . .	90	0	0
1877—EVERARD, Miss GRACE, Laverstock, Wilts (Free of Duty) . . . . .	1,000	0	0
1870—EVANS, ALFRED SMITH, Esq., Edgbaston (Ditto) . . . . .	500	0	0
1880—EVANS, Mrs. LOUISA, Belgrave Square . . . . .	19	19	0
1877-8—FAIRLIE, Lady CUNNINGHAM . . . . .	893	6	2
1879—FARMER, JOHN, Esq., Darlington . . . . .	270	0	0
1864—FARNELL, JOHN, Esq., Isleworth (Free of Duty) . . . . .	1,000	0	0
1877—FARTHING, MICHAEL, Esq., Hartlepool (Ditto) . . . . .	120	0	0
1880—FERGUSON, JOSEPH, Esq., J.P., Carlisle . . . . .	5	0	0
1876—FERGUSON, the Misses, Edinburgh . . . . .	4,500	0	0
1873—FERNLEY, JOHN, Esq., Southport (Free of Duty) . . . . .	500	0	0
1874—FINDLATER, ALEXANDER, Esq., Kingstown (Ditto) . . . . .	200	0	0
1876—FINNIE, JOHN, Esq., Bowden Lodge, near Altrincham . . . . .	666	13	4
1877—FIRBANK, EDWARD, Esq., Uplyme, Devon (Free of Duty) . . . . .	1,000	0	0
1880—FIRBANK, Mrs. ANNE, Charlton (3 per Cent. Consols) . . . . .	908	5	0
1879—FISHER, EDWARD, Esq., Ashby-de-la-Zouch (Free of Duty) . . . . .	100	0	0
1872—FITCH, Mrs. FRANCES, Bath . . . . .	500	0	0
1856—FITZGERALD, Captain HAMILTON, R.N., V.P. . . . .	9,551	14	2
1864—FITZROY, The Hon. Mrs., Upper Grosvenor Street (Free of Duty) . . . . .	400	0	0
1879—FLETCHER, G. H., Esq., Carshalton . . . . .	450	0	0
1879—FOLEY, Miss MARY, Bramley Road, Notting Hill . . . . .	233	1	6
1880—FORBES, WILLIAM, Esq., Glasgow (Free of Duty) . . . . .	20	0	0
1858—FOSTER, GEO. HOLGATE, Esq., V.P., Moorgate Street (Ditto) . . . . .	1,000	0	0
1875—FOULSTON, Mrs. ELIZA, South Kensington . . . . .	83	0	6
1869—FOX, ROBERT, Esq., Falconhurst, Kent (Free of Duty) . . . . .	100	0	0
1878—FOXTON, Mrs. C. D., Pendlebury, near Manchester (Ditto) . . . . .	1,000	0	0
1867—FRITH, Mrs. ANNE, Deptford . . . . .	90	0	0
1868—FYDELL, R. S., Esq., Morcot Hall (Free of Duty) . . . . .	100	0	0
1873—GARDEN, R. J., Esq., South Kensington . . . . .	1,193	6	0
1862—GEDGE, Miss ALICE, Great Yarmouth . . . . .	304	16	0
1876—GIBB, B., Esq., Deptford . . . . .	90	0	0

[Continued.]

LIST OF PAID LEGACIES—*continued.*

	<i>Amount received.</i>		
	£.	s.	d.
1878—GIBBON, L. P., Esq., Pembroke . . . . .	450	0	0
1875—GIBBONS, MRS. SILLS, Bath (Free of Duty) . . . . .	500	0	0
1874—GIBSON, Capt. ROBERT, R.N., C.B., Lancaster (Ditto) . . . . .	100	0	0
1877—GIBSON, Dr. ALEXANDER, Auchenreoch, N.B. . . . .	802	16	0
1866—GILBERT, JOHN GRAHAM, Esq., Yorkhill (Free of Duty) . . . . .	100	0	0
1877—GILBERT, MRS. JANE GRAHAM, Yorkhill, N.B. (Ditto) . . . . .	250	0	0
1875—GOADSBY, MRS. M. A., Fallowfield . . . . .	450	0	0
1875—GODIN, Miss SARAH, Maida Vale (Free of Duty) . . . . .	100	0	0
1879—GOOCH, JAMES, Esq., Ipswich (Ditto) . . . . .	100	0	0
1866—GOODMAN, Miss ELLEN, Eversholt . . . . .	540	0	0
1877—GORDON, Capt. J. A., R.N., Ittington, N.B. . . . .	271	19	2
1868—GORFENKLE, JACOB, Esq., Liverpool (Free of Duty) . . . . .	500	0	0
1872—GOVER, Miss ELEANOR, Pimlico (Ditto) . . . . .	94	9	0
1872—GRAHAM, JOHN, Esq., Ide Hill, Sevenoaks (Ditto) . . . . .	1,000	0	0
1877—9—GRAHAM, JAMES, Esq., Cornwall Terrace, Regent's Park . . . . .	2,500	0	0
1877—GRAHAM, Miss ANN MAXWELL, Williamswood (Free of Duty) . . . . .	500	0	0
1851—GRANTHAM, MRS. JANE, Altrincham, Cheshire . . . . .	100	0	0
1871—GREENE, JOHN, Esq., Gateshead (Free of Duty) . . . . .	200	0	0
1877—GRIFFITH, H. DAVIES, Esq., Caer Hân, Carnarvon (Ditto) . . . . .	2,000	0	0
1875—GRIFFITHS, Miss REBECCA, Dudley . . . . .	180	0	0
1874—GRINDLAY, THOMAS, Esq., Edinburgh (Free of Duty) . . . . .	1,000	0	0
1866—GROVE, WILLIAM CHAFYN, Esq., Mere, Wiltshire . . . . .	90	0	0
1875—HABERFIELD, Lady, Clifton (Free of Duty) . . . . .	640	0	0
1868—HALL, Miss LOUISA, Maida Vale (Ditto) . . . . .	945	0	0
1880—HALL, THOMAS, Esq., Welbeck St., Cavendish Square . . . . .	1,600	0	0
1867—HALL, WILLIAM JOHN, Esq., Trinity Square . . . . .	580	11	10
1880—HAMILTON, ADAM, Esq., Glasgow . . . . .	19	19	0
1873—HAMILTON, Miss MARY ANN, Harrogate (Free of Duty) . . . . .	200	0	0
1864—HARCOURT, Admiral O. V., Swinton Park (Ditto) . . . . .	1,000	0	0
1880—HARCOURT, Mrs. A. H. DANBY VERNON, Swinton (Ditto) . . . . .	500	0	0
1873—4—HARRIS, Capt. E. W., Roehampton . . . . .	8,342	8	0
1880—HARRIS, HENRY, Esq., Streatham . . . . .	900	0	0
1881—HARRIS, Mrs. HENRY, Streatham (Free of Duty) . . . . .	1,000	0	0
1876—HARRISON, Miss H. M. Bath (Ditto) . . . . .	500	0	0
1868—HARRISON, Miss SARAH, Edge Hill (Ditto) . . . . .	100	0	0
1834—HAYMAN, Mrs., Topsham, Devon . . . . .	88	0	0
1825—HECKER, JOHN HENRY, Esq., Finsbury Square . . . . .	1,000	0	0
1860—HEMINGTON, THOMAS FISHER, Esq., Uplyme, Devon (Free of Duty) . . . . .	100	0	0
1877—HENLEY, Mrs. ANN, Plymouth . . . . .	180	0	0
1879—HINDLEY, Miss ELIZABETH, Heaton Norris . . . . .	90	0	0
1878—HOLGATE, JOHN, Esq., Burton-in-Lonsdale (Free of Duty) . . . . .	200	0	0
Ditto, for the widows and families of men lost or injured while engaged in Life-boats (Free of Duty) . . . . .			
1865—HOLLINS, Wm., Esq., Over Wallop, Southampton (Ditto) . . . . .	200	0	0
1880—HOLME-SUMNER, Mrs. H. K., Swaffham (Ditto) . . . . .	511	11	6
1872—HOLME, THOMAS, Esq., City Road . . . . .	100	0	0
1872—HOLME, THOMAS, Esq., City Road . . . . .	4,545	0	0
1881—HOLT, Col. W. J., Gorphwysfa, Bangor . . . . .	450	0	0
1867—HOOPER, Mrs. MARIANA, Andover (Free of Duty) . . . . .	100	0	0
1880—HOPE, Mrs. ELLEN, Upper Seymour Street . . . . .	270	0	0
1069—HORTON, Miss MARY ANN, Highbury (Free of Duty) . . . . .	100	0	0
1865—HORTON, SAMUEL, Esq., Prior's Lee (Ditto) . . . . .	100	16	10
1872—HOWARD, THOMAS, Esq., Rotherhithe (Ditto) . . . . .	100	0	0
1874—HOWELL, JOHN, Esq., Cadogan Place (Ditto) . . . . .	210	13	9
1879—HOYLE, DUNCAN, Esq., Orme Square, Bayswater (Ditto) . . . . .	1,000	0	0
1868—HUDSON, JOSEPH, Esq., Barrow-upon-Soar . . . . .	90	0	0
1879—HUGHES, Miss HANNAH, Budleigh-Salterton . . . . .	214	5	9
1879—HUNT, Mrs. MARIA, Hornsey . . . . .	450	0	0
1873—HYDE, Colonel J. C., Timbercombe Lodge, Somerset (Free of Duty) . . . . .	247	7	6
1873—INGLEBY, Rev. CHARLES, Cheadle, Stafford (Ditto) . . . . .	100	0	0
1880—INGO, JOHN, Esq., Gosforth, Northumberland (Ditto) . . . . .	50	0	0
1877—IRLAM, GEORGE, Esq., North Row, Park Lane (Ditto) . . . . .	1,000	0	0
1867—IRLAM, Miss MARIA, Dibbinsdale (Ditto) . . . . .	1,000	0	0
1876—IRVINE, Mrs. S., Geneva . . . . .	270	0	0
1878—JACKSON, Miss A. C., Croydon (Free of Duty) . . . . .	100	0	0
1877—JEFFERSON, EDWARD, Esq., Pontefract (Ditto) . . . . .	400	0	0
1875—JEREMY, Mrs. C. A., Axminster (Ditto) . . . . .	1,000	0	0
1863—JOLLY, Mr. JOHN, Farmer, Enstone, Oxford . . . . .	189	0	0
1868—JONES, CHARLES WILLIAM, Esq., Norwich . . . . .	180	0	0
1879—JONES, EDWARD, Esq., Port Hope, Ontario . . . . .	611	5	11
1880—JONES, Mrs. LUCY, Woburn . . . . .	10	0	0
1861—JUDKIN, J. R., Esq., Hackney (Free of Duty) . . . . .	105	0	0
1870—J. L., Esq., Horsham . . . . .	450	0	0
1864—KEATE, Miss EMMA, Kensington (Free of Duty) . . . . .	300	0	0
1869—KEMP, Miss E. S., City Road (Ditto) . . . . .	100	0	0
1878—KENDALL, Wm., Esq., Exeter (Ditto) . . . . .	1,000	0	0

[Continued.]

LIST OF PAID LEGACIES—*continued.*

	<i>Amount received.</i>		
	£	s.	d.
1877—KENDRICK, Mrs., Philpot Street (Free of Duty) . . . . .	100	0	0
1875—KERR, MALCOLM, Esq., Glasgow (Ditto) . . . . .	250	0	0
1879—KERR, Miss MARY, Dumfries . . . . .	45	18	4
1868—KINGSTON, FRANCIS HOUSE, Esq., Harpenden . . . . .	431	2	0
1874—KIPLING, Mrs. S. E., Kentish Town . . . . .	450	0	0
1874—KIRBY, Mrs. F. S., Dublin . . . . .	180	0	0
1880—KIRKPATRICK, Mrs. HARRIET SUTTON (Free of Duty) . . . . .	100	0	0
1864—KITCHING, JOHN, Esq., Stamford Hill (Ditto) . . . . .	100	0	0
1872—KNIGHT, Miss MARIA, Hathern, Leicester . . . . .	90	0	0
1875—LAMBERT, JAMES, Esq., Alloa, N.B. . . . .	502	11	6
1880—LANDSEER, CHARLES, Esq., R.A., St. John's Wood (Free of Duty) . . . . .	500	0	0
1880—LANDSEER, Miss JESSIE, Kensington Park Gardens (Ditto) . . . . .	100	0	0
1877—LEE, Miss MARY, Foleshill, Warwickshire (Ditto) . . . . .	250	0	0
1872—LEEVEES, EDWARD, Esq., Venice (Ditto) . . . . .	100	0	0
1876—LEWTHWAITE, Miss SARAH, Bowdon, Chester. . . . .	450	0	0
1877—LEWTHWAITE, Miss F. J., Colton, Lancashire (Free of Duty) . . . . .	200	0	0
1876—LIDDELL, HENRY, Esq., Kingston-upon-Hull (Ditto) . . . . .	100	0	0
1870—LLOYD, CHARLES, Esq., Kennington (Free of Duty) . . . . .	500	0	0
1876—LONG, Miss CATHERINE, Chipping Norton . . . . .	172	16	6
1876—LONSDALE, HENRY, Esq., M.D., Carlisle . . . . .	90	0	0
1854—LOWE, SAMUEL J., Esq., Shadwell . . . . .	871	15	0
1880—LUPTON, Miss MARY, Broughton, Lancaster (Free of Duty) . . . . .	103	16	0
1862—LUPTON, WILLIAM, Esq., Salford (Ditto) . . . . .	100	0	0
1872—LYON, Mrs. JANE, Knightsbridge (Ditto) . . . . .	500	0	0
1869—MACKIE, Dr., Greenock . . . . .	359	12	5
1864—MACNAB, JAMES, Esq., Guildford (Free of Duty) . . . . .	99	4	6
1879—MACNAMARA, Admiral Sir BURTON, Kingstown . . . . .	525	3	0
1864—MAGENIS, F. R., Esq., Grosvenor Place (Free of Duty) . . . . .	1,000	0	0
1881—MAHONY, Dr. MONTAGUE MARTIN, Chelsea (Stock) . . . . .	4,509	5	10
1875—MARKLAND, Miss ELLIN, Notting Hill (Free of Duty) . . . . .	200	0	0
1875—MARSHALL, ROBERT, Esq., Edinburgh . . . . .	270	0	0
1881—MARTIN, Miss CHARLOTTE, Lowestoft . . . . .	10	0	0
1879—MASON, Miss ELIZABETH, Necton . . . . .	900	0	0
1877—MAY, Dr. H. S., Exeter . . . . .	180	0	0
1869—MCALLEY, WILLIAM, Esq., Stirling, N.B. . . . .	99	1	10
1874—MCKINNELL, or HANNAY, Mrs., Kirkcudbright, N.B. . . . .	91	11	0
1872—MEREDITH, Mr. THOMAS, Edgware Road . . . . .	52	10	0
1874—METGE, PETER PONSONBY, Esq., Athlumney, Navan . . . . .	180	0	0
MEYER, Mr. CECIL, Upper Norwood . . . . .	2	2	0
1871—MEYNELL-INGRAM, Miss LOUISA E., Hoar Cross (Free of Duty) . . . . .	300	0	0
1871—MEYRICK, STANTON, Esq., Brompton . . . . .	611	7	6
1863—MILLER, JAMES, Esq., Glasgow (Free of Duty) . . . . .	100	0	0
1878—MILLOTT, Miss EMILY, Pendleton, near Manchester (Ditto) . . . . .	100	0	0
1877—MITCHELL, JAMES, Esq., Kincairney, N.B. (Ditto) . . . . .	506	5	0
1864—MONTAGU, Captain M., R.N., Bath (Ditto) . . . . .	98	13	4
1865—MORGAN, Mrs., Cheltenham (Ditto) . . . . .	204	11	10
1876—MORRIS, Mrs. C. H., Hammersmith . . . . .	463	14	4
1877—MOSTYN, T. A. B., Esq., St. James's Place (Free of Duty) . . . . .	100	0	0
1875—MYTTON, Miss C. H. A., Shelton, near Shrewsbury . . . . .	450	0	0
1868—NAYLOR, WILLIAM, Esq., of Twickenham (Free of Duty) . . . . .	500	0	0
1871—NEALE, Miss ELIZA, Hayes, towards the building of a "Pendock Neale" Life-boat . . . . .	£246	16	7
1872-5—Also donations from Miss HERRING, Newport, for same Life-boat, in memory of departed friends . . . . .	353	3	5
1876—NEWEN, GEORGE, Esq., Cambridge Terrace (Free of Duty) . . . . .	600	0	0
1881—NICHOLS, Miss CHARLOTTE, Finsbury Park (Ditto) . . . . .	100	0	0
1878—OVEY, Miss JANE, Henley-on-Thames (Ditto) . . . . .	785	6	0
1867—OXENHAM, Miss C. N., Kensington . . . . .	500	0	0
1875—PARK, WILLIAM, Esq., Torwoodhill, N.B. (Free of Duty) . . . . .	180	0	0
1875—PARK, Mrs. Do. Do. . . . .	148	18	5
1877—PARKER, Mrs. M. D., Whippingham, Isle of Wight (Ditto) . . . . .	500	0	0
1881—PARMETER, R. W., Esq., Cambridge . . . . .	300	0	0
1880—PECK, Mrs. AMELIA KEZIA, Plymouth (Free of Duty) . . . . .	19	0	0
1857—PETERSON, Miss MARIA, Bromley . . . . .	250	0	0
1876—PHELPS, Mrs. MARGARET, Chichester (Free of Duty) . . . . .	90	0	0
1876—PICKERSGILL, H. W., Esq., R.A., Blandford Square . . . . .	101	18	3
1879—POPHAM, Mrs. J. E. M., Ardchattan, N.B. . . . .	900	0	0
1880—PRICE, ALLIN FOOD, Esq., M.D., Deptford (Free of Duty) . . . . .	464	8	7
1830—PRIOR, WILLIAM, Esq., Herne Hill, Camberwell. . . . .	100	0	0
1880—PRYOR, Mrs. ELIZABETH, Redruth, Cornwall . . . . .	1,827	14	8
1880—PYCOCK, Miss JANE, Howden, York (Free of Duty) . . . . .	6	15	2
1879—RADCLIFFE, H. J., Esq., Eastbourne . . . . .	50	0	0
1875-6—RANDELL, JAMES, Esq., Mark Lane . . . . .	520	14	5
	483	15	11

[Continued.]



LIST OF PAID LEGACIES—*continued.*

	<i>Amount received.</i>		
	£	s.	d.
1874—RATTRAY, Miss MARY GRAY, Tavistock Square . . . . .	200	0	0
1867—RAWSON, Miss MARIA, Sheffield . . . . .	90	0	0
1876—RAYMENT, Mrs., Dartford (Free of Duty) . . . . .	100	0	0
1874-5—REEVE, JOHN, Esq., Reading (Ditto) . . . . .	948	15	0
1848—RENNELE, THOMAS THACKERAY, Esq., Enfield . . . . .	360	0	0
1880—RHODES, W. B. Esq., Hounslow . . . . .	27,779	2	9
1881—RICHARDSON, Mr. BENJAMIN, Gosberton, Lincoln . . . . .	2	0	0
1869—RICHARDSON, Mrs. HARRIETT, Greenwich . . . . .	4,412	0	6
1874—RICHARDSON, Miss MARY, Edinburgh (Free of Duty) . . . . .	500	0	0
1877—RIDEOUT, W. J., Esq., Charles Street, Berkeley Square (Ditto) . . . . .	1,000	0	0
1876—RIGDEN, the Misses, Chestow (Ditto) . . . . .	100	0	0
1877—ROBERTSON, CHARLES, Esq., Long Acre . . . . .	450	0	0
1870—ROBERTS, JOHN, Esq., Mornington Road (Free of Duty) . . . . .	200	0	0
1873—ROBERTSON, Mrs. M. J., Kelso, N.B. . . . .	450	0	0
1881—ROBINSON, Mr. ANTHONY, Whitcombe Street, Haymarket . . . . .	0	10	0
1863—ROBINSON, Mr. THOS., Cheetham, Manchester . . . . .	189	0	0
1879—ROE, Mrs. Mary, Nutley, Co. Dublin (Free of Duty) . . . . .	400	0	0
1870—ROLLESTON, Mrs. HARRIET, Swindon (Ditto) . . . . .	450	0	0
1874—ROYOU, WILLIAM, Esq., Tottenham . . . . .	501	11	11
1874—RUSSELL, Lady FRANKLAND, Thirkleby, Yorkshire . . . . .	106	19	8
1880—SAUNDERS, Miss ELLEN . . . . .	23	18	1
1869—SCOTT, SAMUEL, Esq., Cavendish Square (Free of Duty) . . . . .	1,000	0	0
1858—SELL, Mr. CHARLES, Hoxton . . . . .	66	2	11
1867—SHARPE, Miss JANE, Whitburn . . . . .	89	6	8
1866—SHAW, JAMES DAVIDSON, Esq., Newcastle-on-Tyne . . . . .	449	1	8
1879—SHAW, JAMES, Esq., Brighton (Free of Duty) . . . . .	100	0	0
1876—SHEPPARD, FREDERICK, Esq., Folkington, Sussex (Ditto) . . . . .	2,000	0	0
1868—SILVER, THOMAS TEMPLE, Esq., Woodbridge (Ditto) . . . . .	650	0	0
1868—SINCLAIR, DAVID, Esq., Thurso (Ditto) . . . . .	100	0	0
1869—SINCLAIR, WILLIAM, Esq., Sowerby, York (Ditto) . . . . .	138	18	3
1874—SKURRAY, W. H., Esq., Leamington . . . . .	1,155	12	4
1868—SLADE, FELIX, Esq., Lambeth (Free of Duty) . . . . .	300	0	0
1866—SMALL, Mrs. SARAH, Brighton . . . . .	76	7	6
1865—SMITH, Miss ANN FRANCES, Greenwich . . . . .	50	15	0
1875—SMITH, JOHN, Esq., Hull (Free of Duty) . . . . .	200	0	0
1867—SMITH, Mrs. MARY ANN, Greenwich (Ditto) . . . . .	1,000	0	0
1875—SMITHEMAN, JOHN, Esq., Hertford . . . . .	90	0	0
1879—SNAGG, Sir WILLIAM, Georgetown, Demerara . . . . .	10	0	0
1880—SOMERVILLE, Miss MARTHA CHARTERS, Genoa (Free of Duty) . . . . .	2,500	0	0
1864—SPENCER, RICHARD, Esq., Gower Street . . . . .	180	0	0
1880—SPURRELL, Miss CHARLOTTE, Bampton, Norfolk . . . . .	90	0	0
1878—STAINTON, J. J., Esq., Meadowcroft, Lewisham . . . . .	107	8	10
1874—STANNAH SAMYNTAS, Esq., Gower Street . . . . .	450	0	0
1873—STANTON, WILLIAM, Esq., Bramly Wharf, Surrey . . . . .	473	17	5
1875—STEAD, Mrs., Helensburgh (Free of Duty) . . . . .	100	0	0
1876—STONE, RICHARD, Esq., Ulceby, Lincolnshire . . . . .	101	11	1
1866—STORY, Mrs. MARY ANN, Kensington (Free of Duty) . . . . .	500	0	0
1870—STUART, CHARLES, Esq., Norfolk Street (Ditto) . . . . .	200	0	0
1865—STUBBS, THOMAS, Esq., Hulme, Manchester (Ditto) . . . . .	500	0	0
1869—STURM, JAMES, Esq., High Holborn (Ditto) . . . . .	500	0	0
1865—SYKES, Capt. JOHN, R.N., Bolsover Street (Ditto) . . . . .	100	0	0
1878—SYKES, Mrs. ANN ELIZABETH, Butharlyph, How Grasmere (Ditto) . . . . .	600	0	0
1871—TANCRED, J. J., Esq., Pearville, Co. Dublin (Ditto) . . . . .	1,350	0	0
1866—TAYLOR, THOMAS TRAVERS, Esq., Southport (Ditto) . . . . .	950	0	0
1879—THOMAS, Miss LOUISA, Bowden, Chester . . . . .	900	0	0
1874—THOMPSON, JOHN, Esq., Nottingham (Free of Duty) . . . . .	500	0	0
1859—THOMPSON, Mrs. ANN, Greenwich . . . . .	82	8	1
1865—THORNTON, RICHARD, Esq., Old Swan Wharf (Free of Duty) . . . . .	2,000	0	0
1875—TOMPKINSON, THOS., Esq., Bath . . . . .	90	0	0
1880—TOMLINSON, JOHN, Esq., Walkerth, Lincoln . . . . .	15	0	0
1866—TRAVIS, SAMUEL, Esq., Cheltenham (Free of Duty) . . . . .	100	0	0
1873—TREDWELL, Wm., Esq., Handsworth, Staffordshire (Ditto) . . . . .	105	0	0
1878—TROWELL, Wm., Esq., Fletton, Hunts (Ditto) . . . . .	100	0	0
1869—TUCKETT, Miss LUCRETIA, Osnaburgh Street (Ditto) . . . . .	100	0	0
1880—VANDELEUR, RICHD. J. O., Esq., Dublin . . . . .	448	19	0
1863—VENABLES, THOMAS ARUNDEL, Esq., Worcester . . . . .	450	0	0
1872—WALDRON, Miss MARIA, Trowbridge (Free of Duty) . . . . .	100	0	0
1867—WALKER, CHARLES, Esq., Southport (Ditto) . . . . .	100	0	0
1870—WALKER, Miss MARY, Coates, N.B. (Ditto) . . . . .	500	0	0
1869—WALKER, Mrs. MARY ANN, Onslow Square (Ditto) . . . . .	500	0	0
1879—WALLACE, Wm., Esq., Curtain Road, Shoreditch . . . . .	550	19	4
1872—WALMESLEY, Mrs. C. E., Connaught Square (Free of Duty) . . . . .	300	0	0
1869—WARNER, Mrs. ANN, Lyncombe, Somerset . . . . .	224	10	0
1869—WARNER, Miss ELIZABETH SOPHIA (Free of Duty) . . . . .	350	0	0

[Continued.]

LIST OF PAID LEGACIES—*continued.*

	Amount received.		
	£	s.	d.
1876—WATKINS, Capt. W., R.N., Croydon (Free of Duty) . . . . .	100	0	0
1871—WATSON, Mrs. ELIZA, Loughton, Essex (Ditto) . . . . .	100	0	0
1861—WATSON, Mrs. WILHELMINA, Berwick-on-Tweed . . . . .	450	0	0
1880—WEBB, Miss ANN, Brighton (Free of Duty) . . . . .	50	0	0
1864—WEBSDALE, W., Esq., Ipswich (Ditto) . . . . .	79	16	0
1880—WEDGWOOD, Miss S. E., Down, Kent (Ditto) . . . . .	100	0	0
1862—WEST, Dr. CHARLES TURNER, Hull . . . . .	90	0	0
1879—WEST, RICHARD THORNTON, Esq., Streatham Hall, Exeter (Free of Duty) . . . . .	500	0	0
1864—WHEELHOUSE, G., Esq., Deptford (Ditto) . . . . .	260	0	0
1880—WHITE, Mrs. ANN, Brockley . . . . .	90	5	0
1877—WHITTINGHAM, Mrs. J. P., Manchester Street, Manchester Square . . . . .	303	4	4
1875—WILLIAMS, Mrs. ROBINA, Edinburgh (Free of Duty) . . . . .	1,000	0	0
1877—WILLIAMS, C. T. LLOYD, Esq., Cheltenham . . . . .	540	0	0
1870—WOOD, Miss MARY ANN, Bath (Free of Duty) . . . . .	100	0	0
1877—WOOD, GEORGE, Esq., Chelsea (Ditto) . . . . .	1,000	0	0
1875—WOODBURN, Miss MARY FRANCES, Kensington Park Gardens . . . . .	270	0	0
1875—WOODHOUSE, Mrs. S. D., Upper Grosvenor Street (Free of Duty) . . . . .	127	13	3
1880—WOODWARD, Miss MARY, Sproughton, Suffolk (Ditto) . . . . .	1,500	0	0
1879—WOODWARD, Miss SARAH, Oldham Place . . . . .	1,800	0	0
1879—WRIGHT, Miss M. A., Cottingham, York . . . . .	268	19	0
1875—WRIGHTSON, Mrs. C. R., York . . . . .	180	0	0
1875—YATES, Mrs. HANNAH, Sheffield . . . . .	900	0	0
1879—YEARSLEY, E. H., Esq., Roma, Queensland . . . . .	46	7	6

## FORM OF BEQUEST OF MONEY, STOCK, OR OTHER PERSONAL ESTATE.

*I give and bequeath to the ROYAL NATIONAL LIFE-BOAT INSTITUTION for the Preservation of Life from Shipwreck, founded in 1824, London, the sum of £* \_\_\_\_\_ *for the use of the said Institution; and I do hereby direct that the same be paid exclusively out of such part of my Personal Estate as may lawfully be appropriated to such purpose, and that the receipt of the Treasurer for the time being of the said Institution shall be a sufficient discharge to my Executors for the same.*

ROYAL NATIONAL LIFE-BOAT INSTITUTION,

14 John Street, Adelphi, London,

2nd May, 1881.

## LIST OF DONATIONS AND ANNUAL SUBSCRIPTIONS.

\*\* Donations of £5 and under are omitted after having been published *once* in the Report.

HER MOST GRACIOUS MAJESTY THE QUEEN (Annual, £50) (1853) £100 0 0  
 HIS ROYAL HIGHNESS THE PRINCE OF WALES, K.G. . . . . 135 0 0

	Ann. Subs.	Donations.		Ann. Subs.	Donations.
	£. s. d.	£. s. d.		£. s. d.	£. s. d.
A. B. . . . .	0 5 0		Adams, Mr. J., Brecknock Rd. . . . .	0 10 6	
A. B., Penryn (1872-80) . . . . .		9 0 0	Adams, R., Esq., St. Ives . . . . .	1 1 0	
A. C., Croydon (1859-80) . . . . .	120 0 0		Adamson, A., Esq. . . . .	1 1 0	
A. C., In Memoriam (1871) . . . . .	20 0 0		Adamson & Co., Messrs. D., Blyth (1880) . . . . .	1 0 0	
A. C. S. (1875) . . . . .	10 0 0		Addington, Mrs. Henry (1873) . . . . .	10 0 0	
A. C. A. M., In the beloved name and memory of (1881) . . . . .		1 1 0	Addison, Mrs., New Brighton) 2 2 0		
A. D. M., Mrs., born Hawkins, in memory of two Officers Indian Army (Madras), Hawkins and Spinks (many years deceased) (1876) . . . . .	1,000 0 0		Ágar, W. T., Esq. (1870-80) . . . . .	30 0 0	
A. L., Guildford (1863-80) . . . . .	85 0 0		Aldam, William, Esq. . . . .	1 0 0	
A. L., A. W., M. W., and A. A., Wimbledon (1877-81) . . . . .	56 4 3		Alexander, B. F., Esq. (1880) . . . . .	1 0 0	
A. M. B. (1877) . . . . .	10 0 0		Alexander, Jas., Jun., Esq. (1880) . . . . .	10 10 0	
A. P. R. . . . .	1 0 0		Alexander, T. H., Esq. (1873-5) . . . . .	21 0 0	
A. S. W. (1875-7) . . . . .	31 10 0		Alexander, The Misses . . . . .	1 1 0	
A Friend (1872) . . . . .	15 0 0		Allen Bros. and Co., Messrs. . . . .	1 1 0	
A Friend at Leominster (1869-78) . . . . .	37 0 0		Allen, C. F. R. Esq. (1869-76) . . . . .	10 0 0	
A Friend at Llangollen . . . . .	1 0 0		Allen, Hanbury, & Co. Messrs. . . . .	1 1 0	
A Friend at the Annual Meeting (1872) . . . . .	10 0 0		Allen, J., Esq., Cornhill . . . . .	1 1 0	
A Friend, in aid of the cost of the new Boat House for Worthing (1874) . . . . .	100 0 0		Allen, Murray, & Co., Messrs. . . . .	1 1 0	
A Friend, Worthing (1881) . . . . .	2 0 0		Alloa Branch (1881) . . . . .	39 18 4	
A Friend at Chatham (1880) . . . . .	5 0 0		Alrutz, R., Esq. . . . .	1 1 0	
A Friend (1881) . . . . .	1 0 0		Alston, Chas. H., Esq. . . . .	2 2 0	
A Friend at Holmfirth, Halifax Corporation Bonds (1880) . . . . .	1000 0 0		Alston, Hamilton, & Co. Messrs. . . . .	1 1 0	
A Friend, per Messrs. Nisbet & Co. (1880) . . . . .	0 10 0		Amos, Mrs. M., St. Ibbs . . . . .	1 1 0	
A Lady, per J. B. Parker (1863-73) . . . . .	135 0 0		Amphlett, Rev. J. . . . .	1 1 0	
A Lady, per W. H. Moore, Esq. (1876) . . . . .	10 0 0		Anderson, C. A., Esq., Waverley Abbey . . . . .	2 2 0	
A Lady (1880) . . . . .	20 0 0		Anderson, Mrs. J., Dalhousie . . . . .	2 2 0	
A Mother whose Son was Lost at Sea (1869-74) . . . . .	12 0 0		Anderson, Robt., Esq., Arbroath . . . . .	1 1 0	
A Resident in Heidelberg (1881) . . . . .	2 10 0		<i>Andrina V.</i> , Austrian barque, Underwriters of the cargo of the (1879) . . . . .	26 5 0	
A Sailor's Orphan (1881) . . . . .	1 0 0		Angus, General, Edinburgh (1881) . . . . .	5 0 0	
A Sailor's Sister (1880-81) . . . . .	2 10 0		An old Sailor, Native of Faversham, now of Canada (1875) . . . . .	40 0 0	
A Shipowner, Greenock . . . . .	5 0 0		Anonymous (1872) . . . . .	10 0 0	
A Thank-offering for a Son's preservation at Sea (1870) . . . . .	10 0 0		Anonymous (1873-4) . . . . .	10 0 0	
Ditto, for safe return of Sons from long Voyages (1874) . . . . .	10 0 0		Anonymous (1881) . . . . .	1 10 0	
A Thank-offering from F. R. A. (1879) . . . . .	100 0 0		Anonymous, per Messrs. Barclay, Bevan, & Co. (1874-6) . . . . .	350 0 0	
A Thank-offering, from T. H. L. (1867-76) . . . . .	54 0 0		Anonymous, Retford (1879-80) . . . . .	0 10 0	
A Thank-offering ("Let not the deep swallow me up") (1871) . . . . .	25 0 0		Anonymous, "W." (1878) . . . . .	100 0 0	
A Thank-offering from C. C. (1880) . . . . .	1 0 0		Anson, Miss, Chester (1875-81) . . . . .	35 0 0	
A Well Wisher, "A Valentine for the Institution" (1881) . . . . .	1 5 0		Antrobus, Hugh Lindsay, Esq., Treasurer (1878) . . . . .	10 10 0	
Aberdeen Branch (1880) . . . . .	60 0 0		Antrobus, Miss C. H. (1865-79) . . . . .	17 4 0	
Abney, Rev. Canon . . . . .	1 1 0		Ditto . . . . .	2 0 0	
Ackers, Mrs., Hyde Park . . . . .	5 0 0		Appach, T. H., Esq. (1880) . . . . .	31 10 0	
Acland, Sir T. Dyke, Bart., M.P. (1875) . . . . .	10 0 0		Archer, J., Esq. . . . .	1 1 0	
Acocks Green, Yardley and Olton Branch (1881) . . . . .	34 17 4		Ardsowan Branch (1881) . . . . .	15 0 0	
Acton, Miss, Teston (1879-81) . . . . .	4 0 0		Arkwright, J. C., Esq. . . . .	1 1 0	
Adam, E., Esq., Kilmarnock (1881) . . . . .	1 1 0		Armitage, Miss H., Bath . . . . .	1 1 0	
Adam, Messrs. John and James and Co. . . . .	1 1 0		Armourers & Braziers, Worshipful Company of (1881) . . . . .	10 10 0	
Adams, A., Esq., Skelwith . . . . .	0 10 0		Armstrong, Mrs., Huntingdon . . . . .	0 10 6	
Adams, Edgar T., Esq., Halstead . . . . .	1 1 0		Armstrong, Henry, Esq. . . . .	1 1 0	
			Armstrong, Sir W. G., F.R.S. . . . .	1 1 0	
			Arnold, Mrs. Francis . . . . .	1 1 0	
			Artill, J. D., Esq. . . . .	0 5 0	
			Ash, Hy., Esq., Weston . . . . .	0 10 0	
			Ash, W., Esq., Weston . . . . .	0 10 0	
			Ashby, Capt., Naseby . . . . .	1 1 0	
			Ashby, James, Esq. . . . .	0 10 6	
			Ashwood, John, Esq. . . . .	1 1 0	
			Astell, Mrs. H. D. (1866-73) . . . . .	13 10 0	
			Astley, Miss, Princes Gardens . . . . .	2 0 0	

	Ann. Subs.		Donations.	
	£.	s. d.	£.	s. d.
Atkin, John T., Esq., Alexandria (1880)			1	0 0
Atkinson and Co., Messrs.	2	2 0		
Atkinson, G. C. W., Esq.	2	2 0		
Atkinson, Lieut.-Col. Ralph (1873)			10	0 0
Atkinson, W., Esq., Beckenham	1	1 0		
Attenborough, R., Esq., Sawtry	1	0 0		
Attwell, T. M., Esq.	1	1 0		
Auerbach, Emil, Esq.	1	1 0		
Auldjo, Henry, Esq., Cowes (1851-81)	47	15 0		
Austin, F., Esq., Aubert Park (1880)	10	0 0		
Austin, G., Esq., London St.	1	1 0		
Austin, Mrs., Bethnal Green	1	1 0		
Austin, Mrs., Clifton	1	0 0		
A Well Wisher and Regular Subscriber (1880)			30	0 0
B. C. M., A Thank-offering (1880)	5	0 0		
B. H. C. (1872-80)	90	0 0		
B. Y.	1	1 0		
Baber, Harry H., Esq. (1870)	10	10 0		
"Baby," per Mrs. Dalton (1881)	2	2 0		
Backhouse, James E., Esq.	5	0 0		
Bacup Co-operative Stores (1868-80)	125	0 0		
Badcock, H., Esq.	1	0 0		
Badcock, H. J., Esq.	0	10 0		
Bagehot, Hicks, and Co.	1	1 0		
Bagehot, T. W., Esq. (1878)	50	0 0		
Bailey, E., Esq., Berners St.	1	1 0		
Bailey, E. H., Esq., ditto	1	1 0		
Baillie, Mrs. E. F., Leicester	1	1 0		
Baily, Miss A. L., Sudbury	1	1 0		
Baily, Miss E., ditto	1	1 0		
Bainbridge, E. M., Esq., Dis-sington	1	1 0		
Baines, Charles J., Esq.	1	1 0		
Baker, John, Esq., Clapham	1	0 0		
Baker, Mrs., ditto	0	10 0		
Baker, Gen. Sir W. E.	2	2 0		
Baker, Rev. Sir T. H. B., Bart.	1	1 0		
Baker, Sir George, Bart. (1865-74)	25	0 0		
Balderson, Mrs., Hanover Sq.	1	1 0		
Baldwin, Alfred, Esq. (1877)	10	10 0		
Balézeaux, Captain Ed., In-spector, French Lifeboat Society	1	1 0		
Balfour, John B. Esq. (1868-75)	10	14 0		
Balkwill, Robt. Coad, Esq.	1	1 0		
Ballard, George, Esq., the late, Re-siduary Legatees of, per Mrs. Ballard (1875)	50	0 0		
Banff and Macduff Branch (1881)	20	0 0		
Banfield, R., Esq.	1	1 0		
Bannatyne, C., Esq. (1880)	10	10 0		
Bannockburn Branch (1881)	11	9 9		
Barber, Mrs.	0	5 0		
Barber and Co., Messrs. J.	1	1 0		
Barclay and Sons, Messrs.	2	2 0		
Baring Bros. & Co., Messrs.	5	0 0		
Barker, F. C., Esq., Leigh (1871-80)	9	0 0		
Barker & Co., Messrs., Alex-andria (1880)	4	0 0		
Barkworth & Spaldin, Messrs.	1	1 0		
Barkworth, J. B., Esq., Hull (1873)	50	0 0		
Barkworth, Miss M., Tun-bridge Wells (1880)	50	0 0		
Barlow, Miss, Kersal	2	2 0		
Barnard, Rev. Thomas (1879-80)	20	0 0		
Barnard, Rev. Wm. (1878-9)	10	0 0		
Barnardiston, N. C., Esq.	1	1 0		
Barndillon, E. D., Esq.	0	10 0		
Barnes, Mrs. (1881)	0	10 0		
Barnes, O., Esq.	0	5 0		
Barnett Bros., Messrs.	2	2 0		

	Ann. Subs.		Donations.	
	£.	s. d.	£.	s. d.
Barnett, John, Esq. (1867-80)			60	0 0
Barnett, Mrs., Meopham Court (1874-7)			20	0 0
Barningham, Thos., Esq. (1873-7)			20	0 0
Barras, Mrs., Farnacres	2	2 0		
Barrett, H., Esq.	1	1 0		
Barrington, R., Esq.	10	0 0		
Barron, F., Esq.	2	2 0		
Barron, W. T., Esq.	1	1 0		
Barrow, A. M., Esq.	1	1 0		
Barry, F. T., Esq., for the barques <i>Mertola &amp; Umgeni</i>	2	2 0		
Barton, Bertram F., Esq. (1873-5)			10	10 0
Barton, Daniel, Esq. (1868-73)			20	10 0
Barton, Mrs. Hope (1881)			15	0 0
Bartram, William, Esq.	1	1 0		
Bastard, T. Horlock, Esq.	1	0 0		
Bastow, Mrs. M. (1881)			1	0 0
Bates, Brian, Esq., Buxton	1	1 0		
Bates, Colonel Robert	1	1 0		
Batey, Chas., Esq. (1881)			1	1 0
Bath Branch (1880)			18	17 2
Batten and Edwards, Messrs.	1	1 0		
Batten and Ginner, Messrs.	1	1 0		
Batthyany, Count Edmund	1	0 0		
Bax, E., Esq., Cockspur St.	1	1 0		
Bax, H. A., Esq.	1	5 0		
Baxter, John George, Esq.	1	1 0		
Bayley and Ridley, Messrs.	1	1 0		
Baylis, T. C., Esq.	2	2 0		
Bayly, Miss, Plymouth (1875)			10	0 0
Bazett, Lieut.-Col. C. G. (1867-79)			12	0 0
Beach, Messrs. & Co.	1	1 0		
Beachcroft, Miss, Talbot Sq.	1	1 0		
Beart, Mrs., Godmanchester	1	1 0		
Beaumont, G., Jun., Esq.	1	1 0		
Beaumont, Mrs., Durham Terrace			0	10 6
Beckett, Rev. W. P., B.A.	0	10 0		
Beckett, James, Esq., Senr., Rath-mines (1876-8)			20	0 0
Beddoes, Mrs. C. C.	1	1 0		
Beddoes, Miss A. F. E.	2	0 0		
Bedford, Henry, Esq.	1	1 0		
Beech, Chas., Esq., Coventry	1	0 0		
Beech, W. T., Esq., Holloway	2	2 0		
Begbie, T. S., Esq.	0	10 6		
Begley, Mrs., Hammersmith (1862-79)			21	0 0
Belcher, Lady (1864-73)			12	6 0
Belcher, Lady	2	2 0		
Belcher, Miss H.	2	2 0		
Belfast & Groomsport Branch (1881)			51	14 8
Bell, Alex., Esq., Tooting	1	1 0		
Bell, Messrs. Alexander, & Co.	1	1 0		
Bell, Mrs. L.	1	0 0		
Bell, Mrs. Mary, Maldon	1	1 0		
Bellamy, Miss	2	2 0		
Belli, W. H., Esq., The Court-lands (1861-74)			31	2 0
Belper Branch (1880)			13	14 6
Belsham, J., Esq., Heybridge	0	10 0		
Benecke, Otto A., Esq. (1873)			10	10 0
Benetfink, S. A. & Co., Messrs.	0	10 6		
Benham, John, Esq.	1	1 0		
"Benjamin," per C. Few, Esq. (1869)	100	0 0		
Bennetts, Miss Olympia (1864-79)	50	0 0		
Bentinck, Lady (1874-81)			30	0 0
Ditto	10	0 0		
Bentley, Mrs. S. C., Croydon (1873-81)			35	0 0
Bentwitch, Herbert, Esq.	1	1 0		
Bentwitch, Mrs. Herbert	0	10 6		
Beresford, Mrs. L.	1	1 0		
Berman's Charity, Trustees (1872-81)	94	10 0		
Berry, George, Esq.	0	10 6		
Bettell, Wm., Esq., Brixton (1874-81)	23	2 0		
Bevan, Geo. J., Esq.	1	1 0		
Beveridge, Capt.	1	1 0		

	Ann. Subs.		Donations.			Ann. Subs.		Donations.			
	£.	s. d.	£.	s. d.		£.	s. d.	£.	s. d.		
Bicknell, Percy, Esq.	1	1	0		Brand, Miss Janet (1881)			3	0	0	
Bieber & Co., Messrs. (1880)				1	1	0		10	0	0	
Bigge, Francis E., Esq., Carl- ton Curliou		1	1	0	Brassey, Albert, Esq. (1873)			100	0	0	
Billingsley, Capt., R.N.		0	10	0	Brassey, H. A., Esq., M.P.		5	0	0		
Birch, Miss Eliza, Cheddar		1	1	0	Brassey, Thos., Esq., M.P.		5	5	0		
Birch, Miss J. M. W., Neston		0	5	0	Bray, T. B., Esq.			3	3	0	
Birch, J. W., Esq.		1	1	0	Brayne, Charles Seymour, Esq.		0	10	6		
Birchall, J. Dearman, Esq. (1881)				1	Brecks, Chas., Esq. (1890)				1	0	0
Bird, S. G., Esq. Maida Vale		1	1	0	Brett and Co., Messrs.		0	10	6		
Ditto (1880)				1	Brettell, J., Vaughan, Esq.		1	1	0		
Birkbeck, Edward, Esq., M.P., V.P. (1861-81)				997	Brettell, Mrs., Camden Square		1	1	0		
Birkenhead National Eisteddfod, the Committee of (1879)				50	Bridge, T. J. L., Esq.		2	2	0		
Birmingham Branch (1880)				72	Bridges, Capt. H. E. (1873)				20	0	0
Birt, Messrs., Dock Street	4	4	0		Bridport Branch (1881)				9	9	3
Bischoff and Sons, Messrs.	1	1	0		Bridson, Josh., Winder- mere		2	0	0		
Black, Alex., Esq. (1875)				50	Briggs, Major-Gen. W. L., C.B. (1879)		26	5	0		
Blackburn Branch (1881)				18	Brighton Branch (1881)				52	18	2
Blackburne, Col. Wm.		1	1	0	Brinckman, Sir Theodore, Bart. (1878)				15	0	0
Blackwell, Samuel J., Esq.		2	2	0	Bristol Branch (1881)				76	4	11
Blain, Samuel, Esq., Liverpool	2	2	0		Bristol Histrionic Club, in aid of the support of their Life-boat at Lossie- mouth (additional) (1878).				50	0	0
Blake, T. N., Esq., Gosport.	5	0	0		Bristol, The Marquis of		2	2	0		
Blakiston, John R., Esq.	1	0	0		British Ship Owners' Com- pany (Limited)		5	5	0		
Blakiston, M., Esq., Maberley 2	0	0			Broadwood, Mrs., St. Leonards		2	2	0		
Bland, Captain, R.N.	5	0	0		Brock, Mrs. Osmond de Beauvoir.			2	2	0	
Blane, Capt. A. Rodney, R.N.	1	1	0		Brocklehurst, Chas., Esq.		1	1	0		
Blane, T. L., Esq., Dover St. (1875-80)	30	0	0		Brocklehurst, F. D., Esq. (1868-76)				18	3	0
Blatch, F., Esq., Theale		2	0	0	Brocklehurst, Wm. Walter, Esq.		5	0	0		
Blathwayte, Rev. C. W., M.A.	1	1	0		Brogden, J., Esq., Charing Cross		1	1	0		
Blenkinsop, B., Esq.	1	1	0		Bromley, H. M., Esq. (1881)				1	0	0
Bligh, Harbottle, and Co.	1	1	0		Bromley, Mossey, Esq. (1881)				1	1	0
Bolton Branch (1881)				35	Bromley, Wm., Esq. (1881)				1	1	0
Bonamy, Lieut.-Col.	1	1	0		Brook, Mrs., Foxcote		1	1	0		
Bond, Luke A., Esq., Cole- man Street	1	1	0		Brooke, Rev. J., Houghton		1	1	0		
Bonser, Mrs. (1873)				10	Brooke, Sir Wm. De Capell, Bart. (1857-81)				205	0	0
Boord, Mrs. Joseph, Stanley Gardens		1	1	0	Brooke, the Misses, sisters of the late John Brooke, Esq., Q.C., per John Richardson, Esq., Q.C., in addition to special gifts on behalf of Cahore, Giles' Quay, Greencastle, Balbriggan and Skerries Life-boats (1878)				100	0	0
Borough, J. C. B., Esq.	2	2	0		Brooks, G., Esq., Laceby		2	2	0		
Borradaile, J. H., Esq. (1875-80)				16	Brooks, Thomas, Esq.		1	1	0		
Borror, Mrs.		0	10	0	Brooksbank, Miss M. S., Acroplats (1862-70)				50	0	0
Borwick, Alfred, Esq.	1	1	0		Broughton, John, Esq., Poole		2	2	0		
Bosanquet, Curtis, and Co., Messrs.	2	2	0		Brown and Mackay, Messrs.		1	1	0		
Boston Shipwreck Association (1865-81)	85	0	0		Brown, Bateman, Esq., Hunt- ingdon				1	1	0
Ditto		5	0	0	Brown, David, Esq.				1	1	0
Boulton, M. P. W., Esq.	2	2	0		Brown, G. W., Esq., Houghton		1	1	0		
Bourne, John K., Esq.	1	1	0		Brown, George Gilpin, Esq., Sedbury Park (1874)				10	0	0
Bourne, Miss A. S.	5	0	0		Brown, Goppsil, & Sons, Messrs.		0	10	0		
Bouts, T., Esq., Gracechurch Street		1	1	0	Brown, Hy., Esq., Luton		1	0	0		
Bovet, Chas., Esq. (1877-81)		2	2	0	Brown, James Clifton, Esq. (1868-79)		200	0	0		
Bowden, Jas. P., Esq. (1881)				1	Brown, Miss A. M., Sudbury		0	5	0		
Bowles, Rev. G. D.	0	5	0		Brown, Mr. H., Jun., Luton		1	0	0		
Bowles, H. C. B., Esq.	2	2	0		Brown, Mrs., Whitehill		2	2	0		
Bowling, Henry P., Esq., Sacombe	2	2	0		Brown, Miss Rachel, Luton		1	0	0		
Bowyer, George, Esq.	1	1	0		Brown, Shipley, & Co., Messrs.		3	3	0		
Bowyer, John, Esq., the late	1	1	0		Browne, G. B., Esq., Halifax		2	2	0		
Bowyer, Miss Mary	1	1	0		Browne, G. H., Esq., Greenwich		3	3	0		
Bowyer, W. Esq., Buckden	1	1	0		Browne, J. W., Esq., Frascati		2	2	0		
Boyd & Co., J. & C., Messrs.	2	2	0		Browne, Lieut. A. G. F., B.S.C.		0	10	6		
Boyd, Alfred, Esq., Barlaston	1	0	0		Browne, Mrs., Avenue Road		1	1	0		
Boyd, E. F., Esq.	1	1	0		Browne, H. N., Esq.		1	1	0		
Boyle, Vice-Adml. A.	2	2	0		Browne, W. J., Esq., Kidwelly		1	0	0		
Boyton, F. R., Esq.	3	3	0		Brumell, Mrs. M. E.		1	0	0		
Bradford Branch (1881)				178	Bruno, Silva, & Son, Messrs. (1867-71)		26	5	0		
Bradford, Gen. Sir J. F., K.C.B.	1	1	0								
Bradford, Mrs. H. W.	1	1	0								
Bradford, Mrs. J. E.	1	1	0								
Bradshaw, Capt., R. A.	1	1	0								
Bramly, W. J., Esq.	1	0	0								
Bramswell, John, Esq., Ken- sington	2	2	0								

	Ann. Subs.		Donations.			Ann. Subs.		Donations.		
	£.	s. d.	£.	s. d.		£.	s. d.	£.	s. d.	
Brushfield, Mr. Richard . . .	0	10	6		Caldwell, J., Esq., Starcross (1878)	100	0	0		
Bryant, Arthur C., Esq. . . .	5	5	0		Calrow and Son, Messrs. J. . . .	1	1	0		
Brydges, Sir Harford Jones, Bart. (1857-78) . . . . .			25	0	0	Campbeltown & Southend Branch (1881)	15	0	0	
Brymer, Miss (1877-8) . . . .			10	0	0	Cameron, Miss, Hillwood . . . .	2	0	0	
Buccleugh, His Grace the Duke of, K.G. . . . .	10	10	0		Campbell, Arthur E., Esq. (1871)	50	0	0		
Buchanan, Mrs., Edinburgh . . .	1	1	0		Campbell, C. M., Esq., Stoke . . .	2	2	0		
Buckingham, Miss S. C. (1868-81)			31	8	0	Campbell, Mrs. Emma R. . . . .	1	1	0	
Buckle, Rev. John, M.A. . . . .	1	0	0		Candler, P. W., Esq. (1872-5) . . .			40	0	
Buckley, Victor, Esq. . . . .			2	0	0	Cann, James, Esq. . . . .	1	1	0	
Budge, Rev. H. S., B.A. . . . .	1	1	0		Capel, Frank C., Esq. . . . .	5	5	0		
Budgett, Messrs. J. & Son . . . .	2	2	0		Capel, J. D., Esq. . . . .			1	1	
Budgett, James & Branth, Messrs. (1873) . . . . .			21	0	0	Capel, Messrs. Arthur & Co. . . . .	1	1	0	
Bulkeley, Miss Louisa, Brighton (1866-81) . . . . .			165	0	0	Carbutt and Co., Messrs. . . . .	1	1	0	
Bullard, King, & Co., Messrs. . .	1	1	0		Cardale, Rev. E. T. . . . .			0	10	
Bulloch, Messrs. J. & G., & Co. . .	3	3	0		Carew, Mrs. G., Mytton Hall . . . .	2	2	0		
Bunbury, Sir Charles, Bart. . . .	3	0	0		Carew, Rev. Gerald . . . . .	1	1	0		
Bunn, Mrs. Sydenham . . . . .	2	2	0		Carew, Mrs. Hallowell (1870-81) . .	110	0	0		
Bunn, Miss, Sydenham . . . . .	0	10	6		Carew, T., Esq., Collipriest . . . .	1	0	0		
Burbidge, Pritchard, and Bartleet, Messrs. . . . .	1	1	0		Carew, Capt. B. Pole . . . . .	1	0	0		
Burch, E. C., Esq. (1881) . . . .			2	0	0	Carey and Browne, Messrs. . . . .	1	1	0	
Burchell, J. D., Esq. . . . .	1	0	0		Carey, S. W., Esq., New York, \$100 (1876)	18	16	4		
Burden, Stephen, Esq. . . . .	1	0	0		Carlingford, The Right Hon. Lord . . . . .			2	0	
Burgess, the Misses . . . . .			0	10	0	Carlisle, The Bishop of . . . . .	1	1	0	
Burgoyne, Montagu G., Esq. . . .	2	2	0		Carmichael, Sir W. G., Bart. . . . .	2	0	0		
Burgoyne, Thos., Esq. (1871) . . .			10	10	0	Carr, W. J., Esq. . . . .			1	1
Burkitt, Rev. Jas. . . . .	0	5	0		Carrera, C. L., Esq. . . . .			1	1	
Burmester, Miss . . . . .	1	1	0		Carson and Sons, Messrs. W. (1879)	10	10	0		
Burn, S., Esq. . . . .	1	1	0		Carswell, Morris, Esq., in memory of his wife (1880) . . . . .			15	0	
Burnes, Miss, Oxford (1880) . . .			3	0	0	Carter, Fredk. (1881) . . . . .			2	0
Burnett, D. W., Esq. . . . .	0	5	0		Carter, Rev. S. R., B.D. (1875) . . .			10	10	
Burnett, E. L., Esq. . . . .	1	1	0		Cartwright, Col. H. . . . .			1	1	
Burnett, W. H. W., Esq. . . . .	1	1	0		Cartwright, Capt. R. Norton . . . .	1	0	0		
Burney and Co., Messrs. . . . .	2	2	0		Cartwright, Miss, Bury St. Edmunds (1862-81) . . . . .			150	0	
Burr, D. Higford D., Esq. . . . .	2	0	0		Cartwright, Mrs., Ellingham . . . .	0	10	0		
Burrell, H., Esq., Gravesend . . .	1	1	0		Cartwright, Rev. R. . . . .			1	0	
Burrell, Hy., Esq., Castle Grey . .	2	2	0		Cassell, Smith, & Co., Messrs. . . . .	1	1	0		
Burrows, Mrs. Cookham (1881) . .			5	0	0	Cattley, Thos., Esq., Scarborough' (1880)	5	0	0	
Burton-on-Trent Branch (1880-81)	60	2	10		Cator, Miss S. H. Bertie (1861-73)	18	13	0		
Burton, Rev. R. C. . . . .	0	5	0		Ditto . . . . .			1	1	
Burton, W. F., Esq. (1859-70) . . .			15	0	0	Cator, Mrs. Wm. A. . . . .	1	1	0	
Burton, W. Hally, Esq. . . . .	1	1	0		Causton, Sir J., & Sons . . . . .	1	1	0		
Busfield, Major . . . . .	1	1	0		Cavan Branch (1831) . . . . .			12	0	
Busfield, Mrs., South Cave . . . .	1	1	0		Cave, B., Esq., Wigmore St. . . . .	0	10	6		
Busk, Capt. Hans . . . . .	1	1	0		Cave, L. T., Esq., F.R.G.S. . . . .	2	2	0		
Busk, Mrs. (1869-78) . . . . .			27	4	0	Cave-Browne-Cave, Mrs. Ed- ward F. . . . .			2	2
Butcher, Mrs. M. A., Islington, towards support of Margate and Yarmouth Life-boats (1873) . . . . .	200	0	0		Cave, W., Esq., Wigmore St. . . . .	0	10	6		
Butler, C., Esq., Drury Lane . . . .	0	10	0		Chads, Admiral . . . . .	1	0	0		
Butler, Lieut.-Col. H. T. (1880) . .			2	0	0	Chadwick, Mrs. . . . . .			1	1
Butler, Paul, Esq. (1873-4) . . . .			11	0	0	Ditto (1881) . . . . .			1	1
Butler, S., Esq., Fen Court . . . .	2	2	0		0	Chalmers, Guthrie, and Co. (1871)	10	10	0	
Butlin, C., Esq., Nottingham . . . .	1	1	0		Chalmers, Sir David, Demerara . . .	1	1	0		
Butlin, Thomas, Esq. . . . .			0	10	0	Chamberlain, Herbert, Esq. . . . .	2	2	0	
Butterworth, Edward, Esq. (1878) . .	20	0	0		Chamberlain, Lieut. T. J. . . . .	1	0	0		
Buxton, Fras. W., Esq. (1874) . . .	10	0	0		Chamberlain, Miss C. . . . .	1	1	0		
Byng, Admiral J. L. . . . .	1	1	0		Chamberlain, Richard, Esq. . . . .	1	1	0		
					Chamberlain, Tankerville J., Esq. (1870-9) . . . . .			12	2	
					Champion, F. C., Esq., Clap- ham . . . . .	1	1	0		
C., Mrs. M. L., South Australia, "In grateful remembrance of her merciful preservation from imminent dangers by sea in 1862" (1866-80) . . . . .	120	0	0		Chance, E., Esq., Lawnside . . . . .	2	2	0		
C. H. A. C. . . . .	0	10	0		Chaplin, E., Esq., Hamburg (1867-74)	26	5	0		
C. L. (1865-9) . . . . .	50	0	0		Chapman, T., Esq., F.R.S., Chairman . . . . .			21	0	
C. M. B., Sheffield (1878-81) . . . .	3	0	0		Chardless, H., Esq. (1867-81) . . . .	45	16	0		
C. S. and G. S. (1874) . . . . .	11	0	0		Charles, Mrs., Finchley . . . . .	1	1	0		
C. T. (A Seaman's Daughter, produce of her Needlework) (1864-72) . . . .	60	0	0		Charley, E., Esq., Lisburn . . . . .	0	10	0		
Cain, Geo., Esq. . . . .	0	5	0		Charley, Mrs., and Family, Dunmurry . . . . .	1	0	0		
Cain, Miss, Edmonton . . . . .	0	5	0		Charrington, Miss E., Woodsleigh (1875)	10	0	0		
					Charrington, Miss M., Harley Street . . . . .			2	2	
					Charteris, Lady Margaret . . . . .	2	2	0		

	Ann. Subs.		Donations.			Ann. Subs.		Donations.			
	£.	s. d.	£.	s. d.		£.	s. d.	£.	s. d.		
Chatterton, Mrs., Dublin (1880)			0	10	0	Collie, Dr. G. D. Milne	1	0	0		
Chatterton, Miss J., Dublin	1	0	0			Collier, Messrs. F. H. & A.	1	1	0		
Chavasse, Mrs. Horace	1	1	0			Collin, J., Esq., Lewisham	1	1	0		
Chaytor & Co., Messrs.	1	1	0			Collin, Miss, Gower St.	2	2	0		
Cheape, G. C., Esq., Wellfield (1864-80)	62	0	0			Colling, Joseph, Esq., Islington (1875)	10	10	0		
Cheesman, G., Esq., Dorking	3	3	0			Ditto	1	1	0		
Cheetam, C., Esq.	2	2	0			Collingwood, Miss M. A.	1	1	0		
Cheltenham Branch (1880)			10	12	3	Collinson, Admiral Sir R., K.C.B.	1	1	0		
Chetwynd, The Viscount	1	0	0			Collinson, Miss A. M., Weston (1865-81)	68	10	0		
Chetwynd, Major the Hon. C. C.	1	1	0			Colonial Company (Limited)	2	2	0		
Chester Branch (1881)			18	3	6	Colvill, Colonel (1873-81)			2	0	0
Chester, C., Esq.	5	0	0			Colville, Lord	2	2	0		
Chichester Harbour & Selsey Branch (1881)			40	0	0	Colvin, Miss E. H.	2	2	0		
Child and Co., Messrs.	2	2	0			Commeline, Thomas, Esq.	0	10	0		
Child, Sir Smith (1881)			5	0	0	Commercial Union Assurance Company (1879)			10	10	0
Childers, Rt. Hon. H. C. E., M.P.	1	1	0			Comptoir d'Escompte de Paris	3	3	0		
Childers, Miss L.	1	1	0			Conlan, F. P., Esq., Lincoln	1	1	0		
Cholmondeley, The Marquis of.	2	2	0			"Continental Daily Parcels Express"	1	1	0		
Chorlton, Isaac, Esq., Withington	1	1	0			Conyngham, Marquis of	2	2	0		
Christy and Co., Messrs., Gracechurch Street	1	1	0			Cooch, Mrs. R.	2	2	0		
Christie, Mrs. (1878)			10	10	0	Coode, Sir John	1	1	0		
Chudleigh, Mrs.	2	2	0			Cook, Mrs. A.	0	5	0		
Church and Son, Messrs.	0	10	0			Cooke, Mrs. Martha (1865-71)	20	0	0		
Church, Rev. G. L.	0	10	6			Cooper, Cooper, & Co., Messrs.	1	1	0		
Chuter, Mrs., Croydon	2	2	0			Cooper, J. E., Esq., Milford	3	3	0		
Civil Service Life-boat Fund, vide p. 319.						Cooper, Mrs., Cobham (1881)			5	0	0
Claris, Sydney, Esq. (1881)	5	5	0			Coote, Thomas, Esq.	1	1	0		
Clark, W., Esq., Brompton	2	2	0			Coplestone, Rev. W. C. (1878-80)	1	0	6		
Clarke and Rowe, Messrs.	1	1	0			Corbett, Miss, Brighton	1	1	0		
Clarke, H. M., Esq.	2	0	0			Cordes, T., Esq., Bryn Glas (1869)	10	10	0		
Clarke, Mrs. Cowden	1	1	0			Ditto	2	2	0		
Clarke & Co., Stephenson	2	2	0			Cordwainers, Worshipful Company of (1875)			21	0	0
Clarke, The Misses, Carlisle	2	0	0			Cork and Queenstown Branch (1880-81)	54	17	7		
Clatworthy, J., Esq.	1	0	0			Cornell, Geo., Esq., Coleshill	1	1	0		
Clayton, Colonel Fitz-Roy	2	0	0			Cornell, R., Esq., New Cross	1	1	0		
Clayton, C. H., Esq.	1	1	0			Cornell, Samuel, Esq., Chelsea	1	1	6		
Clayton, F. S., Esq.	1	1	0			Cornish-Bowden, Admiral W.	2	2	0		
Clayton, Sir Wm. R., Bart.	5	5	0			Corrie, Mackie, & Co., Messrs.	2	2	0		
Clayton, T. W., Esq., Ryde (1859-73)	15	0	0			Corrie, Rev. E. S., in memory of E. B. C.			0	10	0
Clegram, W. B., Esq., J.P.	2	2	0			Corrie, A. J., Esq., Duurod	2	2	0		
Clerk, Major-Gen. H., R.A.	1	1	0			Ditto (1878-81)			4	4	0
Clermont, Lord	2	2	0			Corrie, Miss, Malvern Wells (1878-81)	4	4	0		
Clermont, Lady	1	1	0			Corscaden, Mrs., Holland Park	5	5	0		
Clevedon Life-boat Fund, vide p. 319.						Cory, Miss, Stamford	1	0	0		
Clifford, Messrs. C., & Son	1	1	0			Coster, Capt.	1	1	0		
Clifford, Colonel	2	0	0			Cotesworth, W., Esq.	1	1	0		
Clinton, Lady Charlotte P.	1	1	0			Coupland, J. M., Esq., Tinsley (1859-71)	15	0	0		
Cloid, Routledge, and Co.	2	2	0			Courage and Co., Messrs., Horse-lydown (1859-80)			50	0	0
Clothier, Mrs. (1881)			1	0	0	Court, A., Esq., R.N.	0	5	0		
Clothworkers, Worshipful Company of (1855-80)	135	9	0			Court and Co., Messrs.	0	5	0		
Clough, Hugh C. B., Esq. (1880)			10	0	0	Courtenay, Messrs. J. & W. J.	2	2	0		
Clowes, R., Esq., Stockwell (1861-81)	18	18	0			Courtenay, Miss, Brompton (1880)	50	0	0		
Clutterbuck, Mrs. C. F.	2	2	0			Courthope, G. C., Esq.	1	1	0		
Coal Factors' Society	5	5	0			Ditto, in aid of Sussex Life-boats	1	0	0		
Coal Merchants' Society	5	5	0			Courtney, J. W., Esq., Chelsea	1	1	0		
Coates, James, Jun., Esq., Paisley (1874)	20	0	0			Courtney, Miss, Stoney Cross	1	0	0		
Coates, Jos., Esq., North Bank	1	1	0			Courtown Branch (1881)			8	0	0
Cobb, Mrs. M. A., Jersey (1880)	300	0	0			Coutts and Co., Messrs.	10	0	0		
Cock, Miss E. A. (1868-81)	70	0	0			Covent Garden Life-boat Fund, vide p. 319.					
Cockey, E., Esq. & Mrs., Frome	0	10	0			Cowie, T. S., Esq. (1863-74)	21	0	0		
Codd, Admiral (1880)			5	0	0	Cowie, Mrs. In remembrance of little Alfred's 14th birthday (1881)			1	1	0
Ditto	1	1	0			Ditto, and Family (1872-81)			10	17	6
Coffin, Admiral H. E. (1867-78)	34	10	0			Cox and Co., Messrs.	5	5	0		
Cole, A. C., Esq., Lee	1	1	0			Cox, Henry, Esq., Trevereux (1864-77)	50	0	0		
Coleman, Capt. G.	1	1	0			Cox, Miss	1	1	0		
Coleman, Rev. W. (1868-80)			7	0	0	Cracklow, General	2	0	0		
Coles, J., Esq., Throgmorton Street	1	1	0			Cranfield, Wm. Esq.	1	1	0		
Coles, Miss A., West Hove	0	10	6			Craven, Miss S.	0	10	0		
Coller, Mrs. (1878)			50	0	0						
Ditto	1	1	0								
Collet, W. W., Esq.	1	1	0								





	Ann. Subs.		Donations.			Ann. Subs.		Donations.	
	£.	s. d.	£.	s. d.		£.	s. d.	£.	s. d.
Duncan, G., Esq., East India Avenue	5	5	0		Engelhardt, L. A., Esq.	1	1	0	
Duncombe, G. T., Esq.	3	3	0		English, Bros., Messrs.	1	1	0	
Dunfee Branch (1881)				80 0 0	English, Capt., R.E.	1	0	0	
Dunfermline Branch (1881)			23	15 5	Engström, George, Esq.	1	1	0	
Dunn and Co., Messrs. W.	1	1	0		Enniskillen Branch (1881)				15 18 10
Dunn, Ernest H., Esq.	1	1	0		Epps, Jas., Esq., Norwood	1	1	0	
"Dunsappie" (1874)				10 0 0	Erne, The Earl of, K.P.	1	0	0	
Dunsford, Miss (1873-81)				9 9 0	Erne, The Countess of	1	0	0	
Durnford, Rev. Edmund	1	1	0		Ernsthausen and Oesterley, Messrs.	1	1	0	
Durrant, Capt. F., R.N.	2	0	0		Esse, F., Esq. (1877-80)				4 4 0
Dyas, Capt. R. H.	3	0	0		Essex and Colchester Branch (1881)	24	3	10	
Dyer, John, Esq., Blackheath	1	1	0		Estridge, Edward, Esq.	1	1	0	
Dyer, Wm., Esq.	3	3	0		Evans, Capt. F. J. O., R.N., C.B., F.R.S.	2	2	0	
E. (1869)				50 0 0	Evans, Mrs., Seymour Street	2	0	0	
E. A. (1870)				10 10 0	Evatt, Miss C. Hanning (1878)	10	10	0	
E. A. B. (1872-5)				17 0 0	Eversfield, C. G., Esq.	1	1	0	
E. B., a Thank-offering for mercies received (1869)				100 0 0	Ewart, Macaughy, and Co., Messrs.	2	2	0	
E. C., Lancaster Gate	1	0	0		Ewart, Miss Mary A.	3	3	0	
E. C. (1872-5)				20 0 0	Ewart, William Lee, Esq.	10	0	0	
Ditto, a Thank-offering (1876)				10 0 0	Ewing, W. Orr, Esq.	5	0	0	
E. C. E., Horsham (1880)				5 0 0	Exmouth Branch (1881)				29 0 0
E. C. W. (1869-81)				8 0 0	Eyre, G. J., Esq. (1872-80)				90 0 0
E. G. (1876-81)				21 0 0	Eyre, G. J., Esq., Hove	5	5	0	
E. H. (1869)				10 0 0	Eyre, Mrs. M., South Kensington (1880)	2	0	0	
E. H. (1873)				10 0 0	Eyre, Rev. H. S.	1	0	0	
E. M. C.	5	0	0		Eyre, Mrs. Robert	0	10	6	
E. V. A. (1875-7)				45 0 0	F. G. R. (1878)				10 0 0
Earle's Shipbuilding & Engineering Co., Limited.	1	1	0		F. P. H. (1871)				10 0 0
East and West India Dock Co. (1863)	52	10	0		F. R. (1869)				50 0 0
East, Sir Gilbert A. C., Bart.	5	0	0		Faber and Co., Messrs. A.	2	2	0	
Eastbourne Branch (1881)				34 9 4	Fair, J., Esq.	2	2	0	
Easton, John, Esq., M.D.	1	1	0		Fairbank, H., Esq., Willenhall	1	1	0	
Eastwood, John F., Esq.	1	1	0		Fairthorne, E., Esq.	2	2	0	
Ecroyd and Sons, Messrs.	3	3	0		Fairthorne, Miss A.	5	0	0	
Eden, Mrs. Henry	2	0	0		Fairthorne, Miss E.	1	1	0	
Edge, W. M., Esq.	1	1	0		Fairthorne, Mrs., Slade End.	0	10	6	
Edgeworth, M. P., Esq.	0	10	0		Falcon, Mrs. (1867-71)				15 0 0
Edinburgh, Leith, and Granton Branch (1880)				263 17 3	Falcon, Rev. R. S.	2	2	0	
Edwardes, T. D., Esq.	1	0	0		Falmouth, The Viscount	5	0	0	
Edwardes, J., Esq., Record Office	1	1	0		Fane, W. D., Esq.	2	2	0	
Edwards, Miss, Clifton	1	1	0		Fanning and Co., Messrs. W.	1	1	0	
Edwards, Miss M. (1871)				50 0 0	Fanshawe, Mrs. F., Uckfield	0	10	0	
Edwards, S., Esq., Fenchurch Street	1	1	0		Fanshawe, Rev. Arthur A. (1872)	20	0	0	
Edwards, S., Esq., Lewisham	1	1	0		Fanshawe, Adm. E. G., C.B.	1	1	0	
Egan, T. Selby, Esq.	1	1	0		Farmer, J.S.C., Esq., s.s. <i>Craigforth</i> (1880)				0 10 0
Egerton, Mrs. M. A. F.	5	0	0		Farmer, Capt. Wm. R. G.	1	1	0	
Egerton, Miss G. C.	2	0	0		Farnell, Mrs., Colchester	1	1	0	
Egerton, Rev. J. C.	0	10	6		Farquhar, Captain H. R., 24th Regt. (1865-74)				70 0 0
Ekins, Mrs. P. J.	5	5	0		Faulkner, J., Esq., Tunbridge Wells (1880)				5 0 0
Elam, Miss	2	10	0		Fayad, Abram., Esq., Alexandria (1880)	0	10	0	
Elder, A. L., Esq.	1	1	0		Featherstonhaugh, C., Esq.	1	0	0	
Elias and Co., Messrs.	1	1	0		Feeney, John, Esq.	1	1	0	
Eliot, Hon. H. C.	2	0	0		Fellowes, H. D., Esq.	5	0	0	
Ellen and Co., Messrs.	0	10	6		Fellowes, C. F., Esq.	5	0	0	
Elliott, Geo., Esq., Croydon (1873-81)	15	0	0		Ditto (1868-9)				10 0 0
Elliott, Sir Walter	1	0	0		Felton, W. V., Esq. (1873)				10 0 0
Elliott, Mrs., Bournemouth	2	2	0		Fenn, Mrs., Blackheath Park (1881)	1	0	0	
Elliott, Wm., Esq.	1	1	0		Fenwick, C. R., Esq.	5	0	0	
Ellis and Sons, Messrs. H.	1	1	0		Fenwick, Capt. John	1	1	0	
Ellis, Alderman (of London)	1	1	0		Fenwick, Mrs. S. C.	1	0	0	
Ellis, Capt., Lyminster	2	0	0		Few, Chas., Esq. (1881)				5 5 0
Ellis, Mrs., Hampstead	1	1	0		Few, Rev. Charles E., M.A.	1	1	0	
Ellis, Miss, Hampstead	1	1	0		Field, Capt. E., R.N.	1	0	0	
Ellis, Mrs., Bognor	0	10	6		Field, Rev. F., Heigham	1	1	0	
Elwes, J. H., Esq.	2	0	0		Field, J. P., Esq.	2	0	0	
Ely, The Most Noble the Marquis of	20	0	0		Figgis, Samuel, Esq.	2	2	0	
Emery, William, Esq.	0	10	6		Filliter, Freeland, Esq.	1	1	0	
Emmerson, Mrs. Susan (1873-80)	7	5	0		Findlater, Mackie, and Co.	2	2	0	

	Ann. Subs.		Donations.			Ann. Subs.		Donations.	
	£.	s. d.	£.	s. d.		£.	s. d.	£.	s. d.
Findlay, Mrs. James, in aid of Scotch Life-boats . . .	1	1	0		Gale and Co., Messrs. . . . .	2	2	0	
Finnis, Fisher, & Co., Messrs. . . .	1	1	0		Galloway, Joseph, Esq. . . . .	1	0	0	
Fisher, G. A., Esq. . . . .	1	1	0		Gambier, Admiral R. F. . . . .	1	0	0	
Fishmongers, Worshipful Company of (1873) . . . . .	105	0	0		Garden, Miss Emma (1858-80) . . . .	42	10	0	
Fishwick, J. H., Esq. (1871-81) . . .	11	10	0		Garden, Mrs. (1863-72) . . . . .	34	10	0	
Fishwick, S. E., Esq. (1875-81) . . .	7	6	0		Gardiner, Miss . . . . .	1	1	0	
Fisk, Rev. J. H. (1857-71) . . . . .	45	0	0		Gardner, F. G., Esq. . . . .	1	1	0	
Fitz-George, Capt. G. . . . .	1	1	0		Gardner, Rev. T. J. C. . . . .	1	1	0	
FitzRoy, Captain C. C. (1869) . . . .	10	0	0		Garland, C., Esq., Billiter St. . . . .	0	10	6	
Fladgate, Mrs., Staines . . . . .	1	1	0		Garrett, W., Esq. . . . .	1	1	0	
Fleetwood Branch (1881) . . . . .	50	0	0		Garrett, W. H., Esq. . . . .	1	1	0	
Fleming, B. R., Esq., Down St. . . . .	5	5	0		Garrett, Mrs. W. H. . . . .	1	1	0	
Fletcher, W., Esq., Cheltenham . . . .	2	0	0		Garston, Edgar, Esq., K.R.G. (1871-3)	15	0	0	
Flood, Frederick, Esq. . . . .	5	5	0		Gas Light and Coke Company . . . . .	10	0	0	
Flower, C. E., Esq. (1859-69) . . . . .	21	0	0		Gatty, C. H., Esq. . . . .	2	2	0	
Ford, Mrs., Croydon (1872-9) . . . . .	12	5	0		Gatty, Mrs. (1880) . . . . .			5 0 0	
Ford, Mrs., Queensboro' Terrace (1880)	0	10	0		Gee, Mrs. Isabella, Aberdeen (1879)			17 10 0	
Foreman, Mr. Owen . . . . .	0	5	0		George, Hugh, Esq., Horncastle (1877-80)			5 1 0	
Foresters, Ancient Order of, <i>vide p.</i> 319.					Gibb, B. D., Esq., Royal Exchange (1874)			10 10 0	
Forrest, Major-General . . . . .	1	1	0		Gibb, Chas. J., Esq., M.D. (1871) . . . .	10	10	0	
Forrester, Miss (1870-81) . . . . .	45	0	0		Gibb, Col. W. E. (1873-81) . . . . .	9	9	0	
Forrow, B. A., Esq., and Edwin Taffs, Esq., Poplar (1874) . . . . .	10	10	0		Gibb, T. Jones, Esq. . . . .	2	2	0	
"For those in peril on the Sea" (1872-80) . . . . .	41	0	0		Gibbes, W., Esq. . . . .	1	0	0	
Fortnum, Mason, and Co., Messrs. . . . .	2	2	0		Gibbs, Geo., Esq., Junr. (1877-81)			5 5 0	
Foster, James L., Esq. (1875-81) . . . .	40	0	0		Gibbs, H. H., Esq. . . . .	2	2	0	
Foster, Rev. Sir C., Bart. . . . .	2	2	0		Gibson, Mrs. (1873-80) . . . . .			7 0 0	
Foster, Richard, Esq. . . . .	5	0	0		Giesler and Co., Messrs. . . . .	3	3	0	
Fothergill, The late Mr., per Mrs. Fothergill (1881) . . . . .	50	0	0		Gilbert, J. A., Esq. . . . .	1	1	0	
Fowler, John, Esq., Sheffield (1874-7)	11	6	0		Gill, John, Esq., Battersea . . . . .	1	1	0	
Fox, Rev. G. T. . . . .	1	1	0		Gillespies, Moffatt, and Co. . . . .	2	2	0	
France-Hayhurst, Rev. T. . . . .	1	0	0		Gillett, W. S., Esq. . . . .	1	1	0	
Francis, Mrs. A., Colchester . . . . .	0	10	0		Gillett, Mrs. W. S. . . . .	1	1	0	
Franklyn, H. W., Esq. . . . .	2	2	0		Gilmour, Rankin & Co., Messrs. . . . .	1	1	0	
Fraser, E., Esq., Insch (1872-8) . . . .	35	0	0		Girdlestone, Mrs. E. B., Ox- ford . . . . .	1	0	0	
Fraserburgh Branch (1881) . . . . .	25	0	0		Glasgow Branch (1881) . . . . .	390	10	0	
Frazer, Miss Florence M. . . . .	1	1	0		Glen, Joseph, Esq. (1873-9) . . . . .			52 0 0	
Frazer, John, Esq., Cornhill . . . . .	1	1	0		Glover Brothers, Messrs. . . . .	0	10	0	
Frazer, Mrs., Manchester . . . . .	2	2	0		Godlee, Mrs. R. . . . .	1	1	0	
Freeland, Messrs. J. and A. B. . . . .	1	1	0		Godsal, P. W., Esq. . . . .	2	0	0	
Freeling, Mrs. (1869-80) . . . . .	39	18	0		Godwin & Son, Messrs., Poole . . . . .	2	2	0	
Freeman, C., Esq., Leamington (1874)	10	0	0		Goff, Major R. . . . .	1	0	0	
Freeman, Miss, Canterbury (1872-80)	45	0	0		Goldsmith, Admiral, C.B. . . . .	1	1	0	
Freer, Rev. T. H., M.A. . . . .	1	1	0		Goldsmiths, Worshipful Co. of (1877)	150	0	0	
Freer, Leacroft, Esq. . . . .	-1	1	0		Gollop, G. T., Esq. . . . .	2	2	0	
French, B. F., Esq. (1880) . . . . .	10	0	0		Gollop, Mrs. . . . . .	1	1	0	
French, David, Esq. (1881) . . . . .	10	10	0		Gomonde, Mrs. Anne, Pau (1864-80)			340 0 0	
Freshfield, Miss . . . . .	1	1	0		Gonne, Edward, Esq. . . . .	1	1	0	
Fribourg and Treyer, Messrs. . . . .	0	10	0		Goode, Miss M. H. (1877-81) . . . . .	2	10	0	
Frith, Rev. Wm. A., M.A. (1871-81)	10	9	0		Goode, The Misses (1880) . . . . .	1	0	0	
Frost, Brothers, Messrs. . . . .	1	1	0		Goodenough, S. R., Esq. . . . .	1	1	0	
Fry, The Hon. Justice . . . . .	2	0	0		Goodman, Miss M. (1869-81) . . . . .	42	0	0	
Fryer, Captain, Worthy Park Ditto (1880) . . . . .	1	1	0		Goolden, Dr. Francis (1881) . . . . .	1	0	0	
Fuller, Mrs. Trayton . . . . .	2	0	0		Gordon and Stamp, Messrs., for the steamers <i>Nettlesworth</i> , <i>Leversons</i> , <i>Monica</i> , <i>Consul, Usworth</i> , <i>John John-</i> <i>asson</i> , <i>Dorcas</i> , <i>Eunice</i> , and <i>Sybil</i> . . . . .	4	10	0	
					Gore, Miss E. E. . . . .	1	0	0	
G., Thurloe Square . . . . .	1	4	0		Gore, Rev. G. (1876) . . . . .			10 0 0	
G. B. (1872) . . . . .	25	0	0		Gorringe, Frederick, Esq. . . . .	2	2	0	
G. B. (1881) . . . . .	1	0	0		Gosling, Francis, Esq. . . . .	1	1	0	
G. H. (1880) . . . . .	5	0	0		Gosling, General W. C., R.A. . . . .	1	1	0	
G. J. A. (1872) . . . . .	20	0	0		Gosling, H., Esq., Wyesham . . . . .	1	1	0	
G. L. (1877-81) . . . . .	2	0	0		Gosselin, Gerard, Esq. (1880) . . . . .			5 0 0	
G. R. B. (1877-80) . . . . .	15	5	0		Gotobed, Miss . . . . .	2	2	0	
G. S. (1878-80) . . . . .	2	15	0		Ditto (1873-6) . . . . .			10 0 0	
Gadsby, John T., Esq. . . . .	1	1	0		Goyeneche, J. V., Esq. . . . .	1	1	0	
Gairdner, G. W., Esq. . . . .	1	1	0		Graham, Col. Sir L., Bart. . . . .	2	0	0	
					Graham, Cyril C., Esq. . . . .	1	0	0	
					Graham, H. S., Esq., Bradford (1880)			0 10 6	
					Grant, Messrs. J. and R. (1874) . . . .			21 0 0	
					Grant, Henry, Esq., Fen- church Street . . . . .	2	2	0	
					Grant, R., Esq., Leadenhall St. (1881)	21	0	0	

LIST OF DONATIONS AND ANNUAL SUBSCRIPTIONS.

	Ann. Subs.		Donations.			Ann. Subs.		Donations.	
	£.	s. d.	£.	s. d.		£.	s. d.	£.	s. d.
Grant, Edw., Esq., Leamington (1881)			1	1	0	Hamilton, F. A., Esq. . . . .	10	10	0
Grant, W. D., Esq., Leamington	1	0	0			Hamilton, John, Esq. . . . .	3	0	0
Gray, Dawes, & Co., Messrs.	1	1	0			Hamilton, Rear-Admiral, C.B.	1	0	0
Gray, Rev. C. . . . .	0	5	0			Hamilton, Major T. B. . . . .	1	1	0
Greaves, Mrs. . . . .	0	10	0			Hammick, Mrs. W. M. . . . .	1	1	0
Green, Frederick, Esq. . . . .	1	1	0			Hand, Vice-Adm. G. S., C.B.	1	1	0
Green, J., Esq., Dover St. . . . .	1	1	0			Hankey, Capt. F. T. B., R.N.	1	0	0
Green, Joseph E., Esq. . . . .	1	1	0			Hankey, George, Esq. . . . .	1	1	0
Greenock Branch (1881) . . . . .			40	0	0	Hankey, Capt. Walter A. (1879) . . . . .	10	10	0
Greenway, Mrs., Myton . . . . .	2	2	0			Hankey, Wm. Barnard, Esq. . . . .	1	0	0
Greenwood, John, Esq. . . . .	0	10	6			Hanmer, Capt. J. G. J., R.N.	0	10	0
Gregory and Co., Messrs. F. . . . .	1	1	0			Hanson, Mrs. . . . .	0	10	6
Gregory and Prentis, Messrs., Bermondsey . . . . .	1	1	0			Harcourt, Adm. F. E. Vernon . . . . .	1	1	0
Grey, Lady, Norwood (1872-9) . . . . .			50	15	0	Hardie, Mrs. Peter, Bayswater (1874-81) . . . . .	30	5	0
Ditto . . . . .	1	0	0			Hardie, Thos. Kincaid, Esq., do. (1874-81) . . . . .	40	5	0
Grice & Co., Messrs. W. (1862-81) . . . . .			185	0	0	Hardman, Mr. T. . . . .	0	5	0
Griffin, E., Esq., Oakley Square (1867-80) . . . . .	61	10	0			Hardwick, Mrs. F. W. . . . .	1	1	0
Griffith, Sir G. Waldie, Bart. . . . .	3	0	0			Hardy, Mrs. . . . .	1	1	0
Griffith, J., Esq., Regent's Park . . . . .			52	10	0	Hardyman, Miss C. J. . . . .	1	1	0
Griffith, Mrs. (1881) . . . . .			0	10	0	Hare, John, Esq., Stonehouse . . . . .	1	1	0
Griffiths, Tate, and Selby . . . . .	2	2	0			Harker & Co., Messrs. G. . . . .	1	1	0
Grindall, Mrs. Sturt (the late) . . . . .	1	0	0			Harper, E. N., Esq. . . . .	1	1	0
Gripper, John E., Esq. . . . .	1	1	0			Harris, J., Esq., Thames St. . . . .	0	10	0
Grocers, Worshipful Company of (1877) . . . . .			100	0	0	Harris, Miss, Clapton . . . . .	1	1	0
Grosvenor, Capt. the Hon. Norman de P.A. . . . .	1	0	0			Harris, J., Esq., Thames St. . . . .	0	10	0
Grosvenor, Chater, and Co., Messrs. . . . .	1	0	0			Harris & Dixon, Messrs. . . . .	2	2	0
Grove, Chas. B., Esq., Callender . . . . .	1	1	0			Harrison, C. A., Esq., Lincoln . . . . .	2	2	0
Grove, Mrs., Bolton Row . . . . .	1	1	0			Harrison, Mrs. F., Surbiton (1881) . . . . .	1	0	0
Grove, Miss Chafyn . . . . .	5	0	0			Hart, Henry, Esq., Rotherham . . . . .	0	10	0
Gubbins, Mrs. . . . .	2	2	0			Hartley & Co., Messrs. James . . . . .	2	2	0
Guimaraens, M. F., Esq. . . . .	0	10	6			Hartley, F., Esq., Exeter . . . . .	0	5	0
Gun Makers, Worshipful Company of (1881) . . . . .			10	0	0	Hartley, Jas. Robt., Esq. (1881) . . . . .	10	10	0
Gunning, Rev. Sir Henry, Bart. . . . .	0	10	0			Harton, Samuel, Esq. . . . .	1	1	0
Gurdon, W., Esq. (1864-76) . . . . .			25	0	0	Harton, W. H., Esq., V.P. . . . .	2	2	0
Gwilt, Alfred, Esq. . . . .	1	1	0			Harvey and Greenacre, Messrs. (1875-8) . . . . .	15	0	0
Gwilt, Mrs. . . . .	1	1	0			Ditto . . . . .	5	0	0
Gwilt, Mrs. Hannah Jackson (1877) . . . . .			10	10	0	Harvey, Charles, Esq. . . . .	1	1	0
H. and F. M., in aid of Hummersea, Whitby, or Staithes Life-boats (1875-6) . . . . .	15	0	0			Harvey, H. M., Esq., Hexworthy (1866-79) . . . . .	90	0	0
H. B. T. (1867-80) . . . . .			11	0	0	Harvey, Miss B. A., Ickwell Bury . . . . .	1	0	0
H. C. (1869) . . . . .			20	0	0	Harvey, the late Mrs. Alicia, Exors. of, Rev. G. M. Gorham and Rev. J. Holmes (1879) . . . . .	20	0	0
H. E. U., Bitterne (1874) . . . . .			100	0	0	Harvie, Miss Hannah (1877) . . . . .	50	0	0
H. G. . . . .	1	1	0			Harwich Branch (1881) . . . . .	30	0	0
H. G. (1870) . . . . .			10	10	0	Harwood, Knight, and Allen, Messrs. . . . .	1	1	0
H. M. (1877) . . . . .			25	0	0	Haslam, Appleton, and Co., Messrs. . . . .	1	1	0
H. P. F. (1869) . . . . .			10	0	0	Haslam, Henry, Esq., Croydon . . . . .	1	1	0
H. R. (1871) . . . . .			25	0	0	Hassell, Mrs., Cheltenham (1879-80) . . . . .	10	0	0
H. R. S. (1875) . . . . .			10	0	0	Hastings and St. Leonards Branch (1880-1) . . . . .	75	0	0
H. S. C. (1859-81) . . . . .			500	0	0	Haswell, Rear-Admiral W. H. . . . .	1	0	0
Haarbleicher and Schumann. . . . .	1	1	0			Hatcher, D., Esq. . . . .	0	5	0
Haberdashers, Worshipful Company of (1878-80) . . . . .			15	15	0	Hatherton, Lord . . . . .	1	1	0
Hack, C., Esq., Poplar . . . . .	5	0	0			Hatton, Mrs., Leamington . . . . .	0	10	0
Hackett, Ausender, and Co. Messrs. . . . .	1	1	0			Haverfield, Rev. W. R., M.A. . . . .	0	10	0
Hacon, The Misses . . . . .	1	0	0			Hawes and Hertz, Messrs. . . . .	0	10	0
Haddington, The Earl of . . . . .	1	0	0			Hawker, Charles, Esq. . . . .	1	1	0
Haigh & Son, Messrs. W. . . . .	0	10	6			Hawkins, Clement, J., Esq. . . . .	1	1	0
Halford, Lady . . . . .	1	1	0			Hawkins, Rev. Bradford D., in memory of E. B. C. . . . .	0	10	6
Hall, John, Esq., Addiscombe . . . . .	2	2	0			Hay, Adm. J. B. L. . . . .	2	2	0
Hall, Miss M. S. . . . .	0	10	0			Hay, Adm. J. B. P. . . . .	1	0	0
Hall, Miss, Whitchurch . . . . .	1	1	0			Hay, Mrs., Carshalton (1879-81) . . . . .	1	11	0
Hall, Richard, Esq., Wigton . . . . .	1	1	0			Haycock, Miss H., Clifton (1862-80) . . . . .	17	0	0
Ditto (1881) . . . . .			2	0	0	Hayes, Mrs. L., New Hampton . . . . .	2	0	0
Hall, Richard C. Esq., Bath . . . . .	1	0	0			Ditto (1877-80) . . . . .	11	0	0
Hallam, C. T., Esq. . . . .	0	10	0			Hayes, Lieut. M. R., R.N., The late, per Vice-admiral Hayes, C.B. (1881) . . . . .	10	0	0
Halsey, Mrs. (1881) . . . . .			0	10	0	Hayle Branch (1881) . . . . .	5	0	0
Hambro & Son, Messrs. C. J. . . . .	1	0	0			Hayne, Chas. Seale, Esq., Eaton Square . . . . .	1	0	0
						Haynes, Edmund C., Esq. . . . .	1	1	0

	Ann. Subs.		Donations.			Ann. Subs.		Donations.		
	£.	s. d.	£.	s. d.		£.	s. d.	£.	s. d.	
Hays, John W., Esq. (1859-69)	1	1	0		Hodgkinson, W. S., and Co.,					
Hay's Wharf, Proprietors of.	1	1	0		Messrs.	1	1	0		
Hayter and Hayter, Messrs.	1	1	0		Hodgson, E. D., Esq., Temple	1	1	0		
Hayward, J. Fred., Esq. (1873-80)			36	0	Hodgson, F. C., Esq., Down-			1	10	
Head and Co., Messrs. H.	2	2	0		ing Street					
Headfort, The Marquis of	2	2	0		Hodgson, F. W., Esq., Friday			1	1	
Headly, J. Ind., Esq.	2	0	0		Street			1	0	
Hearne, T. P., Esq. (1869)			10	10	Hoggard, Mrs. (the late).			1	0	
Heathcote, J. M., Esq.	1	1	0		Holden, E. T., Esq.			1	1	
Heathorn, W., Esq., and Lady					Holder, Chas. V., Esq., Maida					
Prinn	2	2	0		Vale			5	0	
Heatley and Son, Messrs.	1	1	0		Holland, Commander S. C.,			1	1	
Hemery, C., Esq.			0	10	R.N.					
Henckell, Du Buisson, and Co.,			2	2	Holland, Edmund, Esq., Hyde					
Messrs.			2	2	Park Square (1872-81)			31	5	
Henderson, Miss F., in memory of the			1	1	Holland, The Hon. Mrs. F.			1	1	
late J. Henderson, Esq., R.N.			1	1	Holliday, Miss A. S., (1878-80)				6	
Henderson, The Misses S. & F., Lee (1881)			3	3	Holmes, Sancroft, Esq.			1	0	
Heneage, Major			5	5	Home, Mrs., Edinburgh			0	10	
Henley-on-Thames Branch (1881)				9	16	0	Home, The Rt. Hon. Earl of			
Hennell, Thomas, Esq.			0	10	0	Homer, C. G., Esq.			1	
Henning, E. Nares, Esq.			0	10	6	Homer, Rev. H. (1875-81)			8	
Henning, Mrs., Orsett Ter.			1	1	0	Honychurch, Mrs.			0	
Henry, Lieut.-Col.			1	1	0	Hood, Admiral, C.B.			2	
Henty, C. P., Esq., Chichester			1	1	0	Hood, Miss Jacobm (1864-71)				
Hepburn, Mrs. Emily M.			1	1	0	Hooper, A., Esq., Royal In-				
Herbert, Dennis, Esq.			1	1	0	stitution (1863-73)			25	
Herd, Mrs. J.			1	1	0	Ditto			1	
Hereford, Miss Lucy, Mordiford			4	0	0	Hooper, A. D., Esq., Lloyd's			1	
Herring, Messrs. G. & A., & Co.			1	1	0	Hooper, Miss A. M., Bristol.			2	
Herring, Miss J. E.			1	0	0	Hooper, Miss E., Gloucester			0	
Herschell, Mrs., Westbourne						Hooper, Mrs. H., Blackheath			1	
Terrace			1	1	0	Hooper, T. W., Esq., Southsea			1	
Hertford, The Marquis of (1879)				10	10	0	Hope, Charles, Esq.			1
Ditto			2	2	0	Hope, Mrs. W. C., Bath (1873-80)			34	
Hetherington, John M., Esq. (1871)				115	10	0	Hopkins, Mrs., Northleigh			1
Hewett & Co., Messrs. J. D.			2	2	0	Hopkins, Miss R. (1873)				
Hewetson, Thos. Esq.			1	1	0	Hopkins, Rev. Canon.			1	
Ditto (1873-80)				6	6	0	Hopkins, Rev. F.			2
Hewett, W., Esq., Sydenham (1881)				5	0	0	Hopkins, The Misses, Not-			
Hewitt, The Misses, Lytham (1873-7)			500	0	0	tingham			5	
Heywood, E. S., Esq.			2	2	0	Hopkins, Joshua Scales, Esq. (1874)				
Hichens, A. K., Esq.			1	1	0	Hopkinson, Mrs., Ichester			2	
Hicke, Miss F., Bath			1	0	0	Hopton Chapel Sick and				
Hickes, Mrs. A. J., the late,						Funeral Society			3	
per Miss Hickes, Bath (1875)				100	0	0	Hore, Fred Fulford, Esq. (1880)			1
Hickman, Mrs. (1869-80)				12	11	0	Horn, Mr. J. E.			1
Hickman, Miss (1869-79)				15	15	0	Horniman, John, Esq.			1
Ditto			1	1	0	Horrockses, Miller, and Co.			2	
Higham, W. S., Esq.			0	10	0	Horschitz and Co., Messrs.			1	
Hilhouse, Messrs. R. and						Horton, Rear-Admiral W.			1	
Sons			2	2	0	Horton, T. E., Esq.			3	
Hilhouse, Miss.			0	10	6	Hotchkis, John, Esq.			1	
Hilhouse, Miss Harriet			0	10	6	Hotham, Beaumont, Esq.			1	
Hill and Sons, Messrs. J.			1	1	0	Hotham, The Hon. Lady			2	
Hill, F., Esq., Hampstead			1	0	0	Hovell, J. R., Esq. (1872-81)				
Hill, Jas. D., Esq.			3	3	0	Hovenden, F. P., Esq. (1872-81)			280	
Hill, Lord Arthur William			5	5	0	0	Howard, Dr., Sandycroft			1
Hill, Major			1	1	0	Howard, Geo., Esq., Palace				
Hillier, Miss M. A.			1	1	0	Green			2	
Hillier, W. G., Esq.			2	0	0	Howard and Escombe, Messrs. (1879)			10	
Hillman, Mrs. Clark			1	0	0	Howson, F. J., Esq.			1	
Hills, A. F., Esq., Redleaf			2	2	0	Hoyland, J., Esq., Brierley			1	
Hills and Underwood, Messrs.			1	0	0	Hubbard, Colonel C. J.			1	
Hills, F. C., Esq., Deptford			1	1	0	Huddersfield Branch (1880)				
Hills, F. Ernest, Esq., Redleaf			2	2	0	Hudson, Mrs. W.			1	
Ditto (1880)				15	0	0	Hudson, Thos., Esq.			1
Hilton, Anderson, and Co.,						Hughes, Miss, East Bergholt			1	
Messrs.			0	10	6	Hughes, H., Esq., Edge Hill (1880)				
Hilton, Jas., Esq., Shawhall			1	1	0	Ditto			0	
Hindley, W. H., Esq.			1	1	0	Hughes, W., Esq., Meole			1	
Hinkley, John, Esq.			1	1	0	Hull Branch (1881)				
Hirsch, J. F. Esq.			0	10	0	Hunter, G., Esq.			1	
Hoblyn, Jas., Esq. (1869-80)					10	0	Hunter, John & Co., Messrs.			2
Hobson, Chas., Esq., Beverley			1	1	0	Hunter, Mark William, Esq. (1872-80)			34	
Hodd and Son, Messrs. R.			1	1	0				13	

	Ann. Subs.		Donations.			Ann. Subs.		Donations.	
	£.	s. d.	£.	s. d.		£.	s. d.	£.	s. d.
Hunter, The Misses Harriott & Isabella, in memory of their mother (1881)	100	0	0	0	James, Robert, Esq., Store Street . . . . .	1	1	0	
Hunwicke, F. S., Esq. . . . .	1	0	0		Jamieson, Hugh, Esq. (1878-80) . . . . .			12	12
Hurst, T. G., Esq. . . . .	0	10	6		Janson, R., Esq. . . . .	1	1	0	
Husey and Son, Messrs. R. A. . . . .	1	1	0		Jauncey, G. M., Esq. . . . .	2	2	0	
Hussey, R. H., Esq. (1859-69) . . . . .			20	0	Jeffery, Miss S. . . . .			1	0
Hutchins, Mrs., Portland Place . . . . .	1	0	0		Jenkin and Phillips, Messrs. . . . .	1	1	0	
Hutchinson, A., Esq. (1860-80) . . . . .	210	0	0		Jenkins, A. H., Esq. (1877) . . . . .			50	0
Hutchinson, Miss, Longworth (1881) . . . . .	25	0	0		Jenner and Sons, R. and H. . . . .	5	5	0	
Hutchinson, Miss C. (1863-80) . . . . .	29	0	0		Jenson, John, Esq. . . . .	1	1	0	
Hutchinson, Miss Fanny (1871-80) . . . . .	20	0	0		"Jehoiada Walters" (1869) . . . . .			10	0
Hutchinson, Miss, Great Mal- vern (1877-80) . . . . .	16	1	0		Jersey Swimming Club . . . . .	1	0	0	
Ditto . . . . .	1	1	0		Jobson, W. W., Esq. . . . .	1	1	0	
Hutchinson, Rev. J. R., B.D. . . . .	1	0	0		Johnson, Admiral. . . . .	1	0	0	
Huth and Co., Messrs. F. (1864-73) . . . . .	21	0	0		Johnson, F., Esq. . . . .	0	5	0	
					Johnson, David, Esq., Wrex- ham . . . . .	1	1	0	
I. W. (1877) . . . . .	10	0	0		Johnston, T., Esq. . . . .			2	2
FAnson, Charles, Esq. . . . .	1	1	0		Johnston and Son, Messrs., Botolph Lane . . . . .	1	1	0	
Image, Mrs., Mildenhall (1879-80) . . . . .	10	10	0		Johnston & Sons, Messrs. N., Seething Lane . . . . .	1	1	0	
Image, W. E., Esq. . . . .	1	1	0		Johnston, Sons, & Co., Messrs. E., Great St. Helen's . . . . .	1	1	0	
Imlach, R. W., Esq., Demerara . . . . .	1	1	0		Jones, C. W., Esq., Cheltenham . . . . .	1	1	0	
Ingilby, Sir William . . . . .	1	1	0		Jones, H. Cadman, Esq. . . . .	1	1	0	
Ingle, J. B., Esq. (1880) . . . . .	1	1	0		Jones, James, Esq., Ramsey . . . . .	1	1	0	
Inglis, J., Esq., Colchester . . . . .	1	1	0		Jones, Miss S., Cheltenham . . . . .	1	1	0	
Inglis, Mrs., Southend . . . . .	1	0	0		Jones, Mrs., Faversham (1878) . . . . .			25	0
Ingram, Mrs. Herbert . . . . .	5	5	0		Jones, Winslow, Esq., Exeter . . . . .	1	1	0	
Ingram, Rev. H. M. . . . .	1	0	0		Joy, Mr. W. J. . . . .	0	10	6	
"In Memoriam" (1875-6) . . . . .	150	0	0		Jubb, John, Esq., J.P. (1879) . . . . .			10	0
"In Memoriam" . . . . .	25	0	0		Jubb, Samuel, Esq., Batley (1875) . . . . .			10	0
"In Memory of a Sister who was an Annual Subscriber" (1877) . . . . .	50	0	0						
In Memoriam (1881) . . . . .	2	0	0		K. and E. C. (1873-81) . . . . .			35	0
In the beloved name and Memory of A. C. A. M. (1881) . . . . .	1	1	0		K. S. (1880) . . . . .			2	0
"InterCruces," per Mrs. Dalton (1876-81) . . . . .	11	11	0		K. W. (1878) . . . . .			20	0
Ipswich Branch (1881) . . . . .	35	13	0		"Kattey," per Mrs. Dalton (1880-1) . . . . .			3	3
Irby, Rev. The Hon. L. C. R. . . . .	1	1	0		Kaye, C., Esq., Northwich . . . . .	1	1	0	
Iredell, Chas., Esq. . . . .	1	1	0		Kaye, Miss E. F. . . . .	2	2	0	
Iredell, Major J. S. . . . .	1	0	0		Keal, Miss, Hereford . . . . .	1	0	0	
Ironmongers, Worshipful Com- pany of (1863-73) . . . . .			21	0	Keeling, Rev. Wm., B.D. . . . .	1	1	0	
Irving, Mrs. Colonel (1860-81) . . . . .	22	10	0		Keighley Branch (1881) . . . . .			32	8
Ivegil Church Temperance Society . . . . .	0	10	6		Keiller, William, Esq. . . . .	2	0	0	
Iver, Capt. . . . .	1	1	0		Kellock, Messrs. C. W., & Co. . . . .	1	1	0	
					Kelly, Mrs., Ealing . . . . .	1	1	0	
J. A. (1869) . . . . .	50	0	0		Kelso Branch (1880-1) . . . . .			21	10
J. B. S. . . . .	5	0	0		Kemble, Mrs. Henry . . . . .	10	10	0	
J. B. W. (1879) . . . . .	50	0	0		Kemble, William, Esq. . . . .	5	0	0	
J. C. (Birmingham) (1870) . . . . .	20	0	0		Kempster, John, Esq., and Mrs. . . . .	1	1	0	
Ditto . . . . .	2	2	0		Kennard and Co., Messrs. S. . . . .	2	2	0	
J. C. and J. S. C. (1869-80) . . . . .	20	0	0		Kennedy, Adm., C.B. . . . .	1	10	0	
J. C., per Mrs. Dalton (1880-81) . . . . .	3	3	0		Kent and Co., Messrs. G. B. . . . .	0	10	6	
J. E. D. . . . .	1	1	0		Kent, Henry, Esq., Shepherd's Bush . . . . .	1	1	0	
J. D. (1870-80) . . . . .	15	10	0		Kent, Mrs. Henry, Ditto. . . . .	1	1	0	
J. G. (1877) . . . . .	100	0	0		Kent, T. J., Esq. (1871) . . . . .			10	10
J. S. . . . .	10	0	0		Kent, Rev. Chas., Ludlow . . . . .	1	0	0	
J. S. (1878) . . . . .	10	0	0		Keppel, Admiral the Hon. Sir Henry, K.C.B. . . . .	1	1	0	
J. S. A. (1872-80) . . . . .	16	7	0		Kidd, Miss Pringle (1877-80) . . . . .			35	0
J. T. C. (1862-75) . . . . .	73	10	0		Kidd, Mrs., Skipton . . . . .	1	1	0	
J. W. (1878-81) . . . . .	40	0	0		Kiddle, Mrs. W. W. (1880) . . . . .			5	0
Jackson and Till, Messrs. . . . .	1	1	0		Kilvert, N., Esq., Manchester . . . . .	1	1	0	
Jackson, Miss (1881) . . . . .			1	1	Kinahan and Co., Messrs. . . . .	5	5	0	
Jackson, Miss H. A., Glo'ster . . . . .	1	1	0		King, G., Esq., Algiers . . . . .	2	2	0	
Jackson, Rev. J. . . . .	0	5	0		King, Mrs. A., Kentish Town (1872-81) . . . . .	5	0	0	
Jackson, W., Esq., Tower St. . . . .	1	1	0		King, Mrs., Algiers . . . . .	2	2	0	
Jacomb, Charles, Esq. (1868-72) . . . . .	21	0	0		King, Miss Louisa A. . . . .	1	0	0	
Jaffray and Co., Messrs. . . . .	5	0	0		King, Miss Sarah, Skipton . . . . .	1	0	0	
James, F., Esq., Kensington (1877) . . . . .	50	0	0		King, Messrs. H. S., & Co. . . . .	2	2	0	
James, Mrs., in memoriam Major C. D. James, H.M. 36th Regt. . . . .	5	0	0		Kinglake, Rev. F. C. . . . .	1	1	0	
					King's Lynn Branch (1881) . . . . .			32	18
					Kingstown Branch (1881) . . . . .			25	8
					Kinloch, Miss, Gilmerton . . . . .	1	0	0	



LIST OF DONATIONS AND ANNUAL SUBSCRIPTIONS.

307

	Ann. Subs.	Donations.
	£. s. d.	£. s. d.
Luokhunt, A. H., Esq., <i>Gamma</i> (1880)		0 10 0
Luscombe, Mrs.	2 0 0	
Lushington, Mrs. J. D.	2 0 0	
Luttrell, Miss, St. Katherine's (1861-70)	36 10 0	
Lutwidge, C. R. Fletcher, Esq.	1 1 0	
Lyall, George, Esq., <i>Deputy-Chairman</i>	2 2 0	31 10 0
"Lydia," Southampton (1874-80)	3 11 6	
Lyell, Miss C., Shielhill (1877-8)	20 0 0	
Ditto	1 0 0	
Lyell, The Misses (1871)	10 0 0	
Lytham Branch (18:0-1)	58 16 1	
M. (1863-81)	18 18 0	
M. (1873-4)	150 0 0	
M., per Messrs. Coutts & Co. (1867-80)	42 0 0	
M. A. F.	1 1 0	
M. A. L., per W. Arnott, Esq. (1872)	200 0 0	
M. B. (1881)	1 0 0	
M. B. T. W. (1869-75)	150 0 0	
Ditto (1877)	50 0 0	
M. C. M. (1869-73)	10 0 0	
M. E. C.	2 2 0	
M. E. I.	1 1 0	
M. E. W. E. C. (1877-80)	4 0 0	
M. M. M., In Memory of	10 0 0	
M. R.	5 0 0	
M. R., "A Thank-offering" (1872)	20 0 0	
M. S. S.	1 1 0	
M. T. (1865-75)	25 0 0	
M. T. (1880)	1 0 0	
Macan, Lieut.-Gen. H., C.B.	2 0 0	
MacAndrew & Co., Messrs. R.	2 2 0	
Macdonald, D., Esq., Larne (1875-9)	25 0 0	
MacDonald, The Misses	1 0 0	
Mackenzie, Colonel	2 2 0	
Mackenzie, Mrs. E.	2 2 0	
Mackeson, H. B., Esq.	1 1 0	
Mackie, Dr., Alexandria (1880)	1 0 0	
Mackinlay, Mrs., Regents Park	1 1 0	
Mackreth and Fosters, Messrs.	1 1 0	
Maclean, Maris & Co., Messrs.	1 1 0	
Macleod, Capt. R. B. E., R.N.	2 2 0	
Macmillan and Sons, Messrs.	1 1 0	
MacWhirter, John, Esq., and Miss MacWhirter (1871-80)	36 19 0	
Magrath, Rev. J. R.	0 10 0	
Mahon, R. H. D. Esq.	2 0 0	
Mahon, Mrs.	2 0 0	
Maingay, Mrs.	2 0 0	
Maitland, Capt. H. L., R.N.	1 1 0	
Major and Field, Messrs.	1 1 0	
Major, C. M., Esq.	1 1 0	
Malcolm, W. E., Esq.	1 0 0	
Mallam, Richard, Esq.	1 0 0	
Malby, Major E. P.	1 1 0	
Manchester Branch (1881)	237 6 10	
Manley, A. E., Esq.	2 0 0	
Mann, Mrs. Dixon	1 1 0	
Mannock, W. M. S. F., Esq.	1 1 0	
Mansel, J. C., Esq.	1 1 0	
Marcet, W., Esq., M.D. (1869-81)	15 15 0	
March, Lieut., Santander	0 10 0	
Margate Branch (1881)	20 0 0	
Margetts, Charles, Esq.	1 1 0	
Margetts, Mrs. H.	1 1 0	
Marine and General Mutual Life Assurance Society	10 0 0	
Mark Lane Life-boat Fund, <i>vide p. 320.</i>		
Markby, Alfred, Esq. (1873-81)	20 0 0	
Marks, J. C., Esq., Swansea (1881)	5 0 0	
Marriott, Capt. Edwd.	1 1 0	
Marryat and Sons, Messrs. J.	2 2 0	
Marryat, Charles, Esq.	1 1 0	

	Ann. Subs.	Donations.
	£. s. d.	£. s. d.
Marsh, Miss, Gloucester	1 0 0	
Marshall, A., Esq., Huntingdon	1 0 0	
Marshall, C., Esq., Huntingdon	1 1 0	
Marshall, Rev. E. (1854-77)		33 14 6
Ditto	1 0 0	
Marshall, J. M., Esq., Walingford	1 1 0	
Marter, Miss Mary B.	1 1 0	
Marter, Wm. Ingram, Esq.	1 1 0	
Martin, Capt. W. L., R.N.	1 0 0	
Martin, Dowager Lady (1880)	10 0 0	
Martin, E. M., Esq.	5 5 0	
Martin, J. Stapleton, Esq.	0 10 6	
Martin, J. B., Esq., Lombard St. (1873)	10 10 0	
Martin, Capt. Leslie (1873)	25 0 0	
Martin, Mrs., West Buckland	2 2 0	
Martin, The Misses, Bloomsbury (1869-75)	18 12 6	
Martin, T., Esq., St. Austell	1 1 0	
Martin, Rev. Glanville	1 1 0	
Martineau, Miss F., Clapham	2 2 0	
Martyn, Miss Jane A., Carthew	5 0 0	
Ditto (1879-80)		3 0 0
Mason, Miss, Audenshaw Hall	0 10 6	
Massey, Richard, Esq., Handforth	2 0 0	
Massy-Beresford, Very Rev. John M.	1 0 0	
Masterman, N., Esq.	5 0 0	
Mathew, Major, Wem.	2 2 0	
Mathews, G. H., Esq.	2 2 0	
Matthews and Luff, Messrs.	1 1 0	
Matthews, W. E., Esq. (1881)	10 0 0	
Matveiff and Co., Messrs.	1 0 0	
Maude, Capt. Hon. F., R.N.	1 1 0	
Maude, John, Esq., Clapham	1 1 0	
Maudslay, Chas., Esq.	1 0 0	
Maudslay, Henry, Esq.	11 0 0	
Maudslay, Son, and Field	2 2 0	
Maughan, Mrs. (1881)	1 0 0	
Mawe, F. E., Esq.	1 1 0	
Maxwell, Rev. E.	2 0 0	
Maxwell, Col. G. Shirley	1 0 0	
Maxwell, Lieut.-Gen. H. H., R.A.	10 0 0	
Maxwell, Mrs. (1880)	0 12 0	
Mayne, Adm. R. C., C.B.	1 1 0	
McArthur, Messrs. W. & A.	2 2 0	
McBayne, Miss Frances (1875-81)	14 0 0	
McCance, Henry J., Esq.	0 10 0	
McDonogh, Mrs., Molesey	2 2 0	
McDougall Bros., Messrs.	1 1 0	
McEwan and Co., Messrs. J.	1 1 0	
McHardy, Admiral	1 1 0	
McKerrell, Wm., Esq. (1863-72)	80 0 0	
McNeill, Sir J., G.C.B.	1 0 0	
Mead, Joseph B., Esq.	1 1 0	
Meadows, T., and Co., Messrs.	1 1 0	
Meares, Thos., Esq.	1 1 0	
Medlycott, Capt. M. B., R.N.	1 1 0	
Medwin, Dr. A. G.	1 1 0	
Mee, Mrs. J. H.	1 1 0	
Meggeson and Co., Messrs.	1 1 0	
Melhuish, Sons, & Co., Messrs.	1 1 0	
Meller, Capt. A., Ipswich (1874-9)	30 0 0	
Mellish, Henry, Esq.	1 1 0	
Mellish, Mrs. Leigh	1 1 0	
Mellor, the Hon. Justice (1878)	50 0 0	
Mellor, T. W., Esq., Q.C., M.P.	1 1 0	
Melrose Branch (1881)	16 17 0	
Melville, Lady F.	3 3 0	
Menars, Major H. (1863-69)	22 15 6	
Menzies, John, Esq., s.s. <i>Despatch</i> (1880)	1 0 0	
Merchant Taylors, Worshipful Company of (1857-76)	147 0 0	
Meredith, Miss Emma (1870-80)	22 5 9	







	Ann. Subs.		Donations.	
	£.	s. d.	£.	s. d.
Phillips, W. W., Esq. . . . .	1	1 0		
Phillimore, Capt. W. B. (1859-81) . .	215	10 0		
Phillimore, Vice-Admiral A. . . . .	3	0 0		
Phillipps and Graves, Messrs. . . . .	1	1 0		
Phillipotts, W. F., Esq. . . . .	1	1 0		
Pick, Edgar S., Esq. . . . .	1	1 0		
Pickering, Leonard, Esq. (1872) . . . .	200	0 0		
Pickernell Brothers, Messrs. (1880). . .	1	1 0		
Pickernell, F. C., Esq. (1880). . . . .	1	1 0		
Piel Branch (1881) . . . . .	30	0 0		
Pigeon, Henry, Esq. (1864-79) . . . . .	52	10 0		
Pigott, Assist.-Commissary General A. W. (1880). . . . .	2	2 0		
Pike, Mrs. Justine (1873-8) . . . . .	20	0 0		
Pilcher, R. A., Esq., Cromwell Houses . . . . .	1	1 0		
Pilgrim, C. H., Esq. . . . .	2	2 0		
Pirie and Co., Sir John . . . . .	2	2 0		
Pitt, Miss E., Ossington Street (1874-81) .	3	10 0		
Platt, Fredk., Esq., Oldham (1873) . . . .	90	0 0		
Platt, Owen, Esq., Manchester . . . . .	1	1 0		
Playne, Peter, Esq. (1860-79) . . . . .	95	0 0		
Plymouth Branch (1880) . . . . .	50	0 0		
Poë, Rev. J. Leslie . . . . .	1	1 0		
Pol, Paris, Esq. (1871) . . . . .	10	10 0		
Polidori, Miss E. (1880) . . . . .	2	0 0		
Poole, Miss E., Canonbury (1880) . . . .	1	5 0		
Port of Rochester Branch (1881) . . . . .	17	7 1		
Porteous & Senior, Messrs. . . . .	2	2 0		
Porter, Rev. C. F. . . . .	0	10 0		
Porter, Capt. H. R. . . . .	1	1 0		
Porthcawl Branch (1880) . . . . .	10	0 0		
Postans and Sons, Messrs. . . . .	0	10 6		
Pott, Norbury, Esq. (1881) . . . . .	5	0 0		
Potter, J. D., Esq. . . . .	2	2 0		
Powell, Messrs. T. J. and T. . . . .	1	1 0		
Poyer, J. P., Esq. . . . .	1	1 0		
Poynder, William, Esq., Hartnam Park (1874) . . . . .	500	0 0		
Prall, Z. E., Esq. . . . .	2	2 0		
Pratt, Mrs. H., Leamington (1863-80) . .	210	10 0		
Prescott, H. W., Esq. . . . .	2	2 0		
Preston, Miss L. F. M. . . . .	5	0 0		
Price and Pierce, Messrs. . . . .	5	5 0		
Price, Miss, Gloucester . . . . .	1	1 0		
Price, Mrs. Admiral (1880-1) . . . . .	20	0 0		
Priestley, E., Esq., barque <i>Aurora</i> (1880) .	0	10 0		
Priestley, Wm., Esq. . . . .	1	1 0		
Primrose, The Hon. B. F., C.B. . . . .	2	2 0		
Prince, John, Esq. . . . .	2	2 0		
Prince, Ogg, and Co., Messrs. . . . .	1	1 0		
Pritchard, J., Esq. . . . .	1	1 0		
Pritchard, Mrs., Astley Abbots . . . . .	1	1 0		
Prowett, N. H. E., Esq. (1862-80) . . . .	60	0 0		
Prowse, Capt G. J. W. . . . .	1	1 0		
Pryor, Miss, Walmer (1881). . . . .	1	0 0		
Psaila, Linga, Demerara . . . . .	1	1 0		
"Psalm 107" . . . . .	1	0 0		
Pugh, Miss, Leighton . . . . .	1	0 0		
Queensberry, Marquis of . . . . .	2	2 0		
Quick, Rev. R. H., M.A. . . . .	2	2 0		
R. B. and Co. (1867-81) . . . . .	112	7 0		
Rabbetts, Rev. F. D., M.A. . . . .	0	5 0		
Rackham, Willoughby, Esq. . . . .	2	2 0		
Radcliffe, Josiah, E-q., Bryn Dinarth (1881). . . . .	5	5 0		
Radcliffe, John, Esq., Furlane . . . . .	1	1 0		
Rahn and Co., Messrs. . . . .	2	2 0		
Ralli, A. M., Esq., Alexandria . . . . .	5	0 0		
Ralli Brothers, Messrs. . . . .	2	2 0		
Ralph, Rowland W., Esq. . . . .	1	0 0		
Ram, Rev. Stopford J. . . . .	1	0 0		

	Ann. Subs.		Donations.	
	£.	s. d.	£.	s. d.
Ramsay, Capt. John, R.E. . . . .	2	0 0		
Randell, Edward, Esq., Mark Lane . . . . .	1	1 0		
Randells, Howells, and Co. . . . .	1	1 0		
Randolph, Admiral G. G. . . . .	5	0 0		
Rawlins, Colonel, the late . . . . .	1	1 0		
Rawson, Miss, Tilney Street (1879) . . . .	100	0 0		
Rawson, Miss E., Nydd Hall (1880) . . . .	100	0 0		
Ray, Brisco, Esq., in memory of the late Richard Glaister, Esq. (1875) . . . . .	10	0 0		
Ray, Capt. H. R. (1873) . . . . .	10	0 0		
Ray, Rev. Henry, B.A. . . . .	1	1 0		
Raymond and Reid, Messrs. (1873) . . . .	50	0 0		
Reading Branch (1881) . . . . .	179	8 11		
Redfern, Alexander, and Co. . . . .	5	0 0		
Reece, Miss (1869-77) . . . . .	24	0 0		
Reeves, A., Esq. . . . .	0	5 0		
Regent's Canal Company . . . . .	3	3 0		
Reid, Alex., Esq., . . . . .	1	1 0		
Reid, P., Esq., Stock Exchange (1879) . . .	50	0 0		
Reinachs, Nephew, and Co. . . . .	0	10 6		
Reiss Bros., Messrs. . . . .	2	2 0		
Remington, Rev. T. M. . . . .	2	2 0		
Rendell, Jas. & Sons, Messrs. . . . .	1	1 0		
Reneau, Mr. & Mrs. R. P. W. . . . .	1	1 0		
Reynardson, Rev. G. B. (1865-72) . . . . .	15	0 0		
Ditto . . . . .	2	0 0		
Reynardson, Rev. J. B. . . . .	1	1 0		
Reynolds, Rear-Admiral . . . . .	0	5 0		
Reynolds, E. M., Esq. . . . .	1	1 0		
Reynolds, J., Esq. . . . .	0	10 6		
Rich, H. T., Esq., Hounslow . . . . .	0	6 0		
Richards, M., Esq. . . . .	1	1 0		
Richardson, Brothers and Co. . . . .	1	1 0		
Richardson, James G., Esq. . . . .	1	0 0		
Richardson, Jonathan, Esq. . . . .	1	0 0		
Richardson, Miss . . . . .	0	10 6		
Richardson, Miss, per Mrs. Dalton (1881) .	5	0 0		
Richardson, T., Esq. . . . .	1	0 0		
Rickards, Walter, Esq. (1879) . . . . .	10	0 0		
Rickett, Smith, & Co., Messrs. . . . .	1	1 0		
Ricketts, Miss Fredericka L. . . . .	1	1 0		
Riddell, Miss, Beaufort Grdns. . . . .	2	2 0		
Ridge, Henry, Esq., Stock Exchange (1876-81) . . . . .	14	14 0		
Ridgway & Co., Messrs. . . . .	2	2 0		
Ridpath, E., Esq. . . . .	1	1 0		
Rigaud, General (1880) . . . . .	2	2 0		
Rigge, H. F., Esq., . . . . .	1	1 0		
Riley, C., Esq. . . . .	1	0 0		
Rivaz, Charles, Esq. . . . .	1	1 0		
Rivington, Septimus, Esq. . . . .	1	1 0		
Roake, J. J., Esq., Anerley . . . . .	0	10 0		
Robartes, The Rt. Hon. Lord . . . . .	5	0 0		
Robartes, Hon. T. C. Agar, M.P. . . . .	2	2 0		
Roberts, C. W., Esq., . . . . .	1	1 0		
Roberts, Jas., Esq., Brockley . . . . .	1	1 0		
Roberts, Miss, Slade End . . . . .	0	10 6		
Robertson, Capt. G. M. . . . .	5	0 0		
Robertson, Graham, Esq., Cleveland Square (1880) . . . . .	10	0 0		
Robertson, Henry, Hull (1873) . . . . .	100	0 0		
Robertson, Henry, Esq., Glasgow (1880) . .	20	0 0		
Robertson, Mrs., Girtton (1863-79) . . . .	17	0 0		
Robertson, J. C. Esq. . . . .	1	0 0		
Robins, Miss, Woburn Place . . . . .	1	0 0		
Robins, Miss G., ditto . . . . .	1	0 0		
Robins, Mrs. Jane, Lee (1881) . . . . .	1	0 0		
Robinson, F. J., Esq., Chester St. . . . .	2	2 0		
Robinson, G., Esq., Skipton . . . . .	1	1 0		
Robinson, Lawson, Esq. . . . .	1	1 0		
Robinson, Miss Emma . . . . .	0	10 0		
Robinson, Rev. Henry (1874) . . . . .	10	0 0		
Robinson, Rev. T. B. E. . . . .	1	1 0		

	Ann. Subs.		Donations.	
	£.	s. d.	£.	s. d.
Robson, A., Esq., Stroud (1881) . . .	5	0	0	0
Rochdale Branch (1880) . . .	80	4	0	0
Rochester, Thomas, Esq. (1870) . . .	1000	0	0	0
Rockley, J., Esq., Boro' . . .	1	1	0	0
Rodgers, Mrs. (1881) . . .		1	1	0
Rodocanachi, Sons, and Co. . . . .	1	1	0	0
Rodwell, Mrs. Helen, Win- chester (1863-77) . . . . .		91	9	8
Rogers, Mrs., Westbourne Sq. . . .	1	1	0	0
Roget, Mrs., Maida Hill . . . . .	1	1	0	0
Röhrweger, J. C., Esq. . . . .		1	1	0
Rolle, The Hon. Mark . . . . .	10	0	0	0
Rolleston, Miss, Bath . . . . .		1	1	0
Rolt and Co., Messrs. Peter . . . . .	2	2	0	0
Ropes, W. H., Esq. . . . .		1	1	0
Rose, Alderman Sir W. A. . . . .		1	1	0
Rose, Mrs. A. M., Fulham . . . . .		1	1	0
Rosher, W. H. Burch, Esq. (1880) . .	10	10	0	0
Ross & Co., Messrs., Alexandria (1880)	0	10	6	0
Ross, Wm. Lewis, Esq. . . . .	2	2	0	0
Rosse, Dowager Countess of . . . . .		2	0	0
Rothery, H. C., Esq., M.A. (1880) . . . . .		25	0	0
Rothschild, Messrs. N. M., & Sons . . . . .	10	0	0	0
Rotton, Major G. . . . .	1	1	0	0
Routh, Miss A. . . . .	1	0	0	0
Routh, W. D., Esq. . . . .	5	0	0	0
Rowbotham, Dr. Wm. . . . .	0	10	6	0
Rowlandson, Miss Ann . . . . .	1	1	0	0
Rowley and Davies, Messrs. . . . .	1	1	0	0
Rowley, Col. Sir C., Bart. . . . .	2	2	0	0
Royal Harwich Yacht Club . . . . .	2	2	0	0
Royal Mail Steam Packet Co. (annual) . . . . .	10	0	0	0
Royal Yacht Squadron . . . . .	10	0	0	0
Rubie, J. P., Esq., Cowes . . . . .	1	1	0	0
Ruck Bros., Messrs. . . . .	0	10	0	0
Rudge, Miss, Southwick St. . . . .	1	0	0	0
Rudge, W. N., Esq. (1865-81) . . . .	52	10	0	0
Rufford, F. T., Esq. . . . .	1	1	0	0
Rugg, Mrs. J. S. . . . .	1	1	0	0
Runcorn Branch (1881) . . . . .	11	7	1	0
Ruskin, Professor, M.A. . . . .	5	0	0	0
Russell, Robt., Esq., s.s. Bellond (1880)	1	0	0	0
Rust, George J., Esq. . . . .	1	1	0	0
Rutherford Brothers, Messrs. . . . .	1	0	0	0
Rycroft, Chas. A. W., Esq. (1863-71)	25	0	0	0
Ryder, Admiral A. P. . . . .	1	0	0	0
S. C. H. (1859-77). . . . .	41	11	0	0
Ditto . . . . .	1	1	0	0
S. H. H., "Little Colonial" . . . . .	1	1	0	0
S. M., Kensington . . . . .	1	1	0	0
S. M. S. (1881) . . . . .	2	0	0	0
S. S., Manchester (1880) . . . . .	1	0	0	0
S. S., Tunbridge Wells . . . . .	2	2	0	0
S. Y. N. (1872-80) . . . . .	40	0	0	0
Sabel, Max, Esq. . . . .	1	1	0	0
Saddlers, Worshipful Com- pany of (1877-8) . . . . .	30	10	0	0
Sadler, Harrison, and Co. . . . .	2	2	0	0
St. Ives Harbour Comm" . . . . .	10	10	0	0
Saker, W. E., Esq. . . . .	2	2	0	0
Salisbury, Mrs. L. (1881) . . . . .		1	0	0
"Sally-forth," per Mrs. Dalton (1878-81)	14	14	0	0
Salmon, Capt. Henry Thomas (1875) . .	10	0	0	0
Salt, John Chas., Esq. (1879) . . . . .	10	10	0	0
Salters, Worshipful Company of 5 . . . .	5	5	0	0
Samuel, Mrs. J., Ryde (1881) . . . . .	2	0	0	0
Samuelson, Miss F. A. . . . .	0	10	6	0
"Sand," Alexandria (1880) . . . . .		0	10	0
Sanders, Saml., Esq., De Vere Gardens . . . . .	2	2	0	0
Sanders, F., Esq., Cross Keys . . . . .	1	1	0	0

	Ann. Subs.		Donations.	
	£.	s. d.	£.	s. d.
Sandwich, The Countess of (1872-80) . . .	70	0	0	0
Sandwich, The Earl of . . . . .	1	1	0	0
Sandys-Lumsdaine, Mrs. . . . . .	1	1	0	0
Santley, Charles, Esq. (1879) . . . . .	20	0	0	0
Sartoris, Alfred, Esq. . . . .	5	0	0	0
Sartorius, Sir G. R., Admiral of the Fleet, K.C.B. . . . .	1	1	0	0
Sassoon and Co., Messrs. D. . . . .	2	2	0	0
Saul, G. T., Esq., Bow . . . . .	1	1	0	0
Saunders, Mrs., Durham Ter. . . . .	2	2	0	0
Savage and Hill, Messrs. . . . .	2	2	0	0
Savory and Moore, Messrs. . . . .	3	3	0	0
Sawrey, Josh. H., Esq., (1881) . . . .		0	10	0
Saxe-Weimar, General H.S.H. Prince Edward of . . . . .		1	0	0
Scales and Rogers, Messrs. . . . .	0	10	0	0
Scarborough Branch (1881) . . . . .	90	0	0	0
Scarth, W., Esq., Highbury . . . . .	1	1	0	0
Schilizzi and Co., Messrs. (1867-74) . .	37	16	0	0
Schloss Brothers, Messrs. . . . .	0	10	0	0
Scholey, Mrs. . . . . .		1	1	0
Schroder & Co., Messrs. J. H. . . . .	2	2	0	0
Scorer, A., Esq. . . . .		1	1	0
Scott & Denham, Messrs. . . . .		1	1	0
Scott, E., Esq., Colchester (1869-80) . .	7	5	0	0
Scott, Patrick, Esq. . . . .	1	1	0	0
Scott, Rev. Canon . . . . .	1	1	0	0
Scott, Rev. M. R., M.A., & Miss 1 . . .	1	0	0	0
Scott, R. H., Esq., M.A. . . . .	1	1	0	0
Scrimgeour, Mrs., Highgate (1872-80) . .	46	15	0	0
Scrimgeour, Miss, Dorking . . . . .	1	0	0	0
Scriveners, Worshipful Com- pany of (1860-78) . . . . .	37	7	0	0
Seager, Charles H. Esq. (1872-8) . . . .	15	15	0	0
Seaton Carew Branch (1881) . . . . .	15	0	0	0
Sebag, Joseph, Esq. (1877) . . . . .	10	0	0	0
Seely, Chas., Esq., M.P. (1872) . . . . .	20	0	0	0
Selborne, The Lord . . . . .	2	0	0	0
Semple, A., Esq., Maida Vale . . . . .	1	1	0	0
Senior, J., Esq., Streatham . . . . .	2	2	0	0
Senior, Julian, Esq. (1877-9) . . . . .	31	0	0	0
Settle Branch (1880) . . . . .	109	4	4	0
Severn, J. P., Esq. . . . .	3	3	0	0
Sewell, Mrs., Brompton . . . . .	1	1	0	0
Sewell, W., Esq., Richmond . . . . .	1	1	0	0
Seyd and Co., Messrs. . . . .	1	1	0	0
Shackleton, Richard, Esq. . . . .	3	3	0	0
Shafto, Mrs. J. D. . . . .	1	0	0	0
Ditto in aid of Swanage Lifeboat (1875) . . . . .		50	0	0
Ditto (1881) . . . . .		50	0	0
Sharland, H. H., Esq. (1881) . . . . .	5	0	0	0
Sharp, A. M. Esq., Epworth . . . . .	1	1	0	0
Sharp, Sidney, Esq. . . . .	2	0	0	0
Sharpe and Co., Messrs. R. . . . .	1	1	0	0
Sharpe, Sutton, Esq. . . . .	3	0	0	0
Sharps and Wilkins, Messrs. . . . .	1	1	0	0
Shaw, Miss L. C. . . . .	0	5	6	0
Shaw, Rev. F. . . . .	1	1	0	0
Shaw, Savill, and Co., Messrs. . . . .	1	1	0	0
Sheffield Branch (1881) . . . . .	41	5	8	0
Sheepshanks, W., Esq. . . . .	1	1	0	0
Sheldon, Rev. J. (1881) . . . . .	10	0	0	0
Shepard & Co., Messrs. . . . .	2	2	0	0
Shepherd, Arthur, Esq. (1869-74) . . . .	41	0	0	0
Shepherd, Major Howell (1859-80) . . . .	50	0	0	0
Sherwood, Joseph, Esq. (1862-73) . . . .	15	15	0	0
Shewell, Rev. Frank, M.A. . . . .	1	1	0	0
Shiffner, Miss J. P. (1871-81) . . . . .	23	2	0	0
Shiffner, Mrs. . . . .	1	1	0	0
Shipp, T. P., Esq. . . . .	1	1	0	0
Short, F. B., Esq., Buckham (1878) . . . .	10	0	0	0
Short, Mrs., Hastings . . . . .	2	0	0	0
Ditto (1869-75) . . . . .	55	0	0	0
Shuckburgh, Sir Geo., Bart. . . . .	1	1	0	0
Ditto, Contribution Box . . . . .	18	6	5	0



## LIST OF DONATIONS AND ANNUAL SUBSCRIPTIONS.

313

	Ann. Subs.		Donations.			Ann. Subs.		Donations.			
	£.	s. d.	£.	s. d.		£.	s. d.	£.	s. d.		
Strahan, W. S., Esq., Buxton	2	2	0		Taylor, Rev. Alfred R.	1	1	0			
Strange, Mrs. Mary Ann	1	1	0		Taylor, Wm., Esq., Lee	1	1	0			
Streetfield, R. J., Esq.	5	5	0		Taylor, W., Esq., Jun., Lee	1	1	0			
Street, George, Esq.	1	1	0		Taylor, W. R., Esq.	0	10	0			
Strickland, A. E. C., Esq.	1	1	0		Teevan, Major G. J.	1	0	0			
Stripling, Miss, Lichfield	2	0	0		Teignmouth Branch (1880)			30	0	0	
Ditto (1879)			25	0	0	Temperleys, Carter, & Darke	1	1	0		
Stuart, Colonel	2	0	0		Tempest, J., Esq., Derby	1	1	0			
Stuart, Geo., Esq. (1865-80)			45	0	0	Templer, R. B., Esq.	1	1	0		
Stucley, Lieut.-Colonel	1	0	0		Terry, John, Esq.	3	3	0			
Sturrock, Archibald, Esq.	2	2	0		Tesdorpf & Co., Messrs. A.	2	2	0			
Stutfield, W., Esq.	1	1	0		Tetley and Co., Messrs. J.	0	10	0			
Stutfield, Mrs. (1867-76)			45	0	0	Tetley and Son, Messrs. E.	1	1	0		
Suart, Mrs. Alfred	1	0	0		Tetley, The Misses, Oaklands (1869-80)			80	0	0	
Sugden, Richard, Esq.	1	1	0		Thames & Mersey Marine Insurance Co., Royal Exchange	5	5	0			
Sugg, Henry, Esq., Reading	1	1	0		Thomas, Capt. Montague, R.N. (1868-81)	64	0	0			
Sullivan, Capt. T. B. M., R.N.	1	0	0		Thomas, Charles, Esq.	0	10	6			
Summerson, T. R., Esq.	0	7	6		Thomas, D. C., Esq.	0	10	6			
Surr, Watson, Esq.	1	1	0		Thomas, John C., Esq.	1	1	0			
Surrey Commercial Dock Co.	5	5	0		Thomas, Mr. W., Caerphilly	0	10	0			
Sutherland, H., Esq., Dulwich	1	1	0		Thompson, Alex., Esq. (1880)			0	12	6	
Sutherland, His Grace the Duke of	5	0	0		Thompson, Adam, Esq.	1	1	0			
Sutherland, R., Esq., Egham	5	0	0		Thompson, Vice-Adm. T. P.	1	0	0			
Swansea Branch (1880)			50	0	0	Thompson, Henry, Esq.	1	1	0		
Swanzy, Messrs. F. and A.	1	1	0		Thompson, Messrs. W. J. & H.	2	2	0			
Swinburne, Sir J., Bart., F.R.S.	5	0	0		Thorley Rectory, Bishop's Stortford	2	2	0			
Sx B.	0	10	6		Thorngate, W., Esq. (the late), Trustees of	80	0	0			
Sykes, J., Esq.	2	2	0		Threlfall, Chas., Esq. (1867-9)			20	10	0	
Sykes, Miss, Bristol	1	1	0		Ditto	5	5	0			
Symonds, F., Esq., M.A.	3	3	0		Threlfall, Mrs.	1	1	0			
Symonds, Wm. Thos., Esq.	2	2	0		Thresher, Capt. W. (1871-80)			15	15	0	
					Ditto	2	2	0			
T. H. N., Thanksgiving for a safe voyage (1870)			16	0	0	Thwaites, D., Jun., Esq. (1868-70)			15	0	0
T. J. K. (1871-81)			15	15	0	Tidd, Frederick A., Esq. (1870)			10	10	0
T. J. M. (1877-81)			70	0	0	Tidd, Walter R., Esq. (1873)			10	10	0
T. J. S.	0	5	0		Tillard, Edward, Esq.	1	1	0			
Taddy and Co., Messrs.	3	3	0		Tindall, Riley, & Co., Messrs.	1	1	0			
Taitte, Charles, Esq.	1	1	0		Tindall, W. H., Esq.	1	1	0			
Talbot, Lady	1	1	0		Tinley, Mr. R. R.	0	10	0			
Tallow Chandlers, The Worshipful Company of (1869-70)			21	0	0	Tisdall, Mr. Sidney, and Friends (1874-80)	8	15	0		
Tanqueray & Co., Messrs. C.	2	2	0		Toke, Major	1	1	0			
Taplin, Thomas, Esq., the late (1859-73)			26	5	0	Tollemache, Hon. Algernon Grey (1867-77)			250	0	0
Tapling and Co., Messrs. Thos.	2	2	0		Tomkinson, Thomas, Esq. (1864-74)			115	0	0	
Tapp, Mrs. Denning, Bristol	1	1	0		Toms and Co., Messrs.	0	10	0			
Tapper, A. A., Esq.	1	1	0		Toppin, Miss, Putney	1	1	0			
Tarleton, Adm. Sir Walter, K.C.B. (the late)	1	1	0		Torquay Branch (1831)			90	0	0	
Turner, A. T., Esq.	2	2	0		Towgood, Alfred, Esq.	1	1	0			
Turner, E. T., Esq.	1	0	0		Towgood, Edw., Esq.	2	2	0			
Turner, G. Edward, Esq.	1	1	0		Townend and Co., Messrs. T.	1	1	0			
Turner, H. T., Esq.	1	0	0		Toynbee, Capt. H.	1	1	0			
Turner, Miss C. T.	0	10	0		Treherne, H., Esq., Ashperton	0	10	0			
Turner, Miss L. T.	0	10	0		Treherne, Mrs. Hy., ditto	0	10	0			
Tarratt, Josh., Esq.	2	2	0		Trigg, Mrs. James	0	10	6			
Tarratt, Mrs., Ashford Hall (1877)			300	0	0	Trimmell, Mrs. E. (1881)			2	0	0
Tassell, Mr. F.	0	5	0		Trinder, Anderson, & Co.	3	3	0			
Tate, Miss C. E.	1	1	0		Trotter, Mrs., Thurloe Sq.	5	0	0			
Tatham, C. N., Esq. (1881)			1	1	0	Ditto (1881)			10	0	0
Tattersall, John, Esq., one year's maintenance of a Life-boat station (1877)	70	0	0		Trotter, William, Esq. (1872-81)			60	0	0	
Tatton, Lees W., Esq., Manchester	1	1	0		Trower, Alfred, Esq., The late (1878-9)	10	10	0			
Tatton, Mr. Samuel, Chorley	0	10	0		Troyte, C. A. W., Esq.	1	1	0			
Taunton, Miss, in memory of the late Lady Taunton	1	1	0		Tryon, Hon. Mrs.	1	0	0			
Tawke, A., Esq., and Mrs. Tawke, The Lawn, Rochford	0	10	0		Tudor, E. O., Esq.	1	1	0			
Taylor and Sons, Messrs. J.	1	1	0		Tudor, Henry, Esq.	1	1	0			
Taylor, Charles, Esq., Manningtree	1	1	0		Tudor, Mrs. W. Langley	1	1	0			
Taylor, J. D., Esq. (1865-79)			85	0	0	Tufton, Sir Henry J., Bart.	3	3	0		
					Tulloch, General, R.A.	1	1	0			
					Tulloch, Miss	1	1	0			
					Tupp, Mr. J., Tottenham Court Road (1874-8)			7	4	0	
					Turle, James, Esq., M.D.	1	1	0			
					Turle, Mrs.	0	10	6			



	Ann. Subs.		Donations.			Ann. Subs.		Donations.	
	£.	s. d.	£.	s. d.		£.	s. d.	£.	s. d.
Weston, W., Esq., Bramley (1880)			10	0 0	Wilson, Lieut. William, R.N. (1874-81)	27	0 0		
Whalley, F. R., Esq. . . . .	2	2 0	10	10 0	Wilson, Miss, Maidenhead (1878)	10	0 0		
Whalley, John, Esq., Blackburn (1881)			10	10 0	Wilson, Miss H. J. . . . .	4	4 0		
Whateley, Mrs. George, Sacombe Lodge . . . . .	1	1 0			Wilson, Rev. Robert (1858-75)	102	10 0		
Wheeler, E., Esq., Stock Exch.	1	1 0			Wilson, Wm., Esq., Highbury	1	1 0		
Wheeler, George, Esq. . . . .	1	1 0			Winckworth, Lewis, Esq. . . . .	2	2 0		
Wheeler, H. S., Esq. . . . .	1	1 0			Windley and Barwick, Messrs.	2	0 0		
Whichcote, Mrs. Francis. . . . .	2	0 0			Windsor, Miss E. . . . .	0	10 0		
Whish, Admiral (1879) . . . . .			25	0 0	Wing, Thomas, Esq., Bosmore Hall (1875) . . . . .		10 10 0		
Whitaker, T. S., Esq. . . . .	1	1 0			Winn, W., Esq. (1860-80) . . . . .	105	0 0		
Whitby, Messrs. W. and G. . . . .	1	1 0			Winter, The Misses M. E. and E. (1869-81) . . . . .	27	6 0		
White Brothers, Messrs. . . . .	1	1 0			Wire, Travers B., Esq. . . . .	1	1 0		
White, J., Esq., Gt. St. Helens	1	1 0			Wire, Mrs. Travers B. . . . .	1	1 0		
White, John, Esq., Cowes . . . . .	1	1 0			Wise, H. C., Esq. . . . .	1	1 0		
White, Miss M. C., Brighton (1868-81)	17	10 0			Wise, Richard, Esq., St. Ives	1	1 0		
Whitehead, T. S. & Co., Messrs.	0	10 6			Witherby, Arthur, Esq., Lee (1880)	5	5 0		
Whiteley, George, Esq. (1871) . . . . .			50	0 0	Wolverhampton Branch (1881)	36	19 0		
Whiteman, Stephen, Esq. . . . .	1	0 0			Wood, Chas., Esq., East Street	1	1 0		
Whiter, Fredk. W., Esq., Birmingham . . . . .	1	1 0			Wood, F., Esq., Sidcup . . . . .	0	10 6		
Whiteron, J., Esq. (1869) . . . . .			11	0 0	Wood, J. Garthorne, Esq. . . . .	5	0 0		
Whiting, R. M. & H., Messrs.	0	10 0			Wood, Mrs. B., The Lodge (1854-76) . . . . .	235	0 0		
Whyte, Capt. W. H., R.N. . . . .	1	0 0			Woodcock, Henry, Esq., Bolnore . . . . .	2	2 0		
Wickens, Rev. H. (1861-9) . . . . .			35	10 0	Woodhouse, Rev. E. . . . .	0	10 0		
Wieting and Richter, Messrs., Demerara . . . . .	1	1 0			Woodley & Co., Messrs. (1881)	5	5 0		
Wilcox, Robt. M., Esq. (1881)			2	2 0	Woodroffe and Westrope, Messrs. . . . .	1	1 0		
Wilde, Spencer C., Esq. . . . .	1	1 0			Woodruff, Rev. Thos., M.A. . . . .	1	1 0		
Wilkinson, J. R., Esq. . . . .	1	1 0			Woods, Mrs. H. T. . . . .	1	1 0		
Wilkinson, Mrs. M. D. P., "In remembrance of a dear friend" (1874) . . . . .			10	0 0	Woolcott, Wm., Esq. . . . .	1	1 0		
Wilkinson, O. R., Esq. . . . .	1	1 0			Woolfe and Son, Messrs. . . . .	2	2 0		
Willans, Mrs. S. . . . .	1	1 0			Woolley, Miss (1877) . . . . .	15	0 0		
Williams, Admiral W. J. (1871-81)	22	0 0			Worcester Branch (1880) . . . . .	35	4 4		
Williams, J., Esq., Mark Lane	0	10 0			Workington Branch (1880) . . . . .	23	1 6		
Williams, O. J., Esq. . . . .	1	1 0			Worsley, Rev P. R., M.A. (1876-80)	5	0 0		
Williams, Robert, Esq., Wrexham . . . . .	0	10 6			Worthing Branch (1881) . . . . .	10	0 0		
Williams, R. B., Esq., Hyde Vale (1871-80) . . . . .			5	0 0	Wright, Henry E., Esq. . . . .	2	2 0		
Williamson, A. D., Esq., Haxby (1861-73) . . . . .			31	15 6	Wright, J. W., Esq. s.s. <i>Ganos</i> (1880)	0	10 0		
Willimott, Miss E. A. . . . .	1	1 0			Wrigley, Miss, Holbeck . . . . .	1	0 0		
Willimott, W., Esq. (1877) . . . . .			21	0 0	Wyndham, Mrs., Salisbury . . . . .	1	1 0		
Willink, W. W., Esq. . . . .	2	2 0			X. L. V. . . . .	1	0 0		
Willis, Com. G. H. R., R.N.	1	0 0			X. Y. Z. (1867-75) . . . . .	215	0 0		
Willis, H. B., Esq. . . . .	1	1 0			Yates, Capt. R. B. . . . .	1	1 0		
Willis, Henry, Esq. (1876) . . . . .			10	10 0	Yates, J., Esq., Rotherham . . . . .	0	10 0		
Willis, J. E., Esq. (1864-70) . . . . .			65	0 0	Yates, Mrs., per N.B. Whitby, Esq. (1881) . . . . .		5 0 0		
Willis, Major W. . . . .	1	1 0			York Branch (1881) . . . . .	63	4 0		
Willis, Mrs. . . . .	1	1 0			Youle, F., Esq. (1863-73) . . . . .	55	5 0		
Wills, Mrs., Shaftesbury . . . . .	0	10 0			Young and Lark, Messrs. . . . .	1	1 0		
Willmott, E. W., Esq. . . . .	1	1 0			Young, Capt. Sir A. W. . . . .	1	1 0		
Wilson, Capt. J. E.M., R.N.	1	1 0			Zulueta and Co., Messrs. . . . .	1	1 0		
Wilson, John R., Esq. . . . .	1	1 0							
Wilson, J., Esq., Hackney . . . . .	1	1 0							

## LIST OF GENERAL COLLECTIONS, ETC., 1880-81.

	£.	s.	d.		£.	s.	d.
Aberford Alms Box, one month, per Rev. Canon Eden . . . . .	1	10	0	Hutchinson, H. N., Esq., Rugby, col. by Johnson, Adml., col. by (Annual) . . .	1	11	0
Adderley Church, offertory, per Rev. A. Corbet, M.A. . . . .	6	1	6	Johnson, Miss, Wrexham, collected by Johnson-Smyth, Miss Lillie, Donnybrook, collected by . . . . .	2	5	0
Arthur Hill Life-boat Fund, per G. B. Hill, Esq. (additional). . . . .	6	0	0	Kensington Town Hall, surplus funds from Subscription Balls at, per Henry C. Baggallay, Esq. . . . .	14	8	0
Ashford, Alexander Academy, Scholars and Family of Mr. T. H. Vie . . . . .	1	1	0	Licensed Victuallers' School, Miss English, Matron, and Officers, and Children, in aid of <i>Licensed Victualler</i> Life-boat . . . . .	5	0	0
Barrett, E. J., Esq., Camberwell, collected by . . . . .	1	10	0	Little Glenham Church, collection at, per Rev. R. H. King, M.A. . . . .	1	8	5
Biddestone, near Chippenham, proceeds of Penny Readings, per Rev. J. Emra Bird, Mrs. G. A., Putney, collected by Brampton Bryan, Lecture at, per Rev. Frank Sheffield . . . . .	2	2	6	Maidstone, portion of offertory at H.M. Prison, per Rev. A. H. Harrison . . . . .	1	0	0
Bromley, Mrs. W., Penge, collected by Brompton Sunday Schools, collected at, per Rev. E. Walker . . . . .	10	12	0	Martin, Lieut. Leslie, collected by . . . . .	1	0	0
Caister Church, offertory in, per Rev. E. G. H. Murrell . . . . .	1	10	0	Netheravon Church, collection per Rev. W. H. Heaven, M.A. . . . .	1	3	3
Chatham, H.M. Dockyard, col. from the workmen in, per Mr. J. Higgin . . . . .	7	11	9	Newton-by-Sudbury, share of harvest thank-offering, per Rev. Reginald Smith . . . . .	1	10	3
Chilton Parish Church, portion of Harvest Festival collection, per Rev. Herbert Smith, M.A. . . . .	1	0	0	North Leigh Church, offertory, per Rev. R. W. Fiske . . . . .	3	18	1
<i>Christian, The</i> , Readers of, per Messrs. Morgan and Scott . . . . .	6	12	0	Nottingham Amateur Dramatic Club, Entertainment by, per A. Vickers . . . . .	0	5	0
Ciare, Miss Constance Leigh, Hoylake, collected by . . . . .	1	15	6	Nunn, Rev. F. J., Maidenhead, pupils of . . . . .	1	1	0
Clifton Down Hotel, collected from Visitors, per Lieut. R. H. Eyre, R.N. Collected by a Child after reading Mr. Ballantyne's Life-boat Book . . . . .	1	3	6	Odd Fellows, Independent Order of (M.U.), Loyal Hope of Bloomsbury Lodge . . . . .	1	1	0
Cromer Church, collection at, per Rev. Frederic Fitch, M.A. . . . .	13	3	6	Ditto, Hope Lodge, Southampton . . . . .	1	1	0
Crowl, Mr. J., collected by . . . . .	1	2	0	Ditto, Nelson Lodge, Norwich (Annual) . . . . .	2	2	0
Dalston Junction Sunday Schools, per F. Clements, Esq. . . . .	1	1	0	Ditto, Prosperity Lodge, Norwich (Annual) . . . . .	1	1	0
Demerara, West Indies, collected by M. R. O'Maley, Esq. (Annual) . . . . .	11	11	0	Oldham, col. at Young Men's Bible class, per Rev. A. J. J. Cachemaille . . . . .	0	7	6
Elvetham Church, offertory on Christmas Day, per Rev. W. Gill . . . . .	6	5	0	Oxford Gas Works employes, per J. Eldridge, Esq. . . . .	3	6	0
Fazakerley, Miss, Denbigh, collected by Fines of a Mutual Improvement Society, per Miss Stolterfoht . . . . .	1	3	0	Park Chapel Boys' Sunday School, per Mr. Ernest Wench . . . . .	1	10	6
Freemasons, Macdonald Lodge, No. 1216, per Captain Arthur Styan, Treasurer . . . . .	5	5	0	Perth, Middle Parish Sabbath School, collection at, per Rev. Mr. Brunton and Mr. D. Galloway . . . . .	2	4	0
Ditto, Leigh Lodge of, in aid of <i>Lady Leigh</i> Life-boat (Annual) . . . . .	1	1	0	Pin-cushions, Patent Life-boat, portion of profits by their sale, per Miss M. A. Rich, Neston . . . . .	0	16	10
Ditto, Prosperity Lodge 65 . . . . .	2	2	0	Railway Clearing House, collected at, per Hy. Turner, Esq. . . . .	7	13	0
Ditto, Temperance Lodge 739 (Ann.) . . . . .	2	2	0	S. Michael's Life-boat Fund, per Rev. G. F. Prescott, M.A., towards support of Kessingland No. 2 Life-boat . . . . .	20	14	4
Ditto, Lodge 809, Wisbeach (Ann.) . . . . .	2	2	0	Shaboe, Rev. D., in aid of Masonic Life-boat . . . . .	2	2	0
Girvan, St. John the Evangelist Church, collected at an evening service from a congregation of working men, per Rev. W. R. Gallacher . . . . .	1	1	3	Smith, Rev. H., Southampton, collected at Bible Class . . . . .	0	5	0
Hadnall Church, near Shrewsbury, per Rev. Brooke C. Mortimer . . . . .	9	5	8	Stubton Church, offertory at, per Rev. P. R. Worsley, M.A. . . . .	2	0	0
Harby Church, col. on 19th Sunday after Trinity, per Rev. M. O. Norman . . . . .	1	10	8	Temple, Mr. M. H., Leeds, further on account of his Life-boat fund . . . . .	4	0	0
Holloway, St. Anne's Church, collection at, per Rev. W. H. Chambers . . . . .	13	6	6	Tilney, col. at All Saints' Church, per Rev. S. J. Phillips . . . . .	3	10	0
"Hop Bitters" World's Regatta, The Managing Committee of, moiety of surplus funds, per C. H. Ashby, Esq. . . . .	9	3	6	Do., do., St. Lawrence Church, do. . . . .	0	14	0
Hotham, F. W., Esq., Buckland Rectory, collected by . . . . .	3	5	0	Walton-on-the-Naze Life-boat Fund, per Capt. Gibbs . . . . .	17	11	0
				Waterfield, The Misses, Shrewton, col. by West, Miss, Woburn . . . . .	0	12	4
					1	1	0



## CONTENTS OF PILLAR AND OTHER CONTRIBUTION BOXES, 1880-81.

(In addition to those included under "SEAMEN'S COLLECTIONS.")

	£.	s.	d.		£.	s.	d.
Alexandra Palace Pillar Box . . . . .	1	6	7	London Bridge Railway Station . . . . .	4	0	10
Allen, Ashton C., Esq., Park Crescent	7	16	9	London Docks Pillar Box, per Mr.			
Basingstoke Railway Station, per J.				Cox . . . . .	0	19	7
Harvey, Esq. . . . .	0	10	0	Macclesfield, per Mr. T. R. Comberbach	1	0	6
Buncey, Mr. W. F., Rochester Row . . . . .	0	7	6	Maitland, J. N., Esq., Kensington . . . . .	2	16	6
Bremhill Free Library, per J. Vines, Esq.	0	5	0	"Margaret" Box, per Mrs. Etherington			
Conlon, F. P., Esq., Lincoln . . . . .	0	9	5	Smith, in aid of <i>Joseph Sykes</i> Life-			
Cox and Son, Messrs., Chaucery Lane . . . . .	1	0	8	boat at Uppang . . . . .	3	3	0
Crystal Palace Pil. Boxes, per Dr. Price	6	13	2	Martin, J. S. Esq., Montague Place . . . . .	1	10	0
Dashwood, C. G., Esq., Park Street . . . . .	3	0	0	Moss, Frank, Esq., Croydon . . . . .	0	18	9
Day and Son, Messrs. R., Cork . . . . .	0	6	2	Newnham, Miss H. K., Corsham . . . . .	1	0	0
East India Docks Pillar Box, per Capt.				Old Bell Hotel, Holborn, per Miss			
Marrable . . . . .	0	10	7	Bunyer . . . . .	2	2	6
Farrar, Miss, Brixton . . . . .	2	0	6	Payne, Miss, Bewdley . . . . .	1	3	0
Fenchurch Street Railway Station . . . . .	4	10	2	Ramsgate Pillar Box, per Captain			
Geary, Mr. W. N., Cadogan Place . . . . .	2	0	0	Braine . . . . .	13	3	0
Greet, Miss, Old Charlton . . . . .	0	6	7	Do. Contribution Boxes at Hotels, &c.	2	16	7
Gore, Mrs., Brighton . . . . .	1	13	0	Ramsgate—Contribution Box at South-			
Hancocks, Alfred, Esq., Wolverley . . . . .	4	12	9	Eastern Railway Station . . . . .	0	10	0
Harris, Master Josh. C., Calne . . . . .	0	15	0	Robinson, H. P., Esq., Clapham . . . . .	2	2	0
Holden, W. S., Esq., Liverpool . . . . .	0	11	10	Skinner, Mrs., Cambridge . . . . .	3	1	6
Horn, Mr. J. E., West India Dock Road	0	11	0	Southampton Pillar Box, per C. A.			
Isle of Man Banking Company . . . . .	0	5	1	Jellicoe, Esq. . . . .	2	12	6
Jeffery, Miss C., Walworth . . . . .	0	5	6	Tait, Mr. J. W., Mile End . . . . .	0	5	6
Jersey, Pillar Box, per J. Sullivan, Esq.	2	2	0	Trowbridge, Mr. T., Holloway . . . . .	0	5	6
Jervoise, Miss Ethel, Herriard . . . . .	0	12	0	Tupp, Mr. John, Tottenham Court			
Johnson, Mrs., Hoddesdon . . . . .	16	5	10	Road . . . . .	1	1	0
Keal, Miss, Hereford . . . . .	0	12	6	Tyrrell, Lewis, and Co., Messrs., Al-			
Keswick Hotel, per the Misses Frank				bany Court Yard . . . . .	0	9	0
and Coles . . . . .	1	5	0	Victoria Railway Station . . . . .	4	4	3
Kirkaldy, Master D. D., Wimbledon . . . . .	1	1	0	Waddington, H. H., Esq., Chorlton-			
Lambeth Police Ct., per G. A. Bird, Esq.	1	0	0	cum-Hardy . . . . .	1	1	0
Liverpool Street, Great Eastern Rail-				Waterloo Railway Station . . . . .	2	6	7
way Station . . . . .	3	18	9	Watson, Thomas, Esq., Row . . . . .	1	10	0

## COLLECTIONS FROM SEAMEN AND OTHERS, BY COLLECTORS OF CUSTOMS, BY THE AGENTS OF THE SHIPWRECKED MARINERS' SOCIETY, AND BY OTHERS, IN 1880-81.

	£.	s.	d.		£.	s.	d.
Alexandria, collected at, per H. Main,				Exeter, per G. Foyes, Esq. . . . .	1	0	0
Esq. . . . .	44	0	6	Fowey, per Emra Holmes, Esq. . . . .	2	0	0
<i>Austrian</i> , s.s., collected on board, per				<i>Franziska</i> , collected in pennies on board			
Captain Barrett . . . . .	1	10	0	the yacht, per P. R. Brewis, Esq. . . . .	2	2	0
Belfast, per E. Foyster, Esq. . . . .	7	3	0	Glasgow, per T. J. Graham, Esq. . . . .	81	0	0
Belfast Mercantile Marine Office, per				Glasgow, per Messrs. Campbell & Hall	0	15	6
A. Dent, Esq., R.N. . . . .	6	18	9	Gloucester, per T. Cumming, Esq., and			
Blyth, per Mr. J. Robinson, Jun. . . . .	5	2	9	W. H. Stewardson, Esq. . . . .	3	4	1
Board of Trade Shipping Office, Poplar,				Grangemouth, per A. Richardson, Esq.	4	6	4
per Capt. Furnell & Jas. Swain, Esq.	8	2	3	<i>Grecian</i> , s.s., collected on board, per			
Boston, per J. E. Ridlington, Esq. . . . .	0	13	6	Captain Le Gallais . . . . .	1	14	9
Bristol, per G. C. Whitwell, Esq. . . . .	2	16	0	Greenock, collected in, per Rev. Donald			
<i>Buenos Ayrean</i> , s.s., collected on board,				Brothie . . . . .	0	14	0
per Captain McLean . . . . .	0	11	11	Greenock, per Thos. Avery, Esq. . . . .	0	13	0
Coleraine, per H. de Manilped, Esq. . . . .	1	2	0	Hamburgh, collected by Jas. Hitchins,			
<i>Conway Castle</i> , s.s., per Captain E.				Esq. . . . .	0	5	3
Jones, R.N.R. . . . .	0	6	0	<i>Hawke</i> , barque, Captain J. Wilson and			
Cork, per R. T. Dolan, Esq. . . . .	0	17	1	Crew . . . . .	0	18	0
Cork Mercantile Marine Office, per R.				<i>Himalaya</i> , H.M.S., Canteen Fund, per			
Singe, Esq. . . . .	0	17	5	Lieut. C. B. Neate, R.N. . . . .	17	0	0
Cowes, per H. C. Mauers, Esq. . . . .	1	12	3	Hull, per J. W. Day, Esq. . . . .	10	0	0
Dublin, per The Superintendent . . . . .	1	10	0	Ipswich, per I. Walker, Esq. . . . .	1	1	9
Dundalk, per G. W. Hughes, Esq. . . . .	1	3	1	Jersey, per George Clayton, Esq. . . . .	2	0	0

	£. s. d.		£. s. d.
<i>Jumna</i> , H.M.S., Canteen Fund, per Lieut. M. L. Kelham, R.N. . . . .	5 0 0	Port William, per Thomas Whyte, Esq. . . . .	0 7 6
<i>Lady Josyan</i> , s.s., collected on board, per Capt. P. Marett . . . . .	2 2 6	<i>Potosi</i> , s.s., collected on board, per Captain Cooper . . . . .	3 5 6
Leith, per J. A. Thomson, Esq., and T. Isaac, Esq. . . . .	8 19 6	"Sea-going Engineers," collected from, per Chas. Smith, Esq. . . . .	4 0 0
Limerick, per R. Mostyn, Esq. . . . .	1 14 9	Silloth, per Mr. W. Smith . . . . .	1 3 0
Liverpool, per F. Holder, Esq. . . . .	2 0 0	St. Andrew's, per N. McLeod, Esq. . . . .	0 7 0
<i>Mabel</i> , collected on board the yacht, per R. Bartholomew, Esq. . . . .	3 3 0	St. Katherine's Docks, Mercantile Marine Office, per Capt. J. Watson . . . . .	12 6 4
<i>Manitoba</i> , s.s., collected on board, per Capt. McDougall . . . . .	2 19 1	Sunderland, per Messrs. R. Hudson and Sons . . . . .	1 11 3
Montrose, per Lawrence S. Smith, Esq. . . . .	1 18 11	Sutton Bridge, per J. H. Webb, Esq. . . . .	0 18 0
Newport Mercantile Marine Office, per Jas. Lyons, Esq. . . . .	3 3 0	<i>Utopia</i> , s.s., collected on board, per Captain McRitchie . . . . .	2 13 0
Newport, Monmouth, per Caleb Cox, Esq. . . . .	13 10 6	<i>Waldensian</i> , steamer, collected on board, per Captain R. P. Moore . . . . .	1 9 8
North Shields Sailors' Home, per G. Trench, Esq. . . . .	0 10 4	Wigtown, per R. Chalmers, Esq. . . . .	0 10 0
<i>Phanician</i> , s.s., collected by Capt. J. Scott . . . . .	0 12 6	Wisbeach, per J. H. Webb, Esq. . . . .	0 16 0
Plymouth, per H. M. Shapcott, Esq. . . . .	3 13 10	Wivenhoe, collected at, per T. J. Howard, Esq. . . . .	1 3 9
Portsmouth, per Robert Raggett, Esq. . . . .	1 4 9	Woodbridge, per H. Fisher, Esq. . . . .	1 0 0
		<i>Worcester Cadet Life-boat Fund</i> , per Capt. J. H. Smith (additional) . . . . .	75 14 6

### The Royal National Life-boat Institution

Is prepared to establish and maintain a Life-boat Station on any part of the coast of the United Kingdom where it can be shown, from previous disasters, that a Life-boat is required. It is requisite that there should be a sufficient number of men (fishermen, or others accustomed to the management of boats at sea) to man the Life-boat, and a Committee formed from the residents in the neighbourhood to superintend the Station and obtain such small Annual Subscriptions as may contribute towards a portion of the expense of the Life-boat Station.

Communications may be addressed to

THE SECRETARY OF THE INSTITUTION,

14 JOHN STREET, ADELPHI, LONDON, W.C.

SPECIAL LIFE-BOAT CONTRIBUTIONS.

**CIVIL SERVICE LIFE-BOAT FUND.**

Patron—  
**HIS ROYAL HIGHNESS THE DUKE OF EDINBURGH, K.G., K.T. &c.**  
 Treasurer—  
**CHARLES G. TURNER, Esq.**  
 Hon. Secretary—  
**CHARLES DIBDIN, Esq., F.R.G.S.**

*Annual Subscriptions of 2s. 6d. have been promised in aid of the above Fund by 4973 gentlemen in the following Government Departments:—*

Admiralty.....	258
Board of Trade.....	36
British Museum.....	24
Charity Commission.....	45
Chatham Dockyard.....	13
Civil Service Commission.....	27
Colonial Office.....	23
Copyhold Commission.....	35
Court of Bankruptcy.....	54
Customs.....	278
Devonport Dockyard.....	17
Ecclesiastical Commission.....	46
Education Department.....	64
Exchequer and Audit Office.....	84
Foreign Office.....	50
Gazette Office.....	5
General Post Office.....	618
Great Seal Patent Office.....	40
High Court of Justice.....	243
Home Office.....	45
House of Commons.....	35
House of Lords.....	31
India Office.....	123
Inland Revenue.....	482
Local Government Board.....	118
Miscellaneous Post Offices.....	693
National Debt Office.....	39
Nautical Almanac Office.....	9
Office of Commissioners in Lunacy.....	6
Office of Woods and Forests.....	57
Office of Works.....	47
Paymaster-General's Office.....	33
Pembroke Dockyard.....	9
Portland Prison.....	4
Portsmouth Dockyard.....	27
Privy Council Office.....	12
Public Record Office.....	30
Public Works Loan Office.....	17
Queen Anne's Bounty.....	14
Record Office of Seamen.....	38
Registrar-General's Office.....	73
Registry of Friendly Societies.....	12
Royal Chelsea Hospital.....	10
Royal Clarence Yard, Gosport.....	5
Royal Mint.....	75
Royal Victoria Yard, Deptford.....	14
Science and Art Department.....	32
Sheerness Dockyard.....	16
Stationery Office.....	37
Treasury.....	47
War Office.....	110
Miscellaneous.....	2

**SCOTLAND.**

Auditor of the Court of Session Office.....	1
Bankruptcy, Office of Accountant Board of Lunacy.....	1
Board of Manufactures.....	7
Board of Supervision.....	15
Chancery Office.....	3
Crown Office.....	5
Customs, Greenock.....	8

Exchequer.....	11
Fishery Board.....	4
General Post Office.....	72
Miscellaneous Post Offices.....	63
General Registry Office.....	6
Horning Office.....	1
Inland Revenue.....	68
Inland Revenue, Glasgow.....	114
Justiciary Office.....	5
Lord Clerk Register's Office.....	6
Northern Lighthouse Board.....	4
Offices of Works.....	1
Prison and Judicial Statistics.....	16
Register of Deeds and Probative Writ Office.....	4
Sasine Office.....	40
Science and Art Department.....	2

**IRELAND.**

Customs.....	8
General Post Office.....	113
General Survey and Valuation Office.....	27
Inland Revenue.....	25
Miscellaneous Post Offices.....	18
Office of National Education.....	56
<b>Total.....</b>	<b>4,973</b>

**CLEVEDON LIFE-BOAT FUND.**

Honorary Secretary—  
**Mrs. E. LAVINGTON, Belgrave House, Clevedon, Somerset.**

<i>Donations.</i>		<i>£. s. d.</i>
Proceeds of Soirée Musicale (Dec. 1872).....	25	0 0
Ditto do. do. (1874).....	26	17 0
Ditto do. do. (1875).....	26	6 0
Collected by Mrs. Lavington's Pupils during the half-year ending June 1875.....	20	18 7
Ditto half-year ending June 1876.....	10	4 9
Collected by Miss Wrigley, Holbeck, Windermere, during the half-year ending June 1876.....	15	15 0
Sale of Work and Christmas Tree, December 1876.....	27	4 0
Sale of Pupils' Work 1878.....	38	4 2
Penruddocke, Miss, Fyfield, Wilts, contributions from the sale of work (1875-81).....	5	15 9
Harrison, Miss, French coins.....	3	5 5
Collected by Miss Ettie Lovibond, Bridgwater.....	4	0 0
Contents of Life-boat Box, and collections during the year 1877.....	6	11 6
Contents of Life-boat Box to Christmas 1878.....	2	2 6
Sale of Pupils' Work, 1879.....	46	4 2
Sale of <i>Clevedon Wild Flowers</i> .....	16	16 6
Sale of Work, Donations, and sale of <i>Clevedon Wild Flowers</i> , 1880.....	39	13 4
<b>Total.....</b>	<b>£311</b>	<b>16 8</b>

**THE "COVENT GARDEN" LIFE-BOAT FUND.**

Amounts handed to the NATIONAL LIFE-BOAT INSTITUTION by the Stewards of this Fund, being the Contribution for the year 1880, in aid of the support of the *Covent Garden* Life-boat, now stationed at Caister, near Great Yarmouth.

Austin, A. Esq.....	£. s. d.	3	3	0
Cumberlege, Rev. S. F. M.A.....	1	1	0	0
Norman, W. Esq.....	1	2	6	
Parker, H. Esq.....	1	0	0	
Robinson, W. Esq.....	10	0	0	
Part Proceeds of Entertainment.....	43	3	6	
<b>Total.....</b>	<b>£50</b>	<b>0</b>	<b>0</b>	

**THE "FORESTER" AND "FORESTERS' PRIDE" LIFE-BOATS FUND.**

List of Voluntary Contributions received for the Fund from the following DISTRICTS, COURTS, &c., of the ANCIENT ORDER OF FORESTERS, from January 31, 1880, to January 31, 1881, per SAMUEL SHAWCROSS, Esq., P.S.

Amount previously published in Foresters' Reports from 1863 to Jan. 31, 1880.....

<i>DISTRICTS.</i>		<i>£. s. d.</i>
Ashton-under-Lyue.....	10	6
Denny.....	1	0 0
Devon, &c.....	4	3 9
Flintshire.....	1	1 0
Ipswich.....	4	0 11
London United.....	2	5 3
Maidstone.....	15	0
Orrell.....	15	5
Rochester.....	9	10 10
Rothsay.....	9	0
Sheffield.....	2	15 3*
Smith, R., P.H.C.R.....	10	0
South London.....	3	7 4
Soath Western.....	3	18 0
Stafford.....	10	6
Staybridge.....	11	2
Tunbridge Wells.....	1	4 2

**COURTS.**

140.....	12	0
256.....	1	1 0
608.....	5	6
664.....	5	0
681.....	10	6
745.....	5	0
757.....	9	2
851.....	5	0
1007.....	5	6
1057.....	8	0
1088.....	5	0
1169.....	12	6
1193.....	11	9
1298.....	10	6
1400.....	8	0
1438.....	6	0
1556.....	1	1 0
1756.....	10	0
1762.....	8	3
1911.....	19	8
1922.....	6	0
2030.....	13	0
2138.....	7	6

Table with 3 columns: Name, £. s. d., and £. s. d. listing donors and amounts for the Manchester Life-Boat Fund.

THE "MANCHESTER LIFE-BOAT FUND.

Contribution from THE INDEPENDENT ORDER of ODD FELLOWS (Manchester Unity) FRIENDLY SOCIETY, for the year 1880, per THOMAS COLLINS, Esq., Secretary. £50 0 0

"MARK LANE" LIFE-BOAT FUND.

Hon. Sec.—H. KATNS-JACKSON, Esq.

Subscriptions at Christmas, 1880-1.

Table with 2 columns: Name and £. s. d. listing subscriptions for the Mark Lane Life-Boat Fund.

Table with 3 columns: Name, £. s. d., and £. s. d. listing donors and amounts for the Oliver Goldsmith Life-Boat Fund.

THE "OLIVER GOLDSMITH" LIFE-BOAT FUND.

Treasurer—Lieut.-Gen. A. T. TULLOH, R.A., C.B.

Honorary Secretary—Miss ADA GOLDSMITH TULLOH, West Malvern.

Table with 3 columns: Name, £. s. d., and £. s. d. listing donors and amounts for the Oliver Goldsmith Life-Boat Fund.



# INDEX TO THE BRANCHES.

	PAGE		PAGE		PAGE
ABERDEEN	364	EXMOUTH	331	NORTH SUNDERLAND	351
ABERDOVEY	347	EYEMOUTH	366	NOTTINGHAM	361
ABERYSTWYTH	324	FALMOUTH	326	PADSTOW	327
ACOCK'S GREEN, YARDLEY, AND		FILEY	360	PALLING	349
OLTON	358	FISHGUARD	351	PEBBLES	374
ALDBOROUGH AND THORPE	354	FLAMBOROUGH	360	PENARTH	337
ALDERNEY	382	FLEETWOOD	342	PENZANCE AND SENNEN COVE	327
ALLOA	367	FOWEY	326	PETERHEAD	365
ALNMOUTH	349	FRASERBURGH	365	PIEL	345
ANGLESEY	323	GIRVAN	366	POOLE	335
ANSTRUTHER	370	GLASGOW	372	PORTCAWL	338
ARBROATH	371	GOODWIN SANDS AND DOWNS	340	PORTHDINLLEN AND ABERSOCH	325
ARDMORE	380	GORLESTON	354	PORTHLEVEN	328
ARDROSSAN	365	GOURDON	372	PORTHOUSTOCK	328
ARELOW	381	GREENOCK	375	PORT ISAAC	328
AYR	365	GRYTONES	381	PORTLOE	328
BACTON	347	GUERNSEY	382	PORT LOGAN AND BAY OF LUKE	376
BALLANTRAE	366	HABLEFPOOL	335	PORTMADOC	325
BALLYFOOTON	377	HARWICH	337	PORT OF PLYMOUTH	332
BALLYWALTER	378	HASBOROUGH	348	PORT OF ROCHESTER	341
BANFF AND MACDUFF	366	HASTINGS AND ST. LEONARDS	357	PORT OF RUNCORN	325
BANNOCKBURN	375	HAUXLEY	350	PORT PATRICK	376
BARMOUTH	347	HAYLE	326	PORTRUSH	377
BARNSTAPLE AND BRAUNTON	330	HENLEY-ON-THAMES	351	PORTSMOUTH AND HAYLING ISLAND	338
BATH	352	HOLYHEAD	323	RAMSEY	382
BELFAST AND GROOMSPORT	376	HOLY ISLAND	350	READING	323
BELPER	329	HORNSEA	360	RHYL	337
BEMBRIDGE	338	Huddersfield	360	ROCHDALE	345
BERWICK	348	HULL	361	ROGERSTOWN	379
BIDEFORD AND APPLEDORE	330	HUNA	367	RUNSWICK	362
BIRMINGHAM	358	HUNSTANTON	348	RYE AND WINCHELSEA	358
BLACKBURN	341	HYTHE	340	SALCOMBE AND HOPE COVE	333
BLACKPOOL	341	ILFRACOMBE AND MORTE	331	SCARBOROUGH	362
BLAKEY	317	IPSWICH	354	SCILLY ISLANDS	328
BLYTH	350	IRVINE	366	SEAHAM	336
BOLTON	341	ISLE OF ARRAN	367	SEATON CAREW	336
BOSTON	346	ISLE OF PURBECK	334	SETTLE	362
BOULMER	350	ISLE OF WHITHORN	376	SHEFFIELD	363
BRADFORD	359	ISLE OF WIGHT	339	SHERINGHAM	349
BRANCASTER	348	KEIGHLEY	361	SHOREHAM	358
BRIDGWATER AND BURHAM	352	KELSO	375	SUDMOUTH	333
BRIDLINGTON	360	KINGSGATE	340	SKERRIES AND BALBRIGGAN	379
BRIDPORT	334	KING'S LYNN	348	SOUTHEND	337
BRIGHTON	365	KINGSTOWN	379	SOUTHPORT	345
BRISTOL	338	KIRKCUDBRIGHT	372	SOUTHWOLD	355
BROADSTAIRS	339	KIRKLISTON	374	STAFFORDSHIRE POTTERIES	353
BUCKIE	368	LANCASTER	342	ST. ANDREW'S	371
BUDE	326	LEEDS	361	ST. DAVID'S AND SOLVA	352
BURTON-ON-TRENT	353	LEEK	353	ST. IVES (CORNWALL)	328
CADGWITH	326	LEICESTER	345	STAITHES	363
CAHORE	380	LIMERICK	379	STEEHFORD	359
CAMBRIDGE	324	LINCOLNSHIRE SHIPWRECK ASSO-		STEBLING	375
CAMPBELTOWN AND SOUTHWOLD	365	CIATION	346	STONEHAVEN	372
CARDIGAN	324	LIVERPOOL AND NEW BRIGHTON	342	STRONNESS	374
CARLISLE AND SILOTH	329	LIZARD (POLPEAR)	326	SUNDERLAND AND WHITBURN	336
CARMARTHEN BAY	325	LLANDDULAS	329	SWANAGE	335
CARNSORE	381	LLANDUDNO	325	SWANSEA	338
CASTLETON	382	LLANELLY AND PEMBREY	325	TEES BAY	363
CAVAN	377	LONDONDERRY AND GREENCASTLE	379	TEIGNMOUTH	333
CHELTENHAM	338	LONGHOPE	374	TENBY	352
CHESTER	325	LOOE	326	THURSO	367
CHICHESTER HARBOUR & SELSEY	355	LOSSIEMOUTH	370	TORBAY	333
CLACTON-ON-SEA	336	LOWESTOFT AND PAKEFIELD	354	TORQUAY	333
CLETHORPES	347	LYDD, DUNGENESS	340	TRALEE BAY	379
CLOVELLY	330	LYME REGIS	335	TRAMORE	360
CORK AND QUEENSTOWN	377	LYNMOUTH	332	TRON	366
COURTMACHERRY	377	LYTHAM	344	TYRELLA	378
COURTOWN	381	MANCHESTER	344	VALENTIA	379
CRESSWELL	350	MARGBATE	341	WAKEFIELD	363
CROMER	348	MARYPORT	329	WATCHET	352
CRUDEN BAY	365	MELROSE	375	WELLS	349
DALEFORTH	367	MELTON	327	WESTERN COUNTIES CENTRAL	334
DARTMOUTH	330	MELFORD HAVEN	351	WEST HARTLEPOOL	336
DAWLISH	331	MONTROSE	371	WEST-SUPER-MARE	363
DERRY	330	MORAY FIRTH	374	WEXFORD AND ROSSLAKE	281
DOUGLAS	382	MULLION	327	WETMOUTH	335
DOVER	340	MUNDESLY	348	WHITBY AND UPGANG	364
DROGHEDA	380	MUSSELBURGH	370	WHITEHAVEN AND SEASCALE	329
DUBLIN	378	NEWARK	351	WHITELINK BAY	365
DUNBAR	372	NEWBIGGIN	350	WICK AND ACKERGILL	367
DUNCANNON AND WATERFORD	381	NEWBURGH	365	WICKLOW	382
DUNDALK	380	NEWCASTLE (DUNDEE)	378	WINTERTON	349
DUNDEE	371	NEWCASTLE, TYNEMOUTH, ETC.	350	WITHERNSEA	364
DUNFERMLINE	370	NEWHAVEN	357	WOLVERHAMPTON	353
DUNGARVAN	380	NEWQUAY AND ABERAYRON	324	WORCESTER	359
DUNWICH	354	NEWQUAY (CORNWALL)	327	WORKINGTON	329
EASTBOURNE	357	NEW ROMNEY AND DUNGENESS	311	WORTHINGTON	358
EDINBURGH AND LEITH	368	NEWTON ABBOT	332	YARMOUTH AND CAISTER	349
ENNISKILLEN	379	NORFOLK	347	YEALEM RIVER	334
ESSEX AND COLCHESTER	336	NORTHAMPTON	349	YORK	364
EXETER	331	NORTH BERWICK	372	YOUGHAL	378

SPECIAL LIFE-BOAT CONTRIBUTIONS.—CIVIL SERVICE, p. 319; CLEVEDON, p. 319; COVENT GARDEN, p. 319; FORRSTERS', p. 319; MARK LANE, p. 320; ODD FELLOWS, p. 320; "OLIVER GOLDSMITH," p. 320.

LISTS OF CONTRIBUTORS TO THE  
BRANCHES OF THE ROYAL NATIONAL LIFE-BEAT INSTITUTION.

Amounts acknowledged in these Lists are those chiefly received between 1st April, 1890, and 31st March, 1891.

ENGLAND AND WALES.

Anglesey.		£.	s.	d.
<b>ANGLESEY BRANCH.</b>				
Treasurer and Hon. Sec.— WILLIAM PRESTON, Esq.				
<i>Annual Subscriptions.</i>				
	£. s. d.			
Atkinson, John, Esq.	10	0	0	
Bangor, Bishop of	2	2	0	
Barber, H. Esq.	10	0	0	
Beever, J. F. Esq.	1	1	0	
<i>Boston, The Right</i>				
Hon. Lord	2	0	0	
Clegg, Henry, Esq.	1	1	0	
Davies, R. Esq. M.P.	2	2	0	
Davies, Robert, Esq.	2	2	0	
Docker, F. W. Esq.	10	0	0	
Duff, C. G. Esq.	10	0	0	
Duncuif, J. Esq.	10	0	0	
Edwards, Miss E. W.	1	0	0	
Edwards, T. F. Esq.	10	0	0	
Evans, T. Wynne, Esq.	1	1	0	
Evton, T. Wynne, Esq.	1	1	0	
Garteide, J. H. Esq.	1	1	0	
Garteide, Mrs.	1	1	0	
Griffith, H. T. D. Esq.	1	1	0	
Griffith, Miss Conway	0	0	0	
Griffith, W. G. Esq.	1	0	0	
Hall, J. Esq.	1	0	0	
Hampton, Miss	10	0	0	
Herbert, Rev. E.	10	0	0	
Higgins, G. Esq.	1	0	0	
Hughes, General	10	0	0	
Hughes, J. W. Esq.	10	0	0	
Hughes, W. B. Esq. M.P.	1	0	0	
Hughes, R. Jones, Esq.	1	0	0	
Husey, Horace, Esq.	1	0	0	
J. W.	1	7	0	
James, R. L., Lieut.				
R.N.A.V.	1	0	0	
Jones, Archd. Wynne	10	0	0	
Jones, F. Nicholls, Esq.	1	0	0	
Lewis, Col. Hampton	1	0	0	
J. W.	1	0	0	
Lewis, Miss	10	0	0	
Lewis, Wm. P. Esq.	1	0	0	
Lingham, F. H. Esq., per Rhosneigr Life-boat	1	1	0	
Lingham, Mrs., per Rhosneigr Life- boat	1	1	0	
Luck, Richard, Esq.	10	0	0	
Mason, Rev. Wms.	10	0	0	
Masse, Mrs.	10	0	0	
Masse, W. Esq.	10	0	0	
Meyrick, Sir George, Bart.	2	0	0	
Millington, Jno. Esq.	10	0	0	
Mitchell, H. B. Esq.	1	0	0	
Mitchell, Mrs. H. B.	1	0	0	
Morgan, Rev. B.	1	0	0	
Neave, The Hon. Lady	10	0	0	
Nunn, J. P. Esq., per Rhosneigr Life- boat	1	1	0	
Nunn, Mrs. for Rhos- neigr Life-boat	1	1	0	
Ogie, Admiral	10	0	0	
Owen, John, Esq.	1	0	0	
Owen, Rev. H. D., D.D. Tredraeth	1	1	0	
Owen, Rev. H. D., M.A., Penrynnydd	1	0	0	
Owen, R. Brisco, Esq.	1	0	0	
Owen, R. E. Esq.	10	0	0	
Owen, W. H. Esq.	2	0	0	
Pacey, J. Esq.	1	0	0	
Paynter, J. W. Esq.	1	0	0	
Penrhyn, Lord	5	0	0	

Collected in Llansa- durn Church, per Rev. R. H. Will- iams <th>£.</th> <th>s.</th> <th>d.</th>		£.	s.	d.
	17	6		
Llanfaes & Penmon churches, per Rev. T. W. Trevor				
	20	0	0	
Proceeds of Concert at Beaumaris, per W. M. Preston, Esq.				
	37	8	8	
Rayner, Mrs. G. Pritchard, contents of Contribution Box				
	10	0	0	
Total Dons				
	62	6	10	
Total Subs.				
	123	4	0	
£185 10 10				
<b>HOLYHEAD BRANCH.</b>				
President— The Hon. W. O. STANLEY.				
Chairman— Rev. Chancellor BRISCOE, D.D.				
Treasurer and Hon. Sec.— W. P. ELLIOTT, Esq.				
<i>Annual Subscriptions.</i>				
Barber, H. T. Esq.	10	6		
Beaumont, Capt.	10	0		
Briscoe, Rev. Chan- cellor, D.D.	10	0		
Cay, Capt. R.N.	10	0		
City of Dublin Steam Packet Co.	5	0	0	
Davis, Richd., Esq. M.P.	1	1	0	
Elliott, W. P. Esq.	10	6		
Ellis, Mr. John	5	0		
Griffith, Rev. Wm.	5	0		
Griffith, J. Lloyd, Esq.	1	0	0	
Haldane, Capt.	1	0	0	
Hughes, Mr. John	5	0		
Hughes, Mr. H. G.	5	0	0	
Jones, Capt. J. E., R.M.S. Ulster	1	0	0	
Jones, Mr. Jos.	5	0		
Jones, R. R. Capt.	10	0		
Kendall, Captain of R.M.S. <i>Commaught</i>	10	0		
Lewis, Capt. Geo.	10	0		
Lloyd, Morgan, Esq., Q.C., M.P.	1	1	0	
London and North Western Raily. Co.	10	0	0	
Mackenzie, Admiral	1	0	0	
Peters, Mr. John	5	0	0	
Pritchard, J. M. Esq., N. P. Bank	1	1	0	
Pritchard, Mr. R.	5	0		
Pughe, W. J. Esq.	10	6		
Stanley, Hon. W. O.	1	0	0	
Weston, Mr. John	5	0		
Williams, Mr. Hugh	10	0		
Williams, Mr.	5	0		
30 11 6				
<i>Donations.</i>				
Owen, Mr. R., King's Arms	7	1		
Life-boat House Box	6	0		
Sums under 5s.	14	1		
Total £31 18 8				

Berkshire.		£.	s.	d.
<b>READING BRANCH.</b>				
Honorary Secretary— C. STEPHENS, Esq.				
<i>Annual Subscriptions.</i>				
	£. s. d.			
Andrews, C. J. Esq.	10	6		
Austen, Capt. R.N.	1	1	0	
Bulley, Mr. J. S.	2	2	0	
Burnett, F. C. C. Esq.	1	1	0	
B. ale, Lansdowne, Esq.	1	1	0	
Bonyon, R. Esq.	3	3	0	
Biggs, Mr. W.	10	6		
Birch, Capt. R.N.	1	0	0	
Blackwell, Messrs. E. and F.	10	6		
Blandy, P. J. Esq.	1	1	0	
Blandy, H. B. Esq.	1	1	0	
Blandy, W. F. Esq.	1	1	0	
Blowers and Son, Messrs.				
	10	6		
Bourne, J. Esq.	10	6		
Brown, Mr. G. J.	1	0	0	
Butler, Capt. A., R.N.	10	0		
Butler, Mr. G. R.	10	0		
Bracher and Syden- ham, Messrs.				
	10	6		
Brailey, Mr. R.	10	0		
Cantrell, Mr. W. S.	10	0		
Catchpool, Mr. R. D.	1	1	0	
Cobham, Capt. A. W. P.	1	1	0	
Cobham, A. C. Esq.	1	0	0	
Cocks, Mrs. C.	10	0		
Collins, Chas. Esq.	10	6		
Collins, Henry, Esq.	10	6		
Cooper, Messrs. J. O. and Son	10	0		
Cooper, Mr. Lewis	10	0		
Cowslade, H. H. Esq.	1	1	0	
Cowslade, W. W. Esq.	1	1	0	
Crawshaw, Mrs.	5	0	0	
Davis, Mr. E.	10	6		
Edge, Jno. Esq.	1	1	0	
Elliott, Capt. R.N.	1	1	0	
F. W. A.	2	0	0	
Ferguson and Son, Messrs.				
	10	6		
Flanagan, Mr. J.	1	1	0	
Fleet, Mrs.	1	0	0	
Forbes, A. C. Esq.	1	1	0	
Fuller, Mr. Josiah	1	0	0	
Garland, T. E. Esq.	1	1	0	
Garry, Rev. N. T.	1	0	0	
Hilligan, Mr. George	10	0		
Grahame, Miss	10	6		
Gray, Col. W.	1	1	0	
Hankey, Sidney A. Esq.	1	1	0	
Harbor, Mr. Thos.	1	1	0	
Harris, W. R. Esq.	1	0	0	
Hawker, The Misses	2	2	0	
Hawkes & Sons, Messrs.	10	6		
Heelas and Sons, Messrs.	1	1	0	
Hewett, Robt. Esq.	1	1	0	
Hewett, T. K. Esq.	10	6		
Hill, Mr. Arthur	10	6		
Hobbs, Mr. Josh.	1	0	0	
Holding, Miss	10	0		
Hounslow, Mr. J. W.	10	6		
Hulme, The Misses	2	2	0	
Hulme, Rev. G.	1	1	0	
Hunter, Sir P. Bart.	1	1	0	
Huntley, Mr. Josh.	1	1	0	
Iremonger, Mr. R.	10	0		
Johnson, Mr. Josh.	1	1	0	
Knox, Mrs.	1	1	0	

	£.	s.	d.
Knox, H. Esq. ....	1	1	0
Langley, Mrs. ....	1	1	0
Layton, Admiral. ....	1	1	0
Leach, Mr. John (the late) .....	1	1	0
Lodge, Mrs. ....	1	1	0
Lovejoy, Mr. G. ....	1	1	0
Lowndes, Mrs. ....	10	6	
Maitland, T. F. Esq. ....	1	1	0
Maurice, O. C. Esq. ....	10	6	
May, George, Esq. ....	1	1	0
Messer, Messrs. J. & O. ....	1	1	0
Millington, Mr. H. ....	10	6	
Minty, J. Esq. ....	1	1	0
Morris, Mr. C. ....	10	6	
Morris, Mr. Josh. ....	1	1	0
Mount, W. G. Esq. ....	1	1	0
Moxhay, W. W. Esq. ....	10	6	
Oakshott, Mr. R. ....	10	6	
Outen, Miss. ....	10	6	
Palmer, A. Esq. ....	6	0	0
Palmer, George, Esq. M.P. ....	1	1	0
Palmer, G. W. Esq. ....	3	0	0
Palmer, W. J. Esq. ....	2	0	0
Petty, F. Esq. ....	10	6	
Petty, Mrs. ....	10	6	
Philp, Mr. Thos. ....	10	6	
Pipon, Capt. ....	1	0	0
Porter, Thomas, Esq. ....	1	0	0
Rogers, Thos. Esq. ....	1	1	0
Rosling, S. Esq. ....	1	1	0
Sawyer, Capt. ....	1	0	0
Simmons, Capt. ....	1	0	0
Simonds, B. Esq. ....	10	6	
Simonds, H. J. Esq. ....	1	1	0
Slocombe, W. Esq. (the late) .....	1	1	0
Smith, Arthur, Esq. ....	1	1	0
Smith, Chas. Esq. ....	10	6	
Solomon, Mr. C. R. ....	10	6	
Stephens, Rev. W. R. W. ....	1	1	0
Stephens, C. Esq. ....	2	2	0
Stephens, Capt. F. ....	1	1	0
Stevens, Mr. S. B. ....	1	1	0
Strange, J. T. Esq. ....	1	1	0
Strange, W. J. Esq. ....	1	1	0
Stransom, Mr. J. T. ....	10	6	
Sturgis, Rev. A. ....	10	6	
Sutton, Alfred, Esq. ....	1	1	0
Sutton, Herbert, Esq. ....	10	6	
Sutton, M. H. Esq. ....	1	1	0
Taylor, J. O. Esq. ....	10	6	
Thoyts, Major ....	1	1	0
Tompkins, Mr. R. ....	10	6	
Travers, Rev. C. H. ....	10	6	
Turner, Mr. Thomas Waterhouse, A. Esq. ....	10	6	
Welch, Arthur, Esq. ....	10	6	
Wheeler Brothers, Messrs. ....	10	6	
Wildner, F. Esq. ....	10	6	
Wildner, Mr. Jno. ....	10	6	
Wilson, J. H. Esq. ....	1	1	0
W. B. R. ....	1	1	0
Sums under 10s. ....	1	5	0
Total.....	£123	18	0

Donations.			
Box, Abbey Restaurant. ....	1	1	0
" Great Western Hotel .....	4	1	
" Pillar .....	15	3	1
" Queen's Hotel .....	1	5	0
" Ventris, Mr. ....	10	6	
Elwes, Miss. ....	15	0	0
Fleet, Mrs. ....	20	0	0
Gill, Miss, Coll by .....	7	6	
Marnden, Mr. G. ....	1	1	0
Palmer, Geo., M.P. ....	1	1	0
Royal Berkshire Lodge A. O. Druids. ....	2	2	0
Stamp, Exors. of Mrs. Ann .....	19	19	0
Simonds, Mrs. Chas. ....	5	0	0

£.	s.	d.	
Union Lodge of Freemasons, No. 414, collected at Anniversary Meeting, January 18, 1881. ....	6	7	6
Total Dons. ....	62	8	4
Total Subs. ....	123	18	0
	£186	6	4

**Cambridgeshire.**

**CAMBRIDGE BRANCH.**

President—  
Rev. E. H. PEROWNE, D.D.,  
Vice-Chancellor Cambridge University.

Vice-President—  
His Worship the Mayor.

Treasurer—  
OSCAR BROWNING, Esq., M.A.,  
Fellow of King's College.

Hon. Secretary—  
Capt. GOING, R.N.

£.	s.	d.	
Ansell, Mrs. J. ....	5	0	
Graves, Rev. C. E. ....	10	0	
Pain, Mr. J. O. ....	10	0	
Routh, Mrs. ....	10	0	
Sayle, B. Esq. ....	1	0	
Selwyn, Mrs. ....	1	0	
Sidwick, Mrs. ....	1	1	0
Smith, Mr. John .....	1	0	0
Thurnall, Miss E. ....	5	0	
Thurnall, Miss F. ....	5	0	
Witt, S. Esq. ....	2	2	0
Total.....	8	13	0

Donations.

Babington, Professor .....	1	0	0
Bumpsted, T. B. Esq. ....	1	0	0
Cooke, Mr. ....	10	6	
Foster, C. F. Esq. ....	5	5	0
Foster, E. Bird, Esq. ....	5	5	0
Foster, G. E. Esq. ....	5	5	0
Humphry, Mrs. A. P. ....	15	0	0
Liveing, Professor .....	1	0	0
Liveing, Mrs. ....	10	0	0
Matthew, Mr. J. ....	10	0	0
Orpen, Rev. T. H. ....	2	0	0
Parkinson, Mrs. ....	1	0	0
Sayle, R. Esq. ....	5	0	0
Thurnall, Miss .....	2	0	0
Witt, S. Esq. ....	10	0	0
Witt, Miss. ....	2	2	0
Sums under 10s. ....	7	6	
Total Dons. ....	43	10	0
Total Subs. ....	8	18	0
	£52	8	0

**Cardiganshire.**

**ABERYSTWYTH BRANCH.**

President—  
E. L. PRYSE, Esq.

Chairman—  
His Worship the Mayor.

Honorary Secretary—  
Rev. J. WILLIAMS.

Annual Subscriptions.

£.	s.	d.	
Davies, D. Esq., M.P. ....	2	0	0
Davies, Mr. D. J. ....	10	0	0
Davies, Mr. Mat. H. ....	5	0	0
Davies, Morris, Esq. ....	10	0	0
Edwards, Rev. Llewellyn, M.A. ....	5	0	0
Edwards, Rev. T. C., M.A. ....	10	0	0
Ellis, Mr. David. ....	5	0	0
Evans, Miss J. A. ....	10	0	0
Evans, Rev. W., M.A. ....	5	0	0
Fossett, Mrs. ....	5	0	0
Gibb, F. T. Esq. ....	1	1	0
Harris, T. D. Esq. ....	5	0	0
Hughes, A. J. Esq. ....	10	0	0
James, John, Esq. ....	10	0	0
James, Mr. Rich. ....	5	0	0
Jones, Edw. Esq. ....	10	6	
Jones, Griffith, Esq. ....	10	0	0
Jones and Morris, Messrs. ....	5	0	0
Jones, Mr. J. P., Pier St. ....	5	0	0
Jones, Peter, Esq., Mayor. ....	10	0	0
Levi, Rev. Thomas. ....	5	0	0
Loxdale, Jas. Esq. ....	1	1	0
Morgan, Mrs. B. ....	10	0	0
Morris, Capt. T. ....	5	0	0
Morris, Mr. Richard .....	5	0	0
Phillips, Rev. Canon Pryse, Col. ....	1	1	0
Roberts, David, Esq. ....	5	0	0
Roberts, Jacob, Esq. ....	5	0	0
Roberts, Messrs. R. and Sons .....	10	0	0
Thomas, Mr. Thomas .....	5	0	0
Watkins, Capt. R. ....	5	0	0
Watkins, John, Esq. ....	5	0	0
Williams, Rev. J. ....	5	0	0
Williams, Phillip, Esq. ....	5	0	0
Williams, Mr. T. ....	5	0	0
Williams, Rev. T. E. ....	5	0	0
Williams, W. Esq. (Sol.) .....	5	0	0
Williams, W. Esq. ....	10	0	0
Williams, Mr. W. T. ....	5	0	0
Wynne Mr. E. P. ....	5	0	0
Total.....	17	15	6

Donations.

Evans, Mr. John ....	2	6	
Garnett, Esq. ....	5	0	
Powell, G. E. J. Esq., Nanteos .....	25	0	0
S., Mrs. per Dr. Williams. ....	10	0	0
Cont. Pillar-box .....	2	0	2
Boxes in Boat-house .....	3	8	10
Total Dons. ....	31	6	6
Total Subs. ....	17	15	6
	£49	2	0

**CARDIGAN BRANCH.**

Chairman—  
R. D. JENKINS, Esq. J.P.

Honorary Secretary—  
JOHN MORGAN, Esq., Collector of Customs.

Annual Subscriptions.

£.	s.	d.	
Bowen, J. B. Esq. ....	5	0	0
Brenchley, T. H. Esq. ....	5	0	0
Brigstoke, W. Esq. ....	10	0	0
Brigstoke, Mrs. ....	1	0	0
Buck, W. Esq. ....	1	1	0
Colby, Mrs. J. ....	1	0	0
Colby, T. Esq. ....	5	0	0
Davies, Capt. Evan. ....	5	0	0
Davies, D. Esq., M.P. ....	2	2	0
Davies, Rev. W. C. ....	5	0	0
Davies, T. Esq. ....	10	0	0
Davies, D. G. Esq. ....	10	0	0
Evans, W. P. Esq. ....	10	0	0
Gilbertson, Esq. ....	5	0	0
Gower, Capt. E. ....	10	0	0
Griffiths, Mrs., Pant-gwyn. ....	5	0	0
Howell, Capt. W. ....	1	1	0
James, J. T. W. Esq. ....	10	0	0
James, Levi, Esq. ....	5	0	0
Jenkins, R. D. Esq. ....	10	0	0
Jones, Morgan, Esq. ....	2	0	0
Jones, Owen .....	10	0	0
Jones, Capt. Parry .....	5	0	0
Lewis, Col., Clyffny .....	10	0	0
Lloyd, G. Mrs. ....	5	0	0
Lloyd, T. Capt., Plas-y-Bryddle .....	10	0	0
Lloyd, T. E. Esq. ....	1	0	0
Miles, Rev. R. ....	10	0	0
Miles, S. H. Esq., Pnory .....	1	1	0
Mitchell, Dr. R.N. ....	5	0	0
Noot, H. Esq. ....	5	0	0
Parry, Miss Webley .....	5	0	0
Patatiano, Count. ....	5	0	0
Phillips, J. Esq., M.D. ....	5	0	0
Richardson, C. E. Esq. ....	10	0	0
Stewart, Captain .....	1	0	0
Wilkins and Co. Messrs. ....	1	0	0
Woodward, Messrs. ....	7	6	
Sums under 5s. ....	6	14	0
Total.....	29	1	6

**NEWQUAY & ABERYRON BRANCH.**

President—  
Captain C. E. LONGCROFT.

Honorary Secretary—  
Capt. DAVID JAMES.

Annual Subscriptions.

Davey, Rev. W. H., M.A. ....	10	0	0
Davies, T. Esq. ....	10	0	0
Evans, Dr. ....	5	0	0
Evans, Stephen, Esq. ....	1	1	0
James, Capt. David. ....	5	0	0
Jones, Dr. ....	5	0	0
Jones, J. Esq. ....	5	0	0
Jones, Rev. J. ....	5	0	0
Jones, Mr. Thomas .....	5	0	0
Lewis, Mrs. Col. ....	2	2	0
Morris, Thos. Esq. ....	10	0	0
National Provincial Bank .....	2	0	0
Parry, J. Esq. ....	5	0	0
Perrott, Mr. J. ....	5	0	0
Pryce, J. P. V. Esq. ....	10	0	0
Sickland, W. J. Esq. ....	5	0	0
Taylor, Capt. ....	10	0	0
Thomas, Mrs. ....	5	0	0
Walters, Miss .....	1	0	0
Williams, E. H. Esq. ....	5	0	0
Total.....	£11	9	0



Carmarthenshire.	LLANELLY AND PEMBREY BRANCH.	Carnarvonshire.	PORTMADOC BRANCH.
<b>CARMARTHEN BAY BRANCH.</b>	President— GENERAL MALCOLM, C.B.	<b>ORME'S HEAD (LLANDUDNO) BRANCH.</b>	Chairman— Capt. D. RICHARDS.
President— VISCOUNT EMLYN, M.P.	Vice-President— CHARLES NEVILL, Esq.	Chairman— Rev. J. MORGAN, Llandudno.	Honorary Secretary— D. HOMFRAY, Esq.
Vice-President— RICHARD JENNINGS, Esq.	Chairman— Capt. LUCKRAFT, R.N.	Treasurer— J. ADEY WELLS, Esq.	<i>Annual Subscriptions.</i>
Honorary Secretary— J. B. RISLEY, Esq.	Honorary Secretary— GERARD ELKINGTON, Esq.	Honorary Secretary— G. F. FELTON, Esq.	<i>£. s. d.</i>
<i>Annual Subscriptions.</i>	<i>Annual Subscriptions.</i>	<i>Annual Subscriptions.</i>	<i>£. s. d.</i>
Bath, Mrs. Henry J., Alyferin, Carmarthen .....	Ashburnham, Right Hon. the Earl of ..	Allen, F. Esq. ....	Breese, Edwd. Esq. ...
Bright and Garrard, Mesocs. ....	Bevan, Mr. Samuel ..	Bramall, G. H. Esq. ...	Do. for Tremadoc Estate .....
Brigstocke, W. B. P. Esq. ....	Broom, Mr. C. N. ....	Carden, Capt. ....	Cwmorthin Slate Co. ...
Brigstocke, Mrs. ...	Buckley, Dr. ....	Hagerdine, J. H. L. Esq., J.P. ....	Dunlop, A. M. Esq. ...
Buckley, Mr. J. N. ...	Buckley, Mr. James ...	Jones, Miss. ....	Ellis-Nanney, H. J. Esq. ....
Cawdor, The Earl of	Burry Port and Gwendreath Valley Co. ..	Moon, Mr. J. ....	Evans, Owen, Esq. ...
Cross, Miss Arengo ..	Bythway, Mr. W. ...	Morgan, Rev. J. ....	Greaves & Sons, John W. ....
Davies, Mostyn, Esq. ...	Coysh, Mr. Joseph. ...	Stanstreet, Esq. ....	Harlech, The Rt. Hon. Lord .....
Day, Lieut.-Col. ....	Elkington, Mr. G. B. ...	Rees, Rev. H., M.A. ...	Holland, S. Esq., M.P. ...
Edwardes, Messrs. ...	Elkington, Mr. H. ...	Williams, Dr. Bold. ...	Homfray, D. Esq. ....
Evans, Rev. Pugh ...	Elkington, Mr. J. B. ...	Woodward, W. Esq. ...	Jones, J. H. Esq. ...
Evans, William, Esq. ...	Evans, Mr. Evan ...	<b>Total</b> .....	Jones, William, Esq. ...
Falkener, E. Esq. ...	Gausson, Mr. C. W. ...	<b>Donations.</b>	Lloyd, Mr. W. ....
Gwynne, Mrs. M. E. ...	Hand, Mr. J. Kenneth	Arrowsmith, Mr. ...	Mutual Insurance Society .....
Hamilton, Lady. ...	Jenkins, Mr. John	Box at Imperial Hotel at Chantry. ...	Oakley, W. E. Esq. ...
	Jones .....	Do. at St. Georges Hotel, Dames. ....	Owen, Capt. G. H. ...

	£.	s.	d.
Hazlehurst & Sons,			
Messrs. ....	1	1	0
Higson, J. Esq. ....	1	1	0
Hoyes, W. and Co. ...	1	1	0
Stimson, Davies, & Sons, Messrs. ....	1	1	0
Speakman, Phillip, Esq. ....		10	6
Stock, Samuel, Esq. ...	1	1	0
Weaver Navigation Company, per Capt. Clarke. ....		1	0
Wells, L. B. Esq. ....		10	6
Contribution Box at Custom House ...	1	5	6
<b>Total.....</b>	<b>£11</b>	<b>14</b>	<b>6</b>

	£.	s.	d.
St. Aubyn, the Rev. Molesworth. ....	1	0	0
Penzance Western Hotel Box. ....		5	0
Sums under 5s. ....		3	0
<b>Total Dons. ....</b>	<b>9</b>	<b>16</b>	<b>9</b>
<b>Total Subs. ....</b>	<b>7</b>	<b>2</b>	<b>0</b>
<b>Total .....</b>	<b>£16</b>	<b>18</b>	<b>9</b>

**FALMOUTH BRANCH.**

President—  
**R. R. BROAD, Esq., J.P.**  
Chairman and Treasurer—  
**THOMAS WEBBER, Esq., J.P.**  
Honorary Secretary—  
**CHARLES CLIFT, Esq.**

*Annual Subscriptions.*

Basset, G. L. Esq. ....	3	0	0
Brett, H. Bailoi, M.P. Broad and Sons, Messrs. ....	1	1	0
Bull, Col. M. ....		10	0
Carme, Messrs. W. and E. C. ....	1	1	0
Carter, Mr. R. ....		5	0
Chard, Mr. A. ....		5	0
Cheesman, Mr. R. G. ....		10	6
Cliff, Mr. C. ....		5	0
Clinton, Lord. ....	2	2	0
Corfield, Mr. T. ....		2	6
Corfield, Mr. W. ....		5	0
Cox & Sons, Messrs. ....		10	6
Fox and Co., Messrs. G. C. ....		2	2
Fox, Mrs. Alfred. ....	1	1	0
Freeman, Mrs. John. ....		10	0
Genn, Mr. W. J. ....		10	6
Halligey, Mr. J. W. ....		5	0
Hosken, Mrs. S. ....	1	0	0
Jenkins, Mr. D. J., M.P. ....	2	2	0
Jenkins, Mr. G. A. ....		10	6
Jenkins, Mr. W. ....		5	0
Kemble, Mrs. ....	5	0	0
Kimberley, Earl of. ....	1	1	0
Keimerley, Mr. J. C. ....	1	1	0
Lean, Mr. W. H. ....		10	6
Melville, Mr. P. ....	1	1	0
Mitchell, Mr. N. ....		5	0
Olver, Mrs. J. ....		5	0
Pollard, Mr. H. ....		5	0
Selley, Mrs. Wm. ....		5	0
Solomon, Mr. W. H. ....		5	0
Snow, Mr. R. ....		5	0
St. Aubyn, Sir John, Bart., M.P. ....	1	1	0
Symons, Mr. G. W. H. ....		10	0
Tilly, Mr. H. ....		5	0
Tremayne, Col. ....	1	1	0
Vivian, Mr. Pendarvis, M.P. ....	1	1	0
Webber, Mr. T. ....		10	6
Williams and Co., Messrs. ....	1	1	0
Willmore, Mr. A. ....		5	0
Collecting Boxes ...	1	13	9
<b>Total.....</b>	<b>£35</b>	<b>15</b>	<b>3</b>

**FOWEY BRANCH.**

President—  
**JONATHAN RASHLEIGH, Esq.**  
Chairman—  
**The Rev. Dr. TREFFRY.**

Treasurer—  
**ARTHUR COODE, Esq.**

Honorary Secretary—  
**W. E. GRACH, Esq.**  
Honorary Collector—  
**W. LOWRY, Esq.**

*Annual Subscriptions.*

	£.	s.	d.
Bate, Mr. John ....		5	0
Carlyon, E. Esq. ....	1	1	0
Carnall, R. Esq. ....		10	0
Cocks, Lieut.-Col. ....	1	1	0
Coode, Arthur, Esq. ....	1	1	0
Coode, Edward, Esq. ....	1	1	0
Coode, John, Esq. ....	1	1	0
Crowder, A. E. Esq. ....	2	12	6
Davis, A. A. M.D. ....		5	0
Dingle, W. W. Esq. ....	1	1	0
Fortescue, Capt. ....	1	0	0
Freeth, George, Esq. ....	1	1	0
Hext, Thos. Esq. ....	1	1	0
Martyn, W. L. Esq. ....	1	1	0
Peard, Colonel ....	1	0	0
Purcell, Rev. H. N. ....		10	0
Rashleigh, Jonathan, Esq. ....		2	2
Robartes, Lord ....	1	1	0
Sartoris, E. J. Esq. ....	2	12	6
Stopford - Sackville, Mrs. ....	2	2	0
Treffry, Rev. Dr. ....	1	1	0
Truscott, Chas. Esq. ....		10	6
West, William, Esq. ....	1	1	0
White, Mrs. S. ....		10	0
Wreford, W. Esq. ....		5	0
<b>Total .....</b>	<b>£26</b>	<b>16</b>	<b>6</b>

**HAYLE BRANCH.**

Chairman—  
**Rev. F. HOCKIN, Rector.**  
Honorary Secretary—  
**JOHN MOORE, Esq.**

*Annual Subscriptions.*

Bain, D. W. Esq. ....		5	0
Basset, G. L. Esq. ....	2	0	0
Bazeley, Mr. Jas. ....		5	0
Bolitto, Sons and Co. Messrs. ....	1	1	0
Burall, Mrs. J. H. ....		10	0
Floyd, Mr. Rd. ....		5	0
Goldsworthy, Mr. T. ....		5	0
Harvey and Co. ....	5	0	0
Harvey, Frank, Esq. ....	1	1	0
Harvey, Wm. Esq. ....	1	1	0
Hitchens, M. T. Esq. ....		5	0
Hockin, G. C. Esq. ....	1	1	0
Hockin, Rev. F. ....	1	1	0
Hosken, Wm. Esq. ....		10	0
Husband, W. Esq. ....	1	1	0
Mudge, James, Esq. ....		10	0
Nicholls, Mr. Loan. ....		10	0
Olver, Miss ....		5	0
Pearce, Mr. G. ....		5	0
Polkinghorne, Mr. T. ....		5	0
Pool, Capt. F. H. ....		10	6
Pool, Mr. Henry. ....		5	0
Pool, Messrs. J. F. ....		5	0
Praed, C. Esq. ....	2	2	0
Rawlings, W. J. Esq. ....		10	0
Rodd, F. Esq. ....	1	1	0
Roskelly, Capt. ....		5	0
Spray, Capt. P. B. ....		10	6
St. Aubyn, Sir John, Bart., M.P. ....	1	1	0
St. Aubyn, Rev. St. Aubyn H. Molesworth ....	1	1	0
The Trevelhoe Estate	2	2	0

	£.	s.	d.
Trevithick and Sons, Messrs. J. H. ....	1	1	0
Vivian, John, Esq. ....		10	0
West, Nicks. J. Esq. ....		10	0
West, William, Esq. ....		10	0
<b>Total .....</b>	<b>29</b>	<b>10</b>	<b>0</b>

*Donations.*

Sums under 5s. ....		8	2
<b>Total .....</b>	<b>£29</b>	<b>18</b>	<b>2</b>

**LIZARD (POLPEAR) BRANCH.**

President—  
**The LORD ROBARTES.**  
Honorary Secretary—  
**Rev. P. VIVYAN ROBINSON.**

*Annual Subscriptions.*

Jauvrin, Misses ....	1	0	0
Gregory, Mrs. (Mada-gascar) ....		2	2
Robartes, Lord ....		10	10
Spencer, Rev. E. ....	1	1	0
St. Aubyn, Sir John, Bart., M.P. ....	1	1	0
Western Morning News, Proprietors of. ....	1	1	0
<b>Total .....</b>	<b>16</b>	<b>15</b>	<b>0</b>

*Donations.*

Collection Boxes—			
Hill's Hotel. ....	5	0	5
Boat House. ....	1	2	4
Mrs. Rowe's. ....	1	2	0
<b>Total Dons. ....</b>	<b>7</b>	<b>4</b>	<b>9</b>
<b>Total Subs. ....</b>	<b>16</b>	<b>15</b>	<b>0</b>
<b>Total .....</b>	<b>£23</b>	<b>19</b>	<b>9</b>

**LOOE BRANCH.**

President—  
**W. H. POLE CAREW, Esq.**  
Chairman—  
**G. KERSWILL, Esq.**  
Honorary Secretary—  
**ROBERT THOMAS, Esq.**

*Annual Subscriptions.*

Allen, Misses ....		5	0
Bawden, Mr. ....		5	0
Bewes, Rev. T. A. ....	1	0	0
Bishop, James, Esq. ....	1	1	0
Blamey, J. H. Esq. ....		5	0
Butler, J. F. Esq. ....	5	0	0
Bush, Rev. Paul ....		10	0
Campbell, Rev. Ed. ....		5	0
Campbell, John, Esq. ....		10	0
Campbell, Mrs. T. ....		10	0
Campbell, T. Esq. ....		10	0
Campbell, Truman, Esq. ....		10	0
Carew, W. H. P. Esq. ....	1	0	0
Caunter, Henry, Esq. ....		10	0
Childs, Borlase, Esq. ....		10	0
Clogg, S. Esq. ....		10	0
Clymo, Mrs. James. ....		10	0
Coad, J. L. Esq. ....		5	0
Condon, Mr. J. ....		10	0
Courtney, —, Esq., M.P. ....		1	0
Crichton, M. F. Esq. ....		10	0
Davy, Capt. Henry. ....		5	0
Fisher, Rev. J. F. ....		10	0
Foster, L. C. Esq. ....		10	0
Foster, Rd. Esq. ....	1	1	0
Furzeaux, Rev. A. ....		5	0
Garrett, Rev. S. ....		10	0
Gill, Dr. ....		5	0
Glanville, Rev. H. C. ....		10	0

**Cornwall.**

**BUDE BRANCH.**

President—  
**SIR T. DYKE ACLAND, Bart., M.P.**

Treasurer—  
**Rev. E. HIGHTON.**

Honorary Secretary—  
**WILLIAM ROWE, Esq.**

*Annual Subscriptions.*

	£.	s.	d.
Acland, Sir T. D. Bart. ....	5	0	0
Carnsew, Rev. T. S. ....		10	0
Carnsew, Mrs. ....		5	0
Chamier, E. Esq. ....	1	0	0
Davey, Oliver, Esq. ....		5	0
Highton, Rev. E. ....		5	0
Hockin, John, Esq. ....	1	0	0
Hockin, Mrs. Frank. ....		5	0
King, J. Esq. ....		5	0
Mills, A. Esq. ....	1	1	0
Thynne, Rev. Lord John. ....	5	0	0
<b>Total .....</b>	<b>£14</b>	<b>16</b>	<b>0</b>

**CADGWITH BRANCH.**

President—  
**Captain SYMONS, R.N.**

Chairman—  
**Mr. Cox, Cadgwith.**

Honorary Secretary—  
**Rev. F. C. JACKSON.**

*Annual Subscriptions.*

Beringer, Mr. ....		2	6
Boaden, Mr. Joseph ....		5	0
Davis, Thomas, Esq. ....	1	1	0
Haynes, Mr. Thos. ....		10	0
Rogers, Henry, Esq. ....		10	6
St. Aubyn, Sir John, M.P. ....	1	0	0
Tyacke, Walker, Esq. ....		10	0
Vivian, Pendarvis, Esq., M.P. ....	1	1	0
Vivyan, Sir Vyvell. ....	1	1	0
W. B. D. ....	1	1	0
<b>Total.....</b>	<b>£7</b>	<b>2</b>	<b>0</b>

*Donations.*

Cadgwith Boxes. ....	1	2	2
G.W.R. Carriage Department. ....	7	6	7

Glencross, Rev. Ed. . . . .	£.	s.	d.
Glencross, Rev. Jas. . . . .	10	0	0
Grigg, John, Esq. . . . .	10	0	0
Hawke, Rd. Esq. . . . .	10	0	0
Hicks, Mr. B. . . . .	5	0	0
Hicks, Mrs. J. S. . . . .	5	0	0
Hicks, Mr. William . . . . .	5	0	0
Hill, Capt. John. . . . .	5	0	0
Hooppell, Mrs. . . . .	5	0	0
Iago, Mr. . . . .	5	0	0
Jenkins, Rev. D. . . . .	5	0	0
Jenkins, S. W. Esq. . . . .	10	0	0
Jones, Rev. E. D. . . . .	10	0	0
Kemble, Rev. A. . . . .	1	1	0
Kerswill, Geo. Esq. . . . .	10	0	0
Kerswill, Mrs. Geo. . . . .	5	0	0
Kerswill, J. B. Esq. . . . .	10	0	0
Kerswill, Robt. Esq. . . . .	10	0	0
King, Rev. Joseph . . . . .	10	0	0
Kitson, Rev. J. F. . . . .	10	0	0
Kitson, Mrs. . . . .	10	0	0
Little, Mr. Rd. . . . .	5	0	0
Marshall, Capt. John . . . . .	5	0	0
Marshall, L. Carrington, Esq. . . . .	10	0	0
Marshall, Wm. Esq. . . . .	1	0	0
Martin, Rev. Canon. . . . .	1	1	0
Martin, Rev. R. . . . .	1	1	0
Medland, James, Esq. . . . .	5	0	0
Morel, Col. de . . . . .	10	0	0
Neale, E. Jas. Esq. . . . .	1	1	0
Nicholas, John, Esq. . . . .	10	0	0
Norton, Rev. F. C. . . . .	10	0	0
Oliver, Mr. Thomas . . . . .	5	0	0
Peel, W. Esq. . . . .	1	0	0
Podd, Mr. John . . . . .	5	0	0
Pole, Henry, Esq. . . . .	1	0	0
Polkinghorne, Wm. Esq. . . . .	10	0	0
Rendle, C. B. Esq. . . . .	5	0	0
Roberts, Rev. John. . . . .	1	1	0
Sargent, J. R. Esq. . . . .	10	0	0
Tatham, Mrs. . . . .	5	0	0
Thomas, Dr. . . . .	5	0	0
Thomas, Robert, Esq. . . . .	10	0	0
Trelawny, Sir John. . . . .	1	1	0
Trelawny, W. L. S. Esq. . . . .	1	1	0
Tucker, Mr. W. T. . . . .	5	0	0
Walters, Mr. James. . . . .	5	0	0
Walters, Capt. John. . . . .	5	0	0
Walters, Capt. John. . . . .	5	0	0
Walters, Capt. Sam. . . . .	5	0	0
Willcocks, Isaac, Esq. . . . .	10	0	0
Willcocks, H. D., Esq. . . . .	5	0	0
Willis, C. Esq. . . . .	10	0	0
Wynhall, Mr. E. . . . .	5	0	0
Total. . . . .	46	4	0
<b>Donations.</b>			
Pillar boxes and small sums . . . . .	5	8	0
£46	9	8	
<b>MEVAGISSEY BRANCH.</b>			
President—			
JOHN TREMATNE, Esq., J.P.			
Chairman—			
Capt. WILLIAM BALL.			
Honorary Secretary—			
Capt. J. BALL FAIGRAN.			
<b>Annual Subscriptions.</b>			
Bailey, Edward, Esq. . . . .	2	0	0
Coode, Arthur, Esq. . . . .	10	0	0
Farran, Capt. J. B. . . . .	5	0	0
Higman, H. W. Esq. . . . .	10	0	0
Mt. Edgcombe, Lord . . . . .	3	0	0
Tremayne, J. Esq. . . . .	5	0	0
Williams, John M. Esq. . . . .	3	0	0
Total . . . . .	£14	5	6

**MULLION BRANCH.**

President—  
The LORD ROBARTES.

Chairman—  
J. SIDNEY DAVEY, Esq., J.P.

Honorary Secretary—  
E. G. HARVEY, Vicar.

**Annual Subscriptions.**

Benney, Mrs. R. . . . .	£.	s.	d.
Davey, J. Sydney, Esq. . . . .	1	1	0
Davey, Richard, Esq. . . . .	1	0	0
Head, Mrs. . . . .	5	0	0
Jose, Mr. Jer. . . . .	5	0	0
Kempthorne, Mr. J. B. . . . .	10	0	0
Lyle, Miss . . . . .	5	0	0
Robartes, Lord . . . . .	5	0	0
Shepherd, Mr. T. . . . .	5	0	0
Thomas, Mr. Joseph . . . . .	5	0	0
Thomas, Mr. Fredk. . . . .	5	0	0
Vyvyan, Rev. Sir Vyvell, Bart. . . . .	2	0	0
Williams, Mr. Peter . . . . .	10	0	0
Sums under 5s. . . . .	19	6	0
Total . . . . .	13	16	6
<b>Donations.</b>			
Collection Box . . . . .	7	9	0
£14	4	3	

**NEWQUAY BRANCH.**

Chairman—  
Major W. E. MICHELL.

Honorary Secretary—  
Mr. RICHD. HICKS.

**Annual Subscriptions.**

Boyle, Mr. . . . .	5	0	0
Cardell, T. M. Esq. . . . .	5	0	0
Carter, Capt. W. J. . . . .	5	0	0
Carus-Wilson, E. S. Esq. . . . .	10	0	0
Collins, J. B. Esq. . . . .	1	1	0
Crocker, Capt. John . . . . .	5	0	0
Edwards, Mr. J. V. . . . .	5	0	0
Ennor, Mr. J. . . . .	5	0	0
Hicks, Mr. W. . . . .	5	0	0
Hicks, Mr. R. . . . .	5	0	0
Hooper, Mr. J. . . . .	5	0	0
James, Miss Ellen. . . . .	1	0	0
Jenkin, Mr. Albert . . . . .	5	0	0
Jenkin, Capt. Thomas . . . . .	5	0	0
Jenkin, Capt. James . . . . .	5	0	0
Martyn, Mr. S. E. . . . .	1	1	0
Michell, Mrs. W. . . . .	1	1	0
Michell, W. E. Esq. . . . .	1	1	0
Molesworth, Sir P. Bt. R.N. . . . .	10	0	0
Morgan, Capt. W. . . . .	5	0	0
Oates, Richd. . . . .	5	0	0
Oliver, Mr. R. S. . . . .	5	0	0
Pearse, Miss. . . . .	1	0	0
Prout, Capt. Thomas . . . . .	5	0	0
Reynolds, Mr. Jno. . . . .	5	0	0
Rodd, F. Esq. . . . .	2	0	0
Shuckford, Mrs. . . . .	1	1	0
Stephens, Mr. Sampson . . . . .	5	0	0
Thomas, Capt. Wm. . . . .	5	0	0
Tonkin, Capt. W. . . . .	5	0	0
Trudwen, Mr. R. . . . .	5	0	0
Treffry, C. E. Esq. . . . .	1	1	0
Tummon, Mr. Cotton . . . . .	5	0	0
Wellington, Mr. B. . . . .	5	0	0
Weston, Mr. Fredk. . . . .	5	0	0
Willyams, A. Esq. . . . .	10	0	0
Willyams, E. Esq. . . . .	1	0	0
Sums under 5s. . . . .	5	0	0
Total . . . . .	19	1	0

**DONATIONS.**

Dunn, J. G. Esq. . . . .	£.	s.	d.
Box at Commercial Hotel, Newquay. . . . .	6	6	0
Do. at Life-boat House . . . . .	5	2	0
Do. at Post Office, Newquay. . . . .	8	0	0
Do. at Wellington Hotel, Boscastle . . . . .	1	0	2
Total Dons. . . . .	24	10	0
Total Subs. . . . .	19	1	0
£21	5	10	

**PADSTOW BRANCH.**

Chairman—  
C. G. PRIDEAUX BRUNE, Esq.

Honorary Secretary—  
Rev. RICHARD TYACKE.

**Annual Subscriptions.**

Robartes, Lord . . . . .	1	1	0
Beatrice, Lady Molesworth . . . . .	10	6	0
Molesworth, Sir Paul W. Bart. . . . .	10	6	0
Sawle, Dowager Lady Graves . . . . .	1	1	0
Allport, Mr. Samuel . . . . .	10	0	0
Allport, Mr. W. S. . . . .	5	0	0
Bishop, Mr. . . . .	1	0	0
Broad, Mr. Arch. J. B. . . . .	10	0	0
Brune, Prideaux, C. G. Esq. . . . .	2	0	0
Clemow and Son, Messrs. . . . .	1	1	0
Carlyon, the Rev. J. . . . .	5	0	0
Gurney, Rev. Goldsworthy . . . . .	1	0	0
Guy, Mrs. . . . .	10	6	0
Hellyar, Miss . . . . .	1	1	0
Hicks, Mr. . . . .	10	0	0
Langford, Capt. R. . . . .	5	0	0
Langford, Mr. Sussex . . . . .	5	0	0
Mann, Rev. C. N. . . . .	5	0	0
Marley, Mr. Hen. F. . . . .	5	0	0
Martyn, Mr. Henry . . . . .	1	0	0
Martyn, Miss G. . . . .	10	6	0
Martyn, Mr. I. . . . .	1	1	0
Martyn, Mr. S. Symons . . . . .	1	1	0
Martyn, Mrs. S. Symons . . . . .	5	0	0
Martyn, Mr. Thomas . . . . .	10	0	0
Nicholls, Mr. . . . .	10	0	0
Paynter, Rev. Samuel . . . . .	1	0	0
Peter, Mrs. . . . .	1	1	0
Peter, Miss . . . . .	1	0	0
Phillipps, Mr. H. N. . . . .	2	2	0
Potter, W. R. C. Esq. . . . .	1	0	0
Rawle, Capt. . . . .	10	6	0
Rawlings, Miss. . . . .	1	0	0
Rolleston, Mrs. . . . .	5	0	0
Stephens, Mrs. . . . .	10	0	0
Tregaskis, Mr. Saml. . . . .	5	0	0
Tyacke, the Rev. R. . . . .	10	6	0
Wilson, Capt. . . . .	1	1	0
Total . . . . .	27	18	0
<b>Donation.</b>			
Chetwynd, Lord . . . . .	1	0	0
£28	18	0	

**PENZANCE AND SENNEN COVE BRANCH.**

Chairman—  
The MAYOR.

Treasurer—  
JOHN R. BRANWELL, Esq.

Honorary Secretary—  
JOHN MATHEWS, Esq.

**Annual Subscriptions.**

Adkins, J. C. Esq. . . . .	£.	s.	d.
Bach, Chas. Esq. . . . .	1	0	0
Bazeley and Son, Messrs. George . . . . .	5	0	0
Bedford, Capt. D. B. . . . .	5	0	0
Bennett, W. S. Esq. . . . .	5	0	0
Boase, Francis, Esq. (Mayor) . . . . .	10	0	0
Bodilly and Sons, Messrs. J. H. . . . .	10	0	0
Bolitho, Edw. Esq. . . . .	1	0	0
Bolitho, R. F. Esq. . . . .	1	1	0
Bolitho, T. S. Esq. . . . .	1	0	0
Bolitho, T. Robins, Esq. . . . .	10	0	0
Bolitho, T. Bedford, Esq. . . . .	10	0	0
Bolitho, W. Esq. . . . .	1	0	0
Bolitho, Mrs. W. . . . .	5	0	0
Borlase, Rear-Adm. . . . .	10	0	0
Borlase, Walter H. Esq. . . . .	10	0	0
Borlase, W. Copeland, Esq. . . . .	10	0	0
Boyns, Richd., St. Just . . . . .	5	0	0
Boyns, Richd. Boscoeden . . . . .	5	0	0
Branwell and Sons, Messrs. R. M. . . . .	10	0	0
Branwell, Miss . . . . .	5	0	0
Brittain, F. W. Esq. . . . .	10	0	0
Came, Miss . . . . .	2	0	0
Carter, Mrs. . . . .	5	0	0
Clarke, Mr. F. J. . . . .	5	0	0
Cock, William . . . . .	5	0	0
Cornish, Thomas, Esq. . . . .	5	0	0
Corporation of Penzance . . . . .	5	0	0
Coulson, Messrs. Tho. and Co. . . . .	5	0	0
Coulson, Rev. T. B., St. Buryan. . . . .	10	0	0
Creed, Mr. A. . . . .	5	0	0
Davy, Messrs. E. & H. . . . .	5	0	0
Davy, Messrs. R. V. and H. . . . .	5	0	0
Dennis, Jas. Esq. . . . .	5	0	0
Dennis, Rev. R. N. . . . .	1	1	0
Dennis, Wm. Esq. . . . .	10	0	0
Doble, Mr. E. . . . .	5	0	0
Dodge, W. H. Esq. . . . .	5	0	0
Downing, S. T. G. Esq. . . . .	1	0	0
Edmonds, Miss. . . . .	5	0	0
Elliot, G. L. Esq. . . . .	5	0	0
Fagan, Rev. H. S., St. Just . . . . .	5	0	0
Field, T. W. Esq. . . . .	10	0	0
Fisher, Mrs. . . . .	5	0	0
Grenfell, P. Esq. (for 2 years) . . . . .	10	0	0
Grindall, Miss . . . . .	5	0	0
Harvey, Mrs. Nichs. . . . .	10	0	0
Harvey, Mr. S., St. Sennen . . . . .	5	0	0
Hedgland, Rev. P., M.A. . . . .	10	0	0
Helm, G. F. Esq. . . . .	5	0	0
Hodge, Hy. Esq., St. Sennen . . . . .	5	0	0
Hobbrook, Mr. A. . . . .	5	0	0
Holman, Fred. Esq. . . . .	1	1	0
Hora, Mr. A. H. . . . .	10	0	0
Jago, the Misses . . . . .	5	0	0
James, Mr. F. H. . . . .	5	0	0
James, Mr. John. . . . .	5	0	0

	£.	s.	d.
James, Mr. S. H., St.			
Just .....	10	0	
Jones, J. Winter, Esq. 1	0	0	
King, T. Esq. ....	10	0	
Laity, Mr. Hy., Penrose	5	0	
Laity, Mr. Hy., Tre-gurno	5	0	
Lambert, R. Esq. ....	5	0	
Lanyon, Mr. J. J. ....	5	0	
Lavin, Mr. Chas. ....	5	0	
Le Grice, D. P. Esq. ....	10	0	
Leigh, Mr. W., St. Levan	5	0	
Lethbridge, M. M. Esq.	5	0	
Liddiard, J. Esq., New Cross, London	1	1	0
Loughurst, Miss. ....	5	0	
Magor, M. Esq. ....	10	0	
Marrack, Mr. Philip	10	0	
Martyn, Mr. R. S. ....	5	0	
Mathews, Mr. F. C. ....	5	0	
Mathews, Messrs. W. D. and Sons. ....	10	0	
Michell, A. O., Esq. ....	10	0	
Michell, Mr. A. H. ....	5	0	
Milton, J. P. Esq. ....	10	0	
Montgomery, Dr. ....	5	0	
Moody, Miss. ....	5	0	
Moody, Miss S. ....	5	0	
Moore, E. T. Esq. ....	5	0	
Molesworth, Sir P. W.	10	0	
Oliver and Sons, Messrs.	5	0	
Oliver and Symons, Messrs. ....	5	0	
Orwell, Mr. R., Trevescon	5	0	
Pagan, W. Esq. ....	5	0	
Pascoe, H. and Son	5	0	
Pascoe, Mr. Nichols, Trevescon	5	0	
Peel, Miss	5	0	
Perry, Mr. F. S., St. Levan	5	0	
Peters, the Misses ..	10	0	
Polisue, Mr. J. ....	5	0	
Pool, Mr. George ....	10	0	
Preston, Rev. Geo. H.	5	0	
Quick, Messrs. J. R. and J. ....	5	0	
Roberts, Mr. Thos., St. Sennen	5	0	
Rodd, W. H. Esq. ....	5	0	
Roe, Rev. R. J., St. Sennen	1	1	0
Rogers, Miss (Trev-arthian)	1	1	0
Rogers, the Misses ..	5	0	
Roscoria, J. Esq. ....	5	0	
Rosa, C. C. Esq. (Mayor)	1	1	0
Ross, Mrs. ....	10	0	
Roughhead, T. C. Esq.	5	0	
Ruck, Mr. John ....	5	0	
Saundry, J. and Son, St. Sennen	5	0	
Scobell, Geo. Esq. ....	1	0	
Spratt, Mr., St. Levan	5	0	
St. Aubyn, Sir John, Bart., M.P.	1	1	0
Sterling, Rev. C. J. ....	10	0	
Thomas, Henry, Esq. ....	5	0	
Thomas, R., St. Just	5	0	
Tonkin, Rev. John, St. Buryan	10	0	
Trelawney, Colonel.	5	0	
Tremewen, Mr. N. T., St. Sennen	5	0	
Trevethick, Mrs. ....	10	0	
Trythall, W. Esq. ....	10	0	
Victor, Messrs. E. R. and H. ....	5	0	
White, W. Todd, Esq. ....	10	0	
Williams, Mrs. ....	5	0	
Wills, Mrs. ....	5	0	
Wingfield, Rev. W. W.	10	0	
Sums under 5s. ....	13	18	6
<b>Total .....</b>	<b>72</b>	<b>2</b>	<b>0</b>

	£.	s.	d.
<i>Donations.</i>			
Pillar Box, Promenade, and Box at the Life-boat Station, Penzance	5	11	9
Box, Union Hotel (the Misses Longhurst) .....	1	1	9
Do. Queen's Hotel (Mr. A. H. Hora)	6	0	
Do. Western Hotel (Mr. W. Mitchell)	15	6	
Do. Beachfield House (Miss Dingley) ..	4	3	
Do. Mount's Bay House (Mrs. Lavins) .....	4	4	
Do. Auction Mart (J. Bennett) .....	2	2	0
Do. Godolphin Hotel, Marazion (Mrs. Jenkin) .....	9	4	
Do. Godolphin Hotel, Marazion (Mr. Erikson) .....	11	8	
Newall, Mr. J. D., 12, Penrose Terrace, Penzance	10	0	
Small sums .....	2	7	
<b>Total Dons. ....</b>	<b>11</b>	<b>19</b>	<b>2</b>
<b>Total Subs. ....</b>	<b>72</b>	<b>2</b>	<b>0</b>
<b>£84 1 2</b>			

**PORHLIVEN BRANCH.**

President—			
The Lord ROBERTS.			
Chairman—			
Rev. E. PRIDMORE.			
Honorary Secretary—			
E. SUDGEMAN JAMES, Esq.			
Annual Subscriptions.			
Robertes, Lord	5	5	0
Bickford-Smith, W., Esq.	1	1	0
Bolitho, Sons & Co., 1	1	0	
Cade, Mr. R.	5	0	
Coode, Ed. Esq.	1	1	0
Cornish Bank Limited, Helston	1	1	0
Grylls, Col.	1	1	0
Harvey, Wm. Esq.	2	2	0
Lanyon, Mrs.	5	0	
Lear, E. W. Esq.	10	0	
Martyn, Mr. R.	5	0	
Molesworth - St. Aubyn, W. Esq., M.P.	10	0	
Pridmore, Rev. E.	1	1	0
Roberts, Mr. H.	5	0	
Rogers, Capt. J. P., R.A.	1	1	0
Rogers, H. Esq.	10	0	
Rogers, Miss Elizab.	1	1	0
St. Aubyn, Sir J., M.P.	1	1	0
Simons, J. Esq.	5	0	
Sleeman, Mr. W.	5	0	
Smedley, Miss	1	0	
Vyvyan, Rev. Sir Vyell, Bt.	3	3	0
Wise, Rev. R. F.	1	1	0
Young, W. A. Esq.	1	0	
Sums under 5s. ....	15	0	
<b>Total .....</b>	<b>£26</b>	<b>15</b>	<b>0</b>

**PORHOUSTOCK BRANCH.**

President—			
WILLIAM TREVENEN, Esq.			
Chairman—			
EDWD. J. LEVERTON, Esq.			
Honorary Secretary—			
Mr. E. F. ROSKRUGE.			
Annual Subscriptions.			
Robertes, Lord	2	2	0
Billeit, Mr.	5	0	
Dolman, Jas. Esq.	2	2	0
Fox, G. C. and Co.	1	1	0
Glubb, Rev. P. S.	1	1	0
Griffith, Rev. E.	2	2	0
Hearle, Mr.	5	0	
Howard, Rev. A. W.	10	0	
James, Mr. Wm.	10	0	
Leverton, Edw. Esq.	10	0	
Lory, C. M. Esq.	5	0	
Pengilly, Mr. Alex.	10	0	
Smedley, Miss	2	0	
St. Aubyn, J. Esq. M.P.	1	0	
Tremayne, Colonel.	1	1	0
Trevenen, Wm. Esq.	1	1	0
Venables, Mrs.	10	0	
Vyvyan, Rev. Sir Vyell	2	2	0
<b>Total .....</b>	<b>£19</b>	<b>7</b>	<b>0</b>

**PORT ISAAC BRANCH.**

Honorary Secretary—			
W. GUY, Esq.			
Annual Subscriptions.			
Allen, Mr. Edw.	1	1	0
East Cornwall Bank	1	1	0
Guy, Mr. Warwick.	10	0	
Guy, Mrs. Mark	10	6	
Hambly, Mrs. E.	10	0	
Johnson, Mr. Thomas	5	0	
Page, Rev. V.	1	1	0
Pearse, M.	1	0	
Robertes, Lord	1	0	
Stephens, Mrs.	1	1	0
Treffry, Rev. R.	1	1	0
Treven, Dr. M. R. N.	10	0	
Treven, Mr. F.	2	2	0
Wharndcliffe, Lord	2	0	
<b>Total .....</b>	<b>£12</b>	<b>2</b>	<b>6</b>

**PORTLOE BRANCH.**

Chairman—			
The Lord HYLTON.			
Honorary Secretary—			
Rev. Canon CORNISH.			
Annual Subscriptions.			
Blamey, Mr. J. A.	5	0	
Blamey, Mr. T.	5	0	
Carlyon, E. T. Esq.	10	6	
Cornish, Rev. J. R.	5	0	
Devon and Cornwall Bank	10	0	
Dunstone, Mr. P.	10	0	
Dunstone, Mr. W.	5	0	
Fookes, Rev. W.	5	0	
Hylton, Lord	3	3	0
Miners' Bank, Truro	10	0	
Peter, Rev. L. M.	1	1	0
Wise, Rev. Canon	10	0	
Young, J. T. Esq.	10	6	
<b>Total .....</b>	<b>£8</b>	<b>10</b>	<b>0</b>

**ST. IVES (CORN-WALL) BRANCH.**

Treasurer—			
EDWARD HAIN, Jun., Esq.			
Honorary Secretary—			
T. B. WILLIAMS, Jun. Esq.			
Annual Subscriptions.			
Anthony, Mr. M. D.	5	0	
Barnfield, Mr. R. H.	10	0	
Batten, Carne and Carne, Messrs.	10	6	
Best, Mr. W. H.	5	0	
Bolithos & Co. Messrs.	1	1	0
Care, Capt. H.	5	0	
Care, Capt. W. H.	5	0	
Chelwell, Capt. J.	5	0	
Cogar, Thomas	5	0	
Coles, Rev. E. E.	10	0	
Comley, Mr. J.	5	0	
Cowley, Earl, K.G.	2	2	0
Docton, William	5	0	
Gyles, Capt. William	5	0	
Hain, Edw., and Son, Messrs.	10	6	
Hain, Capt. John	5	0	
Hain, Capt. R.	5	0	
Hamlyn, G. S.	5	0	
Harris, Mrs. Henry	10	0	
Harry, Capt. T. R.	5	0	
Hodge, Capt. John	5	0	
Johas, Mr. W.	5	0	
Joll, J. B.	5	0	
Jones, Rev. J. B.	10	6	
Morton, Capt. R.	5	0	
Pernewan, Mr. R.	5	0	
Phillips, Capt. J. G., the late	2	0	
Richards, Mr. George	5	0	
Robertes, The Right Hon. Lord	1	1	0
Rosewall, Mr. G. B.	5	0	
Rowe, Mr. James	5	0	
St. Aubyn, Sir John, Bart. M.P.	1	1	0
Staff, Dr.	5	0	
Stevens, Mr. D. F.	5	0	
Tremearne, Mr. J. N.	10	0	
Trewhidder, Mr. W. T.	10	0	
Trewhella, W.	5	0	
Tyacke, Rev. R. F.	10	0	
Vivian, A. Pendarves, Esq. M.P.	1	1	0
Wallis, Capt. S.	5	0	
Wasley, Mr.	5	0	
Williams, Mr. T. B.	5	0	
Williams, Mr. Geo.	5	0	
Sums under 5s. ....	2	19	0
<b>Total .....</b>	<b>£23</b>	<b>3</b>	<b>6</b>

**SCILLY ISLANDS BRANCH.**

President—			
T. ALGERNON SMITH DORRIN SMITH, Esq.			
Chairman—			
W. M. HOSKIN, Esq.			
Honorary Secretary—			
JOHN BANFIELD, Esq.			
Annual Subscriptions.			
Jackson, Mr. Aug.	10	0	
Smith, T. A. Smith Dorrien, Esq.	1	3	0
Hayn House Hotel	5	0	
Life-boat House and other Boxes, &c.	11	11	
<b>Total .....</b>	<b>£2</b>	<b>9</b>	<b>11</b>

## Cumberland.

### CARLISLE AND SILLOTH BRANCH.

Chairman—  
The MAYOR OF CARLISLE.

Honorary Secretary—  
JOHN STONACH, Esq.

#### Annual Subscriptions.

£.	s.	d.
Blair, Mr. Thomas	10	0
Carlisle, The Very		
Rev. the Dean of	1	1
Carr and Co. Messrs.	1	1
Committee, The Local, Silloth		7
Creighton, R. Esq.		10
Elliott, R. Esq. M.D.		10
Ferguson, J. C. Esq.		10
Ferguson, Rt. Esq.		
M.P.	1	0
Harrison, W. Esq.	1	0
Hope, Mrs. Joseph		10
James, Isaac, Esq.		10
Lawson, Sir W. Bart.		
M.P.	1	0
Little, Miss		10
Maxwell, Mr. Wm.		10
Page, W. B. Esq.	1	0
Redford, Rev. F. M. A.		10
Standish, E. R. W. P.		
Esq.	1	0
Sutton, Wm. Esq.		10
<b>Total</b>	<b>12</b>	<b>12</b>

#### Donations.

Contribution Pillar		
Box	2	1
Contribution Box, Boat-house and other Boxes	1	10
<b>Total Dons.</b>	<b>3</b>	<b>12</b>
<b>Total Subs.</b>	<b>12</b>	<b>12</b>
	<b>£16</b>	<b>4</b>

### MARYPORT BRANCH.

Chairman—  
H. P. SETHOUSE, Esq., J.P.

Honorary Secretary—  
W. H. ECKERSLEY, Esq.

#### Annual Subscriptions.

A Friend, W. P. S.	5	0
Addison, John, Esq.	5	0
Brayton Coal Co.	1	1
Brown, Mrs.	10	0
Campbell, John, Esq.	10	0
Carrol, Rev. John	10	0
Collin, P. de E. Esq.	10	0
Crosby Colliery Co.	1	1
Eckersley, W. H.	5	0
Graham & Co. Messrs.	10	0
Hewitson, Mrs.	10	0
Hine Bros. Messrs.	10	6
Kenyon, H. Esq.	10	0
Mark, Jos. Esq.	10	0
Maryport Hematite Iron Co.	1	1
Melmore, John	5	0
Pearson, Dr.	10	0
Penrice, Jas. Esq.	5	0
Ritson, Messrs. Robt. and Co.	1	1
Robinson, Jos. Esq.	10	0
Senhouse, H. P. Esq.		
J.P.	1	1
Sewell, Mrs.	5	0
Solway Hematite Iron Co.	1	1

£.	s.	d.
Tomlinson, J.	5	0
Tyson and Hobson, Messrs.	1	0
Wilson, Robert, Esq.	1	0
Wilson, Mr. Wm.	5	0
Wood, Mr. J. H.	5	0
Wood, William Wilson, Esq.	5	0
<b>Total</b>	<b>16</b>	<b>7</b>

#### Donations.

Box in H.M. Customs, Maryport	2	0
Ditto Golden Lion Hotel		8
Excelsior Lodge of Odd Fellows, Maryport	1	0
	<b>£19</b>	<b>15</b>

### WHITEHAVEN AND SEASCALE BRANCH.

Patron—  
The Right Hon. the EARL OF LONSDALE.

Treasurer and Hon. Sec.—  
Capt. DAVID BORROWDALE, 34 Scotch Street.

Collector—  
L. BORROWDALE, 16 Woodville Terrace.

#### Annual Subscriptions.

Lonsdale, The Right Hon. The Earl of	5	5
Adair, Mr. J.	5	0
Ainsworth, Mr. D., M.P.	10	6
Ainsworth, Mr. J. S.	10	6
Ainsworth, Mr. T.	1	0
Atkinson, Mr. H.	5	0
Atter, Mr. E.	10	6
Barker, Mrs. A.	1	0
Bedford, Mr.	5	0
Bentinck, Right-Hon. G. A. C., M.P.	1	1
Brackenbridge, T. & Co.	5	0
Brockbank, Mr. Jas.	10	0
Brown, Mr. T.	10	0
Buckham, Mrs.	10	0
Burnyeat, Mr. W.	10	6
Cameron, Mr. Peter.	1	0
Capt. and Officers s.s. Henry Schotfield	8	0
Collins, Mr. J.	5	0
Collis, Mr. Isaac	10	0
Cousins, Mr. R.	5	0
Crossfield Iron Ore Co.	1	0
Davis, Mr. John	5	0
Dees, Mr. James G.	10	0
Dickinson, Mr. J. N.	5	0
Dixon, Mr. T. C.	10	0
Feldtman & Co. Messrs. R.	1	1
Fisher, Mr. Charles	1	0
Fletcher, Mr. H. A.	10	0
Furness Railway Co.	2	0
Gordon & Todhunter, Messrs.	5	0
Hampton Brothers, Messrs.	5	0
Hellou, Mr. John S.	10	0
Helder, Mr. A.	5	0
Hodgetts, Mr. A.	1	1
Hodgson, Capt. Isaac	5	0
Howson, Mr. Thos.	10	0
Hudson, Mr. T.	1	0
Ianson, Dr.	10	0
Jackson, Mr. George	5	0
Jackson, Mr. John	5	0
Jackson, George, & Co.	5	0
Jackson, Mr. T.	5	0
Jacques, Capt.	1	1
Jefferson, Messrs. R. and H.	1	0

£.	s.	d.
Jenkins, Mr. John	10	0
Johnson, the Misses	1	0
Leconfield, Lord	1	0
Lindow, S. & J.	2	2
Little, James & Co., Barrow (per Mr. E. Eddis)	1	1
Lumb, Mr. W. W.	10	0
Mackenzie, Mr. H. M.	1	0
McKelvie, Mr. John	10	0
McGowan, Messrs. J. A. & W.	5	0
Metcalf and Jackson, Messrs.	5	0
Moore & Co. Messrs.	10	0
Mossop, Mr. J. B.	5	0
Muncaster, Lord	5	0
Murray, Miss	5	0
Musgrave, Mr. John	1	0
Musgrave, Mr. J. R.	10	0
Nicholson, Mr. J.	5	0
Nicholson, Mr. T.	5	0
Pearson, John & Son	5	0
Poslethwaite, Mr. J.	10	0
Poslethwaite, Mr. M.	10	0
Rigg & Co. Messrs.		
C. A.	5	0
Robinson, Mr. J. H.	1	0
Robinson, Mr. R. A.	10	0
Russell, Mr. John	5	0
Scott, Mrs.	5	0
Senhouse, Miss	10	0
Sparrow, Mr.	5	0
Spencer, Major	1	0
Sterling, Mr. John	2	2
Steward, Mr. A. B.	1	0
Thompson, Mr. A.	10	0
Thompson, Miss	1	1
Turner, Mr. W. B.	1	1
Vivian, Mr. John	5	0
Walker, Mrs. R.	1	0
Walker, Mr. Wm.	5	0
Whiteside, Mr. H. J.	5	0
Whittle & Son, Messrs.	5	0
Wilson and Kitchin, Messrs.	10	0
Winder Iron Ore Co.	1	1
Whitehaven, Trustees of the Port of	10	0
Wordsworth, Rev. J.	10	0
Sums under 5s.	3	5
<b>Total</b>	<b>79</b>	<b>15</b>

Robinson, Mr. J. H.	1	0
Robinson, Mr. R. A.	10	0
Russell, Mr. John	5	0
Scott, Mrs.	5	0
Senhouse, Miss	10	0
Sparrow, Mr.	5	0
Spencer, Major	1	0
Sterling, Mr. John	2	2
Steward, Mr. A. B.	1	0
Thompson, Mr. A.	10	0
Thompson, Miss	1	1
Turner, Mr. W. B.	1	1
Vivian, Mr. John	5	0
Walker, Mrs. R.	1	0
Walker, Mr. Wm.	5	0
Whiteside, Mr. H. J.	5	0
Whittle & Son, Messrs.	5	0
Wilson and Kitchin, Messrs.	10	0
Winder Iron Ore Co.	1	1
Whitehaven, Trustees of the Port of	10	0
Wordsworth, Rev. J.	10	0
Sums under 5s.	3	5

<b>Total</b>	<b>£80</b>	<b>18</b>
--------------	------------	-----------

### WORKINGTON BRANCH.

Chairman—

CHARLES J. VALENTINE, Esq.  
Honorary Secretary—  
J. C. THOMPSON, Esq.

#### Annual Subscriptions.

Alexander, Miss	10	0
Bell, Capt. Thomas	5	0
Bouch, the Misses	2	0
Brought, J. A.	5	0
Clifton, Rev. C. W.	10	0
Crosthwaite, Thomas	10	0
Derwent Iron Co., The	10	0
Dickinson, Wm., J.P.	10	0
Douglas, P. S.	10	0
Fisher and Sprout	1	1
Gambles, John	10	0
Graham, George	5	0
Griffiths, William	10	0
Hodgson, R. H.	10	0
Iredale Brothers	1	0
Kirk Brothers	10	0
Milburn, Tom	10	0

£.	s.	d.
Mordy, John	5	0
Mordy, William	1	0
Moss Bay Company, The	3	3
Ormerod, F.	10	0
Patten, Capt.	10	0
Peile, Alfred	10	0
Robinson, Capt. R.	5	0
Salters, M.	5	0
Saunders, G. F.	5	0
Scott, Mrs. Isaac	10	0
Scott, W. G.	5	0
Snelus, G. J.	5	0
Sprott, Capt. John	10	0
Thompson, R. S., J.P.	10	0
Thompson, J. C.	10	0
Thompson, Mrs.	5	0
Thompson, the Misses	10	0
Thornley, Rev. J. J.	5	0
West Cumberland Iron and Steel Co.	10	0
Wallace, J. R.	10	0
Whitelock, R. W.	5	0
Wilson, William	5	0
Sums under 5s.	1	4
<b>Total</b>	<b>£23</b>	<b>13</b>

#### Donations.

Money in Boxes	1	11
Williamson, R. & Sons	10	0
	<b>£25</b>	<b>14</b>

## Denbighshire.

### LLANDDULAS BRANCH.

Chairman—

ANDREW DOYLE, Esq.

Honorary Secretary—

REV. J. DAVIES, M.A.

#### Annual Subscriptions.

£.	s.	d.
Davies, Rev. J.	1	0
Doyle, A. Esq.	2	0
Hesketh, R. B. Esq.	5	0
Kneeshaw & Co., Messrs.	5	0
Llanddulas Quarry Company	5	0
<b>Total</b>	<b>£18</b>	<b>0</b>

## Derbysire.

### BELPER BRANCH.

Chairman—

H. LOMAS, Esq.

Treasurer—

W. WINTERBOURNE, Esq.

Honorary Secretary—

W. P. ADSHEAD, Esq.

#### Annual Subscriptions.

£.	s.	d.
Adshead, Mr. W. P.	1	1
Adshead, Mrs. W. P.	10	6
Adshead, Miss W. P.	10	6
Adshead, Mr. G. H.	5	0
Anthony, Mr. W. B.	10	0
Bourne, Mrs.	1	1
Calvert, Mr.	5	0
Friend, Rev. F.	5	0
Hanson, Mr.	10	0
Hogg, Mr. F.	5	0
Hogg, Mr. J. M.	5	0

Table listing names and monetary contributions for the Derby Branch, including Hunter, Mr. J., Lloyd, Rev. R. L., and others, with a total of £14 1 0.

DERBY BRANCH.

Table listing names and monetary contributions for the Derby Branch, including Treasurer William Peat, Esq., and various subscribers, with a total of £37 11 0.

Devonshire.

BARNSTAPLE AND BRAUNTON BRANCH.

Table listing names and monetary contributions for the Barnstaple and Braunton branch, including Alford, Mr. Wm., Avery, W. Esq., and others, with a total of £53 11 10.

Table listing names and monetary contributions for the Bideford and Appledore branch, including Crosse, R. J. Esq., Darracott, Mr. E. J., and others, with a total of £43 13 0.

BIDEFORD AND APPLEDORE BRANCH.

Table listing names and monetary contributions for the Bideford and Appledore branch, including E. U. Vidal, Esq., and others, with a total of £53 6 0.

Table listing names and monetary contributions for the Dartmouth branch, including Charlewood, Admiral, Churchward, Rev., and others, with a total of £53 6 0.

Table listing names and monetary contributions for the Dartmouth branch, including Junior School, United Services College, and others, with a total of £55 9 4.

GLOVELLY BRANCH.

Table listing names and monetary contributions for the Gvelly branch, including Chairman N. H. Fane, Esq., and various subscribers, with a total of £20 6 0.

DARTMOUTH BRANCH.

Table listing names and monetary contributions for the Dartmouth branch, including Charles Chalker, Esq., and others, with a total of £20 6 0.

## BRANCHES—LIST OF ANNUAL SUBSCRIPTIONS AND DONATIONS. 331

	£.	s.	d.
The Balmoral Castle	1	1	0
Box at Post Office	—	15	6
Do. Sands Hotel	—	18	6
Do. Kingswear Station	—	8	6

Total Dons	9	12	6
Total Subs.	2	11	6

£12 4 0

## DAWLISH BRANCH.

Chairman—  
SIR J. DUNTZE, BART.

Treasurers—  
ALEX. McCASLAND, Esq.  
C. H. TURNER, Esq., J.P.

Honorary Secretary—  
J. B. PIKE, Esq.

Collector—  
MR. DAVID PHELAN, R.N.

## Annual Subscriptions.

Adams, Miss	—	5	0
Bartlett, Mr. E. B.	—	10	0
Bughaw, Mrs. F.	—	10	0
Benbow, Col.	—	1	0
Brett, Capt. R.N.	—	10	6
Brown, Mr. R. N. G.	—	10	6
Collins, Miss	—	1	1
Craigie, Mrs.	—	1	1
Ditto (1879)	—	1	1
Dolman, Mr. F.	—	10	0
Doxat, Lieut., R.N.	—	10	0
Duntze, Sir J., Bart.	—	1	0
Ermen, Mr. P.	—	10	0
Ermen, Mr. G.	—	10	0
Ferris, Mr. R.	—	10	6
Fortiscae, M. (Judge)	—	1	0
Grace, Mrs.	—	10	0
Grace, Miss	—	10	0
Holland, Mrs. J.E.	—	2	2
Holt, Mr.	—	5	0
Hughes, Col.	—	10	6
Jackson, Major	—	1	1
Lea, Mr. Thomas	—	5	0
Manley, Rev. O.	—	5	0
Marshall, Miss	—	5	0
Maye, Mrs.	—	10	0
Maye, Mr. Thos.	—	1	1
Mayne, Rev. Jas.	—	10	0
McCasland, Mr. A.	—	10	0
Moss, Mr.	—	10	6
Nuthall, Miss	—	10	0
Pennell, Mr.	—	5	0
Pike, Mr. John B.	—	17	0
Pike, Mr. W. Jupp	—	10	6
Porter, Mr. H. A.	—	10	0
Riach, Colonel	—	2	2
Robertson, Miss	—	1	1
Short, Mrs.	—	10	0
Strickland, Miss	—	1	0
Sweet, Colonel	—	5	0
Tebbit, Mr. W.	—	1	1
Turner, Mr. C. H.	—	1	1
Ware, Mrs.	—	10	0
Welsh, Mr.	—	10	0
Whidborne, Mr. J.S.	—	10	0
Wiley, Mr. J. W.	—	10	0

Total.....36 7 0

## Donations.

Douglas, Lady	—	1	0
Marshall, Miss	—	5	0
Millman, Mrs.	—	5	0
Sneyd, Mr. Thos.	—	5	0
Tebbit, Mr. W.	—	5	0
Ware, Mrs.	—	5	0
Sums under 5s.	—	1	10

Pillar and Collecting  
Boxes.....4 4 5

Total Dons.....7 19 5

Total Subs.....36 7 0

£44 6 5

## EXETER BRANCH.

President—

The Right Hon. the EARL  
OF DEVON.

Honorary Treasurers and  
Secretaries.

T. B. GIBBS, Esq.  
COURTENAY H. EDMONDS,  
Esq.

## Annual Subscriptions.

	£.	s.	d.
Acland, Sir T. D.	1	1	0
Arden, Mrs.	—	1	0
Barnes, W. Esq. Jun.	1	1	0
Barton, Hy. D. Esq.	—	5	0
Belfield, J. Esq.	—	1	0
Bond, Miss	—	5	0
Boyd, Very Rev. Dn.	1	1	0
Bremridge, Miss	—	1	0
Brice, Mrs.	—	5	0
Bridges, Mrs.	—	1	0
Bullivant, J. Esq.	—	1	0
Cardew, Mrs.	—	5	0
Cridland, Mrs.	—	2	6
Crome, Mr.	—	5	0
Cuthbertson, W. Esq., J.P.	—	5	0
Churchill, Miss.	—	2	0
Dawson, Mrs.	—	5	0
Dickens, Capt.	—	10	0
Drake, Dr.	—	5	0
Drake, Mr.	—	5	0
Ellis, Rev. R.	—	5	0
Evans, Miss	—	2	6
Follett, J. C. Esq.	—	1	1
Gard, Mrs.	—	1	1
Geare, J. Esq.	—	5	0
Gibbs, T. B. Esq.	—	10	0
Grav, W. Esq.	—	5	0
Green, E. Esq.	—	5	0
Hooper, Smith, Esq.	—	5	0
Hoskins, Rev.	—	5	0
Huxham, C. Esq.	—	1	0
I'Anson, J. Esq.	—	10	0
Kennaway, Miss A.	—	1	0
Lee, Canon	—	10	6
Lloyd, H. Esq.	—	10	6
Martyn, H. Esq.	—	10	0
Mason, Browne, Esq.	—	5	0
Mathews, Miss	—	5	0
Milford, J. Esq.	—	1	0
Milford, Miss	—	10	0
Milne, Mr.	—	5	0
Morris, Mrs.	—	5	0
Mortimer, Major	—	5	0
Norman and Pring, Messrs.	—	1	0
Payne, Major	—	5	0
Pinder and Tuckwell, Messrs.	—	5	0
Sanders, R. Esq.	—	1	1
Segan, Mrs.	—	5	0
Smith, Mrs.	—	5	0
Snow, E. Esq.	—	10	6
Thorpe, Mrs. T. R.	—	1	0
Thomas and Co., Messrs. J. L.	—	10	6
Tremlett, Miss (2 yrs.)	—	2	0
Tucker, C. Esq.	—	5	0
Tucker, J. S. Esq.	—	5	0
Turner, Mrs.	—	10	0
Varwell, Mr.	—	5	0
White, Rear-Admiral	—	1	0
Wilcocks, Weston, & Dinham	—	1	1
Williams, Mr.	—	5	0
Wimble, Mrs.	—	1	0
Wilson & Son, Messrs.	—	5	0
Wippell, Mr. C. J.	—	10	0
Wippell, J. Esq.	—	5	0
Sums under 5s.	—	4	4

Total.....46 6 0

## Donations.

Clapp, W. Esq.	—	5	0
Offertory at St. Mary Arches, per Rev. A. H. Hamilton.	—	10	7

£47 1 7

## EXMOUTH BRANCH.

Patroness—

The Right Hon. LADY ROLLE.

Chairman—

CHARLES PRETTJOHN, Esq.

Honorary Secretary—

Capt. C. SQUIRRE.

Collector—

Mr. E. GARD.

## Annual Subscriptions.

	£.	s.	d.
A Friend	—	5	0
Abbott, Misses	—	5	0
Adams, H. C. Esq.	—	10	0
Agazis, Mrs.	—	5	0
Allen, Mr.	—	5	0
Arcscott, G. Esq.	—	5	0
Barnes, Mrs.	—	5	0
Bartlett, General.	—	10	0
Baldcock, Mrs.	—	5	0
Bazalgette, Col. C.	—	10	0
Bovans, T. P. Esq.	—	10	0
Birch, C. Esq.	—	10	0
Bligh, F. I. Esq.	—	10	0
Boase, —, Esq.	—	10	0
Breamidge, Mrs.	—	5	0
Brent, Miss	—	5	0
Browning, Mrs.	—	1	1
Browning, Mrs.	—	5	0
Bridge, Major	—	5	0
Bryce, J. P. Esq.	—	1	0
Buller, Misses	—	10	0
Bundock, The Misses	—	1	0
Carr, Rev. C. R.	—	10	0
Campbell, Mrs.	—	5	0
Chown, W. C.	—	5	0
Cooke, F. Esq.	—	1	0
Cooke, Miss.	—	5	0
Copleston, Miss	—	5	0
Claggett, Major	—	5	0
Cleave, Mrs. C.	—	10	0
Cole, E. S. Esq.	—	1	0
Crompton, S. Esq.	—	5	0
Darke, A. J. Esq.	—	5	2
Dawson, Chas. Esq.	—	5	0
Devon, The Earl of	—	1	0
Dicken, Mrs. Row- land	—	5	0
Drake, Lady Elliot	—	10	0
D'Urban, Mrs.	—	10	0
Dumbleton, H. Esq.	—	10	0
Ellicombe, Miss	—	5	0
Ensor, the Mis-ess	—	5	0
Elwes, Rev. W.	—	5	0
Ewen, A. B. Esq.	—	5	0
Foster, G. Esq.	—	5	0
Freeman, Rev. R.	—	10	0
Freeman, Rev. R.	—	10	0
Fulford, J. D. Esq.	—	5	0
Gordon, J. Esq.	—	1	0
Grant, H. Esq.	—	5	0
Grenfell, Admiral S., C.B.	—	5	0
Hall, Major	—	10	0
Hamilton, A. K. Esq.	—	5	0
Harborough, Countess of	—	5	0
Hecks, R. P. Esq.	—	10	0
Hill, Miss	—	10	0
Holman and Sous (2 years)	—	4	0
Hull, Mrs.	—	5	0
Hussey, Col.	—	10	0
J. B. N.	—	5	0
Jameson, Miss F. E.	—	5	0
Johnson, E. Esq. M.P.	—	1	0
Johnstone, Miss	—	5	0
Langley, John, Esq.	—	5	0
Lee, Miss.	—	10	0
Land, Mrs.	—	5	0
Lipscomb, Rev. F.	—	5	0
Long, Mrs.	—	10	6
Malet, Rev. D. S.	—	5	0
Moore, Miss	—	5	0
Paidoe, A. Esq.	—	5	0
Parnell, Miss.	—	5	0
Patrick, the Misses.	—	5	0
Perry, T. P. Esq.	—	1	0
Pennel, Miss	—	10	0

	£.	s.	d.
Peters, W. H. Esq.	—	10	0
Phear, Sir John	—	1	1
Prettjohn, Col.	—	5	0
Prettjohn, C. Esq.	—	5	0
Purcell, Rev. W.H.D.	—	10	0
Pycroft, G. Esq.	—	10	0
Pycroft, Mrs.	—	5	0
R. E. B. G.	—	10	0
Ravenscroft, Mrs.	—	5	0
Roberts, Lady	—	10	0
Robertson, Misses	—	5	0
Rolle, Hon. Mark (3 years)	—	3	15
Shirreff, Dr. J. W.	—	5	0
Speke, — Esq.	—	10	0
Spetigue, J. Esq.	—	10	0
Squire, Capt.	—	5	0
Smith, Howard S. Esq.	—	10	0
Terry, H. M. Esq.	—	10	0
Trail, D. Esq.	—	10	0
Trehane, W. Esq.	—	5	0
Turnbull, G. W. Esq., M.D.	—	5	0
Turnour, W. Esq.	—	5	0
Upton, Capt.	—	10	0
Walrond, Col. M.P.	—	1	0
Webster, Miss.	—	5	0
Welland, Mrs.	—	5	0
Winterbotham, J. B. Esq.	—	5	0
Wippell, Rev. W.	—	10	0
Wood, J. Esq.	—	10	0
X. Y. Z.	—	5	0
Sums under 5s.	—	18	7

Total.....£73 1 0

## Donations.

Pillar and Collecting  
Boxes.....5 1 3

£78 2 3

## ILFRACOMBE AND MORTE BRANCH.

Chairman—

P. STONEHAM, Esq.

Honorary Secretary—

N. VYE, Esq. J.P.

## Annual Subscriptions.

Adams, J. Esq.	—	10	6
Blandy, Mrs.	—	1	1
Butcher, L. G. Esq.	—	5	0
Corrie, Misses	—	1	1
Chanter, Rev. J. M.	—	5	0
Clay, Mrs. Sherard	—	5	0
Darbyshire, C. Esq.	—	10	6
Down, Mrs.	—	5	0
E. A. P.	—	5	0
Faber, Mrs.	—	5	0
Foquett, H. R. Esq.	—	10	0
Gardner, F. Esq.	—	5	0
Gilbert, J. P. Esq.	—	5	0
Hicks, G. W. Esq.	—	5	0
Hooper, Miss	—	5	0
Hooper, Mrs.	—	10	0
Hotel Co.	—	5	0
Hosken, Admiral	—	10	0
Howland, J. Esq.	—	5	0
Huxtable, Captain	—	5	0
Huxtable, Mr. R.	—	5	0
Jenkinson, Misses	—	1	0
Leigh, General	—	5	0
Leman, Misses	—	10	0
Man, J. L. Esq.	—	10	0
Martin, Miss A.	—	10	6
Maule, G. N. Esq.	—	1	1
Maunder, Mrs.	—	5	0
Mello, Miss C.	—	2	0
Milligan and Co.	—	5	0
Mish, J. G. Esq.	—	10	0
Prevost, Mrs. A. E.	—	1	1
Pemell, Jas. Esq.	—	5	0
Richard, Mr. P.	—	5	0
Sale, D. Esq.	—	5	0
Sopwith, Mrs.	—	10	0
Stephens, Admiral.	—	10	0
Stoneham, P. Esq.	—	1	1

Swain, Captain	£.	s.	d.
Vye, N. Esq.	1	0	0
Wingrove, Mrs.	10	0	0
Wright, Rev. Harry	1	0	0
Wren, Miss	10	0	0
Welch, T. Esq.	5	0	0
Yelland, R. E. Esq.	10	0	0
Sums under 5s.	3	4	6

Total ..... 28 3 0

**Donations.**

Boyd, Mr.	5	0	0
Bright, Mr. H.	5	0	0
Broughton, Lieut. C.D.	1	0	0
Bruce, Mr.	5	0	0
Chatto, W. J. P. Esq.	10	0	0
Crookes, J. Esq.	5	0	0
Dickenson, C. H. Esq.	10	0	0
F. W. P.	5	0	0
Gladstone, D.	5	0	0
Hole, T. Esq.	1	0	0
Houlstone, Mrs.	5	0	0
Ilfacombe Amateur Dramatic Society	5	0	0
M.	5	0	0
Peak, A. Esq.	1	0	0
Robertson, Mrs.	10	0	0
S. S. G.	10	0	0
Teape, C. A. Esq.	5	0	0
Thomas, S. Esq.	10	0	0
Watkin, Lady	5	0	0
Watson, Rev. T. H.	5	0	0
Wheeler, Mr. J.	5	0	0
Wigran, Mr. F.	5	0	0
W.	12	0	0
8, Lastone Terrace. Collected by Mrs. Groves, 3 Quay, Ilfacombe.	1	16	0
Sums under 5s.	16	1	0
Contribution Boxes.	21	5	5

Total Dons. .... 53 14 5

Total Subs. .... 26 3 0

£79 17 5

**LYNMOUTH BRANCH.**

Honorary Secretary—  
Mr. JOHN CROOK.

**Annual Subscriptions.**

Baker, Mr.	10	0	6
Bevan, Mr.	5	0	0
Crook, Mr.	10	0	6
Halliday, W. H. Esq.	1	0	0
Hartley, C. Esq.	10	0	6
Heywood, Mr.	10	0	6
Jones, Mr. T.	10	0	6
Kennett, E. Lean, Esq.	1	0	0
Medway, Mr.	10	0	6
Middleship, — Esq.	1	0	0
Riddell, W. K. Esq.	10	0	6
Whitehead, Mrs.	1	1	0
Sums under 5s.	10	0	0

Total ..... 8 10 0

**Donations.**

F. J.	10	0	0
Albrecht, Mr.	5	0	0
Channing, Mr.	5	0	0
Oakley, Mr.	5	0	0
D'Cossin, Capt.	5	0	0
Hunter, Major	5	0	0
M. A. H.	5	0	0
Ditto	2	6	0
Rippinghall, — Esq.	1	0	0
Roberts, Misses	5	0	0
Contribution Boxes.	2	10	9
Sums under 5s.	14	0	0

Total Dons. .... 16 3 3

Total Subs. .... 8 10 0

£24 13 3

**NEWTON ABBOT BRANCH.**

Honorary Secretaries—  
Captain F. D. BEWES,  
Mr. R. L. LLOYD.

**Annual Subscriptions.**

Baker, R. H. M. Esq.	10	0	0
Bearne, Mr. J. S.	5	0	0
Bewes, Capt.	10	0	0
Bradnee, Mrs.	5	0	0
Cornish, Mrs.	5	0	0
Devon and Courtenay Clay Co.	1	1	0
Francis, Robt. Esq.	10	0	0
Harris, Rev. S. G.	5	0	0
Rae, Lady	5	0	0
Taylor, Gen. Reynell	1	0	0
Wall, Miss.	1	0	0
Warner, Rev. G. Townsend.	1	0	0
Watta, Blake, Bearne, and Co.	1	1	0
Sums under 5s.	3	11	0

Total ..... 11 8 0

**Donations.**

Armstrong, Dr. Leonard	5	0	0
Beachey, H. G. Esq.	10	0	0
Lifeboat Pillar Box	1	12	3
Price, R. C. Esq.	5	0	0
Sums under 5s.	3	9	6

Total Dons. .... 6 1 9

Total Subs. .... 11 8 0

£17 9 9

**PORT OF PLYMOUTH BRANCH.**

Chairman—  
ADMIRAL H. D. HICKLEY.

Treasurer—  
THOS. JONES STEVENS.

Honorary Secretary—  
JOHN SADLER.

**Annual Subscriptions.**

Adams and Son.	10	0	0
Adams, B.	5	0	0
Adams, Clark, and Lindon	10	0	0
Allen, John	10	0	0
Arliss, Ward	5	0	0
Ash, A.	10	0	6
Barker, Nathaniel	5	0	0
Barrett, G. R.	10	0	0
Bastow, T. W.	10	0	0
Beer, J.	5	0	0
Bennett, J. N.	5	0	0
Bewes, Rev. Thomas	1	0	0
Boger Hext.	10	0	0
Boulds, C. C.	10	0	0
Bourne, James	2	0	0
British & Irish Sugar Refining Co.	10	6	0
Brown, H.	1	1	0
Brown, Wills, and Nicholson	10	0	0
Burnard, Lack & Alger	1	0	0
Butt, W. and Co.	5	0	0
Carpenter, Richard	5	0	0
Chubb, Mrs.	5	0	0
Clark, W.	10	6	0
Coates and Co., Distillery	1	1	0
Coles, S. J.	1	0	0
Collier Brothers	1	1	0
Cridland, E. F. (4 years)	1	0	0

Crossing, J.	5	0	0
Crowther, A.	5	0	0
Cuddeford, T.	10	0	0
Curgenven, Mugford, and Kendall	10	0	0
Davies, Edward	10	0	0
Derry and Co.	10	0	0
Devon and Cornwall Banking Co.	1	1	0
Dupré, John	5	0	0
Eads, John	5	0	0
Edgcumbe, Mount, Earl of	1	1	0
Edmonds and Son	10	0	0
Elworthy, Curtis, and Dawe	10	0	0
Foale and Son	10	0	0
Fowler, Mrs.	1	0	0
Fox, Eliot, and Co.	10	0	0
Fox, Sons, and Co.	10	0	0
Gard, E. O.	5	0	0
Gas Co., Plymouth	2	0	0
Gidley, G.	5	0	0
Goldfinch, Mrs.	5	0	0
Goldsmith, J. P.	10	0	0
Goulding, F. H.	10	0	0
Greaves, Rev. H. A.	5	0	0
Greenway, John	10	0	0
Hare, Hon. Colonel	10	0	0
Harvey, E.	10	0	0
Harvey, J. & T.	1	1	0
Haycroft and Pethick	10	0	0
Hearder and Son	5	0	0
Heywood, Henry	10	0	0
Hickley, Adm. H. D.	1	0	0
Hicks and Co.	10	0	0
Hoare, Henry	5	0	0
Hodge, W. & Co.	1	0	0
Holmes, Mrs. A. E.	10	0	0
Hubbard, A.	10	0	0
Hubbard, G.	10	0	0
Hurrell and Co.	5	0	0
Hyne, Simon	5	0	0
Jackman, William	5	0	0
James and Son, E.	2	0	0
James and Rosewall	10	0	0
James, J. S.	5	0	0
Joll, W.	10	0	0
Keen, Edmund	5	0	0
King, James	10	0	0
Lansdown, T. W.	10	0	0
Lethbridge, J.	5	0	0
Liscombe, R. L.	1	1	0
Lloyd, S. S.	1	1	0
Lott, Misses	10	0	0
Lowe, Admiral	1	1	0
Loye, P. and Co.	5	0	0
Luce, W.	10	0	0
Luscombe, Bellamy, and Co.	1	1	0
Margary, P. J.	1	0	0
Marshall, E.	5	0	0
Marshall, W.	5	0	0
Matthews, Henry	10	0	0
Matthews, J. W.	5	0	0
Maynard, H.	5	0	0
Melhuish, E.	5	0	0
Monk, J. E.	5	0	0
Moore, James	1	1	0
Morrish, F. A.	5	0	0
Morshead, Capt., R.N.	1	1	0
Mortimer, J. F.	5	0	0
Nathan, Jacob	1	9	6
Naval Bank	1	1	0
Newcombe, J. R.	10	0	0
Norrington, Charles, and Co.	1	1	0
Page, Keen, and Page	10	0	0
Parkhouse, S., and Sons	5	0	0
Pearn, E. A.	2	2	0
Pearn, F.	1	1	0
Peek, W.	1	1	0
Penrose, E. A.	5	0	0
Pethick, J.	10	0	0
Phillips, Capt.	10	0	0
Picken and Co.	10	0	0
Pillman, J.	5	0	0
Pitts, Son, and King	5	0	0
Polkinghorne, Mrs.	5	0	0
Popham, Radford, & Co.	10	0	0

France, Dr.	1	0	0
Ralph, A.	5	0	0
Rendle, T., and Co.	5	0	0
Rew and Co.	10	0	0
Rolston, J. M.D.	5	0	0
Rolston, G. T.	5	0	0
Rooker, Miss.	10	0	0
Rooney, J.	5	0	0
Röwse, W.	10	0	0
Rundte, G.	5	0	0
Rundle, Rogers, and Brook	1	1	0
St. Aubyn, Sir J.	1	1	0
Saltast Corporation	1	1	0
Shapley and Co.	5	0	0
Shelly, John	5	0	0
Shilston, Wm.	5	0	0
Skardon, C.	5	0	0
Skardon, W.	5	0	0
Smith, Jno.	5	0	0
Sparrow, B., and Co.	1	1	0
Spearmen and Spearman	5	0	0
Spooner and Co.	1	1	0
Stanbury, F. R.	5	0	0
Steadman and Co.	10	6	0
Stephens, Robert	10	0	0
Stevens, J. hn	1	1	0
Stevens, Thos. Jones	1	1	0
Skidston, W.	5	0	0
Stoll, Mrs.	1	0	0
Stoneman & Square	5	0	0
Tanner, C. F.	1	0	0
Tanner, Mrs.	1	0	0
Thorold, Dr.	5	0	0
Treuby and Co.	10	0	0
Tremayne, H. H.	5	0	0
Tucker, Miss.	5	0	0
Tyeth, T. E.	5	0	0
Usborne, Capt.	10	0	0
Vosper, S.	5	0	0
Walters, C. H.	5	0	0
Watt, C.	5	0	0
Watt, R. J.	5	0	0
Watts, I.	5	0	0
Weary, J.	10	0	0
Webber, John	10	0	0
Western Counties Manure Co.	10	0	0
Westlake and Son	5	0	0
Whiteford, H.	5	0	0
Wilkinson, Rev. Dr.	10	0	0
Willoughby Brothers	10	6	0
Wills, Son, and Box	10	0	0
Wilson, Rev. C. M.A.	10	0	0
Windeat, J.	1	1	0
Windeat, Miss	10	0	0
Sums under 5s.	15	0	0

Total ..... 93 14 6

**Collecting Boxes, &c.**

H.M.S. Cambridge	0	10	0
Brown's Victoria Hotel	1	10	6
Chubb's Hotel	1	8	0
Dock Office	4	10	0
Harvey's Hotel	9	1	0
Hoare's "Rose and Crown"	8	3	0
Navy Hotel	8	9	0
Ramsden's Criterion	6	0	0
Royal Devonport	12	4	0
South Devon Railway	1	11	8
Thomas' Hotel, Devonport.	18	5	0
Small sums	9	2	0

Total Dons. .... 8 17 0

Total Subs. .... 93 14 6

£102 11 6



SALCOMBE & HOPE  
COVE BRANCH.President—  
The Right Hon. the  
EARL OF DEVON.Chairman—  
ROBERT HUBBELL, Esq.Honorary Secretary—  
W. H. WEBB, Esq.

Annual Subscriptions.

	£.	s.	d.
Balkwill, R. C. Esq.	1	0	0
Brown, Rev. Bevel	-	10	0
Cubitt, Wm. Esq.	5	0	0
Devon, Right Hon. the Earl of	5	0	0
Douglas, Mr.	1	0	0
Earle, Rev. and Ven. Archdeacon	1	1	0
Earle, Miss.	-	10	6
Foale, Mrs.	-	10	6
Hill, J. H. Esq.	-	10	6
Hurrell, John S. Esq.	1	0	0
Hurrell, Robert, Esq.	1	1	0
Hurrell, Mrs.	1	1	0
Ibert, Rev. P. A.	1	0	0
Kelly, Rev. Maitland	1	0	0
Netherton, R. L. Esq.	1	1	0
Newton, E. C. Esq.	1	0	0
Squires, John, Esq.	-	10	6
Turner, Misses	-	1	0
Twysden, Capt. R. N.	1	1	0
Twysden, Rev. Thos.	1	0	0
Webb, W. H. Esq.	-	10	6
Contribution box, South Sands	-	10	6
Total	£27	0	0

SIDMOUTH  
BRANCH.

Chairman—

The Rev. H. G. CLEMENTS,  
Vicar.Honorary Secretary—  
W. M. FLOYD, Esq.

Annual Subscriptions.

Balfour, The Masters	2	2	0
Barnard, F.	-	5	0
Clements, Rev. H. G. J.	1	1	0
Coulson, Bros.	-	10	0
Dunning, Messrs.	1	0	0
Fisher, Edward, Esq.	-	10	0
Floyd, W. M. Esq.	1	1	0
Gordon, Mrs.	1	1	0
Gore, Mrs.	-	5	0
Hine—Haycock, W. Esq.	1	1	0
Hooke, Mr. J. E.	-	5	0
Kennett—Were, T., Esq.	-	10	0
Kennett-Dawson, R. Esq.	-	10	0
King, J. G. Esq.	-	5	0
Macintosh, Mrs.	1	0	0
Majendie, W. Esq.	1	0	0
McArthur, Rev. C.	-	10	0
Mitchell, T. W. Esq.	-	10	0
Morshead, Rev. J. A.	1	1	0
Nicolas, Capt. Toup, R.N.	-	10	0
Pile, Mr. S. J.	-	5	0
Potbury, Mr. J.	-	5	0
Radford, Dr.	-	10	0
Radford, J. G. Esq.	-	10	0
Robinson, Rev. J.	-	10	0
Scott, George, Esq.	-	10	0
Thurton, Rev. R. T.	-	10	0
Trump, William	-	5	0
Vane, Mrs.	-	10	0
Warner, Miss	-	10	0
Webber, Mr. C. F.	-	5	0
Willcock, Robt. Peel, Esq.	-	10	0
Sums under 5s.	-	1	7
Total	£21	5	6

	£.	s.	d.
Donations.			
Addington, Major, the Hon. L.A.	-	5	0
A. I. T.	-	5	0
Bailey, Alfred Esq.	-	5	0
Bartelot, Capt. F.	-	10	0
Buttmer, G. Esq.	-	10	0
Ede, H. Esq.	-	5	0
Foe, the Misses	-	5	0
Grundy, Thomas Esq.	-	5	0
Hill, F. Esq.	-	5	0
Hawtreay, G. P. Esq.	-	5	0
Hood, R. Jacob Esq.	-	10	0
Marzetti, R. B. Esq.	-	5	0
Matthews, Mrs.	-	5	0
M. P.	-	5	0
May, Mrs.	1	0	0
Foote, Thomas Esq.	-	5	0
Sargant, Mrs. H.	-	10	0
Satow, S. A. M. Esq.	-	10	0
Sheffield, Mrs.	-	5	0
Smith, F. W. Esq.	-	5	0
Wilnot, Rev. Eardley— X. X.	-	10	0
Sums under 5s.	-	19	6

Total Dons. .... 9 4 6

Total Subs. .... 21 5 6

£30 10 0

TEIGNMOUTH  
BRANCH.

President—

The Rt. Hon. LORD HALDON.

Chairman—

B. A. ARNOLD, Esq.

Treasurer and Hon. Sec.—

J. W. BEATER, Esq.

Annual Subscriptions.

Arnold, B. A. Esq.	1	1	0
Barrows, Hill T. Esq.	-	10	0
Barrows, Col.	-	10	0
Beater, John, Mr.	-	5	0
Beavan, J. G. Esq., J.P.	-	10	0
Bergman, J. G. Esq.	-	10	0
Beuts, W. Esq.	-	5	0
Blake, G. P. Esq.	-	10	0
Brown, Lewis, Major, J.P.	-	10	0
Burrows, Hy., Esq.	1	0	0
Bushell, Capt. R.N.	-	10	6
Call, Mrs. G.	1	1	0
Chandless, Mr.	1	1	0
Clayton, Mr.	-	10	0
Collings, Mr. C. H.	-	10	0
Collins, C. R. Esq., J.P.	1	1	0
Cook, F. Esq.	-	10	0
Dawson, C. A. Esq.	-	10	0
Field, Mrs. O.	-	5	0
Fiamank, Capt. T.	-	10	0
Fripp, Miss.	-	10	0
Fry, Rev. James	-	5	0
Guerin, Colonel	-	10	0
Halford, Mrs.	-	5	0
Homer, Capt.	-	10	0
Huddleston, Mrs.	-	10	0
Hutchins, Rev. H.	-	10	0
Hutchings, Mr. T.W.	-	10	0
King, Miss.	-	5	0
Kersteman, J. S. Esq.	1	1	0
Langley, Miss.	-	1	0
Lysaght, Mr.	-	10	0
Marsh-Lunn, Mrs. Marsh	-	10	0
Moir, R. Esq.	-	10	6
Ogle, Rev. W. R.	-	5	0
Parson, Mrs.	-	10	0
Paul, Captain A.	-	10	0
Richards, Miss	-	10	0
Redman, Mrs.	-	5	0
Robin, John, Esq.	-	5	0
Rotherham, Mrs.	1	1	0

Rudkin, W. H.	-	5	0
Saunders, J. B. Esq.	-	10	6
Simson, Graham, Mrs.	1	0	0
Smyth, Rev. T. R.	-	10	0
Spencer, H. H. Esq.	-	10	6
Stayner, Mrs.	-	5	0
Taylor, J. Esq.	-	10	0
Teignmouth Harbour Commissioners	-	10	0
Templer, R. W. Esq.	-	10	0
Ward, Mr. G. P.	-	5	0
Whidborne, J. Esq.	-	1	0
Wood, C. H., Esq.	-	10	0
Woodhouse, Rev. U.	-	5	0
Wright, John, Esq.	-	10	0
Young, Col.	-	10	0
Smaller sums	3	1	0

Total..... 42 17 0

Donations.

Pillar and Life-Boat	-	-	-
Station boxes, &c. 14	4	0	0
Total	£57	1	0

## TORBAY BRANCH.

President—

The Rt. Hon. LORD CHESTER.

Honorary Secretary—

Rev. R. FENWICK ELLINGTON.

Annual Subscriptions.

Adams, Mr. C. T.	-	5	0
Apletree, Mrs. Russell	-	5	0
Bartlett, Mr. O. H.	-	5	0
Benbow, Mr. Vernon	-	5	0
Berthon, Capt.	-	5	0
Cook, Mrs.	-	10	0
Eales, Miss	-	10	0
Ellington, Rev. R. F.	-	5	0
Green, Mr. C.	-	5	0
Goodfellow, Dr.	-	10	0
Hall, Rev. J.	-	5	0
Hatch, Mrs.	-	5	0
Hogg, Mrs. Maxwell	-	10	0
Hunt, Mr. G.	-	10	0
Hunt, Mrs. G.	-	10	0
Kendrick, Mr. W. G.	-	5	0
Lakeman, Mr. T.	-	10	0
Patrick, Mr. W.	-	10	0
Poland, Rev. F. W.	-	5	0
Russell, Mrs.	-	10	0
Samuelson, Mr. B. M.P.	-	5	0
Smith, Mr. N.	-	5	0
Tanner, Mr.	-	5	0
Uniacke, Capt.	-	10	0
Sums under 5s.	4	1	0

Total..... £12 11 0

## TORQUAY BRANCH.

President—

The Rt. Hon. LORD HALDON.

Vice-President—

R. S. CARY, Esq.

Secretary and Collector—

Mr. R. G. COVE, of the Post

Office. Residence: Clifton

Villa.

Annual Subscriptions.

Abbott, Mrs.	-	5	0
Adams, Mrs. J.	1	1	0
Adams, Miss	1	1	0
Ainslie, W.	-	10	0
Ainsworth, Miss	-	5	0
Alexander, Mrs.	-	5	0
Aphorp, Mrs.	-	5	0
Arbutnot, Hon. Mrs.	1	0	0
Atkinson, Mrs.	-	5	0
Auldjo, T. R.	1	1	0

Baldwin, Miss	-	5	0
Baldwin, Mrs.	-	10	6
Bernard, Mrs. H.	-	5	0
Besley, the Misses	-	5	0
Best, Mrs. N.	-	5	0
Bevan, J. P.	-	10	0
Black, Miss	-	5	0
Blackwood, F.	-	10	0
Bogle, Mrs.	-	10	0
Boileau, Miss	-	5	0
Booth, Mrs.	1	0	0
Boothby, Miss	-	5	0
Borwick, G.	-	10	0
Boudier, General E. W.	-	10	0
Bowring, L. B.	-	5	0
Brand, Mrs.	-	5	0
Bridges, W.	-	10	0
Bridson, Major T. R.	1	1	0
Brisson, Mrs.	-	1	0
Brownlow, Colonel	-	10	0
Burchard, O.	-	10	0
Burdon, G.	-	2	0
Campbell, J., Possit.	-	10	0
Campbell, Mrs. A.	-	5	0
Campbell, the Misses	-	5	0
Carew, J. D. (the late)	1	1	0
Cartwright, the Misses	-	10	0
Cary, Mrs. Stanley	-	5	0
Cary, R. S.	1	1	0
Casavitti, J.	-	10	0
Casson, Rev. G.	-	5	0
Chapman, J.	-	5	0
Chapman, Rev. C.	1	1	0
Chatto, W. J. P.	2	0	0
Clark, R. A.	1	1	0
Clarke, Rev. T.	-	10	0
Clifford, Colonel M.	-	5	0
Cobb, J. F.	-	10	0
Cobham, Mrs.	-	5	0
Coggan, Miss	1	0	0
Cole, Miss	-	10	0
Cole, R.	1	0	0
Collett, C.	-	10	0
Combes, Miss	-	5	0
Coulson, F. R.	-	5	0
Coulthurst, J.	-	10	0
Coventry, Miss	-	10	0
Croker, E. J.	1	0	0
Cubitt, Geo., The Rt. Hon.	-	10	0
Dale, Mrs.	-	5	0
Davis, Rev. T. J. and Mrs.	-	10	0
Davis, Rev. W. B.	-	5	0
Daw, W. B.	-	10	6
De Mierre, Dr. (the late)	-	10	0
Dennistown, the Misses	-	5	0
Diggle, J.	-	10	0
Drane, Mrs.	-	10	0
Drinkwater, P. B.	1	1	0
Edmonstone, G.	1	1	0
Edwards, Rev. E.	-	5	0
Egerton, P.	-	5	0
Erle, Miss	1	1	0
Erskine, Dowager Lady	1	1	0
Everard, Miss	-	5	0
Farrer, M.	-	2	0
Felder, Miss.	-	5	0
Fisher, J.	-	5	0
Fisher, Miss M.	1	0	0
Fordyce, Mrs.	-	5	0
Fox, F. H.	-	5	0
Fradd, M.	-	10	0
Gamble, Miss	-	10	0
Gamble, Mrs. Henry	2	2	0
Gaston, Mrs.	-	5	0
Gibson, the Misses	-	5	0
Gibson, Mrs.	-	10	0
Gregor, Miss	1	1	0
Gretton, Rev. W. H.	-	5	0
Goodfellow, General.	-	5	0
Gooch, Miss	-	10	0
Gosse, P. H.	-	10	0
Gould, Miss	-	10	0
Grosvenor, Mrs.	-	10	0
Hagart, Mrs.	-	10	0
Haliburton, Mrs.	-	5	0
Hames, Mrs.	-	5	0
Hamplyn, Joseph	-	10	0

	£.	s.	d.
Hanbury, Sampson	1	0	
Hannay, R.	5	0	
Harvey, Mrs.	1	0	
Heath, Dr.	5	0	
Hewett, Rev. J.	10	0	
Hinde, Mrs.	5	0	
Hugonin, Mrs.	1	0	
Huxley, J. U.	10	6	
Ingham, Mrs.	5	0	
Jackson, J. M.	5	0	
Jamieson, Mrs. J. Audrey	5	0	
Jervoise, S. C. Clarke	1	1	0
Jolly, C. N.	10	0	
Johnson, James	5	0	
Kinnear, Mrs. G.	5	0	
Kinnoul, The Countess	10	0	
Kitson, John	10	0	
Kitson, William	10	0	
Knowles, R. M.	5	0	
Lambert, Mrs.	5	0	
Latham, Mrs.	5	0	
Latham, Mrs. R.	10	0	
Lavers, W.	10	0	
Lear, Thomas	5	0	
Le Breton, Mrs.	5	0	
Lee, J. E.	2	0	
Lillingstone, the Misses	15	0	
Lloyd, Mrs.	1	0	
Lombe, Dr. and Mrs.	10	0	
Louis, Mrs.	5	0	
Luscombe, J.	10	0	
Macaulay, the Misses	10	0	
Macgregor, Sir G. and Lady	10	0	
Macdougall, Lt.-Col.	5	0	
Maconchy, George	10	0	
Madden, Dr.	1	1	0
Maddison, Miss	10	0	
Manning, Capt. G.	10	0	
Martyr, Mrs.	1	0	
McGrath, Rev. Canon	5	0	
Meade, Spencer	10	0	
Midgley, Miss	5	0	
Mills, Mrs.	10	0	
Mills, Robert F.	10	0	
Mitchell, Mrs.	5	0	
Myers, Mrs.	1	1	0
Oldfield, Mrs.	5	0	
Pannel, C. L.	10	6	
Parker, C. E.	1	0	
Parker, W.	5	0	
Patteson, Miss	10	0	
Perkins, Capt. R.N.	1	1	0
Perks, H.	5	0	
Perrins, W. K.	10	0	
Phillipps, H. C. M. (the late)	1	0	
Phillips, Capt. Leigh	5	0	
Phillips, the Misses	1	0	
Popham, Mrs. A. L.	10	0	
Porter, L.	5	0	
Prater, Rev. T.	10	6	
Proctor, W.	5	0	
Pulford, A.	5	5	0
Ramsay, R. B. Ward-law	5	0	
Rawdon, Mrs.	2	0	
Reade, J. Page	5	0	
Reid, Dr.	5	0	
Remfry, G. F.	10	0	
Rich, Mrs.	5	0	
Ridley, Colonel.	5	0	
Robertson, Mrs.	1	0	
Robertson, Mrs. B.	5	0	
Robinson, Mrs. D.	5	0	
Rowe, H.	10	0	
Sanders, Mrs.	5	0	
Schuster, Mrs.	1	0	
Sealey	5	0	
Self, Rev. W. H.	5	0	
Sheppard, Mrs.	10	0	
Skeffington, the Hon. Mrs.	5	0	
Smith, Major-General	10	0	
Smithwick, Miss	1	10	0
Smithwick, Rev. W. J.	2	0	
Smyth, F. C.	10	0	
Saltau, John F.	10	0	
Southill, W. H.	5	0	

	£.	s.	d.
Splatt, W. F.	1	0	0
Squire, Capt.	10	0	0
Stanley, Mrs.	5	0	0
Stark & Co.	10	0	0
Stayner, F. H.	10	0	0
Stewart, N. B.	1	0	0
St. George, Mrs.	2	2	0
Stonestreet, F.	1	0	0
Sutherland, The Duchess	1	0	0
Swinburne, Capt. T.	1	0	0
Taylor, W. H.	1	0	0
Thompson, Mrs.	1	0	0
Thomson, Dr. Spencer	5	0	0
Tinney, Mrs.	10	0	0
Tombe, Canon H.	5	0	0
Tomlinson, Rev. J. P.	1	0	0
Trevar, E. F.	5	0	0
Tucker, Capt. Fane	5	0	0
Turnbull, Colonel	5	0	0
Turnbull, Miss	10	0	0
Whidborne, the Misses	10	0	0
Warrington, Miss	1	0	0
Wilson, W. (the late)	10	0	0
Wilton, C. F.	1	0	0
Walker, Mrs. R.	5	0	0
Weymouth, Captain	5	0	0
Wilks, Dr.	1	1	0
Warneford, Dr. C.	5	0	0
Woodhouse, W. S.	10	0	0
Webster, James	5	0	0
Whiteaway and Ball	10	0	0
Walker, Miss	1	0	0
Weir, Miss	10	0	0
Total	£127	19	6

Donations.			
Bolingbrook, Miss	5	0	0
Boxes at All Saints Church, Babbacombe	3	11	8
British Workman (No. 2)	2	6	
Collected at Custom House	17	3	
Heath, Miss Mary (of Bath)	1	5	0
Imperial Hotel	1	6	0
Jackson, J.	5	0	0
Life-Boat House	6	3	
Matheson, J.	5	0	0
Nelson, G. H.	5	0	0
Parkinson, Mrs.	5	0	0
Pillar Box	1	1	0
Ray, Biscoe	5	0	0
R. C. S.	10	0	0
W. D. B.	5	0	0
Small Sums	1	8	0
Total Dons	12	2	8
Total Subs.	127	19	6
Total	£140	2	2

### WESTERN COUNTIES CENTRAL BRANCH.

President— The Right Hon. the EARL OF DEVON.			
Honorary Treasurer— THOMAS B. GIBBS, Esq.			
Annual Subscriptions.			
Barnard, Admiral	1	1	0
Bere, Mrs. Sen.	10	6	
Knight, Rev.	1	1	0
Lowe, Miss	5	0	
Neumann, G. Esq.	1	0	0
Simcoe, Capt., R.N.	2	2	0
Total	5	19	6

Donations.			
Burch - Reynardson, A. Esq.	1	0	0
Lowe, Rev.	10	0	0
Mellor, A. Esq.	1	0	0
Passmore, Mrs.	10	0	0
Sharpe, J. Esq.	10	0	0
Contribution boxes on G. W. R.	4	1	0
Ditto on L. & S. W. Railway	8	12	0
Ditto on Somerset & Dorset Railway	9	2	
Ditto on South Devon Railway	6	9	3
Ditto on Great Eastern Railway	3	0	5
Ditto Bodega, London, per Messrs. Lavery, & Co.	12	9	
Ditto, per Mr. Davis, 'London Tavern,' Mark Lane	3	10	10
Pillar boxes	10	14	4
Total Dons	40	19	9
Total Subs.	5	19	6
Total	£46	19	3

Contributions in aid of Walton-on-Naze Life-boat Fund.			
Benton & Woodiwiss, Messrs.	1	0	0
Gibbs, Thos. B. Esq.	1	1	0
Kay, General & Mrs.	2	0	0
Loyd, Col. & Family	6	0	6
Woolranch, W. Esq.	1	1	0
Pillar Contribution box	5	16	0
Contribution boxes at Albion, Brooks', and Post Office	7	8	
Ditto Marine Hotel	17	9	
Ditto Portobello do.	10	0	
Ditto Queen's Head Hotel	7	6	
Total	£19	1	5

### YEALM RIVER BRANCH.

Hon. Secretary— RALPH DAWSON, Esq.			
Annual Subscriptions.			
Baring, Edward C.	1	1	0
Bastard, Baldwin J. P.	1	1	0
Collinsplatt, Hawtrey	1	0	0
Collinsplatt, Henry	1	1	0
Cory, Richard	1	1	0
Dawson, Ralph	1	1	0
Dawson, Mrs.	1	1	0
Hicks, Col., C. B.	1	0	0
Hicks, Miss	1	1	0
Holberton, T. & V.	1	1	0
Lane, Rev. Richard	1	1	0
Roe, Rev. Henry F.	1	1	0
Williams, Michael	1	1	0
Yonge, Rev. Duke	1	1	0
Total	£14	12	0

### Dorsetshire.

#### BRIDPORT DISTRICT BRANCH.

President—  
THOMAS COLFOX, Esq.  
Secretary and Collector—  
Mr. H. Good.

#### Annual Subscriptions.

	£.	s.	d.
Beach, Thomas	10	0	0
Chick, W. H.	5	0	0
Colfox, T.	1	0	0
Colfox, W.	1	0	0
Cox, E.	10	0	0
Crocker & Son, W.	5	0	0
Edmunds, C.	5	0	0
Edmunds, T. H.	5	0	0
Good, F.	5	0	0
Gundry, F. W.	5	0	0
Gundry, J. P. F.	1	0	0
Hounsell, H. E. (Lim.)	5	0	0
Hounsell, J.	5	0	0
Hounsell, R.	5	0	0
Hounsell, T.	10	0	0
Hounsell, W.	10	0	0
Howell, H.	5	0	0
Knight, W.	5	0	0
Legg, Job	10	0	0
Manley, W. H.	5	0	0
Suttil, J. P.	5	0	0
Tucker, C.	5	0	0
Tucker, Frank	5	0	0
Tucker, Harry	5	0	0
Waldron, Capt.	5	0	0
Waney, Miss	5	0	0
Collecting Box	3	0	0
Sums under 5s.	2	6	
Total	£10	5	6

#### ISLE OF PURBECK BRANCH.

President—  
THE EARL OF ELDON.  
Vice-President—  
LIEUT.-COL. MANSSEL.

Honorary Secretary—  
GEORGE H. BOND, Esq.

#### Annual Subscriptions.

Earl of Eldon	15	0	0
Banckes, Albert, Esq.	1	0	0
Banckes, Rev. Canon	1	0	0
Bennett, S. Esq.	10	0	0
Best, Mr.	5	0	0
Bond, George, Esq.	1	0	0
Bond, Nath. Esq.	1	10	0
Bond, Rev. Canon	1	0	0
Bond, Thos. Esq.	10	0	0
Cann, Mr. R.	5	0	0
Colson, Miss	5	0	0
Cust, Mr.	5	0	0
Digby, G. Wingfield, Esq.	2	2	0
Drew, Mr.	5	0	0
Farrer, Mrs.	1	0	0
Filliter, F. Esq.	1	1	0
Fyler, J. Esq.	1	0	0
Hoare, Mrs. C. R.	1	0	0
Hooper, Mr.	10	0	0
Hunt, Miss	7	0	0
Jackson, Miss	1	0	0
Kent, Mr. J.	5	0	0
Lance and Co.	10	0	0
Lester, Rev. Lester	1	0	0
Mansel, Lieut.-Col.	1	0	0
Mansel, Rev. O. L.	1	0	0
Marshallsay, Mr. J.	10	0	0
Marshallsay, Mr. F.	10	0	0
Oakley, Mr.	5	0	0
Panton, J. Esq.	10	6	
Pearce, Rev. T.	2	2	0
Pike, W. J. Esq.	1	0	0
Pryce, Mrs.	5	0	0

BRANCHES—LIST OF ANNUAL SUBSCRIPTIONS AND DONATIONS. 335

	£.	s.	d.
Randall, Mr. T. ....	5	0	0
Rodgett, Mrs. ....	2	0	0
Rowe, Mrs. G. ....	10	6	
Selby, Mr. ....	10	0	
Trenchard and Smith ..	7	6	
Willshire, Mr. ....	5	0	
Total.....	43	10	6

**Donations.**

Collected by Eustace Mansel, Esq., 52nd Regt. ....	1	2	0
Collected in Mrs. Serrell's Sunday Class.....	4	0	0
Collected by Miss Yearsley.....	9	0	0
Proceeds of Lecture by Rev. O. L. Mansel .....	6	8	6
Small Sums.....	1	11	0
Total Dons.....	13	10	6
Total Subs.....	43	10	6
	£57	1	0

**LYME REGIS BRANCH.**

**Chairman—**  
WILLIAM HINGESTON, Esq.

**Honorary Secretary—**  
Mr. WILLIAM BENNETT.

**Annual Subscriptions.**

Ames, E. L. Esq. ....	1	0	0
Brandram, Lt.-Col. ...	1	0	0
Bullen, Capt. R.N. ...	1	0	0
Chalmers, A. J. Esq. ...	5	0	0
Edwards, Z. Esq. ....	10	0	0
Hayward, Miss.....	10	0	0
Henley, Miss.....	10	0	0
Henning, Miss.....	5	0	0
Hingeston, Wm. Esq. ...	1	0	0
Ingram, H. F. Esq. ....	1	0	0
Landon, Mrs. ....	5	0	0
Lean, Mrs. ....	10	0	0
Luttrell, Mrs. ....	10	0	0
Marsh, Isaac, Esq. ....	5	0	0
Peck, Rev. Edward.....	1	0	0
Peel, Edmund, Esq. ....	5	0	0
Preston, I. W. Esq. ....	10	0	0
Radford and Radford ..	5	0	0
Symons, Mrs. ....	10	0	0
Tucker, Henry, Esq. ....	10	0	0
Vizard, Mrs. H. B. ....	1	0	0
Warting, Mrs. ....	5	0	0
Williams, R. & R. and Co. ....	1	1	0
Wrey, Mrs. ....	10	0	0
Total .....	19	2	0

**Donations.**

Hodges, late Dr. ....	10	0	
Homan, E. Esq. ....	10	0	
Hussey, Mrs. ....	5	0	
Leathes, the Misses Stanger.....	7	6	
Lister, Professor.....	10	0	
Marder, Miss.....	5	0	
Matthey, Chas. Esq. ....	5	0	
Munro, Capt.....	10	0	
Patton, Capt. R.N.....	10	0	
Palgrave, F. T. Esq. ....	5	0	
Shore, Mrs. ....	5	0	
Skinner, Dr.....	5	0	
Salmon, Rev. F.....	5	0	
Stewart, Rev. I. T.....	5	0	
Wallis, Mrs. W. B.....	5	0	
Sums under 5s.....	2	4	6
Pillar and other collecting boxes ..	3	13	11
Total Dons.....	11	0	11
Total Subs.....	19	2	0
	£30	2	11

**POOLE AND BOURNEMOUTH BRANCH.**

**President—**  
LORD SIDNEY GODOLPHIN OSBORNE.

**Chairman—**  
Rev. J. A. LAWSON.

**Honorary Secretary and Treasurer—**  
Mr. RICHARD PENNEY.

**Annual Subscriptions.**

Aldridge, G. B. Esq. ...	5	0	
Alington, Lord.....	2	2	0
Belben, G. Esq. ....	10	6	
Belben, T. Esq. ....	10	6	
Blisset, Rev. G.....	10	0	
Budge, P. S. L. Esq. ...	5	0	
Colquhoun, Sir Jas., Bart.....	2	2	0
Cox, W. Esq. ....	10	0	
Damer, Rev. L. Dawson .....	1	0	0
Digby, G. D. W. Esq. ...	2	10	0
Glyn, Sir R. G. Bart. ...	2	0	0
Glyn, Rev. C. J.....	10	0	
Grey, Admiral.....	10	0	
Kemp, Rev. A.....	1	0	0
Kemp, Miss.....	1	0	0
Kettle, Miss.....	10	0	
Lang, Major.....	10	0	
Lawson, Rev. J. A.....	5	0	
Meredith, H. Esq. ....	5	0	
Norton, J. J. Esq. ....	10	6	
Ouslow, Rev. C.....	10	6	
Thelps, Miss.....	10	0	
Pocock, Rev. F.....	5	0	
Portman, Hon. W. H. B.....	1	0	0
Schreiber, C. Esq., M.P.....	2	2	0
Sladen, Rev. E. H. M. ...	10	6	
Sullivan, Admiral Sir B. J., K.C.B.....	1	0	0
Waterman, W. Esq. ....	5	0	
Welch, M. Kemp- Esq.....	10	6	
West, Miss.....	10	0	
Wimborne, Lord.....	2	2	0
Wood, M., Esq. ....	5	0	
Total.....	26	16	0

**Donations.**

Harrison, G. Esq. ....	5	0	
Peter, G. W. Esq. ....	10	0	
Westminster, Duke of.....	5	0	0
Sums under 5s.....	3	6	
Box at Boat-house ..	6	2	
Pillar Box, Bournemouth Pier .....	2	12	2
Do. Arcade.....	10	14	8
	£46	7	6

**SWANAGE BRANCH.**

**President—**  
G. BURT, Esq.

**Treasurer—**  
G. C. DE LA MOTTE, Esq.

**Honorary Secretary—**  
Mr. H. J. HIXSON.

**Annual Subscriptions.**

Bloxsome, J. B. Esq. ...	10	0	
Burt, G. Esq., Sheriff ..	2	0	
Colson, Miss.....	5	0	
Crawford, Dr.....	1	0	0
Disby, Capt. M.P.....	1	0	0
Docura, Thos. Esq. ....	10	0	
Filfiter, Freeland, Esq. ...	10	0	
Marsh, Mr. S.....	5	0	

Randall, Mrs. ....	10	0	
Robinson, J. C. Esq. ...	2	2	0
Seavill, Rev.....	5	0	
Serrell, Mrs., and her Sunday School Scholars .....	4	0	0
Slater, R. Esq. ....	1	0	0
Travers, Rev. K. D.....	10	0	
Wilde, S. Esq. ....	3	0	0
Wilde, Miss.....	2	0	0
Total.....	19	10	0

**Donations.**

A Friend.....	10	0	
Eloran, E. Esq.....	5	0	
Pearce, Dr.....	1	10	0
Seymer Place.....	5	0	
Shakspeare, Miss.....	5	0	
Winwood, Esq.....	5	0	
Wood, G. Esq.....	5	0	
Other Sums.....	2	4	6
Pillar Box & Collected at Royal Victoria Hotel ..	1	18	6
Proceeds of Concert ..	11	9	0
Total Dons.....	18	17	0
Total Subs.....	19	10	0
	£38	7	0

**WEYMOUTH BRANCH.**

**Patron—**  
The Right Hon. the EARL OF STRAFFORD.

**President—**  
The Right Hon. LORD ASHLEY.

**Honorary Secretary—**  
G. H. PRICE, Esq.

**Annual Subscriptions.**

Bannton and Sons, Messrs.....	5	0	
Bayley, E. Esq. J.P. ...	1	0	0
Church, Mrs. J.....	5	0	
Devenish and Co. Messrs. J. A. ....	10	6	
Elliot & Co. Messrs. ...	1	0	0
Elliot, George, Esq. ....	10	6	
Erskine, Miss.....	5	0	
Goodden, H. C. Esq., J.P.....	10	0	
Greaves, Rev. T.....	5	0	
Groves, Mr. T. B.....	5	0	
Groves, Mr. J.....	5	0	
Hame, T. A.....	5	0	
Hodges, J. F. Esq. ....	10	6	
Hoopfer, Pelly.....	5	0	
Hopkins, Mr. B.....	10	6	
Howard, R. N. Esq. ....	5	0	
Lynes, Rev. J.....	5	0	
May, Captain R.N., Inspecting Commander.....	10	6	
Moorhead, Dr.....	10	0	
Penny, Colonel.....	5	0	
Phelps, Capt.....	1	0	0
Pidgeon and Sons, Messrs.....	5	0	
Pigou, Rev. H. C.....	10	0	
Pretor, Capt.....	5	0	
Roberts, W. and Co. ...	7	6	
Simpson, R. P. Esq. ....	5	0	
Smith, Dr. M.D.....	10	0	
Speake, Hugh.....	5	0	
Thompson, S. Esq.....	10	0	
Tizard, Dr.....	5	0	
Welsford, G. B. Esq. ...	5	0	
Williams, Messrs. R. and H. and Co. ....	1	1	0
Total.....	13	18	0

**Donations.**

Erskine, Miss.....	5	0	
Aquila s.s., Capt. Flisher.....	1	19	0
Brighton s.s., Capt. Falle.....	10	5	7
Cosens & Co.'s steamboats.....	1	4	8
Great Western s.s., Capt. E. S. Blam-pied.....	4	15	6
South of Ireland s.s., Capt. Pearn.....	1	12	6
Total Dons.....	20	2	3
Total Subs.....	13	18	0
	£34	0	3

**Durham.**

**HARTLEPOOL BRANCH.**

**Honorary Secretary—**  
S. HERBERT BELK, Esq.

**Annual Subscriptions.**

Belk, Thos. Esq.....	1	0	0
Barton, Rev. J.....	3	0	0
Ditto 1879.....	3	0	0
Coverdale, J. Esq. ....	1	1	0
Hartlepool Port Harbour Commissioners	5	5	0
Ditto 1879.....	5	5	0
Huntley, B. R. Esq. ...	1	1	0
Marshall, Mr. John ..	10	6	
Richardson, T. Esq., M.P.....	3	3	0
Ropner, R. Esq.....	1	1	0
Withy, E. Esq.....	1	1	0
Total.....	25	8	6

**Donations.**

Ropner, R. Esq.....	1	1	0
The Mayor.....	1	1	0
Watts, Mr. R.....	5	0	0
Voluntary contributions from shipping .....	47	2	1
	£74	17	7

**SEAHAM BRANCH.**

**President—**  
The MARQUESS OF LONDONDERRY.

**Chairman—**  
Rev. A. BETHUNE.

**Honorary Secretary—**  
WILLIAM WARHAM.

**Annual Subscriptions.**

Londonderry, The Marquess of.....	3	3	0
Bethune, Rev. A.....	10	6	
Brough, Mrs. T.....	10	0	
Brown, J. B. Esq. ....	10	0	
Brydon, R. Esq.....	5	0	
Candlish, R. Esq.....	10	0	
Chilton, Thos. Esq. ...	5	0	
Clazey, J. O. Esq.....	5	0	
Colling, Rev. J.....	5	0	
Corbett, V. J. Esq.....	5	0	
Ditchfield, S. J. Esq. ...	5	0	
Elliot, Thos. Esq.....	5	0	
Emington, J. B. Esq. ...	10	6	
Lough, W. Esq.....	5	0	

	£.	s.	d.
Mann, Major.....	10	6	
North Hetton Coal Company.....	2	2	0
Pallister, W. Esq... ..	10	6	
Scott, Rev. W. A. ....	5	0	
Sheridan, W. Esq... ..	10	0	
Smith, T. & W. Messrs.	1	1	0
The South Hetton Coal Company... ..	2	2	0
Thorman, Robt. Esq... ..	10	6	
Turnbull, T. S. & Co... ..	5	0	
Warham, William... ..	5	0	
Watson, Kipling & Co. Messrs... ..	2	2	0
Woods & Co. Messrs.	1	1	0
Wright, H. B. Esq... ..	10	0	
Young, Ehlers, & Co. Messrs... ..	2	2	0
Collecting Box.....	5	4	
Collected from ships.	8	1	8
Total.....	£29	17	6

**SEATON CAREW  
BRANCH.**

**Chairman—  
M. PEARSK, Esq.**  
**Treasurer—  
JOHN BAKEWELL, Esq.**  
**Honorary Secretary—  
Rev. JOHN LAWSON, M.A.**

**Annual Subscriptions.**

Eldon, The Earl of.	5	0	0
Appleby, Thos. Esq.	1	1	0
Backhouse, A. Esq.	1	0	0
Backhouse, E. Esq. (the late).....	1	0	0
Backhouse, Edmund, Esq.....	2	2	0
Bakewell, John, Esq.	1	1	0
Barclay, Mrs.....	1	1	0
Boyne, Viscount.....	3	3	0
Clarke, George, Esq.	1	0	0
Dale, David, Esq... ..	1	1	0
Dalton, Rev. C. W... ..	1	1	0
Dalton, Miss.....	2	2	0
Fawcus, Henry, Esq.	2	2	0
Fawcus, R. S. Esq... ..	1	1	0
Garbutt, E. W. Esq. .	1	1	0
Herskind, F. Esq... ..	1	1	0
Hodgkins, J. B. Esq. .	1	1	0
Hudson, T. S. Esq... ..	1	1	0
Inglby, Lady Am- cotts.....	1	1	0
Kell, John, Esq... ..	1	1	0
Lawson, Professor... ..	1	1	0
Lawson, Rev. John... ..	2	2	0
Longbotham, J. Esq. .	1	1	0
Lucas, Albert, Esq... ..	1	1	0
McIntire, Rev. T... ..	1	0	0
Mitchell, John J. Esq. .	1	1	0
Mounsey, E. B. Esq. .	1	1	0
Pearse, M. Esq.....	1	1	0
Reay, Thomas M. Esq.....	1	1	0
Rogers, Mrs. (late)... ..	1	1	0
Surtees, W. E. Esq... ..	2	2	0
Swanson, W. Esq... ..	1	1	0
Tilly, Harry T. Esq. .	1	1	0
Tone, Miss.....	1	1	0
Vivian, Mrs.....	1	1	0
Total.....	£47	17	0

**Donation.**

Barometer Pillar.....	5	0	
Life-boat House Box	14	7	
Total.....	£43	16	7

**SUNDERLAND AND  
WHITBURN  
BRANCH.**

**Chairman—  
ALDERMAN REED.**  
**Treasurer—  
J. C. FORRETT, Esq.**  
**Honorary Secretary—  
WILLIAM MILBURN, Esq.**

**Annual Subscriptions.**

	£.	s.	d.
Alderson, C. Esq... ..	10	0	0
Allison, J. J. and W. H. Messrs.....	1	0	0
Anderson, T. Esq... ..	1	0	0
Armstrong, Addison & Co. Messrs. ....	1	0	0
Austin, S. P. & Son, Messrs.....	1	1	0
Backhouse and Co., Messrs.....	1	1	0
Barnes, T. Esq... ..	3	0	0
Barwick, I. S. Esq. .	10	0	0
Blain, Thomas Esq... ..	10	6	
Blumer & Co. Messrs...	5	0	0
Booth, George R. Esq... ..	10	0	0
Bramwell and Co., Messrs.....	1	1	0
Briggs, Wm. & Sons, Messrs.....	10	0	0
Christal, J. and Sons, Messrs.....	10	0	0
Clarke, George Esq. .	1	1	0
Cockin, Rev Canon... ..	10	0	0
Craven and Speeding, Messrs.....	1	0	0
Cross, John, Esq. per N. P. Bank, Sun- derland Branch... ..	1	1	0
Davison, R. G. Esq... ..	5	0	0
Dickenson, J. Esq... ..	10	0	0
Durham, Right Hon. Earl of.....	2	2	0
Elliot, Thomas, and Sons, Messrs.....	10	0	0
Fairley, T. W. and C. Messrs.....	7	6	
Fairman, J. C. Esq... ..	5	0	0
Featherstonhaugh, A. W. and E., Messrs.....	10	0	0
Forster, John, Esq... ..	5	0	0
Friend, A.....	5	0	0
Gayner, R. H. Esq... ..	1	1	0
Gowland, G. H. Esq... ..	10	6	
Graham, John, Esq... ..	10	0	0
Graham, Henry, Esq... ..	5	0	0
Greaves, J. W. E.-q... ..	5	0	0
Grimshaw and Sons, Messrs.....	10	0	0
Harrison Brothers... ..	5	0	0
Harrison, T. E. Esq. .	1	10	0
Harrison, W. B. Esq... ..	10	0	0
Hartley, James, Esq. .	1	1	0
Hill, J. G. Esq... ..	10	0	0
Hills, James, Esq... ..	5	0	0
Hills, John, Esq... ..	5	0	0
Hills, W. H. Esq... ..	5	0	0
Hitchcock, Rev. Canon W. M.....	2	2	0
Hodgson, Mrs... ..	10	0	0
Horan, James, Esq... ..	10	0	0
Hudson, R. & Sons, Messrs.....	10	0	0
Kayil, J. J. Esq... ..	10	6	
Laing, James, Esq... ..	1	1	0
Lambton and Co., Messrs.....	1	1	0
Lilburn, Chas. Esq... ..	10	6	
Lumsdon, Byers, and Co. Messrs.....	1	1	0
Meier, C. W. and Co. Messrs.....	5	0	0
Modlin, T. Esq... ..	5	0	0
Morton, H. T. Esq... ..	10	6	
Newbiggin, E. J. Esq... ..	5	0	0
Oliver, R. Esq... ..	10	0	0
Peckett, G. C. Esq... ..	5	0	0

	£.	s.	d.
Pemberton, R. L. Esq... .	1	0	0
Porrett, R. B. Esq... .	1	1	0
Potts, J. Jun. Esq... .	1	1	0
Potts, R. H. & Bros. Messrs.....	1	0	0
Reay, T. J. Esq... ..	5	0	0
Reed, Alderman... ..	1	1	0
Richardson, S. Esq... ..	10	0	0
Ritson, Henry, Esq... ..	5	0	0
Ritson, John & Sons, Messrs.....	10	0	0
Robson, E. C. & Son, Messrs.....	10	0	0
Robson, W. W. and Sons, Messrs.....	5	0	0
Rutter, R. P. W. Esq... ..	5	0	0
Service and Phillips, Messrs.....	5	0	0
Sheraton, Richd. Esq... ..	5	0	0
Smith, Alexander, Esq... ..	10	0	0
St. John, Wm. Esq... ..	10	6	
Steel, Thomas, Esq... ..	5	0	0
Stobart, William, Esq... ..	10	0	0
Thompson, Alder- man William... ..	10	0	0
Thompson, J. and H. H. & Co. Messrs...	10	0	0
Thompson, John, Esq... ..	5	0	0
Tone, William, Esq... ..	10	0	0
Tyzack & Branfoot... ..	1	0	0
Vaux, Cuthbert, Esq... ..	5	0	0
Watson, George, Esq... ..	10	0	0
Wayman, J. W. Esq... ..	10	6	
Wiener, Martin, Esq. .	1	1	0
Williamson, Sir H., Bart.....	4	0	0
Wilson, C. Stanley, Esq.....	10	6	
Wilson, C. Esq... ..	10	6	
Woods & Co. Messrs.	1	1	0
Woodcock, Mrs., in- terest on the legacy of the late.....	2	18	8
Total.....	£62	9	8

**Sundry Donations,  
per H. M. Customs 94** 12 2

**Collecting Boxes... ..** 14 0 0

**£157** 15 10

**WEST HARTLEPOOL  
BRANCH.**

**Chairman—  
W. UPWARD, Esq., H.M.C.**

**Honorary Secretary—  
C. A. BAKER, Esq.**

**Annual Subscriptions.**

Subscriptions collected by  
Mr. Garthwaite during  
1880, viz. :—

Appleby, T. & Co... ..	1	1	0
Cory, Lohden & Co... ..	2	2	0
East Coast Insurance Co.....	2	2	0
Farmer, H. T... ..	10	0	0
Fryer, E.....	5	0	0
Gray, W. & Co.....	2	2	0
Groves, Maclean & Co.....	1	1	0
Herskind, F... ..	10	6	
Irvine, R. & Co... ..	2	2	0
Lane, C... ..	10	6	
Lauder, R. & Co... ..	10	6	
May & Hassell... ..	10	6	
Middleton & Co... ..	1	1	0
Pease, J. W. & Part- ners.....	1	1	0
Pyman, George.....	2	2	0
Robinson, T... ..	10	6	
Steam Navigation Co... ..	2	2	0
Turnbull, E. ....	1	0	0
Withy, E. ....	10	6	
Total.....	£21	14	0

**Donations.**

J. M. C. ....	5	0	
Sundry donations per H.M. Customs....	8	10	0
Voluntary Tolls col- lected at the Dock Office.....	50	18	6
	£81	7	6

**ESSEX.**

**ESSEX AND COL-  
CHESTER BRANCH.**

**President—  
G. H. ERRINGTON, Esq.,  
High Steward of Colchester.**  
**Chairman—  
Mr. Alderman J. BAWTREE  
HARVEY.**  
**Vice-President—  
Major BISHOP.**  
**Treasurer—  
JOHN BAWTREE, Esq.**  
**Hon. Secretary—  
Lieut. C. HARVEY HERRING,  
R.N.**

**Annual Subscriptions.**

	£.	s.	d.
Balderston, Miss... ..	1	1	0
Bannatyne, Rev. C... ..	1	0	0
Bawtree, John, Esq. .	1	1	0
Bishop, Major... ..	1	1	0
Carlingford, Rt. Hon. Lord.....	2	0	0
Causton, R. K. Esq., M.P.....	1	1	0
Errington, G. H. Esq. .	1	1	0
"Essex Standard"... ..	10	6	
"Essex Telegraph"... ..	10	6	
Freeland, Mrs.....	1	1	0
Harvey, J. Bawtree, Esq.....	1	1	0
Hanson, Mrs. G... ..	1	1	0
Luard, Admiral, C.B. .	1	1	0
Round, Mrs. Chas. G. .	1	1	0
Round, Mrs. Geo... ..	1	1	0
Willis, W. Esq., Q.C., M.P.....	1	1	0
Total.....	16	12	0

**Donations.**

Bannatyne, Rev. C... ..	2	0	0
Bawtree, John, Esq... ..	2	2	0
Bawtree, Mrs.....	1	1	0
Errington, G. H. Esq. .	5	5	0
Luard, Admiral, C.B. .	2	2	0
Morrell, Mrs.....	1	0	0
Wright, Miss Sturley... ..	10	6	
Total Dons.....	14	0	6
Total Subs.....	16	12	0
	£30	12	6

**Donations.**

Bannatyne, Rev. C... ..	2	0	0
Bawtree, John, Esq... ..	2	2	0
Bawtree, Mrs.....	1	1	0
Errington, G. H. Esq. .	5	5	0
Luard, Admiral, C.B. .	2	2	0
Morrell, Mrs.....	1	0	0
Wright, Miss Sturley... ..	10	6	
Total Dons.....	14	0	6
Total Subs.....	16	12	0
	£30	12	6

**Donations.**

Bannatyne, Rev. C... ..	2	0	0
Bawtree, John, Esq... ..	2	2	0
Bawtree, Mrs.....	1	1	0
Errington, G. H. Esq. .	5	5	0
Luard, Admiral, C.B. .	2	2	0
Morrell, Mrs.....	1	0	0
Wright, Miss Sturley... ..	10	6	
Total Dons.....	14	0	6
Total Subs.....	16	12	0
	£30	12	6

**CLACTON-ON-SEA  
BRANCH.**

**President—  
Rev. Henry LAW.**

**Chairman—  
JAMES HARMAN, Esq.**

**Honorary Secretary—  
Mr. FRED. MANN.**

**Annual Subscriptions.**

Agate, W... ..	10	6	
Ager, George.....	10	6	
Allen, —.....	1	1	0

BRANCHES—LIST OF ANNUAL SUBSCRIPTIONS AND DONATIONS. 337

£	s.	d.	£	s.	d.
Aitwood, —	1	0	Grice, Mr. J.	10	0
Baker, W. S.	5	0	Hammond, Misses	10	0
Bawtree, Octavius, Esq.	1	0	Jackson, G. L.	2	6
Bland, W.	1	0	Marsden, Canon	1	0
Boys, J. Esq.	2	0	Murray, Mr. W.	10	0
Chambers, George	10	6	Nichols, F. M. Esq.	2	0
Chapman, James	10	6	Nalborough, W. J.	10	0
Cortauld, Samuel, Esq.	1	0	Pattrick and Son, Messrs.	1	0
Cox, J.	10	6	Tomline, Colonel	5	0
Ellis, J.	10	6	Tyler, Sir Henry	1	0
Fowler, J. T.	10	6	Vaux, J. H. Esq.	10	0
Garnham, —	1	0	Watts, John, Esq.	10	0
Green, R.	5	0	Whitmore, Mr. J.	10	0
Harman, Jame	1	0	Worts, Mr. A.	10	0
Harman & Matthews	10	6			
Hayes, T. D.	10	6			
Hudson, Matthews, Lopez, and Co.	3	0			
Jackson, W. P.	10	6			
Law, Rev. Henry	2	0			
Law, Mrs.	1	0			
Macbride Crofts, Rev. J. D.	1	0			
Main, W.	10	6			
Mann, Fred	10	6			
Mitchell, James	10	6			
Newman, Rev. T. Harding, D.D.	1	0			
Nichols, F. M. Esq. J. P.	1	0			
Nunn, F. J.	5	0			
Osborne, A. T.	10	6			
Page, Henry James	1	0			
Penfold, A.	10	6			
Phillips, J.	2	6			
Poston, —	1	0			
Reynolds, Burford, and Co.	10	6			
Round, James, Esq. M. P.	1	0			
Rutherford, W.	5	0			
Salmon, R. Esq.	10	0			
Sizer, J. H.	12	0			
Smith, I.	10	0			
Smith, J.	10	6			
Tabrum and Jones	10	6			
Topp, J.	10	6			
Vincent, W. T.	5	0			
Walton and Attwood	1	0			
<b>Total</b> .....	<b>36</b>	<b>1</b>	<b>0</b>		

**Donations.**

Contribution Box at boathouse	9	0	11
Do. on board G. E. R. steamers, per Capt. Howard	1	6	9
Proceeds of Concert, per Rev. R. E. Gaye	6	6	0
<b>Total Dons.</b> .....	<b>16</b>	<b>13</b>	<b>8</b>
<b>Total Subs.</b> .....	<b>33</b>	<b>4</b>	<b>6</b>

£19 18 2

**SOUTHDEN  
BRANCH.**

Chairman—  
Rev. F. THACKERAY.  
Honorary Secretary—  
THOMAS SMITH, Esq.

**Annual Subscriptions.**

Beard, Mr.	10	0	
Bell, Miss L.	10	6	
Brightwell, Mr. I. R.	1	0	
Browne, Rev. R. C.	5	0	
Davies, Miss	5	0	
Deeping, Mr. G. D.	10	6	
Dettmar, Mr.	10	0	
Dettmar, Miss	5	0	
Dettmar, Miss May	5	0	
Dowsett, Mr.	10	0	
Dyer, Mrs.	1	0	
Gregson, Mr. W.	10	6	
Lancaster, Mr. J. L.	1	0	
Merritt, Mr. W. D.	10	6	
Merritt, Mrs. W. D.	10	6	
Richmond, Mr.	10	0	
Smith, Mr. T.	10	6	
Swaine, Mrs. G.	10	0	
Thackeray, Rev. F.	1	0	
Verrall, Mr.	10	0	
Withers, Mr.	1	0	
Wood, Mr. F.	1	0	
Woodsman, Mr.	10	6	
<b>Total</b> .....	<b>13</b>	<b>19</b>	<b>6</b>

**Donations.**

Brett Mr. Edwin, per Rev. F. Thackeray	5	0	0
<b>Total</b> .....	<b>£18</b>	<b>19</b>	<b>6</b>

**HARWICH BRANCH.**

President—  
EDGAR WALTER GARLAND,  
Esq., High Steward of the  
Borough of Harwich.

Chairman—  
J. R. FRANKS, Esq.  
Honorary Secretary—  
Mr. A. P. BRAY.

**Annual Subscriptions.**

Barnes, R. S. Esq.	10	0
Bevan, Mr. C. F.	10	0
Brady, H.	1	0
Barnster, Rev. G. and Family	1	0
Carlingford, Lord	2	0
Cottingham, F.	10	0
Eley, Chas. Esq.	1	0
Evans, Mrs.	10	0
Evans, S. Esq.	10	0
Franks, J. R.	10	0
Garland, E. W. Esq.	10	0
Ground, W. Esq.	10	0

**Flintshire.**  
**RHYL BRANCH.**

President—  
R. BAMFORD HESKETH, Esq.  
Chairman—  
T. GRIFFIES DIXON, Esq.  
Treasurers—  
NORTH AND SOUTH WALES  
BANK.  
Honorary Secretary—  
Mr. ROBERT HUGHES.  
*Annual Subscriptions.*

£	s.	d.	
Buddicom, W. B. Esq.	2	0	
Butterton, Rev. G. A., D.D.	10	0	
Churton, John, Esq.	10	0	
Conwy, Major Conwy Rowley	5	0	
De Broke, Lady Wil- loughby (the late)	2	0	
Dixon, T. Griffies, Esq.	2	2	
Fuller, Mrs.	1	0	
Gladstone, Rev. S. E.	1	0	
Hesketh, R. Bamford, Esq.	5	0	
Hughes, H. R. Esq. Kimmel	5	0	
Johnson, G. Esq.	5	0	
Jones, Mrs. E. Olinda	2	2	
Jones, W. Price, Esq.	10	6	
Jones, Mrs. Price	10	6	
Mainwaring, T. Esq.	5	0	
Mountfield, W. B. Esq.	10	6	
Penn, Major	10	6	
Pennant, P. P. Esq.	1	0	
Richardson, Rev. T. M.A.	10	0	
Roberts, J. Esq. M. P.	1	0	
Roberts, R. Price, Esq.	1	0	
Sisson, R. J. Esq.	1	0	
Sneyd, Miss.	1	0	
St. Asaph, Dean of	1	0	
Wilkin, W. Esq.	1	0	
Winstan, Thos. Esq.	1	0	
Wynn, Mrs. Wms.	1	0	
<b>Total</b> .....	<b>43</b>	<b>7</b>	<b>0</b>

**Donations.**

Bell, G. A. Esq.	5	0	
C. R.	10	6	
Editor, Rhyl "Record"	10	6	
Editor, Rhyl "Journal"	17	0	
Editors, Rhyl "Ad- vertiser"	10	6	
Lloyd, Dr. F. Ll.	10	0	
Belvoir Hotel	1	3	3
Children's Meeting, per Capt. Phipps	8	5	
Cliff, Mr., Market Hall	11	8	
Dudley Arms Hotel	12	4	
Parade Pillar Box	3	11	8
Pier Refreshment Rooms	15	4	
Queen's Hotel	15	2	
Railway Refreshment Rooms, Rugby	12	11	
Royal Hotel	5	3	
Steamer <i>Gipsy King</i>	8	9	
Sun Inn	10	2	
Sums under 5s.	15	8	
<b>Total Dons.</b> .....	<b>14</b>	<b>4</b>	<b>1</b>
<b>Total Subs.</b> .....	<b>43</b>	<b>7</b>	<b>0</b>

£57 11 1

**Glamorganshire.**  
**PENARTH BRANCH.**

Patron—  
C. R. M. TALBOT, Esq. M. P.  
Chairman—  
Colonel E. S. HILL.  
Treasurer—  
JAS. EDWARDS, Esq.  
Penarth.  
Honorary Secretary—  
Commander W. M. PEN-  
GELLEY, H.M.'s late Indian  
Navy.

**Subscriptions for 1880.**

£	s.	d.
Aberdare Coal Co.	10	6
Adams, Mr. G. F.	10	6
Adams, Wilson, and Co.	5	0
Alexanders & Co.	1	0
Andrews, Mr. S.	10	6
Barnes, Gutbrie & Co.	10	6
Bewick, Mr. Geo.	10	6
Bland & Co., Messrs. J.	1	0
Bovey, John and Co. Messrs.	10	6
Brown, Mr. Forster	5	0
Burness, Jas. & Sons	1	0
Bute, Marquis of	10	0
Eyers, Dr.	5	0
Capper, Mr. E. H.	10	6
Clive, Lady Mary Windsor	1	0
Coedcae Coal Co.	10	6
Cloake, Capt. H.	5	0
Coffin and Co.	1	0
Collins, Capt. J. R.	5	0
Cornwell, Mr. D.	10	6
Cory Bros. and Co.	1	0
Cory, J. and Sons	10	0
Davies, David, & Co.	1	0
Davis, David, & Sons	1	0
Duncan, Mr. R.	5	0
Edwards, Mr. W. Y.	10	0
Elliott, J. and Son, Messrs.	10	0
Fothergill, Mr. H.	5	0
Frazer and Co.	10	0
Fry, Mr. John	10	0
Gaskell, Mr. J.	10	6
Gaskell, Mr. W. G.	10	6
Gibbs, Mr. Peter	10	6
Glamorgan Coal Co.	1	0
Haquoil Bros.	10	6
Harrison Bros. and Moore, Messrs.	10	6
Hill, C. and Son, Messrs.	1	0
Hodge & Hill, Messrs.	5	0
Hollier, Mr. H.	10	6
Hollyer & Co. Messrs.	5	0
Insole, J. and Sons, Messrs.	1	0
Jackson, Miss E.	10	6
Jacobs, Mr. C. M.	10	6
Jessen, Mrs. G. N.	5	0
Johnson, Mr. S. N.	5	0
Jones, Mr. Edward O.	5	0
Jones, Heard, and Ingram, Messrs.	10	6
Jones, Mr. W. G.	5	0
Jotham, D. and Son, Messrs.	5	0
Krieger, Mr.	5	0
Lee, Mr. R.	5	0
Lucoch, Mr. A. T.	1	0
Martin & Marquand, Messrs.	5	0
Marychurch, J. & Co.	1	0
Morel Bros. & Co. Messrs.	10	6
Morgan, Mr. J. T.	1	0
Nell, Mr. R. F.	10	6
Nixon, Mr. Thos.	5	3
Nixon, Taylor, and Cory, Messrs.	1	0
Page & Co., Messrs.	1	0

Table with 3 columns: Name, £, s, d. Lists names like Parry Bros., Plain, Mr. T., Powell, Duffryn & Co., Messrs., Price, W. and Sons, Messrs., Pym, Watson, and Co., Messrs., Richards, Mr. D., Richards, Rev. H. H., Riley, Mr. W., Rönnefeldt, Mr. W., Rous, The Misses., Rundle, Mr. C. O., Short and Dunn, Messrs., Smith, Mr. W. R., Spiller & Co. Messrs., Stallybrass, Balmer, and Co., Stephens, Mr. T. H., Stowe, Mr. G. S., Strong, W. & R. H., Messrs., Tapson, Mr., Tellefsen, Wills and Co. Messrs., Thomas and Griffiths, Messrs., Thomas, Mr. A. R., Thomas, Mr. W., Thompson, Mr. T. R., Thomson, Mr. A., Todd, Mr. R. R., Troedryheo Coal Co., Turnbull, Bros., Vellacott, Mr. H., Williams, Mr. T. J., Wilson, Mr. J. H., Windsor, Lord, Worms, Mr. H., Young, C. O. & Christie, Messrs., Sums under 5s., Total, Donations, Greenhill, Mr. F. R., Helgham & Co., X. Y. Z., Boxes, Penarth Hotel, Custom House, Eagle Brewery, Life-boat House, Boxes under 5s., Total Dons., Total Subs., Patron—C. R. M. TALBOT, Esq. M.P., President—J. C. NICHOLL, Esq., Honorary Secretary—Rev. W. JONES, Annual Subscriptions, Brogden, James, Esq., Bate, Marquis of, Byass & Co., Messrs., R. B., Carne, J. W. Stradling, Esq., D.C.L., Clark, G. T. Esq., David, Edward, Esq., David, Evan, Esq., Davis, Wm. Esq., Dunsraven, Earl, Dyke, T. J. Esq.

Table with 3 columns: Name, £, s, d. Lists names like Edmondson, Rev. Thos., Forbes, Miss, Gibbon, J. S. Esq., Gwyn, Howel, Esq., Halkett, Mrs., Homfray, J. R. Esq., Jenkins, Mrs. Blandy, Jones, J. D. Esq., Knight, Rev. C. R., Knight, Mrs. E. D., Llewellyn, G. Esq., Llewellyn, J. T. D. Esq., Llewellyn, R. W. Esq., Llewellyn, W. Esq., Morris, G. Byng, Esq., Nicholl, Lieut.-Col., C. R. H., Nicholl, J. C. Esq., Olivant, Mrs., Prichard, W. Esq., Stacey, Rev. C., Traherne, Major, Turberville, Lt.-Col., Turberville, Mrs., Williams, W. Esq., Wilson, Thos. Esq., Wimborne, Lord, Donations, Box at Life-Boat, House, Box at Wyndham, Bridgend, Total, SWANSEA BRANCH, Honorary Secretary—T. W. ISLAY YOUNG, Esq., Annual Subscriptions, Bath, Henry & Son, Bidduhlph, Brewery Co., Crowhurst, Mr. H. W., Evans, J. M., Ford, Capt., Forester, Mr. W. H., Gilbertson, W. & Co., Gold, Mr. Charles, Goodall, Mr. H. G., Grenfell and Sons, Harvey & Fish, Haynes, Mr. G. B., Horman-Fisher, Mr. S. S. H., James, Mr. F., Manger, E. O., Mesnier & Co., Michael, Mr. James, Nettell, J. T., Prevost & Letricheux, Richardson, Mr. J. C., Richardson and Co., Townshend, Wood, & Co., Trustees of Swansea Harbour, Tulloch, I., Vivian, Mr. H. H., Vivian, Mr. W. G., Williams, Mr. F. E., Total, Donations, Blyth, Mrs. R., Bush, J. and R., Butterworth, M<sup>r</sup> Arthur & Co., Daniel, Thos. & Sons, Edgar, Miss, Edgar, Miss R., Gell, Mrs., G. H. P., Goodwyn, T. W., Goody, Cripps, & Sons, Grace, J. and H., Hill, C. and Sons, Hutchins, T. C., Justice, F. W., Justice, Miss., Justice, Miss M. E., King, R. P. & W. P., Merry, W., Miles, W. H., Phillips, J. R. & Co., Powell, W. & Sons, Rushforth, Mrs. E. M., Russell, Miss., Russell, Miss C. E., Russell, Rev. J. C., Stroud, Rev. H., Stuckey and Co., Terrell, W. and Sons, Thomas, C. J. & Bros., Wansley, A., Wedmore, T., Whitwill, M., Woodman, C., Wright, W.

Gloucestershire.

BRISTOL BRANCH.

Chairman—M. WHIRWILL, Esq.
Honorary Secretary—Capt. HUTCHINS.
Collector—Mr. Z. JONES, 19 College Green.

Annual Subscriptions.

Table with 3 columns: Name, £, s, d. Lists names like Beesley, J. R., Blyth, Mrs. R., Bush, J. and R., Butterworth, M<sup>r</sup> Arthur & Co., Daniel, Thos. & Sons, Edgar, Miss, Edgar, Miss R., Gell, Mrs., G. H. P., Goodwyn, T. W., Goody, Cripps, & Sons, Grace, J. and H., Hill, C. and Sons, Hutchins, T. C., Justice, F. W., Justice, Miss., Justice, Miss M. E., King, R. P. & W. P., Merry, W., Miles, W. H., Phillips, J. R. & Co., Powell, W. & Sons, Rushforth, Mrs. E. M., Russell, Miss., Russell, Miss C. E., Russell, Rev. J. C., Stroud, Rev. H., Stuckey and Co., Terrell, W. and Sons, Thomas, C. J. & Bros., Wansley, A., Wedmore, T., Whitwill, M., Woodman, C., Wright, W., Total, Donations, Tulloch, Mrs. Box, Bristol Marine Association, Greffey, W. P., Hiscocks, R., Lacey, J., Leonard, Miss, Rowe, Mr. J., Screw steamer Calypso, Do. Juno, Society of Merchant Venturers, Total Dons., Total Subs., Patron—Wm. PAYNE, Esq., Nat. Prov. Bank of England, Portsmouth, Annual Subscriptions, Allnutt, Mr., Austen, Rev. G., Bacon, Mr. F., Baker, Ed., Balday, Rev. F., Blake, Rev. J. S., Bramley, R. J., Briggs, Colonel, Bull, Wm. M., Carter, Mr. B. W., Chambers, Mr. W. G., Conway-Gordon, Col., F., Darroch, Rev. C. P. T., Davies, Mrs. R. E., Total Dons., Total Subs.

Table with 3 columns: Name, £, s, d. Lists names like Friend, A., Hawkins, Miss, Haydock, Mrs., Hodgson, Capt. G. E., Lloyd, Mrs., Pitham, Henry, Esq., Scarth, Mrs., Selbig, Samuel, Tapp, Mrs. Denning, Williams, Miss., Young, Captain R.N., Total, Donations, Abbott, Sir F., Aston, Rev. J. A., Christian, Admiral., Debenham & Hewett, Messrs., Dixon, J. J. Esq., Evans, J. Bowle, Esq., Geddes, Lieut. Col., Gillilan, Esq. E. H., Godfrey, H. Esq., Harland, C. Esq., Jackson, Mr. T. R., Kay Brook, Sir, Kennedy, Mrs. C. P., Lewis, Mrs. I. Montpelier Terrace, Martin & Co., Owen, Rev. J. A., Robberds, Rev. J., Roper, H. Esq., Shirer & Haddon, Messrs., Skillicorne, W. Nash, Esq., Sloper, G. O. Esq., Voile, Thos. & Co., Walker, J. Esq., Young, Lieut.-Col., Total Dons., Total Subs., £25 4 0

PORHCRAWL BRANCH.

Patron—C. R. M. TALBOT, Esq. M.P.
President—J. C. NICHOLL, Esq.
Honorary Secretary—Rev. W. JONES.
Annual Subscriptions.
Brogden, James, Esq. 1 1 0
Bate, Marquis of... 5 0 0
Byass & Co., Messrs.
R. B. 2 2 0
Carne, J.W. Stradling, Esq., D.C.L. 1 1 0
Clark, G. T. Esq. 1 0 0
David, Edward, Esq. 10 0 0
David, Evan, Esq. 10 6 0
Davis, Wm. Esq. 1 1 0
Dunsraven, Earl. 5 0 0
Dyke, T. J. Esq. 10 6 0

SWANSEA BRANCH.

Honorary Secretary—T. W. ISLAY YOUNG, Esq.
Annual Subscriptions.
Bath, Henry & Son. 5 5 0
Bidduhlph, J. 1 0 0
Brewery Co. 1 1 0
Crowhurst, Mr. H. W. 10 6 0
Evans, J. M. 10 6 0
Ford, Capt. 1 1 0
Forester, Mr. W. H. 1 1 0
Gilbertson, W. & Co. 1 1 0
Gold, Mr. Charles. 1 1 0
Goodall, Mr. H. G. 10 6 0
Grenfell and Sons. 2 2 0
Harvey & Fish. 10 6 0
Haynes, Mr. G. B. 10 6 0
Horman-Fisher, Mr. S. S. H. 10 6 0
James, Mr. F. 1 1 0
Manger, E. O. 2 6 0
Mesnier & Co. 1 1 0
Michael, Mr. James. 10 6 0
Nettell, J. T. 10 6 0
Prevost & Letricheux. 5 0 0
Richardson, Mr. J. C. 1 1 0
Richardson and Co. 2 2 0
Townshend, Wood, & Co. 1 1 0
Trustees of Swansea Harbour. 50 0 0
Tulloch, I. 10 6 0
Vivian, Mr. H. H. 3 3 0
Vivian, Mr. W. G. 1 1 0
Williams, Mr. F. E. 10 6 0
Total. £59 14 6
Donations.
Tulloch, Mrs. Box. 10 10 0
Bristol Marine Association. 6 6 0
Greffey, W. P. 9 3 0
Hiscocks, R. 5 0 0
Lacey, J. 8 0 0
Leonard, Miss. 5 0 0
Rowe, Mr. J. 5 0 0
Screw steamer Calypso. 13 6 0
Do. Juno. 2 12 1 0
Society of Merchant Venturers. 10 10 0
Total Dons. 36 18 10
Total Subs. 43 15 0
£80 13 10
Cheltenham BRANCH.
Hon. Secretary—Captain G. E. HODGSON.
Collector—Mr. W. WITCHELL.
Annual Subscriptions.
Adams, Mrs., Cots-wold Grange. 10 0 0
Bell, W. E. Esq. 1 1 0
Busfield, Mrs. 2 0 0

Hampshire.

PORTSMOUTH AND HAYLING ISLAND BRANCH.

Honorary Secretary—Wm. PAYNE, Esq.
Nat. Prov. Bank of England, Portsmouth.
Annual Subscriptions.
Allnutt, Mr. 5 0 0
Austen, Rev. G. 10 0 0
Bacon, Mr. F. 1 0 0
Baker, Ed. 10 6 0
Balday, Rev. F. 5 0 0
Blake, Rev. J. S. 1 0 0
Bramley, R. J. 10 0 0
Briggs, Colonel. 10 6 0
Bull, Wm. M. 10 6 0
Carter, Mr. B. W. 1 0 0
Chambers, Mr. W. G. 10 0 0
Conway-Gordon, Col. F. 1 1 0
Darroch, Rev. C. P. T. 1 1 0
Davies, Mrs. R. E. 10 0 0

**BRANCHES—LIST OF ANNUAL SUBSCRIPTIONS AND DONATIONS. 339**

	£.	s.	d.
Deimé, H. P. Esq. . . . .	1	1	0
Dunlop, Commander			
R.N. . . . .	5	0	
Farley, Miss. . . . .	5	0	
Festing, Col. Sir F.,			
K.C.M.G., C.B. . . . .	10	6	
Ford, Mr. R. W. . . . .	5	0	
Foster, H. P. . . . .	10	6	
Gloynce, Mr. J. . . . .	5	0	
Grant & Co. Messrs. . . . .	1	1	0
Grant, Mr. C. H. . . . .	10	0	
Hackman, Mr. L. L. . . . .	1	1	0
Hall Hall, Mrs. . . . .	1	0	0
Hall, J. S. . . . .	1	1	0
Heron, M. L., per			
Stokes & Co. . . . .	2	2	0
"Hants Telegraph" . . . . .	10	0	
Hardy, Rev. C. . . . .	10	0	
Harrison, Miss. . . . .	10	0	
Holdsworth, Miss. . . . .	10	6	
Jackson, Dr. . . . .	5	0	
Jacob, Rev. Edgar . . . . .	10	6	
Jeans, H. W. Esq. . . . .	1	0	0
Key, Comm. & Mrs. . . . .	10	6	
Knight, J. P. . . . .	1	1	0
Knighton, Sir W. W.			
Bart. . . . .	1	1	0
Knight, S. P. . . . .	10	6	
Knox, Capt. (V.C.) . . . . .	5	0	
Lancaster, Capt. H. J. . . . .	1	0	0
Landport railway			
Station Collecting			
Box . . . . .	12	9	
Langdale, Rev. G. A. . . . .	5	0	
Lethbridge, Admiral . . . . .	5	0	
Lush, Mr. Joseph. . . . .	10	0	
Marvin, Mrs. R. . . . .	5	0	
Moore, Miss M. S. . . . .	1	0	0
Murray, Mrs. E. D. . . . .	10	6	
Nat. Prov. Bank of			
England, Portsea			
Branch . . . . .	1	1	0
Norman, Dr. . . . .	5	0	
Pares, John, Esq. . . . .	1	1	0
Payne, W. . . . .	5	0	
Peile, Capt. M. S. L.,			
R.N. . . . .	10	6	
Pike, Spencer, & Co.,			
Messrs. . . . .	1	1	0
Raby, Admiral, V.C. . . . .	5	0	
Bake, G. . . . .	5	0	
Ricketts, Mr. E. . . . .	10	0	
Ricketts, Miss. . . . .	1	0	0
Ryder, Admiral,			
Commander-in-			
Chief. . . . .	1	0	0
Sandeman, Mrs. . . . .	5	6	0
Seymour, Admiral			
Sir M. Bart., G.C.B. . . . .	1	0	0
Sheppard, C. W. . . . .	5	0	
Sheppard, Rev. H.W. . . . .	1	0	0
Stokes, Capt. R., R.N. . . . .	1	0	0
Tatchell and Son,			
Messrs. . . . .	10	0	
Taylor, Capt. R.N. . . . .	5	0	
Treadgold, Mr. W. . . . .	10	0	
Turner, Mr. W. C. . . . .	5	0	
Weeks, Mr. . . . .	5	0	
Woodman, Mrs. . . . .	10	0	
Collecting Boxes. . . . .	7	3	8
Sums under 5s. . . . .	5	0	
Total . . . . .	255	19	5

Total . . . . . 255 19 5

### Isle of Wight.

### ISLE OF WIGHT BRANCH.

**Chairman—**  
CHARLES SERLY, Esq., M.P.

**Treasurer—**  
G. WYATT, Esq., Newport, I.W.

**Honorary Secretaries—**  
Rev. W. E. HEYGATE,  
Rector of Brightstone;  
Rev. R. BROUROW,  
Vicar of Shorewell.

WILLIAM SELBY, Esq., Brooke.

#### Annual Subscriptions.

	£.	s.	d.
Barrett, O. Moulton,			
Esq. . . . .	3	0	0
Blake, J. Ruffin, Esq. . . . .	10	6	
Brigstocke, Miss. . . . .	1	1	0
Broughton, Rev. R. . . . .	10	6	
Brown, Mr. C. . . . .	5	0	
Brown, Mr. H. . . . .	5	0	
Browne, Lt.-Col. H.G. . . . .	1	1	0
Bushnell, Mrs. . . . .	10	0	
Carter, E. Esq. . . . .	1	1	0
Carter, Miss. . . . .	10	6	
Cochrane, Lady. . . . .	1	0	0
Collins, E. P. Esq. . . . .	10	6	
Collins, Miss. . . . .	10	6	
Connor, Rev. Canon,			
E. D. . . . .	10	0	
Cottle, Rev. Thomas . . . . .	1	0	0
Cotton, B. T. Esq. . . . .	1	1	0
Crozier, Mrs. . . . .	1	1	0
Earl Yarborough			
Lodge of Odd Fel-			
lows . . . . .	1	1	0
Eldridge, Jas. Esq. . . . .	10	0	
Eveleigh, Captain. . . . .	1	1	0
Feilden, Misses. . . . .	2	0	0
Gaze, Rev. J. Pellaw. . . . .	10	6	
George, Mr. Jas. . . . .	5	0	
Giles, Mrs. George. . . . .	2	2	0
Golden, Mr. Isaac. . . . .	10	6	
Gordon, Lady Mary. . . . .	1	1	0
Harvey, Capt. T. &			
Mrs. . . . .	2	0	0
Hayton, Rev. G. . . . .	10	6	
Herschel, Sir Wm. . . . .	10	0	
Heygate, Rev. W. E. . . . .	1	0	0
Heytesbury, Lord . . . . .	1	0	0
Hoffmeister, W. C.			
Esq., M.D. . . . .	5	0	
Hillier, Mr. W. . . . .	5	0	
Hood, Hon. Mrs.			
Grosvenor . . . . .	5	0	
Howard, G. Esq. . . . .	10	0	
Isaacson, Rev. Canon . . . . .	10	6	
Jephson, Commr. A.,			
R.N. . . . .	2	2	0
Jolliffe, Mr. Jonathan . . . . .	10	0	
Kentfield, Mr. T. . . . .	5	0	
Kerr, Mrs. B. . . . .	1	0	0
Kirkpatrick, Miss. . . . .	1	1	0
Law, Miss. . . . .	5	0	
Le Marchant, Thos.			
Esq. . . . .	1	1	0
Love, Miss, the late. . . . .	1	0	0
Lowther, Capt. Mar-			
cus, R.N. and Mrs. . . . .	2	2	0
Macnamara, Rev. T. B. . . . .	1	0	0
Manners, Lieut.-Col.			
W. W. . . . .	10	0	
Martin, Miss F. P. . . . .	3	0	0
Meares, Huah, Esq. . . . .	10	0	
Mew, Messrs. W. B.			
Langton and Co. . . . .	1	1	0
Meyers, Barnett, Esq. . . . .	1	1	0
Mildmay, Sir Henry,			
Bart. . . . .	1	1	0
Milidge, Mr. W. H.,			
the late. . . . .	5	0	0
Moore, Mr. James . . . . .	10	6	
Mortimer, H. Esq.			
J.P. . . . .	10	0	

	£.	s.	d.
Mortimer, Wm. Esq.			
J.P. . . . .	10	6	
Mowbray, Mr. John . . . . .	5	0	
Newnham, Mr. . . . .	5	0	
Newnham, Mr. C. . . . .	5	0	
Oglander, Lady . . . . .	2	2	0
Ommaney, Admiral			
Sir Erasmus . . . . .	10	6	
Pattinson, Maj. W. H. . . . .	10	0	
Pelham, Hon. Mrs. D. . . . .	1	1	0
Pennethorne, J. Esq. . . . .	1	1	0
Pring, Mr. Samuel . . . . .	10	0	
Richards, Mrs. Russell . . . . .	1	1	0
Scott, Miss. . . . .	5	0	
Secker, G. H. Esq. . . . .	1	1	0
Seely, C. Esq. M.P. . . . .	2	2	0
Seely, Mrs. . . . .	1	1	0
Selby, Mr. Wm. . . . .	5	0	
Sewell, Miss. . . . .	10	0	
Shedden, Mrs. W. G. . . . .	1	0	0
Simcon, Sir Barring-			
ton, Bart. . . . .	1	1	0
Smith, Capt. Gilbert			
Spencer . . . . .	1	0	0
Sorby, Misses H. & L. . . . .	10	0	
Southouse, Rev. G. W. . . . .	7	6	
Spickernell, Mr. J. J. . . . .	5	0	
Spickernell, Mr. Wm. . . . .	5	0	
Swift, Mrs. Catherine . . . . .	1	1	0
Tennyson, A. Esq. . . . .	1	1	0
Thornton, A. B. W.			
Esq. . . . .	1	1	0
Thornton, H. S. W.			
Esq. . . . .	1	1	0
Tubb, Miss A. . . . .	10	0	
Tuffley, Mr. R. . . . .	5	0	
Upward, E. J. Esq. . . . .	1	1	0
Vibert, Mr. Benjamin . . . . .	1	1	0
Ward, Miss, the late . . . . .	2	0	0
Ward, W. G. Esq. . . . .	1	1	0
Way, Mr. Henry . . . . .	10	6	
Way, Mr. W. C. . . . .	5	0	
Winther and Co.			
Messrs. . . . .	1	0	0
Wood, J. Esq. . . . .	2	2	0
Worsley, J. Esq. . . . .	1	1	0
Wright, H. Smith,			
Esq. . . . .	1	1	0
Wyatt, Mr. G. . . . .	10	6	
Yard, Mrs. Alleyne. . . . .	1	0	0
Total . . . . .	84	5	6

**Donations.**

Amalgamated De-			
monstration Com-			
mittee of Odd			
Fellows and Fo-			
resters. . . . .	1	1	0
Ashley, Hon. Evelyn,			
M.P. . . . .	2	0	0
Barrett, O. M. Esq. . . . .	1	0	0
Browne, Mrs. Lt.-Col. . . . .	2	0	0
Carisbrooke Congre-			
gational Collection			
by Rev. E. B.			
James. . . . .	10	14	6
Dowling, Mr. H. . . . .	5	0	0
Heygate, Rev. W. E. . . . .	3	5	0
Woodford, Mrs. . . . .	10	0	
Collecting Boxes:—			
Golden, Master			
Leonard . . . . .	1	1	1
Royal Needles Hotel,			
Alum Bay . . . . .	1	4	0
Sums under 5s. . . . .	12	5	
Total Dons. . . . .	23	13	0
Total Subs. . . . .	84	5	6
£107 18 6			

### BEMBRIDGE BRANCH.

**Chairman—**  
The Marquis of CHOLMON-  
DELEY.

**Honorary Secretary—**  
Admiral WILMSHURST.

#### Annual Subscriptions.

	£.	s.	d.
Cholmondeley, The			
Marquis of (1879) . . . . .	2	2	0
" " (1880) . . . . .	2	2	0
Clayton, Rev. A. P. . . . .	10	6	
Clayton, W. L. N. Esq. . . . .	10	0	
Le Mesurier, Rev. J. . . . .	1	1	0
Levinge, W. H. Esq. . . . .	10	0	
McDonald, Capt., R.N. . . . .	10	0	
Moreton, Captain			
A. M. D. . . . .	2	2	0
Palmer, Rev. J. N. . . . .	1	1	0
Thomas, F. R. Esq. . . . .	1	1	0
Wilmshurst, Admiral . . . . .	1	0	0
Small Subscriptions. . . . .	16	0	
Total . . . . .	£13	5	6

#### Donations.

Seymour, Captain. . . . .	10	0	
Sale of Life-Boat			
Stores . . . . .	1	3	0
Sundry Donations . . . . .	15	6	

Total Dons. . . . .	2	8	6
Total Subs. . . . .	13	5	6
£15 14 0			

### Kent.

### BROADSTAIRS BRANCH.

**Chairman—**  
Rev. J. H. CARR.

**Honorary Secretary—**  
Mr. THOS. JACKSON.

#### Annual Subscriptions.

	£.	s.	d.
His Grace the Arch-			
bishop of Canter-			
bury. . . . .	1	0	0
Anson, Admiral. . . . .	10	0	
Banting, W. Esq. . . . .	2	2	0
Barritt, Mr. . . . .	10	0	
Bligh, C. Esq. . . . .	1	1	0
Brown, Miss . . . . .	10	0	
Buckingham, J. Esq. . . . .	1	1	0
Bullivant, —, Esq. . . . .	1	0	0
Carr, Rev. J. H. . . . .	1	0	0
Chapman, Mr. Lacy. . . . .	10	6	
Delo, Mr. S. H. . . . .	5	0	
Elyard, Lieut.-Col. . . . .	10	0	
Elyard, The Misses . . . . .	1	1	0
Eveling, M. Esq. . . . .	10	6	
Harwood, Mrs. . . . .	1	1	0
Iles, W. Esq. . . . .	1	2	0
Jackson, Mrs. . . . .	1	1	0
Lasham, Mr. . . . .	5	0	
Marriott, E. T. . . . .	1	1	0
Mortimer, —, Esq. . . . .	1	1	0
McNally, Mr. . . . .	5	0	
Moyes, John, Esq. . . . .	1	1	0
North, Hon. H. F. . . . .	1	1	0
Painter, Mr. Wm. . . . .	10	0	
Poore, E. . . . .	5	0	
Walter, O. C. Esq. . . . .	10	0	
Wyatt, W. Esq. . . . .	1	1	0
Total . . . . .	£21	14	0

#### Donation.

Fisher, J. A. Esq. . . . .	2	10	0
£24 4 0			

DOVER BRANCH.

Chairman—Major SCOTT.
Honorary Secretary—Lieut.-Gen. BRUCE, C.B.

Table with columns £, s, d. listing annual subscriptions for Dover Branch, including names like Austen, Ayers, Back, Baird, Birmingham, Boodle, Boyle, Bradley Brothers, Bruce, R.N., Buca, Cannon, Court, Cow, Crosby, Dickson, Finnis, Flashman, Frith, Graves, Goren, Hathorn, Hayward, Heath, Hills, Hughes, Hyde, Igglesden, Joyce, Knocker, Marshall, Maxwell, Mesham, Morgan, Poole, Ramsbottom, Rose, Schyott, Scott, Sisco, Smithett, Stilwell, Stuart, Sutton, Warsfold, Weston, Wilson, Wissenden, and sums under 5s.

Table listing donations and collecting boxes for Dover Branch, including W. Lake, Circus, and Ginnett, with totals of £47 15 6.

GOODWIN SANDS AND DOWNS BRANCH.

Patrons—The Right Hon. the EARL GRANVILLE, K.G., P.C. SIR WALTER JAMES, BART.
Chairman—Capt. G. DOUGLAS, R.N.
Treasurer and Hon. Sec.—Rev. T. S. TERBOR.
Local Hon. Secretary at Kingsdown—Mr. W. BAILEY.

Table with columns £, s, d. listing annual subscriptions for Goodwin Sands and Downs Branch, including A Friend, Boys, Benson, Bray, Chennell, Cullen, Darby, Edwards, Evans, Frost Bros, Griffith, Hammond and Co, Harvey, Henderson, Hilton, Harrison, Hulke, Iggulden, James, Kemball, Lamplough, Long, McEnragh, Morris, Nethersole, Pittock, Roope, Sydney, Soward, Watt, Westhorp, Wood, and Small Sums, with a total of £28 9 0.

Table listing donations for Goodwin Sands and Downs Branch, including Deal collecting box, Deal Dramatic Society, and Hicks, with totals of £55 17 4 and £28 9 0.

WALMER LIFE-BOAT.
P.C. Granville, Earl, K.G.
A Lady, per J. Henderson, Esq.
Benson, Rev. E. W.
Boys, Mrs.
Brassey, H. Esq. M.P.
Brooke, Miss.
Bushe, Capt. R.N.
Cannon, Vice-Adm.
E. St. Leger.

Table with columns £, s, d. listing annual subscriptions for Hythe, Sandgate, and Folkestone Branch, including Cullen & Sons, Douglas, Duthie, Elliston, Fisher, Friend, Green, Griffith, Halse, Hammond, Harvey, Hill, Hilton, Hugessen, James, Kemball, Kenrick, McEnragh, Monins, Nethersole, Samler, Simpson, Smith, Thompson and Sons, Walmer Collecting Box, Watt, and Woodruffe, with totals of £121 10 6.

HYTHE, SANDGATE, AND FOLKESTONE BRANCH.
President—The Rt. Hon. Lord PELHAM.
Chairman—Capt. A. SARBEAUNT, R.N. Folkestone.
Treasurer—J. R. DAVY, Esq., N. P. Bank, Folkestone.

Table with columns £, s, d. listing annual subscriptions for Hythe, Sandgate, and Folkestone Branch, including Andrews, Ashdown, Barton, Bligh, Brockman, Burden, Cobb, Cobbs, Davy, Dawson, Deedes, Edwards, Fitness, Godden, Hankey, Harrison, Hart, Hoad, Holden, Jenkins, Jones, Kingsford, Kirkpatrick, Lonsdale, Mackeson, Morton, Nelson, Orenden, Pledge, and Rigden, with totals of £25 17 2 and £284 6 4.

Table with columns £, s, d. listing annual subscriptions for Kingsgate Branch, including Russell, Sampson, Sandlands, Sherwood, Shipwash, Sargeant, Sidle, Smith, Thompson, Tolpunn, Tourney, Walton, Ward, Watkin, Wildash, Wilks, Williamson, Wilson, and Wilson, Mr. William, with a total of £23 8 0.

KINGSGATE BRANCH.
Honorary Secretary—Capt. ISAACK, H.C.S.

Table with columns £, s, d. listing annual subscriptions for Kingsgate Branch, including His Grace the Archbishop of Canterbury, Alexander, Cotton, Edmeades, Fearon, Hannam, Harris, Hodgson, Isacke, Levy, Metcalfe, Rammell, Webb, Whish, Whish, and Whitehead, with a total of £19 4 0.

Table listing donations for Kingsgate Branch, including Pillar Boxes (1880), with a total of £6 13 2.

LYDD DUNGENESS BRANCH.

Table with columns £, s, d. listing annual subscriptions for Lydd Dungeness Branch, including William, Bass, Blacklocks, Burra, Burton, Denne, Finns, Howson, Prescott, and Procter, with a total of £25 17 2.



BRANCHES—LIST OF ANNUAL SUBSCRIPTIONS AND DONATIONS. 341

	£.	s.	d.
Selmes, Messrs. ....	10	0	0
White, Mrs. C. ....	6	0	0
Wingate, Rev. W.C.L. ....	10	0	0
Wood, Field, & Ham-			
bury, Messrs. ....	1	0	0
Young, E. D., Esq. ....			
R.N. ....	10	0	0
<b>Total</b> .....	£11	11	0
<b>Donations.</b>			
Bevan, Rd. Esq. ....	10	0	0
Sums under 5s. ....	8	4	0
<b>Total</b> .....	£12	9	4

**MARGATE BRANCH.**

Chairman—  
J. T. FRIEND, Esq., J.P.

Honorary Secretary—  
ROBERT ISAACSON, Esq.

**Annual Subscriptions.**

Amos, Mr. G. (1879			
& 1880).....	10	0	0
Arnold, Mr. W. G. ....	5	0	0
Bayly, Mr. John. ....	5	0	0
Benham, Rev. W.,			
B.D. (1879).....	10	0	0
Bentley, Messrs. D.			
and W. and Son ....	5	0	0
Blyth, Rev. E. H.,			
M.A. ....	5	0	0
Bower, W. G. Esq. ....	10	6	0
Boulden, Rev. A. W.,			
M.A. ....	10	0	0
Bradley, Mrs. ....	5	0	0
Carroway, Mr. John ....	5	0	0
Chancellor, Mr. S. S. ....	5	0	0
Chubb, Mr. J. F. ....	5	0	0
Cubb, A. B. Esq. ....	10	0	0
Cobb, F. C. Esq. ....	1	0	0
Cobb, T. F. Esq. ....	1	0	0
Cotton, H. H. P., Esq. 1	0	0	0
Crawford & Co. Messrs. 1	1	0	0
Cutlack, R. and A. ....	5	0	0
DeVaynes, Miss ....	1	0	0
Dentry, James, Esq. ....	10	0	0
Daring, Sir E. C. Bart. 2	2	0	0
Edgar, Miss R. ....	10	0	0
Emtage, Mr. D. ....	5	0	0
Eveling, Mr. M. ....	10	6	0
Fagg, Mr. W. A. ....	5	0	0
Food-Kelcey, Geo.,			
Esq. ....	10	6	0
Friend, J. T. Esq. ....	1	0	0
Galindo, Miss ....	5	0	0
Getting, Mrs. C. T.			
(1879 & 1880) ....	2	2	0
Gray, Mr. W. G. ....	5	0	0
Green, Walter, Esq. ....	5	0	0
Greensted, Mr. P. ....	5	0	0
Harris, Mrs. Chas. ....	5	0	0
Harvey, Mr. W. S. ....	5	0	0
Hatfield, Capt. ....	10	0	0
Head, G.F. Esq. LL.D. ....	10	0	0
Hermitage, Mr. H. F. ....	5	0	0
Horwell, T. E. Esq. ....	1	1	0
Hume, Mr. J. ....	5	0	0
Isaacson, E. Esq. ....	1	1	0
Jones, Rev. W.			
Taylor ....	1	1	0
Kerr, Robt. Esq. ....	10	6	0
Kidd, Mrs. ....	10	6	0
Knight, Rev. C. ....	10	0	0
Love, Horatio, Esq. ....	10	0	0
Malins, Mr. J. B. ....	5	0	0
Mercer, W. Esq. ....	5	0	0
Paramor, Messrs. R.			
and Son ....	5	0	0
Pittock, Dr. ....	5	0	0
Purdey, J. Esq. ....	1	1	0
Reeve, Messrs. T. U.			
and J. ....	5	0	0
Robinson, G. W. Esq.			
M.A. ....	10	6	0
Rowe, Dr. T. S. ....	1	0	0

	£.	s.	d.
Rowe, Mr. T. S. ....	5	0	0
Russell, Geo. Esq. ....	2	2	0
Scott, Miss ....	2	2	0
Searles, Mr. Walter. ....	5	0	0
Smeed, Mr. F. ....	5	0	0
Smith, C. D. Esq. ....	5	0	0
Staner, Mr. J. H. ....	5	0	0
Stile, S. Esq. ....	1	0	0
Thornton, Miss ....	2	2	0
Thurston, Mr. J. ....	5	0	0
Treves, W. K. Esq. ....	5	0	0
Wastall & Co. Messrs. ....	5	0	0
Weekley, Mr. J. ....	5	0	0
Willett, T. W. Esq. ....	5	0	0
Wood, R. Esq. ....	5	0	0
Woodruff, Mr. W. C. ....	5	0	0
Wootton, Mr. A. ....	5	0	0
Wootton, S. Esq. ....	10	0	0
Young, Mr. H. W. ....	5	0	0
Sums under 5s. ....	2	0	0
<b>Total</b> .....	£42	18	0

**Donations.**

Rich, Miss. ....	5	0	0
Simpson, the Misses. ....	10	0	0
Sums under 5s. ....	12	0	0
Small Sums. ....	17	5	0
Pillar Box on Jetty			
Extension ....	3	11	10
Do. at L. C. & D. R.			
Station ....	1	16	3
Do. at S.E.R. Station .....	12	11	0
Do. at Hoy Hotel. ....	7	7	0
<b>Total Dona.</b> ....	8	13	0
<b>Total Subs.</b> .....	£42	18	0
<b>Total</b> .....	£51	11	0

**NEW ROMNEY BRANCH.**

Chairman—  
HENRY COBB, Esq.

Honorary Secretary—  
HENRY SPRINGER, Esq.

**Annual Subscriptions.**

Baker, C. E. Esq. ....	1	0	0
Blake, Mr. ....	1	0	0
Blake, Miss ....	5	0	0
Castle, Miss ....	1	0	0
Cobb, Mrs. ....	10	0	0
Cobb, Henry, Esq. ....	5	0	0
Curling, Miss ....	5	0	0
Denne, Alured, Esq. ....	10	0	0
Finn, Mrs. G. ....	10	0	0
Furley, R. Esq. ....	1	1	0
Humphrey, J. Esq. ....	5	0	0
Hunt, Mr. L. ....	10	0	0
Jones, J. Esq. ....	10	0	0
Kingsnorth, Mr. E. ....	10	0	0
Miller, Mrs. ....	5	0	0
Pearson, Mr. ....	5	0	0
Russell, Mrs. ....	10	0	0
Scott, Miss. ....	1	1	0
South, Rev. R. M. ....	10	6	0
Stringer, H. Esq. ....	1	1	0
Stringer, Capt. R.N. ....	1	1	0
Thornton, Miss ....	3	3	0
Tufton, Sir Henry J.			
Bart. ....	1	0	0
Contents of Box at			
Ship Hotel, Dym-			
church ....	11	2	0
Do. at Littlestone			
Station ....	5	0	0
<b>Total</b> .....	£17	14	8

**PORT OF ROCHESTER BRANCH.**

President—  
His Worship the MAYOR.

Honorary Secretary—  
MR. J. H. CROCKFORD.

**Annual Subscriptions.**

	£.	s.	d.
Aldridge, Mr. W. ....	10	0	0
Allen, Mrs. ....	5	0	0
Austen, Mr. W. ....	5	0	0
Aveling, T. Esq. ....	1	0	0
Bartram, Capt. Sch.			
Yacht <i>Merlin</i> ....	1	1	0
Belsey, F. F. Esq. ....	10	6	0
Budden, A. F. Esq.			
(Mayor of Roches-			
ter) .....	10	6	0
Budden, W. Esq. ....	10	0	0
Bullard, Mr. C. ....	5	0	0
Burfield, Mr. R. C. ....	5	0	0
Crockford, Mr. J. H. 1	1	0	0
Edwards, J. L. Esq. ....	5	0	0
Food, J. and Sons,			
Messrs. ....	1	1	0
Gardiner, Mr. A. F. ....	10	0	0
Gill, Mr. G. W. ....	10	0	0
Haymen, W. Esq. ....	1	1	0
Hills, Mr. J. S. ....	5	0	0
Hills, Mr. W. ....	5	0	0
Royal Engineer Yacht			
Club, School of			
Military Engineer-			
ing, per Lieut. A.			
E. Sandbach ....	2	0	0
Watson & Gill ....	10	6	0
Webb, Mr. W. ....	5	0	0
Woodhams, W. Esq. ....	10	6	0
<b>Total</b> .....	£13	6	0

**Donations.**

Contents of Boxes L			
& P. Bank Branch			
Chatham. ....	5	9	0
Do. Do. Rochester			
Branch. ....	8	9	0
Do. London and			
County Bank,			
Chatham Branch. ....	16	1	0
Royal Victoria Owl			
Club, Rochester. ....	2	2	0
Amounts under 5s. ....	3	6	0
<b>Total Dona.</b> ....	3	16	1
<b>Total Subs.</b> .....	£17	2	1

**Lancashire.**

**BLACKBURN BRANCH.**

President—  
His Worship the MAYOR.

Treasurer—  
J. S. POLLITT, Esq.,  
Manchester and County Bank.

Honorary Secretary—  
JOSEPH BRIBLEY, Esq. C.E.

**Donations and Subscriptions.**

	£.	s.	d.
His Worship the			
Mayor, Henry			
Harrison, Esq. ....	1	1	0
Appleby and Son ....	1	1	0
Birch, Herbert, Esq. ....	1	1	0
Boyd, John ....	5	0	0
Brierley, J., C.E. ....	10	6	0

	£.	s.	d.
Bryan, W. B., C.E. ....	5	0	0
Cockcroft, Miss ....	5	0	0
Coddington, W. Esq.,			
M.P. ....	1	0	0
Dodgson, E. B. Esq. ....	1	1	0
Dugdale, Mrs. Adam 1	1	0	0
Hart, Thomas, Esq. ....	1	1	0
Holt, J. M. Esq. ....	1	1	0
Pollitt, J. S. Esq. ....	5	0	0
St. George's School,			
per Rev. A. B.			
Grosart, I.L.D. ....	7	10	0
Do. 2nd contribution -	11	4	0
Thompson, W. Esq. ....	10	0	0
Umpleby, J. ....	10	0	0
Sums under 5s. ....	2	0	0
<b>Total</b> .....	£19	0	10

**BLACKPOOL BRANCH.**

Chairman—  
HENRY HALL, Esq., Mayor.

Treasurer—  
J. PICKOP, Esq.

Honorary Secretary—  
A. M. VINNER, Esq.

**Annual Subscriptions.**

Aspinwall, Miss ....	5	0	0
Brown, Dr. ....	1	1	0
Carter, Miss. ....	10	6	0
Caw, Mrs. ....	10	0	0
Cocker, W. H. Esq. ....	1	1	0
Dutton, Miss. ....	10	0	0
Grindrod, Mr. ....	1	1	0
Handley, Mr. ....	10	6	0
Hanley, Esq. ....	1	1	0
Harrison, R. Esq. ....	1	1	0
Haydock, Mrs. ....	1	0	0
Jeffrey, Rev. N. S. ....	10	6	0
Jenkenson, Miss. ....	10	0	0
Lowe, Miss. ....	10	0	0
Masheer, Mr. ....	5	0	0
Meredith, Esq. ....	1	1	0
Parnell, Mr. ....	1	1	0
Pickop, J. Esq. ....	1	1	0
Rycroft, Capt. ....	10	0	0
Sharples, Mr. George,			
Southshore. ....	10	0	0
Smith, Mr. John. ....	5	0	0
Sutcliffe, Mr. ....	1	1	0
Sykes, Benj. Esq. ....	1	1	0
Thomas, Mrs. ....	1	1	0
Threlfall, Laz. Esq. ....	1	1	0
Tolson, Mrs. ....	1	1	0
Topping, Ewd. Esq. ....	1	1	0
Viner, A. M. Esq. ....	1	1	0
Whiteley, Miss ....	1	1	0
Williams, Mr. ....	10	0	0
Young, Capt. R.N. ....	1	1	0
<b>Total</b> .....	£24	13	6

**Donations.**

Hotel Collecting			
Boxes ....	17	10	4
Pillar Do. ....	12	10	11
<b>Total</b> .....	£54	14	9

**BOLTON BRANCH.**

Chairman—  
JOSEPH MUSGRAVE, Esq.,  
Mayor of Bolton.

Honorary Secretary—  
THOMAS H. WINDER, Esq.

**Annual Subscriptions.**

Abbott, Mr. Wm. ....	10	6	0
Ainsworth, E. H. Esq.			
J.P. ....	1	1	0
Arrowsmith, Mr. T.H. 1	1	0	0

Table listing names and amounts for the Fleetwood Branch, including Barlow and Jones, Barnes & Co. Messrs., Bradshaw, Mr. J., Briggs, A. L. Esq., etc.

Table listing names and amounts for the Lancaster Branch, including Drewry, Mr. William, Drummond, Mr. Thomas A., Dunderdale, Robert, Esq., J.P., etc.

Table listing names and amounts for the Liverpool & New Brighton Branch, including Bell, John, Bell, Thos., Bell, W., Blades, Chas., Bone, Rev. John, etc.

Table listing names and amounts for the Liverpool & New Brighton Branch, including Pryke, Rev. W. Esq., Ripley, Mrs., Roper, W., Rothwell, Miss., etc.

FLEETWOOD BRANCH. Patron - F. KEMP, Esq., J.P. Chairman - J. WIGNALL, Esq., J.P. Treasurer - THOS. DREWRY. Honorary Secretary - J. PICKERING, Esq.

LANCASTER BRANCH. President - Lieut.-Col. GREENE. Honorary Treasurer - J. C. MOON, Esq. Honorary Secretary - M. SIMPSON, Esq.

LIVERPOOL & NEW BRIGHTON BRANCH. President - JOSEPH LEATHER, Esq. Chairman - A. BOWEN, Esq. Treasurer - HABOLD L. BOWEN, Esq. Hon. Secretary at Liverpool - CHARLES H. BELLOE, Esq.

Annual Subscriptions for all branches, listing names and amounts such as Ashton, Mr. Walter, Carr, Mr. Thomas H., Carson, Mr. Alex., etc.

**BRANCHES—LIST OF ANNUAL SUBSCRIPTIONS AND DONATIONS. 343**

£.	s.	d.	£.	s.	d.	£.	s.	d.	£.	s.	d.
Allan, R. G. Esq. ...	1	1	0	Derby, Right Hon. The Earl of. ....	2	2	0	Hutchinson, W. H. Esq. ....	-	10	6
Anderson, W. H. Esq. ....	1	1	0	Dixon, W. T. Esq. .	1	1	0	Thiers & Bell, Messrs.	1	1	0
Anderson, John, Esq., the late. ....	1	1	0	Dobell & Co. Messrs. A. ....	1	1	0	Inman Steam Ship Co. Limited. ....	1	1	0
Anderson, R. & Co. Messrs. ....	1	1	0	Durning, Wm. Esq. .	1	1	0	Ismay, Imrie, & Co. Messrs. ....	2	2	0
Armstrong, Jos. Esq. .	1	1	0	Earles and King, Messrs. ....	1	1	0	Jack & Co. James, Messrs. ....	3	3	0
Ashie, T. F. Esq. ....	1	1	0	Easton, Thos. O. Esq.	2	2	0	Jackson, Jos. Esq. .	1	1	0
Aspinall, Son, and Brooke, Messrs. ...	1	1	0	Eden, Dr. ....	-	10	0	Jackson, R. Esq. ....	1	1	0
Baker, Chas. Esq. ...	1	1	0	Edwards-Moss, Sir T.	5	0	0	Jardine, D. Esq. ....	2	2	0
Bailey, John, Esq. ...	1	1	0	Elder, Dempster, and Co. Messrs. ....	1	1	0	Jacob, W. T. Esq. .	1	1	0
Balfour, Williamson, and Co. Messrs. ...	1	1	0	Elkington and Co. Messrs. ....	1	1	0	Japp & Kirby, Messrs.	1	1	0
Banks, Meyrick, Esq. .	1	1	0	Ellery, Mrs. ....	2	2	0	Johnson, F. Esq. ....	1	1	0
Baring, Brothers & Co. Messrs. ....	2	2	0	Esqrigge, R. A. Esq. .	3	2	0	Johnson, Richd. Esq. .	1	1	0
Barrow, James, Esq. .	1	1	0	Evans, T. Esq. ....	-	5	0	Johnson, R. C. Esq. .	1	1	0
Bartlett, Thos. Esq. .	1	1	0	Fairhurst, J. Esq. .	1	0	0	Johnston, W. and Co. Messrs. ....	5	0	0
Bartlett, Wm. Esq. .	1	1	0	Fletcher, G. H. & Co. Messrs. ....	1	1	0	Jones, Edw. W. Esq. .	1	1	0
Bates, E. and Son, Messrs. ....	2	2	0	Fogg, N. B. Esq. ....	1	1	0	Jones Wm. Esq. ....	-	5	0
Beazley, James, Esq. .	1	1	0	Fowell, Rev. R. D. .	-	10	6	Jones, Thos. Esq. ....	-	10	0
Belcher, M. Esq. ....	1	1	0	Friend, E. C. and Co. Messrs. ....	1	1	0	Jones, W. H. Esq. ....	1	1	0
Belcher, Wm. M. Esq. .	1	1	0	Frangopulo, Agelasto, and Co. Messrs. ...	1	1	0	Kent, Alfred, Esq. ....	-	10	0
Beloe, Charles H. Esq. .	1	1	0	Gamble, D. Esq. ....	1	0	0	Kerferd, G. B. Esq. .	1	1	0
Beloe, H. C. Esq. ....	1	1	0	Gardner, Capt. Thos. .	1	1	0	King, W. Esq. ....	1	1	0
Bennett, Wm. Esq. .	2	2	0	Gardner, Henry, Esq. .	1	1	0	Knox, Wm. Esq. ....	1	1	0
Bewley, Jno. Esq. ....	1	1	0	Gardner, Joseph, Esq. .	5	0	0	Kurtz, A. G. Esq. .	1	1	0
Blower, Dr. ....	-	10	6	Gardner, R. C. Esq. .	-	10	6	Kurtz, Charles & Sons, Messrs. ....	2	2	0
Bouch, John, Esq., J.P. .	1	1	0	Garratt, John, Esq. .	-	10	6	Laird Bros. Messrs. .	2	2	0
Bouch, T. W. Esq. ....	1	1	0	Gillespie & Co. Messrs.	1	1	0	Lampfort and Holt, Messrs. ....	3	3	0
Bower, A. Esq. ....	3	0	0	Gladstone, Robt. Esq. .	1	1	0	Langton, Chas. Esq. .	1	1	0
Bower, H. L. Esq. ....	2	0	0	Glyn, Jno. & Sons, Messrs. ....	1	1	0	Lear, John, Esq. ....	1	1	0
Bowring, C. T. & Co. Messrs. ....	2	2	0	Goffey, Thomas, Esq. .	1	1	0	Leitch, Jas. & Co. Messrs. ....	1	1	0
Boxwell, Wm. Esq. .	1	1	0	Gossage, Fred. H. Esq. .	1	1	0	Litherland, W. Esq. .	1	1	0
Bracker, John, Esq. .	1	1	0	Goodlass, Wall, and Co. Messrs. ....	1	1	0	Little, James, Esq. .	1	1	0
Brandreth, Thos. Esq. .	1	1	0	Graham, Henry, Esq. .	2	2	0	Little, William, Esq. .	1	1	0
Briggs, Capt. W. S. .	1	1	0	Graham, Miss ....	-	10	0	Littledale, H. Esq. .	2	2	0
Bristow, J. Esq. ....	1	1	0	Graves and Son, S. R. Messrs. ....	1	1	0	Lister, Jas. Esq. ....	1	1	0
British and African Steam Ship, Co. ...	2	2	0	Greenfields, T. E. Esq. ....	1	1	0	Liverpool Steam Tug Co. Messrs. The. .	2	2	0
Brocklehurst, G. W. Esq. ....	5	0	0	Grey, Edward, Esq. .	1	1	0	Lloyd, Mrs. M. ....	-	10	6
Brocklehurst, H. Esq. .	1	1	0	Groves, Charles, Esq. .	1	1	0	Lockett, C. H. Esq. .	1	1	0
Brocklehurst, R. Esq. .	1	1	0	Gruning & Co. Messrs.	2	2	0	Lowndes, R. Esq. ....	1	1	0
Brocklehurst, S. Esq. .	1	1	0	Gunson, Brown & Co. Messrs. ....	1	1	0	Lunt, W. J. Esq. ....	-	10	6
Bromham, W. Esq. .	1	1	0	Haberhorn, E. Esq. .	1	1	0	McDiarmid, J. Esq. .	1	1	0
Browne, A. F. Esq. .	-	10	0	Hamilton, John L. C. Esq. ....	1	1	0	McKibbin, A. Esq., the late. ....	1	0	0
Bulley, S. M. & Sons, Messrs. ....	1	1	0	Hannay, J. M. Esq. .	1	1	0	Macfie and Sons, Messrs. ....	2	2	0
Bulley, S. M., Jun., Esq. ....	1	1	0	Harding, Thos. Esq. .	2	2	0	Macgregor, A. Esq. .	1	1	0
Butterworth, Miss J. .	1	1	0	Hargreaves, Jno. Esq. .	2	2	0	Macgregor, Alex. Esq.	2	2	0
Calvert, Capt. ....	1	1	0	Harris, G. Esq. ....	-	10	6	Macintyre, L. H. & Co. Messrs. ....	1	1	0
Carson, Wm. Esq. .	1	0	0	Harrison, E. H. Esq. .	1	1	0	MacIver, D. Esq. ....	1	1	0
Carter, Tyrer, and Parker, Messrs. ...	1	1	0	Harrison, Gilbert and Bros. Messrs. ....	1	1	0	Macrae, G. G. Esq. .	2	2	0
Carter, Wm. Esq. ....	1	1	0	Harrison, T. and Co. Messrs. ....	1	1	0	Maddock, F. T. Esq. .	1	1	0
Chadburn, W. Esq. .	1	1	0	Hay, John, Esq. ....	1	1	0	Maddock, Mrs. ....	-	10	6
Chamberlain, G. Esq. .	1	1	0	Healey, S. R. Esq. .	2	2	0	Maples, A. Esq. ....	1	1	0
Chambres, Major Wm., J.P. ....	2	2	0	Henderson, Capt. H. .	1	1	0	Marriott, Wm. Esq. .	1	1	0
Coltart, R. Esq. ....	1	1	0	Henderson, W. G. Esq. ....	1	1	0	Marshall, W. B. Esq. .	1	1	0
Comber, Thos. Esq. .	1	1	0	Herschell, A. and M. Messrs. ....	1	1	0	Martin, Jas. T. Esq. .	-	10	6
Comberbach, W. S. Esq. ....	-	10	0	Heywood Sons and Co. Messrs. A. ....	1	1	0	Mason, E. G. Esq. ....	-	10	6
Cope, Bros. and Co. Messrs. ....	1	1	0	Higginbottom, Miss E. A. ....	1	1	0	Masse, Fredk. Esq. .	1	1	0
Corf, N. Esq., the late Cotesworth, Lyne and Co. Messrs. ...	1	1	0	Higgins, Wm. Esq. .	1	1	0	Mellor, J. H. Esq. .	1	1	0
Cotesworth, Mrs., the late. ....	1	1	0	Hind, Miss A. ....	-	5	0	Meyer, F. A. Esq. .	1	1	0
Coubrough, H. Esq. .	1	1	0	Holder, Thomas, Esq. .	1	1	0	Minoprio, Chas. Esq. .	2	2	0
Coulbourne, E. W. Esq.	1	1	0	Holland, Mrs. ....	2	0	0	Molyneux, Capt. A.M.	1	0	0
Coulbourne, Wm. Esq.	1	1	0	Hollinshead, Miss .	1	0	0	Montague, Mrs. ....	1	1	0
Cox, G. R. Esq. ....	2	2	0	Holt, G. A. Esq. ....	1	1	0	Moore, Dr. ....	1	1	0
Cox, Henry, Esq. ....	1	1	0	Hope, S. T. Esq. ....	1	1	0	Moss, Thomas Esq. .	1	1	0
Cox, James, Esq. ....	2	2	0	Hope, William, Esq. .	1	1	0	Moss, Rev. J. Miles .	1	1	0
Crellin, H. Esq. ....	-	10	0	Hornby, H. B. Esq. .	-	10	0	Mounsey, E. Esq. .	1	1	0
Crosbie, C. E. Esq. .	1	1	0	Hornby, Rev. Thos. .	1	1	0	Muspratt, E. K. Esq. .	1	1	0
Crosby, R. Esq. ....	-	10	6	Houghton, E. P. Esq. .	-	10	0	National S.S. Co. Limited Messrs. .	1	1	0
Cunningham, H. Esq. .	1	1	0	Houghton, Jno. Esq. .	1	1	0	Newgass, B. Esq. ....	1	0	0
Currey, Major Henry .	1	1	0	Houghton, Miss E. .	1	0	0	North, Fred. Esq. ....	1	1	0
Currey, John, Esq. .	1	1	0	Houghton, Miss Jane .	1	0	0	Pappacolo, D. Esq. .	1	1	0
Davies, E. & Co. Messrs. ....	1	1	0	Hutchinson, Miss. .	-	10	0	Papayanni and Co. Messrs. ....	2	2	0
Davies, W. R. Dr. ...	1	1	0	Hutchinson, W. H. Esq. ....	-	10	6	Parker, A. T. Esq. .	1	1	0

Table with columns £, s, d. listing names and amounts such as Travis and Wilde, Messrs., Turner, Alfred, Esq., etc.

LYTHAM BRANCH.

Table with columns £, s, d. listing names and amounts for Lytham Branch including John Talbot Clifton, Esq., and others.

Donations.

Table with columns £, s, d. listing donation amounts and names for Lytham Branch.

MANCHESTER BRANCH.

Table with columns £, s, d. listing names and amounts for Manchester Branch including Robert Whitworth, Esq.

Table with columns £, s, d. listing names and amounts such as Brown, Miss M. F., Drury, Captain, etc.

Table with columns £, s, d. listing names and amounts such as Briggs, Thos., British and Foreign Marine Insurance, etc.

Table with columns £, s, d. listing names and amounts such as Luke, Jas., M'Keand, Mrs. Jos., etc.

## BRANCHES—LIST OF ANNUAL SUBSCRIPTIONS AND DONATIONS. 345

	£.	s.	d.
Wedemeyer, R. ....	1	1	0
Whalley, Thos. & Co. ....	1	1	0
Whitworth, Edmund ....	1	1	0
Windsor, Councillor. ....	10	6	
Worthington and Son. ....	10	0	
Wright and Shaw. ....	1	1	0
Wrigley, G. N. ....	1	1	0
Wympory, Miss. ....	5	0	
Ziegler, Ph. and Co.. . .	1	1	0
Total .....	261	2	10

## Donations and Legacies.

Consterdine, Master, Collected by (Al- derley) .....	2	5	10
Coupland Street Presbyterian Sun- day School .....	1	4	0
Scotch Church Sunday Sch. (Bloomsbury) ..	0	0	
Heywood, Oliver, J.P. (for " City of Manchester " Life- boat) .....	30	0	0
Ditto .....	10	0	0
Leedham, F. H. Coll. Box .....	5	0	
Lower Mosley Street Sunday School .....	1	10	0
St. Thomas's Sunday School, Ardwick. . .	2	1	2
Storey, R. Executors of the late .....	90	0	0
Townend, Mrs., for Life-boat at Salt- burn-on-Sea .....	1000	0	0
Whalley Range, Young Friends. . .	12	0	
Legacy under will of the late Miss Lup- ton .....	103	16	0
Total Dons., &c. ....	1242	14	0
Total Subs. ....	261	2	10
£1503 16 10			

## PIEL BRANCH.

President—  
His Grace the DUKE OF  
DEVONSHIRE, K.G.

Honorary Secretary—  
CAPTAIN STOKES.

## Annual Subscriptions.

Duke of Devonshire. . .	2	0	0
Ashburner, T. ....	10	6	
Barrow Steam Nav. Co. ....	2	2	0
Fowle, J. F. ....	10	6	
Gradwell, W. ....	1	0	0
Hodgson & Sons. . .	1	1	0
Little, James & Co. .	2	2	0
Schutz, G. H. ....	10	6	
Smith, J. T. ....	1	1	0
Strongtharme, A. H. .	1	1	0
Wadhams, E. ....	5	0	
Westray, Copeland, and Co. ....	10	6	
Worrall, F. ....	10	6	
Total .....	17	19	6

## Donations.

Amateur Dramatic Club, Barrow .....	30	0	0
Capt. Donnan. ....	10	0	0
Capt. Morrison. ....	10	0	0
Crew of <i>Armagh</i> ..	1	0	6
Ditto <i>Tyrone</i> .....	1	3	0

	£.	s.	d.
Crew of <i>Roe</i> .....	7	0	
Ditto <i>Herald</i> .....	19	0	
Life-boat Boxes .....	2	14	6
Total Dons. ....	37	4	0
Total Subs. ....	17	19	6
£553 3 6			

## ROCHDALE BRANCH

Honorary Secretary—  
ROBT. TAYLOR HEAPE, Esq.

## Annual Subscriptions.

Ashworth, Wm. Esq. . .	1	1	0
Ashworth, Miss. ....	1	1	0
Barlow, Edwd. Esq. . .	1	1	0
Barrett, Joseph, Esq. .	1	1	0
Brierley, Abm. Esq. . .	1	1	0
Brierley, Arthur, Esq. .	1	1	0
Brierley, James, Esq. .	1	1	0
Bright, J. A. Esq. ....	1	1	0
Bright, Thomas, Esq. .	1	1	0
Butterworth, R. L. Esq. ....	1	1	0
Chadwick, G. T. Esq. . .	1	1	0
Chadwick, H. Esq. ....	1	1	0
Clegg, E. A. Esq. ....	1	1	0
Colley, Frank, Esq. . .	1	1	0
Coupe, Mrs. ....	1	1	0
Crowther, F. Esq. ....	1	1	0
Dearden, J. G. Esq. . .	1	1	0
Davenport, J. M. Esq. .	1	1	0
Dimmock, Jas. Esq. . .	1	1	0
Entwistle, John, Esq. .	1	1	0
Heape, R. T. Esq. ....	1	1	0
Heape, R. T. Jun. Esq. ....	1	1	0
Heap, James, Esq. ....	1	1	0
Heap, Joshua, Esq. . .	1	1	0
Haigh, J. W. Esq. ....	1	1	0
Hegubottom, Mrs. ....	1	1	0
Holt, W. C. Esq. ....	10	6	
Hurst, R. Esq. ....	1	1	0
Hurst, Wm. Esq. ....	1	1	0
Hoyle, Mrs. James. . .	10	6	
Jackson, R. Esq. ....	1	1	0
Jewison, R. Esq. ....	1	1	0
Kay, E. G. Esq. ....	1	1	0
Kay, Miss .....	1	1	0
Kay, Mrs. ....	1	1	0
Kemp, Mrs. ....	2	2	0
King, Mrs. ....	10	6	
King, W. H. Esq. ....	10	6	
Lancashire, J. H. Esq. .	1	1	0
Leach, John, Esq. ....	1	1	0
Leach, Robert, Esq. . .	1	1	0
Leach, Robert, Esq. . .	10	0	
Littlewood, J. S. Esq. .	1	1	0
Lord, James, Esq. ....	1	1	0
Lord, T. K. Esq. ....	1	1	0
Moore, J. E. Esq. ....	1	1	0
Newall, H. Esq. ....	1	1	0
Openshaw, J. H. Esq. .	1	1	0
Ormerod, Wm. Esq. . .	1	1	0
Petrie, George, Esq. . .	1	1	0
Petrie, John, Esq. ....	1	1	0
Petrie, J. E. Esq. ....	1	1	0
Petrie, Mrs. James. . .	1	1	0
Phillippi, F. T. Esq. . .	1	1	0
Pilling, Edwin, Esq. . .	1	1	0
Pilling, John, Esq. . .	1	1	0
Radcliffe, James, Esq. .	1	1	0
Robinson, J. Esq. ....	1	1	0
Robinson, P. H. Esq. .	1	1	0
Robinson, R. Esq. ....	1	1	0
Robinson, S. Esq. ....	1	1	0
Rochdale Equitable Pioneers' Society. . .	1	1	0
Royds, A. H. Esq. ....	1	1	0
Royds, C. M. Esq. ....	1	1	0
Royds, E. A. N. Esq. .	1	1	0
Royds, E. E. M. Esq. .	1	1	0
Schofield, Captain. . .	1	1	0
Schofield, G. W. Esq. .	1	1	0
Schofield, Mrs. Jos. . .	1	1	0
Schofield, R. Esq. ....	1	1	0

	£.	s.	d.
Shaw, W. Esq. ....	1	1	0
Shawcross, L. Esq. ....	1	1	0
Shepherd, J. Esq. ....	1	1	0
Smithson, T. Esq. ....	1	1	0
Standing, J. Esq. ....	1	1	0
Stott, William, Esq. . .	1	1	0
Tatham, John, Esq. . .	1	1	0
Watson, Thos. Esq. . .	1	1	0
Whittaker, Chas. Esq. .	1	1	0
Whittaker, Geo. Esq. . .	1	1	0
Williams, T. B. Esq. . .	1	1	0
Wood, John, Esq. ....	1	1	0
Wood, Joseph, Esq. . .	1	1	0
Total .....	853	11	0

## SOUTHPORT BRANCH.

President—  
The Rt. Hon. EARL LATHOM.

Chairman—  
SAML. BOOTHROYD, Esq. J.P.

Honorary Secretary—  
J. A. ROBINSON, Esq.

## Annual Subscriptions.

Acton, Mrs. ....	1	1	0
Atkinson, John, Esq. . .	1	1	0
Atkinson, Wm. Esq. . .	1	1	0
Barton, Admiral, the late .....	1	1	0
Bellhouse, W. Esq. . .	1	1	0
Boothroyd, Samuel, Esq., J.P. ....	2	2	0
Bradbury, Mrs. ....	1	1	0
Brittain, Wm. S. Esq. . .	2	2	0
Bromilow, Mrs. ....	1	1	0
Buckley, R. Esq. ....	5	0	0
Buckley, Mrs. ....	1	1	0
Chadwick, Wm. ....	10	0	
Cheetham, B. Esq. ....	1	1	0
Clarke, Rev. B.S.D.D. . .	10	6	
Cornwell, Dr. John . .	10	6	
Cross, Rev. T. H. ....	5	0	
Darwell, Mrs. ....	10	6	
Farnley, Wm. Esq. . .	1	1	0
Fletcher, Edwin, Esq. .	1	1	0
Forshaw, Mrs. ....	1	1	0
Garton, Miss .....	1	1	0
Geddes, Miss .....	1	1	0
Glover, Isaac, Esq. . .	10	6	
Glover, James, Esq. . .	1	1	0
Gregory, H. L. Esq. . .	1	1	0
Halliday, Misses. ....	1	1	0
Heap, Robert, Esq. ....	1	1	0
Heaton, Miss .....	1	1	0
Hesketh, Capt. ....	1	1	0
Irving, J. C. Esq. ....	1	1	0
Johnson, John, Esq. . .	10	6	
Knowles, Mrs. ....	1	1	0
Knowles, Miss .....	1	1	0
Lancashire and York- shire Railway Co. . .	3	3	0
Lathom, The Earl . . .	5	5	0
Lees, Mrs. S. ....	1	1	0
Litton Wm, Esq. ....	1	1	0
Macrae, Misses. ....	1	1	0
Mason, Henry, Esq. . .	1	1	0
Mathwin, Henry, Esq., B.A. ....	1	1	0
Mawdsley, Mrs. ....	1	1	0
Mocatta, E. Esq. ....	1	1	0
Mottram, J. Esq. ....	1	1	0
Nicholson, R. Esq. . .	1	1	0
Sharpe, Misses. ....	10	6	
Smith, W. Esq. ....	1	1	0
Stead, J. F. Esq. ....	1	1	0
Storey, Mrs. ....	1	1	0
Swire, S. Esq. ....	1	1	0
Sutcliffe, Rev. T. ....	1	1	0
West, Mrs. ....	1	1	0
Wood, James, Esq. . .	1	1	0
Wood, P. F., Esq. ....	1	1	0
Total .....	63	10	0

	£.	s.	d.
Geldert, Mrs. Chas. (1890) .....	5	0	0
Pillar and Boat- House Boxes.....	6	11	8
Total Dons. ....	11	11	8
Total Subs. ....	63	10	0
£75 1 8			

## Leicestershire.

## LEICESTER BRANCH.

Chairman—  
W. H. WALKER, Esq.

Treasurer—  
T. T. PAGET, Esq., M.P.

Honorary Secretaries—  
WILLIAM GREEN, Esq.  
FRANK HODGES, Esq.

## Annual Subscriptions.

	£.	s.	d.
Allen, Mr. Joseph. . .	5	0	
Atkins Bros. Messrs. . .	5	0	
Baines, Messrs. Geo. and Sons .....	10	6	
Baines, John & Sons, Messrs. ....	10	6	
Barrs, Mr. J. H. ....	5	0	
Bellairs, Major. ....	5	0	
Blunt, Dr. ....	10	6	
Bowman, Mr. W. C. . .	1	1	0
Brookhouse, Miss. . .	5	0	
Brown, Jno. & Sons, Messrs. ....	5	0	
Burfield, Rev. Canon . .	5	0	
Burgess, Mr. A. ....	1	1	0
Burgess, Mr. A. H. . .	5	0	
Burgess, Mr. Josh. . .	1	1	0
Burnaby, Maj.-Gen. M.P. ....	5	0	
Burnaby, Mrs. ....	5	0	
Burnaby, Mr. A. E. . .	5	0	
Burnaby, Miss H. L. . .	5	0	
Charlesworth, Mr. T. G. ....	5	0	
Church, Mr. W. H. ....	10	6	
Clarke, Mrs. J. C. . .	1	1	0
Clephan, Mr. E. ....	10	6	
Coltman, Mr. T. ....	5	0	
Cook, Mrs. John, London .....	1	1	0
Corah, Messrs. N., Sons and Cooper. . .	10	6	
Cort & Paul, Messrs. . .	10	6	
Colls, Mrs. Thomas (Edgoston) .....	1	1	0
Crow, Mr. J. ....	5	0	
Davis, Mr. S. (Hinckley) .....	10	6	
Dicks, Mr. Wm. ....	10	6	
Ellis, Mrs. A. ....	10	6	
Ellis, Mrs. E. S. ....	1	1	0
Ellis, Mr. G. H. ....	1	1	0
Ellis and Everard, Messrs. ....	10	6	
Else, Mr. A. ....	10	6	
Everard, Mr. W. ....	5	0	
France, Mr. E. ....	5	0	
Gilson, Mr. H. T. . .	1	1	0
Gimson, Mrs. Josiah . .	10	6	
Goddard, Mr. J. W. . .	5	0	
Goddard, Mr. Josh. . .	10	6	
Goodchild, Mrs. (Ro- therby) .....	1	1	0
Goodchild, Mstr. T. P. (Rotherby) .....	5	0	

Table with columns £, s, d. containing names and amounts such as Green, Mr. W., Green, Messrs. John and Co., Hall, Mr. J., etc.

Donations.

Table with columns £, s, d. for donations including Library, Collected at Pillar, Collected in Box at Rutland House, etc.

Total.....£73 14 5

Lincolnshire.

LINCOLNSHIRE SHIPWRECK ASSOCIATION BRANCH.

Treasurer— WILLIAM GARFIT, Esq. Joint Honorary Secretaries— Rev. R. W. CRACROFT and Rev. E. RAWNSLEY.

Annual Subscriptions.

Table with columns £, s, d. listing annual subscribers for the Lincolnshire branch, including Ainslie, Rev. Robert, Alington, Rev. John, etc.

Table with columns £, s, d. listing subscribers for the Louth branch, including Massingberd, C. L., Massingberd, Rev. W. O., Monson, Lord, etc.

LOUTH BRANCH.

Table with columns £, s, d. listing subscribers for the Louth branch, including Allison, T. F., Allison, Wm., Bell, Dr., etc.

Table with columns £, s, d. listing subscribers for the Boston branch, including Nell, Mr., Parker, Mr. J., Sharpley, T. Esq., etc.

BOSTON BRANCH.

J. H. GARFIT, Esq., Steward.

Table with columns £, s, d. listing subscribers for the Boston branch, including Allen, Mr. Thompson, Allen, John, and Co., Bailes, W. H., etc.

	£.	s.	d.
Skinner, Charles, and Son .....	10	6	
Stator, Thos. & Son ..	10	6	
Small, J. H. & Son ..	10	6	
Smith, Captain .....	1	0	0
Stainton, W. Esq. ....	10	6	
Stanford, Spalding, and Boston Banking Company .....	5	5	0
Staniland, R. W. Esq. .	1	1	0
Stanwell, F. Esq. ....	1	1	0
Storr, Mrs. ....	10	6	
Swain, C. F. Esq. ....	10	6	
Swain, R. H. Esq. ....	10	6	
Thomas, J. H. & Son ..	1	0	0
Thomas, G. W. Esq. .	1	1	0
Thompson, Mr. John ..	5	0	0
Thorns, Son & Mawson ..	1	0	0
Thorpe, Mr. T. W. ....	10	6	
Tunnard, Mrs. ....	1	1	0
Tunnard, C. T. Esq. .	1	0	0
Tuxford, J. E. Esq. .			
M.D. ....	1	1	0
Walker, The Misses. .	1	0	0
Ward, Mr. John .....	10	6	
West, John, Esq. ....	1	1	0
Wiglesworth, P. Esq. .	10	6	
Wise, George, Esq. ....	10	6	
Wood, Mr. W. H. ....	10	6	
Wright, C. T. & H. T. .	1	1	0
Yeatman, C. Esq. ....	1	1	0
Wren, J. Esq. ....	1	1	0
<b>Total .....</b>	<b>£61</b>	<b>5</b>	<b>6</b>

**CLEETHORPES BRANCH.**

Patroness—  
The Countess of YARBOROUGH.

Chairman—  
A. W. T. GRANT-THOROLD, Esq.

Honorary Secretary—  
F. C. DAWSON, Esq.

*Annual Subscriptions.*

Bannister, Mr. Ald., J.P. ....	1	1	0
Chapman, J. Esq. ....	1	1	0
Charlton, T. Esq. ....	1	1	0
Grant-Thorold, A. W. T. Esq. J.P. ....	2	2	0
Heneage, E. Esq., M.P. .	1	1	0
Jones, Rev. W. P. ....	1	1	0
Josse, Henri, Esq. ....	1	1	0
Manchester, Sheffield, and Lincolnshire Railway Company	5	5	0
Marshall and Atkinson, Messrs. ....	1	1	0
Mason, R. Esq. ....	10	6	
Moody, Walker, Esq. ....	10	6	
Mudd, H. Esq. ....	10	6	
Oates, Thos. Esq. ....	1	1	0
Seddon, P. K. Esq. J.P.	2	2	0
<b>Total .....</b>	<b>19</b>	<b>7</b>	<b>6</b>

*Donations.*

Boxes—			
Victoria Hotel ...	8	0	
Levi Stephenson's Booth .....	6	10	0
Boathouse .....	1	0	2
Cleethorpes Station	5	6	
Huddersfield, S. S. ....	8	4	
Small sums, .....	1	3	1
<b>Total .....</b>	<b>£29</b>	<b>2</b>	<b>7</b>

**Merionethshire.**

**ABERDOVEY BRANCH.**

Chairman—  
J. WEAVER, Esq.

Honorary Secretary—  
Dr. F. H. V. GROSHOLZ.

*Annual Subscriptions.*

	£.	s.	d.
Coney, Major B. (the late), in memoriam	1	1	0
Corbett, J. Esq. M.P.	1	1	0
Griffiths, Rev. John, Rector of Merthyr	10	6	
Grosholz, Dr. ....	10	6	
Holland, S. Esq., M.P.	1	1	0
Hurt, Miss F. ....	10	6	
Jones, J. H. Esq. ....	10	6	
Morgan, Rev. D. Parker, Vicar	5	0	
Price, Capt. C. K. ....	10	6	
Thruston, C. F. Esq.	1	0	0
Sums under 5s. ....	1	17	0
<b>Total .....</b>	<b>8</b>	<b>15</b>	<b>6</b>

*Donations.*

C. E. B. ....	10	0	
Williams, Mrs. ....	5	0	
Wickham, P. Esq. ....	5	0	
<b>Total Dons. ....</b>	<b>1</b>	<b>0</b>	<b>0</b>
<b>Total Subs. ....</b>	<b>8</b>	<b>15</b>	<b>6</b>
<b>£9</b>	<b>15</b>	<b>6</b>	

**BARMOUTH BRANCH.**

Chairman—  
J. R. DAVIES, Esq.

Honorary Secretary—  
Mr. JOHN JENKINS, H.M.'s Customs.

*Annual Subscriptions.*

Jones, Rev. J. ....	10	0	
Jones, Wm. Esq. ....	1	1	0
Lloyd, Miss .....	1	0	0
Ricketts, Miss .....	1	1	0
Thomas, L. H. Esq. .	1	0	0
<b>Total .....</b>	<b>4</b>	<b>12</b>	<b>0</b>

*Donations.*

Barmouth Hotel Box	2	11	
Corsyedal Hotel Box	4	1	
Pillar Box .....	7	18	10
Rent of old Boat-house .....	2	0	0
<b>Total Dons. ....</b>	<b>10</b>	<b>5</b>	<b>10</b>
<b>Total Subs. ....</b>	<b>4</b>	<b>12</b>	<b>0</b>
<b>£14</b>	<b>17</b>	<b>10</b>	

**Norfolk.**

**NORFOLK BRANCH.**

Honorary Secretary—  
F. O. TAYLOR, Esq., Norwich.

*Annual Subscriptions.*

	£.	s.	d.
Albemarle, Rt. Hon. Earl of .....	1	0	0
Andrew, Rev. W. W.	1	1	0
Bagge, Richard, Esq.	2	2	0
Bailey, Rev. John ..	1	1	0
Barclay, J. G. Esq. .	2	2	0
Bayning, lady .....	4	4	0
Bennett, Edwd. Esq.	10	6	
Bensty, W. T. Esq. LL.D. ....	1	1	0
Bentnick, G. W. P. Esq., M.P. (2 yrs.)	4	4	0
Birkbeck, Hen. Esq.	2	0	0
Blake, Mrs. C. Jex. .	1	1	0
Blake, Henry, Esq. .	1	1	0
Brown, Mrs. Henry, Exors. of .....	1	1	0
Buxton, C. Louis, Esq.	1	0	0
Buxton, Geoffrey, Esq.	5	0	0
Carey, Joseph Henry, Esq. ....	2	0	0
Chamberlin, G. M. Esq. ....	1	1	0
Cholmondeley, The Marquis of .....	2	0	0
Cooper, Geo. H. Esq. .	1	1	0
Corbett, Admiral J.	1	0	0
Dairymple, Mrs. ....	1	1	0
Dolphin, Rev. John.	1	0	0
Dowson and Son, Messrs. ....	2	2	0
Edwards, Rev. B. .	1	1	0
Elwin, Hastings, Esq.	1	0	0
Fletcher, B. E. Esq.	1	1	0
Fountain, Miss .....	2	2	0
Fryer, W. G. Esq. .	1	1	0
George, Mr. T. W. .	5	0	0
Goulburn, Very Rev. E. M., D.D., Dean of Norwich	2	2	0
Gunton, Rev. J. ....	1	1	0
Gurdon, B. Esq. ....	2	2	0
Hamond, R. N. Esq.	1	0	0
Harmer, F. W. Esq. .	1	1	0
Harvard, S. Esq. ....	1	1	0
Heaviside, Rev. Canon	1	1	0
Hindes, Francis, Esq.	1	1	0
Holmes, Mrs. ....	1	1	0
Humphrey, R. Blake, Esq. ....	1	1	0
Irby, Mrs. Isabella H.	2	2	0
Jones, Sir W. Bart. .	2	2	0
Keppel, Rev. W. A. W.	1	1	0
Keppel, Hon. & Rev. E. S. ....	1	1	0
Lacon, Sir E. H. K. Bart. M.P. ....	1	1	0
L'Estrange, W. R. Esq. ....	1	0	0
Lothian, The Marchioness Constance	2	2	0
Lucas, George, Esq.	1	1	0
Lucas, Rev. R. G. .	1	0	0
Marsh, Rev. W. H. .	1	1	0
Marsham, Rev. H. P.	1	1	0
Matchett and Co. Messrs. ....	1	1	0
Mealing and Mills, Messrs. ....	1	1	0
Nevill, Rev. Canon .	1	1	0
Nisbet, Rev. Canon .	1	1	0
Norwich, the Hon. & Right Rev. the Bishop of .....	2	2	0
Nugent, Sir G. Bart.	2	0	0
Parimeter, R. W. Esq.	1	1	0
Preston, Isaac, Esq.	1	1	0
Preston, Miss Ellen .	2	0	0
Preston, Miss Sophia	2	0	0
Preston, Sir J. H., Bart. ....	2	0	0
Ripley, Rev. W. N. .	2	2	0
Springfield, G. O. Esq.	1	1	0
Stafford, Rt. Hon. the Lord .....	2	2	0
Steward, Patteson & Co. Messrs. ....	1	1	0
Taylor, F. O. Esq. Hon. Secretary	1	1	0
Taylor, J. O. H. Esq. ....	1	1	0
Thorn, C. Esq. ....	10	0	
Tillett, J. H. Esq. .	1	1	0
Trafford, E. W. Esq.	2	2	0
Tuck, C. E. ....	1	1	0
Upcher, H. R. Esq. .	2	2	0

	£.	s.	d.
Bentnick, G. W. P. Esq., M.P. (2 yrs.)	4	4	0
Birkbeck, Hen. Esq.	2	0	0
Blake, Mrs. C. Jex. .	1	1	0
Blake, Henry, Esq. .	1	1	0
Brown, Mrs. Henry, Exors. of .....	1	1	0
Buxton, C. Louis, Esq.	1	0	0
Buxton, Geoffrey, Esq.	5	0	0
Carey, Joseph Henry, Esq. ....	2	0	0
Chamberlin, G. M. Esq. ....	1	1	0
Cholmondeley, The Marquis of .....	2	0	0
Cooper, Geo. H. Esq. .	1	1	0
Corbett, Admiral J.	1	0	0
Dairymple, Mrs. ....	1	1	0
Dolphin, Rev. John.	1	0	0
Dowson and Son, Messrs. ....	2	2	0
Edwards, Rev. B. .	1	1	0
Elwin, Hastings, Esq.	1	0	0
Fletcher, B. E. Esq.	1	1	0
Fountain, Miss .....	2	2	0
Fryer, W. G. Esq. .	1	1	0
George, Mr. T. W. .	5	0	0
Goulburn, Very Rev. E. M., D.D., Dean of Norwich	2	2	0
Gunton, Rev. J. ....	1	1	0
Gurdon, B. Esq. ....	2	2	0
Hamond, R. N. Esq.	1	0	0
Harmer, F. W. Esq. .	1	1	0
Harvard, S. Esq. ....	1	1	0
Heaviside, Rev. Canon	1	1	0
Hindes, Francis, Esq.	1	1	0
Holmes, Mrs. ....	1	1	0
Humphrey, R. Blake, Esq. ....	1	1	0
Irby, Mrs. Isabella H.	2	2	0
Jones, Sir W. Bart. .	2	2	0
Keppel, Rev. W. A. W.	1	1	0
Keppel, Hon. & Rev. E. S. ....	1	1	0
Lacon, Sir E. H. K. Bart. M.P. ....	1	1	0
L'Estrange, W. R. Esq. ....	1	0	0
Lothian, The Marchioness Constance	2	2	0
Lucas, George, Esq.	1	1	0
Lucas, Rev. R. G. .	1	0	0
Marsh, Rev. W. H. .	1	1	0
Marsham, Rev. H. P.	1	1	0
Matchett and Co. Messrs. ....	1	1	0
Mealing and Mills, Messrs. ....	1	1	0
Nevill, Rev. Canon .	1	1	0
Nisbet, Rev. Canon .	1	1	0
Norwich, the Hon. & Right Rev. the Bishop of .....	2	2	0
Nugent, Sir G. Bart.	2	0	0
Parimeter, R. W. Esq.	1	1	0
Preston, Isaac, Esq.	1	1	0
Preston, Miss Ellen .	2	0	0
Preston, Miss Sophia	2	0	0
Preston, Sir J. H., Bart. ....	2	0	0
Ripley, Rev. W. N. .	2	2	0
Springfield, G. O. Esq.	1	1	0
Stafford, Rt. Hon. the Lord .....	2	2	0
Steward, Patteson & Co. Messrs. ....	1	1	0
Taylor, F. O. Esq. Hon. Secretary	1	1	0
Taylor, J. O. H. Esq. ....	1	1	0
Thorn, C. Esq. ....	10	0	
Tillett, J. H. Esq. .	1	1	0
Trafford, E. W. Esq.	2	2	0
Tuck, C. E. ....	1	1	0
Upcher, H. R. Esq. .	2	2	0

	£.	s.	d.
Watson, John Ferra, Esq. ....	1	1	0
Wild, Edward, Esq. .	1	0	0
Wodehouse, Mrs. C. .	2	0	0
<b>Total .....</b>	<b>113</b>	<b>14</b>	<b>0</b>

*Donations.*

Allen, George, Esq. .	1	1	0
Bircham, F. S. Esq. .	10	0	0
Brockdish Church Collection, per Churchwardens of	3	15	3
Bulwer, Lieut.-Col.	1	0	0
Buxton, S. Gurney, Esq. ....	5	0	0
Cubitt, Major .....	1	0	0
Hoblack, John, Esq.	1	0	0
Hosson, Mrs. ....	5	0	
I. L. W. ....	10	0	0
Taylor, Samuel, Esq.	10	0	0
Collected in box at Old bank Buildings	7	10	
<b>Total Dons. ....</b>	<b>14</b>	<b>19</b>	<b>1</b>
<b>Total Subs. ....</b>	<b>113</b>	<b>14</b>	<b>0</b>
<b>£128</b>	<b>13</b>	<b>1</b>	

**BACTON BRANCH.**

Honorary Secretary—

*Annual Subscriptions.*

Birkbeck, Edward, Esq., M.P. ....	5	5	0
Cubitt, W. ....	10	0	0
Forster, W. Esq. ....	1	0	0
Ives, George, Esq. .	1	0	0
Kimberley, Earl of	2	0	0
Mack, John, Esq. .			
Paston .....	1	0	0
Mack, Thos. Esq. ....	1	0	0
Read, C. S. Esq. M.P.	1	0	0
Read, J. H. Esq. .			
London .....	1	0	0
<b>Total .....</b>	<b>£13</b>	<b>15</b>	<b>0</b>

**BLAKENEY BRANCH.**

Treasurer and Honorary Secretary—  
Rev. R. H. TILLARD, M.A.

*Annual Subscriptions.*

Townshend, Marquis	2	0	0
Birkbeck, Edward, Esq., M.P. ....	5	5	0
Boulnois, E. Esq. ....	5	0	0
Brereton, Rev. R. B.	1	1	0
Brumell, Rev. E. ....	10	6	
Buck, W. Esq. ....	5	0	0
Burroughes, T. H. Esq.	5	0	0
Cooke, Mr. Robins .	1	0	0
Dowell, Rev. E. W. .	5	0	0
Fenwick, Rev. J. ....	10	0	0
Frere, R. T. Esq. ....	10	0	0
Hardy, W. H. C. Esq.	1	1	0
Hudson, George, Esq.	1	1	0
Jodrell, Mrs. ....	1	1	0
Marsham, Rev. T. ....	5	0	0
Page, M. F. Esq. ....	1	1	0
Pearson, J. W. Esq. .	10	0	0
Porritt, J. E. Esq. .	10	0	0
Purdy, W. Esq. ....	10	0	0
Tillard, Rev. R. H. .	1	1	0
<b>Total .....</b>	<b>£18</b>	<b>16</b>	<b>6</b>

BRANCASTER BRANCH.

President—The Earl of ORFORD. Chairman—SIMMS REEVE, Esq. Honorary Secretaries—Rev. E. K. KERSLAKE. E. DEWING, Esq.

Annual Subscriptions.

Table of annual subscriptions for Brancaster Branch, listing names and amounts in £ s. d. format.

CROMER BRANCH.

Chairman—Right Hon. LORD SUFFIELD. Honorary Secretary—MR. W. G. SANDFORD.

Annual Subscriptions.

Table of annual subscriptions for Cromer Branch, listing names and amounts in £ s. d. format.

HASBOROUGH BRANCH.

President—R. S. BAKER, Esq. Honorary Secretary—Rev. J. SLATER, M.A.

Annual Subscriptions.

Table of annual subscriptions for Hasborough Branch, listing names and amounts in £ s. d. format.

HUNSTANTON BRANCH.

President—H. LE STRANGE, Esq. Honorary Secretary—Rev. A. WALLER.

Annual Subscriptions.

Table of annual subscriptions for Hunstanton Branch, listing names and amounts in £ s. d. format.

Table listing donations for Hasborough Branch, including Whitmore, G. Esq., Whitty, Dr., etc.

Table listing boxes and other donations for Hasborough Branch.

KING'S LYNN BRANCH.

Treasurer—F. J. CRESSWELL, Esq. Honorary Secretary—MR. WILLIAM HITCHCOCK.

Annual Subscriptions.

Table of annual subscriptions for King's Lynn Branch, listing names and amounts in £ s. d. format.

Table listing donations for King's Lynn Branch, including Cresswell, F. J. Esq., Boat, Bank do., etc.

MUNDESLEY BRANCH.

Honorary Secretary—MR. G. GORDON.

Annual Subscriptions.

Table of annual subscriptions for Mundesley Branch, listing names and amounts in £ s. d. format.

Donations. Box at L. B. House - 8 4



**BRANCHES—LIST OF ANNUAL SUBSCRIPTIONS AND DONATIONS. 349**

**PALLING BRANCH.**

Honorary Secretary—  
Mr. E. FRENCH,  
Chief Officer of Coastguard.  
Annual Subscription.  
£. s. d.  
Birkbeck, Edward,  
Esq., M.P. .... 5 5 0

**SHERINGHAM BRANCH.**

Chairman—  
HENRY R. UCHER, Esq.  
Honorary Secretary—  
Rev. L. MOORE, M.A.  
Annual Subscriptions.  
Barclay, Gurney, Esq. 5 0 0  
Birkbeck, Edward  
Esq., M.P. .... 5 5 0  
Buxton, Sir Fowell 2 2 0  
Fraser, Mrs. .... 5 0 0  
Hoare, Joseph, Esq. 1 1 0  
Hoare, Samuel, Esq. 1 1 0  
Wilson, Rev. Roland 1 1 0  
  
£20 10 0

**WELLS BRANCH.**

Patron and President—  
The Right Hon.  
The EARL OF LEICESTER.  
Honorary Secretary—  
Rev. J. R. PILLING.  
Annual Subscriptions.  
Bellett, Lieut. E. T. .... 10 0 0  
Birkbeck, Edward,  
Esq., M.P. .... 5 5 0  
Bullard & Son. .... 2 2 0  
Bygott, —, Esq. .... 10 0 0  
Chad, J. Scott, Esq. 1 0 0  
Cripp, R. S. .... 1 0 0  
Dewing, Herbert Esq. .... 5 0 0  
Doggett, J. R. Esq. .... 10 0 0  
Dugmore, J. Esq. .... 1 1 0  
England, R. Esq., J.P. .... 10 0 0  
Everitt, G. Esq. .... 5 0 0  
Everitt, J. Esq. .... 5 0 0  
Foot, Dr. .... 10 0 0  
Gurney & Co. Messrs. 2 0 0  
Hudson, Wm. Esq. .... 5 0 0  
Jones, Rev. H. .... 1 0 0  
Lacon, Sir E. Bart. .... 3 0 0  
Leicester, Earl of. .... 5 0 0  
Loynes, E. B. .... 5 0 0  
Rump, Hugh R. Esq. 1 0 0  
Mack, J. .... 5 0 0  
Marriott, Messrs. J.  
and B. .... 1 1 0  
Middleton, C. Esq. .... 10 0 0  
Middleton, E. P. Esq. .... 10 0 0  
Rippling, W. Esq. .... 1 0 0  
Shellabear, S. Esq. .... 1 0 0  
Smith, Messrs. F. & G. 2 2 0  
Southgate, F. B. .... 5 0 0  
Wagner, H. Lee, Esq. 1 0 0  
Sums under 5s. .... 10 0

£34 6 0

**WINTERTON BRANCH.**

Honorary Secretary—  
Rev. W. GREEN, M.A.  
Annual Subscriptions.  
Birkbeck, Edward,  
Esq., M.P. .... 10 10 0  
Copeman, Mrs. .... 1 0 0  
Green, Rev. W. .... 1 1 0

£. s. d.  
Harden, Rev. H. W. .... 10 0 0  
Mrs. Hume. .... 2 2 0  
Lucas, Rev. Charles. 2 2 0  
Lucas, Rev. C. J. .... 1 1 0  
Rising, Robert, Esq. 1 0 0  
Waters, Wm. Esq. .... 10 0 0  
Total. .... £19 16 0

**GREAT YARMOUTH AND CAISTER BRANCH.**

Chairman—  
Wm. WORSHIP, Esq.  
Honorary Secretaries—  
Rev. E. G. H. MURRELL, M.A.  
Mr. JOHN PETTS.  
Annual Subscriptions.  
Aldred, C. C. Esq. .... 10 6 0  
Arnold Brothers,  
Messrs. .... 10 6 0  
Beeching Brothers. 2 2 0  
Biddlecomb and  
Bening, Messrs. .... 1 1 0  
Birkbeck, Edward,  
Esq., M.P. .... 5 5 0  
Bostock, J. Esq. .... 5 0 0  
Bracey, J. Esq. .... 10 6 0  
Bristow, S. B. Esq.,  
Q.C. .... 1 1 0  
Burroughs, T. Esq. 1 1 0  
Buxton, H. E. Esq. 1 0 0  
Carr, George, Esq. .... 10 0 0  
Chamberlain and Co.  
Messrs. .... 1 1 0  
Clowes, J. Esq. .... 1 1 0  
Clowes, J. E. Esq. .... 10 6 0  
Currie, D. A. Esq. .... 10 6 0  
Liver, O. Esq. .... 10 6 0  
Lugmore, Mrs. .... 2 2 0  
Fellows, J. H. Esq. .... 10 6 0  
Ferrier & Co. .... 10 6 0  
Goodman, E. N. P. .... 10 6 0  
Gurneys & Co. .... 2 2 0  
Lacon, Sir E., and  
Youell ..... 1 1 0  
Leach, John, Esq. .... 1 1 0  
Lee, John, Esq. .... 10 6 0  
Nightingale, S. Esq. 1 1 0  
Petts, John, Esq. .... 10 6 0  
Palgrave, R.H.I. Esq. 10 0 0  
Saul & Co. Messrs. J. 1 0 0  
Shales, Wm. Esq. .... 10 6 0  
Spingles, G. S. Esq. .... 10 6 0  
Steward, T. Burton .... 10 6 0  
Sutton, J. Esq. .... 10 6 0  
Taylor, J. Esq. .... 1 1 0  
Turner, Mrs. .... 10 0 0  
Venables, Rev. G. .... 10 6 0  
Walpole, R.H.V. Esq. 1 1 0  
Walpole, Mrs. R.H.V. 1 1 0  
Watling, R. S. Esq. 1 1 0  
Wild & Co. Messrs. .... 5 0 0  
Woolverton, C. Esq. .... 10 6 0  
Worship, W. Esq. .... 1 1 0  
Youell, Mrs. .... 10 6 0  
Total. .... 38 14 0

**Donations.**

Bend, J. .... 5 0 0  
Bowler, Mrs. F. E. 1 1 0  
Captain Thorp. Officers  
and Crew of  
Trinity steamer  
Beacon ..... 2 7 0  
Catholic Church, per  
Father T. Splain 2 10 0  
Calk, G. Esq. .... 5 0 0  
Cotton, T. Esq. and  
Mrs. .... 1 0 0  
Fowler, Mrs. T. .... 10 0 0  
Gooch, Miss. .... 1 0 0  
Kirkham, C. .... 10 0 0  
Mitchell, Miss. .... 5 0 0

£. s. d.  
Service at Hopto  
Church, per Rev.  
J. S. Muller .... 4 2 3  
Turrell and Torkild-  
sen, Messrs. .... 5 0 6  
Vaux, Rev. B. .... 10 0 0  
Wigg, T. Esq. .... 5 0 0  
Pier and Railway  
Pillar Boxes .... 3 1 1  
Boxes at Public  
Places ..... 6 12 3  
Do. Life-boat House 15 9 1  
  
Total Dons. .... 42 11 2  
Total Subs. .... 38 14 0  
  
£83 7 2

**Northamptonshire.**

**NORTHAMPTON BRANCH.**

Chairman—  
Rev. S. J. W. SANDERS, M.A.  
Treasurer—  
A. KEMPSON, Esq.  
Collector—  
Mr. E. LAW.  
Annual Subscriptions.  
£. s. d.  
Aris, Mr. Thos. .... 1 1 0  
Arney, Mr. Henry. .... 2 6 0  
Barnes, Mr. T. R. .... 10 6 0  
Barry, Mr. Jas. .... 1 0 0  
Becke, Mr. John. .... 10 0 0  
Blencowe, Mrs. C. .... 1 0 0  
Boemé, Mr. M. A. .... 5 0 0  
Bostock, Mr. F. .... 10 0 0  
Chandler, Mr. H. P. .... 10 0 0  
Grafton, Duke of. .... 1 0 0  
Hensman, Mr. H. P. .... 10 0 0  
Hesleden, Mr. B. .... 5 0 0  
Hill, Mr. Wm. .... 1 1 0  
Hollis, Mr. Wm. .... 2 6 0  
Jeffery, Mr. Wm. .... 10 0 0  
Kempson, Mr. A. .... 1 1 0  
Kennig, Mr. C. .... 1 1 0  
Law, Mr. E. F. .... 10 6 0  
Law, Mr. W. A. .... 5 0 0  
McKinnell, Mr. W. .... 5 0 0  
Osborn, Mr. Thos. .... 5 0 0  
Page, Mr. Alfred .... 5 0 0  
Perry, Mr. P. P. .... 5 0 0  
Phipps, Mr. John. .... 10 0 0  
Phipps, Mr. Pick. .... 1 0 0  
Phipps, Mr. Wm. .... 10 0 0  
Portal, Mr. W. T. .... 1 1 0  
Robinson, Mr. Jon. .... 10 0 0  
Rust, Mr. B. .... 10 0 0  
Sanders, Rev. S. J. W. 1 0 0  
Saul & Son, Messrs. .... 5 0 0  
Scriven, Mr. Thos. .... 5 0 0  
Sheffield, Mr. D. .... 10 6 0  
Shipman, Mr. L. .... 2 2 0  
Shipman, Mr. W. .... 1 1 0  
Shoosmith, Mr. W. .... 10 0 0  
Stanton, Mr. J. U. .... 5 0 0  
Tarry, Isaac .... 10 6 0  
Turner Bros, Messrs. .... 10 0 0  
Vernon, Mr. J. M. .... 5 0 0  
Walker, Mr. W. .... 10 6 0  
Ward, Mr. H. W. .... 5 0 0  
Wilson, Mr. John .... 5 0 0  
Total ..... £25 0 6

**Northumberland.**

**ALNMOUTH BRANCH.**

Chairman—  
Rev. E. L. MARRETT, Vicar.  
Honorary Secretary—  
H. SMITH, Esq.  
Annual Subscriptions.  
£. s. d.  
Northumberland, The  
Duke of. .... 2 0 0  
Armstrong, Sir W. G.  
Kt. C.B. .... 1 1 0  
Blair, Mr. H. Hunter .... 5 0 0  
Browne, A. H. Esq. 1 0 0  
Browne, Major. .... 1 0 0  
Burrell, Bryan, Esq. .... 10 0 0  
Buston, R. Esq. .... 10 0 0  
Cadogan, C. H. Esq. .... 1 0 0  
Chrisp, L. C. Esq. .... 1 0 0  
Cooke, Miss. .... 10 0 0  
Crewe, Lord, Trusts, of 1 1 0  
Dickson, W. Esq. .... 1 1 0  
Graville, Lady C. .... 1 1 0  
Gray, John, Esq. .... 10 0 0  
Grey, Lt.-Col. Alfred 1 0 0  
Hindmarsh, W. T. Esq. 1 0 0  
Jones, Mrs. .... 10 0 0  
Lisle, Mrs. .... 1 0 0  
Marrett, Rev. E. L. 1 1 0  
Maule, Mr. .... 5 0 0  
Moore, Rev. David. .... 10 0 0  
Paynter, H. Esq. .... 5 0 0  
Pease, J. W. Esq. .... 2 2 0  
Percy, Earl. .... 1 0 0  
Purvis, Mr. H. T. .... 10 0 0  
Richardson, Mr. G. .... 5 0 0  
Riddell, Sir W. B. Bt. 2 2 0  
Robertson, Mr. T. .... 5 0 0  
Ryle, Mrs. .... 10 0 0  
Shilbottle Colliery,  
Lessees of. .... 10 0 0  
Simpson, Mrs. Anne .... 10 0 0  
Smith, Henry. .... 1 0 0  
Stephenson, W. .... 5 0 0  
Strother, Wm. Esq. .... 5 0 0  
Tate, G. Esq. .... 10 0 0  
Tate, John, Esq. .... 10 0 0  
Tate, T. Esq. .... 10 0 0  
Thew, Arthur H. Esq. 10 0 0  
Wilkinson, Capt. J.F. .... 10 6 0  
  
Total ..... £29 14 6

**BERWICK BRANCH.**

Chairman—  
Rev. C. BALDWIN, Vicar.  
Honorary Secretary—  
B. G. SINCLAIR, Esq.  
Annual Subscriptions.  
Agent, Shipwrecked  
Mariners' Society. 1 1 6  
Allan Bros. Messrs. .... 5 0 0  
Allan, Thomas, Esq. .... 5 0 0  
Askew, Watson, Esq. 1 0 0  
Berwick Salmon  
Fisheries Company 1 0 0  
Bolam, R. G. Esq. .... 10 0 0  
Border Brewery Co. .... 10 6 0  
Cahill, Dr. F. .... 5 0 0  
Clay and Son. .... 5 0 0  
Crossman and Paulin 1 0 0  
Darling, Thomas, Esq. .... 5 0 0  
Dodds, R. Esq. .... 5 0 0  
Fleming, L. T. & J. .... 10 0 0  
Forbes, Capt. R.N. .... 1 1 0  
Forster, Capt. James 1 1 0  
Harbour Commissioners 2 2 0  
Henderson, G. & Son .... 10 0 0  
Innes, J. H. Esq. .... 10 6 0  
Johnston, Thos. Esq. 1 1 0  
Lowrey, A.R. Esq. J.P. .... 10 0 0

	£.	s.	d.
Norman, Capt. ....	10	0	0
Paxton and Purves ..	5	0	0
Purves, James D. Esq.	10	0	0
Richardson, Dr. R. N.	10	0	0
Riddell, Mrs. W. E. .	5	0	0
Robertson, A. Esq. J. F.	10	0	0
Rutter, Rev. Ewan . .	5	0	0
Sanderson, S. Esq. . .	10	0	0
Sinclair, B. G. Esq. . .	5	0	0
Thompson, A. Esq. . .	5	0	0
King, Rev. Mr. . . . .	5	0	0
Woods & Co. Bankers	1	10	0
Sums under 5s. . . . .	1	15	0
<b>Total</b> . . . . .	<b>20</b>	<b>13</b>	<b>6</b>

**Donations.**  
(1879.)  
Collecting - box at  
Custom House . . . 6 10 0  
Amateur Musical  
Entertainment . . . 2 0 0

Total Dons . . . . 8 10 0  
Total Subs . . . . . 20 13 6

£29 3 6

**BLYTH BRANCH.**

Chairman—  
JOHN DENT, Esq.

Honorary Secretary—  
MR. JAMES DARLING.

**Donations.**

Arkless, Bell, & Co. .	10	0	0
Cole, John . . . . .	5	0	0
Darling, James . . . .	10	0	0
Dawson, George R. . .	10	0	0
Dent & Co. . . . .	10	0	0
Dent, John . . . . .	10	0	0
Dixon, John . . . . .	5	0	0
Dromgoole, Rev. F. O. .	5	0	0
Eccles, Thomas . . . .	10	0	0
Gray, Robert, & Co. . .	10	0	0
Hedley, John . . . . .	1	0	0
Hodgson, Joseph . . . .	10	0	0
Hodgson, Richard . . . .	10	0	0
Keenlyside, Jacob . . .	5	0	0
Laws, John . . . . .	10	0	0
Lund, G. . . . .	5	0	0
McAlpine, John . . . .	5	0	0
Ridley, Sir M. W. Bt. .	5	0	0
Robinson, Edw. A. . . .	5	0	0
Robinson, William . . .	5	0	0
Saunders & Co. . . . .	10	0	0
Shyne & Son . . . . .	10	0	0
Smith, Thomas A. . . .	5	0	0
Smith, William R. . . .	10	0	0
Trustees Thoroton & Croft Estates, per William Gough . . . .	2	2	0
Ward, Dr. G. . . . .	10	0	0
Ward, William M. . . .	5	0	0
Whitehead & Son . . . .	5	0	0
Wood, James . . . . .	5	0	0
Sums under 5s. . . . .	5	8	0
<b>Total</b> . . . . .	<b>£23</b>	<b>10</b>	<b>6</b>

**BOULMER BRANCH.**

Chairman—  
JOHN CRASTER, Esq.

Honorary Secretary—  
REV. L. J. STEPHENS, M.A.

**Annual Subscriptions.**

Northumberland, The Duke of . . . . .	2	0	0
Browne, A. H. Esq. . . .	1	1	0
Grey, The Earl . . . . .	2	0	0
Grey, Sir G. Bart. M.P. . . . .	1	0	0
Tankerville, Earl of . .	1	0	0

	£.	s.	d.
Percy, Earl, M.P. . . . .	1	0	0
Allgood, Hunter, Esq. . . . .	10	0	0
Bosanquet, Rev. R.W. .	2	0	0
Brown, Rev. Dixon. . . .	1	0	0
Brown, Robert, Esq. . .	10	0	0
Burrell, Bryan, Esq. . .	10	0	0
Collinson, Mr. . . . .	10	0	0
Crafter, John, Esq. . . .	10	0	0
Dodds, Mr. . . . .	10	0	0
Grey, Mr. James. . . . .	10	0	0
Horstey, Mr. John. . . .	5	0	0
Lombard, Mrs. . . . .	3	0	0
Ronaldson, James T. Esq. . . . .	10	0	0
Sanderson, Mr. . . . .	5	0	0
Smith, Mr. Mark. . . . .	5	0	0
Streetfield, Rev. W.C. . .	10	0	0
Tate, John, Esq. . . . .	10	0	0
Thorpe, Mrs. . . . .	10	0	0
Yeaman, Mr. . . . .	5	0	0
<b>Total</b> . . . . .	<b>£20</b>	<b>14</b>	<b>0</b>

**GRESSWELL BRANCH.**

Chairman—  
REV. J. E. LEEPE, M.A.

Honorary Secretary—  
MR. JOHN ROBSON.

**Annual Subscriptions.**

Annett, Mr. J. . . . .	10	0	0
Baker-Cresswell, Maj. O. C. . . . .	5	0	0
Bell, Mr. Thos. . . . .	5	0	0
Bowman and Watt . . .	5	0	0
Bowman, Messrs. . . . .	10	0	0
Burrill, Messrs. . . . .	1	0	0
Chirney, Messrs. G. & J. . . . .	5	0	0
Cranston, Mr. Thos. Senior. . . . .	5	0	0
Cresswell, Francis, Esq. . . . .	1	0	0
Cresswell, Ann Crozier .	5	0	0
Hodson, Mr. Wm. . . . .	10	0	0
King, Mr. Thos. . . . .	5	0	0
Leefe, Rev. J. E. . . . .	1	0	0
Matheson, Mr. Thos. . .	5	0	0
Slater, Mrs. Jane. . . .	10	0	0
Stamp, Mr. Thos. . . . .	5	0	0
Watson, Messrs. . . . .	1	1	0
Small Sums. . . . .	9	6	0
<b>Total</b> . . . . .	<b>£13</b>	<b>10</b>	<b>6</b>

**HAUXLEY BRANCH.**

Chairman—  
S. F. WIDDINGTON, Esq.

Honorary Secretary—  
REV. A. O. MEDD.

**Annual Subscriptions.**

Northumberland, His Grace the Duke of . . . .	2	0	0
Atkinson, G. C. . . . .	1	0	0
Wilson, Esq. . . . .	1	0	0
Browne, General. . . . .	1	1	0
Carr, Rev. T. W. . . . .	1	1	0
Clutterbuck, T. Esq. . . .	1	1	0
Currie, Dr. . . . .	10	0	0
Dand, M. H. Esq. . . . .	1	1	0
Dand, Robert, Esq. . . . .	10	0	0
Dand, James, Esq. . . . .	10	0	0
Dand, Rev. J. J. . . . .	10	0	0
Dunn, Rev. J. W. . . . .	10	0	0
Forster, Col. . . . .	1	1	0
Ildeston, Rev. Thos. . . .	1	0	0
Maling, C. Esq. . . . .	1	1	0
Riddell, J. G. Esq. . . . .	1	0	0
Shotton, Jas. Esq. . . . .	10	0	0
Thomson, Rev. G. S. . . .	1	0	0
Warkworth Harbour, Commissioners of. . . . .	10	0	0

	£.	s.	d.
Widdington, S. F.	2	2	0
Esq. . . . .	2	2	0
Sums under 5s. . . . .	6	0	0
Box at Life-boat House	—	—	—
4 Young Ladies . . . . .	1	1	6
<b>Total</b> . . . . .	<b>£23</b>	<b>16</b>	<b>6</b>

**HOLY ISLAND BRANCH.**

Chairman—  
ROBERT CROSSMAN, Esq.

Honorary Secretary—  
REV. W. W. F. KEELING.

**Annual Subscriptions.**

Armstrong, Sir W. G. Bart. . . . .	1	1	0
Askew, Watson, Esq. . . .	1	1	0
Border Brewery Co. . . . .	10	0	0
Crew's, Lord, Trustee s. . . . .	2	2	0
Crossman, R. Esq. . . . .	2	2	0
Cruidas, W. D. Esq. . . .	1	1	0
Douglas, Mrs. . . . .	1	1	0
Grey, Grey, Jas. Esq. . . .	10	0	0
Ridley, Sir M. W., Bart. . . . .	1	0	0
Tankerville, Earl . . . . .	1	0	0
Waterford, Louisa, Marchioness of. . . . .	2	2	0
Wilson, Mrs. R. A. . . . .	10	0	0
<b>Total</b> . . . . .	<b>£14</b>	<b>1</b>	<b>6</b>

**NEWBIGGIN BRANCH.**

Chairman—  
J. C. REID, Esq. M.D.

Honorary Secretary—  
REV. E. SHORT, M.A.  
Woodhorn Vicarage.

**Annual Subscriptions.**

Dent, Mrs. Hedley . . . .	1	1	0
Edwards, Jas. Esq. . . . .	10	0	0
Foster, Robert, Esq. . . .	1	1	0
Hewitt, Mr. . . . .	5	0	0
Lawson, Rev. E. . . . .	1	1	0
Mitford, Col. . . . .	1	1	0
Nesham, T. C. Esq. M.D. . . . .	1	1	0
Northumberland, His Grace the Duke of . . . .	2	0	0
Parker, Thos. Esq. . . . .	1	1	0
Short, Rev. E. . . . .	1	1	0
Trevelyan, Miss. . . . .	1	1	0
Waddilove, Major . . . .	1	1	0
Watson, Hobb. Esq. . . . .	2	0	0
Concert in New- biggin School . . . . .	3	3	0
Sums under 5s. . . . .	2	6	0
<b>Total</b> . . . . .	<b>£17</b>	<b>9</b>	<b>6</b>

**NEWCASTLE, TYNE-MOUTH, & CULLERCOATS BRANCH.**

Vice-Patrons—  
RT. HON. EARL RAVENSWORTH.  
RIGHT HON LORD HASTINGS.  
W. B. BEAUMONT, Esq. M.P.

Treasurer—  
HUGH TAYLOR, Esq.

Hon. Sec. at Tynewmouth—  
P. J. MESSERT, Esq. C.E.

Hon. Sec. at Cullercoats—  
MAJOR WILLIAM ADAMSON.

**Annual Subscriptions.**

Northumberland, His Grace the Duke of . . . .	2	0	0
P. C. (Patron) . . . . .	2	0	0
Adam Brothers & Co. . .	5	0	0

	£.	s.	d.
Adamson, Wm. . . . .	10	6	0
Alexander, J. B. . . . .	10	6	0
Angus, George . . . . .	1	1	0
Annandale, James . . . .	5	0	0
Bainbridge, E. M. . . . .	1	1	0
Barras & Co. John . . . .	1	1	0
Bedington Coal Co. . . . .	2	0	0
Benson, W. . . . .	1	1	0
Bessler, Waechter & Co. .	1	0	0
Bilton, Williams & Co. . .	1	0	0
Borries, Craig, & Co . . .	10	6	0
Breyen, Richardson & Co. . . . .	5	0	0
Brown, Ralph . . . . .	2	2	0
Burnup, W. & C. . . . .	10	0	0
Carr and Co. . . . .	10	6	0
Carr, John, & Son . . . . .	10	6	0
Carver & Co. . . . .	10	6	0
Clapham, Henry . . . . .	10	6	0
Clayton & Armstrong . . .	10	6	0
Clayton, John . . . . .	1	1	0
Coppin, John, J.P. . . . .	1	1	0
Corporation of New- castle . . . . .	10	10	0
Crawhall & Son, J. . . . .	1	1	0
Cully, Edward . . . . .	5	0	0
Curry, Carrs, and Co. . .	6	0	0
Dees, R. R. . . . .	10	6	0
Diezinger and Co. . . . .	10	6	0
Dixon, S. & C.W & Co. . .	1	1	0
Elchholtz, R. & Sons . . .	10	6	0
Farly, Clark & Berkeley . . . . .	1	1	0
Fedden Brothers and Co. . . . .	1	6	0
Fenwick, George . . . . .	2	0	0
Forster, G. B. . . . .	1	1	0
Forster, James . . . . .	5	0	0
Foster, Blackett and Wilson . . . . .	10	6	0
Goddard, D. H. . . . .	1	1	0
Greene & Sons, John . . .	1	1	0
Haansbergen and Usher . . . . .	10	6	0
Haggie, Peter . . . . .	1	1	0
Hall, John & Co. . . . .	1	1	0
Harrison, A. P. . . . .	1	1	0
Hart, J. De . . . . .	1	1	0
Harton Coal Co. . . . .	1	1	0
Havelock, M. . . . .	10	0	0
Hawks, Crawshaw, & Co. . . . .	1	1	0
Hawthorn, R. & W. . . . .	1	1	0
Herring, John . . . . .	10	6	0
Hodgkin, Barnett & Co. . .	3	0	0
Holmes, Wm. Henry . . . .	1	1	0
Houen, A. C. and Co. . . .	10	6	0
Hume and Sons . . . . .	10	6	0
Hunter, William . . . . .	10	6	0
Ildeston, Miss . . . . .	5	0	0
Ingledeu, H. . . . .	10	6	0
Jarrow Chemical Co. . . .	2	2	0
Johnson, R. J. . . . .	10	6	0
Joicey, Jas. & Co. . . . .	2	2	0
Lamb, R. O. . . . .	1	1	0
Lambert, M. W. . . . .	10	6	0
Lambton & Co. Messrs. . .	5	0	0
Leideman and Co. . . . .	1	1	0
Liddell, John . . . . .	1	1	0
Locke, Blackett, & Co. . .	1	1	0
Maling, C. T. . . . .	1	1	0
McConnell, W. . . . .	10	6	0
Milling and Co. . . . .	10	6	0
Mitchell, C. and Co. . . .	2	2	0
Nelson, H. . . . .	5	0	0
Newcastle Branch of National Provincial Bank of England . . . .	3	3	0
Newcastle Chemical Co. . . . .	1	1	0
O'Hare, P. . . . .	5	0	0
Ormston, John . . . . .	2	2	0
Ormston, Robert . . . . .	2	2	0
Owners Pelaw Main Colliery . . . . .	2	2	0
Ors, Backworth Colly. . . .	1	1	0
Orwin, W. J. . . . .	5	0	0
Owen, W. . . . .	5	0	0
Palmer, C. M. . . . .	1	1	0
Pledge, Fred de . . . . .	10	0	0
Potter, Addison . . . . .	1	1	0
Potter, W. A. . . . .	1	1	0

BRANCHES—LIST OF ANNUAL SUBSCRIPTIONS AND DONATIONS. 351

	£.	s.	d.
Priestman, Jonathan	10	6	
Proctor, J. R.	10	6	
Pyman Bell & Co.	1	1	0
Ravensworth, Rt. Hon. Earl	2	0	0
Reid & Sons	10	6	
Richardson Brothers	10	0	
Ridley, Son, & Tully, John	10	6	
Rogerson, J. & Co.	1	1	0
Rowell, Robert	10	6	
Schlesinger, Davis & Co.	1	1	0
Scholefield, Henry, and Co.	10	6	
Sclater & Procter	10	6	
Scott Brothers	10	6	
Scott, J. J. & Green	10	6	
Smith, T. & W.	1	1	0
Sowerby, John G.	1	1	0
Spence, J. F.	10	6	
Spence, Joseph	10	6	
Spencer, J. & Sons	1	1	0
Steenberg, R. Swan and Co.	5	0	
Stephens & Mawson	5	0	
Stephens, W. D.	10	0	
Stephenson, R. & Co.	1	1	0
Stevens, Vermehren and Co.	1	1	0
Stokoe and Co.	10	6	
Strachan, H. & Co.	10	6	
Straker, John	1	1	0
Surtees and Co.	10	6	
Swanston, W. & Sons	1	1	0
Taylor, Hugh	1	1	0
Tully, Chas. and Co.	5	0	
Tyne Coal Company	10	6	
Tyne General Ferry Company	5	5	0
Usworth Colliery	2	2	0
Van der Werff & Co.	5	0	
Walker, Parker & Co.	2	2	0
Ward, Geo. Chas.	10	6	
Watson, S. O.	10	6	
West, R.	1	1	0
Wilkinson, W. B.	10	0	
Williamson and Co.	1	1	0
Woods and Co.	5	5	0
Woods, J. A.	1	1	0
Woods, M. C.	1	1	0
Woods, W. G.	10	6	
Total	142	6	0
<i>Donations.</i>			
Hawbensack, Geo.	2	5	0
Box at Central Station	18	9	
Do. at Cullercoats	2	6	
Do. on Pier	4	16	3
Do. at Boat Houses	4	6	
Do. at Turk's Head	8	8	
Total	£151	1	8

**NORTH SUNDERLAND BRANCH.**

Chairman—			
Rev. Wm. DARNELL			
Honorary Secretary—			
Capt. A. MARSHALL			
<i>Annual Subscriptions.</i>			
Lord Crewe's Trustees	30	0	0
Broadbent, L.G., M.P.	10	0	0
Colquhoun, Capt. in addition to present of a set of wheel and trace harness	10	0	0
Darnell, Rev. W.	10	0	0
Erwing, Mr. J.	1	0	0
Marshall, Anthony, Esq.	1	0	0
Orde, Rev. L. S.	1	0	0
Robson, Miss.	10	0	0
Sanderson, J. Burdon, Esq.	10	0	0

	£.	s.	d.
Sanderson, Mrs. J. B.	10	0	0
Simpson, Rev. F. R.	10	0	0
Taylor, Mr. John	10	6	
Taylor, Mrs.	1	1	0
Wilson, Mr. G.	10	0	0
Winchester, J.	10	0	0
Woodger, Mr. G. C.	2	2	0
Total	£41	3	6

**Nottinghamshire.**

<b>NEWARK BRANCH.</b>			
Honorary Secretary—			
Mr. E. T. SIMMONS.			
<i>Annual Subscriptions.</i>			
Allen, Miss. Castle Gate, col. by	1	12	0
Anderson, Mrs.	5	0	0
Atkins, Mr. T. F.	10	0	0
Burnaby	10	0	0
Bainbridge and Co. Messrs.	10	0	0
Bakewell, Mr. J.	10	0	0
Bayliffe, Mr. Robert	5	0	0
Bilson, Mrs. D., col. by	14	6	0
Branston, Mr.	10	0	0
Branston, Mrs. Sen.	1	1	0
Branston, Mr. J. G.	10	0	0
Burnaby, Mr. T. F.	10	0	0
Cearn, Mrs. Robert	10	0	0
Chest, Mr. George	10	0	0
Easterfield, Mr.	7	6	0
Egglestone, Mrs.	5	0	0
Falkner, Mr. E. S.	5	0	0
Foster, Mr.	5	0	0
Gilstrap, Mrs. Geo.	10	0	0
Gozd, Miss	10	0	0
Hall, Mrs. Henry	1	1	0
Harvey, Mr. John	5	0	0
Hildyard, Mr. T. B.	1	1	0
T. M.P.	1	1	0
Hodgkinson, Mrs. G.	10	0	0
Ironmonger, Miss	10	0	0
Job, Mr. Samuel	10	0	0
Lammin, Mr. Henry	10	0	0
Lawton, Miss	5	0	0
McGeorge, Mrs. J. P.	5	0	0
Newbald, Mr. Henry	5	0	0
Palmer, Mr. John	5	0	0
Parker, Mrs.	10	6	0
Plater, Rev. H.	10	0	0
Riddell, Mr. E. M. H.	1	1	0
Simmons, Mr. E. T.	5	0	0
Smith, Mr. J. E.	1	1	0
Simmons, Miss, col. by	9	0	0
Tallents, Mr. W. E.	10	0	0
Tallents, Mr. G.	10	0	0
Thorpe, Mr. James	10	0	0
Thorpe, Mr. John	10	0	0
Trent Brewery	10	0	0
Walton, Mr. Henry	5	0	0
West, Mr. D.	5	0	0
Wilson, Mrs., Balderton	1	0	0
Wright, Rev. J. B.	1	1	0
Sums under 5s.	10	0	0
<b>COLLINGHAM.</b>			
Woolley, Mr. T. S.	1	1	0
<b>SOUTHWELL.</b>			
Heathcote, Mrs.	10	6	
Total	£26	6	0

**NOTTINGHAM BRANCH.**

Chairman—			
WILLIAM VICKERS, Esq.			
Honorary Secretary—			
SAMUEL COLLINSON, Esq.			
<i>Annual Subscriptions.</i>			
Adams, Mr. John	10	6	
Adlington, W. D.	2	2	0
Armitage, S. F. Esq.	1	1	0
Birkin, Thomas, Esq.	1	1	0
Bradley, Mr. A.	1	1	0
Bradley, Mrs.	1	1	0
Braithwaite, Joseph, Esq.	1	1	0
Brown, Mr. George	1	1	0
Cowen, G. R. Esq.	10	6	
Edge, J. T. Esq.	1	1	0
Goater, Mr. A.	10	6	
Goldschmidt, E.	10	6	
Gripper, E.	1	1	0
Hardwick, G.	10	6	
Heymann, Mr. A.	1	1	0
Heymann, H. Esq.	1	1	0
Hodgson, Wm. Esq.	10	6	
Hogg, J. T.	10	6	
Hollins and Co. Messrs. W.	1	1	0
Hutchinson, Mr. Robert	1	0	0
Jacoby and Co.	1	1	0
Kirk, Henry	10	6	
Kulp & Son, Messrs.	1	1	0
Lewenz, Mr. F.	10	6	
Lottermir and Co. Messrs.	2	2	0
Miller, W. W.	10	6	
Parker and Booth	1	1	0
Rayner, Miss	1	1	0
Richards, Mr. W. A.	10	6	
Seely, Charles, Esq.	2	2	0
Jun.	2	2	0
Sully, E. Esq.	2	2	0
Vickers, Wm. Esq.	1	1	0
Walker, Messrs. J. and T.	1	1	0
Wells, Mr. A.	1	1	0
Whitlock, Mrs.	1	1	0
Wright, Dr. T.	1	1	0
Total	£36	3	0
<i>Donations.</i>			
Allsopp, W. G. Esq.	10	0	0
Amateur Christy	50	0	0
Minstreis	50	0	0
Armstrong, Mr. Jas.	5	0	0
Bradley, Mr. A.	5	0	0
Goodliffe, Mr. W. F.	1	1	0
Kenrick, Geo. Esq.	30	0	0
Ditto, second don.	50	0	0
Leavers, Miss	1	0	0
Sully, E. Esq.	10	0	0
Ditto, second don.	10	0	0
Collected by Miss Armstrong	6	6	
Total	£203	15	6

**Oxfordshire.**

<b>HENLEY-ON-THAMES BRANCH.</b>			
Chairman—			
C. LUCKY, Esq.			
Honorary Secretary—			
A. R. AWBERRY			
<i>Annual Subscriptions.</i>			
Barnett, Mrs.	10	0	0
Bennett, J., Esq.	10	6	
Brakspear, W. H. Esq.	1	1	0

	£.	s.	d.
Child, Miss	10	0	0
Elwes, Miss	1	1	0
Jackson, Mrs.	5	0	0
Lockey, Miss	10	6	
Lucey, C. Esq.	1	1	0
Melvin, Miss	5	0	0
Morgan, F. Esq.	1	1	0
Noble, J. Esq.	2	0	0
Pinckney, Rev. W. P.	1	1	0
Schwabe, G. C. Esq.	1	0	0
Scott, Mrs.	5	0	0
Boxes at the Catharine Wheel, Red Lion, Royal Hotel, Bell Inn, and the Library	1	9	6
Total	£12	10	6

**Pembrokeshire.**

**FISHGUARD BRANCH.**

Chairman—			
LEWIS MATHIAS, Esq.			
Honorary Secretary—			
Mr. WILLIAM VAUGHAN.			
<i>Annual Subscriptions.</i>			
Bowen, Capt. C.	5	0	0
Brettingham, C. Esq.	10	0	0
George, Capt. D.	1	0	0
Harriss, H. LL. Esq.	10	0	0
Johns, Rev. T.	10	0	0
Kensington, Lord, M.P.	2	0	0
Mathias, Lewis, Esq. (2 years)	2	0	0
Mathias, Mr. and Mrs. Jas.	10	0	0
Owens, John, Esq.	5	0	0
Owen, the Hon. Mrs. and Col.	1	0	0
Perkins, John, Esq.	10	0	0
Powell, G. E. J. Esq.	1	0	0
Plumtree, Rev. Mr.	5	0	0
Protheroe, Miss Schaw-Quilter, J. W.	5	0	0
Smith, F. Esq.	5	0	0
Smith, L. Esq.	5	0	0
Vaughan, Mr. W.	5	0	0
Sums under 5s.	5	0	0
Collecting Boxes	1	1	4
Total	£17	19	4

**MILFORD HAVEN BRANCH.**

Patron—			
The Right Hon. the EARL OF CAWDOR.			
President—			
Sir J. OWEN SCOURFIELD, Bt.			
Chairman—			
Admiral J. LOST STOKES.			
Honorary Secretary—			
H. PATTISON, Esq.			
<i>Annual Subscriptions.</i>			
Allen, H. G. Esq. Q.C. M.P.	1	1	0
Cawdor, Earl of	2	0	0
Davies, Wm. Esq.	1	1	0
Dawkins, W. Esq.	5	0	0
Evans, James Eaton, Esq.	5	0	0
Green & John, Messrs.	5	0	0
Greenish & Dawkins, Messrs.	5	0	0

Table with 3 columns: Name, £, s. d.
Griffith, Geo. Esq. 5 0
J.P. 1 0 0
Harries, George, Esq. 1 0 0
Rickestone 1 0 0
Jackson, S. Esq. 5 0
Jackson, T. T. Esq., D.L., J.P. 1 1 0
Lake & Co. 1 1 0
Lambton, Colonel 1 0 0
Lambton, Lady 1 0 0
McMaster, Thos. Esq. 5 0
Meyrick, T. C. Esq. 1 1 0
Mirehouse, R. W. B. Esq. 1 0 0
Morgan, Mrs. E. S. 10 0
Morgan, Miss Alice. 10 0
Parkin, Capt. R.N. 1 0 0
Roberts, W. R. Esq. 5 0
Roch, Nicholas, Esq. 1 0 0
Stokes, Admiral 1 0 0
Stokes, Colonel 10 0
Sanrin, M. A. Esq. 1 0 0
Shettle, John, Esq. 5 0
Smedley, Isaac, Esq. 5 0
Teasdale, J. H. Esq. 10 0
Toler, J. M. Esq. C.E. 5 0
Trayler, E. and A. Messrs. 5 0
Life-boat Boxes 5 0
Total 20 5 0

Table with 3 columns: Name, £, s. d.
Donations.
Scourfield, Sir Owen, Bart. 5 0 0
Sums under 5s. 2 7 3
Total 27 12 3

ST. DAVID'S AND SOLVA BRANCH.

Table with 3 columns: Name, £, s. d.
Patron—
Right Rev. Lord Bishop of ST. DAVID'S.
President—
Rev. Canon LEWIS.
Chairman—
JOHN WILLIAMS, Esq.
Vice-Chairman—
E. REES, Esq.
Honorary Secretary—
Capt. JOHN DAVIES.

Table with 3 columns: Name, £, s. d.
Annual Subscriptions.
Allen, Rev. Dean 1 1 0
Allen, Miss 1 1 0
Appley, Mr. W. 5 0
Arnold, Mr. W. 5 0
Bevan, Rev. Canon 1 1 0
Bickerstaff, Colonel 1 1 0
Bishop of St. David's 1 1 0
Cawdor, Earl. 2 2 0
Davies, J. Esq. 5 0
Davies, W. Esq. 1 1 0
Foley, F. Esq., M.D. 5 0
Griffiths, Capt. 5 0
Harries, Gilbert D. Esq. 10 6
Hicks, Capt. D. 5 0
Hicks, H. Esq., M.D. 10 0
Lewis, Rev. Canon 1 1 0
Lloyd, Capt. 5 0
Morgan, C. Esq. 10 6
Phillips, Rev. J. 10 0
Propert, Dr. 1 1 0
Rees, E. Esq. 10 0
Robinson, E. Esq. 10 0
Shipwrecked Mariners' Society, pr. C. Browne 2 9
Thomas, Miss 1 1 0
Tudor, Capt. 5 0
Williams, Mr. G. O. 5 0
Williams, J. Esq. 10 0
Williams, Mr. W. 5 0
Total 18 14 6

Table with 3 columns: Name, £, s. d.
Donations.
Bowen, J. B. Esq. 1 0 0
Croley, Mr. 5 0
Walker, Captain 5 0
Sums under 5s. 8 4
Total 20 13 1

TENBY BRANCH.

Table with 3 columns: Name, £, s. d.
President—
F. D. DYSTER, Esq., M.D.
Chairman—
C. ALLEN, Esq.
Treasurer and Hon. Sec.—
JOHN R. ROWLANDS, Esq.
Annual Subscriptions.
Allen, Charles, Esq. 1 0 0
Brook, Mrs. 5 0
Brooks, Misses 5 0
Brook, T. 5 0
Bull, Mrs. 5 0
Clatworthy, A. R. 5 0
Craddock, J. D. 5 0
Davies, H. 5 0
Dunn, N. J. Esq. 5 0
Dyster, Dr. 1 0 0
Evans, Capt. 5 0
Farmer, A. 5 0
Featherstone, Sir G. Bart. 5 0
Frith, W. P., R.A. 5 0
Gibson, T. 5 0
Graham, Mr. 5 0
Graham, Mr. D. 5 0
Gregory, Mr. Joseph 5 0
Harries, Miss 5 0
Hatchets, —, Esq. 5 0
Hawkesley, J. Esq. 10 0
Herbert, Rev. H. H. 5 0
Holmes, W. 10 0
Huntington, Rev. G. 5 0
Hutchinson, Lt.-Col. 5 0
Kentley, A. G. 10 0
K., W. E. C. 5 0
Lewes, Colonel 5 0
Lloyd, Howarth 5 0
Lock, Mrs. Wm 5 0
Mar and Kellie, Dowager Countess. 10 6
Morley and Sons 5 0
National Provincial Bank. 5 0
Owen, M. 5 0
Paget, F. 5 0
Paget, W. B. 1 1 0
Power, E. R. Esq. 10 0
Prothero, T. Esq. 5 0
Pryse, Sir Pryse 10 0
Rees, William, Esq. 5 0
Richards, W. H. Esq. 5 0
Smith, Mrs. C. H. 5 0
Spiller, Misses 5 0
Stevenson, J. P. 5 0
Stone, Mrs. C. 1 0 0
Summers, Wm. Esq. 5 0
Taylor, J. R. 5 0
Tucker, Miss. 5 0
Warner, E. H. 5 0
Warrick, W. H. 5 0
Waters, Miss. 5 0
Webb, A. H. Com. R.N. 5 0
Wells, Major 5 0
Whalley, Thos. 5 0
White, W. E. 5 0
Sums under 5s. 16 1 0
Total 30 7 6

Somersetshire.

BATH BRANCH.

Collector—
Mr. WATERMAN.

Table with 3 columns: Name, £, s. d.
Annual Subscriptions.
Bond, Rev. J. 5 0
Breton, Capt. R.N. 10 0
Broke, Miss. 1 0 0
Brooke, Lieut.-Gen. 5 0
Davies, Miss 5 0
Dobson, Mrs. B. 10 0
Dobson, W. Esq. 10 0
Doherty, General 5 0
Domager, Miss 5 0
Eden, General 1 1 0
Eden, Mrs. 5 0
Evans, Mrs. 5 0
Gilmore, Lt.-Col. 5 0
Gosselin, G. L. Esq. 5 0
Hare, Lt.-Col. 5 0
Hickes, C. R. Esq. 5 0
Holbourne, Miss. 5 0
Jones, Mrs. C. 10 0
Lawrence, Mrs. W. 5 0
Lean, G. S. Esq. 5 0
Little, Mrs. B. 1 0 0
Maurice, P. Esq. 5 0
Mundy, Major-Gen. 10 0
Orde, Miss 10 0
Paynter, Mrs. 10 0
Rogers, Miss. 5 0
Scott, Mrs. Fitzmaurice 10 0
Sheppard, Mrs. 5 0
Smith, Mrs. P. 5 0
Sprowle, Mrs. 5 0
Stanley, Mrs. 5 0
Thorn, Lady 5 0
Thornton, Mrs. 5 0
Warren, The Misses. 10 0
Whyngates, General 5 0
Sums under 5s. 5 0
Total 18 6 0

BRIDGWATER AND BURNHAM BRANCH.

Table with 3 columns: Name, £, s. d.
President—
The MAYOR OF BRIDGWATER.
Chairman—
J. B. THWAITES, Esq. J.P.
Honorary Secretary—
CUTHBERT RITSON, Esq.
Collector—
Mr. J. BAKER.
Annual Subscriptions.
Ash, W. Esq. 1 1 0
Bagehot, Edwd. Esq. 2 2 0
Brackenridge, Rev. W. 1 1 0
Clunie, R. C. Esq. 5 0
Corporation of Bridgwater 10 0 0
Denison, the Ven. Archdeacon 1 1 0
Drake, Rev. F. C. 1 0 0
Elton, Sir Arthur, Bt. 1 1 0
Estlin, J. P. Esq. 10 6
Harford, Mrs. 2 2 0
Harte, E. Esq. 5 0
Hervey, Lord Arthur C., Bishop of Bath and Wells 2 2 0
Hobbs, S. Esq. 5 0
Knyfton, T. F. Esq. J.P. 1 0 0
Luttrell, Colonel H. A. F., J.P. 1 0 0
Mapleton, Rev. W. H. 1 1 0
Munbee, Gen. G., J.P. 1 1 0
Paget, Major R. H. M.P. 1 0 0

Table with 3 columns: Name, £, s. d.
Ritson, C. Esq. J.P. 10 0
Spiller & Co. Messrs. 1 1 0
Stephenson, Rev. Prebendary 1 1 0
Thwaites, J. B. Esq. J. P. 10 0
Total 30 19 6

WATCHET BRANCH.

Table with 3 columns: Name, £, s. d.
Patrons—
Sir A. A. HOOD, Bart.
G. F. LUTHELL, Esq.
JOHN HALLIDAY, Esq.
Chairman—
The Rev. R. POOLE, Vicar of St. Decumans.
Honorary Secretary—
R. J. GIMBLETT, Esq.
Annual Subscriptions.
Alben, Mrs. St. 10 0
Blommart, J. Esq. 1 0 0
Clarke, Dr. 5 0
Collins, W. J. S. 10 0
Copp & Co. Messrs. 5 0
Crews, Miss. 5 0
Escott, Rev. H. Sibeeh 1 0 0
Gatchett, Jos. 5 0
Gatchett, Jos. 5 0
Gimblett, Capt. 10 0
Gimblett, Robt. Esq. 10 0
Gimblett, W. J. Junr. 5 0
Gimblett, Wm. Esq. 5 0
Halliday, Jno. Esq. 1 0 0
Hawkes, Thos. Esq. 10 0
Heathcote, Rev. S. J. 10 0
Herringham, Rev. W. W. 5 0
Hobson, Capt. R.N. 1 1 0
Hood, Sir A. A. Bt. 2 0 0
Horne, A. V. Esq. 10 0
James, Mr. 5 0
Luttrell, G. F. Esq. 2 0 0
Luttrell, Rev. A. F. 2 0 0
Luttrell, Mrs. A. H. F. 0 0
Martineau, J. P. Esq. 5 0
Norian Brewery 2 0 0
Notley, M. Esq. 1 0 0
Poole, Rev. R. 1 1 0
Robinson, Henry 10 0
Scmes, Mrs. 1 1 0
Stanley, E. J. Esq. 1 1 0
Stoate and Sons, Messrs. 1 0 0
Thorne and Son, Messrs. 10 0
Vernon, Rev. J. R. 5 0
Wansbrough and Brooke, Messrs. 2 2 0
White, W. H. Esq. 5 0
Williams, J. W. Esq. 5 0
Sums under 5s. 10 0
Total 33 6 0

Donations.

Table with 3 columns: Name, £, s. d.
Battershee, Esq. 1 1 0
Bland, Mrs. 5 0
Cunningham, Rev. A. 5 0
Herringham, Mrs. 5 0
Leatheren, Mrs. 5 0
Nichols, W. L. 5 0
Ollerhead, Mrs. 5 0
Ridler, Mrs. 5 0
Siderfin, John, Esq. 5 0
Wedlake, Mrs. 5 0
Sums under 5s. 2 0 0
Total Dons. 5 6 0
Total Subs. 33 6 0
£38 12 0

**WESTON-SUPER-MARE BRANCH.**

Honorary Secretary—  
— HILLIER, Esq.

Annual Subscriptions.

	£.	s.	d.
Armstrong, Mrs. L.	5	0	0
Ash, Wm.	10	0	0
Ash, Henry.	10	0	0
Atkins, Mrs.	5	0	0
Baker, S. E. Esq.	5	0	0
Battiscombe, Capt. A.	5	0	0
Blyth, E. H. Esq.	10	0	0
Bown, Miss.	5	0	0
Bowyer, W. J. Esq.	5	0	0
Buckle, Rev. G.	5	0	0
Cavan, Lord.	5	0	0
Charrington, Miss.	5	0	0
Coakson, Colonel.	5	0	0
Crawford, R. J.	1	0	0
Culley, R. S. Esq.	5	0	0
Davidson, General.	10	0	0
Drake, J. Esq.	10	0	0
Dunn, Misses.	5	0	0
Elphinstone, Mrs.	10	0	0
Girdlestone, Rev. C.	5	0	0
Granger, Miss.	5	0	0
Hall, Miss.	5	0	0
Harris, Mrs. Geo.	10	6	0
Hart, G. C. B.	5	0	0
Hawkes, Mrs.	5	0	0
Hazelwood, Mrs.	5	0	0
Hodgson, M. J.	5	0	0
Hunt, Rev. W.	5	0	0
Hyde, Misses.	5	0	0
Kirkpatrick, Rev. F.	5	0	0
McAdam, Miss.	5	0	0
Mansford, Miss.	7	0	0
Marshall, Miss.	10	0	0
Matheson, Mrs. H.	5	0	0
Moore, R.	5	0	0
Mullings, Mrs.	5	0	0
Murray, Mrs.	5	0	0
Paterson, A. H.	5	0	0
Peyton, Mrs.	5	0	0
Phillipson, R.	5	0	0
Phillott, R. Esq.	5	0	0
Pruen, Mrs. G. A.	5	0	0
Smith, Miss, Grey-stone.	5	0	0
Smith, Rev. T.	5	0	0
T. Miss, 3 Park Villas	5	0	0
Tulloch, Mrs.	5	0	0
Theobald, Surgeon-General.	5	0	0
Tomkins, Rev. H. G.	5	0	0
Tomkins, W. S.	5	0	0
Wilson, Miss.	5	0	0
Wood, Mrs.	5	0	0
Wootnam, Mrs.	5	0	0
Sums under 5s.	10	19	0
Total.	26	17	6

*Donations.*

St. John's Church. Collected after Sermon, by Rev. G. Buckle.	11	14	0
Trinity Church, Collected after Sermon, by Rev. W. Hunt	20	19	6
Collecting Box, by Mast. A. Crawford	5	8	

Total Dons.	32	19	2
Total Subs.	26	17	6
	£59	16	8

**Staffordshire.**

**BURTON-ON-TRENT BRANCH.**

President—  
M. A. BASS, Esq. M.P.

Treasurer and Hon. Sec.—  
MR. E. MADELEY.

Annual Subscriptions.

	£.	s.	d.
Abbotts, R. W.	1	1	0
Alsopp and Sons.	5	0	0
Bass and Co.	10	0	0
Bass, Abram	1	1	0
Brown, Edwin A.	10	6	0
Cartledge, E.	5	0	0
Deaville, S. R.	10	0	0
Douglas, G.W. & Co.	5	0	0
Drewry, J. & W. J.	1	1	0
Eadie, James.	1	1	0
Elliott, R. S.	1	1	0
Evans, William.	5	0	0
Evershed, Sydney.	1	1	0
Flint, Mrs.	10	6	0
Goodger, Henry.	10	6	0
Graham and Co.	5	0	0
Gretton, Misses.	1	1	0
Hallam, C. M.	5	0	0
Hallam, F.	5	0	0
Harrison, Charles.	10	6	0
Hill, Charles, & Sons	1	1	0
Howard, W.	5	0	0
Hunt, William.	5	0	0
Ind, Coope, and Co.	5	0	0
Istitt, Benjamin.	5	0	0
Jackson, Charles.	5	0	0
Jackson, Thomas A.	10	6	0
Lea, H. S.	10	6	0
Loverock, William.	5	0	0
Lowe, Thos. & Sons.	1	1	0
Marshall, William.	5	0	0
Marston, John, & Son.	5	0	0
Matthews, John.	1	1	0
Morris, John.	5	0	0
Mudie, James.	10	6	0
Owen, W. C.	5	0	0
Parsons, F. J.	1	1	0
Payne, Mrs.	10	6	0
Ratcliff, Misses.	10	6	0
Ratcliff, Robert	1	1	0
Robinson and Co.	2	2	0
Robinson, R.	5	0	0
Salt, Miss.	10	6	0
Salt, Thomas, & Co.	5	0	0
Salt, W. D.	5	0	0
Stanley, C. & W.	1	1	0
Thompson and Son.	2	2	0
Thornewill, Mrs.	1	1	0
Thornewill, Rev. C.	10	6	0
Townsend, W.	10	6	0
Treaise, J. N.	5	0	0
Wardle, William.	5	0	0
Warham, Charles.	5	0	0
Whitehead, T. N.	10	6	0
Wilson, Mrs.	10	6	0
Woodroffe, Henry.	5	0	0
Worsley, F.	5	0	0
Worthington & Co.	3	3	0
Wright and Son	1	1	0
Yeomans, John.	1	1	0
Sums under 5s.	10	19	0
Total.	62	18	6

*Donations.*

Millar Box, Recreation Ground.	1	2	4
Box, George Hotel	7	7	
" White Hart Hotel.	10	6	
Sums under 5s.	6	5	
Total Dons.	2	6	10
Total Subs.	62	18	6

£65 5 4

**LEEK BRANCH.**

Treasurer—  
A. R. WHYATT, Esq.

Honorary Secretary—  
J. NICHOLSON, Esq.

Annual Subscriptions.

	£.	s.	d.
Bradshaw, Mrs, E.	10	6	0
Brealey, John, Esq.	1	1	0
Brough, Edwin Esq.	1	1	0
Brough, John, Esq.	1	1	0
Brough, Joshua, Esq.	1	1	0
Brough, Wm. S. Esq.	1	1	0
Challinor, Jos. Esq.	2	2	0
Challinor, Wm. Esq.	1	1	0
Cruso, Mrs.	1	1	0
Deacon, Rev. G. E.	1	1	0
Goodwin, Stephen, Esq.	1	1	0
Hall, John, Esq.	1	1	0
Heaton, Edwin, Esq.	1	1	0
Johnson, H. L. Esq.	1	1	0
Nicholson, Arthur, Esq.	1	1	0
Nicholson, Joshua, Esq.	5	5	0
Nixon, B. B. Esq.	1	1	0
Smith, Miss.	1	1	0
Worthington, E. A. Esq.	1	1	0
Total.	£24	13	6

**STAFFORDSHIRE POTTERIES BRANCH.**

Treasurer—  
FRED. ALLEN, Esq.  
Hanley.

Honorary General Secretary—  
THOMAS ELSMORE, Esq.  
Tunstall.

**BURSLICK.**

Honorary Secretary—  
G. W. GARLICK, Esq.

Annual Subscriptions.

Alcock, John, Esq.	1	1	0
Alcock, Joseph, Esq.	1	1	0
Alcock, Richard, Esq.	1	1	0
Baker, C. G. Esq.	1	1	0
Bates, Gilda and Walker.	1	1	0
Bodley, E. F. Esq.	1	1	0
Boote, Messrs. T. and R.	1	1	0
Boetock, Thos. Esq.	10	6	0
Boutton, Wm.	10	6	0
Davenport, Hy. Esq.	1	1	0
Davenport, H. T. Esq.	1	1	0
Dean, Arthur.	1	1	0
Edge, Stephen.	1	1	0
Edge, Malkin, & Co.	1	1	0
Emery, J. P. Esq.	10	6	0
Emery, Robt. Esq.	10	6	0
Garlick, G. W. Esq.	1	1	0
Goodwin, George, Esq.	1	1	0
Hulme, Thos. Esq., Endon.	10	6	0
Hulme, Thos. Esq., Wolstanton.	1	1	0
Maddock, J. and Sons	1	1	0
Parker, Henry, Esq.	1	1	0
Shaw, A. Esq.	1	1	0
Tennant, F. Esq.	1	1	0
Till, T. and Sons.	1	1	0
Vernon, J. & G.	1	1	0
Wood, Edward, Esq.	1	1	0
Wood, Reginald N.	1	1	0
Woodall, Wm. Esq., M.P.	1	1	0
Total.	27	16	6

**HANLEY.**

Honorary Secretary—  
R. E. NARRAMORE, Esq.

	£.	s.	d.
Raxter, Edward, Esq.	10	6	0
Clementson Brothers, Messrs.	1	1	0
Dudson, James, Esq.	1	1	0
Hope, J. and Co. (2 years)	2	2	0
Keeling, Sam. Esq.	1	1	0
Meakin, J. & G.	2	2	0
Narramore, R.E. Esq.	10	6	0
Ridgway, Sparks, and Ridgway, Messrs.	1	1	0
Sherwin, Robt. Esq.	1	1	0
Stubbs, W.	1	1	0
Walker, J. G. Esq.	1	1	0

**LONGTON.**

Honorary Secretary—  
G. BAKEWELL, Esq.

Adderly, W. A. Esq.	10	6	0
Allerton and Sons, G.	1	1	0
Asbury, E. Esq.	1	1	0
Aynsley, J. Esq.	1	1	0
Bennion, Geo. Esq.	10	6	0
Bridgwood and Son, S.	1	1	0
Clarke Bros.	1	1	0
Carryer and Hawley.	1	1	0
Copeland and Sons, T. W.	1	1	0
Dale, Page, and Goodwin.	1	1	0
Dawes, W. J. Esq.	10	6	0
Glover, C. Esq.	1	1	0
Hawley, Felix, Esq.	1	1	0
Hudden, J. T. Esq.	10	6	0
Hulse, J. Esq.	1	1	0
Lockett and Co. J.	1	1	0
Mier, Stephen, Esq.	10	6	0
Kent and Son, John.	10	6	0
Robinson and Co. W.	1	1	0
Steele and Co.	1	1	0
Stirrup and Pye	1	1	0
Webberley, W. Esq.	1	1	0
Wright, F. S. Esq.	1	1	0
Wileman, W. F. Esq.	10	6	0

**NEWCASTLE.**

Honorary Secretary—  
FREDERIC ALLEN, Esq.

Coghill, H. Esq.	1	1	0
Keeling, Chas. Esq.	1	1	0

**TUNSTALL.**

Honorary Secretary—  
H. L. CLARK, Esq.

Beech, James, Esq.	1	1	0
Elsmore, T. Esq.	1	1	0
Ford and Challinor, Messrs.	1	1	0
Hollinshead, E. W.	1	1	0
Turner and Sons, Messrs. G. W.	1	1	0
Total.	£69	6	6

**WOLVERHAMPTON BRANCH.**

Chairman—

THOMAS SKIDMORE, Esq.  
Honorary Secretary—  
MR. SAMUEL HAND.

Annual Subscriptions.

Allen, E. F.	5	0	0
Anslow, H.	5	0	0
Armstrong, G.	10	0	0
Baker and Crockett.	1	1	0
Barker, J. W.	5	0	0
Bate, W. and Henry.	1	1	0
Bayliss, Jones, and Bayliss.	1	1	0

	£.	s.	d.
Birch, Wm.	5	0	
Bissell, W.	1	0	
Briscoe and Son, W.	5	0	
Brotherton, John	10	0	
Broughton, B. & Sons	5	0	
Burns, Thos.	5	0	
Cartwright, S.	1	1	0
Clarke, T. & C. & Co.	10	6	
Clarke, Mrs. C. S.	5	0	
Colebourne, W. H.	5	0	
Coleman, John	5	0	
Cooley, W. B.	5	0	
Cooper, John	5	0	
Cope, Captain T. B.	10	0	
Crane, C. H.	10	0	
David, E.	5	0	
Edwards, W.	10	6	
Evans & Son, J.	5	0	
Evans, Jas.	5	0	
Ewart, T. J. M.	5	0	
Fisher, Thomas	10	6	
Fleeming, Wm.	10	0	
Forayth, J.	10	0	
Gibbons, James	5	0	
Graham, Thos.	5	0	
Gospel Oak Iron Co.	1	1	0
Gough, Major F.	10	0	
Harley, G.	7	6	
Harper, H. G.	1	1	0
Hickman, E.	10	0	
Horsman, P.	2	0	
Hunter, E.	5	0	
Ironmonger, M.	10	6	
Jenks, Isaac, Esq.	10	0	
Jones, Jos.	1	0	
Langman, Mrs. F.	10	6	
Lea, Messrs.	10	0	
Lees and Sons, W.	1	1	0
Lee, P. J.	10	0	
Loveridge, H. Esq.	1	1	0
Meanley, George	5	0	
Meynell and Inman	5	0	
Miller, Jos. N.	1	0	
Mills, Mrs.	1	1	0
Moore, Mrs.	1	0	
Moreton, J. and Co.	1	1	0
Newnham, Dr.	10	0	
Owen and Fendelow	1	1	0
Paddy, Hy.	5	0	
Peck, Wm.	10	0	
Perks, Jno. and Son	1	1	0
Perry, Capt. T. J.	1	1	0
Plant, W. & J.	5	0	
Ready, Son, & Jones	10	0	
Reynolds, W. B.	5	0	
Riley, John	5	0	
Rogers and Sons, H.	1	1	0
Shaw and Son, John	1	1	0
Shelton, R.	10	6	
Skidmore, Thomas	10	0	
Sollom, B.	5	0	
Steen and Co.	10	6	
Stewart, John	10	0	
Stokes, Miss	10	0	
Tatiow, M.	10	0	
Thomas, W. Esq.	5	0	
Tudor, Major G. S.	1	1	0
Underhill, J. E.	10	0	
Walker, R. P.	5	0	
Ward, G. Esq.	1	1	0
Waterhouse, Thomas	10	0	
Weaver, W. H.	10	0	
Wheeler, C.	5	0	
Whitehouse, J.	1	1	0
Wilkes, M.	10	0	
Other Sums	7	6	
<b>Total</b>	<b>£52</b>	<b>8</b>	<b>6</b>

# Suffolk.

## ALDBOROUGH AND THORPE BRANCH.

Chairman—  
Colonel THELLUSSON.

Honorary Secretary—  
JAMES OSBORNE, Esq.

### Annual Subscriptions.

	£.	s.	d.
Aldboro' Corporation	5	0	0
Attwood, Rev.	1	0	0
Austin, Mrs.	1	1	0
Berners, J. Esq.	5	0	0
Bloomfield, Mrs.	1	1	0
Crampain, Mrs.	1	1	0
Crisp, Miss	10	0	0
Crisp, Miss E.	10	0	0
Ferrand, Capt.	1	0	0
Gurney & Co. Messrs.	1	0	0
Harper, G. Esq.	1	0	0
Holland, Rev. E.	2	0	0
Jan-on, Miss.	5	5	0
Long, Col.	1	1	0
Lynn, Miss	1	1	0
Middleton, Sir G.N.B.	10	0	0
Ogilvie, A. Esq.	2	10	0
Ogilvie, Mrs.	2	10	0
Osborne, Mr. J.	10	0	0
Rope, George, Esq.	1	0	0
Rose, Sir W. Bart.	1	1	0
Rose, Lady	1	1	0
Rowley, Sir C. Bart.	1	0	0
Thellussou, Col.	1	0	0
Wallace, Sir R. Bart.	10	0	0
Wayney, Lord	1	0	0
Wentworth, F. T. P. Esq.	2	2	0
Wiltshire, R. Esq.	1	1	0
<b>Total</b>	<b>62</b>	<b>5</b>	<b>0</b>

### Donations.

Mottee, Rev. Le	10	0	
Shouldham, Miss	1	0	0
Aldbore Boat House Box	1	4	4
Aldbore Church, per Rev. H. Thompson	4	15	3
Aldbore Pillar Box	12	6	0
Aldringham Church, per Rev. T. Cox.	4	1	1
<b>Total Dons.</b>	<b>12</b>	<b>2</b>	<b>8</b>
<b>Total Subs.</b>	<b>62</b>	<b>5</b>	<b>0</b>
<b>Total</b>	<b>£74</b>	<b>7</b>	<b>8</b>

## DUNWICH BRANCH.

President—  
F. BARNE, Esq.

Chairman—  
Lieut.-Col. BARNE, M.P.

Honorary Secretary—  
Rev. J. F. NOOR.

### Annual Subscriptions.

Arnott, Mr.	1	1	0
Barne, F. Esq.	2	2	0
Barne, Mrs.	1	1	0
Barne, Col., M.P.	2	2	0
Barne, Lady Constance	1	1	0
Bowater, Lady	1	1	0
Bridgeman, Lt.-Col. Hon. F. C.	1	0	0

	£.	s.	d.
Cotton, Miss	1	1	0
Noott, Rev. J. F.	10	6	
Scrivener, Mrs.	1	1	0
Sums under Esq., &c.	7	6	
<b>Total</b>	<b>£12</b>	<b>8</b>	<b>0</b>

## GORLESTON BRANCH.

Chairman—  
Capt. W. G. ALDRICH, R.N.

Honorary Secretary—  
J. P. BAUMGARTNER, Esq.

### Annual Subscriptions.

Aldrich, Capt. R.N.	10	6	
Bateley, John	5	0	
Baumgartner, J. P.	1	0	0
Baumgartner, Mrs., Godmanchester	1	0	0
Blake, Arthur Wm.	10	6	
Combe, Ed. H.	10	0	
Dendy, Mrs.	5	0	
Hammond, John	5	0	
Harvey, George	10	0	
Hewett, Fleming	10	6	
Nelson, Ambrose	1	0	0
Palmer, Garwood	10	6	
Salmon, Mrs. S.	1	1	0
Salmon, Wm.	10	6	
Tillard, P. E.	1	1	0
Tomkins, Rev. Gerald	5	0	
Tomlinson, Jos.	10	6	
Willis, W. H.	10	6	
<b>Total</b>	<b>£10</b>	<b>15</b>	<b>6</b>

## IPSWICH BRANCH.

President—  
J. C. COBOLD, Esq.

Vice-President—  
F. ALEXANDER, Esq.

Chairman—  
E. GRIMWADE, Esq.

Treasurer—

Honorary Secretary—  
J. F. TRICHMARSH, Esq.

### Annual Subscriptions.

Alexander, E. and Son	10	0	
Alexander, F. Esq.	1	1	0
Alexander, W. Esq.	10	6	
Alexander, S. Esq.	1	1	0
Anstruther, Col. J. H. L.	1	1	0
Bacon, G. C. E. Esq.	1	1	0
Bantoft, W. Esq.	10	6	
Bayley, Messrs. W. and Sons	1	1	0
Bell, A. Esq.	10	0	
Biddell, G. A. Esq.	1	1	0
Booth, D. H. Esq.	10	6	
Brown, W. Esq.	1	1	0
Burley, D. Esq.	10	0	
Byles, Mrs.	1	1	0
Churchman, H. Esq.	5	0	
Cobbold, J. C. Esq.	2	2	0
Cobbold, Mrs. J. P.	1	1	0
Cobbold, T. C. Esq. M.P.	1	1	0
Colchester, W. Esq.	10	0	
Collins, Mr. W. H.	5	0	
Cornell and Cornell, Messrs.	5	0	
Cuckow, Mr. W.	10	0	
Fish, F. Esq.	1	1	0
Fison, I. O. Esq.	10	0	
Fosdick, F. H. Esq.	10	6	

	£.	s.	d.
--	----	----	----

Footman, Pretty, and Nicolson, Messrs.	1	1	0
Goddard, E. Esq.	10	0	
Gower, Mrs.	1	2	0
Grimwade, E. Esq.	1	1	0
Haddock, Mr. J.	5	0	
Hamby, Capt.	5	0	
'Ipswich Journal'	5	0	
Jeffery, Rev. Alex.	5	0	
Josselyn, Miss	5	0	
Kemp, Mr. J. O.	5	0	
Limber, Mr. John	5	0	
Mason, Admiral	1	1	0
Maw, S. A. Esq.	1	1	0
May, John, Esq.	10	6	
Miller, Mr. R. M.	10	6	

National Provincial Bank, per E. Nicholson, Esq.	10	0	
Packard, E. Esq.	1	1	0
Packard, E., Jun., Esq.	1	1	0
Paul and Co., Messrs. R.	10	0	
Ransome, R. C. Esq.	1	1	0
Ransome, R. J. Esq.	10	6	
Reeve, Mrs.	1	1	0
Ridley, F. Esq.	10	0	
Ridley, Messrs. G. and O.	1	1	0
Schulen and Boby, Messrs.	10	0	
Sims, W. D. Esq.	1	1	0
Turner, Messrs. E. R. and F.	1	1	0
Turner, Messrs. W. and A. J.	1	1	0
Tidbury, H. Esq.	10	0	
Westhorp, S. Esq.	10	0	
Wright, C. Esq.	10	0	
Wrinch, Mr. A.	10	0	

Total .....40 18 6

### Donations.

Foresters' and Odd Fellows' Amalgamated Fete Committee, 1880, per Wm. B. Jerries, Esq. (Total contributions from this Committee, 1867-80, £36 10s.)	5	5	6
Box at "Journal" office	12	6	
<b>Total</b>	<b>£46</b>	<b>15</b>	<b>6</b>

## LOWESTOFT AND PAKEFIELD BRANCH.

Chairman—  
J. J. COLMAN, Esq., M.P.

Honorary Secretaries—  
FREDERICK MORSE, Esq.

Lowestoft.  
W. F. LARKINS, Esq.  
Pakefield.

Hon. Superintendent of Life-boats—  
Mr. JOHN HENDERSON.

Collector—  
Mr. J. E. COOK.

### Annual Subscriptions.

Ayerst, Mrs.	10	0	
Balls, W. T. Esq.	10	6	
Barne, Fred. Esq.	1	1	0
Base, Sam. Esq.	1	1	0
Birbeck, H. Esq.	1	0	0
Birbeck, Wm. Esq.	1	0	0
Bradbeer, B. M. Esq.	10	0	
Buxton, H. E. Esq.	2	2	0

BRANCHES—LIST OF ANNUAL SUBSCRIPTIONS AND DONATIONS. 355

	£.	s.	d.
Clemence, J. L. Esq. . . . .	5	0	0
Clubbe, W. H. Esq. . . . .	10	6	0
Colman, J. J. Esq. M.P. . . .	2	2	0
Cook, Mr. J. E. . . . .	5	0	0
Crake, Mr. E. F. . . . .	1	1	0
Crosley, Lady . . . . .	2	2	0
Cubitt, Rev. F. W. . . . .	1	1	0
Davey, Miss M. . . . .	1	1	0
Denny, Rev. R. C. . . . .	1	1	0
Eastaugh, J. D. Esq. . . . .	10	0	0
Eden, Adm. Henry . . . . .	1	0	0
Edwards, George, Esq. . . . .	1	1	0
Everitt, William, Esq. . . . .	1	1	0
Fisher, James, Esq. . . . .	5	0	0
Fiske, Edward B. Esq. . . . .	10	6	0
Fiske, Rev. R. W. . . . .	10	6	0
Fowler, E. W. Esq. . . . .	1	1	0
Fowler, G. G. Esq. . . . .	1	1	0
Gowing, J. J. W. Esq. . . . .	1	1	0
Gurneys and Co. . . . .	2	2	0
Harvey, E. K. Esq. . . . .	1	1	0
Henderson, Mr. John . . . . .	5	0	0
Howett, Samuel, Esq. . . . .	1	1	0
Hurst, Mrs. . . . .	10	0	0
Jadrell, Rev. Hy. . . . .	10	0	0
Johnson, Mr. W. . . . .	5	0	0
Johnson, Mrs. . . . .	1	1	0
Larkins, Capt. W. F. . . . .	2	2	0
Leathes, Lt.-Col. H. M. . . . .	1	1	0
Lucas, A. G. Esq. . . . .	1	1	0
Lucas, C. T. Esq. . . . .	1	1	0
Lucas, Thomas, Esq. . . . .	1	1	0
Morse, Frederick, Esq. . . . .	1	1	0
Mummy, E. . . . .	5	0	0
Peto, James, Esq. . . . .	1	1	0
Preston, Benj. Esq. . . . .	10	6	0
Preston, Capt. R.N. . . . .	10	6	0
Price, Rev. L. . . . .	1	1	0
Reeve, Rev. J. F. . . . .	1	0	0
Roddam, Mrs. . . . .	1	1	0
Rounce, J. Esq. . . . .	1	0	0
Seppings, Henry, Esq. . . . .	10	6	0
Spashett, Mr. A. . . . .	10	6	0
Stebbing, Mr. A. . . . .	5	0	0
Steward, Rev. Chas. J. . . . .	1	1	0
Thirtle, Mr. T. E. . . . .	5	0	0
Watson, J. T. Esq. . . . .	10	6	0
Warman, Wm. Esq. . . . .	10	6	0
Wingfield, Mrs. . . . .	1	0	0
Woods, Henry G. Esq. . . . .	10	6	0
Woods, T. B. Esq. . . . .	1	1	0
Worthington, F. S. Esq. . . . .	1	1	0
Worthington, J. C. Esq. . . . .	1	1	0
Worthington, W. C. Esq. . . . .	10	6	0
Youngs, Jos. Esq. . . . .	1	1	0
Youngman, W. Esq. . . . .	10	6	0
<b>Total . . . . .</b>	<b>56</b>	<b>3</b>	<b>0</b>

<b>Donations.</b>			
Carter, Rev. S. R. . . . .	5	0	0
Hamond, Capt. . . . .	1	0	0
National Provincial Bank . . . . .	2	2	0
Collection at Somerleyton Church . . . . .	3	16	5
Do. Corton Church . . . . .	1	15	11
Collecting Boxes . . . . .	3	14	4
<b>Total Dons. . . . .</b>	<b>17</b>	<b>8</b>	<b>8</b>
<b>Total Subs. . . . .</b>	<b>56</b>	<b>3</b>	<b>0</b>
<b>£73 11 8</b>			

**SOUTHWOLD BRANCH.**

**Chairman—**  
**J. L. EWEN, Esq.**  
**Treasurer—**  
**Mr. H. J. DEBNEY.**  
**Honorary Secretary—**  
**Mr. JOHN SINCLAIR.**

<b>Annual Subscriptions.</b>			
	£.	s.	d.
Allen, H. R. Esq. . . . .	10	0	0
Blacket, J., Esq. . . . .	1	0	0
Bosanquet, Miss. . . . .	1	1	0
Brook, J. W. Esq. . . . .	2	2	0
Burleigh, R. W. Esq. . . . .	10	6	0
Cautley, Rev. P. L. . . . .	10	0	0
Chester, Colonel . . . . .	1	0	0
Crabtree, Misses . . . . .	2	2	0
Crowfoot, Mrs. . . . .	1	1	0
Debney, Mr. H. J. . . . .	10	6	0
Eeles, Miss . . . . .	10	0	0
Ellis, Colonel . . . . .	1	0	0
Ewen, J. L. Esq. . . . .	1	0	0
Ewen, Rev. F. . . . .	10	0	0
Foster, Charles, Esq. . . . .	2	2	0
Gannon, E. M. Esq. . . . .	1	0	0
Gausson, Mrs. . . . .	1	0	0
Girling, R. C. Esq. . . . .	10	0	0
Grubbe, E. W. Esq. . . . .	1	0	0
Grubbe, J. E. Esq. . . . .	2	0	0
Grubbe, R. Esq. . . . .	1	0	0
Holland, Rev. E. . . . .	2	0	0
Marsden, Mrs. . . . .	10	6	0
Middleton, Adm. Sir G. N. Broke, Bart. . . . .	5	0	0
Powell, Capt. . . . .	10	0	0
Remnant, F. W. Esq. . . . .	2	0	0
Riches, Mr. B. . . . .	5	0	0
Sawyer, Mr. John . . . . .	2	6	0
Steele, T. D. Esq. . . . .	10	0	0
Symonds, Rev. N. . . . .	1	0	0
Vincent, J. L. Esq. . . . .	10	6	0
Whitaker, Herbert, Esq. . . . .	1	0	0
Wilmer, B. W. Esq. . . . .	1	1	0
<b>Total . . . . .</b>	<b>36</b>	<b>8</b>	<b>6</b>

<b>Donations.</b>			
Thompson, Henry, Esq. . . . .	1	0	0
Collecting Boxes . . . . .	2	13	0
<b>Total Dons. . . . .</b>	<b>3</b>	<b>13</b>	<b>0</b>
<b>Total Subs. . . . .</b>	<b>36</b>	<b>8</b>	<b>6</b>
<b>£40 1 6</b>			

**SUSSEX.**

**BRIGHTON BRANCH.**

**Chairman—**  
**Mr. Alderman COX, J.P.**  
**Treasurer—**  
**WILLIAM JOHNSTON, Esq.**  
**Honorary Secretary—**  
**W. R. WOOD, Jun., Esq.**

<b>Annual Subscriptions.</b>			
	£.	s.	d.
Ashbury, J. Esq., M.P. . . . .	10	10	0
Ashby & Co. Messrs. . . . .	1	1	0
Ashton, Mrs. . . . .	1	1	0
Attree, Geo. Esq. . . . .	10	6	0
Barnston, Miss . . . . .	1	1	0
Beaumont, Dr. . . . .	10	6	0

	£.	s.	d.
Bellingham, —, Esq. . . . .	10	0	0
Bevis & Co. Messrs. . . . .	1	1	0
Booth, E. Esq. . . . .	1	1	0
Bovill, Miss . . . . .	1	1	0
Bowen, Miss P. . . . .	1	1	0
Boys, Jacob, Esq. . . . .	10	0	0
Clarke, Somers, Esq. . . . .	10	6	0
Cox, Alderman . . . . .	1	1	0
Estridge, Lieut.-Col. . . . .	1	1	0
Eyre, G. J. Esq. . . . .	5	5	0
Forster, Capt. R.N. . . . .	1	1	0
Gore, Miss . . . . .	5	0	0
Hannington, C.S. Esq. . . . .	1	1	0
Howlett, J. W. Esq. . . . .	10	6	0
Jenner, H. N. Esq. . . . .	10	6	0
Johnston, W. Esq. . . . .	1	1	0
London and County Bank . . . . .	1	1	0
Lyon & Hall, Messrs. . . . .	10	6	0
Mason, Mrs. . . . .	1	1	0
Miller, Miss Constance . . . . .	11	6	0
Ogilvie, Mrs. . . . .	1	1	0
Oldham, J. Esq. . . . .	1	1	0
Partridge, Mr. A. . . . .	10	6	0
Penton, Colonel . . . . .	1	1	0
Poundall, W. L. Esq. . . . .	10	6	0
Reade, Rev. F. . . . .	1	1	0
Robertson, Miss L.M. . . . .	1	1	0
Skirrow, Miss . . . . .	1	1	0
Sutherland, A. H. Esq. . . . .	10	6	0
Sutton, Mrs. . . . .	1	1	0
Syrett . . . . .	1	1	0
Tamplyn, Mr. C. . . . .	1	1	0
Tuffnel, Miss . . . . .	10	6	0
Vallance and Catt, Messrs. . . . .	2	2	0
Wallis and Hack, Messrs. . . . .	1	1	0
Wilkinson & Son . . . . .	1	1	0
Willett, G. W. Esq. . . . .	1	1	0
Willett, H. Esq. . . . .	1	1	0
Woodhead, Major . . . . .	1	1	0
Wood, Mr. W. R. Jun. . . . .	10	6	0
Yates, Rev. H. W. . . . .	5	0	0
<b>Total . . . . .</b>	<b>55</b>	<b>2</b>	<b>0</b>

<b>Donations.</b>			
Boxes on Piers and Esplanade and at Aquarium . . . . .	50	1	7
H. B. . . . .	1	0	0
W. D. . . . .	1	0	0
<b>Total . . . . .</b>	<b>£107</b>	<b>3</b>	<b>7</b>

**CHICHESTER HARBOUR AND SELSEY BRANCH**

**President—**  
**The Right Rev. the LORD BISHOP OF CHICHESTER.**  
**Chairman of General Central Committee—**  
**C. LENNOX TERSDALE, Esq.**  
**Chairman of Local Committee—**  
**Rev. H. MITCHELL, F.S.A.**  
**Honorary Secretaries—**  
**Rev. H. MITCHELL,**  
**Rev. HERBERT C. FOSTER,**  
**Mr. JAMES GORHAM.**  
**Treasurers—**  
**Messrs. DENBY and Co.**

<b>Annual Subscriptions.</b>			
	£.	s.	d.
Rayton, Mr. . . . .	5	0	0
Bethell, Miss. . . . .	5	0	0
Buckner, Mrs. . . . .	5	0	0
Burnett, Rev. W. . . . .	5	0	0
Clement, Rev. T. . . . .	5	0	0
Cogan, Mr. T. S. . . . .	5	0	0
Cogan, Rev. H. . . . .	5	0	0
Collins, Mr. H. . . . .	1	1	0

	£.	s.	d.
Collins, Mrs. H. . . . .	10	6	0
De Bathe, General Sir H. P. Bart. . . . .	1	0	0
Ditto . . . . .	10	0	0
Denman, Hon. R. . . . .	1	0	0
Edmont, the Earl of . . . . .	2	2	0
Fetherstonhaugh, Miss . . . . .	10	0	0
Fletcher, Sir Henry, Bart. . . . .	10	6	0
Fletcher, Mr. C. J. . . . .	2	2	0
Foster, Rev. R. . . . .	5	0	0
Gaisford, Rev. G. . . . .	5	0	0
Garnham, Lt.-Colonel . . . . .	1	1	0
Hall, Mr. C. H. . . . .	1	0	0
Herington, Mr. E. . . . .	5	0	0
Hobgen, Mr. C. . . . .	10	0	0
Hobgen, Mrs. T. . . . .	5	0	0
Hornby, Admiral Sir G. T. Phipps, K.C.B. . . . .	1	0	0
Jarman, Captain . . . . .	10	0	0
Johnson, Rev. E. H. (the late) . . . . .	1	0	0
Kelly, Rev. E. . . . .	5	0	0
Kent, Mr. . . . .	5	0	0
Langdale, Rev. G. A. . . . .	5	0	0
Leconfield, Lord . . . . .	1	0	0
Lewis, Rev. H. C. . . . .	5	0	0
Miller, Rev. J. Webber . . . . .	5	0	0
Oldfield, Col. B. E. . . . .	5	0	0
Pechkam, Mrs. (the late) . . . . .	5	0	0
Prime, Capt. . . . .	1	0	0
Raikes, Mr. C. S. . . . .	10	0	0
Randall, Mr. J. . . . .	10	0	0
Richmond and Gordon, The Duke of, K.G. . . . .	2	2	0
Robinson, Mr. A. . . . .	10	0	0
Smith, Mrs. F. . . . .	1	0	0
Stanford, Mr. E. . . . .	10	0	0
Sutton, Rev. E. . . . .	5	0	0
Turing, Sir R. F., Bt. . . . .	1	0	0
Upton, Mr. H. . . . .	5	0	0
Welliesley, The Lady Victoria Long . . . . .	3	0	0
Woods, Mr. John W. . . . .	10	0	0

<b>ARUNDEL, per Mr. C. BARTLETT, Jun.:</b>			
Butt, Rev. Canon . . . . .	5	0	0
Constable, Mr. G. S. . . . .	10	0	0
Coote, Mr. G. C. . . . .	5	0	0
Drewitt, Mr. R. D. . . . .	10	0	0
Duke, Mr. F. . . . .	10	0	0
Evans, Mr. T. . . . .	1	1	0
Evershed, Mr. C. L. . . . .	10	0	0
Evershed, Mr. G. T. . . . .	5	0	0
Fogden, Mr. John . . . . .	5	0	0
Fry, Mr. E. . . . .	5	0	0
Fry, Mr. William . . . . .	10	0	0
Holmes, Mr. E. Carleton . . . . .	5	0	0
Holmes, Mr. Richard . . . . .	10	0	0
Lambert, Mr. . . . .	1	1	0
Lewis, Mr. D. . . . .	5	0	0
Long, Mr. John . . . . .	5	0	0
Mitchell, Mr. W. W. . . . .	5	0	0
Moety, Captain . . . . .	5	0	0
Norfolk, The Duke of, E.M. . . . .	2	2	0
Thompson, Rev. A. S. . . . .	5	0	0
Tompkins, Mr. John . . . . .	5	0	0
Uplfold, Mr. R. . . . .	5	0	0
Watkins, Mr. E. . . . .	5	0	0
Webb, Mr. W. L. . . . .	5	0	0
<b>Sums under 5s. . . . .</b>	<b>2</b>	<b>9</b>	<b>6</b>

<b>LITTLEHAMPTON, per Mr. GEORGE LEGGETT:—</b>			
Barker, Mr. C. J. . . . .	5	0	0
Bryan, Mr. . . . .	5	0	0
Butt, Mr. J. . . . .	10	0	0
Butt, J. E. & Sons, Messrs. . . . .	10	0	0
Butt, Mrs. J. E. . . . .	5	0	0
Candy, Mr. J. H. . . . .	5	0	0
Candy, Mrs. . . . .	5	0	0
Constable, Mr. Thos. . . . .	5	0	0
Downer, Miss . . . . .	5	0	0
Duke, Messrs. . . . .	10	0	0

		£.	s.	d.			£.	s.	d.			£.	s.	d.	
Evans, Mr. Thomas.	5	0	0	Smith, Mr. William.	5	0	Pasco, Mr.	5	0	Covert-Freund, Mrs.	5	0			
Harvey, Messrs. J. & W. B.	10	0	0	Spencer, Mrs.	5	0	Paul, Mr. G.	5	0	Gravey, Rev. H. F.	0	5	0		
Ion, Mr.	5	0	0	Titchener, Mr. J. J.	5	0	Peachey, Mr. E.	5	0	Hobgen, Mr. F. N.	5	0			
Iron, Mr. and Mrs.	10	0	0	Trevett, Mrs. J.	5	0	Percival, Mr.	1	0	Hodson, Mrs.	5	0			
Lefroy, Captain, R.N.	5	0	0	Trevett, Mr. O.	5	0	Phipps, Mrs. (the late)	5	0	Mount Carmel, the Rev. Mother of the Convent of.....	5	0			
Leggett, Mr. G.	5	0	0	Walker, Miss	5	0	Pinnix, The Misses	5	0	Nunns, Rev. R. A.	5	0			
Looker, Mr.	5	0	0	Walker, Rev. G. A.	5	0	Pratt, Capt.	10	0	L.....	5	0			
Moore, Miss	10	0	0	Walker, Mr. W.	5	0	Purchase, Mr. R.	5	0	Peachey, Mr. James	5	0			
Neame, Mr. G.	5	0	0	Walker, Mr. T. L.	5	0	Raper, Mr. R. G.	5	0	Teesdale, Mr. C. L.	10	0			
Neame, Mrs. G.	5	0	0	Wallis, Admiral Sir Provo, G.C.B.	5	0	Riadore, Rev. G.	5	0	Torr, Rev. T. J.	5	0			
Neame, Mr. N.	5	0	0	Warren, Capt.	5	0	Richardson, Mr. J.	5	0	Sums under 5s.....	10	0			
Phillip, Rev. W. B.	5	0	0	Woodman, Capt. C. E. S., R.N.	5	0	Russell and Sons, Messrs.....	5	0						
Robinson, Mr. G.	5	0	0	Wood, Mr. John	5	0	Russell, Mr. G.	5	0	SELSEY, per Mr. JAMES LAWRENCE:—					
Robinson, Mr. Joseph	5	0	0	Wyatt, Mr. F. W.	5	0	Sayers, Mr. J.	5	0	Bateman, Mr. E. H.	5	0			
Rumball, Rev. C.	5	0	0				Shippam, Mr. C.	5	0	Chase, Mr. R.	5	0			
Smith, Mr. C.	5	0	0				Silverlock, the Misses	5	0	Foster, Rev. H.	5	0			
Stansfield, Rev. E.	5	0	0	CHICHRISTER, per Mr. W. NORMAN:—			Smith, Mr. G.	5	0	Foster, Rev. Herbert C.....	5	0			
Wathew, Mrs.	5	0	0	Adames, Mrs. Benness	10	0	Smith, Mrs. H.	5	0	Penfold, Mr. H.	5	0			
Whitehead, Mr.	5	0	0	Adames, Mr. F.	5	0	Smith, Mr. T.	5	0	Pullinger, Mr. C.	5	0			
Sums under 5s.....	6	15	6	Anderson, Mr.	5	0	Smith, Messrs.	5	0	Woodman, Mr. W.	5	0			
				Arnold, Mr. E.	10	6	Sowton, Mr. M. J.	5	0	Yeatman, Capt.....	10	0			
				Atkey, Mr. C. J.	5	0	Swainson, Rev. Dr.	5	0						
BOGNOR, per Mr. G. E. KEED.															
Bray, Mrs.	5	0	0	Ballard and Son, Messrs.....	5	0	Temple, Mr. (the late)	10	0						
C. C. T.	5	0	0	Bennell, Mr.	10	0	Teulon, Rev. J. S.	5	0	SINGLETON, per Rev. F. A. BOWLES:—					
Davenport, Mr.	5	0	0	Brown, Major	5	0	Tyacke, Dr.	5	0	Bower, Mr. F.	1	1	0		
Douglas, Mrs.	5	0	0	Bruton, Rev. W.	5	0	Vick, Mr. F. M.	5	0	Bowles, Rev. F. A.	10	0			
Drake, Capt., R.N.	5	0	0	Buckell, Dr.	5	0	Walker, Ven. Arch- deacon.....	5	0	Bulbeck, Mr.....	5	0			
Fletcher, Mrs.	5	0	0	Buckle, Mr.	5	0	Wilmshurst, Mr.	5	0	Deedes, Miss	10	6			
Hay, Mr. R. B.	5	0	0	Caffin, Mr. J.	5	0	Wilson, Mr. T.	5	0						
Keates, Capt.	5	0	0	Caffin, Mr. W. J.	5	0	Wright, Mr. A.	5	0						
Mair, Mrs.	5	0	0	Campbell, Mrs.	10	0	Sums under 5s.....	8	9	6					
Phillip, Rev. W. B.	5	0	0	Cavill, Rev. G.	5	0									
Slade, Colonel	5	0	0	Charge, Miss	5	0	EMSWORTH, per Mr. BULL:—								
Taylor, Admiral	5	0	0	Chichester, the Lord Bishop of.....	10	0	Allen, Rev. R. P.	10	0						
Tritton, Rev. R. B.	5	0	0	Chichester, the Dean of.....	10	0	Aylward, Miss	5	0						
Weld, Mr.	5	0	0	Church, Mr.	5	0	Boyd, Mr. C. P.	10	0						
Wilson, Mr. James	5	0	0	Comper, Mr. H. (the late).....	1	2	Castle, Mrs.	5	0						
Sums under 5s.....	3	15	6	Cover, Messrs.	5	0	Cox, Mr. J. E.	5	0						
				Curtis, Captain, R.N.	5	0	De Kantzog, Capt. W. S.....	5	0	WEST WITTERING, per Mr. JOHN TRUST:—					
				Dendy, Mrs. G. T. (the late).....	5	0	Dixon, Mr. H. H. W.	5	0	Andrews, Mr. John	5	0			
				Dendy, Mr. R.	5	0	Fellowes, Mrs. W. B.	5	0	Aylmore, Mr. Thos.	5	0			
				Dilke, Mr. W.	10	0	Hipkin, Mrs. W.	5	0	Combes, Mr. Charles	10	0			
				Dulke, Mr. W.	5	0	King, Mr. W.	5	0	Gorham, Mr. J.	10	0			
				Edgell, Mrs.	10	0	Liott, Mrs.	5	0	Sparkes, Mr. R. H.	5	0			
				Farenden, Miss (the late).....	5	0	Lyon, Miss	5	0	Underwood, Rev. W. D.....	5	0			
				Frampton, Rev. C. T.	1	0	Mackie, Mrs.	5	0	Wilson, Mr. T.	5	0			
				Fraser, Rev. J.	5	0	Martin, Mr. G. P., R.N.....	5	0	Sums under 5s.....	7	0			
				Freeland, Mr. H. W.	10	0	Matson, Miss	5	0						
				Gadd, Mr. E.	5	0	Munday, Lady	5	0	Total.....152 11 6					
				Gambing and Sons, Messrs.....	5	0	Norris, Rev. W.	10	0						
				Garland, Mr. S.	5	0	Norris, Rev. W. B.	5	0						
				Gatehouse and Son, Messrs.....	10	0	Oldfield, Miss	5	0						
				Gibbings, Mrs.	5	0	Orsborn, Mr. J.	5	0						
				Gibbings, Mr. H. W.	5	0	Osmond, Mr. J. H.	5	0						
				Glennie, Rev. A. H.	5	0	Padwick, Mr. H.	1	0						
				Greene, Mr. T.	5	0	Rawson, Mr.	5	0						
				Gruggen, Mrs. J.	5	0	Rawson, Mrs.	5	0						
				Gruggen, Rev. G. S.	5	0	Sainthill, Mr. R.	5	0						
				Gruggen, Mr. F. W.	5	0	Scale, G. T.	10	0						
				Habin, Mr. E.	5	0	Shawe, Mrs. R.	5	0						
				Halsted, Mr. C. T.	5	0	Shearn, Rev. H. S.	5	0						
				Hardy, Maj.-Gen.	5	0	Sheppard, Rev. H. W.	10	0						
				Hayler, Mr. G.	5	0	Smith, Mrs. E.	5	0						
				Hayllar, Miss	10	0	Spencer, Capt.	1	0						
				Hayllar, Mrs. C.	10	6	Thompson, Mrs.	5	0						
				Henty, Mr. G.	10	0	Wilde, Rev. R.	5	0						
				Hill, Rev. J.	5	0	Wildier, Mr. G.	1	0						
				Irving, Mr. G.	10	0	Sums under 5s.....	3	5	6					
				Johnson, Mr. J. J., Q.C.	10	0									
				Johnson, Rev. S.	5	0	MIDHURST, per								
				Johnson and Son, Messrs.....	5	0	Gosden, Mr. J.	5	0						
				Johnson, Captain J. Luttman.....	5	0	Hilton, Rev. M. F.	5	0						
				Lennard, Miss	5	0	Johnson, Mr. Thomas	5	0						
				Matthews, Miss	5	0	Robinson, Mr. John, M.D.....	5	0						
				Newland, Miss	5	0	Stapley, Rev. F. A.	5	0						
				Nicolls, Miss L.	10	0	Stephens, Rev. Pre- bendary.....	10	6						
				Norman, Mr. W.	1	0	Warren, Mrs. H.	10	0						
				Olden, Mr.	5	0	Weekes, Mr. (2 years)	1	0						
				Partington, Mr.	5	0									
							MUNDHAM, per Rev. T. J. TORR:—								
							Andrews, Mr. T.	5	0						
							Caldwell, Mr.	10	0						



**EASTBOURNE BRANCH.**

Chairman—  
A. B. WRANGHAM, Esq.  
Treasurer—  
G. MOLINEUX, Esq.  
Honorary Secretary—  
Mr. H. M. EMARY.

*Annual Subscriptions.*

	£.	s.	d.
Adams, Rev. E. ....	10	0	0
Alder, the Rev. Dean ..	5	0	0
Allen, Rev. R. ....	5	0	0
Allpress, Mr. F. ....	5	0	0
Angell, Mrs. ....	5	0	0
Bindon, Mr. S. ....	5	0	0
Blackburn, J. J. Esq. 1	0	0	0
Bradley, Miss. ....	5	0	0
Brodie, Wm. Esq. ....	10	0	0
Brodie, Miss. ....	5	0	0
Bromley, G. F. ....	5	0	0
Brown, G. ....	5	0	0
Brown, Mr. J. ....	5	0	0
Brown, Mr. H. R. ....	5	0	0
Cardwell, Mrs. D. A. ....	5	0	0
C. H. ....	10	0	0
Climpson, Mr. ....	5	0	0
Colgate, R. Esq. ....	10	0	0
Colville, E. Esq. ....	5	0	0
Crake, Rev. E. ....	5	0	0
Devonshire, His Grace the Duke of.....	1	1	0
Dexter, Mrs. ....	5	0	0
Earp, Wm. Esq. ....	1	1	0
E. H. ....	5	0	0
Edwards, Mr. James ..	6	0	0
Ellis, John, Esq. ....	10	0	0
Foran, J. C., Esq. ....	5	0	0
Gage, Hon. Miss. ....	5	0	0
Gilbert, Hon. Mrs. ....	1	1	0
Gould, Dr. G. ....	10	0	0
Green, Rev. G. R. ....	5	0	0
Gurney, G. Esq. ....	5	0	0
Hagger, Mrs. ....	5	0	0
Hart, Miss. ....	10	0	0
Hedley, Capt. G. ....	10	0	0
Henderson, R. H. Esq. ....	5	0	0
Holman, Captain ..	5	0	0
Homewood, Mr. ....	5	0	0
Hood, W. Esq. ....	10	0	0
Hurst, Mr. Alex. & Co. 1	0	0	0
Lippencott, R. C. C. Esq. ....	10	6	0
Lothian, ....	5	0	0
Low, Rev. T. ....	5	0	0
Manby, Colonel. ....	1	1	0
Michell, Mr. R. ....	5	0	0
Morris & Son, Messrs. ....	5	0	0
Mures, Miss. ....	10	0	0
Palmer, Rev. ....	5	0	0
Pennell, Mrs. C. ....	10	0	0
Percival, Esq. ....	1	1	0
Phipps, Mrs. Jane ..	5	0	0
Pitman, Rev. T. ....	5	0	0
Podmore, Rev. J. ....	10	0	0
Roberts, Dr. ....	5	0	0
Roper, F. C. S. Esq. ....	1	1	0
Roper, Mr. John ....	5	0	0
Rudd, Mr. ....	5	0	0
Russell, Scott, Esq. ....	10	0	0
Schreiner, Fredk. Esq. ....	10	0	0
Sharp, R. M. Esq. ....	10	0	0
Sherwood, Dr. A. P. ....	5	0	0
Soddy, B. Esq. ....	5	0	0
Sparks, Mr. Jno. ....	5	0	0
St. Clair, Mrs. Rosetta Solomons .....	10	0	0
Stiff, Carlton, Esq. ....	5	0	0
Stretton, Mr. J. ....	5	0	0
Sturgis, J. Esq. ....	1	1	0
Sutton, Mr. H. ....	5	0	0
Sutton, Mr. Thos. ....	5	6	0
Swift, John, Esq. ....	1	1	0
Swinford, Mrs. A. ....	5	0	0
Tarbut, Miss. ....	5	0	0
Tindall, Miss. ....	5	0	0
Travers, Archd. Esq. ....	10	0	0
Ustill, Rev. J. ....	5	0	0

	£.	s.	d.
Walker, E. Esq. ....	1	0	0
Whelpton, Rev. H.R. ....	5	0	0
Winder, J. Esq. ....	5	0	0
Whitfield, Molineux, Messrs. ....	10	0	0
Witder, Mr. E. ....	5	0	0
Woodland, Mrs. ....	5	0	0
Wragg, G. P. Esq. ....	5	0	0
Wrederson, W. Esq. ....	5	0	0
Small sums .....	22	17	2
	57	3	2

*Donations.*

Allen, Mrs. Sarah L. ....	1	0	0
Bradford, Miss M. ....	7	13	3
Collecting Boxes. ....	12	8	1
	21	1	4
	57	3	2
	£78	4	6

**HASTINGS AND ST. LEONARDS BRANCH.**

Secretary—  
Geo. HUTCHINGS.

*Annual Subscriptions.*

	£.	s.	d.
Abergavenny, Mar. of.....	10	0	0
Adey, Dr. ....	10	0	0
Addison, Mr. W. S. ....	5	0	0
Agnew, Mr. ....	5	0	0
Aikin, Mrs. ....	5	0	0
Anstey, Mrs. ....	10	0	0
Anstey, Mrs. H. ....	10	0	0
Bacchus, Mrs. ....	10	0	0
Back, Miss. ....	1	1	0
Barlow, Capt. and Mrs. ....	10	0	0
Baker, Mr. H. M. ....	5	0	0
Baker, Wm. Esq. ....	5	0	0
Bartlett, W. A. A. Esq. ....	10	0	0
Beaumont, Mrs. ....	5	0	0
Beaumont, Mrs. ....	1	1	0
Beecing and Co., Messrs. ....	1	1	0
Biddulph, Lady ..	10	0	0
Bishop, Miss F. ....	1	1	0
Burton, A. H. Esq. ....	1	1	0
Boger, G. O. Esq. ....	5	0	0
Boning and Small, Messrs. ....	10	6	0
Bostock, Mrs. S. ....	1	1	0
Boxill, Mr. M. A. ....	5	0	0
Braham, Mrs. ....	10	0	0
Brassey, T. Esq. M.P. ....	1	1	0
Brisco, Miss. ....	1	1	0
Broadwood, Mrs. ....	10	0	0
Brocklebank, R. M. Esq. ....	1	1	0
Bromhead, Mrs. A. L. ....	5	0	0
Brown, H. A. Esq. ....	10	0	0
Bryant, Col. ....	5	0	0
Byass, Mrs. R. Blake Burfield, Messrs. ....	10	0	0
J. and C. ....	5	0	0
Burgoyne, J. C. Esq. ....	10	0	0
Butts, Mrs. ....	10	0	0
Byng, Lieut.-Col. ....	10	0	0
Carter, C. P. Esq. ....	1	1	0
Caulfield, H. C. Esq. ....	5	0	0
Cayleys, Miss. ....	5	0	0
Christopherson, Miss Coles, T. H. Esq. ....	1	1	0
Cooke, Dr. ....	5	0	0
Corporation of Hastings .....	20	0	0
Cotton, Miss. ....	1	1	0
Coutts, Baroness Burdett. ....	1	0	0
Crake, V. B. Esq. ....	1	1	0
Crothers, Dr. ....	1	0	0
Croucher, Dr. ....	5	0	0
Cumberlege, Mrs. ....	5	0	0
Darley, E. G. Esq. ....	5	0	0
Dashwood, Mrs. ....	5	0	0
Dawes, Rev. G. D. ....	5	0	0

	£.	s.	d.
Dawson, Mrs. W. H. 1	1	0	0
Denyssen, Hon. Justice .....	10	0	0
Dickinson, Mrs. ....	5	0	0
Dixon, J. Esq. ....	1	0	0
Dockray, Mrs. ....	5	0	0
Dods, Mrs. & Misses. 1	10	0	0
Douglas, Mrs. J. ....	5	0	0
Ede, Miss. ....	5	0	0
Edridge, Mrs. ....	5	0	0
Elkin, C. M. Esq. ....	5	0	0
Ellis, Miss. ....	5	0	0
Emerson, Miss. ....	5	0	0
Emerson, Mrs. ....	5	0	0
Evans, A. Esq. ....	5	0	0
Eversfield, C. I. Esq. 1	0	0	0
Eyre, Rev. C. J. P. ....	10	0	0
Fisk, Rev. J. H. ....	1	1	0
Foyster, Rev. G. A. ....	10	0	0
Foyster, Rev. H. B. ....	10	0	0
Friend, A. (a lady) . 1	0	0	0
Gardner, Rev. G. G. ....	10	0	0
Ginner and Son, Messrs. ....	5	0	0
Gray, Mrs. J. ....	1	1	0
Green, Rev. W. ....	10	0	0
Griffin, Mrs. N. ....	1	1	0
Gordon, Admiral ...	10	0	0
Gordon, Sir Seton . 1	0	0	0
Gore, Hon. Mrs. A. ....	5	0	0
Gottlieb, Mrs. ....	5	0	0
Guillebad, Rev. H. ....	10	0	0
Hagger, Mrs. J. B. ....	5	0	0
Hancock, Miss .....	10	0	0
Hardy, Misses .....	5	0	0
Havelock, Sir H. V. C. ....	10	0	0
Haviland, F. G. Esq. 1	0	0	0
Heathcote, U. Esq. ....	5	0	0
Hewlett, H. G. Esq. ....	10	0	0
Hodgson, Genl. S. ....	10	0	0
Holley, Mrs. H. ....	10	0	0
Horton, Sir G. W. ....	10	0	0
How and Co. Messrs. C. T. ....	5	0	0
Hume, Rev. W. W. ....	1	1	0
Huxtable, Archdeacon Jones, R. J. Esq. ....	10	0	0
Kennerly, Miss .....	5	0	0
Kingsbury, Miss ...	5	0	0
Langdon, A. W. Esq. ....	10	0	0
Lee, Miss .....	10	0	0
Leigh, Mrs. ....	1	1	0
Mackay, Miss .....	6	0	0
Marquis, Col. ....	5	0	0
Martin, Charles, Esq. ....	10	0	0
Martin, Horace, Esq. 1	1	0	0
Mason, J. Esq. ....	1	1	0
Merry, Mrs. ....	5	0	0
Morris, J. S. Esq. ....	10	0	0
Mount, W. Esq. ....	10	0	0
Muller, Mrs. ....	10	0	0
Newton, Genl. ....	10	0	0
Nicholl, Miss .....	10	0	0
Nichols, Mrs. C. ....	5	0	0
Norcott, Gen. Sir W. ....	5	0	0
Norie, Miss .....	5	0	0
North, Miss .....	10	0	0
Orlebar, Admiral . 1	0	0	0
Paget, Lady .....	5	0	0
Parkin, Rev. J. ....	5	0	0
Perkins, Mrs. ....	1	0	0
Peyton, J. E. H. Esq. 1	0	0	0
Pilkington, Mrs. ....	5	0	0
Pritchard, Mrs. ....	10	0	0
Pott, Mrs. A. S. ....	10	0	0
Rawlins, Rev. F. J. ....	10	0	0
Reeve, Mrs. Ellis. ....	5	0	0
Roe, Henry, Esq. ....	5	0	0
Ross, Thomas, Esq. ....	10	0	0
Rosher, Miss. ....	5	0	0
Rosher, Mrs. ....	5	0	0
Sandaz, Mrs. ....	5	0	0
Sayer, The Misses . 1	1	0	0
Scrivens, S. Esq. ....	10	0	0
Sedgewick, Mrs. ....	10	0	0
Shaddock, Mrs. ....	10	0	0
Shaw, Dr. A. ....	5	0	0
Smith, Mrs. E. J. ....	10	0	0
Smith, Mrs. Masters. ....	5	0	0
Spedding, Mr. J. ....	5	0	0
Stacey, Mrs., and visitors .....	12	6	0

	£.	s.	d.
Stainton, Miss. ....	10	0	0
Stanton, A. J. ....	5	0	0
Steele, Genl. Sir T. ....	10	0	0
Stiebel, Miss .....	10	0	0
Sutton, Rev. E. S., Rype Rectory. ....	1	0	0
Tanner, Mr. & Mrs. ....	10	0	0
Taylor, Genl. P. ....	5	0	0
Thackeray, Lady E. ....	10	0	0
Thank Offering, S. L. ....	10	0	0
Thompson, Hon. A. R. ....	5	0	0
Thorne, Mrs. ....	5	0	0
Tottenham, Rev. J. W. ....	10	0	0
Teacher, H. Esq. ....	10	0	0
Turner, Miss. ....	10	6	0
Turner, Rev. W. T. ....	10	0	0
Visitors, 21 Wat. Sq. ....	10	0	0
Vores, Alderman S. ....	10	0	0
Von Roemer, Baroness 1	0	0	0
Waldgrave, Lady M. ....	5	0	0
W. A. M. ....	5	0	0
Warrior Sq., 47 .....	5	0	0
Waterfield, Mrs. ....	5	0	0
Wickham, Miss. ....	5	0	0
White, Lynot. ....	5	0	0
Whiting, Mrs. Scott ..	5	0	0
Wiggin, Miss .....	5	0	0
Young, W. B. Esq. ....	1	0	0
Sums under 5s. ....	11	12	11
Boxes .....	19	3	6
	136	7	11

*Donation.*  
Peyton, J. E. H. Esq. 4 0 0

£140 7 11

**NEWHAVEN BRANCH.**

Chairman—  
R. T. DOLAN, Esq.  
Honorary Secretary—  
J. W. NOEL, Esq.

*Annual Subscriptions.*

	£.	s.	d.
Sheffield, Earl of. ....	2	0	0
Chichester, Earl of. ....	2	0	0
Gage, Viscount .....	2	0	0
Blencowe, J. G. Esq. ....	1	0	0
Brown, Thomas, Esq. 1	0	0	0
Burfield & Son, Messrs. 2	0	0	0
Bushby, Geo. Esq. ....	10	0	0
Catt, Miss. ....	1	0	0
Catt & Son, Messrs. W. 1	1	0	0
Chatfield & Co. Messrs. ....	10	6	0
Edwards, W. S. Esq. ....	10	0	0
Farncombe, J. Esq. ....	5	0	0
Gardlee, B. Esq. ....	10	0	0
Gorring, Mrs. H. B. ....	10	0	0
Hillman, Messrs. T. & R. ....	10	0	0
Lamb, Robert, Esq. ....	5	0	0
Love, T. H. Esq. ....	10	6	0
Lowdell and Cooper, Messrs. ....	10	0	0
Madgwick and Son. ....	5	0	0
Monk & Son, Messrs. ....	10	6	0
Morris, E. Esq. ....	10	6	0
Pam, Mr. Albert. ....	5	0	0
Parsons, Messrs. ....	10	0	0
Simmons, H. Esq. ....	10	0	0
Simmons, T. J. Esq. ....	10	0	0
Southwood, Rev. E. P. ....	5	0	0
Stevens, Mr. Z. ....	5	0	0
Stone and Townner, Messrs. ....	10	0	0
White, Capt. ....	5	0	0
Whitfield and Co. Messrs. ....	1	1	0
	22	2	0

*Donations.*  
Iron Pillar Box and  
other boxes .....

£29 10 7

**RYE AND WINCHELSEA BRANCH.**

**President—**  
T. S. PIX, Esq.

**Honorary Secretary—**  
HENRY BURRA, Esq.

**Annual Subscriptions.**

Adamson, E. Esq.	10	0
Bellingham, F. Esq.	10	6
Blomfield, Mrs.	1	0
Burra, H. Esq.	10	0
Churton, Rev. H. B.	10	0
W.	10	0
Dawes, Walter, Esq.	5	0
Frewen, Edward, Esq.	2	0
Gladstone, Rev. D. T.	1	0
Hilder, Mr. George.	2	0
Inderwick, F. A.	1	0
Esq., M.P., Q.C.	1	0
Lord, Rev. J. O.	10	0
Mayor of Rye.	10	0
Meryon, Mrs.	10	0
Pix, Thomas S. Esq.	1	0
Skinner, R. V. Esq.	10	0
Stileman, Major.	1	0
Styeman, Miss.	10	0
Symonds, Mrs.	1	0
Vidler, Mr. J. S.	10	6
<b>Total</b>	<b>15</b>	<b>14 0</b>

**Donations.**

Pilot Smith	1	0	0
Mr. Moon's box	10	0	0
<b>Total</b>	<b>11</b>	<b>0</b>	<b>0</b>

**£17 4 0**

**SHOREHAM BRANCH.**

**Chairman—**  
HUGH GOBBINGE, Esq.

**Treasurer—**  
ROBERT HENDERSON, Esq.

**Honorary Secretary—**  
THOS. FULLER, Esq. M.D.

**Honorary Collector—**  
D. PILMORE.

**Annual Subscriptions.**

Reves and Co.	1	0	0
Brown, J. E. Esq.	10	6	0
Burrell, Sir W. W.	1	0	0
Bart. M.P.	1	0	0
Cave, Rt. Hon. Sir	1	0	0
Stephen, G.C.B.	1	0	0
Ditto (legacy)	2	0	0
Fuller, Thomas, Esq.	10	6	0
Gorringe, H. Esq.	2	0	0
Henderson, R. Esq.	10	6	0
Ingram, Colonel	2	0	0
(1878 and 1879)	2	0	0
Loder, Robert, Esq.	1	0	0
M.P.	1	0	0
Penney, R. H. Esq.	1	0	0
Pilmore, D. Esq.	10	6	0
Rake, S.	5	0	0
Stapledon, T. L. Esq.	10	0	0
Swales, Captain	10	6	0
Vallance, Catt, & Co.	1	0	0
Willet, G. W. Esq.	1	0	0
<b>Total</b>	<b>116</b>	<b>17</b>	<b>6</b>

**WORTHING BRANCH.**

**Patron—**  
Sir W. W. BURRELL, Bart. M.P.

**Chairman—**  
H. HARGOOD, Esq.

**Honorary Secretary—**  
MELVILL GREEN, Esq.

**Annual Subscriptions.**

Anonymous, per Post-master	10	6	
Anstlin, C. Esq.	5	0	
Blair, Mrs.	5	0	
Blaker, Ernest H. Esq.	5	0	
Blaker, Mr. F.	5	0	
Brewer, Mrs.	5	0	
Brooke, Mrs.	10	0	
Burnand, Capt. A.	10	0	
Burnand, G. Esq.	10	6	
Butcher, Mrs.	5	0	
Butler, Mrs.	10	6	
Capron, Rev. C. H.	5	0	
Chaplin, Messrs.	5	0	
Cholmeley, the Misses	5	0	
Coffin, E. Esq.	10	0	
Collet, A. H. Esq.	5	0	
Collet, G. B. Esq.	5	0	
Cortis, Mr. A.	5	0	
Cripps, Mr. F.	5	0	
Cruse, Rev. F.	5	0	
Curry, Mrs.	1	0	0
Davey, Mrs.	5	0	0
Dawes, R. Esq.	1	0	0
Dawes, Mrs. (the Cottage)	5	0	0
Dodd, Mrs.	10	0	0
Edmunds, R. Esq.	5	0	0
E. I. R.	10	0	0
Elliott, Rev. E. K.	5	0	0
Ferguson, Miss	5	0	0
G. E. F.	5	0	0
Goldsmith, Dr.	5	0	0
Graham, T. G. Esq.	10	6	0
Green, F. Esq.	5	0	0
Green, M. Esq.	1	0	0
Gresson, Rev. J. G.	10	6	0
Grevett, Mr. R.	5	0	0
Hargood, Admiral.	1	0	0
Hargood, H. Esq.	1	0	0
Harris, W. J. Esq.	1	0	0
Harris, W. Esq.	10	6	0
Harrison, Mrs.	1	0	0
Henty, E. Esq.	5	0	0
Hill, J. Rowland, Esq.	10	0	0
Holmes, G. P. Esq.	10	6	0
Hopkins, H. Esq.	10	6	0
Loder, R. Esq. M.P.	1	0	0
Masters, J. K. L. Esq.	5	0	0
Maxwell, General	10	0	0
Morris, T. Esq.	5	0	0
Morton, Mrs.	5	0	0
Newland, the Misses	1	0	0
Nicholls, Mrs.	10	0	0
Parr, Rev. J. O.	5	0	0
Parry, Major.	5	0	0
Patching, Mr. E. C.	10	6	0
Patching, W. Esq.	10	6	0
Patrick, Rev. J. B.	5	0	0
Paul, H. Esq.	10	0	0
Potter, Mr. W.	5	0	0
Pryce, T. D. Esq.	5	0	0
Puckle, Mrs. R.	10	6	0
Purdon, Rev. J.	5	0	0
Roberts, Chas. Esq.	10	6	0
Roberts, Clarence, Esq.	5	0	0
Simpson, W. S. Esq.	5	0	0
Skindle, Mr. W.	10	6	0
Smart, H. Esq.	10	6	0
Smith, J. C. T. Esq.	10	6	0
Smith, Messrs. G. H. and Son	5	0	0
Stock, Misses.	10	0	0
Taylor, Mrs. C. B.	10	0	0
Thornton, A. J. Esq.	10	6	0
Traill, Miss.	10	0	0

Ullathorne, A. Esq.	5	0	
Unknown	5	0	
Vansittart, Vice-Admiral, C.B.	10	0	
Verrall, W. Esq.	5	0	
Verrall, W. F. Esq.	10	0	
Watson, J. L. Esq.	5	0	
Welsh, C. J. Esq.	5	0	
West, Mrs. P.	10	6	
Wickham, A. Esq.	5	0	
Wisden, Colonel	10	0	
Wood, Major M.	10	0	
Young, A. Esq.	1	0	0
Sum under 5s	2	6	0
<b>Total</b>	<b>37</b>	<b>19</b>	<b>6</b>

**Donations.**

Post Office Box	9	10	0
Pillar and Wall Boxes	4	7	3
<b>Total Dons</b>	<b>4</b>	<b>17</b>	<b>1</b>
<b>Total Subs.</b>	<b>37</b>	<b>19</b>	<b>6</b>

**£42 16 7**

**Warwickshire.**

**BIRMINGHAM BRANCH.**

**Chairman—**  
J. H. CHANCE, Esq.

**Honorary Secretaries—**  
Messrs. CHARLES and WILLIAM BARWELL.

**Annual Subscriptions.**

Avery, Mrs.	1	0	0
Baldwin, J. and Sons, Messrs.	2	2	0
Barclay, Hanbury, Esq.	1	0	0
Barwell, Chas. Esq.	1	0	0
Barwell, James, Esq.	1	0	0
Barwell, Wm. Esq.	1	0	0
Barwell, Miss	10	6	0
Cadbury, Joel, Esq.	1	0	0
Chamberlain, King, and Jones, Messrs.	1	0	0
Chance, J. H. Esq.	5	5	0
Chance, R. L. Esq.	5	5	0
Clay, John, Esq.	10	6	0
Collings, Alderman J., M.P. (Ex-Mayor)	1	0	0
Colmore, Mrs.	1	0	0
Corbett, Jno. Esq. M.P.	1	0	0
Crosbee and Sons, Messrs.	1	0	0
Cutler, T. Esq.	1	0	0
Davis, E. May, Esq.	10	6	0
Dew, Mrs.	1	0	0
Downing, S.	2	2	0
Ellis, & Sons, Messrs.	2	2	0
Finnemore, J. B. Esq.	1	0	0
Fitter, M. A.	1	0	0
Gilbert, J. Esq.	10	6	0
Gilbert, Mrs.	10	6	0
Griffiths & Browett, Messrs.	1	0	0
Heaton and Taylor, Messrs.	1	0	0
Heaton, G. Esq. J.P.	1	0	0
Heaton, G. (Solihull)	1	0	0
Heaton, H. Esq.	1	0	0
Hoerner, M. U. Esq.	1	0	0
Huggins, W. Esq.	1	0	0

**£. s. d.**

Jutson and Sons, Messrs.	1	1	0
Manton, H. Esq. J.P.	2	2	0
Oldham and Bower, Messrs.	1	0	0
Oslor, Mrs. C.	1	0	0
Padmore, J. Esq.	1	0	0
Price, Robt. & Co.	1	1	0
Simpson, F. R. & Co. Messrs.	1	1	0
Stevens, James, Esq.	1	1	0
Stokes, J. Esq.	1	1	0
Tangye Bros.	1	1	0
Tangye Bros. and Holman	1	1	0
Trydall, E. L. Esq.	1	1	0
Walker, S. Esq.	1	1	0
Whitefield, S. Esq.	1	1	0
Whitehouse, J. Esq.	1	1	0
Wilkes, G. Esq.	1	1	0
Wilkes, J. Esq.	1	1	0
Wilkes, John, Esq., Darlaston	10	6	0
Williams, J. Esq.	1	1	0
Williams, Mrs. J.	1	1	0
Williams, J. A. Esq.	1	1	0
<b>Total</b>	<b>65</b>	<b>0</b>	<b>0</b>

**Total**

**Donations.**

Balance of the Ingledy Life-boat Fund	3	15	0
Briggs, Mrs.	2	2	0
Christian, B.	1	0	0
Shorthouse, J. Esq.	10	6	0

**Total Dons**..... 7 8 6  
**Total Subs.**..... 65 0 0

**£72 8 6**

**Worcestershire.**

**ACOCK'S GREEN, YARDLEY, AND OLTON BRANCH.**

**Chairman—**  
J. BARROWS, Esq., J.P.

**Treasurer and Honorary Secretary—**  
REV. A. BUTLER, LL.D.

**Annual Subscriptions.**

ACOCK'S GREEN, Per Miss BARKER	£. s. d.
Atkin, Mrs.	5 0
Arnold, Mrs.	5 0
Bach, Mr.	5 0
Barker, Mr. J.	10 6
Barker, Mrs.	10 0
Barker, Mr. H.	5 0
Barker, Mr. T. B.	5 0
Dixon, Mrs.	5 0
Duke, Mr.	5 0
Duke, Mrs.	5 0
Fletcher, Mrs.	5 0
Hall, Miss	5 0
Handley, Mr.	5 0
Handley, Mrs.	5 0
Hodgkins, Mr.	1 0
Holroyd, Mr. E. B.	5 0
Hoskins, Mrs.	5 0
Hunt, Mrs.	5 0
Jefferys, Mr.	5 0
Kimpton, Mrs.	10 0
Kiss, Mr.	5 0
Marran, Mr.	5 0
Mellor, Mrs.	5 0
Neale, Mrs.	5 0
Pattison, Mr.	5 0

	£.	s.	d.
Phillips, Mrs.....	5	0	0
Walker, Mr.....	10	0	0
Ward, Mrs.....	5	0	0
Watts, Mr.....	5	0	0
Whitfield, Mr. A.....	5	0	0
Whitfield, Mrs. A.....	5	0	0
Whitfield, Mr. H.....	10	0	0
Whitfield, Mrs. H.....	5	0	0
Wilkins, Mrs.....	5	0	0
Sums under 5s.....	1	10	0

**Per Miss TOMKINS:—**

Boston, Mr.....	10	0	0
Dudley, Mrs.....	5	0	0
Butler, Rev. A.....	5	0	0
King, Mrs.....	5	0	0
Newey's, Mrs., Children.....	5	0	0
Yardley, Miss.....	5	0	0

**YARDLEY,**

per Miss WHITAKER:—  
Alston, Mrs. Elmdon

Hall.....	1	0	0
Barrows, Mr., J.P.....	1	0	0
Barrows, Mr. Jun.....	10	6	0
Biddle, Mr.....	5	0	0
Bullivant, Mrs.....	5	0	0
Cox, Mrs.....	5	0	0
Dalman, Mrs.....	5	0	0
Dodd, Rev. F. S.....	5	0	0
Fenton, Mr.....	10	0	0
Hackett, Mr.....	10	0	0
Hedges, Mrs.....	5	0	0
Higginson, the Misses.....	5	0	0
Lichfield, Mrs.....	5	0	0
Madeley, Mrs.....	10	0	0
Onions, Mr. J. C.....	5	0	0
Pollack, Mrs.....	5	0	0
Ransome, Mr.....	5	0	0
Rosenbury, Mr.....	5	0	0
Shakespeare, Mrs. C.....	5	0	0
Shakespeare, Mr. W.....	5	0	0
Simms, Rev. G. H.....	5	0	0
Tangye, Mr., J.P.....	1	0	0
Whitaker, Mrs.....	1	0	0
Whitaker, Miss.....	5	0	0
Whitaker, Miss A.....	5	0	0
Sums under 5s.....	11	0	0

Total.....24 14 0

**Donations.**

ACOCK'S GREEN,  
per Miss BARKER:—  
A Friend.....

Jenkins, Mr.....	10	0	0
Sums under 5s.....	3	6	0

**Per Miss TOMKINS.**

Sums under 5s.....	2	6	0
--------------------	---	---	---

**YARDLEY,**

per Miss WHITAKER:—  
Fenton, Mr., L.-B. Box 1

Whitaker, Miss, L.-B. Box.....	1	1	6
--------------------------------	---	---	---

Total..... 3 19 10

**Collecting Cards.**

ACOCK'S GREEN,  
per Miss BARKER:—  
Jeffreys, Mr. B.....

Richards, Master W. 1	1	0	0
Sums under 5s.....	11	0	0

**YARDLEY,**

per Miss HOSKINS:—  
Biddle, Miss.....

Corah, Miss.....	2	10	0
Grice, Miss.....	14	2	0
Hoskins, Miss.....	7	6	0
Sums under 5s.....	11	8	0

Total..... 7 0 4

Total Subs.....24 14 0

Total Dons. .... 3 19 10

Collecting Cards 7 0 4

£35 14 2

**STECHFORD  
BRANCH.**

Treasurer and Hon. Sec.—  
Mr. WILLIAM MORGAN.

**Annual Subscriptions.**

	£.	s.	d.
Archer, Mr., Edg- baston.....	10	6	0
Baird, Miss, Dover.....	5	0	0
Bower, Misses, Knowle- chirm, Mr. J., Edg- baston.....	5	0	0
Clarke, Mr.....	10	0	0
Davis, Mrs. Bolton, Swereford Park..	1	0	0
Icke, Mrs.....	10	6	0
King, Mr. W. R., Birmingham.....	10	6	0
Lloyd, Miss, Lea- mington, collected by (6s. 6s.):—	4	0	0
Dartwell, Miss.....	4	0	0
Fretwell, Captain.....	5	0	0
Grimsdick, Mr. W.....	5	0	0
Goode, Mr. W.....	10	6	0
Heathcote, Miss.....	5	0	0
Ingall, Mr. W. H.....	1	0	0
Lloyd, Mrs. C.....	5	0	0
Lloyd, Mr. R.....	2	6	0
Lloyd, Miss H.....	10	0	0
Lloyd, Mr. C. B.....	2	6	0
L. J. W. H.....	5	6	0
Mactavish, Miss.....	10	0	0
Mathews, Rev. J. E.....	5	0	0
Metcalfe, the Misses 1	0	0	0
M. S.....	5	0	0
Tritton, Col.....	5	0	0
Tritton, Mrs.....	5	0	0
Maxwell, Miss, Bir- mingham.....	5	0	0
Morgan, Miss, Quarn- ndon.....	10	6	0
Morgan, Mr. W.....	10	6	0
Neal, Mr. J. R., Torquay.....	5	0	0
Pollack, Mrs.....	5	0	0
Ramsden, Mr.....	5	0	0
Riddell, Mr., Shen- stone Lodge.....	10	0	0
Smallwood, Mr.....	10	6	0

Total.....13 4 0

**Donations.**

Brittain, Mr. A. col. by 1	7	6	0
Greig, Miss, Enderby, Life-boat Box 1879, 1l. 5s.; 1880, 1l. 8s. 2	13	0	0
Hemus, Mr. Life-Boat Box, 1879.....	10	6	0
Morgan, Miss, and Newbold, Miss, Quarndon, Life- Boat Box.....	2	10	0
Annual Meeting, Readings, &c., by Mr. W. Morgan ..	1	16	7

Total..... 8 17 7

**Collecting Cards.**

Aston, Miss, Bir- mingham, 1879, 10s. 6d.; 1880, 10s. 6d. 1	1	0	0
Barton, Miss.....	5	6	0
Bradley, Miss Ada.....	15	8	0
Gwyther, Miss Shen- stone.....	6	0	0
Gwyther, Miss.....	6	0	0
Gwyther, Miss P.....	6	0	0
Gwyther, Miss M. F.....	6	0	0
Luff, Miss, Bristol.....	10	0	0
Smith, Miss Eva.....	5	0	0
Tomlinson, Miss.....	6	0	0
Tomlinson, Master.....	6	0	0
Wood, Misses.....	16	10	0

**QUARNDON.**

	£.	s.	d.
Newbold, Miss.....	10	3	0
Brasher, Miss.....	15	0	0
Cockin, Miss.....	3	6	0
Colman, Miss F.....	6	0	0
Ellin, Miss E.....	10	0	0
Hargreaves, Miss A. M.....	10	0	0
Marriott, Miss.....	16	0	0
Newbold, Miss Rose.....	13	0	0
Swingler, Miss A.....	10	6	0
Walton, Miss A.....	7	3	0
Welby, Miss.....	1	18	0

Total.....12 9 6

Total Subscriptions 13	4	0	
„ Donations.....	8	17	7
„ Col. Cards.....	12	9	6

£34 11 1

**WORCESTER  
BRANCH.**

Chairman—  
Capt. TINKLAR, R.N.

Treasurer—  
FRAS. SPOONER, Esq.

Honorary Secretary—  
F. W. SEAMAN, Esq.

**Annual Subscriptions.**

	£.	s.	d.
Allsopp, Sir Hy.....	1	0	0
Ames, Frederick.....	1	0	0
Amphlett, Rev.....	10	6	0
Beacroft, Rev. J.....	1	0	0
Binyon, Mrs.....	1	0	0
Cheshire, Rev. J. S.....	10	0	0
Clarke, Erlin, Esq.....	1	0	0
Clarke, Geo. Esq.....	1	0	0
Congreve, Julia.....	1	0	0
Cooper, J. D.....	5	0	0
Cox & Painter, Messrs.....	10	6	0
Dodd, Rev. Thomas.....	5	0	0
Dorville, Capt. J. W., R.N.....	1	0	0
Evans, E. B.....	1	0	0
Evans, E. W. Esq.....	1	0	0
Gresley, E. A. D.....	1	0	0
Hadley, E., Newport Hall, Joseph, Esq.....	10	6	0
Heaton, W. H. Esq.....	1	0	0
Holden, Mrs. Hylla.....	10	0	0
Hopkins, T. M. Esq.....	5	0	0
J. J. Miss.....	5	0	0
Jefferis, B. Esq.....	5	0	0
Jones, Henry, Esq.....	1	0	0
Lea, C. Wheeley, Esq.....	2	2	0
Lechmere, Sir E. A. H.....	1	0	0
Lugard, Rev. F. G.....	10	6	0
McNaught and Smith Martins, Miss.....	2	0	0
Mellor, Wm. Esq.....	10	0	0
Nicholas, Mrs.....	10	6	0
Perrins, J. D. Esq.....	1	0	0
Pidcock, Chas. Esq.....	1	0	0
Piercy & Co. Messrs 1	0	0	0
Reid, John, Esq.....	1	0	0
Rowlands, Rev.....	10	6	0
Rutland, Jos. Esq.....	10	6	0
Scott & Oram.....	10	6	0
Seaman, F. W.....	5	0	0
Shaw, David.....	10	6	0
Spooner, Fras. Esq.....	10	6	0
Stallard, Josh.....	1	0	0
Stallard, Lieut.-Col.....	1	0	0
Temple, Mrs. P.....	1	0	0
Turley & Co. Messrs.....	10	6	0
Walker, Hy. Esq.....	1	0	0
Williamson & Son.....	10	0	0
Box at the Hop Mar- ket Hotel.....	1	8	0
Box at the Bell Hotel.....	13	0	0

Total..... 39 4 6

**Yorkshire.****BRADFORD BRANCH**

Chairman—  
FREDK. PRIESTMAN, Esq.

Honorary Secretary—  
J. A. GODWIN, Esq.

**Annual Subscriptions.**

	£.	s.	d.
Ackroyd, W. & Co. Messrs.....	2	2	0
Albrecht & Fecht, Messrs.....	2	2	0
Alexander, E. & Son, Messrs.....	1	1	0
Ambler, Thos. & Son, Messrs.....	1	1	0
Anderton, Swithen & Sons, Messrs.....	2	2	0
Anonymous.....	5	0	0
Aykroyd, Chas. Esq.....	1	0	0
Aykroyd, Jno. Sen.....	1	0	0
Aykroyd, Jno. Jun.....	1	0	0
Baird, T. & M. Messrs.....	1	0	0
Beckenbach and Co. Messrs.....	1	0	0
Bell, E. & Co. Messrs 2	2	0	0
Berend and Rée, Messrs.....	3	3	0
Best, A. & Son, Messrs.....	10	6	0
Bottomley, M. Jun. and Co. Messrs.....	1	0	0
Bottomley, S. & Bros. Messrs.....	2	2	0
Briggs, Nath. Esq. J.P.....	1	0	0
Brown, George, Mr.....	10	6	0
Brown, Henry, Esq.....	1	0	0
Busfield, J. A. Esq.....	1	0	0
Chamberlin, Donner and Co. Messrs.....	1	0	0
Cohen, B. Esq.....	1	0	0
Collins, William, Esq.....	1	0	0
Cordingley, Arm- strong, and Co.....	1	0	0
Crabtree, Thos. Esq.....	1	0	0
Craven, Joseph, Esq.....	2	2	0
Ashfield, Thornton 1	1	0	0
Delius, D. & R. Messrs 1	0	0	0
Drake, N. Esq.....	1	0	0
Drummond, Jas. Esq.....	1	0	0
Drummond, Jno. Esq. 1	0	0	0
Fawcett, Richard, Esq. J.P.....	1	0	0
Firth, T. A. Esq.....	1	0	0
Firth, William, Esq.....	1	0	0
Forster, Rt. Hon. W. E., M.P.....	1	0	0
Foster, John & Son, Messrs.....	5	5	0
Fox and Whitley, Messrs.....	1	0	0
Garnett, Wm. & Co. Messrs.....	1	0	0
Getz and Co. Messrs 2	2	0	0
Gillies, Garnett, & Co. Messrs.....	1	0	0
Godwin, J. V. Esq. J.P.....	1	0	0
Goldsmith, P. & Co. Messrs.....	1	0	0
Gourlay Bros. Messrs. 10	6	0	0
Haggas & Sons, Jas. 2	2	0	0
Halstead, H. R. & Co. 1	0	0	0
Hargreaves, Jos. Esq. 1	0	0	0
Harrison and Single- ton, Messrs.....	1	0	0
Heilborn, Ferdinand, Esq.....	1	0	0
Henry & Co. Messrs. A. and S.....	3	3	0
Hertz, W. D. and Co. Messrs.....	1	0	0
Heyn, Franc. & Co. Messrs.....	1	0	0
Heyneman, Edw. Esq. 1	0	0	0
Hirst, H. S. Esq.....	1	0	0

Table listing names and amounts for the first column, including Hodgson, Geo. & Co., Hoffman, and others.

Table listing names and amounts for the second column, including Steinthal & Co., Messrs., and others.

Table listing donations for the second column, including Taylor, Mr., and Sundries.

BRIDLINGTON BRANCH.

Table listing names and amounts for the third column, including Barnby, F. W., Bedwell, F. A., and others.

Table listing names and amounts for the fourth column, including Filey Branch, Chairman, Henry Darley, Esq., and others.

Table listing names and amounts for the fifth column, including donations for the Filey Branch, including Sept. 6, Net proceeds.

Table listing names and amounts for the sixth column, including Flamborough Branch, Chairman, William Dyson, Jun., Esq., and others.

Table listing names and amounts for the seventh column, including Hornsea Branch, Chairman, William Dyson, Jun., Esq., and others.

Table listing names and amounts for the eighth column, including Haller, Heslop, George, Henson, W. K., and others.

Table listing names and amounts for the ninth column, including donations for the Huddersfield Branch, including A Friend, per Mr. A. Smithson.

Table listing names and amounts for the tenth column, including Huddersfield Branch, Honorary Secretary, J. A. Harrison, Esq., and others.



	£.	s.	d.
Fitch, J. J. & Son, Messrs.	1	1	0
Fraser, J. B. Esq.	10	6	
Gaines, Thomas, Esq.	5	0	
Galsworthy, R. Esq.	10	6	
Granger, Chas. Esq.	5	0	
Greenwood & Batley, Messrs.	1	1	0
Hall, William, Esq.	10	0	
Harrison and Co. Messrs. R.	1	1	0
Harvey & Reynolds.	1	1	0
Hathorn, Davey & Co., Messrs.	10	6	
Hebblethwaite Bros. Messrs.	1	1	0
Hepper and Sons, Messrs.	1	1	0
Hotham & Whiting, Messrs.	10	6	
Howitt & Pemberton, Messrs.	1	1	0
Hudswell, Clark, & Rodgers.	10	6	
Hyam & Co. Messrs. A.	1	1	0
Ingham, Wm. Esq.	1	1	0
Jowitz, John, Esq.	1	1	0
Joy, W. L. Esq.	10	6	
Kiton, Messrs. Jas. and Co.	2	2	0
Lambert, Wm. Esq.	10	6	
Lawson, Messrs. S. and Sons.	1	0	0
Ludolf, Herman.	1	1	0
McConnell, Messrs. A. and J.	10	6	
Maclea and March, Messrs.	1	1	0
Manning, Wardle, & Co. Messrs.	1	1	0
Marcant & Co., Messrs.	10	6	
Marshall & Snelgrove, Messrs.	1	1	0
Marshall, A. Esq.	2	2	0
Megeson, Geo. Esq.	10	6	
Metcalfe, G. Esq.	1	1	0
Middleton, Wm. Esq.	1	1	0
Milling (Partners).	1	1	0
Moorhouse & Co. Messrs.	1	1	0
Newstead, J. S. Esq.	10	6	
North, William, Esq.	1	1	0
Nusse, Thomas.	10	6	
Oxley, Henry, Esq.	1	1	0
Patent Woolen Cloth Co.	1	0	0
Pearson, J. T. Esq.	10	6	
Rayner, John, Esq.	1	1	0
Riley, H. W. Esq.	10	6	
Robinson, Joshua, Esq.	1	1	0
Schmitz, H. Esq.	5	0	
Shackleton, J. Esq.	10	6	
Smecton, W. Esq.	10	0	
Smecton and Co. Messrs. J.	1	1	0
Smith, Albert, Esq.	10	6	
Taylor, Bros. Messrs.	2	2	0
Taylor, Henry, Esq.	1	1	0
Tetley and Sons, Messrs. Joshua.	3	3	0
Town and Sons, Messrs. J.	1	1	0
Turner, R. B. Esq.	1	1	0
Turton, W. Esq.	5	0	
Urgubart, Mrs.	1	1	0
Walker, I. D. Esq.	10	6	
Wharmcliffe, Right Hon. Lord.	1	0	0
Wilson, Walker, and Co. Messrs.	1	1	0
Wood, T. M. Esq.	10	6	
Yewdall and Sons, Messrs. D.	1	1	0
York, John, Esq.	2	0	0
Boxes	17	3	
<b>Total</b>	<b>£91</b>	<b>5</b>	<b>3</b>

**RUNSWICK BRANCH**

Patron—  
The Most Noble the MARQUIS OF NORMANDY.  
President—  
C. M. PALMER, Esq.  
Honorary Secretary—  
Dr. J. V. LAVERICK.  
Annual Subscriptions.  
£. s. d.  
Chaloner, Admiral... 2 2 0  
Chomley, Mrs. H... 1 1 0  
Hildyard, Rev. H. S. I. O... 1 0 0  
Kerr, John, Esq... 10 6  
Laverick, Dr. J. V... 10 6  
Logan, W. Esq... 1 1 0  
Palmer, C. M. Esq... 3 3 0  
Stephens, Capt. D. W... 10 6  
Webster, Robt. Esq... 10 6  
**Total**.....10 9 0

**SCARBOROUGH BRANCH.**

Chairman—  
PRESIDENT OF TRINITY HOUSE.  
Treasurer—  
J. W. WOODALL, Esq.  
Honorary Secretaries—  
JOHN STEPHENSON, Esq.  
A. E. HICK, Esq.  
Annual Subscriptions.  
Alderson-Smith, G. Esq. .... - 10 0  
Blunt, Ven. Arch-deacon. .... - 5 0  
Bottomley, Miss. .... - 5 0  
Bright & Sons. .... - 5 0  
Burland, Miss. .... 1 0 0  
Caine, W. S. Esq. M.P. 2 0 0  
Calvert, F. W. Esq. .... - 5 0  
Cankrien, Miss. .... - 5 0  
Cathcart, Earl. .... 1 0 0  
Collinson, R. Esq. .... - 5 0  
Craven, Miss Mary. .... - 5 0  
Cros, Dr. .... - 5 0  
Denby, Jesse, Esq. .... - 5 0  
Ellershaw, R. J. Esq. 1 1 0  
Forster, H. H. Esq. .... 1 1 0  
Forster, R. Esq. .... - 5 0  
Fowler, Benj. Esq. .... - 5 0  
Gratton, Colonel. .... - 5 0  
Hamerton, Rev. C. .... - 10 0  
Harrison, Mrs. .... - 10 0  
Hebden, Wm. Esq. .... 1 1 0  
Hemsworth, B. Esq. .... - 10 0  
Hick, M. Esq. .... - 5 0  
Hick, P. Esq. .... - 5 0  
Hick, T. Esq. .... - 5 0  
Holroyd, Miss Eliz. 1 1 0  
Holroyd, Miss Emma 1 1 0  
Hudson, G. and H. & Co. .... - 5 0  
Hugill, Mr. Thos. .... - 5 0  
Ingils, Major. .... - 10 0  
Jack, Miss. .... - 10 0  
Jackson, Geo. Esq. .... 1 0 0  
Johnstone, Sir Harcourt, Bart. .... 2 2 0  
Lea, George, Esq. .... - 5 0  
Leigh, Hon. Augusta - 5 0  
Marshall, Mrs. .... - 10 0  
Morris, R. M. & Co. - 5 0  
Newton, E. H. Esq. .... - 10 0  
Owen, R. Esq. .... - 10 0  
Parkinson, A. Esq. .... 1 1 0  
Peacock, C. J. Esq. .... - 10 0  
Petrie, Mrs. .... - 5 0  
Porrett, G. Esq. .... - 5 0  
Reed, Mr. .... - 5 0  
Robinson, Colonel. .... - 5 0  
Rodham, Mrs. J. .... - 10 6  
Rowntree, J. Esq. .... - 10 6  
Rowntree, W. Esq. .... - 10 6  
Sarony, Mrs. .... - 5 0

£. s. d.  
Stitwell, Lady. .... - 5 0  
Stead, Samuel, Esq. .... - 5 0  
Stephens, T. B. Esq. .... - 10 6  
Teale, J. W. Esq. .... - 5 0  
Thaakstone, S. W. & Co. .... - 5 0  
Tindall, Mrs. .... - 10 6  
Tindall, Mrs. R. H. .... - 10 0  
Tindall, John, Esq. .... 1 1 0  
Uppley, Mrs. .... - 10 0  
Vassalli, Mr. J. .... - 5 0  
Wales, Miss. .... - 5 0  
Walker, H. Esq. .... - 5 0  
Ward, Rev. G. A. .... - 5 0  
Weddell, Mrs. .... - 5 0  
Whittaker, Mr. T. .... - 5 0  
Wintle, Miss. .... - 5 0  
Woodall, J. W. Esq. .... 1 1 0  
Wortley, Hon. F. S. .... - 10 0  
Wray, Mrs. .... - 5 0  
Sums under 5s. .... 1 17 6  
**Total** .....35 15 6

Donations.  
A. H. Y. .... - 5 0  
Ashton, John W. Esq., Newton Lodge, Cheshire. .20 0 0  
Banks, Mrs. .... - 10 0  
Barton, Mrs. .... 1 0 0  
English, Mrs. E. .... 1 0 0  
F. R. E. .... - 10 0  
Gordon, F. Esq. .... - 5 0  
Haddon, F. J. Esq. 2 0 0  
Hatton, Mrs. .... - 5 0  
Hatton, J. Esq. .... 2 0 0  
Hawkins, H. Esq. .... - 5 0  
Hay, Lady. .... - 4 6  
Hunt, Miss. .... - 5 0  
Kerslake, Mr. .... - 5 0  
Langdale, W. Esq. .... - 5 0  
Magician. .... 1 1 0  
Mer, W. C. Esq. .... 1 0 0  
Morphew, J. B. Esq. - 7 6  
Mosley, Miss. .... 1 0 0  
Pegg, J. T. and S. .... - 7 6  
Rudgard, R. Esq. .... - 10 0  
Singlehurst, R. Esq. - 5 0  
Singlehurst, Miss. .... - 6 0  
Spence, R. Esq. .... - 5 0  
Visitor, 10 Prince of Wales Terrace - 10 0  
Waddington, W. A. - 5 0  
Walker, Wm. .... - 5 0  
Watson, Miss. .... - 5 0  
Watkins, Miss H. .... - 10 0  
Whitfield, John, Esq. - 5 0  
Wilkinson, Oscar, Esq. .... - 10 0  
Wintie, Miss. .... - 5 0  
Woodall, Mrs. .... 1 0 0  
Sums under 5s. .... 27 12 2

Cards.  
60 Eastborough .... - 9 6  
Mrs. Porters .... - 10 6  
Boxes.  
Boat-house Box .... 7 14 9  
Pillar Box, Esplanade 5 13 2  
Old Cliff. 2 13 0  
Railway Station Box 4 4 7  
Mr. Wray's, box at. - 5 0  
Smaller sums .... - 3 7

Hotels.  
Brunswick Hotel. .... - 17 0  
Bull Hotel. .... 1 10 0  
Cambridge Hotel. .... 5 2 6  
Castle Hotel. .... - 13 0  
Crown Hotel. .... 21 14 0  
Pavilion Hotel. .... 3 1 0  
Prince of Wales Hotel 5 18 6  
Swift's Hotel. .... 5 0 1  
Wetherall's Boarding House. .... - 7 6  
**Total Dons.** ..131 5 4  
**Total Subs.** .. 35 15 6  
**£167 0 10**

**SETTLE BRANCH.**

President—  
WALZ MORRISON, Esq.  
Honorary Secretary—  
C. BROWN, Esq.  
Annual Subscriptions.  
£. s. d.  
Abbotson, Chas. Esq. 1 1 0  
A Friend. .... - 5 0  
A Friend. .... - 5 0  
Alcock, Wm. Esq. .... 1 1 0  
Ambler, Mr. .... - 5 0  
Armistead, Mr. H. .... - 5 0  
Batten, Mrs. .... - 10 0  
Battersby, Miss. .... - 5 0  
Birkbeck, John, Esq. 1 1 0  
Birkbeck, J. John, Esq. 1 0 0  
Birkbeck, Jos. Esq. .... 1 1 0  
Birkbeck, Capt. R. S. 1 1 0  
Boyd, Rev. Canon. .... - 10 0  
Brayshaw, Mrs. .... - 10 6  
Brayshaw, T. Esq. .... 1 1 0  
Brennand, Mrs. .... - 5 0  
Brockbank, Mr. E. .... - 5 0  
Bromley, Mr. John. .... - 10 0  
Brown, Chris. Esq. .... 2 2 0  
Bryning, Miss E. M. .... - 5 0  
Burrow, Mrs. the late - 10 6  
Butterfield, Mr. John - 5 0  
Chamley, Mr. W. .... - 5 0  
Charlesworth, C. H. Esq. .... 1 1 0  
Christie, Hector, Esq. 2 2 0  
Clapham, T. R. Esq. .... 1 1 0  
Clark, Mr. .... - 10 0  
Clayton, Miss. .... 1 1 0  
Clayton, Mrs. .... 1 0 0  
Conlthurst, Rev. W. H. .... - 10 0  
Craven Bank Compy. 2 2 0  
Crossley, Mrs. .... 1 1 0  
Dawson, W. Moseley, Esq. .... 1 1 0  
Deighton, Chris. Esq. (the late) .... - 5 0  
Delves, Mr. G. .... - 10 0  
Dodd, Wm. Esq. .... - 5 0  
Ducket, Mr. R. .... - 5 0  
Ellis, Mr. Francis. .... - 10 0  
Foster, John, Esq. .... - 10 0  
Foster, Miss, Settle. - 10 0  
Foster, Mrs. E. T. .... - 10 0  
Foster, Mrs. J. W. .... 1 1 0  
Fo-ter, W. Esq., Westward Pk. .... 1 0 0  
Gibson, Mr. G. H. .... - 5 0  
Gill, Mrs. .... 1 1 0  
Gollard, Mrs. .... 1 0 0  
Gore, Mr. H. .... - 5 0  
Grime, Mr. R. .... 1 0 0  
Grisedale, Mrs. .... - 5 0  
Hamerton, John, Esq. 1 1 0  
Hammond, J. Esq. .... 1 0 0  
Hammond, Miss. .... - 10 0  
Hammond, Mrs. .... - 5 0  
Handby, Mr. John. .... - 5 0  
Hargraves, John, Esq. - 5 0  
Hargraves, Mr. T. .... 1 0 0  
Hartley, James, Esq. - 10 6  
Hartley, Mr. Jas. .... - 5 0  
Hartley, John, Esq. .... - 10 0  
Hartley, Robt. Esq. .... - 10 0  
Harvey, Mr. Thos. .... - 5 0  
Hawkins, Mr. .... - 10 0  
Hick, Edw. Esq. .... - 10 6  
Hird, Mr. A. .... - 5 0  
Holden, Mr. T. .... - 10 0  
Hoigate, Miss. .... - 10 0  
Hoigate, T. Esq. (B.) - 10 0  
Hoigate, T. Esq. (N.H.) .... 1 0 0  
Hook, Sergeant. .... - 5 0  
Hornor, Mr. Thos. .... - 5 0  
Howarth, Mr. Jas. .... - 5 0  
Howarth, Mr. Wm. .... - 5 0  
Hubble, Wm. Esq. .... (the late) .... 1 1 0  
Hunter, Mr. Wm. .... - 5 0  
Ingham, Mr. W. .... - 5 0  
Ingleby, Chris. Esq. 1 1 0

**BRANCHES—LIST OF ANNUAL SUBSCRIPTIONS AND DONATIONS. 363**

<b>de Maine, Miss</b> ..... - 15 0		<b>Wilson, Hawksworth,</b>		<b>Coatham Pier</b> ..... 1 7 9	
<b>de Gornall, Mr. James</b> ..... - 5 0		<b>Ellison, and Co.</b> ... 1 1 0		<b>Middlesbro', shipping</b> 9 9 0	
<b>Hartley, Mr. J. Audley</b> ..... - 10 6		<b>Wilson, Thomas</b> ... 1 1 0		<b>Redcar, small sums</b> ... - 7 2	
<b>Holden, Mr. T.</b> ..... - 10 6		<b>Wostenholm, Mrs. G.</b> 2 2 0		<b>Do. Boat-house</b> ..... - 10 3	
<b>Holmes, Mr. T.</b> ..... - 10 6		<b>Wright, John</b> ..... - 10 6		<b>Do., Pillar</b> ..... - 17 6	
<b>Jackson, Geo. Esq.</b> 1 0 0		<b>Total</b> ..... 47 19 6		<b>Total Dons</b> ..... 12 11 8	
<b>Just, Miss</b> ..... - 10 0		<b>Donaton.</b>		<b>SALTBURN STATION.</b>	
<b>McCounell, Mr. H.</b> ... - 7 6		<b>Webster, Wm.</b> ..... 2 2 0		<b>Honorary Secretary—</b>	
<b>Routh, Rev. C.</b> ..... - 10 6		<b>£50 1 6</b>		<b>Mr. T. G. PEARSON.</b>	
<b>Slinger, Miss M. M.</b> ... - 5 0		<b>STAITHES BRANCH.</b>		<b>Annual Subscriptions.</b>	
<b>Slinger, Mr. John</b> ... - 5 0		<b>President—</b>		<b>Cass, W. E. Esq.</b> ... - 10 0	
<b>Spencer, Mr. John</b> ... - 5 0		<b>C. M. PALMER, Esq., M.P.</b>		<b>Collidge, Mr. G.</b> ... - 10 0	
<b>Stackhouse, Miss</b>		<b>Chairman—</b>		<b>Clayton, Mr. D.</b> ... - 5 0	
<b>(B. E.)</b> ..... - 10 0		<b>GEORGE BROTCHE, Esq.</b>		<b>Dickinson, T. Esq.</b> ... - 10 0	
<b>11 Dons. at 2s. 6d.</b> ... 1 7 6		<b>Honorary Secretary—</b>		<b>Fox, F. Esq., J.P.</b> ... 1 1 0	
<b>Small Sums</b> ..... - 4 5		<b>Dr. J. V. LAVERICK.</b>		<b>Gilbertson, Mr.</b> ... - 10 0	
<b>Small Sums (per</b>		<b>Annual Subscriptions.</b>		<b>Harrison, W. E. Esq.</b> ... - 5 0	
<b>J. W. E.)</b> ..... - 5 0		<b>Brochie, George, Esq.</b> ... - 10 6		<b>Irvin, Rev. B.</b> ..... - 10 0	
<b>Total Dons</b> ..... 14 1 0		<b>Hon. Secretary</b> ..... - 10 6		<b>l'Anson, W. Esq.</b> ... - 5 0	
<b>Total Subs.</b> ..... 106 2 0		<b>Laverick, Capt. G.D.</b> ... - 10 6		<b>Lazenby, Mr. G.</b> ... - 10 0	
<b>£120 3 0</b>		<b>Palmer, C. M. Esq.,</b>		<b>Melliship, Mr. W.</b> ... - 10 6	
<b>Earlier Donations.</b>		<b>M.P.</b> ..... 3 3 0		<b>Ollivaunt, Mr. C.</b> ... - 10 0	
<b>A Friend (1875)</b> ..... 0 0		<b>Ryder, Mr. William</b> ... - 10 6		<b>Pearson, Mr. T. G.</b> ... - 10 0	
<b>Atkinson, Miss (Legacy</b>		<b>Robinson, Capt. J. J.</b> ... - 10 6		<b>Peacock, Mr. J.</b> ... - 5 0	
<b>1879)</b> ..... 19 19 0		<b>Spinks, Mr. Jas.</b> ... - 10 6		<b>Rhodes, G.S. Esq., M.D.</b> ... - 10 0	
<b>Brown C. Esq. (1869-</b>		<b>Verrill, Mr. Josh.</b> ... - 10 6		<b>Rapp &amp; Sons, Messrs.</b> ... - 10 0	
<b>70)</b> ..... 12 12 0		<b>Waddell, John, Esq.</b> 2 2 0		<b>Simpson, J. C. Esq.</b> ... - 5 0	
<b>Do (1875-6-7-8-9)</b> 525 0 0		<b>Total</b> ..... 8 18 6		<b>Taylor, G. Esq.</b> ... - 10 0	
<b>Farrer, J. Esq. (the</b>		<b>Donations.</b>		<b>Thubron, Mr. W.</b> ... - 5 0	
<b>late) (1866-8)</b> ... 30 0 0		<b>Black Lion Hotel</b> ... - 7 4		<b>Walker, W. Esq.</b> ... - 10 6	
<b>Foster, Mr. G.H. (the</b>		<b>Golden Lion Hotel,</b>		<b>Yeoman, Rev. Canon</b> 1 0 0	
<b>late, 1866-9-70)</b> ... 17 17 0		<b>Lofters</b> ..... - 5 0		<b>Zetland, The Earl</b> ... 5 0 0	
<b>Hardacre, Mrs. T.</b>		<b>Small Sum</b> ..... - 1 6		<b>Sums under 5s.</b> ... - 18 0	
<b>(the late, 1875)</b> ... 20 0 0		<b>£9 12 4</b>		<b>Donations.</b>	
<b>Hearn, Mrs. (the late)</b>		<b>TEES BAY BRANCH.</b>		<b>Ayrton, W. S. Esq.,</b>	
<b>1876-7-8-9)</b> ... 31 10 0		<b>Patron—</b>		<b>J.P.</b> ..... 1 0 0	
<b>Holgate, John (the</b>		<b>The EARL OF ZETLAND.</b>		<b>Hudson, — Esq.</b> ... - 10 6	
<b>late) Legacy</b> ... 400 0 0		<b>President—</b>		<b>Daniels, Mr., box</b> ... - 8 0	
<b>Jackson, John</b> ... 33 6 8		<b>JOSEPH W. PEARSE, Esq., M.P.</b>		<b>Queen's Hotel, do.</b> ... - 8 1	
<b>Knowles, T. F.</b> ... 10 10 0		<b>Treasurer—</b>		<b>Zetland Hotel, do.</b> ... - 9 4	
<b>Pierson, John E. Esq.</b> 5 0 0		<b>EDMUND BACKHOUSE, Esq.</b>		<b>Pillar Boxes, &amp;c.</b> ... 19 15 10	
<b>Preston, Miss J.</b> ... 5 0 0		<b>Honorary Secretary—</b>		<b>£38 11 9</b>	
<b>Procter, Thos. Esq.</b> 33 6 8		<b>MATTHEW MURRAY, Esq.</b>		<b>WAKEFIELD BRANCH.</b>	
		<b>Annual Subscriptions.</b>		<b>Honorary Secretary—</b>	
		<b>Backhouse, E. Esq.</b> 1 1 0		<b>HENRY ROBINSON, Esq.</b>	
		<b>Barrow, Rev. Jas.</b> ... 1 1 0		<b>Annual Subscriptions.</b>	
		<b>Bell Brothers &amp; Co.</b> ... 6 6 0		<b>Aked, R. G.</b> ..... - 10 6	
		<b>Bolckow, Carl</b> ... 1 1 0		<b>Alder, Thos. and Son</b> - 10 6	
		<b>Bolckow, Vaughan,</b>		<b>Alder, Thomas</b> ... - 10 6	
		<b>&amp; Co.</b> ..... 2 2 0		<b>Baker, William</b> ... - 10 0	
		<b>Chaloner, Admiral</b> 2 2 0		<b>Barker, Major</b> ... 1 1 0	
		<b>Craddock, J. Esq.</b> ... 1 1 0		<b>Binks, John</b> ..... - 10 6	
		<b>Dodds, Joseph, M.P.</b> 1 1 0		<b>Boston, Broughton</b> ... - 10 6	
		<b>Dorman, Long, &amp; Co.</b> 1 1 0		<b>Briggs, Archibald</b> ... 2 2 0	
		<b>Fallows, W. Esq.</b> ... 1 1 0		<b>Brigs, Mrs. Marianne</b> 2 0 0	
		<b>Lowther, Sir C. H., Bt.</b> 2 0 0		<b>Brown, John</b> ..... - 5 0	
		<b>Morehead, Rev. G. J.</b> - 10 0		<b>Bruce, Samuel</b> ... - 10 6	
		<b>Owners of Middles-</b>		<b>Charlesworth, J. Barff</b> 1 1 0	
		<b>borough Estate</b> ... 2 2 0		<b>Child, Rowland</b> ... - 10 0	
		<b>Pearse &amp; Co. Messrs.</b> 1 1 0		<b>Clarks, Henry</b> ... - 10 0	
		<b>Pease, J. N. Esq., M.P.</b> 2 2 0		<b>Coates, J. H.</b> ..... - 10 0	
		<b>Richardson, Duck, &amp;</b>		<b>Crowther, Mary Anne</b> 1 0 0	
		<b>Co., Messrs.</b> ..... 1 1 0		<b>Dixon, J. H.</b> ..... - 10 6	
		<b>Samuelson, B. &amp; Co.</b> 2 2 0		<b>Dunns and Co.</b> ... 1 1 0	
		<b>Swan, J. E. &amp; Bros.</b> 2 2 0		<b>Grace, William</b> ... - 10 0	
		<b>Tees Conservancy</b>		<b>Graham, C. E.</b> ..... - 10 0	
		<b>Commissioners</b> ... 3 3 0		<b>Green, Edward</b> ... 1 1 0	
		<b>Trevor, W. C. Esq.</b> 1 0 0		<b>Hall, J. T.</b> ..... - 5 0	
		<b>Walker, D. H. &amp; Co.</b> 1 1 0		<b>Holdsworth, Richard</b> 1 0 0	
		<b>Watson &amp; Co. James</b> 1 1 0		<b>Holdsworth, J. Hulme</b> 1 1 0	
		<b>Watson, R., Exors.</b> ... 1 1 0		<b>Holdsworth, S. M.D.</b> - 10 6	
		<b>Wharton, J. T. Esq.</b> 2 2 0		<b>Kirkgate Station Box</b> 1 3 7	
		<b>Whitwell, W. &amp; Co.</b> 1 1 0		<b>Leatham, S. G.</b> ... 1 0 0	
		<b>Total</b> ..... 41 8 0		<b>Leatham, Claude</b> ... 1 1 0	
				<b>Lee, Geo. and Sons.</b> ... 1 1 0	
				<b>Mackie, R. Bownas.</b> ... 1 1 0	

Mackie, Mrs. John	1	1	0
Mander, George	10	0	0
Masterman, John	10	0	0
Micklethwaite, Mrs.	1	0	0
Micklethwaite, Mrs.	1	0	0
James	5	0	0
Robinson, Henry	1	0	0
Rogers, Rev. S.	5	0	0
Shaw, Mrs. Isaac	10	0	0
Smith, Henry	1	0	0
Stanfield, A. W.	10	0	0
Stewart, William	1	0	6
Tew, Percy	1	0	0
Tew, Herbert S.	1	0	0
Tomlinson, W. H. B.	1	0	0
Willis, Alan	10	0	0
	<b>£35</b>	<b>12</b>	<b>1</b>

**WHITBY AND UP-GANG BRANCHES.**

Honorary Secretaries—  
E. W. CHAPMAN, Esq.  
MR. ROBERT GIBSON.

**Annual Subscriptions.**

Atkinson, Mr. Thos.	2	6	0
Attlay, Mrs.	5	0	0
Austen, Rev. G.	5	0	0
Barker, J. Esq.	5	0	0
Barrick, H. Esq.	10	0	0
Barry, Capt. J. H.	5	0	0
Belcher, T. W. Esq.	10	0	0
Brewster, Mrs. John	10	0	0
Booth, Mrs.	1	0	0
Boulby, Rev. A.	5	0	0
Brown, Mrs.	5	0	0
Buchanan and Son.	5	0	0
Chapman, E. W. Esq.	1	0	0
Cholmley, Mrs.	1	0	0
Clarkson, Jas. & Son	5	0	0
Cohen, A. D.	10	0	0
Collier & Son, Messrs.	5	0	0
Corner & Marr, Messrs.	5	0	0
Corney, Mr.	5	0	0
Ellerby, Mrs.	5	0	0
English, A. W. Esq., J.P.	1	1	0
Farrow, Rev. J. R.	5	0	0
Fisher, Mr. Charles	5	0	0
Gibson, Mr. Robt.	5	0	0
Gray & Partners	10	0	0
Harrison, C. Esq.	5	0	0
Harrowing, Mr. Robt. Hayes & Falking-bridge, Messrs.	5	0	0
Hewson, Miss	5	0	0
Holder, J. W. Esq.	1	1	0
Horne & Son, Messrs.	5	0	0
Jameson, Miss	5	0	0
Jones, Capt. Thos.	5	0	0
Knaggs, G. T. Esq.	5	0	0
Langborne, Misses	5	0	0
Laingdale and Sons	5	0	0
Laycock, Rev. J. A.	5	0	0
Leng, J. H.	5	0	0
Marwood and Sons	10	6	0
Maule, Mr. J. D.	5	0	0
Maw, Mr. N.	5	0	0
Mead, Dr.	5	0	0
Mennel, Thos.	5	0	0
Moorson, Mrs.	1	0	0
Nicholson, Mr. J. B.	5	0	0
Pannett, R. E. Esq.	5	0	0
Patchett, Rev. W. H.	5	0	0
Pearson, B. Esq.	5	0	0
Pearson, Thos. Esq.	5	0	0
Pease, A., M.P.	1	0	0
Pease, G. Esq.	5	0	0
Richardson, C. Esq.	5	0	0
Richardson, F. Esq.	10	6	0
Richardson, Mrs. C.	10	0	0
Rothwell, Mrs.	5	0	0
Sanderson, Capt. W.	5	0	0
Sewell, Mr.	5	0	0
Simpson, Chapman & Co.	10	0	0
Smailes, Capt. Thos.	5	0	0

Smales Bros. Messrs.	10	0	0
Smales, G. W.	1	0	0
Smales, G. H. Esq.	5	0	0
Smallwood, D.	5	0	0
Smith, Mr. W. B.	5	0	0
Stevenson, Mr. J.	5	0	0
Stewart, Mr. John	5	0	0
Summerson, Capt.	5	0	0
Taylor, Mrs. H.	5	0	0
Tinley, Dr.	5	0	0
Thistlewaite, L.	5	0	0
Ton, John	5	0	0
Turnbull and Son	10	6	0
Turnbull Bros.	1	0	0
Usherwood, W. Esq.	5	0	0
Walker, Lieut. H.	10	6	0
Walker, J. C. Esq. J.P.	5	0	0
Walker, Rev. Canon I	1	0	0
Welghill, John & Son	5	0	0
Wharton, Capt.	5	0	0
White, Mr. John	5	0	0
Wright, Capt. Chas.	5	0	0
Wright, W. Esq.	10	0	0
Yeoman, Dr.	5	0	0
Yeoman, Mr. T. P.	5	0	0
Sums under 5s.	17	6	0
Total	32	17	0

**Donations.**

Clayhill, Lieut.-Col., J.P.	10	10	0
Crompton, Miss	10	0	0
Elliott and Lascelles, Misses	1	0	0
English, John Esq.	1	0	0
Jackson, Mrs. Thos.	1	0	0
Wakfield, Misses	11	6	0
Wilson, John, Esq.	1	0	0
Pillar and Collecting Boxes	8	13	11
Life-boat Sunday Collection	24	5	9
Total Dons	48	12	2
Total Subs.	81	9	2

**WITHERNSEA BRANCH.**

Honorary Secretary—  
H. H. AYBE, Esq.

**Annual Subscriptions.**

Allison, E.	5	0	0
Allison, Henry	5	0	0
Atkinson, J.	10	6	0
Ayre, H. H.	10	0	0
Bailey and Leatham	1	1	0
Broadley, W. H. H.	1	1	0
Brochner, C. C.	1	1	0
Chambers, W.	10	0	0
Champney, R.	1	1	0
Davis, Mrs.	1	1	0
Hewitson, Miss	1	1	0
Hildyard, J. G. B. T.	1	1	0
Holden, Thomas	1	1	0
Hutchinson and Son	1	1	0
Jackson, R.	1	0	0
Pease and Sons	1	1	0
Pugh, William	10	0	0
Ramsdale, J.	1	0	0
Seaton, J. L.	10	0	0
Smith Bros. and Co.	1	0	0
Straker, J. B.	10	0	0
Stephenson, Laurence	10	0	0
Swann, Capt.	1	0	0
Thompson, Mrs.	10	0	0
Trinity House, Hull	5	0	0
White, T. W.	10	6	0
Wilson, D.	1	1	0
Wilson, T., Sons & Co.	1	1	0
Young, James	1	1	0
Young, James, Jun.	10	0	0
Total	£28	6	0

**YORK BRANCH.**

Treasurer and  
Honorary Secretary—  
DR. DUNHILL.

**Annual Subscriptions.**

Acton, George, Esq.	10	6	0
Agar, Joseph, Esq.	10	0	0
Barnes, Mrs.	1	1	0
Bateman, Sam. Esq.	1	0	0
Cabry, Mrs.	10	6	0
Cadman, Wm. Esq., J.P.	1	1	0
Cartwright, Miss S.	2	2	0
Chapman, Wm. Esq.	1	1	0
Clarke, Rev. A. J., M.A.	5	0	0
Clayton, Mrs.	1	1	0
Clutton, Wm. J. Esq., J.P.	1	1	0
Cowling, Henry, Esq.	5	0	0
Creyke, Ralph, Esq., M.P.	1	1	0
Dimsdale, Miss Eliz.	1	1	0
Dunhill, C. H. Esq., M.D.	1	1	0
Dunhill, W.H.C. Esq.	1	1	0
Dyson, Mrs. Alice E.	1	1	0
Easley, Chas. Esq.	1	0	0
Farrar, Robert, Esq.	1	0	0
Felton, R. H. Esq.	10	6	0
Fenwick, R. H. Esq., J.P.	1	1	0
Fowler, Thos. N. Esq.	10	0	0
Gray, Miss	5	0	0
Harcourt, Egerton Vernon, Esq.	1	0	0
Hill, Edward, Esq.	1	1	0
Hill, John R. Esq.	1	1	0
Hodgson, Jos. Esq.	1	1	0
Hodgson, Mrs. Capt.	10	6	0
Jeffries, Julius, Esq.	5	0	0
Johnson, Rich. Esq.	10	0	0
Leak, Wm. Esq.	2	2	0
Leeaman, J. J. Esq., M.P.	1	1	0
Leetham, Henry, Esq.	1	0	0
Malcolm, Col. E. D.	1	1	0
Mason, Mrs. Sarah	1	1	0
Meek, Sir James, J.P.	10	0	0
Melrose, James, Esq.	10	0	0
Monkhouse, T. Esq.	10	0	0
Morrill, W. W. Esq.	5	0	0
Nettleton, Mrs.	10	0	0
Norcliffe, Mrs. R.	1	0	0
Pierson, Mrs. John	10	0	0
Rawdon, W. F. Esq.	1	0	0
Richardson, Hen. Esq.	1	0	0
Robinson, Mrs. E. A.	2	0	0
Rose, Rev. C. M.A.	5	0	0
Rowntree, Mrs. Sarah	1	0	0
Starkie, Capt. Ed. C.	1	1	0
Taylor, J. F. Esq.	10	6	0
Terry, Joseph, Esq., J.P.	10	6	0
Thompson, Luke, Esq.	5	0	0
Thorp, H. B. Esq.	1	1	0
Umpleby, G. W. Esq.	1	0	0
Wade, Jno. Esq.	5	0	0
Walker, Thos. Esq.	1	1	0
Walker, Wm. Tunlison, Esq., J.P.	1	1	0
Ware, Henry J. Esq.	10	0	0
Whitehead, George, Esq., J.P.	1	1	0
Whythead, W., Esq.	10	6	0
Wilberforce, W. W., Esq., J.P.	1	1	0
Wilkinson, Jos. Esq.	10	0	0
Williams, Mrs.	5	0	0
Wilson, G. Esq., J.P.	1	1	0
Yorke, Miss	1	0	0
Total	53	13	6

**Donations.**

Brown, Misses	10	6	0
Dunhill, Dr.	5	0	0
Spence, Mrs. Jemima (5th donation)	5	0	0

Lascelles, the Hon., Egremont	10	6	0
Lascelles, the Hon., Mrs. Egremont	10	6	0
Ellis, Thos. Esq.	5	0	0

Total Dons	16	11	0
Total Subs.	53	13	6

£70 4 6

**SCOTLAND.**

**Aberdeenshire.**

**ABERDEEN BRANCH.**

Chairman—  
THE LORD PROVOST OF  
ABERDEEN.

Honorary Secretary—  
A. D. MILNE, Esq.

**Annual Subscriptions.**

Aberdeen Steam Navigation Company	5	5	0
Adam, J. B.	1	1	0
Adam, Thos., Jun.	1	1	0
Aiken, James, Jun.	1	1	0
Anderson, Alex.	10	6	0
Begg, John	1	1	0
Black, Wm.	10	6	0
Clatto, Robert	1	1	0
Cook, John (Banker)	10	6	0
Copland, Alex.	10	6	0
Cran, P. M.	10	6	0
Davidson, George	10	0	0
Davidson, J. and A.	1	1	0
Duthie, Alex.	1	0	0
Duthie, Wm.	1	1	0
Duthie, Robt.	1	0	0
Fiddes, Edward	10	0	0
Edmond, Alex.	1	1	0
Edmond, Francis	2	0	0
Easlemont and Macintosh	1	1	0
Ferguson, Wm.	10	6	0
Gibson, Wm.	10	6	0
Gordon, Wm.	10	6	0
Grant, Wm.	10	0	0
Hall, Alex. and Co.	1	1	0
Harvey, Geo. T.	10	6	0
Henderson, Wm.	2	2	0
Horne, E. B.	1	1	0
J. F. L.	1	0	0
Jamieson, George	1	1	0
Leslie, Wm.	10	6	0
Ludwig, Chas. & Co.	10	6	0
Lumsden, Robt.	1	0	0
Macquoen, J. O.	1	1	0
Miller, John	1	0	0
Milne, John D. (1879-80)	2	0	0
Milne, Geo. (Banker)	10	6	0
Milne, Wm. (C.A.)	10	6	0
Nicol, Alex. and Co.	1	1	0
Pratt and Keith	1	1	0
Reid, John	1	0	0
Riddel, Peter	10	6	0
Rorie, George L.	1	1	0
Rust, John, and Son	1	1	0
Shipmaster's Society (1880-81)	4	4	0
Smith, Neil, Jun., and Co.	1	0	0
Stephen, Alex.	10	6	0
Thompson, Cornelius	2	2	0
Thompson, Geo. Jun.	3	3	0
Walker, Alex.	1	1	0
Webster, John	1	1	0
Wilson, Alex. H.	1	1	0
Yeats, Wm.	1	0	0
Small Sums	0	9	0
Total	59	5	3



BRANCHES—LIST OF ANNUAL SUBSCRIPTIONS AND DONATIONS. 365

	£.	s.	d.
<i>Donations.</i>			
Aberdeen, Rt. Hon.			
the Earl of,.....	10	0	0
Bon Accord Slate			
Merchant Comp. . .	1	1	0
Duthie, Wm. ....	1	1	0
Robertson's, Miss,			
Trustees, per F.			
Edmond, Esq.....	5	0	0
<b>Total Dons. . . . .</b>	<b>17</b>	<b>2</b>	<b>0</b>
<b>Total Subs. . . . .</b>	<b>59</b>	<b>5</b>	<b>3</b>
	<b>£76</b>	<b>7</b>	<b>3</b>

**CRUDEN BAY BRANCH.**

Patron—  
The Right Hon. the EARL of ERROLL,  
Treasurer—  
G. I. FRASER, Esq., M.D.  
Honorary Secretary—  
Mr. JAMES BODDIE.

	£.	s.	d.
<i>Annual Subscriptions.</i>			
Alcock, Mr. ....	1	5	0
Brown, Rev. Geo. . .	1	0	0
Earl of Erroll . . . .	5	0	0
Countess of Erroll . .	5	0	0
Brand, Mr. ....	7	6	
Duguid, Mr. ....	7	6	
Forbes, Keith, Esq. . .	10	0	
Moir, Mr. ....	10	0	
Murdock, Rev. P. J. . .	7	6	
Phillip, Mr. ....	10	0	
Ross, Rev. R. ....	10	0	
Russel Trust. ....	5	0	0
Shepherd, Jas. Esq. . .	1	0	0
Walker, Rev. Mr. . . . .	7	6	
Will, Misses. ....	7	6	
<b>Sums under 5s. . . . .</b>	<b>4</b>	<b>15</b>	<b>0</b>
<b>Total . . . . .</b>	<b>25</b>	<b>17</b>	<b>6</b>

**FRASERBURGH BRANCH.**

Patron—  
The Right Hon. the LORD SALTOUN.

Treasurer & Hon. Sec.—  
ANDREW TARRAS, Esq.

	£.	s.	d.
<i>Annual Subscriptions.</i>			
Anderson, Sir Alex. . .	1	1	0
Baird's Trustees . . . .	1	0	0
Clinton, Rt. Hon. Lord	2	0	0
Cordiner, W. F. Esq. . .	0	0	0
Forbes, Dr. O. . . . .	1	0	0
Fordyce, Mrs. . . . .	1	0	0
Fraserburgh Harbour			
Commissioners. . . . .	22	0	0
Gordon, Rear-Ad-			
miral, A.C. . . . .	1	0	0
Gordon, Wm. Esq. . . .			
Cairness. . . . .	2	0	0
Henderson, C.P. Esq. . .	1	1	0
Saltoun, Rt. Hon. Lord	5	5	0
<b>Total . . . . .</b>	<b>38</b>	<b>7</b>	<b>0</b>

	£.	s.	d.
<i>Donation.</i>			
Russel Trust . . . . .	5	0	0
<b>Total . . . . .</b>	<b>£43</b>	<b>7</b>	<b>0</b>

**NEWBURGH BRANCH.**

President—  
JOHN H. UDNY, Esq.  
Hon. Secretary—  
Mr. P. MURRAY.

	£.	s.	d.
<i>Annual Subscriptions.</i>			
Gordon, H. W. Esq. . . . .	2	0	0
(two years) . . . . .	5	0	0
Lumsden, Miss M. . . . .	5	0	0
Udny, J. H. Esq. . . . .	5	0	0
Udny, Mrs. . . . . .	2	2	0
Turner, Misses . . . . .	1	0	0
<b>Total . . . . .</b>	<b>15</b>	<b>2</b>	<b>0</b>

*Donations.*

Anderson, M. F. . . . .	10	0	0
Lumsden, W. H. . . . .	5	0	0
Russel Trust . . . . .	5	0	0
Collecting Box at Newburgh Bank . . . .	16	3	
Bank Interest . . . . .	2	4	
<b>Total Dons. . . . .</b>	<b>11</b>	<b>8</b>	<b>7</b>
<b>Total Subs. . . . .</b>	<b>15</b>	<b>2</b>	<b>0</b>
	<b>£26</b>	<b>10</b>	<b>7</b>

**PETERHEAD BRANCH.**

Treasurer—  
WM. BAXTER, Esq.  
Honorary Secretary—  
WILLIAM BOYD, Esq., F.R.S.E.

	£.	s.	d.
<i>Annual Subscriptions.</i>			
Alexander, Mrs., Edinburgh. . . . .	10	6	
Arbutnot, Adam. . . . .	5	0	
Boyd, A. and W. . . . .	1	1	0
Bremner, T. J. . . . .	1	1	0
Cumine, Jas. Esq. of Rattray . . . . .	2	2	0
Ferguson, Colonel, of Pitfour . . . . .	2	0	0
G. M. . . . .	5	0	
Hutchison, E. . . . .	5	0	
Kidd, Robert, & Sons . . . .	13	0	
Mackintosh, John . . . .	5	0	
McCombie, James, and Co. . . . .	5	0	
Merchant Maiden Hospital of Edin- burgh. . . . .	3	3	0
Mitchell, William . . . .	5	0	
Peterhead Harbour Trustees, Amount Collected from Shipping . . . . .	19	3	0
Proceeds from Satur- day Evening Ent- ertainment . . . . .	3	3	0
Russel, Misses, Trus- tees . . . . .	5	0	0
Scott and Leslie . . . .	5	0	0
Stephen and Hay . . . .	5	0	0
<b>Sums under 5s. . . . .</b>	<b>4</b>	<b>4</b>	<b>0</b>
<b>Total . . . . .</b>	<b>£44</b>	<b>0</b>	<b>6</b>

**WHITELINK BAY BRANCH.**

President—  
Rev. W. WILLIAMSON.  
Honorary Secretary—  
Mr. A. J. BIRNIE.

	£.	s.	d.
<i>Annual Subscription.</i>			
Cordiner, W. F. Esq. . . . .	1	0	0
<i>Donations.</i>			
A. J. B. . . . .	5	0	0
Charlestown Villagers . . . .	9	6	
Cheeson, Wm. Esq. . . . .	5	0	0

	£.	s.	d.
Cordiner, W. F. Esq. . . . .	1	0	0
Duthie, Mrs. Matilda . . . .	1	1	0
Laurence, Geo. Esq. . . . .	5	0	
Lawrence, W. J. Esq. . . .	10	0	
Marr, Thos. Esq. . . . .	5	0	
Milne, J. H. Esq. . . . .	10	0	
Russel Trust . . . . .	5	0	0
St. Combs Villagers. . . . .	2	18	5
Small Sums . . . . .	1	2	3
<b>Total . . . . .</b>	<b>£14</b>	<b>11</b>	<b>2</b>

**Argyllshire.**

**CAMPBELTOWN AND SOUTHD (CANTYRE) BRANCH.**

Patron—  
His Grace the DUKE OF ARGYLL, K.T., V.P.

President—  
PROVOST GREENLEES.  
Honorary Secretary—  
Mr. A. MITCHELL,  
H. M. Customs.

	£.	s.	d.
<i>Annual Subscriptions.</i>			
Argyll, His Grace the Duke of, K.T., V.P. . . . .	5	0	0
Boyd, Mr. J. C. . . . .	5	0	0
Brown & Co. Messrs. T. . . . .	10	0	
Buchanan, Col. R. A. . . . .	2	0	0
Campbell, Capt. J. C. R.N. . . . .	1	0	0
Campbell, Miss McNeill . . . . .	1	0	0
Campbeltown Har- bour Trustees . . . . .	5	0	0
Colville and Son, Messrs. A. . . . .	5	0	
Colville, David, Esq. . . . .	5	0	
Colville, Duncan, Esq. . . .	5	0	
Dundas, Sheriff. . . . .	10	0	
Dunlop, James, Esq. . . . .	5	0	
Ferguson, Duncan, Esq. . . . .	5	0	
Galbraith & Cochrane . . . .	5	0	
Galbraith, John, Esq. . . . .	1	0	0
Gibson, Dr. M.D. . . . .	10	0	
Greenlees, Alex. Esq. . . . .	5	0	
Greenlees, C. C. Esq. Provost . . . . .	1	0	0
Greenlees, Dan. Esq. . . . .	10	0	
Greenlees, J. W. Esq. . . . .	5	0	
Greenlees, Robt. Esq. . . . .	10	0	
Greenlees, Sam. Esq. . . . .	10	0	
Hall, James M. Esq. . . . .	1	0	0
Lord, Simeon . . . . .	5	0	
Mackay, Major . . . . .	1	0	0
Mackinnon, P. Esq., Devaar . . . . .	1	0	0
Mackinnon, P. Esq., Rosemount . . . . .	1	0	0
Mactaggart, C. Esq. . . . .	10	0	
McAlister, Keith, Esq. . . . .	1	0	0
McAlister, Mrs. K. . . . .	1	0	0
McCallum, Duncan, Esq. . . . .	5	0	
McDonald, D.W. Esq. . . . .	5	0	
McGibbon, D. Esq. . . . .	10	0	
McIntyre, L. Esq. . . . .	5	0	
McKersie, John, Esq. . . . .	5	0	
McKersie, W. Esq., Jun. . . . .	5	0	
McMillan & McSpor- ran, Messrs. . . . .	5	0	
McNair, W. Esq. . . . .	5	0	
McQueen & McKay. . . . .	5	0	
Mitchell, Alex. Esq. . . . .	5	0	
Muir, John, Esq. . . . .	10	0	
Murray, John, Esq. . . . .	5	0	
Russell, Rev. J. C. . . . .	10	0	
Scarlet, J. W. Esq. . . . .	1	0	0

Spinks, Mr. John. . . . .	5	0
Stewart, James, Esq. . . . .	10	0
21 sums under 5s. . . . .	2	10
<b>Total . . . . .</b>	<b>36</b>	<b>5</b>

*Donations.*

Custom House Box . . . . .	1	8	7
"Kinloch" . . . . .	6	4	
Southern Boat-house Box . . . . .	1	4	3
Sums under 5s. . . . .	6	6	
<b>Total . . . . .</b>	<b>£39</b>	<b>11</b>	<b>2</b>

**Ayrshire.**

**ARDROSSAN BRANCH.**

Honorary Secretary—  
JOHN MOFFAT, Esq.  
*Annual Subscriptions.*

	£.	s.	d.
Eglinton and Winton, The Earl of. . . . .	15	0	0
Anderson, Jno. Esq. . . . .	5	0	
Anderson, Jno. Esq. . . . .	5	0	
Bailey, Jas. L. Esq. . . . .	5	0	
Baird, W. and Co. . . . .	5	0	
Barr and Shearer . . . . .	1	1	0
Craig, John, Esq. . . . .	5	0	
Emmie, John, Esq. . . . .	10	0	
Finnie, A. and Son . . . . .	2	2	0
Gardner, Mrs. . . . .	1	1	0
Goodwin, Jas. and Co. 1	0		
Goodwin & Hogarth . . . .	5	0	
Guthrie, Alex. Esq. . . . .	5	0	
Halkett, J. G. Esq. . . . .	10	6	
Logan, John, Esq. . . . .	5	0	
McIsaac, James, Esq. . . . .	10	6	
Mack, D. J. Esq. . . . .	10	6	
Merry and Cuning- hame . . . . .	5	0	0
Moffat, John, Esq. . . . .	2	2	0
Muir, W. . . . .	5	0	
Robertson, Dr. . . . .	10	6	
Russell & Fullarton . . . .	1	1	0
Steel, Captain . . . . .	5	0	
Vernon, Hon. G. H. (5 years) . . . . .	5	5	0
Sums under 5s. . . . .	—	—	—
<b>Total . . . . .</b>	<b>£44</b>	<b>16</b>	<b>9</b>
Sundry Donations . . . .	1	6	9

**AYR BRANCH.**

Chairman—  
THOMAS STEELE, Esq.  
Provost of Ayr.

Honorary Secretary—  
JOHN POLLOCK, Esq.

	£.	s.	d.
<i>Annual Subscriptions.</i>			
Alexander, Colonel . . . . .	3	3	0
Baird, John, of Knoy- dart . . . . .	2	2	0
Baird, W. . . . .	2	0	0
Bell, John . . . . .	1	0	0
Campbell, E. F. F. . . . .	1	0	0
Coats, Sir Peter . . . . .	5	0	0
Cowan, Hugh . . . . .	1	0	0
Dykes, Rev. Dr. . . . .	10	0	
Flint & Son, William . . . .	5	0	
Gairdner, W. . . . .	1	0	0
Gemmell, T. M. . . . .	5	0	
Hamilton, Alexander . . . .	2	0	0
Hamilton, John, of Sundrum . . . . .	2	0	0
Hight & Son. . . . .	10	0	
Houldsworth, J. M. . . . .	1	0	0
Houldsworth, Wm. . . . .	2	0	0
Hunter, John . . . . .	1	0	0
McCreadie, George . . . . .	5	0	
McGavin, Mrs. . . . .	1	0	0

	£.	s.	d.
Mellwrath, John, Son & Co.	10	0	0
Mitchell, John	10	0	0
Morton, J. M. Mathie	1	0	0
Murdoch, R. D.	5	0	0
Oswald, R. A.	5	0	0
Paton & Sons, James	1	0	0
Smith & Son, Andrew	5	0	0
Steele, Thomas	10	0	0
Stewart, William	10	0	0
Taylor, J. and A.	10	0	0
Templeton, James, and Son	10	0	0
Young, J. and T.	10	0	0
<b>Total</b>	<b>38</b>	<b>0</b>	<b>0</b>

**Donations.**

	£.	s.	d.
Box at Life-boat House	8	8	8
Trustees of Wm. Tennant, of Eastonville	19	0	0
<b>Total</b>	<b>27</b>	<b>8</b>	<b>8</b>

**BALLANTRAE BRANCH.**

**Patron—**  
JAMES HUNTER, Esq., Glenapp.

**President—**  
Rev. F. J. WILLIAMSON.

**Honorary Secretary—**  
Mr. WASON.

**Annual Subscriptions.**

	£.	s.	d.
Hunter, James, Esq.	2	2	0
McConnel, W. Esq.	1	1	0
Stair, The Earl of	2	1	0
<b>Total</b>	<b>5</b>	<b>5</b>	<b>0</b>

**Donations.**

	£.	s.	d.
Box contributions	10	3	3
Sums under 5s.	1	11	0
<b>Total</b>	<b>27</b>	<b>6</b>	<b>3</b>

**GIRVAN BRANCH.**

**Patron—**  
The Right Hon. the EARL OF STAIE, K.T.

**Treasurer—**  
ALEXANDER MARTIN, Esq.

**Honorary Secretary—**  
WILLIAM FORSYTH, Esq.

**Annual Subscriptions.**

	£.	s.	d.
Alexander, Col., M.P.	2	2	0
McConnel, William, of Knockdolian	1	1	0
Young, J. G. K., of Glendoune	1	1	0
<b>Total</b>	<b>4</b>	<b>4</b>	<b>0</b>

**IRVINE BRANCH.**

**President—**  
GEORGE BROWN, Esq., Provost.

**Vice-Presidents—**  
Capt. DAVID BOYLE, R.N., of Shewalton, &c.  
JOHN PATERSON, Esq., of Knowehead.

**Honorary Secretary—**  
JAMES DICKIE, Esq.

**Annual Subscriptions.**

	£.	s.	d.
Alexander, Hugh	10	0	0
Aiston, Chas. H.	1	0	0
Armour James	5	0	0

	£.	s.	d.
Begg, J. S.	5	0	0
Boyle, Captain, R.N.	2	0	0
Boyd, H. F.	1	0	0
Brenner, Mrs.	5	0	0
Brown, Geo.	1	1	0
Brown, Capt. James	5	0	0
Brown, J. G.	1	1	0
Calderwood, Hugh	5	0	0
Christie, Wm.	5	0	0
Clark, Capt.	5	0	0
Dickie, Rev. W. S.	7	6	6
Drummond, J.	5	0	0
Eglinton, Earl of	3	3	0
Eglinton Chemical Co., Limited	3	3	0
Finnie, Archibald	1	1	0
Springhill	1	1	0
Galloway, And. C.E.	10	0	0
Gilmour, Alexander	10	0	0
Gorman, C. S.	10	0	0
Goudie, James	7	6	6
Gray, David	1	0	0
Hamilton, Alexander	10	6	6
Henderson and Co. Wm.	3	3	0
Highet, H. M.	5	0	0
Holmes, Miss	5	0	0
Johnston, John	5	0	0
Lindsay, J. B.	5	0	0
Longmuir, Alex.	10	6	6
Macredie, Mrs. Mure, of Perceton	10	0	0
Marr, Capt.	5	0	0
McJannet, Wm.	5	0	0
McKinlay, William	7	6	6
Morris, Capt. A. F.	10	0	0
Muir, Capt. David	5	0	0
Paterson, John, Knowehead	10	6	6
Paton, Alex. & Son	5	0	0
Pipe, James	5	0	0
Robertson, Miss	5	0	0
Rose, Mrs.	5	0	0
Ross, Z. M. H.	10	0	0
Sommerville, Rev. Jas.	5	0	0
Stevenson, William	5	0	0
Stewart, James	10	0	0
Walker, Alex.	5	0	0
Wilson, Dr.	5	0	0
Wilson, James	5	0	0
Wyllie, John	5	0	0
Sums under 5s.	6	17	0
<b>Total</b>	<b>237</b>	<b>9</b>	<b>0</b>

**TROON BRANCH.**

**Honorary Secretary—**  
ALEXANDER WYLLIE, Esq.

**Subscription.**

	£.	s.	d.
Gilmour, Allan	1	0	0

**Donations.**

	£.	s.	d.
A Friend	1	0	0
Alexander, Col., M.P.	2	2	0
Alexander, W., M.P.	10	0	0
Calderwood, H.	10	0	0
Cook, Duncan	10	0	0
Cowan, Rev. A. H.	10	0	0
Craig, J. & M., Kilmarnock	1	0	0
Cunningham, W. S. of Cappington	1	0	0
Easton, Robt.	1	1	0
Finnie, Archd. & Son	2	0	0
Finnie, Miss	10	0	0
Fleming, Rev. Jas.	10	0	0
Galloway, John, Kilmarnock	1	0	0
Guthrie, James	10	0	0
His Grace the Duke of Portland	2	2	0
Horne, John, & Sons	10	0	0
Houldsworth, W. H.	1	0	0
Kirkwood, Rev. Jno.	10	0	0
Logan, Jno.	10	0	0

	£.	s.	d.
Russell, E.	1	0	0
Troon Shipbuilding Company	1	0	0
Wood, James	1	0	0
Boxes in Custom House and Post Office, &c.	9	4	4
<b>Total</b>	<b>19</b>	<b>4</b>	<b>4</b>

**Banffshire.**

**BANFF AND MACDUFF BRANCH.**

**President—**  
The EARL OF FIFE, K.T.

**Chairman—**  
WILLIAM COUTTS, Esq., Provost of Banff.

**Deputy Chairman—**  
JAMES MARTIN, Esq., Provost of Macduff.

**Treasurer and Hon. Sec.—**  
JAMES WATT, Esq.

**Annual Subscriptions.**

	£.	s.	d.
Fife, Earl of	10	0	0
Seafieid, Earl of	1	0	0
Abercromby, Sir R. Bt.	1	0	0
Ainslie, A. D. Esq.	1	0	0
Allan, John, Esq.	5	0	0
Banff Shipping	4	14	0
Bow, Alex. Esq.	5	0	0
Bryson, W. G. Esq.	5	0	0
Campbell, Colonel	1	0	0
Coutts, Provost	5	0	0
Cumming, Geo. Esq.	5	0	0
Cumming, Colonel Gordon	1	0	0
Diggins, Mrs.	5	0	0
Duff, Rt. Hon. M. E. Grant, M.P.	1	0	0
Duff, Hon. G. Skene	1	0	0
Duff, R. W. Esq. M.P.	1	0	0
Duff, Major Gordon	1	0	0
Forbes, Colonel	1	1	0
Geddie, Rev. J. W.	5	0	0
Gordon, W. and C.	5	0	0
Grant, Capt.	10	0	0
Hannay, John, Esq.	5	0	0
Harvey, John, Esq.	1	1	0
Henderson, E. P. Esq.	1	1	0
Hodge, Capt.	10	0	0
Hunter, Rev. Wm.	5	0	0
McConnachie & Ironside	5	0	0
Macduff, Cmercl. Co.	5	0	0
Macduff Shipping	6	0	0
Macfarlane, Alex. Esq.	5	0	0
Manson, Dr.	5	0	0
Martin, Provost	5	0	0
Milne, Dr.	5	0	0
Moncrieff, Sheriff Scott	5	0	0
Morison, Mrs. of Bog-nie	2	0	0
Murray, G. W. & Co.	5	0	0
Nisbet and Co.	5	0	0
Pirie, Geo. Esq.	5	0	0
Russell, Trustees of late Misses	5	0	0
Scott, Alex. Esq.	1	0	0
Simpson, J. Esq.	5	0	0
Sinclair, Arthur, Esq.	10	0	0
Stronach, Wm. Esq.	1	0	0
Taylor, W. J. Esq.	1	0	0
Walker, Rev. George	5	0	0
Watt, Alex. Esq.	5	0	0
Watt, Capt. James	5	0	0
Watt, G. N. Esq.	5	0	0

	£.	s.	d.
Boxes at Boat-house, &c.	13	5	5
Sums under 5s.	2	4	0
Bank Interest	4	8	8
<b>Total</b>	<b>253</b>	<b>14</b>	<b>1</b>

**BUCKIE BRANCH.**

**President—**  
The Right. Hon. the EARL OF SEAFIELD.

**Chairman—**  
W. R. DUGUID, Esq., M.D.

**Honorary Secretary—**  
JOHN SHEARER, Esq.

**Donations.**

	£.	s.	d.
Russell's Trust, Misses, Aberdeen	5	0	0
Bryson, W. G. Esq.	5	0	0
Earl of Seafieid	1	0	0
Small sums	17	6	6
<b>Total</b>	<b>27</b>	<b>2</b>	<b>6</b>

**Berwickshire.**

**EYEMOUTH BRANCH.**

**President—**  
Lieut.-Col. MILNE HOME, of Wedderburn, M.P.

**Vice-President—**  
JAMES GIBSON, Esq., Eyecliffe Chemical Works.

**Treasurer—**  
Mr. JOHN DICKSON, Fish Curer.

**Honorary Secretary—**  
Mr. ANDREW WHITTLE, Commercial Bank.

**Annual Subscriptions.**

	£.	s.	d.
Allan, Robert, Esq.	10	0	0
Cairns, John, Esq.	10	0	0
Dickson, John, Esq.	10	0	0
Gibson, James, Esq.	10	0	0
Hamilton, The Hon. R. Baillie	5	0	0
Home, Col. Milne, M.P.	5	5	0
Home, Miss, of Guns-green	1	0	0
Mack, J. S., Esq.	1	0	0
Marjoribanks, E., Esq., M.P.	5	0	0
Marjoribanks, Lady	1	0	0
<b>Total</b>	<b>20</b>	<b>5</b>	<b>0</b>

**Donations.**

	£.	s.	d.
Chartres, Wm., Esq.	1	0	0
Wilson, T., and crew	10	0	0
Wilson, And., and crew	7	0	0
Post Office Box	1	1	1
<b>Total Dons.</b>	<b>18</b>	<b>1</b>	<b>1</b>
<b>Total Subs.</b>	<b>20</b>	<b>5</b>	<b>0</b>
<b>Total</b>	<b>22</b>	<b>3</b>	<b>1</b>

BRANCHES—LIST OF ANNUAL SUBSCRIPTIONS AND DONATIONS. 367

**Buteshire.**

**ISLE OF ARRAN BRANCH.**

Honorary Secretary—  
JAMES PATERSON, Esq.

Annual Subscriptions.

£. s. d.	
Campbell, Rev. Colin	0
F.	10 0
Paterson, James	1 0 0
<b>Total</b>	<b>1 10 0</b>

*Donations.*

Ackrill, R.	5 0
A. H.	5 0
Allan, James	10 0
Bannatyne, John	5 0
Blyth, Robert	5 0
Bollaud, J. Reed	5 0
Bow, Mrs. J. A.	5 0
Boyd, John K.	5 0
Boyd, Miss	5 0
Bruce, Mrs.	5 0
Coats, Thomas	1 0 0
Davidson, Robt.	5 0
Denny, —	5 0
Dickie, Wm. M.	5 0
Fraser, Mrs.	5 0
Fullarton, R. W. MacLeod	1 1 0
Govan, Wm.	5 0
Hamilton, Robt.	5 0
Henry, Mrs.	5 0
Hering, Mrs.	10 0
J. A. B.	5 0
Latham, S.	5 0
MacDonald, Peter	10 0
MacKintosh, Jas.	5 0
MacNeish, D. & Son	10 0
McLean, Rev. M.	5 0
Middlemas, Mrs.	5 0
Cameron, Duncan, Esq.	5 0
Rankine, Mrs.	5 0
Reid, Alex.	5 0
Richmond, David	5 0
Robertson, Jas.	5 0
Scott, Mrs.	5 0
Smith, Miss C. R.	5 0
Sprague, T. B.	5 0
Steamer Brodick Castle	1 0 0
Stewart, Jas. Hay	5 0
Stewart, Rev. A.	10 0
Wallace, John	5 0
Waller, C. H.	5 0
Watson, Edward	5 0
Wooley, Mrs.	5 0
Wylie, Robert S., LL.D.	5 0
Yorke, James	5 0
Corrie Hotel Col. Box	1 0 0
Lamlash	18 7
Shedog	7 0
Kildonan boat-house	1 0 0
Collecting Box	1 0 1
Sums under 5s.	13 18 6
<b>Total Dons.</b>	<b>31 10 2</b>
<b>Total Subs.</b>	<b>1 10 0</b>
<b>£33 0 2</b>	

**Caithness-shire.**

**HUNA BRANCH.**

President—  
PETER KRITH, Esq.  
Barrogill Castle.

Honorary Secretary—  
Mr. D. DUNNETT.

Annual Subscriptions.

£. s. d.	
Caithness, The Rt. Hon. the Earl of.	2 2 0
Heathcote, T. G. Esq.	5 0
Keith, Peter, Esq.	10 0
McGregor, Dr. A.	5 0
McGregor, Rev. R.	5 0
McPherson, Rev. Jas.	5 0
Shepherd, Miss Jane	5 0
Sutherland, John, Esq.	5 0

*Donation.*

Box at Huna Hotel	5 0
Box at Life-boat House	2 11
<b>Total</b>	<b>24 9 11</b>

**THURSO BRANCH.**

Patron—  
SIR J. G. T. SINCLAIR, BART.,  
M.P.

Treasurer—  
JAMES BRIMS, Esq.

Honorary Secretary—  
JOHN COGHILL, Esq.

Annual Subscriptions.

Brims, James, Esq.	5 0
Cameron, Duncan, Esq.	5 0
Coghill, John, Esq.	5 0
Craig, D. B. Esq.	5 0
Dunbar, Lewis, Esq.	5 0
Galloway, J. W., Esq.	5 0
Henderson, A. Esq., of Stemster	10 0
Henderson, Donald, Esq.	2 6
Henderson, John, Esq. (2 years)	10 0
Logan, George, Esq.	5 0
Miller, Mrs. George	10 0
Miller, Rev. J. S.	5 0
Russell, Miss	2 6
Sinclair, David, Esq.	5 0
Sinclair, Hugh, Esq.	5 0
Sinclair, Sir J. G. T., Bart. M.P.	2 2 0
Stuclair, Sir R. C. Bt.	1 0 0
Sutherland, David, Esq.	5 0
Swanson, John, Esq.	10 0
Tait, W. R. Esq.	5 0
Trall, J. C. Esq.	1 1 0
Williamson, Capt.	5 0
<b>Total</b>	<b>9 13 0</b>

*Donations.*

Contribution Box in Royal Hotel, Thurso	10 3
Ditto at Scrabster	7 9
<b>Total Dons.</b>	<b>18 0</b>
<b>Total Subs.</b>	<b>9 13 0</b>
<b>£10 11 0</b>	

**WICK AND ACKER-GILL BRANCH.**

President—  
G. DUFF DUNBAR, Esq.

Honorary Secretary—  
GEORGE M. SUTHERLAND.

Annual Subscriptions.

£. s. d.	
Adam, Mr. Thos.	5 0
Begg, Mr. Wm.	5 0
Bremner, Mr. James	5 0
Bruce, Mr. Chas.	5 0
Cormack, Mr. John	5 0
Crawford, Mr. Alex.	5 0
Dunbar, G. Duff, Esq. (2 years)	6 6 0
Dunnet, Mr. Chas.	5 0
Gilchrist, Mr. James	10 6
Gunn, Mr. Jas.	5 0
Gunn and Co.	10 0
Messrs. D.	10 0
Henderson, Mr. J. H.	5 0
Leith, Mr. David	5 0
McArdie, Mr. George	5 0
McArdie, Mr. James	5 0
McEwen, Mr. Alex.	5 0
McLennan, Mr. M.	10 6
Miller, Cormack and Mackay, Messrs.	10 0
Nicol, Mr. Jas.	5 0
Nicolson, Mr. W.	5 0
Pender, John, Esq. M.P.	2 2 0
Rae, Mr. Wm.	10 6
Reid, Peter, Esq.	10 6
Robertson, Mr. R.	5 0
Ross, Mr. D.	5 0
Ross, Mr. Chas.	5 0
Scott, Mr. John	5 0
Simpson, Mr. D. R.	5 0
Simpson, Mr. George	5 0
Sinclair, Mr. A.	5 0
Sinclair, Mr. Alex.	5 0
Sinclair, Mr. R.	5 0
Smith, Mr. W. P.	5 0
Sutherland, Mr. D.	5 0
Sutherland, Mr. G.	5 0
Sutherland, Mr. G. M.	5 0
Sutherland, M. J.	5 0
Sutherland, Mr. John	5 0
Sutherland, Mr. W.	5 0
Wares, Mr. Alex.	5 0
Waters, Mr. Donald	5 0
Sums under 5s.	10 12 0

*Donations.*

Box at Custom House	1 1 9
Do. at Commercial Bank	10 9
<b>Total</b>	<b>£31 19 6</b>

**Clackmannanshire.**

**ALLOA BRANCH.**

Honorary Secretary—  
DAVID BARRY, Esq.

Honorary Collector—  
MR. ALEX. GARDEN.

Annual Subscriptions.

£. s. d.	
Adam, Mr. Robt.	5 0
Alloa Colliery Co.	1 1 0
Archibald, Son, and Co., W.	10 6
Bailey, W. & J. A.	1 1 0
Beveridge, Mr. Walter	5 0
Brinkmann, H.	10 6
Calder, Jas. and Co.	1 1 0
Carmichael, R. Sen.	10 0

£. s. d.

Duncanson, The Misses	2 0 0
Fisher, Morton	10 6
Gentle, Mr. Alex.	10 6
Harvey, J. B. Esq.	10 6
Hunter & Donaldson, Messrs.	10 0
Knob & Son, Robert	1 1 0
Laing, Richard, Esq.	7 6
Laurie, Rev. Mr.	5 0
Leshman, Jas. Esq.	1 0 0
Lochhead, Mr. J.	10 6
McDowall, Capt.	5 0
McEwan, Miss	1 0 0
Mar and Kellie, The Right Hon. the Earl of	3 0 0
Meiklejohn & Son, R.	1 0 0
Melvin, Mrs. John	10 0
Mitchell, Messrs. A. and A.	2 0 0
Moir, Archibald, Esq.	10 6
Paton, A. Forrester, Esq.	3 0 0
Paton, David, Esq.	5 0 0
Paton, Miss	15 0
Paton, Jno., Son & Co.	1 1 0
Patrick, Mr. J.	5 0
Pears, Mr.	5 0
Phillip, Mr. John	5 0
Portsons, Archd.	5 0
Portsons, Mr. J.	10 6
Rintoul, Mr. Robt.	5 0
Rintoul, Son, Wm.	1 1 0
Sewel, W. R. Esq., M.D.	5 0
Strang, Miss	1 2 6
The Carron Co.	5 0 0
Thomson, Bro.	1 1 0
Thomson & Son, A.	1 1 0
Turcan, Wm. Esq.	1 1 0
Walker, Dr.	10 0
Willison, Mr.	10 6
Wingate, Miss	1 0 0
Woir, J. W.	1 0 0
Younger & Son, Geo.	1 1 0
Sums under 5s.	2 17 0
<b>Total</b>	<b>£50 1 6</b>

**Edinburgh.**

**DALKEITH BRANCH.**

President—  
ALEXANDER MITCHELL.

Vice-President—  
WILLIAM PORTEOUS.

Treasurer—  
JOHN CRAIG.

Secretary—  
ALEX. BALLANTYNE, M.D.

Annual Subscriptions.

1879. £. s. d.	
A Friend	5 0
Ballantyne, Dr.	10 0
Bishop, John	5 0
Chisholm, John	5 0
Craig, John	5 0
Dennis, John	5 0
Dods, Archibald	5 0
Douglas, A.	10 0
Douglas, George, and Son	5 0
Dove, David	5 0
Dunn, Malcolm	5 0
Gray, George	5 0
Gray, James	10 6
Hewat, Misses	5 0
Metcalfe, W. J. & Co.	5 0
Mitchell, Alexander	1 0 0
Mutter, Misses	5 0

	£.	s.	d.
Porteous, William.....	5	0	
Purell, David.....	5	0	
Tod, J. and J.....	1	0	0
Todd, Mrs.....	5	0	
Wilson, Robert.....	5	0	
Wilson, Miss.....	5	0	
Sums under 5s.....	5	18	6
<b>Total.....</b>	<b>£13</b>	<b>19</b>	<b>0</b>

**EDINBURGH AND LEITH BRANCH.**

Chairman—  
Adm. SIR ALEXANDER MILNE,  
BART., G.C.B.

Honorary Secretary—  
ROBERT SINCLAIR, Esq.,  
18 Waterloo Place.

Annual Subscriptions.

A. B.....	5	0	
A. H.....	10	0	
A. P. N.....	5	0	
Abbot, F. Esq.....	1	0	
Abercrombie, Misses 1 0	0		
Adams, Sons, and Co. Messrs.....	1	0	
Addie, Alex. Esq.....	1	0	
Agnew, Capt. R. N.....	10	0	
Ainslie, Colonel.....	5	0	
Ainslie, James, Esq., per the Association for Improving the Condition of the Poor.....	2	2	0
Aitchison and Co. Messrs. John.....	10	0	
Aitken, Gray, and Co. Messrs.....	1	1	0
Aitken and Wright, Messrs.....	10	6	
Aitken and Co. Messrs. James.....	5	0	
Aitken, A. Esq., Jun.....	5	0	
Aitken, Mrs.....	5	0	
Alison, Mrs. A.....	5	0	
Allan, Mrs.....	5	0	
Anderson, David, Esq. 1 0	0		
Anderson, Dr., R. N.....	5	0	
Anderson, Miss.....	5	0	
Anderson, Misses.....	1	0	
Anderson, Mrs.....	5	0	
Anderson, Mrs.....	5	0	
Anderson, Mrs. J.....	5	0	
Anderson and Williamson, Messrs.....	5	0	
Annandale, Mrs.....	5	0	
Anstey, Mrs.....	10	0	
Austin, Mrs.....	7	6	
Baildon, H. C. Esq.....	5	0	
Baillie & Co. Messrs. T.....	5	0	
Baillie and Son, Messrs. W.....	10	6	
Baillie, J. M. Esq., C.A.....	10	0	
Bain, G. Esq.....	5	0	
Baird, Sir Jas. G.....	1	0	
Baird, Miss.....	5	0	
Balfour, J. B.....	5	0	
Ballantyne, Hanson, and Co.....	5	0	
Ballantine and Son, Messrs. Geo.....	5	0	
Barbour, Geo. F. Esq. 1 0	0		
Barclay, Rev. J.....	5	0	
Barclay, Mrs.....	5	0	
Barret, Mrs.....	5	0	
Barry, Mr. John.....	5	0	
Barstow, C. M. Esq.....	5	0	
Barton, Mrs. D.....	5	0	
Baxter, E. Esq.....	1	0	
Bayley, Mrs.....	5	0	
Beattie and Sons, Messrs.....	5	0	
Belby, J. H. Esq., per the Association for Improving the Condition of the Poor.....	1	0	0

Beith, Rev. Dr.....	5	0	
Belcombie, Rev. F. E.....	5	0	
Bell, A. M. Esq.....	5	0	
Bell, Mrs. Glassford, & Miss Sandeman.....	10	0	
Bell, M. P. Esq.....	5	0	
Bell, W. Esq.....	1	1	0
Bell, Rannie, and Co. Messrs.....	1	1	0
Bernard and Co. Messrs.....	10	6	
Bernard, Messrs. T. and J.....	10	0	
Berry, Barclay, and Co. Messrs.....	1	1	0
Berry, Mrs.....	10	0	
Bertram, George, Esq.....	10	0	
Bertram, George, Esq.....	5	0	
Bevan, Mrs. A.....	10	0	
Beveridge, J. A. Esq. 1 0	0		
Beveridge, Misses.....	10	0	
Bishop, Dr.....	5	0	
Black, Messrs. A. & C.....	5	0	
Black, Mrs.....	10	0	
Blackhall Brothers, Messrs.....	10	0	
Blackwood, Mrs.....	5	0	
Blackwood, Miss.....	5	0	
Blaik, A.....	5	0	
Blayth, E. L. Esq. 10 0	0		
Bonnar and Carrae, Messrs.....	10	0	
Bow, R. H. Esq.....	10	0	
Boyd, Thomas, Esq. 1 0	0		
Braidwood & Fowler, Messrs.....	5	0	
Brakenridge, Mrs.....	5	0	
Bramwell, Byrom, M.D.....	5	0	
Bringloe, Francis A. Esq.....	5	0	
Brodie, Hamilton, and Co. Messrs.....	5	0	
Brodie, J. Clerk, Esq. 1 0	0		
Brodie, T. D. Esq.....	10	0	
Brothie & Co. Messrs. R.....	1	1	0
Brown, Dr. Crum.....	5	0	
Brown & Son, Messrs. H.....	5	0	
Brown, Miss.....	5	0	
Brown, Mrs.....	1	0	
Brown, Mrs.....	5	0	
Bruce, Boyd, and Co. Messrs.....	1	1	0
Bruce, G. Esq., W.S.....	5	0	
Bruce, Miss.....	10	0	
Bruce, Miss.....	5	0	
Bryden and Son, Messrs. W.....	5	0	
Bryson and Son, Messrs. R.....	5	0	
Buchan and Johnstone, Messrs.....	5	0	
Buckle, Mrs.....	5	0	
Buist, Robert, Esq.....	10	0	
Burn and Son, Messrs. G.....	5	0	
Burnley, W. F. Esq. 1 0	0		
C. S.....	5	0	
Cairns, Mrs.....	5	0	
Callander and Sons, Messrs. David.....	1	1	0
Callander, Miss.....	10	0	
Cameron, C. Esq.....	5	0	
Campbell, A. Esq.....	10	0	
Campbell and Co. Messrs. J. N.....	5	0	
Campbell, Miss D.....	5	0	
Campbell, Mrs.....	5	0	
Carron Iron Co.....	5	0	
Carruthers, P. Esq. 1 0	0		
Cathcart, Mrs.....	5	0	
Chambers, Messrs. W. and R.....	2	2	0
Chapman, Mrs.....	5	0	
Cheap, Hon. Mrs.....	5	0	
Cheape, Mrs.....	5	0	
Chiene, Mrs. G. Todd.....	5	0	
Chisholm, David, Esq.....	5	0	
Christie and Kilpatrick, Messrs.....	5	0	

Christie, W. Esq.....	5	0	
Christie, Mrs.....	5	0	
Christie, Mrs. S.....	5	0	
Christison, David, Esq., M.D.....	1	0	0
Christison, John, Esq., W.S.....	10	0	
Clapperton, John, Esq. 1 0	0		
Clark, Hon. Lord Rutherford.....	1	0	0
Clunes, James, Esq.....	10	0	
Cochrane, Paterson, and Co. Messrs.....	10	0	
Cockburn and Campbell, Messrs.....	2	0	0
Cockburn and Co. Messrs.....	1	1	0
Collie, Mrs.....	5	0	
Constable, Messrs. T. and A.....	5	0	
Coot, Mrs.....	10	0	
Corrwall, Misses.....	5	0	
Corrie, Hanson, & Co. 1 0	0		
Cousin, Mrs.....	5	0	
Cowan and Co.....	5	0	
Cowan and Strachan, Messrs.....	10	0	
Cowan, John, Esq., of Beeslack, per Thomas.....	1	0	0
Cowan, Miss.....	5	0	
Cowan, J., Esq., W.S.....	5	0	
Cowper, Mrs.....	5	0	
Cowper, Mrs. C. M.....	5	0	
Cox, Mrs. J.....	5	0	
Craig & Rose, Messrs.....	5	0	
Crawford, Messrs. A. and A.....	10	6	
Crichton, Mrs. G. H.....	5	0	
Crudelius, Hirst, and Co. Messrs.....	10	0	
Cruikshank and Son, Co. Messrs.....	5	0	
Cumming and Sons, Messrs.....	7	6	
Cunningham, George, Esq.....	2	2	0
Cunningham, Messrs. J. and J.....	10	0	
Cunningham, T. Esq.....	5	0	
Currie and Co. Messrs. James.....	1	1	0
Curriehill, The Hon. Lord.....	1	0	0
Cuthbert, Miss.....	5	0	
Dalglish, Mrs.....	5	0	
Dalgity, Misses.....	5	0	
Dalziel, George, Esq.....	10	0	
Davidson, Lieut.-Col. H.E.I.C.S.....	10	0	
Davidson, Pirrie, and Co. Messrs.....	5	0	
Dempster, Mrs.....	5	0	
Deuchar, David, Esq. 1 0	0		
Dewar, Mrs. E.....	5	0	
Dick, John, Esq.....	5	0	
Dickson, D. S. Esq.....	10	6	
Dickson and Co. Messrs. James.....	10	0	
Dickson and Walker, Messrs.....	5	0	
Dickson, Wm. Esq.....	10	0	
Dickson, Wm. Esq.....	5	0	
Dicksons and Co. Messrs.....	5	0	
Dishington and Co. Messrs. T.....	5	0	
Donaldson, A. Esq.....	5	0	
Douglas, Francis Brown, Esq.....	10	0	
Douglas, Misses.....	5	0	
Douglas, Miss.....	10	0	
Drummond Brothers, Messrs.....	5	0	
Drummond, Jas. Esq.....	5	0	
Drummond, Mrs. D. T. K.....	10	0	
Drybrough, John, Esq.....	5	0	
Drybrough and Co. Messrs. N. B.....	5	0	
Duncan, Flockhart, and Co. Messrs.....	10	0	

Duncan and Co. Messrs. James.....	5	0	
Duncan, Miss.....	5	0	
Duncan, H. Macduff, Esq.....	5	0	
Dunn, J. W. Esq.....	5	0	
Dunsmuir, Dr.....	5	0	
Dymock and Guthrie, Messrs.....	5	0	
Dymock, Jas. R. Esq.....	10	0	
Edinburgh Roperie Co. Messrs. the.....	1	1	0
Edinburgh and Leith Brewery Co.....	5	0	
Edmonstone, Thomas, Esq.....	10	0	
Edmonstone, Sir Wm. Bart., M.P.....	1	0	0
Edwards, H. C. Esq.....	10	0	
Ellis, W. M. Esq.....	10	6	
E. M. M.....	10	6	
Faithfull, Mrs.....	5	0	
Falconer, Miss.....	1	0	0
Farmer, Mr. John.....	5	0	
Fenwick, Bruce, Esq.....	5	0	
Ferguson, Mr. William, Ferguson, Davidson, and Co. Messrs.....	1	1	0
Ferguson and Co. Messrs. Thomas.....	5	0	
Fergusson, Mrs.....	5	0	
Field and Allan, Messrs.....	5	0	
Finlay, J. R. Esq.....	1	0	0
Finlay, Mrs.....	5	0	
Finlay, William, Esq.....	5	0	
Friend, A.....	5	0	
Finnie, Miss.....	10	0	
Fleming, J. Esq.....	5	0	
Flett, Mrs.....	5	0	
Forrest & Turnbull.....	5	0	
Forbes, Miss.....	10	0	
Forbes, Mrs.....	5	0	
Forbes, Mrs. Peter.....	5	0	
Ford & Co. Messrs. John.....	5	0	
Ford & Sons, Messrs. W.....	1	1	0
Forsyth, Mrs.....	10	0	
Fraser, Mrs.....	10	0	
Fraser, Mrs.....	5	0	
Friend, A. Leith.....	5	0	
Friend, A.....	5	0	
Friends, 39 Moray Place.....	5	0	
Friends, 64 Princes Street.....	1	10	0
Fulton & Co. Messrs. J.....	1	1	0
Gallie, Laird, and Co. Messrs.....	5	0	
Galloway, M. P., Esq.....	5	0	
Galloway, Mrs. John 2 0	0		
Gibson, Messrs. R. and T.....	10	6	
Gibson and Walker, Messrs.....	1	1	0
Gibson's Heirs, H. C.....	5	0	
Gibson, Thomas, Esq.....	10	6	
Gillespie, Dr.....	5	0	
Gillespie and Cathcart, Messrs.....	2	2	0
Gillon & Co. Messrs. John.....	10	6	
Gitmore, W. & O.....	5	0	
Gordon, John, Esq.....	5	0	
Gordon, Robert, Esq.....	5	0	
Gordon, Mr.....	5	0	
Gowan, Miss.....	5	0	
Gow, Alex. Esq.....	5	0	
Gray, Robert, Esq.....	5	0	
Gray, Mrs. A.....	5	0	
Gray and Son, Messrs. James.....	5	0	
Hadden and Son, Messrs. R.....	5	0	
Hagart, T. C. Esq.....	5	0	
Haldane, Mrs.....	10	0	
Haldane, Mrs.....	5	0	
Halkett, Lady.....	5	0	
Hall, Dunbar, and Co., Messrs.....	5	0	

## BRANCHES—LIST OF ANNUAL SUBSCRIPTIONS AND DONATIONS. 369

£. s. d.	£. s. d.	£. s. d.	£. s. d.
Hamilton, Claud H., per the Association for Improving the Condition of the Poor..... 10 0 0	Lewis, Mrs..... 5 0	Menzies, John R. Esq. (1879, 1880).. 1 0 0	Petrie and Co. Messrs. Philip..... 5 0
Hamilton, H. Esq. .... 5 0	Lindsayay, Colonel... 1 0 0	Millar, Mrs. John .. 5 0	Philip and Son, .. 10 0
Harrison and Co. Messrs..... 10 6	Lindsay and Son, Messrs. James.... 5 0	Millar, Mrs. W..... 5 0	Pitman, F. Esq. .... 5 0
Harvey, Mr. G. M. .... 5 0	Livingstone & Weir, Messrs..... 1 1 0	Miller, D. A. Esq. ... 5 0	Playfair, Dr. .... 5 0
Harvey, R. E. Esq. .... 5 0	Lockhart, Mrs..... 5 0	Miller and Sons, Messrs. James.... 1 1 0	Pollock, Mrs. .... 5 0
Hawthorns and Co., Messrs..... 1 1 0	London & Edinburgh Shipping Co. .... 1 1 0	Miller, John, Esq., of Leithen..... 1 0 0	Prevost, Colonel .. 10 0
Hay, Admiral..... 5 0	Lord Provost, The .. 1 1 0	Miller, R. Esq. .... 1 0 0	Primrose, David, Esq. 5 0
Hay and Co. Messrs. James..... 10 0	Lorimer, J. Campbell, Esq..... 5 0	Milne, James, Esq. ... 5 0	Pringle, Robert, Esq. 5 0
Hayward, Robt. Esq. ... 5 0	Lothian, E. Esq. .... 10 0	Milne & Sons, Messrs. J..... 10 0	Raeburn, Messrs. W. and J..... 10 0
Henderson, Miss..... 5 0	Lothian, Miss..... 5 0	Milroy, John, Esq. ... 10 0	Ramsay, Geo. Esq. ... 1 0 0
Henderson, Miss..... 5 0	Low, Robertson, and Co. Messrs..... 5 0	Mitchell and Co. .... 5 0	Rankin, Miss..... 5 0
Henderson, Mrs..... 10 0	Lumsden, Mrs..... 5 0	Moir, E. M. Esq., C. A..... 10 0	Rankine, George, Esq. 5 0
Henny, John, Esq., S.S.C..... 1 0 0	Lyon and Turnbull, Messrs..... 10 0	Moir, Mrs..... 5 0	Redpath, Brown, and Co. Messrs..... 10 6
Hewit, Peden, & Co. ... 5 0	M. A. C..... 5 0	Moncrieff, J. Scott, Esq..... 5 0	Reid, William, Esq. ... 10 0
Hewit & Sons, Messrs. ... 5 0	M. B..... 10 0	Moncrieff, Lady ..... 5 0	Renny, Chas. Esq. ... 5 0
Hill, Miss..... 5 0	Macandrew, Mrs..... 5 0	Moncrieff, Mrs..... 5 0	Renton, W. Esq. .... 5 0
Hill, Thomson, and Co. Messrs..... 5 0	Macadduf, Mrs..... 5 0	Moncrieff, W. Esq. ... 5 0	Rhind, D. A. & C. ... 5 0
Hill, W. Scott, Esq. ... 10 0	Macfarlane and Co. Messrs. J. F..... 10 0	Moncrieff, The Montgomery, .. 5 0	Richardson and Co. Messrs. Francis ... 5 0
Hodge, Mrs. Charles ... 5 0	Macfarlane, M. Esq. ... 10 0	Moncrieff, W. Esq. ... 5 0	Richardson, P. Esq. ... 10 0
Hodge, Mrs. T..... 5 0	Macfarlane and Co. Messrs. D..... 5 0	Moore, Geo. Esq. .... 5 0	Richardson, Rob. Esq. 1 0 0
Hogg and Co. Messrs. A. G..... 5 0	Macgibbon, Mrs..... 5 0	Moore, Lady Elizabeth 1 0 0	Ritchie, A. Esq. .... 5 0
Hog, Mrs..... 10 0	Mackenzie, Colin, Esq..... 5 0	Moore, Mrs..... 5 0	Ritchie and Son, Messrs. James .... 5 0
Hoeyman & Wilson, Messrs..... 10 0	Mackenzie, John Ord, Esq..... 10 0	Morison, Patrick G. Esq..... 5 0	Ritchie, Simon, Esq. 5 0
Hope, James, Esq. .... 1 0 0	Mackenzie, Miss..... 10 0	Morrison, Messrs. J. and G..... 10 6	Robertson Brothers, Messrs..... 1 1 0
Hope, Mrs. James..... 1 0 0	Mackenzie, Miss..... 5 0	Morrison and Thom- son, Messrs..... 5 0	Robertson, C. S. Esq. 1 0 0
Hope, John, Esq. .... 1 0 0	Mackie, T. W. and Sons, Messrs..... 5 0	Mowbray, Robt. Esq. 1 1 0	Robertson, Messrs. J. and D..... 5 0
Horn, Mrs. Robert..... 10 0	Mackinlay and Co. Messrs. C..... 10 6	Muir, & Son, Messrs. J., N. B..... 5 0	Robertson, Miss..... 5 0
Horne, T. E. O. Esq. ... 5 0	Maclagan, M. S. D. ... 5 0	Muir, John, Esq., D.C.L..... 1 0 0	Robertson, Sanderson and Co. Messrs..... 5 0
Howden, Misses ..... 3 0 0	Maclagan, Professor Douglas..... 10 0	Muir, William, Esq. 1 1 0	Robinow, Majori- banks, and Co. Messrs..... 1 1 0
Howie, Alex. Esq. .... 1 0 0	Macnair, John, Esq. ... 1 0 0	Munro, J. Esq..... 10 0	Rodger, Miss..... 10 0
Howkins, John, Esq. 1 1 0	Macnee, D. Esq. .... 5 0	Murdoch, A. B. Esq. ... 5 0	Rollo, H. J. Esq. .... 5 0
Hoy, D. Esq..... 5 0	Makellor, W. Esq. ... 1 0 0	Mure, Lord..... 5 0	Ross, Mrs. Geo..... 5 0
Hoyes, John, Esq. .... 1 0 0	Makgill, Miss..... 5 0	Mure, Miss..... 5 0	Ross, Mrs. Kerr..... 10 0
Hunter, J. A. Esq. .... 5 0	McCandlish, J. M. Esq..... 10 0	Mure, Miss S..... 5 0	Roughhead, Mrs., Sen. Russell, Messrs. W. & J..... 5 0
Hunter, Miss..... 5 0	M'Diarmid, W. R. Esq..... 5 0	Murray, George, Esq. C.A..... 5 0	Rutherford and Co. Messrs..... 10 0
Hunter, Robert, Esq. 1 0 0	M'Dowall, Mrs..... 10 0	Murray, Miss, Brae- side..... 5 0	Sampson, Miss..... 10 0
Hutchinson Brothers, Messrs..... 5 0	M'Ewan, Wm. Esq., M'Farlane & Son, Messrs..... 5 0	Murray, Mrs., Holly Wood..... 5 0	Sanderson & Paterson 5 0
Innes, Mrs..... 5 0	M'Gregor, David, Esq. 5 0	Murray, R. Esq. .... 5 0	Sanderson, William .. 5 0
Inglis, H. M. Esq. .... 1 0 0	M'Gregor & Pringle, Messrs..... 1 1 0	Murray, Sir Patrick Keith, of Ochter- tyre, per Hugh Miller, Esq..... 2 0 0	Sandford, D. F. Esq. 5 0
Ivory, Thomas, Esq. ... 5 0	M. H., 2 Salisbury Road..... 5 0	Murray, T. G. Esq. ... 5 0	Sands, Miss..... 1 0 0
Ivory, Miss..... 1 0 0	M'Intosh, J. B. Esq. ... 5 0	Mylne, Mrs. J..... 5 0	Scott & Allan, Messrs. 1 1 0
J. C. W..... 5 0	M. J., 2 Madley M'Kay and Co., Messrs. Geo..... 5 0	N. C..... 10 0	Scott and Anderson, Messrs..... 10 6
J. H., Drylaw House J. H., 18 Belgrave Crescent..... 5 0	M'Laren, D. & Co. .... 10 0	Nelson and Sons, Messrs. Thomas .. 1 0 0	Scott, A. W. Esq. ... 5 0
J. J. C..... 1 0 0	M'Laren, Duncan, Jun. Esq..... 10 0	Newton, James, Esq. ... 5 0	Scott Bros., Messrs. ... 5 0
Jackson, Miss E..... 5 0	M'Laren, Messrs. D. and G..... 1 1 0	Nicolson, D. Esq. .... 10 0	Scott, T. Esq..... 5 0
Jamieson, Mrs..... 5 0	M'Laren, Mrs..... 5 0	N. B. Rubber Co. ... 10 6	Scottish Iron S.S. In- surance Association 5 0
Jamieson and Co. Messrs. Robert..... 5 0	M'Laren, D. Esq., per the Association for Improving the Condition of the Poor..... 10 0	Ogilvie, G. Moncreiff, Esq..... 5 0	Scater, White, & Co., Messrs..... 1 1 0
Jeffrey, Mrs..... 10 0	Maitland, Miss..... 5 0	Olliphant, Mr. School .. 5 0	Seymour, Mrs..... 5 0
Jenner and Co. Messrs. Charles..... 1 1 0	Maitland, Mrs..... 5 0	Olliver & Son, Messrs. 5 0	Shand, Hon. Lord, per the Association for Improving the Condition of the Poor..... 1 1 0
Johnstone, Messrs. W. and A. K..... 1 1 0	Marshall and Co. Messrs. W..... 10 0	Oswald, Lady..... 5 0	Shand, Mrs..... 5 0
Johnston, Robert..... 5 0	Marshall, Miss..... 5 0	Padon, Messrs. A & D. ... 5 0	Shepherd, Mrs..... 5 0
Jopp, Mrs. Charles..... 10 0	Marshall, Mrs..... 10 0	Pagan, Mrs..... 10 0	Shiels, J. S. Esq..... 1 1 0
Justice-General, The Lord..... 1 0 0	Marshall, Mrs. .... 5 0	Pairman Brothers, Messrs..... 5 0	Shields, Robert & Son, Messrs..... 5 0
Kemp, Hisslop, & Co. Messrs..... 5 0	Marshall, Mrs. F..... 10 0	Paterson, Miss..... 1 1 0	Sidley, Charles, Esq. ... 5 0
Kennedy, John, Esq. 1 0 0	Marshall, Mrs..... 10 0	Paterson, Mrs. & Miss .. 5 0	Sidley, Dr..... 5 0
Kidd, Eunson, & Co. Messrs..... 10 6	Marshall, Mrs..... 5 0	Paterson, J. N., and Miss..... 5 0	Sinclair and Barclay, Messrs..... 5 0
Kirkpatrick, Dr..... 5 0	Marshall, Mrs..... 10 0	Paterson-on, G. L. Esq. ... 5 0	Simpson, Jno. A. Esq. 1 1 0
Knoblauch, Hugo, Esq. 5 0	Marshall, Mrs. .... 5 0	Pattison, P. Esq. .... 5 0	Simpson, Mrs..... 1 0 0
Laing, W. and Co. .... 1 1 0	Marshall, Mrs. .... 5 0	Pearson, Charles, Esq. 1 0 0	Simpson, David, Esq. 5 0
Lamont, Mrs..... 5 0	Marshall, Mrs. .... 10 0	Peddie, A. Esq. M. D. ... 5 0	Simon, Mrs..... 5 0
Lancaster, Mrs..... 5 0	Marshall, Mrs. .... 5 0	Peddie, J. D. Esq., R.S.A..... 10 0	Simon, Mrs..... 5 0
Laurie, Jas. D. Esq. 1 1 0	Mathieson, Mrs..... 1 0 0	Penny, Mrs..... 10 0	Simon, F. Esq..... 10 6
Law, Messrs. W. & G. ... 10 0	Melrose and Co. Messrs. A..... 1 0 0	Pentland and Son, Messrs. C. J..... 5 0	Simon, Messrs. R. and D..... 5 0
Learmonth, Mrs..... 5 0	Metrose, John, Esq. ... 1 0 0	Peplow, R. L. Esq. ... 5 0	Smith and Son, Messrs. John..... 10 6
Learmonth, Mrs. L..... 5 0	Meville, Miss..... 5 0		
Leask, J. B. Esq..... 10 0	Melvin, Alex. Esq. ... 5 0		
Lees and Co. Messrs. John..... 10 0	Menzies & Co. Messrs. 5 0		
Lennie, E. Esq..... 5 0			
Leslie, James, Esq. .... 5 0			
Leslie, Miss..... 10 0			
Lewis, John, Esq. .... 1 0 0			

	£.	s.	d.
Smith, J. Esq.	5	0	0
Smith, Messrs. T. and H.	10	0	0
Smith, Miss C. R.	1	0	0
Smith, Mrs.	5	0	0
Smith, Messrs. D. & Co.	5	0	0
Sommerville and Co. Messrs. John.	10	0	0
Spence, Mrs.	5	0	0
Sprague, T. B. Esq.	5	0	0
Sprot, Misses.	5	0	0
Steen, J. C. Esq.	5	0	0
Steven, Miss	10	0	0
Stevenson, Miss	10	0	0
Stevenson, Miss	10	0	0
Stevenson, Mrs.	5	0	0
Stewart, Clapperton, & Co. Messrs. S.B.	5	0	0
Stewart, Chas. Esq.	5	0	0
Stewart, Messrs. J. and G.	5	0	0
Stewart, James, Esq.	5	0	0
Stewart, John, Esq.	5	0	0
Stewart, Mrs. Grainger	5	0	0
Stewart, Mrs.	5	0	0
Stewart, Mrs. R.	5	0	0
Stirling, Mrs.	5	0	0
Stuart, Miss	5	0	0
Stuart, R. L. Esq.	1	0	0
Swan & Son, Messrs. J.	5	0	0
Syme, Miss	10	6	0
Syme, Mrs.	5	0	0
Syme, Mrs.	5	0	0
Sums under 5s.	32	18	4
T. H. O.	5	0	0
Tainsh, James, Esq.	10	6	0
Taylor & Co. Messrs. W.	1	1	0
Taylor, Mr. William	5	0	0
Taylor, MacLeod and Co. Messrs.	5	0	0
Taylor, Arch. Esq.	5	0	0
Teignmouth, Lord	5	0	0
Tennant, R. Esq.	10	0	0
The Singer Machine Manufacturing Co.	5	0	0
Thomas, Capt. F. W. L., R.N.	10	0	0
Thomson, A. Esq.	5	0	0
Thomson, Chas. W. Esq.	5	0	0
Thomson and Co. Messrs. R. H.	10	6	0
Thomson and Co. Messrs. W.	10	6	0
Thomson, J. G. Esq.	10	0	0
Thomson, Miss	5	0	0
Thomson, W. T. Esq.	10	0	0
Thomson and Co. Messrs. D. J.	10	6	0
Tod Bros., Messrs.	5	0	0
Tod, Henry, Esq. W.S.	5	0	0
Tod, J. H., Esq.	10	0	0
Tod, J. W. Esq.	5	0	0
Torry, John, Esq.	5	0	0
Trinity House, The	2	2	0
Trinity Terrace Contribution Box	5	0	0
Trotter, Miss	5	0	0
Turnbull, John, Esq.	5	0	0
Turnbull, Mr. & Mrs. P., per the Association for Improving the Condition of the Poor.	10	0	0
Turnbull and Wilson, Messrs.	5	0	0
Tytler, G. M. Esq.	1	0	0
Tytler, J. S. Esq.	10	0	0
Usher and Co. Messrs. Andrew	1	1	0
Usher, Messrs. J. & T.	2	2	0
Urmiston, Mrs.	10	0	0
Waddell, Mrs. Peddie	5	0	0
Waddie & Co. Messrs.	5	0	0
Waddilove, Miss.	5	0	0
Waldie and Son, Messrs. James.	5	0	0
Walker, James, Esq.	1	0	0
Walker, Mrs.	5	0	0

	£.	s.	d.
Walker, Messrs. G. and J.	10	0	0
Warden and Co. Messrs. William.	5	0	0
Warrack and Co. Messrs. John.	1	1	0
Warrick and Son, Messrs.	10	6	0
Waterson and Sons, Messrs.	1	1	0
Watson, Mrs. D.	5	0	0
Watson, John, Esq.	1	1	0
Watt, James, Esq.	10	6	0
Wauchope, Moodie, and Hope, Messrs.	1	1	0
Webster, Mrs.	5	0	0
Weir, Mrs. G.	5	0	0
Weir and Co. Messrs. R. M. Rolland.	10	0	0
Wenley, James A. Esq.	1	0	0
White, Burns, & Co. Messrs.	10	0	0
White & Co. Messrs. R.	5	0	0
White, John, Esq.	5	0	0
White, Mr. John	5	0	0
White, Moir, and Co. Messrs.	5	0	0
White, Mrs.	5	0	0
Whyte and Son, Messrs. A.	5	0	0
Williamson, Charles, Esq.	10	6	0
Wilson, A. H. Esq.	1	0	0
Wilson, Dr.	5	0	0
Wilson, Miss.	10	0	0
Wilson, W. S. Esq.	10	0	0
Wishart and Sons, Messrs. James.	1	1	0
Wishart, D. F. Esq.	10	6	0
Wood & Co. Messrs.	5	0	0
Wood, John A. Esq.	5	0	0
Wood, Misses	5	0	0
Wood, W. Esq.	1	0	0
Wren, Mr. George	5	0	0
Wright, Messrs. P. and R.	5	0	0
Wright, H. Guthrie, Esq.	10	0	0
Wright, John P. Esq.	5	0	0
Young, James, Esq. M.A.	5	0	0
Young, J. W. Esq.	10	0	0
Young, Mrs.	10	0	0
Young, Mrs. R.	5	0	0
Younger, Robt. Esq.	10	0	0
Younger and Co. Messrs. W.	1	1	0
Total.....	390	11	10

Donations.

Church, Glas-gow, per W. D. Slater	1	0	0
D——c, —	2	0	0
Geddes, Miss, and Friends	2	6	0
Gibson & Co. Messrs. George	1	0	0
London & Edinburgh Shipping Co.	2	0	0
Milne, Admiral, Sir Alexander, G.C.B.	3	3	0
Total Dons.	11	9	0
Total Subs. . .	390	11	10
	£402	0	10

MUSSELBURGH BRANCH.

Treasurer and Hon. Secretary—  
JOHN RAMSAY, Esq.  
Collector—  
Mr. THOS. HALL.

Annual Subscriptions.

	£.	s.	d.
Aitchison, Colonel	5	0	0
Beveridge, Rev. J. G.	5	0	0
Black, A. D. M. Esq.	10	0	0
Cowie, Mr. W.	5	0	0
Currie, Mr. John	5	0	0
Deans and Moore, Messrs.	5	0	0
Home, Mr. A. M.	10	0	0
Hope, Major-Gen.	10	0	0
Hope, Sir Archibald, Bart.	1	0	0
Hunter, Mr. Henry H.	5	0	0
Innes, Mr. A.	5	0	0
Kemp & Co. Messrs. J.	5	0	0
Livingstone, Mr. John	10	0	0
Macfarlane, Mr. A. D.	5	0	0
Menzies, Mrs.	5	0	0
Millar, Mrs., Spring Bank.	5	0	0
Millar, Mr. James	5	0	0
Mitchell, Mr. Alex.	5	0	0
Park, Mr. Jas.	5	0	0
Ramsay, John	5	0	0
Smart, Mr. Charles	5	0	0
Smith, Rev. C.	10	0	0
Stirling, Brothers	5	0	0
Stuart, Messrs. J. & W.	1	1	0
Thomson, Mrs. C. J.	5	0	0
Whitelaw, Mr. David	5	0	0
Wilkie, Messrs. J. & A.	10	0	0
Contributions under 5s.	2	14	6
Total	£12	10	6

Elginshire.

LOSSIEMOUTH BRANCH.

Chairman—  
Capt. J. B. DUNBAR BRANDER of Pitgavenny.

Honorary Secretary—  
MR. JOHN FERGUSON.

Annual Subscriptions.

	£.	s.	d.
Anderson, Capt.	5	0	0
Anderson, Wm. Esq.	1	0	0
Brander, Capt. Dunbar	2	0	0
Brander, R. Esq.	5	0	0
Cameron, Alex. Esq.	10	6	0
Forsyth, D. Esq.	5	0	0
Forsyth, Miss	5	0	0
Gatherer, Geo. Esq.	5	0	0
Jameson, James, Esq.	5	0	0
Johnstone, Major	5	0	0
Levack, Mr. John	5	0	0
Macdonald, W.	5	0	0
Maitland, Miss.	10	6	0
McLean, Dr.	5	0	0
Milne, J. Esq.	5	0	0
Morrison, A.	5	0	0
Munro, John	5	0	0
Priest and Co. Messrs. Wm.	5	0	0
Richmond, His Grace the Duke of	1	1	0
Robertson, Miss.	7	6	0
Sellar, J. and Sons	5	0	0

	£.	s.	d.
Smith, Sheriff	5	0	0
Stuart, J. P. Esq.	5	0	0
Webster, Dr.	5	0	0
Weir, Rev. Wm.	5	0	0
Wood, Mrs.	10	0	0
Sums under 5s.	5	4	6
Total	£15	19	0

ifeshire.

ANSTRUTHER BRANCH.

President—  
His Worship the Provost.  
Honorary Secretary—  
H. B. MACKINTOSH, Esq.

Annual Subscriptions.

	£.	s.	d.
Adamson, John, Esq.	10	0	0
Anderson, W. H. Esq.	5	0	0
Cook, David, Esq.	5	0	0
Darste, Mrs. G.	10	6	0
Darste, J. R. Esq.	1	1	0
Forbes, R. Esq.	7	6	0
Fowler, G. S. Esq.	1	0	0
Fowler, Miss	5	0	0
Irvine, W. D. Esq.	1	0	0
Jamieson, W. T. Esq.	7	6	0
Lloyd, Rev. F. K.	5	0	0
Mackintosh, H.B. Esq.	10	6	0
Murray, Wm. Esq., J.P.	10	6	0
Olyphant, P. Esq.	10	6	0
Sea Box Society	1	1	0
Sharp and Murray, Esqrs.	10	0	0
Watson, Provost	5	0	0
Williamson, Milligan and Co. Messrs.	2	0	0
Williamson, Mrs.	10	0	0
Williamson, S. Esq. M.P.	1	0	0
Woodcock, Dr. R.N.	5	0	0
Contribution Box	3	0	0
Sums under 5s.	6	8	6
Total	£19	10	6

DUNFERMLINE BRANCH.

President—  
Ex-Provost MATHESON.  
Honorary Secretary—  
ROBERT STEEDMAN, Esq.

Annual Subscriptions.

A Lady Friend	1	0	0
Alexander, Daniel	5	0	0
Alexander, Thomas	1	0	0
Alexander, Thomas, Jun.	10	0	0
Barclay, John	5	0	0
Bardner, Henry	5	0	0
Beveridge, Erskine	10	0	0
Beveridge, H.	10	0	0
Clark, W. and Son	5	0	0
Donald, Robert	1	0	0
Dunbar, Rev. J. W.	5	0	0
Hay, James	5	0	0
Hay, Mrs.	5	0	0
Hay and Robertson	1	0	0
Inglis, William	5	0	0
Laudale, John	10	0	0
Macfarlane, James	1	0	0

BRANCHES—LIST OF ANNUAL SUBSCRIPTIONS AND DONATIONS. 371

	£.	s.	d.
McLaren, John and William	-	10	0
Mathieson, K.	-	5	0
Mathewson, James	-	10	0
Mathewson, William	1	0	0
Morris, Dr.	-	5	0
Nicholson, W.	-	5	0
Reid, Robert	-	5	0
Romanes, Archibald	-	5	0
Rutherford, D. G.	-	5	0
Sampson, John	-	5	0
Seath, Alexander	-	5	0
Scobie, Andrew	-	5	0
Smith, Adam	-	5	0
Spowart, Thomas	1	0	0
Steedman, Robt.	-	5	0
Stewart, R. W.	-	5	0
Taylor, Mrs. Peter	-	5	0
Walker, Thomas	1	0	0
Wallace, Andrew	1	0	0
Walls, James	-	5	0
Wardlaw, Jas. L.	-	5	0
Westwood, Wm.	-	5	0
Wilson, John	-	5	0
Wilson, Robert M.	-	10	0
Sums under 5s.	6	19	6
Total	£25	14	6

ST. ANDREW'S BRANCH.

Chairman—  
Capt. JACKSON.

Treasurer—  
ANDREW SYME, Esq.

Honorary Secretary—  
GEO. MURRAY, Esq.

**Annual Subscriptions.**

Brown, Misses	-	5	0
Bulkeley, G.	-	5	0
City of St. Andrews	5	0	0
Jackson, Capt.	3	0	0
McGregor, Gregor	-	5	0
Moir, J. W.	-	5	0
Oiphant, T. T.	-	10	6
Welch, Bailie	-	10	0
Whyte-Melville, J.	-	10	0
Total	10	10	6

**Donations.**

Aikman, A.	-	5	0
Balfour, James	-	5	0
Boyd, Major	-	5	0
Cathcart, R.	-	5	0
Christie, Mrs. per Miss Cook	1	0	0
Curwen, R. E.	-	5	0
Dalziel, R. A.	-	5	0
General, Lord Justice	5	0	0
Gillon, A.	-	10	0
Haldane, James	-	5	0
Jackson, Capt. G. H.	-	10	0
Kinloch, Sir Alex. Bart.	-	10	0
Mansfield, J.	-	5	0
McDougal, T.	-	5	0
Milton, W. T.	-	10	0
Monypenney, Lt.-Col.	-	5	0
Nicholson, John	-	5	0
Ochlerlony, Sir C. M. Bart.	-	5	0
Oswald, J.	-	5	0
Patton, Mrs. Malcolm	-	10	0
Ramsay, Lady	-	5	0
Ranken, R. R.	-	5	0
Sibbald, J.	-	5	0
Stirling, T.	-	10	0
Stuart, A.	-	5	0
Thomas, T. A.	-	5	0
Webster, J. R.	-	5	0
Sums under 5s.	9	17	9
Total	18	17	9

**Annual Subscriptions**  
in aid of "Ladies Own" Life-boat—  
per Miss Smithers—  
A Friend, per Mrs. Prince.

Prince	1	1	0
Clegg, E. A.	1	1	0
Law, A.	1	1	0
Law, W.	1	1	0
Parr, B.	-	5	0
Prince, Rev. W.	-	5	0
Prince, Mrs.	-	5	0
Smithers, Miss	-	11	0
Stevenson, J. S.	1	1	0
Total Dons.	18	17	9
Total Subs.	10	10	6

£25 19 3

Forfarshire.

ARBROATH BRANCH.

Chairman—  
ALEX. REID, Esq., Provost of Arbroath.

Honorary Secretary—  
Wm. CARGILL, Esq.

**Annual Subscriptions.**

	£.	s.	d.
Aitken, Mr.	-	5	0
Anderson, Mr. David	-	5	0
Balfour & Cummings, Messrs.	-	10	0
Binney, Mr. Andrew	-	10	0
Boyd, Mr. James	-	5	0
Briggs, W.	-	5	0
Burnet, Mr. William	-	5	0
Cargill, Mr. David	-	5	0
Carnegie, H. F. Lind-say, Esq.	-	10	0
Chapel, Mr. David	-	5	0
Christie, Miss	-	5	0
Corsar, Mr. Chas. W.	-	10	0
Corsar, Mr. Wm. H.	-	10	0
Corsar Bros. Messrs.	-	10	0
Dickson, Mr. Jas. A.	-	10	0
Dickson, Mr. J. F.	-	5	0
Donaldson, Mr. Robt.	-	5	0
Duncan, Mr. John	-	10	0
Ferguson, Messrs. J. and A.	-	5	0
Forbes, Mr. Thos.	-	5	0
Fraser and Sons, Messrs. D.	-	10	0
Fraser, Mr. Pat. A.	1	0	0
Gordon, A.	-	10	0
Guthrie and McCord-quodale	-	5	0
Jamieson, J.	-	5	0
Laird, Mr. George	-	10	0
Lowson, Mr. Andrew	-	10	0
Macdonald, J. & W.	-	10	0
Min, Mr. George	-	5	0
Muir, Mr. James	-	10	6
Nicol & Co. Messrs. A.	-	5	0
Pierson, Mrs.	-	1	0
Raitt, Mr. Jonathan	-	5	0
Reid, Mr. Alex.	-	5	0
Robertson, George.	-	5	0
Roy, Messrs. Adam & Sons	-	5	0
Salmond and Son, Messrs. W.	-	10	0
Salmond, Mr. Jos.	-	5	0
Shanks, Mr. James	-	5	0
Smart and Ogg	-	5	0
Webster, Messrs. F. and Sons	-	10	0
Webster, Mr. Wm.	-	10	0
Weir, Mr. James	-	5	0
Sums under 5s.	4	0	0
Total	20	10	0

**Donations.**

Collected at Shore Dues Office	6	5	6
Collected in Box at Life-boat House	1	2	5
Total	£27	17	11

DUNDEE BRANCH.

Chairman—  
Wm. O. DALGLEISH, Esq.

Treasurer—  
Wm. CRAIGTON, Esq.

Honorary Secretary—  
JAMES HUNTER, Jun., Esq.

**Annual Subscriptions.**

Alison, G. L. Esq.	1	1	0
Anderson, Alex. Esq.	1	1	0
Armitstead and Co. Messrs. G.	1	1	0
Baxter Brothers and Co. Messrs.	3	0	0
Baxter & Co., Messrs. W. E.	1	1	0
Brunswick, Mrs.	1	0	0
Don Brothers, Buist, and Co. Messrs.	1	1	0
Dundee Harbour Trustees	10	10	0
Dundee Shipping Insurance Association	2	2	0
Dundee, Perth, and London Shipping Company	1	1	0
Gibson, Joseph, Esq.	10	6	0
Gilroy, Sons and Co. Messrs.	1	1	0
Gourlay Brothers and Co. Messrs.	2	2	0
Grimond, Messrs. J. and A. D.	1	1	0
Laing, John, Esq.	10	6	0
Lowson, Wm. Esq.	1	1	0
McGavin, R. Esq.	1	1	0
Martin & Co. Messrs. D.	1	1	0
Masters and Seamen, Fraternity of	5	5	0
Miller, O. G. Esq.	1	1	0
Molison, Mrs. F.	5	5	0
Myles, David, Esq.	1	1	0
Ogilvy, Sir J. Bart.	1	1	0
Pearce, Mrs. A. M.	1	0	0
Sandeman, C. S. Esq.	10	6	0
Sharp, John, Esq.	1	1	0
Smieton and Sons, Messrs. James	1	1	0
Smth & Co. Messrs. Henry	1	1	0
Stephen, Mrs. George	1	1	0
Union Association of Underwriters	5	5	0
Yeaman, James, Esq.	1	1	0
Total	56	19	6

**Donations.**

Pirie, David	-	10	0
Kennedy & Rae	-	5	0
Box at Broughty Ferry	-	5	0
Dundee Harbour, Life-boat Dues on Shipping	17	8	11
Collected by John Machan, Esq. from Seamen frequenting the Port	7	5	0
Total Dons.	25	13	11
Total Subs.	56	19	6
Total	£82	13	6

MONTROSE BRANCH.

Chairman—  
Provost MITCHELL.

Honorary Secretary—  
JAS. WARRACK, Esq.

**Annual Subscriptions.**

	£.	s.	d.
Aberdein, F. Esq.	1	0	0
Anderson, Messrs. J. & Co.	-	5	0
Baxter, David, Esq.	-	5	0
Burnett, Alex. Esq.	-	5	0
Burrell, Geo. Esq.	-	5	0
C. S.	-	10	6
Carnegy, Miss Elizabeth	2	0	0
Chalmers, Geo. C. Esq.	-	5	0
Dickson, Arthur, Esq.	-	10	6
Davidson, Capt. D. C.	-	5	0
Farfor, Capt.	-	5	0
Findlay, J. R.	-	5	0
Gibbons, R. Esq.	-	5	0
Gordon, Mrs. W.	1	0	0
Greig, A. Esq.	-	10	6
Interest from Harbour Trustees	30	0	0
Japp, J. and F.	-	5	0
Johnston, J. & Sons	5	0	0
Key, Dr. Andrew	-	10	6
Largie, Capt. A.	-	10	6
Lindsay and Son, Messrs. John	-	10	6
Lawrence, Dr. S.	-	5	0
Mackenzie & Sons, Messrs. J.	-	5	0
Mearns, Alex. Esq.	1	0	0
Middleton and Sons, Messrs. C.	-	7	6
Middleton, Thos. Esq.	-	5	0
Millar, R. & Sons, Messrs.	2	2	0
Milne, John, Esq.	-	5	0
Mitchell, Wm. Esq.	1	0	0
Moir & Son, Messrs. Wm.	-	5	0
Montrose Lime Co.	-	10	0
Murray & Co. Messrs.	-	10	6
Myers, Geo. C. Esq., Owners of Mary Johnston	-	5	0
Reid, Capt. Henry	-	5	0
Reid, John, Esq.	-	5	0
Renny, Miss	-	1	0
Ross, Oliver, Esq.	-	5	0
Samsen, James, Esq.	-	5	0
Savege, James, Esq.	-	10	6
Stansfeld, Capt. R.A.	2	0	0
Steele, Dr. H.	-	10	0
Walker, George, Esq.	-	5	0
Warrack, J. and Co.	1	1	0
Watson, Dr.	-	5	0
Watt, Alex. Esq.	-	5	0
Whimster, W. S.	-	5	0
Small Subscriptions	3	10	0
Cash in Collecting Boxes	-	19	2
Total	£63	19	2

Haddingtonshire.

DUNBAR BRANCH.

President—The Duke of Roxburgh. Chairman—Richard W. Hunter of Thurston. Honorary Secretary—G. R. Scott, Esq. Annual Subscriptions. Anderson, W. 10 0. Brand, Provost 10 0. Donations. France, Peter 1 0 0. Hunter, Richd. 1 0 0. Rennie, Wm. 1 0 0. Scott, G. R. Esq. 10 0. Contribution Box 4 10. Total £4 14 10.

NORTH BERWICK BRANCH.

President—The Right Hon. Lady Mary Hamilton. Chairman—Sir Hew Dalrymple, Bart. Honorary Secretary—David McCulloch, Esq. Annual Subscriptions. Cree, James, Esq. 1 0 0. Innes, J. B. Esq. for 1879, 1880 2 0 0. Suttie, Capt., R.N. 1 0 0. Suttie, Mrs. 10 0 0. Malcolm, Walter, Esq. 1 0 0. McCulloch, D. Esq. 10 6. McIntyre, Mrs. per Capt. Suttie 1 0 0. Woodrow, T. Esq. 10 6. Total 7 11 0.

Donations. Collected at annual exercise of Life-boat, including £5 from the Right Hon. Lady Mary Hamilton 48 15 1. A Friend, 28 Aug. 1 0 0. A Friend, 9 Sept. 1 0 0. Baird, Mrs. per Sir H. D. 1 0 0. Beveridge, W. Esq. 10 0. Campbell, Esq. per Mr. Malcolm 2 0 0. Campbell, W. Esq. 1 0 0. Dawson, Mr. per Mr. Cree. 1 0 0. Gemmell, Mr., per Sir H. D. 1 0 0. Innes, Mrs. Mitchell 10 0. Jeffrey, Mr. 1 0 0. Laurie, W. Esq. 12 6. Lord, W. 5 0 0. Menzies, Mrs., West Links 1 1 0. From Collecting Box at Boat-house 8 3. Total Dons. 65 16 10. Total Subs. 7 11 0. £73 7 10.

Wincardineshire.

GLORDON BRANCH.

President—James Farquhar, Esq., Hallgreen. Chairman—Hercules Scott, Esq., Brotherton. Honorary Secretary—Rev. John Brown, Bervie. Anderson, Mr. Wm. 5 0. Boath, Mr. David 5 0. Brown, Rev. John 5 0. Bryden, Mr. Wm. 5 0. Collins, Dr. A. 5 0. Collins, Dr. T. 10 0. Craighhead, Mr. 10 0. Dickson, Patrick, Esq. 10 0. Farquhar, James, Esq. 5 5 0. Farquhar, Captain H. R., 24th Regt. 3 3 0. Forbes, Mr. Hector 5 0. Gibb, James, Esq. 10 0. Gladston, Sir Thos. 2 0 0. Glegg, Messrs. 5 0. Guthrie, Mrs. 5 0. Legg, Mr. D. 5 0. Legg, M. A. 10 0. McLachlan, Mr. 5 0. Moir, Mrs. 5 0. Mollison, Mr. 5 0. Reid, Mr. D. 5 0. Scott, Hercules, Esq. 10 10 0. Shand, T. L. R., Esq. 1 0 0. Somerville, Mr. 10 0. Thom, Mr. John 5 0. Urquhart, Mr. Duncan 5 0. Wilson, Provost 5 0. Sums under 5s. 1 13 6. Total 30 11 6.

STONEHAVEN BRANCH.

Patron—Sir Thos. Gladstone, Bart., Lord-Lieut. of the County. President—James G. Soutar, Esq., Banker. Treasurer & Hon. Secretary—David Carr, Esq. Annual Subscriptions. Baird, Alex. of Ury 2 2 0. Davidson, late Mrs., interest on legacy 13 5. Duff, R. W. Esq. 1 1 0. Falconer, Robert 5 0. Greig, George A. 5 0. Innes, Major 1 0 0. Kinneer, A. W. 10 0. Jack, James 5 0. Martin, Thomas 5 0. McInroy, Colonel 2 0 0. Mowat, Wm. 5 0. Reddie, Captain J. G. 1 0 0. Ritchie, Wm. 1 0 0. Scott, James 10 0. Smith, Thomas 5 0. Tindal, Robert 10 0. Watt, Rev. John 5 0. Wylie, George 5 0. Sums under 5s. 5 6 6. Total 17 12 11.

Donations. Sir George Balfour, M.P. 2 0 0. Collection Box at Boat-house 7 1 0. £20 0 0.

Kirkcudbright.

KIRKCUDBRIGHT BRANCH.

Patron—The Earl of Selkirk. President—Wm. Martin, Esq. Treasurer and Hon. Sec.—James McMuldrow, Esq. Annual Subscriptions. Selkirk, Right Hon. the Earl of 3 3 0. Barbour, William, Esq. 1 1 0. Cowan, John, Esq. 1 0 0. Gordon, R. M. Esq. 5 0. Hamilton, Geo. Esq. 5 0. Kennedy, J. L. Esq. 1 0 0. Kenworthy, James, Esq. 5 0. Kirkcudbright, Burgh of 5 0 0. Martin, Wm. President 5 0. Maxwell, Sir Wm., Bart. 2 0 0. Maxwell, W. H. Esq. 1 0 0. Maxwell, Mr. J. H. 10 0. Mackie, J. G. Esq. 2 2 0. McLellan, David, Esq. 5 0. McMuldrow, James, Esq. 5 0. Milroy, A. J. Esq. 5 0. Murray-Stewart, H. G. Esq. 1 1 0. Nicolson, Sheriff 5 0. Oswald, R. A. Esq. 1 0 0. Proprietors of the Dumfries Standard Robinson - Douglas, W. D. Esq. 1 1 0. Skirving, Adam, Esq. 1 0 0. Wigram, Loftus J., Berkeley Square, London, Esq. 1 1 0. Williamson, Provost 5 0. Sums under 5s. 1 8 0. Total 26 2 0.

Donations. Bean, Thos. Esq. 5 0. Gordon, William, Esq. 1 0 0. Threave 1 0 0. Heron - Maxwell, Capt., M.P. 2 0 0. £29 7 0.

Wanarkshire.

GLASGOW BRANCH.

Treasurer—James A. Small, Esq. Honorary Secretary—R. Hope Robertson, Esq. Annual Subscriptions. A Friend 10 6. Addie, Robert, and Sons 2 2 0. Aitken and Waddell 2 2 0. Aitkin, Lilburn, and Co. Messrs. 1 1 0.

£. s. d. Alexander Brothers 10 0. Alexander, Ferguson, & Co. Messrs. 1 1 0. Alexander, A. Lennox & Co. 10 6. Alexander, Mr. J. 5 0. Alexander and Messrs. R. F. & J. 1 1 0. Alston, J. Carfrae 10 0. Amigo 10 0. Andersons and Pattison 10 6. Anderson, Messrs. D. and J. 2 2 0. Anderson and Co. Messrs. Geo. 1 1 0. Anderson and Co. Messrs. James 10 0. Arnott & Co. Messrs. 1 1 0. Arthur & Co. (Limited) Messrs. 1 1 0. Arthur and Hinshaw, Messrs. 10 6. Auld & Guild, Messrs. 2 2 0. Austin and McAslan, Messrs. 10 6. Baird & Brown, Messrs. 1 1 0. Baird and Son, Messrs. Hugh 10 6. Balloch, Robt. & Co. 10 6. Bannatynes, Kirkwood, and McJanet 2 2 0. Barclay & McGregor, Messrs. 1 0 0. Barclay, Curle, and Co. Messrs. 4 4 0. Barr, W. B. 1 1 0. Bell & Sons, Messrs. John 1 1 0. Bell, Edmund 10 0. Bennett, Browne, and Co. Messrs. 1 1 0. Berry, Barclay & Co. 1 1 0. Bilsland Brothers 1 1 0. Binnie, Thomas 10 6. Black & Co. Messrs. James 1 1 0. Black & Co. Messrs. John 2 2 0. Blackie and Sons, Messrs. 1 1 0. Blanefield Printing Company 1 0 0. Bost and Co. A. 1 1 0. Boyd, W. and Co. 10 6. Boyle, Miss E. C. 1 0 0. Boyd, Thos. and Co. 10 6. Braby, Fred. & Co. (Limited) 10 6. British and African Steam Navigation Co. 2 2 0. British India Steam Navigation Company (Limited) 2 2 0. Brown & Co. Messrs. J. and T. 1 1 0. Brown & Co. Messrs. W. and A. 1 1 0. Brown and Polson 5 0 0. Brown, Daniel 5 0. Brown, Downs, and Co. Messrs. 1 1 0. Brown, James, Esq. 2 2 0. Brown, jun., Davies & Tait, Messrs. 5 0. Brown, Sons, & Co. Messrs. Wm. 2 2 0. Browne and Watson 1 1 0. Browne, Easton, & Co. Messrs. 2 2 0. Brownlie and Co. 1 1 0. Browns & Co. 1 1 0. Bryce and Rumpff 10 6. Bryce, J. D. Esq. 1 1 0. Buchanan, Walter 5 0. Buchanan, Watson, and Co. Messrs. 1 1 0. Bulloch, Lade, & Co. Messrs. 2 0 0. Burnley and Co. Messrs. W. F. 2 2 0.



BRANCHES—LIST OF ANNUAL SUBSCRIPTIONS AND DONATIONS. 373

£.	s.	d.	£.	s.	d.	£.	s.	d.	£.	s.	d.	
Burns, Messrs. G. and			Ferguson and Reid,			Irvin and Co. Messrs.			Mackie, J. L.....	-	10	6
J.....	2	0	Messrs.....	-	10	Samuel.....	1	1	MacLean, Neil.....	-	10	6
Burrell and Son,			Finlay & Co. Messrs.			Jackson and Co.			McPear, Robt. & Co.	-	10	6
Messrs.....	1	1	James.....	2	2	Messrs. John.....	-	10	Mulloch, Messrs. C.	-	10	6
Calton Spinning Co.	1	1	Fisher and Watt,			Jaakson, John.....	-	10	and J.....	-	10	6
Campbell and Co.			Messrs.....	1	1	Jamieson, R. Esq....	1	1	Mann, Byars, and			
Messrs. J. and W.	3	3	Fleming, Messrs. P.			Jeffrey, R. and Sons	-	10	Co. Messrs.....	1	1	0
Campbell, Jas. A.			and R. & Co.....	1	1	Johnston, James, Mr.	-	10	Martin, John, Esq....	-	10	6
Esq., M.P., LL.D.	1	1	Forsyth, Miller, and			Kelly & Co. Messrs..	1	1	Martin, Turner, and			
Campbell, Rivers, and			Co.....	1	1	Kerr, Anderson, Muir			Co. Messrs.....	1	1	0
Co. Messrs.....	2	2	Frame, Thos. & Co..	-	10	and Main, Messrs.	2	2	Mason, G. and R....	-	10	6
Cargill, David S.....	-	10	Fraser, Alex. Esq....	1	1	Kerr, Newton, & Co.			Mathew, Paul, & Co.	1	1	0
Caw, David.....	-	5	Fraser and Sons,			Messrs.....	1	1	Middleton and Kirk-			
Chaplin and Co.			Messrs. John.....	1	1	Kettle and Co. Messrs.			patrick, Messrs....	-	10	6
Messrs. Alexander	-	10	Fraser, Gordon, & Co.	1	1	R.....	-	10	Millar & Son, Messrs.			
Chrystal, Robert, Esq.	1	1	Fyfe and Morton,			Keydens, Strang and			John.....	1	1	0
Clark and Co.....	2	2	Messrs.....	-	10	Girvin, Messrs....	-	10	Miller and Co. Messrs.			
Clark, Messrs. J. Jun.			Gairdner, Chas. Esq.	1	1	Kidston & Co. Messrs.			G.....	2	2	0
and Co.....	2	2	Gairbraith, Messrs. A.			A. G.....	1	1	Miller Brothers.....	-	10	6
Clyde Shipping Co....	2	2	and A.....	2	2	Kidston and Sons,			Miller, James, Son,			
Clyde Yacht Club....	2	2	Garroway, Messrs.			Messrs. Wm.....	1	0	& Co. Messrs.....	1	1	0
Coathridge Tin Plate			R. and J.....	1	0	Kirkpatrick, A. B....	-	10	Mirrieas, Tait, and			
Comp. (Limited)....	1	1	Gibb, Elias, Esq....	-	10	Laing and Co. Messrs.			Watson, Messrs....	2	2	0
Coats, Messrs. J. & P.	2	2	Gilbert, Mrs. Crerar.	2	0	J.....	1	1	Mitchell, D.....	1	1	0
Cochran, A. and R....	1	1	Gibson, Robt. T....	1	1	Laird, Alex. A. & Co.	1	1	Mitchell, Watson,			
Cochrane, J. R.....	1	0	Giffillan, J. and T..	-	10	Lamont, Messrs....			and Wink, Messrs.	4	4	0
Collins, Sons, and Co.			Glasgow Iron Co....	2	2	Henry.....	1	1	Mitchells, Cowan, &			
Messrs. William....	2	2	Gourlay, Robt.....	1	1	Langlands and Sons,			Johnstone, Messrs.	1	1	0
Connal & Co. Messrs.	1	1	Gourlie and Son,			Messrs. M.....	1	1	Moncreiff, Paterson,			
Connal & Co. Messrs.			Messrs. William....	1	1	Law, Thos. & Co....	-	10	Forbes, and Barr,			
William.....	1	1	Govan and Son,			Lecky, F. B. & Co..	1	1	Messrs.....	2	2	0
Connell and Co.			Messrs. Wm.....	1	1	Leisler, Bock, and Co.			Moore and Browne,			
Messrs. Charles....	1	1	Gow & Co. Messrs.			Messrs.....	2	2	Messrs.....	-	10	6
Crailsheim and Her-			Allan C.....	1	1	Liepmann, Lehmann,			Moore, Taggart, and			
man, Messrs.....	1	1	Graham, John, Esq..	1	1	and Co. Messrs....	1	1	Co. Messrs.....	1	1	0
Crawford, Cree, and			Graham & Co. Messrs.			Lietke & Co. Messrs.	1	1	Mossend Iron Co....	1	1	0
Co. Messrs.....	1	1	William.....	2	2	Lorimer & Moyes....	1	1	Muncie, Geo.....	1	1	0
Cree, T. S.....	-	10	Graham, Messrs. A.			Lumsden, Geo. Esq..	2	2	Murdoch and Co.			
Crouch, Wm.....	-	10	J. and A.....	2	2	MacArthur and Farie	1	0	Messrs. Robt.....	1	1	0
Cruickshank, R. and			Grant & Son, Messrs.			McAulay and Co.			Napier and M'Intyre,			
Son.....	1	1	G.....	1	1	Messrs. James.....	-	5	Messrs.....	2	2	0
Cruickshank, W.			Gray, Dunn, and Co.			MacBean and Co.			Neill, Messrs. J. & R.	-	5	0
& Co.....	-	10	Messrs.....	1	1	Messrs. H.....	-	10	Neilson & Co. Messrs.	2	2	0
Crum, Alex. Esq....	1	1	Gray & Co. Messrs. J.	1	1	MacBrayne, D.....	1	1	Neilson & Maxwell.	1	1	0
Cumming, J. Esq....	2	2	Gray, Mrs. Walter....	1	1	Macdonald, Hood, &			Neuhaas, Chas.....	1	1	0
Dalgligh, Falconer, &			Grischotti, Fleming,			Co. Messrs.....	1	1	Nimmo, Jas. & Co..	1	1	0
Co. Messrs. R.....	1	1	and Co.....	-	5	MacKenzie & Aitken	1	1	Nisbet, Messrs. A. &			
Dalziel and Sons,			Gumprecht & Stewart	1	1	Mackenzie, Gardner,			J.....	1	1	0
Messrs. J.....	-	5	Harrington, J. P....	1	1	and Alexander,			Nitshell and Lesma-			
Davidson, Alex.....	-	5	Hart, John.....	1	1	Messrs.....	1	1	hagow Coal Co....	2	2	0
Davidson, W. J. Esq.	2	2	Harvie, Alex. Esq..	1	1	Mackinnon and Co.			Owners of barque			
Denniston and Co.			Hay, Jas. and Sons.	1	1	Messrs. William....	2	2	Jane Ure,			
Messrs. Peter.....	1	1	Hatfield, Cameron,			Maclae, A. Crum,			per			
Denny and Co.....	2	2	and Co.....	-	5	Esq.....	1	1	Messrs. Browne &			
Denny, Wm. Brothers,			Hedderwick, James,			Maclay, Murray, and			Watson.....	-	5	0
Messrs.....	2	2	Esq.....	-	10	Spens, Messrs....	2	2	Owners of barque			
Dick, R. and J.....	2	2	Henderson and Co.			MacLellan, Messrs.			Annie, per Messrs.			
Dick, W. B. and Co.	-	10	Messrs. Patrick....	2	2	P. and W.....	2	2	Browne & Watson	-	5	0
Dill, Wilson, & Muir-			Henderson, Bros....	3	3	Macléod, Rev. D.,			Do. Bina Campbell,			
head.....	-	10	Henderson, Miss....	-	10	D. D.....	-	10	per do.	-	5	0
Donald, Mr. Thos....	-	10	Henderson and Co.,			Macpherson, H. S. and			Do. Dalhousa,			
Donaldson Brothers,			Messrs. D. and W..	2	2	Co.....	1	1	per do.	-	5	0
Messrs.....	1	1	Henry and Co.			M'Call and Son,			Do. Eliza Campbell,			
Douglas, R. & Son,			Messrs. A. and S..	1	1	Messrs. James.....	1	1	per do.	-	5	0
Messrs.....	-	10	Herbertson and Co.			M'Clure, Naismith,			Do. Isabella Ure,			
Dow, Archd. Esq....	1	1	Messrs. Hy.....	-	10	Brodie & Macfar-			per do.			
Dunlop, Thos. Esq..	-	15	Hertz, Theodore....	2	2	lane, Messrs....	1	1	Do. Janet M'Nichol,			
Dunn & Son, Messrs.			Hill, R. and J. M....	2	2	M'cowan, David,			per do.	-	5	0
D.....	1	1	Brown, and Co....	2	2	Esq.....	1	1	Do. Jessie,			
Dunn Brothers.....	-	10	Hinselwood, J. and			M'Dowall, Steven,			per do.	-	5	0
Dunn, Jas.....	1	1	Co. Messrs.....	-	10	and Co. Messrs....	2	2	Do. Martha Reid,			
Dunn, Jas. and Sons	1	1	Holmes, Kerr, and			M'ewan, Stevenson,			per do.	-	5	0
Edington and Sons,			Hidderwick.....	-	10	and Leask, Messrs.	1	0	Do. Mary, per do.	-	5	0
Messrs. T.....	2	2	Houldsworth and Co.			M'Gavin, John.....	1	1	Do. Marg. Mitchell,			
Edmiston and Mit-			Messrs. J.....	2	2	M'Gregor, Alex. Esq.	1	1	per do.	-	5	0
chells, Messrs....	1	1	Howat, Messrs. D. G.			M'Grigor, Donald &			Do. Marg. Craig			
Edmiston, J. and E.	-	10	& Co.....	1	1	Co.....	2	2	per do.			
Elder & Co. Messrs.	2	2	Howat and Sons,			M'Laren, Sons, & Co.			Ada Browne.....	-	5	0
Ewing & Co. Messrs.	2	2	Messrs. Jas.....	-	10	Messrs. William....	1	1	Pasley, Jardine, and			
A. Orr.....	2	2	Hurlet and Campsie			McCall and Stephen,	-	10	Co. Messrs.....	1	1	0
Ewing & Co. Messrs.			Alum Co.....	1	1	McClelland, MacKin-			Paterson and Son,			
J.....	2	2	Hutchison, Messrs.			non, and Blyth,			Messrs. Wm.....	1	1	0
Ewing & Co. Messrs.			J. and P.....	1	1	Messrs.....	-	10	Paterson, Andrew,			
J. Orr.....	2	2	Hydepark Foundry			McDonald, Mrs.....	1	0	Esq.....	1	1	0
Farquhar & Rox-			Company.....	-	10	McMillan, Arch. and			Pearson, Adam, and			
burgh, Messrs....	-	10	Incorporation of			Son.....	2	0	Co.....	1	1	0
Ferguson and Sons,			Skinners (per Mr.			McEwan, Robt. D.			Pirrie, Foote, and Co.			
Messrs. James.....	-	10	Greig)	1	1	Esq.....	-	10	Messrs.....	1	1	0
Ferguson and Bros.			Ingils and Wakefield,			Macfarlane, George			Pitkethly, James,			
Messrs. J.....	2	2	Messrs.....	1	1	Gray.....	1	1	Esq.....	1	1	0
Ferguson and For-			Ingils, Messrs. A.			MacIndoe Brothers	1	1	Phillips, John, & Co.			
rester.....	-	10	and J.....	2	2	MacKenzie, David....	-	10	Messrs.....	-	10	6

£.	s.	d.	Teacher and Sons,	£.	s.	d.
			Messrs. William...	2	2	0
			Templeton and Co.	2	2	0
			Messrs. James...	2	2	0
			Tennant and Co.	3	3	0
			Messrs. Charles...	3	3	0
			Thomson, Aikman,			
			and Co. Messrs...			
			Thomson and Gray			
			Thomson, Henry...			
			Thomson, Jas. & Geo.			
			Thomson, Neale...			
			Thomson, Sir Wm.			
			Thompson, Dickie,			
			& Co. for Barques			
			<i>Blairhoyle, 21s. &amp;</i>			
			<i>Craigard, 21s.</i>	2	2	0
			Train & Co. Messrs.			
			Thomas Messrs...			
			Turnbull and Co.			
			Messrs. ....			
			Turnbull, Martin,			
			Co. ....			
			Ure, John, Esq.			
			Walker, A. Esq.			
			Walker & Co. Messrs.			
			John .....			
			Walker & Hamilton,			
			Messrs. ....			
			Wallace, William			
			Watson, Gow, and			
			Co. Messrs. ....			
			Watson and Smith,			
			Messrs. James...			
			Watson and Co.			
			Messrs. James...			
			Watson Bros. ....			
			Watson, John E. .			
			Wharrie, Colledge &			
			Brand, Messrs. .			
			White, Messrs. James			
			and John .....			
			Wilkie, Wm. Esq. .			
			Williamson, T. .			
			Wilson and Son,			
			Messrs. Jas. ....			
			Wilson, Mathison, &			
			Co. Messrs. ....			
			Woodrow, Alexander,			
			& Sons, Messrs. .			
			Wordie and Co. ....			
			Wotherspoon and Co.			
			Messrs. R. ....			
			Wright, J. Brooks,			
			Esq. ....			
			Wright, Johnstone,			
			and Mackenzie,			
			Messrs. ....			
			Total. ....	421	0	6
<i>Donations.</i>						
			Association of Under-			
			writers. ....	20	0	0
			Collected on board			
			s.s. <i>Rathlin</i> , per			
			Clyde Shipping Co.			
			Collected by Free St.			
			Mathews Children's			
			Church. ....	1	0	0
			Total Dons. ....	23	2	0
<i>Legacies.</i>						
			Late Wm. Forbes,			
			Esq., per Messrs.			
			Robertson & Ross			
			Late Adam Hamilton,			
			Esq., per Messrs. R.			
			and T. Russell,			
			Paisley. ....	19	19	0
			Total Legacies. .	39	19	0
			Total Dons. ....	23	2	0
			Total Subs. ....	421	0	6
			£484 1 6			

**Linlithgowshire.**

**KIRKLISTON BRANCH.**

President—  
Rev. J. C. BURNS.  
Honorary Secretary—  
Mr. JOHN GARDINER.  
Annual Subscriptions.  
£. s. d.  
Blair, Miss ..... 7 6  
Burns, Mrs. .... 10 0  
Duncan, Miss M. . . . 1 0 0  
Duncan, Miss ..... 1 0 0  
Hog, T. A. Esq. .... 5 0  
McQueen, G. Esq. . . . 10 0  
Stewart and Co.,  
Messrs. .... 10 0  
Sums under 5s. .... 1 3 0  
Total ..... £5 5 6

**Nairnshire.**

**MORAY FIRTH BRANCH.**

Chairman—  
Provost LESLIE, Nairn.  
Treasurer & Hon. Secretary—  
H. T. DONALDSON, Esq.,  
Solicitor, Nairn.  
Annual Subscriptions.  
£. s. d.  
Dunbar, Sir James  
Alexander ..... 10 0  
Mackintosh, Hugh,  
Esq. .... 10 0  
Forres, Town of. . . . 2 2 0  
Nairn, Town of. . . . 3 3 0  
Donations.  
Sundry Donations . 10 5 0  
Total ..... £16 10 6

**Orkney Islands.**

**LONGHOPE BRANCH.**

Chairman—  
J. G. MOODIE HEDDLE, Esq.  
Honorary Secretary—  
EDWARD E. CORRIGALL, Esq.  
Annual Subscriptions.  
£. s. d.  
Heddle, J. G. Moodie,  
Esq. .... 3 3 0  
Heddle, Mrs. .... 1 1 0  
Corrigall, Edward E.,  
Esq. .... 5 0  
Laughton, John, Esq. . . . 5 0  
Coll. in Small Sums 3 8 0  
Total ..... £8 2 0  
Donations.  
Box at Miss Thompson's. . . . . 6 3  
Do. at St. Margaret's  
Hope. .... 13 6  
Other amounts. . . . . 7 4  
£9 9 1

**STROMNESS BRANCH.**

Honorary Secretary—  
Capt. G. BILTON.

Annual Subscriptions.  
£. s. d.  
Copland, J. S. Esq. . . . 5 0  
Earl of Zetland. . . . 5 0 0  
Miller, Capt. James. . . . 5 0  
Mowat, Capt. Jas. . . . 1 0 0  
Shearer, James,  
Coxswain ..... 5 0  
Spence, Jas. Esq.,  
Banker, Stromness - 10 0  
Watt, Wm. Esq. .... 5 0  
Sums under 5s. .... 7 6  
Contribution Boxes. 3 12 4  
Total ..... £11 9 10

**Peeblesshire.**

**PEEBLES BRANCH.**

President—  
T. H. ORPHOT, Esq.,  
Sheriff-Substitute.

Honorary Secretary—  
Dr. CONNELL.

Annual Subscriptions.  
£. s. d.  
Black, Capt., Kailzie 1 1 0  
Blackwood, Mr. .... 5 0  
Buchan, Mr. W. .... 5 0  
Burgess, Rev. R. .... 5 0  
Hunter, Mrs. .... 5 0  
Jeffrey, Mr. .... 5 0  
Lindsay, Miss. .... 5 0  
Linton, Mr. .... 5 0  
Mackenzie, Mr. F. . . . 1 1 0  
Melrose, Mr. .... 5 0  
McGildowny, Mr. .... 1 1 0  
Orphoot, Mr. .... 10 6  
Panton, Mr. .... 10 6  
Reddel, Mr. .... 10 0  
Scott, Mr., Milkiston - 6 0  
Stirling, Mr. .... 5 0  
Stuart, Mr. .... 1 1 0  
Tennent, Mr. .... 2 2 0  
Thorburn, Mr. M. . . . 10 6  
Thorburn, Mr. R. . . . 10 6  
Tod, Mr., St. Mary's  
Mount. .... 2 2 0  
Wallace, Mr. .... 1 1 0  
Williamson, Mr. R. . . . 5 0  
Wyer, Rev. T. .... 10 6  
Sums under 5s. .... 1 18 0

Donations.  
Hunter, Mr. .... 5 0  
Wallace, Mr. .... 10 6  
Williamson, Rev. A. . . . 2 6  
Total ..... £18 3 6

**Renfrewshire.**

**GREENOCK BRANCH.**

Chairman—  
JAMES STEWART, Esq., M.P.  
Honorary Secretary—  
E. MAXWELL, Esq., H.M.'s Customs.

*Annual Subscriptions.*

<i>£. s. d.</i>	
Baine & Johnstone, Messrs.	2 2 0
Blackwood & Gordon, Messrs.	1 1 0
Brymner, G. Esq.	10 6
Caird, C. S. Esq.	1 0 0
Caird, J. T. Esq.	2 2 0
Carmichael and Co. Messrs. J. H. & A.	1 1 0
Carmichael, T. Esq.	1 1 0
Cartsburn Sugar Refining Co.	1 0 0
Clapperton, J. Esq.	10 6
Crawford, Messrs. W. and J.	1 1 0
Cuthbert, Robert, Esq.	1 1 0
Davie, Robert, Esq.	10 0
Greive, W. Esq.	2 0 0
Greenock, St. John Lady.	2 2 0
Hogg, Allison, & Co. Messrs.	1 1 0
Johnstone, D. Esq.	2 0 0
Kerr & Co. Messrs. John	2 2 0
Lamont, Jas. Esq.	1 0 0
Lindsay and Co. Messrs. W.	1 1 0
Low, L. & Co.	5 0 0
Lyle, Abram, Esq.	2 2 0
Lyle, John	10 0
McArthur, Wm. Esq.	1 0 0
McIver, W. & Co.	10 6
Morton, James, Esq.	1 1 0
Neill, Dempster and Neill.	2 0 0
Neill, R. & S. Messrs.	10 6
Orr, Hunter and Co. Messrs.	1 1 0
Reid & Co. Messrs. J.	1 1 0
Richardson and Co. Messrs. James	2 2 0
Robertson and McDougall, Messrs.	10 6
Scott, Alexander, and Sons, Messrs.	2 2 0
Shankland, Messrs. D. and R.	2 2 0
Spiers, Lady	2 2 0
Steele and McCaskill.	10 6
Steele & Co. Messrs. Robert	2 2 0
Stewart, Messrs. J. and W.	2 2 0
Swinburne, Capt. R.N.	2 2 0
Thorne and Sons, Messrs. R.	1 1 0
Walker and Co. Messrs. John	1 1 0
<b>Total</b>	<b>52 4 0</b>

*Donations.*

Gamble, Mrs.	10 0 0
Munn, Miss	25 0 0
Pillar Boxes— Princess Pier Box.	1 4 0
Customs Quay	13 7 0
<b>Total Dons.</b>	<b>36 17 7</b>
<b>Total Subs.</b>	<b>52 4 0</b>
<b>£89 1 7</b>	

**Roxburghshire.**

**KELSO BRANCH.**

President—  
REV. D. HUNTER, B.D.  
Honorary Secretary—  
ALEXANDER MUIRHEAD, Esq.

*Annual Subscriptions.*

<i>£. s. d.</i>	
Brown, J. J. E. Esq.	1 0 0
Cunningham, Mrs.	5 0 0
Darling, J. F. S. Esq.	5 0 0
Douglas, Dr. C.	10 0 0
Douglas, Dr. Frank.	10 0 0
Douglas, Misses	10 0 0
Douglas, Sir G. H. S.	10 0 0
Bart.	1 0 0
Dunn, Mr.	5 0 0
Hogg, John, Esq.	5 0 0
Hunter, Dr. D.	5 0 0
Johnston, E. Esq.	10 0 0
Johnston, Messrs. J. and J.	5 0 0
Layton, Misses	5 0 0
Logan, P. Esq.	5 0 0
Lugton and Porteous	5 0 0
Maun, A. W. Esq.	5 0 0
McDougall, Miss Scott	2 0 0
McInnes, Mrs.	5 0 0
Muirhead & Purves	5 0 0
Purves, Mrs.	10 0 0
Robertson, Mrs.	5 0 0
Robertson, P. Esq.	5 0 0
Robertson, Mrs. Shaw	5 0 0
Robson, W. Esq.	5 0 0
Scott, Rev. Hill	1 1 0
Smith, James, Esq. C. M.	5 0 0
Stuart, Mein and Allan	5 0 0
Stuart, James	1 0 0
Tait, Miss, Esq.	10 0 0
Turnbull, Dr.	5 0 0
Waldie, W. Esq.	5 0 0
<b>Sums under 5s.</b>	<b>7 7 0</b>
<b>Total</b>	<b>£21 8 0</b>

**MELROSE BRANCH.**

President—  
ADMIRAL THE HON. T. BAILLIE.  
Honorary Secretary—  
JOHN BROAD, Esq.

*Annual Subscriptions.*

Amos, Miss	5 0 0
Baillie, Admiral the Hon. T.	1 0 0
Baillie, Lady Grisell	10 0 0
Baillie, Major the Hon. R.	10 0 0
Baillie, Miss	5 0 0
Broad, John, Esq.	10 0 0
Curle, Alex. Esq.	1 0 0
Curle, James, Esq.	1 0 0
Curle, Mrs.	5 0 0
Dunn, Ralph, Esq.	5 0 0
Elliott, Miss	5 0 0
Erskine, Mrs. Chiefswood.	10 0 0
Erskine, Charles Esq., Friar's Hall.	5 0 0
Freer, Allan, Esq.	5 0 0
Freer, John, Esq.	5 0 0
Grierson, Dr.	10 0 0
Henry, Major-Gen., C.B.	10 0 0
Ker, Andrew, Esq.	5 0 0
Meiklam, John, Esq.	10 0 0
Potwarth, Lord and Lady	2 0 0
Robertson, A. Esq.	10 0 0

<i>£. s. d.</i>	
Small, A. M. Esq.	5 0 0
Smith, Mrs., Darnlee	5 0 0
Smith, Miss E. M.	10 0 0
Tod, the Misses	1 0 0
Sums under 5s.	4 13 6
<b>Total</b>	<b>£17 18 6</b>

**Stirlingshire.**

**BANNOCKBURN BRANCH.**

Treasurer—  
ED. L. WILSON, Esq.

*Annual Subscriptions.*

<i>£. s. d.</i>	
Coll. by Miss Currie— Wilson, Mrs. Col.	10 0 0
Wilson, Rev. John	5 0 0
Wilson's, Jas., Academy, pupils.	5 0 0
Sums under 5s.	1 19 6
Coll. by Miss Buchan— Wilson, Mrs. W.	1 1 0
Sums under 5s.	18 3
Collected by Miss Learmonth— Wilson, Mrs. Ed.	10 6
Wilson, Mrs. J.	5 0 0
Ronald, Mr.	5 0 0
A Friend	5 0 0
Sums under 5s.	4 0 0
Coll. by Miss Mercer— Sums under 5s.	1 18 6
Galbraith, Mrs. W. R., London.	1 1 0
Wilson, Alex. Esq.	1 1 0
Wilson, Ed. L.	1 1 0
<b>Total</b>	<b>£11 9 9</b>

**STIRLING BRANCH.**

Chairman—  
HENRY DRUMMOND, Esq.  
Hon. Treasurer—  
DANIEL FERGUSON, Esq.  
Honorary Secretary—  
JOHN JENKINS, Esq.

*Annual Subscriptions.*

Drummond, Miss, collected by— Aitken, J. G. Esq.	10 6
Carson, Mrs.	5 0 0
Cordie, Miss	5 0 0
Howat, Mrs. Wm.	5 0 0
Kemp & Nicholson, Messrs.	10 6
Mathie and Mackenzie, Messrs.	10 6
Oliphant, Mrs.	5 0 0
Robertson, Miss	5 0 0
Spiers, Miss	10 0 0
<b>Sums under 5s.</b>	<b>2 14 6</b>

<i>£. s. d.</i>	
Gentleman and Ferguson, Misses, collected by— Ferguson, Daniel, Esq.	5 0 0
Gentleman, Eben, Esq.	5 0 0
Mitchell, Mr. Thos.	5 0 0
Ormond, Rev., D.D.	5 0 0
Robertson Bros., Messrs.	10 0 0
Wilson, Mrs.	5 0 0
<b>Sums under 5s.</b>	<b>6 14 7</b>

Johnston, Miss Jane, collected by—

Anderson, Mr.	5 0 0
Anderson, Mrs.	5 0 0
Burden, Mrs. P. J.	5 0 0
Chalmers, Rev. F.	5 0 0
Colquhoun, Miss	5 0 0
Drysdale, Mr. Wm.	5 0 0
Fraser, Mrs.	5 0 0
Frew, Miss	10 0 0
Gray, Mr. James	5 0 0
Hamilton, Misses	5 0 0
Kirkwood, Dr. Anderson	10 0 0
Monteith, Mrs.	5 0 0
Munnich, Mrs.	5 0 0
McEwen, Mrs.	5 0 0
McKenzie, Rev. C.	5 0 0
Owen, Mr. George, Jun.	5 0 0
Paterson, Rob. Esq.	5 0 0
Paton, Mrs., of Viewforth	1 0 0
Reid, Mrs. Wm., of Randolphfield	5 0 0
Smith, Mrs., of Brentham	1 0 0
Steel, Mrs.	5 0 0
Walker, Mrs.	1 0 0
Wright, Misses, of Clifford Park	2 0 0
<b>Sums under 5s.</b>	<b>2 1 0</b>

Miller, Miss, collected by—

Anderson, Provost	5 0 0
Baird, Ex-Dean of Guild	5 0 0
Bell, Mrs.	5 0 0
Carson, Mrs.	10 0 0
Christie, John, Esq.	5 0 0
Cowbrough and Mercer, Messrs.	5 0 0
Cunliff, Mrs.	1 0 0
Cuthbertson, Dr.	5 0 0
Cuthbertson, Mrs.	5 0 0
Dowdy, Mr. Wm.	5 0 0
Drummond, Henry, Esq.	10 6
Duncanson, Mr. Wm.	5 0 0
Forrester, Misses	5 0 0
Galbraith, Misses	5 0 0
Graham, Wm. Esq.	5 0 0
Hunter, Miss	5 0 0
Jenkins, Messrs. A. & J.	7 6
Lennox, Mr. John	5 0 0
Macfarlane, John, Esq.	5 0 0
Mathie, James, Esq.	5 0 0
Millar, Jas. & Sons, Messrs.	7 6
Monteath, Mrs. A.	5 0 0
Morrison, Miss	5 0 0
Morrison, Jas. M., Esq.	5 6
McEwen, John, Esq.	5 0 0
McMath, Mrs.	5 0 0
Morton, Mr.	5 0 0
Muir, A. L., Esq.	5 0 0
Muirhead & Archibald, Messrs.	5 0 0
Murray, Misses	5 0 0
Philp, Jas. L. Esq.	5 0 0
Rae, Mrs.	5 0 0
Richardson, J. B., Esq.	1 1 0

	£.	s.	d.
Smith, Mr. J. ....	5	0	0
Shearer, Dean of Guild .....	5	0	0
Taylor, Robt., Esq. ....	5	0	0
Walls, Mr. R. ....	10	0	0
Sums under 5s. ....	6	13	0
<b>Smith, Mrs. James,</b> collected by—			
Bell, Mrs. ....	5	0	0
Craigie, Miss .....	5	0	0
Galbraith, Dr. ....	5	0	0
Galbraith, T. L. Esq. ....	10	0	0
M <sup>c</sup> Alpine, Mrs. ....	5	0	0
M <sup>c</sup> Innes, Robt. Esq. ....	10	0	0
Smythe, Miss. ....	5	0	0
Thomson, Mrs. ....	5	0	0
Ward, Mrs. ....	1	1	0
Sums under 5s. ....	3	4	6
<b>Total .....</b>	<b>£53</b>	<b>1</b>	<b>7</b>

	£.	s.	d.
Maxwell, Lady. ....	2	0	0
Murray, Thos. Esq. ....	10	0	0
Nicholson, John, Esq. ....	5	0	0
Parlane, James, Esq. ....	2	0	0
Routledge, C. M. ....	5	0	0
Routledge, Thos. ....	5	0	0
Scott, Robert. ....	5	0	0
Selby, Dr. ....	5	0	0
Smith, William. ....	5	0	0
Spedding, Capt. ....	5	0	0
Stewart, Alex. ....	5	0	0
Stewart, Hugh, Esq. ....	10	0	0
Stewart, Hugh. ....	5	0	0
Stewart, R. H. J. Esq. ....	1	1	0
Sums under 5s. ....	11	12	0
<b>Total .....</b>	<b>£46</b>	<b>6</b>	<b>0</b>

**PORT LOGAN AND BAY OF LUCE BRANCH.**

Patron—  
The Right Hon. the EARL OF STAIR, K.T.

President—  
JAMES M<sup>c</sup>DOUALL, Esq., of Logan.

Chairman—  
MARK J. STEWART, Esq.

Honorary Secretary—  
QUINTIN COCHRANE, Esq.

*Annual Subscriptions.*

	£.	s.	d.
Baird, John, Esq. ....	10	0	0
Byres, James, Esq. ....	5	0	0
Cavan, Rev. Jas. ....	5	0	0
Cochrane, Quintin. ....	1	0	0
Cunningham, Rev. R. ....	10	0	0
Dodd, G. Ashley, Esq. ....	1	0	0
Frederick, David, Esq. ....	10	0	0
Marshall, John, Esq. ....	5	0	0
M <sup>c</sup> Connell, Jas. Esq. ....	10	0	0
M <sup>c</sup> Donald, Jas. Esq. ....	5	0	0
M <sup>c</sup> Taggart, Mrs. O. ....	1	1	0
Mitchell, Alex. Esq. ....	1	0	0
Moore, J. Carrick, Esq. ....	2	0	0
Murray, Wm. Esq. ....	10	0	0
Ross, Dr. ....	10	0	0
<b>Sums under 5s. ....</b>	<b>2</b>	<b>2</b>	<b>3</b>
<b>Total .....</b>	<b>£24</b>	<b>11</b>	<b>3</b>

**PORTPATRICK BRANCH.**

Patron—  
DAVID HUNTER BLAIR, Esq., of Dunskey.

Chairman—  
JOHN McCLEW, Esq., J.P.

Honorary Secretary—  
DAVID A. McCLEW, Esq.

*Annual Subscriptions.*

	£.	s.	d.
Forbes, A. C. Esq. ....	2	2	0
Hunter Blair, David, Esq. ....	10	0	0
M <sup>c</sup> Craig, Alexander. ....	1	0	0
M <sup>c</sup> Clew, John. ....	2	2	0
<b>Sums on Boathouse door, &amp;c. ....</b>	<b>1</b>	<b>13</b>	<b>8</b>
<b>Total .....</b>	<b>£16</b>	<b>17</b>	<b>8</b>

**IRELAND.**

**Co. Antrim.**

**BELFAST AND GROOMSPORT BRANCH.**

Presidents—  
The MARQUIS OF DONEGALL.  
The EARL OF DUFFERIN.  
Major R. PERCEVALL.  
MAXWELL.

Chairman—  
The Mayor of BELFAST.

Hon. Sec. at Groomsport—  
Rev. FREDK. J. HEARNE.

Treasurer and Hon. Sec. at Belfast—  
ARTHUR HILL COATES, Esq.

*Annual Subscriptions.*

	£.	s.	d.
Adair, Mr. Hugh ....	5	0	0
Alexander, Messrs. ....	10	0	0
J. & Co. ....	10	0	0
Andrews, Messrs. H. & Co. ....	5	0	0
Archer, Samuel, Esq. ....	5	0	0
Arnott & Co. Messrs. ....	10	0	0
Barklie, Mr. W. M. ....	5	0	0
Belfast Harbour Commissioners. ....	10	0	0
Belfast Steamship Co. ....	2	2	0
Bell, Messrs. R. & Co. ....	10	0	0
Blackstaff Spinning Company. ....	10	0	0
Boag, Robert, Esq. ....	5	0	0
Bristow, E. J. Esq. ....	10	0	0
Brown, David, Esq. ....	5	0	0
Brown and Sons, Messrs. John S. ....	5	0	0
Campbell and Co. Messrs. H. ....	10	0	0
Carlisle, Jas. Esq. ....	10	0	0
Carter, Wm. Esq. ....	1	0	0
Clarke and M <sup>c</sup> Mullan, Messrs. ....	5	0	0
Coates, John, Esq. ....	10	0	0
Coates, A. Hill, Esq. ....	1	0	0
Coates, Victor & Co., Messrs. ....	1	0	0
Coey, Sir Edward. ....	1	0	0
Combe, Barbour, & Combe, Messrs. ....	10	0	0
Corry & Co. Messrs. J. P. ....	10	0	0
Cramer, Wood, & Co. Messrs. ....	10	0	0
Crawford, J. Sharrman, Esq. ....	1	0	0
Crawford and Lockhart, Messrs. ....	1	0	0
Currell, & Co. Messrs. Daniel, Jun. ....	1	0	0
Donegall, The Marquis of. ....	2	2	0
Dufferin, The Earl of ..... 1	0	0	0
Duffin, Adam, Esq. ....	5	0	0
Dunville and Co. Messrs. (Limited). ....	10	0	0
Edgar and Lowry, Messrs. ....	5	0	0
Emerson, Wm. Esq. ....	5	0	0
Ewart and Son, Messrs. W. ....	1	0	0
Ewing, Son, and Co. Messrs. ....	5	0	0
Finlay Brothers and Co. Messrs. ....	10	0	0
Gordon & Co. Messrs. ....	5	0	0
Green, Forster, Esq. ....	1	10	0
Grimshaw Brothers, Messrs. ....	5	0	0
Hamilton, Megaw, & Thomson, Messrs. ....	1	0	0
Hanson, J. Esq. ....	10	0	0

	£.	s.	d.
Harkness, Jas. Esq. ....	5	0	0
Harland and Wolf, Messrs. ....	2	0	0
Hart and Churchill, Messrs. ....	10	0	0
Henderson, J. A. Esq. ....	10	0	0
Henderson and Son, Messrs. R. ....	10	0	0
Henry, Messrs. A. & S. ....	5	0	0
Higginson, J. M. Esq. ....	5	0	0
Hind and Sons, Messrs. John. ....	1	0	0
Houston, John B. Esq. ....	1	0	0
Hughes, Edward, Esq. ....	5	0	0
Jaffé Brothers, Messrs. ....	5	0	0
Johnston, and Thompson, Messrs. W. J. ....	5	0	0
Kyle, Mrs. ....	5	0	0
Lemon, A. D. Esq. ....	10	0	0
Lindsay Bros. Messrs. (Limited). ....	5	0	0
Lipman & Co. Messrs. Little & Co., Messrs. Jas. ....	10	0	0
Lytle and Sons, Messrs. John. ....	5	0	0
Mateer & Co. Messrs. H. ....	10	0	0
Maxwell, R. P. Esq. ....	1	0	0
Maxwell, Mrs. P. ....	1	0	0
M <sup>c</sup> Causland, Saml. Esq. ....	10	0	0
M <sup>c</sup> Clure, Sir Thomas, Bart., M.P. ....	5	0	0
M <sup>c</sup> Gea, John G. Esq. ....	5	0	0
M <sup>c</sup> Neill, H. H. Esq. ....	5	0	0
M <sup>c</sup> Neill, Wm. Esq. ....	1	0	0
M <sup>c</sup> Neill, Malcm. Esq. ....	10	0	0
Millar, Boyd & Reid, Messrs. ....	10	0	0
Moore, Bras., Messrs. ....	5	0	0
Moore and Winberg, Messrs. ....	10	0	0
Moore, James, Esq. ....	10	0	0
Murney, Henry, Esq. M.D. ....	1	0	0
Murphy and Orr, Messrs. ....	5	0	0
Northern Spinning & Weaving Co. ....	5	0	0
Orr, Robert H. Esq. ....	1	0	0
O. D. C. ....	10	0	0
Patterson, Rich. Esq. ....	10	0	0
Patterson, R. L. Esq. ....	10	0	0
Pim, Messrs. E. & W. ....	5	0	0
Pim, Messrs. J. & Son ....	10	0	0
Purdon, H. S. Esq. M.D. ....	5	0	0
Richardson Brothers, Messrs. ....	1	0	0
Richardson, Sons, and Owden, Messrs. ....	1	0	0
Riddell, Saml. Esq. ....	1	0	0
Ritchie, W. B. Esq. ....	10	0	0
Robertson, Leddie, Ferguson & Co. ....	1	0	0
Robinson, W. A. Esq. ....	5	0	0
Royal Ulster Yacht Club. ....	2	0	0
Seeds, Messrs. H. & W. ....	5	0	0
Shaw, Charles W. Esq. ....	5	0	0
Smith, Messrs. J. and T. ....	10	0	0
Stewart, Chas. Esq. ....	5	0	0
Tate, Alex. Esq. ....	10	0	0
Torrans, Jas. Esq. ....	1	1	0
Trimble, Mr. Saml. ....	5	0	0
W. C. F. D., Esq. ....	10	0	0
Wallace, Sir Richard, Bart., M.P. ....	5	5	0
Ward, Marcus, & Co. Messrs. ....	10	0	0
Ward, Robert E. Esq. ....	1	0	0
Workman, Messrs. J. and R. ....	10	0	0
Workman, Mrs. R. Sen. ....	1	0	0
Workman, Mrs. Eobt. ....	1	0	0
Workman, Wm. Esq. ....	1	0	0
Workman, T. Esq. ....	1	0	0

**Wigtown.**

**ISLE OF WHITHORN AND BAY OF WIGTOWN BRANCH.**

Patron—  
The Right Hon. the EARL OF GALLOWAY.

President—  
R. H. JOHNSTON STEWART, Esq.

Chairman—  
Lt.-Col. JOHN FLETCHER HATHORN, of Castle Wigg.

Honorary Secretary—  
ALEXANDER MACFIE, Esq.

*Annual Subscriptions.*

	£.	s.	d.
Galloway, Right Hon. the Earl of. ....	5	0	0
Bute, The Most Noble the Marquis of. ....	1	0	0
Stair, Right Hon. the Earl of, K.T. ....	1	1	0
Borthwich, Right Hon. Lord, Ravenstone. ....	2	2	0
Black, E. S. Esq. ....	10	0	0
Blair, E. Stopford, Esq. ....	2	2	0
Broadhurst, Henry Tootal, Esq. ....	2	0	0
Brown, James. ....	5	0	0
Charters, John. ....	5	0	0
Clephane, Jasper, Esq. ....	5	0	0
Cullen, Rev. J. ....	5	0	0
Donnan, Alex. ....	5	0	0
Donnan, E. ....	5	0	0
Donnan, James. ....	5	0	0
Drew, James, Esq. ....	5	0	0
Duff, James. ....	5	0	0
Gifford, Mr. Geo. ....	5	0	0
Gourlay, R. ....	5	0	0
Hathorn, Colonel J. F. ....	1	0	0
Kennedy, Capt. W. R. R.N. ....	1	0	0
Macfie, Alex. ....	5	0	0
M <sup>c</sup> Candlish, J. ....	5	0	0
M <sup>c</sup> Clelland, Thos. ....	5	0	0
M <sup>c</sup> Clure, Wm. ....	5	0	0
M <sup>c</sup> Rwen, Walter, Esq. ....	5	0	0
M <sup>c</sup> Kie, Geo. ....	5	0	0
M <sup>c</sup> Lean, J. Esq. ....	10	0	0
M <sup>c</sup> Master, Hugh Junr. ....	5	0	0
M <sup>c</sup> Master, P. ....	5	0	0
Martin, John G. ....	5	0	0
Maxwell, Sir Herbert E., Bart., M.P. ....	5	0	0

BRANCHES—LIST OF ANNUAL SUBSCRIPTIONS AND DONATIONS. 377

	£.	s.	d.
Workman, Rev. Rbt.			
Jun.....	1	0	0
Young & Mackenzie,			
Messrs.....	10	0	0
Sums under 5s.....	5	0	0
<b>Total.....</b>	<b>85</b>	<b>5</b>	<b>0</b>

**Donations.**

Pillar Box at Northern Counties Railway Station.....	2	0	1
Duncairn Sunday School, per Mr. Dunwoody.....	10	0	0
<b>£87 15 1</b>			

**PORTRUSH BRANCH.**

President—  
Major-General  
**J. BRADFORD SMYLY.**

Vice-President—  
Rev. H. FOLLIOTT, M.A.

Treasurer—  
**THOMAS BELLAS, Esq.**

Honorary Secretaries—  
Rev. JONATHAN SIMPSON.  
W. E. CARVER, Esq., J.P.

Assistant Secretary—  
Mr. SAMUEL PATTON.

**Annual Subscriptions.**

Adams, J. Esq. J.P. . . . .	10	0	0
Anderson, James S. . . . .	5	0	0
Antrim, L. Countess of 3 . . . . .	0	0	0
Armstrong, Rev. W. . . . .	5	0	0
Bellas, H. and T. . . . .	1	0	0
Bevington, J. B. Esq. . . . .	10	6	
Bevington, S. B. Esq. . . . .	10	6	
Carr, John, Esq. . . . .	10	0	0
Carson, A. T. Esq. M.D. . . . .	5	0	0
Carver, W. E. Esq., J.P. 1 . . . . .	0	0	0
Chaine, Major . . . . .	1	0	0
Cox, Mrs. S. L. . . . .	1	0	0
Cramsie, James, Esq. . . . .	10	0	0
Crookshank, R. Esq. . . . .	10	0	0
Darcus, Col., J.P. . . . .	10	0	0
Denham, Mrs. Dr. . . . .	5	0	0
Fall, Daniel . . . . .	10	0	0
Ffolliott, Rev. H., M.A. . . . .	10	0	0
Gordon, Joseph. . . . .	5	0	0
Grant, P. Drummond . . . . .	5	0	0
Hannay, Lt.-Col. J.P. . . . .	10	6	
Huey, John . . . . .	10	0	0
Hunter, Stewart . . . . .	10	0	0
Lusk, John, Esq. . . . .	5	0	0
McElderry, T. . . . .	5	0	0
Montgomery, Capt. R. J., J.P. . . . .	1	0	0
Moore, J. S. Esq. J.P. 1 . . . . .	0	0	0
Moore, Miss. . . . .	5	0	0
Murray, Major, J.P. 1 . . . . .	0	0	0
O'Neill, Hon. E. . . . .	1	0	0
Orr, Rev. H. Holmes . . . . .	10	6	
Patrick, J. Esq. J.P. . . . .	10	0	0
Portrush Harbour Commissioners . . . . .	2	2	0
Smyly, Major-Gen. John Beresford. . . . .	1	0	0
Simpson, Rev. J. . . . .	1	0	0
Stannus, Miss. . . . .	10	0	0
Taylor, D. Esq., J.P. . . . .	10	0	0
Taylor, Robert . . . . .	1	0	0
Templetown, General, Rt. Hon. Lt. Visc. . . . .	1	0	0
Thompson, J. . . . .	5	0	0
Troughton, James. . . . .	5	0	0
Turnay, J. Esq. J.P. . . . .	10	0	0
Waveney, Lord, Rt. Hon. . . . .	1	0	0
Wilson, Chas. Esq. . . . .	1	0	0
Young, Mrs. Jas. . . . .	10	0	0

	£.	s.	d.
Young, Miss . . . . .	10	0	0
Young, J. Esq. J.P., D.L. . . . .	10	0	0
Young, Wm. A. Esq. . . . .	10	0	0
<b>Total.....</b>	<b>32</b>	<b>9</b>	<b>0</b>

**Donations.**

Antrim Arms Hotel Box.....			
Coleman's Hotel Box Finlayson, Rev. John "First Fruits," Crumlin Road, Belfast . . . . .	1	0	0
Hutcheson, Miss Amelia.....	10	0	0
Watt, Capt. . . . .	1	0	0

The following, per Miss Stannus:

Fitzgerald, Hon. Miss G. Vesey . . . . .	5	0	0
Gidlow, Mrs. . . . .	5	0	0
Stevenson, Mrs. Ellen, Scotton Hall . . . . .	5	0	0
Wayne, Miss . . . . .	10	0	0
Wayne, Miss A. . . . .	10	0	0
<b>Total Dons. . . . .</b>	<b>9</b>	<b>5</b>	<b>0</b>
<b>Total Subs. . . . .</b>	<b>32</b>	<b>9</b>	<b>0</b>
<b>£41 14 0</b>			

**Co. Caban.**

**CAVAN BRANCH.**

President—  
The LORD FARNHAM.

Chairman—  
Major E. J. SAUNDERSON.

Honorary Secretary—  
LLEWELLYN SAUNDERSON, Esq.

Treasurer—  
JOHN BOYD, Esq.

Collector—  
Mr. T. J. SMYTH.

Subscribers in 1880.

	£.	s.	d.
Farnham, The Lord (Don.) . . . . .	5	0	0
Do. (Annual Sub.) . . . . .	2	0	0
Maxwell, Col. The Hon. J. P. (Don.) . . . . .	2	0	0
<b>£9 0 0</b>			

Subscribers in 1881.

Farnham, The Lord (Don.) . . . . .	1	0	0
Do. (Annual Sub.) . . . . .	2	0	0
<b>£12 0 0</b>			

**Co. Cork.**

**BALLYCOTTON BRANCH.**

Patron—  
The Right Rev. the LORD BISHOP OF CORK, CLOYNNE, AND ROSS.

President—  
E. F. LITTON, Esq., Q.C.

Honorary Secretary—  
T. W. STRANGMAN, Esq.

**Annual Subscriptions.**

	£.	s.	d.
Beale, Alfred, Esq. . . . .	5	0	0
Beale, Henry H. Esq. . . . .	5	0	0
Bristol General Steam Navigation Co. . . . .	1	0	0
Clyde Shipping Comp. 3 . . . . .	3	0	0
Cork Harbour Com. . . . .	5	0	0
Cork, Lord Bishop of 1 . . . . .	0	0	0
City of Cork Steam Packet Company . . . . .	5	0	0
Cunard Company . . . . .	2	2	0
Evans, Archdeacon . . . . .	10	0	0
Gaggin, George, Esq. . . . .	5	0	0
Tulloch, Miss A. G. . . . .	1	1	0
Henderson Brothers, Messrs. "Anchor Line" of Steam Ships . . . . .	2	2	0
Inman, William, Esq. (of Inman Line) . . . . .	2	2	0
Litchfield, W. Esq. . . . .	5	0	0
Litton, E. F. Esq. Q.C. 1 . . . . .	0	0	0
Longfield, Mountfort, J. C. Esq. . . . .	2	0	0
Strangman, T. W. Esq. . . . .	10	0	0
<b>Total . . . . .</b>	<b>27</b>	<b>10</b>	<b>0</b>

**Donations.**

Collection Boxes on board Steamers of City of Cork S.S. Co., per W. de Foubert, Esq. . . . . 2 5 11

**£29 15 11**

**CORK AND QUEENSTOWN BRANCH.**

President—  
Rear-Admiral RICHARD VESSEY HAMILTON, C.B., Commanding the Irish Station, Queenstown.

Treasurer—  
HENRY HARDY, Esq., Knockeven, Queenstown.

Honorary Secretary—  
Capt. N. SUTTON, Queenstown.

**Annual Subscriptions.**

Barry, Arthur H. Smith, Esq., D.L., Fota . . . . .	2	2	0
Barry, Capt. R. H. Smith, D. L., R.Y.S. . . . .	2	2	0
Beamish and Crawford . . . . .	2	2	0
Beamish, Capt. J. Caulfield, J.P. . . . .	1	0	0
Bristol General Steam Navigation Co. . . . .	2	2	0
Buckle, Capt., R.N., H.M.S. <i>Revenge</i> . . . . .	1	0	0
Byrne, Edward, Esq. Harbour Master, Cork . . . . .	1	1	0

	£.	s.	d.
City of Cork Steam Packet Co. . . . .	5	0	0
Clyde Shipping Co. . . . .	2	2	0
Cork Harbour Commissioners . . . . .	10	0	0
Currey, P. Esq., Imperial Hotel, Cork . . . . .	1	0	0
Delaw, J. . . . .	1	1	0
Guion and Co. . . . .	1	1	0
Hardy, Henry, Esq. . . . .	1	0	0
Harvey, G. N. & Sons, Queenstown . . . . .	1	1	0
Liverpool, Philadelphia, & New York S. S. Co., per W. Inman, Esq. . . . .	2	2	0
M'Iver, D. and C. Queenstown . . . . .	2	2	0
Murphy, James J. & Co., Lady's Well Brewery, Cork . . . . .	5	0	0
National Steam Ship Co. . . . .	1	1	0
Queenstown Towing Co., per Capt. N. Sutton . . . . .	1	1	0
Rushbrook, Miss . . . . .	5	0	0
Scott, James, & Co., Queenstown . . . . .	1	1	0
Tobin, Sir T., D.L. . . . .	1	1	0
White Star Line Atlantic Steamers, per Ismay, Imrie & Co. . . . .	5	0	0
Woodford & Bourne 1 . . . . .	0	0	0
<b>Total . . . . .</b>	<b>58</b>	<b>2</b>	<b>0</b>

**Donations.**

Helbergs, Messrs. . . . . 11 5

Wise, F. Esq. . . . . 20 0 0

Collected at Messrs. Darntons . . . . . 4 2

Do. Morovech Bros. 1 17 7

Do. C. & W. D. Seymour . . . . . 8 8

Do. Messrs. Harveys . . . . . 1 11

Do. Messrs. Scott and Co. . . . . 2 3

Captains at Do. . . . . 1 1 9

<b>Total Dons. . . . .</b>	<b>24</b>	<b>7</b>	<b>9</b>
<b>Total Subs. . . . .</b>	<b>58</b>	<b>2</b>	<b>0</b>
<b>£82 9 9</b>			

**COURT MACSHERRY BRANCH.**

Chairman—  
The Right Hon. the EARL OF SHANNON.

Honorary Secretary—  
Captain TOWNSEND.

**Annual Subscriptions.**

Bunbury, R. . . . .	10	0	0
Boyle, Ladies . . . . .	5	0	0
Cork Steam Ship Co. . . . .	5	0	0
Cunard Company . . . . .	2	2	0
Foster, A. Esq. . . . .	10	0	0
Garde, Dr. . . . .	10	0	0
Leslie, Wm. B. Esq. . . . .	10	0	0
Shannon, Rt. Hon. the Earl of . . . . .	5	0	0
Stawell, Col. St. L. Alcock, J.P. . . . .	2	0	0
Sealy, John, Esq. . . . .	5	0	0
Townshend, Captain . . . . .	10	0	0
<b>Total . . . . .</b>	<b>£21</b>	<b>17</b>	<b>0</b>

**YOUGHAL BRANCH.**

<b>Honorary Secretary—</b>	
J. W. Pm, Esq.	
<b>Annual Subscriptions.</b>	
£.	s. d.
Allan, Mrs.	5 0
Duke of Devonshire	5 0
Drury & Sons, Messrs.	10 0
Farrell, Mr. Richard	5 0
Fitzgerald, Rev. L.	5 0
Gorman, Mr. Patrick	10 0
Green, Miss C.	10 0
Green, Rev. William	10 0
Lloyde, G. W. Esq.	3 0 0
J.P.	3 0 0
Ponsonby, C. W. T.	1 0
Esq. J.P.	1 13 5
Boxes.	5 0
Sums under 5s.	13 14 5
<b>Total.....</b>	

**Co. Down.**

**BALLYWALTER BRANCH.**

<b>Honorary Secretary—</b>	
Rev. J.O'REILLY BLACKWOOD.	
<b>Annual Subscriptions.</b>	
£.	s. d.
Atkinson, Mrs.	5 0
Belfast Steam Ship-	
ping Co., per John	2 2 0
McKee, Esq.	2 2 0
Carmichael, Messrs.	10 0
D. and W.	10 0
Cleland, Mrs. (Bally-	
walter)	5 0
Dunbar, Miss	1 0
Glover, Jas. B. Jun.	5 0
Greer, Rev. Geo. Jun.	5 0
Houston, J. B. Esq.	1 0
Lyle, Rev. Edward	5 0
Mulholland, J. Esq.	2 0 0
M.P.	2 0 0
Sinclair and Boyd,	
Messrs.	1 0 0
Stewart, Captain D.	2 0 0
Hamill	2 0 0
Walker, Geo. Esq.	10 0
<b>Total.....</b>	
£11 7 0	
<b>Donations.</b>	
English Congregation	
at Croix, Nord,	
France, per Mast.	10 0 0
Harry Faulkner.	10 0 0
<b>Total.....</b>	
£21 7 0	

**NEWCASTLE (DUN-DRUM) BRANCH.**

<b>Chairman—</b>	
WILLIAM BEERS, Esq.	
<b>Honorary Secretary—</b>	
Mr. Wm. HAYWARD.	
<b>Annual Subscriptions.</b>	
£.	s. d.
Andrews, Thos. Esq.	5 0
Annesley, The Earl.	5 0
Annesley, Lady	1 0 0
Blakey, Miss	10 0
Brush, Geo. Esq.	10 0
Brush, Richd. Esq.	1 0 0
Clarendon, S. Esq.	10 0
Corbett, R. S. Esq.	5 0
Crawford, M. Esq.	11 6
and Sons	5 0
Creery, C. Esq.	5 0

£.	s. d.
Gray, Dr.	5 0
Gray, Mrs. Gray-	
mount	5 0
Hamilton, Mrs. Kil-	
leshandra (6th don.)	3 16 2
Humphreys, Mrs.	1 0 0
Kilmorey, The Earl	5 0
of.....	5 0
Kingscote, J. B. Esq.	1 0 0
Knox, Mrs.	5 0
McCraith, A. Esq.	5 0
Murland, J. Esq.	1 0 0
Murphy, J. Esq.	5 0
Old rope	2 0
Pim, A. Esq.	5 0
Richardson, Mrs.	5 0
Robinson, Mrs.	7 0
Roden, Earl.	4 0 0
Stannas, Miss.	5 0
Seymour, Rev. J.	1 0 0
Shaw, W. Esq.	5 0
Smith, Rev. S. J.	5 0
Stewart, Major	1 0 0
Waring, Wm. Esq.	1 0 0
Collection Boxes.	1 11 6
Sums under 5s.	1 14 6
<b>Total.....</b>	
£34 8 1	

**TYRELLA BRANCH.**

<b>Honorary Secretary—</b>	
Rev. J. BINGHAM, B.A.	
<b>Annual Subscriptions.</b>	
£.	s. d.
The Marquis of Down-	
shire	5 0 0
The Dowager Mar-	
chioness of Down-	
shire	1 0 0
Viscount Bangor	2 0 0
The Lady Amelia	
Montgomery	1 0 0
The Lady Matilda	
Montgomery	1 1 0
Lord de Ros	2 0 0
Atkinson, J. Brooke,	
Esq.	10 0
Bingham, Rev. J.	5 0
Birney, Mrs., Oakley	10 0
Deacon, Rev. John J.	10 0
Digney, Mr. P.	5 0
East Downshire S. S.	
Co. Dundrum, per	
Mr. E. G. Henesey	2 2 0
Montgomery, Hugh,	
Esq.	2 10 0
Nugent, Maj. Andrew	1 0 0
Pos, William T. Esq.	1 0 0
Reid, J. Esq.	10 0
Smyth, Rev. G.	10 0
* Gordon	10 0
Stephenson, S. S. Esq.	5 0
M.D.	5 0
Waulfe, S. R. Esq.	1 1 0
<b>Total.....</b>	
£22 19 0	

<b>Donations.</b>	
Book, Collection, by	
Mr. C. Creese.	1 3 6
Box at Mr. W. Nesbitt's,	
Clanmoghery	5 6
Brown, Rev. J. P.	1 0 0
Collection Box at Mr.	
T. K. Orlson's,	
Rathmullen	8 6
Hamilton, Miss, Bal-	
briggan	2 0 0
Other Boxes (Small	
Sums)	7 7
<b>Total Dons...</b>	
5 5 1	
<b>Total Subs...</b>	
22 19 0	
<b>Total.....</b>	
£28 4 1	

**Co. Dublin.**

**DUBLIN BRANCH.**

<b>Patron—</b>	
His Excellency EARL	
COWPER.	
<b>Lord-Lieutenant of Ireland.</b>	
<b>Honorary Secretary—</b>	
THOMAS EDMONDSON, Esq.	
<b>Secretary and Collector—</b>	
Mr. J. PIKE	
<b>Annual Subscriptions.</b>	
£.	s. d.
Marlborough, the	
Duke of	5 0 0
Allen, Richard, Esq.	1 0 0
Ardsiaun, The Lord.	2 0 0
Arnott & Co. Limited,	
Messrs.	3 3 0
Baker & Sons, Messrs.	
Wm.	5 0
Baker, Wardell & Co.	
Ballantine, Alex.	
Bewley & Anderson	1 0 0
Bewley & Co. Messrs.	1 0 0
Boyle, Low, Murray,	
and Co. Messrs.	2 0 0
British & Irish Steam-	
packet Company	2 2 0
Brooke & Son, Messrs.	
G. F.	1 0 0
Brown, Thomas, and	
Co., Messrs.	1 0 0
Cantrill & Cochrane.	1 0 0
City of Dublin Steam-	
packet Company	2 2 0
Clibborn, Jas.	5 0
Colquhoun, D. Esq.	1 0 0
Cowan and Co.	1 0 0
Cowper, His Excellency	
The Earl	5 0 0
Crowe, Wilson, & Co.	
Messrs., Limited	1 0 0
D'Arcy and Son,	
Messrs. John	2 0 0
De Vesci, Lord.	2 0 0
Dixon, Jas.	10 0
Drummond & Sons,	
Messrs. Wm.	1 0 0
Dublin and Glasgow	
Steam-packet Co.	2 2 0
Dublin and Liverpool	
Screw Steam-ship	
Company	2 0 0
Dublin Steam Print-	
ing Co.	1 0 0
Edmundson and Co.	
Messrs. J.	1 0 0
Egan, A. W. Esq.	1 0 0
Ferrier, Pollock, and	
Co. Messrs.	2 0 0
Findlater, J. Esq.	2 2 0
Fisher, Thomas, Esq.	10 0
Forster & Co. Messrs.	1 0 0
Garratt, J. Esq.	1 0 0
Gilbey, Messrs. W.	
and A.	1 1 0
Green Bros. Messrs.	1 0 0
Handcock, W. D.	10 0
Hazleton Connor and	
Co. Messrs.	10 0
Heiton & Co. Messrs.	1 1 0
Hogg & Co. Messrs.	1 0 0
Howell, P. Esq.	1 0 0
Jacob, R. S. Esq.	5 0
Jameson and Son,	
Messrs. John	2 0 0
Jameson, Pim, and Co.	
Messrs.	2 2 0
Jameson and Co.,	
Messrs. William.	1 0 0
Kenny and Owens,	
Messrs.	10 6
Kildare, Lord	
Kinahan and Sons,	
Messrs.	2 0 0

£.	s. d.
Lambert, Brien, and	
Co. Messrs.	10 0
McCullagh, Son, & Co.	
Messrs. James	2 2 0
McDonnell & Co.,	
Messrs. Thomas	10 0
MacMullen, Shaw, &	
Co. Messrs.	1 0 0
McSwiney & Co.	
(Limited)	2 0 0
Manders, Robt. & Co.	2 0 0
Martin and Sons,	
Messrs. John	1 0 0
Martin, Messrs. T.	
and Co.	1 0 0
Millar, Adam, and Co.	1 0 0
Moses, M. T.	
Ogilvy, Alex. Esq.	1 0 0
Palgrave, Murphy,	
and Co. Messrs.	2 2 0
Pattison, H. Esq.	1 0 0
Pearse, Mrs.	2 0 0
Perrin, Rd. and Son.	1 0 0
Pim, Bros. and Co.	
(Limited) Messrs.	3 0 0
Powerscourt, Lord.	1 1 0
Roe, Henry, Jun.	2 2 0
Ross and Walpole,	
Messrs.	1 0 0
Scott, Bell, and Co.	
Messrs.	10 0
Switzer, Ferguson,	
and Co. Messrs.	1 0 0
Taylor, Messrs. W.	
and M.	1 0 0
Tedcastle and Co.	
Messrs. R.	2 0 0
Todd, Burns, and Co.	
Messrs.	3 3 0
Turbett, Messrs. Rbt.	
& Jas.	1 0 0
Watkins & Co. Jo-	
seph Messrs.	2 0 0
Webb, J. B. & Co.	
(Limited)	10 0
Webb, J. Esq.	1 0 0
Weir, James and Co.	1 0 0
Westby, Edward Per-	
cival, Esq., J.P.	5 0 0
White, Joshua, Esq.	1 0 0
Wilson, Wm. Esq.	10 0
Woods & Co. Messrs.	
Adam	1 0 0
Wynyard, Maj.-Gen.	1 0 0
<b>Total.....</b>	
110 0 6	

<b>Donations.</b>	
Gane, Miss C. F.	3 0 0
Collecting Box Nor-	
thumberland Hotel	6 11
Collecting Box Prince	
of Wales	1 3 2
Dividend on Clifford's	
Bequest	44 11 4
Fleet, Dublin & Glas-	
gow, S. P. Coy.	1 0 0
Imp. Hotel, Cork.	6 0
" in memoriam,"	
Armagh	1 0 0
Refreshment Room,	
Limerick Junction	8 11
Pillar Boxes do.	1 10 2
S.S. Countess of	
Dublin	18 8 6
" Cyma	6 6
" Duke of Argyll.	2 1
" Duke of Leinster	11 9
" Lady Olive	11 3
" Lady Eginton.	2 15 9
" Lady Wodehouse	6 11 10
" Lord Clyde	4 8
" Ovoca	1 7 10
Sums under 5s.	0 10 5
<b>Total Dons...</b>	
84 17 1	
<b>Total Subs...</b>	
110 0 6	
<b>Total.....</b>	
£194 17 7	

**KINGSTOWN BRANCH.**

President—  
The Most Noble the MARQUIS OF ORMONDE.

Honorary Secretary—  
Commander the Hon. F. G. CROFTON, R.N.

*Annual Subscriptions.*

	£.	s.	d.
Barton, H. L., D.L.	5	0	0
Barton, Miss	3	0	0
Browne, Mrs. R. F.	1	0	0
Bruce, Miss	5	0	0
Burroughs, Rev. W. E.	10	0	0
Chatterton, the Vice-Chancellor	2	0	0
Close, S. H. Esq.	1	0	0
Coghill, Sir J. J. Bart.	1	0	0
Dalton, Rev. G. W.	10	0	0
Dalton, G. E. R. Esq.	5	0	0
Daly, Hon. Skeffington	2	0	0
Delap, J. B.	1	0	0
Dillon, Hon. L. G.	10	0	0
Dudgeon, J. Hume, Esq.	2	2	0
Elliott, Mrs.	10	0	0
Gilmore, Mrs. J. S.	5	0	0
Hogan, W. O. Esq.	10	0	0
Hone, Brindley	1	0	0
Hogan, J. F. Esq.	10	0	0
Houghton, J. T. Esq.	1	0	0
Hutchison, Com. R.N.	10	0	0
Lodge, Miss	1	0	0
Lyle, J. A. Esq.	1	0	0
Magee, Miss	1	0	0
Moorewood, Misses	1	0	0
Ormonde, Marquis of, Yacht <i>Mirage</i>	5	0	0
Reid, J. Hamilton, Esq.	1	0	0
Royal Alfred Yacht Club	2	2	0
Royal Irish Yacht Club, per Committee	3	0	0
Somerville, Rear-Admiral	10	0	0
Wolf, Mrs.	5	0	0
<b>Total</b>	<b>40</b>	<b>4</b>	<b>0</b>

*Donations.*

Collecting Boxes on Mail Steamers— <i>Connaught</i>	1	4	0
<i>Munster</i>	2	5	4
Kingstown Reading Room	15	6	
Pillar Box at Kingstown	5	8	10
Do. Salthill	1	10	0
<b>Total Dona.</b>	<b>11</b>	<b>3</b>	<b>8</b>
<b>Total Subs.</b>	<b>40</b>	<b>4</b>	<b>0</b>
<b>£51 7 8</b>			

**ROGERSTOWN BRANCH.**

President—  
Maj.-Gen. SIR ROGER PALMER, BART.

Chairman—  
CHARLES COBBE, Esq., D.L.

Honorary Secretaries—  
WM. C. TOWNSHEND, Esq., J.P.  
R. BUTLER, Esq.

*Annual Subscriptions.*

Brooke, The Misses	1	0	0
Butler, R. Esq.	1	0	0
Cobbe, C. Esq.	3	0	0
Grogan, Rev. J.	1	0	0

	£.	s.	d.
Jameson, John, Esq.	1	0	0
Palmer, Major-Gen.	5	0	0
Sir Roger, Bart.	5	0	0
Perrin, M. Esq.	1	0	0
<b>Total</b>	<b>13</b>	<b>0</b>	<b>0</b>

**SKERRIES AND BALBRIGGAN BRANCH.**

Chairman—  
ION TRANT HAMILTON Esq., M.P.

Honorary Secretaries—  
HENRY A. HAMILTON, Esq., J.P., Balbriggan.  
HENRY H. FOSTER, Esq., Skerries.

*Annual Subscriptions.*

B——, Miss, per C.	10	0	0
Cobbe, Esq.	10	0	0
B——, Miss G., per C. Cobbe, Esq.	10	0	0
Cobbe, Charles, Esq.	1	1	0
Foster, H. H.	1	0	0
Gowan, Francis, Esq.	1	0	0
Hamilton, H. A. Esq.	1	1	0
Hamilton, Ion T. Esq., M.P.	2	0	0
Hamilton, Mrs.	1	1	0
Hutchinson, Hon. Mrs. C. Hely	1	1	0
Palmer, Sir R. Bart.	2	0	0
Pepper, T. St. George, Esq.	1	1	0
Scriven, Dr.	1	1	0
Talbot de Malahide, Lord	1	1	0
Taylor, Col. Rt. Hon. T. E., M.P.	2	0	0
Woods, Edward H. Esq.	2	0	0
Collection in Box	4	0	0
<b>Total</b>	<b>12</b>	<b>11</b>	<b>0</b>

**BALBRIGGAN BRANCH.**

Chairman—  
EDWARD HAMILTON WOODS, Esq., J.P.

Honorary Secretary—  
H. A. HAMILTON, Esq., J.P.

*Annual Subscriptions.*

Filgate, Capt.	1	1	0
Grogan, Rev. John	1	0	0
Hamilton, Henry A.	1	1	0
Hussey, A. Esq.	1	1	0
Jameson, R. D. Esq.	1	0	0
Moore, R. T. Esq.	1	0	0
Taylor, Col., M.P.	1	0	0
Woods, E. H. Esq.	1	0	0
Woods, W. St. L. Esq.	1	1	0
Whyte, Wm. Esq.	1	1	0
<b>Total</b>	<b>10</b>	<b>5</b>	<b>0</b>

**Co. Fermanagh.**

**ENNISKILLEN BRANCH.**

President—  
The Right Hon. The EARL OF BELMORE.

Chairman—  
Rev. Dr. STEELE.

Honorary Secretary—  
Hon. Mrs. POMEROY

*Annual Subscriptions.*

	£.	s.	d.
Archdale, Col.	10	0	0
Archdale, W. Esq., M.P.	1	0	0
Bagot, Dr., M.D.	5	0	0
Belmore, Earl of	1	0	0
Brooke, Mrs. Butler	1	0	0
Colley, Miss Pomeroy	10	0	0
Crichton, Hon. Capt. H.	2	0	0
Crichton, Lady C.	1	0	0
Greer, Rev. S.	1	0	0
Jones, Mrs.	5	0	0
Knox, Miss Emily	7	6	
Knox, Mrs. W.	1	0	0
Pomeroy, Hon. Mrs. A.	2	0	0
Pomeroy, John A. Esq.	1	0	0
Pomeroy, Mrs. J. A.	5	0	0
Pomeroy, W. K. Esq.	1	0	0
Stewart, C. Esq.	1	0	0
Stirling, Mrs. of Gardin	1	0	0
Tipping, Lieut. H. Gartaid, R.N.	1	0	0
Williams, W. Esq.	5	0	0
Wood, Mrs.	5	0	0
Sums under 5s.	14	6	
<b>£18 7 0</b>			

**Co. Kerry.**

**TRALEE BAY BRANCH.**

President—  
The Rt. Hon. LORD VENTRY

Vice-President—  
Lieut.-Col. CROSBY.

Honorary Secretary—  
Mr. ROBERT McCOWEN,  
Lloyd's Agent.

*Annual Subscriptions.*

	£.	s.	d.
Crosbie, Col.	1	0	0
Day, Rev. J. F.	10	0	0
Denny, F. McC. Esq.	10	0	0
Denny, Major	1	0	0
Donovan & Sons, John	2	0	0
Donovan, Sir H.	1	0	0
Downing, F. C. Esq.	1	0	0
Hawkey, Capt.	1	0	0
Hurley, J. D. Esq.	1	0	0
Hussey, S. M. Esq.	1	0	0
Leahy, John R. Esq.	1	0	0
Palmer, R. E. Esq.	1	1	0
McCowen, Robt. Esq.	1	0	0
O'Connell, D. J. Esq.	5	0	0
Ventry, Lord	1	0	0
<b>£14 8 0</b>			

**VALENTIA BRANCH.**

Honorary Secretary—  
The KNIGHT OF KERRY.

Assistant Hon. Secretary—  
Mr. JOHN O'DRISCOLL.

*Annual Subscriptions.*

	£.	s.	d.
Butler, James, Esq.	1	0	0
Dunraven, The Earl of	1	1	0
Fitzgerald, J. F. Esq.	10	0	0
Hartopp, E. B. Esq.	1	0	0
Kerry, The Knight of	1	0	0
Lansdowne, The Marquis of	3	0	0
Leahy, John, Esq. (Reps.)	1	0	0
Mahony, Richd. Esq.	1	0	0
Dromore	1	0	0
O'Connell, Dan. Esq.	1	0	0
Derrynane	1	0	0
Slaughton, T. A. Esq.	1	0	0
Trinity Col. Dublin	3	3	0
<b>Total</b>	<b>14</b>	<b>14</b>	<b>0</b>

**Co. Limerick.**

**LIMERICK BRANCH.**

Secretary and Collector—  
Mr. J. PIKE.

*Annual Subscriptions.*

	£.	s.	d.
Alexander, Jas. Esq.	1	1	0
Bannatyne, J. & Son	1	0	0
Boyd, J. and G.	1	0	0
Clarina, Lady	1	0	0
Cochrane, William	1	0	0
Daly and Co. Limited, Messrs. John	10	0	0
Fitt, Edward	10	0	0
Harris, Messrs., and Sons	1	0	0
Limerick Harbour Commissioners	5	0	0
Matterson and Sons, Messrs.	1	0	0
Russell and Sons, Messrs. Jno. N.	1	0	0
Shaw & Sons, Messrs. W. J.	1	0	0
Spaight and Sons, Messrs. F.	1	0	0
Todd and Co. Messrs.	1	0	0
Wallace, Richard	5	0	0
<b>Total</b>	<b>14</b>	<b>16</b>	<b>0</b>

**Co. Londonderry.**

**LONDONDERRY AND GREENCASTLE BRANCH.**

President—  
JOHN COOKE, Esq.

Honorary Secretary—  
Rev. T. McCLELLAN.

*Annual Subscriptions.*

	£.	s.	d.
Andrews, Mr.	5	0	0
Bigger, Mr.	5	0	0
Black & Co. Messrs. A.	10	0	0
Burns, Messrs. G. and J.	1	0	0

	£.	s.	d.
Campbell, Mr. R.	5	0	0
Christy, Mr. J.	5	0	0
Colhoun, Mr. J.	5	0	0
Cook, Mr. John	10	0	0
Cook, Messrs. J. J.	10	0	0
Crosbenden, Mr. Jas.	10	0	0
Crosbie, Mr. Pierce	5	0	0
Derry, Lord Bishop	2	0	0
Donegall, Lord	2	0	0
Donnell & McDevit, Messrs.	5	0	0
Ferris, Mr. W.	5	0	0
Gilleland, Mr. G. K.	10	0	0
Gordon, Mr. Thos.	5	0	0
Hegan, Mr. S. M.	5	0	0
Hamilton, Mr. H. S.	5	0	0
Hastings, Mr. Ross	5	0	0
Irish Society, Hon.	5	0	0
Irvine & Co. Messrs.	5	0	0
Irvine, Major	5	0	0
Lecky, Mr. H.	5	0	0
Lepper, Mr.	5	0	0
Liverpool Steamboat Company	10	0	0
Lloyd, Mr. Thomas	5	0	0
Londonderry Harbour Company	10	0	0
Major, Rev. Canon	5	0	0
McCandless, Mr. Sam.	5	0	0
McClellan, Rev. Thos.	10	0	0
McClelland, Mr.	5	0	0
McCorkill, Mr. Jas.	5	0	0
McCorkill, Mr. B. Jun.	5	0	0
McVicker, Messrs.	5	0	0
Miles, Mr. Thomas	5	0	0
Moville Hotel Box	6	8	0
Montgomery, Sir R.	1	0	0
Muholland & Co. Messrs.	10	0	0
Newton, Mr. R. (2 years)	1	0	0
O'Neill, Mr. Charles	5	0	0
Pollock, Mr. J. J.	5	0	0
Robinson, Messrs.	5	0	0
Rogers, Mr. P. T.	5	0	0
Russel, Mr. Jos. (2 years)	1	0	0
Sawers, Mr.	5	0	0
Scotch Steamboat Co.	1	0	0
Scott, Rev. Canon	5	0	0
Steel and McCaskell, Messrs.	10	0	0
Talbot, Messrs.	5	0	0
Watson, Mr. Thos.	5	0	0
Watt & Co. Messrs. D. (2 years)	1	0	0
White, Dr.	10	0	0
Williams, Mr.	5	0	0
	£38	11	8

**Cos. Louth and Meath.**

**DROGHEDA BRANCH.**

Patron—  
The MARQUIS OF CONYNGBAM.  
Honorary Secretary at  
Baltray—  
NICHOLAS HALLIGAN, Esq.  
Honorary Secretary for  
Mornington—  
MR. JAMES MCCARTIN.  
Secretary and Collector—  
MR. J. MCNAMARA.  
Annual Subscriptions.

	£.	s.	d.
The Harbour Board	5	0	0
Steam Packet Co.	5	0	0
Balfour, B. T., D.L.	1	0	0

	£.	s.	d.
Bank of Ireland	1	0	0
Belfast Banking Co.	1	0	0
Brodigan, Colonel	1	0	0
28th Regiment	1	0	0
Cairnes, T. P., J.P.	10	0	0
Catnach, Mrs.	5	0	0
Chadwick, Messrs. J. and F.	10	0	0
Clinton, Robert	5	0	0
Coddington, H. B., J.P.	10	0	0
Conyngham, Marquis of (Patron)	1	0	0
Daly & Son, Messrs.	5	0	0
R. Daly, Alderman Robert B., J.P.	10	0	0
Darney, Earl of	2	0	0
Davis & Co. Messrs. A.	10	0	0
Dean, Joseph	10	0	0
Donagh, Francis, J.P.	1	0	0
Greene, J. J. F., C.E.	5	0	0
Grendon & Co. Messrs. Thomas	10	0	0
Halligan, N.	5	0	0
Hibernian Bank	10	0	0
Hughes, John	5	0	0
Jameson, James, J.P.	1	0	0
Kennedy, Richard J.	5	0	0
M'Donough, Edward	5	0	0
Montgomery, Richard T., J.P.	10	0	0
Morton, Messrs. J. and R.	10	0	0
Pepper, Thomas St. George, J.P.	1	0	0
Pepper, Chas.	1	0	0
Pepper, the Misses	1	0	0
Provincial Bank	10	0	0
Saw Mills Company	10	0	0
Smith, R., J.P.	10	0	0
Smyth, Miss	5	0	0
Smyth, R., J.P.	10	0	0
Toker, Capt. Edw., s.s. <i>Norah Creina</i>	5	0	0
Wetherill and Co. Messrs.	10	0	0
Whitworth, Wm., J.P.	10	0	0
Whitworth, Nicholas	10	0	0
Woolsey, Jameson, & Co. Messrs.	10	0	0
Subscription box, Custom House	7	11	0
Total	£33	17	11

**DUNDALK BRANCH**

Chairman—  
MICHAEL KELLY, Esq. J.P.  
Honorary Secretary—  
J. F. FARRELL, Esq.  
Annual Subscriptions.

	£.	s.	d.
Kelly, Mr.	1	0	0
Robson, Wm.	1	0	0
Tempest, Wm.	1	0	0
Total	3	0	0

Donations.  
Dundalk Harbour Commissioners... 32 5 7

£35 5 7
---------

**Co. Waterford. ARDMORE BRANCH.**

Chairman—		£.	s.	d.
Rev. THOMAS R. ROTHWELL.				
Honorary Secretary—				
W. C. POOLE, Esq., M.D., J.P.				
Annual Subscriptions.				
£. s. d.				
Bagge, John H. Esq.		1	0	0
J.P.		10	0	0
Cotton, Captain		10	0	0
Cotton, C. P. Esq. C.E.		1	0	0
Cotton, R. W. Esq.		10	0	0
Cotton, Miss		10	0	0
Cotton, Miss E.		10	0	0
Cotton, Mrs.		1	0	0
Donoughmore, Earl of		1	0	0
Foley, Thomas, Esq.		20	0	0
J.P.		10	0	0
Foley, Edmund, Esq.		10	0	0
Foley, Richard, Esq.		10	0	0
Keane, Col. W. A.		10	0	0
Muggrave, Sir R. J. Bart.		2	0	0
McKenna, Sir J. N., M.P.		1	0	0
Paul, Sir Robert J., Bart.		1	0	0
Poole, Wm. C. Esq. J.P.		10	0	0
Power, Mrs.		10	0	0
Rothwell, Rev. Thos.		10	0	0
Sheppard, Colonel		5	0	0
Ussher, Mrs.		1	0	0
Total	£14	15	0	

**DUNGARVAN BRANCH.**

Patron—  
His Grace the DUKE OF DEVONSHIRE, K.G.  
President—  
Lord STUART DE DECIES.  
Treasurers—  
NATIONAL BANK.  
Honorary Secretary—  
MR. JAMES W. SHAW.

Annual Subscriptions.		£.	s.	d.
Ardagh, W. M.		5	0	0
Gibbons, Capt. Wm.		10	0	0
Harbour Commissioners, The		3	0	0
Hudson, R. G. Esq.		10	0	0
Humble, Sir J. Nugent, Bart.		2	0	0
Hunt, John, Esq.		10	0	0
McConey, Mrs.		5	0	0
McGwire, S. E. Esq.		1	0	0
Merry, Robert A. Esq.		5	0	0
Power, Sir R. Bart.		1	0	0
Ussher, R. J. Esq.		1	0	0
Waterford, Lord.		2	0	0
Sums under 5s.		3	13	0
Total	£15	18	0	

**TRAMORE BRANCH.**

Chairman—		£.	s.	d.
The Hon. D. FORTESCUE.				
Honorary Secretary—				
EDWARD JACOB, Esq.				
Annual Subscriptions.				
Ambrose, Charles		10	0	0
Ardagh, Robert, Esq.		10	0	0
Beresford, Lord Charles		2	0	0
Bessborough, Earl of		1	0	0

	£.	s.	d.
Budd, Alfred, Esq.	5	0	0
Budd, James, Esq.	10	0	0
Christy, Wakefield	1	0	0
Clibborn, Edwd. Esq.	10	0	0
Denny, Messrs. A. & E.	2	0	0
Denny, Charles, Esq.	10	0	0
Denny, Henry, Esq.	10	0	0
Donerale, Lord.	3	0	0
Dormer, Thos. P. Esq.	10	0	0
Fisher, Joseph, Esq.	10	0	0
Fortescue, Earl.	2	0	0
Fortescue, Hon. D.	2	0	0
Goff, Strangman D.	2	0	0
Goff, William D.	10	0	0
Graves, J. P. Esq.	10	0	0
Grubb, Miss H.	1	0	0
Grubb, Miss L. & S.	1	0	0
Hallows, Rev. R.	1	1	0
Hanrahan, P. F. Esq.	5	0	0
Harbour Board of Waterford	10	0	0
Jacob, Edward	10	0	0
Jacob, Francis	10	0	0
Jacob, T. W. Esq. J.P.	10	0	0
Kavanagh, Lady Harriet	1	0	0
Kent, David, Esq.	5	0	0
Murray, H. Esq.	10	0	0
Newman, Mrs. C.	10	0	0
Newman, R.	5	0	0
O'Shea, Lady G.	1	0	0
Peet, Edward G. Esq.	10	0	0
Pim, Mrs.	5	0	0
Power, E. H. Esq.	10	0	0
Power, P. W. Esq. J.P.	1	0	0
Power, Rev. R. P.P.	10	0	0
Riall, J. Esq.	10	0	0
Riall, Miss	10	0	0
Rochford, Capt. R.N.	10	0	0
Ryan, Lawrence, Esq.	10	0	0
Slattery, Messrs.	10	0	0
Strangman, S. Esq.	1	0	0
Strangman, Miss C.M.	5	0	0
Tottenham, Mrs. W. D.	1	1	0
Ward Brothers	10	0	0
Wark, John, Esq.	10	0	0
Waterford Steam Ship Co.	5	0	0
White Brothers, Messrs.	1	0	0
White, Edwin, Esq.	5	0	0
White, George, Esq.	5	0	0
White, William Esq.	5	0	0
Wilson, John, Esq.	1	0	0
Total	£54	17	0

Donations.		£.	s.	d.
Coll. by Mrs. Davis				
Ennesworthy		3	19	7
Collection Box at O. Viacava, Italian Consular Agent, Waterford		1	0	0
Collection Box at Jacob, Brothers		5	6	
		£60	2	1

**Co. Wexford. CAHORE BRANCH.**

Honorary Secretary—		£.	s.	d.
Capt. RICHARD D'OLIER GEORGE.				
Assistant Hon. Secretary—				
MR. JOHN SINNOTT.				
Annual Subscriptions.				
£. s. d.				
Bates, Mr. James		10	0	0
Bolton, Wm. Esq.		1	0	0
Bond, E. C. Esq.		10	0	0
Brooke, G. Esq.		1	0	0



**BRANCHES—LIST OF ANNUAL DONATIONS AND SUBSCRIPTIONS. 381**

	£.	s.	d.
Bryan, L. A. Esq. . . . .	2	0	0
Hurkitt, T. H. Esq. . . . .	-	5	0
Chambers, Rev. J. W., D.D. . . . .	-	10	0
City of Dublin Steam- packet Company . . . . .	1	1	0
Corcoran, John, Esq. . . . .	-	10	0
Courtown, Earl of . . . . .	1	0	0
Day, Rev. A. B. . . . .	-	10	0
Donovan, Rich. Esq. . . . .	-	5	0
Doyne, C. M. Esq. . . . .	1	0	0
Eaton, Messrs. M. & S. . . . .	-	10	0
Foster, W. O. Esq. . . . .	1	0	0
Furlong, Rev. J. L., P.P. . . . .	1	0	0
George, Mrs. Mary, Sen. . . . .	-	10	0
George, Capt. R. D'O. . . . .	2	0	0
Godkin, Mr. J. . . . .	-	10	0
Graves, E. Esq. . . . .	1	0	0
Hogan, J. A. Esq. . . . .	1	1	0
Hughes, Sir F. . . . .	1	0	0
Lee, Major . . . . .	1	0	0
Little, S. Esq. . . . .	1	0	0
Lloyd, M. Esq. . . . .	-	10	0
Murdock, Rev. J. C. . . . .	1	0	0
Murphy, J., Esq. . . . .	-	10	0
Murphy, G. Esq. . . . .	-	10	0
Murphy, Michael, Esq. . . . .	-	10	0
Murphy, Rev. P., C.C. . . . .	-	10	0
O'Brien, Rev. J., P.P. . . . .	-	10	0
O'Leary, W. H. Esq., M.D. . . . .	-	10	0
Pounden, J. C. Esq. . . . .	-	7	6
Power, Sir Jno. Bart. . . . .	1	0	0
Richards, Mrs. . . . .	1	0	0
Richards, Mrs. . . . .	-	10	0
Roche, Mrs. . . . .	1	0	0
Scott, J. S. Esq. . . . .	1	0	0
Sinnett, Mr. John . . . . .	-	10	0
Stanley, Rev. A. . . . .	-	15	0
Symes, R. Esq. . . . .	1	0	0
Warren, G. W. Esq. . . . .	-	10	0
Whitcroft, Jno. Esq. . . . .	1	0	0
Sums under 5s. . . . .	-	9	1
<b>Total. . . . .</b>	<b>£34</b>	<b>3</b>	<b>7</b>

**CARNSORE BRANCH.**

Chairman—			
Hon. J. A. KEANE, D.L.			
Honorary Secretary—			
Rev. T. W. MANNING.			
Annual Subscriptions.			
Alexander, (Capt. R.E.)			
A. C. . . . .	1	0	0
Alexander, Miss . . . . .	-	10	0
Alexander, Rev. J. . . . .	-	3	0
Blacker, Mrs. John R. . . . .	1	0	0
Boxwell, Frank, Esq. J.P. . . . .	1	0	0
Garvey, Miss J. M. . . . .	1	0	0
Gilbert, John, Esq. . . . .	-	5	0
Going, Mrs. . . . .	-	5	0
Hatton, Mrs. . . . .	-	5	0
Jeffares-Brett, Mrs. . . . .	-	5	0
Keane, Hon. Major, D.L. . . . .	1	0	0
Keane, Hon. Mrs. . . . .	1	0	0
Lett, B. Esq. . . . .	1	0	0
Lett, Mrs. . . . .	1	0	0
Little, Miss . . . . .	-	10	0
Mahony, W. A. Esq. . . . .	-	10	0
Morgan-Deane, Hon. Mrs. . . . .	1	0	0
M'Kinnell, Jos. Esq. . . . .	-	5	0
Palmer, Mrs. Ricardo . . . . .	1	0	0
Segrave, Mrs. . . . .	1	0	0
Steele, R. B. Esq. . . . .	-	5	0
<b>Total. . . . .</b>	<b>14</b>	<b>5</b>	<b>0</b>
Donation.			
Furlong, Mr. B. . . . .	1	0	0
<b>£15</b>	<b>5</b>	<b>0</b>	

**COURTOWN  
BRANCH.**

Patron—			
Rt. Hon. Earl of Courtown.			
Treasurer and Hon. Sec.—			
JAMES S. SCOTT, Esq., J.P.			
Annual Subscriptions.			
	£.	s.	d.
Allen, John B. M.D. . . . .	1	0	0
Arthur, Rev. Canon. . . . .	1	0	0
Biokerdike, Rev. J. F. for 1878 & 1879 . . . . .	1	0	0
Cooke, Mr. Wm. . . . .	-	5	0
Courtown, Earl of . . . . .	2	0	0
Courtown, Countess. . . . .	1	0	0
Cox, Lieut.-Col. C. Wolsey . . . . .	1	0	0
Davis, Messrs. S. & A. G. . . . .	1	0	0
Devereux, John D. Esq. . . . .	-	10	0
Doyle, Mr. John . . . . .	-	5	0
Doyne, C. M. Esq. . . . .	1	0	0
Doyne, J. W. C. Esq. . . . .	1	0	0
Eckersall, Mrs. . . . .	1	0	0
Edwards, Thos. Esq. . . . .	1	0	0
Ellis, T. C. Esq. for 1879 & 1880. . . . .	1	0	0
Esmond, Sir Thos. . . . .	1	0	0
Fitzsimons, Mrs. M. . . . .	-	5	0
Foster, W. O. Esq. . . . .	1	0	0
George, Captain R. d'Olier . . . . .	1	0	0
Gibbon, J. G. Esq. L.L.D. . . . .	1	0	0
Guise, Major-General John C. V.C. . . . .	1	0	0
Hamilton, Rev. Chas. for year 1878. . . . .	1	0	0
Hatton, Colonel . . . . .	1	0	0
Little, Simon, Esq. . . . .	1	0	0
Montgomery, Mrs. A. Shirley . . . . .	1	0	0
Nixon, Mrs. . . . .	-	10	0
Felan, Mrs. Eliza . . . . .	-	5	0
Power, Sir John Talbot, Bt. . . . .	1	0	0
Ram, Rev. Canon, for 1879 & 1880. . . . .	2	0	0
Redmond, Mr. Jos. . . . .	-	5	0
Richards, Arthur W. M. Esq. . . . .	1	0	0
Roe, C. D. J. Esq. . . . .	-	5	0
Scott, Jas. S. Esq. . . . .	1	0	0
Sinnett, Rev. Robert, P.P. . . . .	-	10	0
Stopford, Hon. E. S. . . . .	1	0	0
Ward, Mrs. Bernard . . . . .	1	0	0
Ward, Capt. T. Le Hunte, R.N. . . . .	1	0	0
Sums under 5s. . . . .	1	7	6
<b>Total. . . . .</b>	<b>34</b>	<b>7</b>	<b>6</b>
Donations.			
Stopford, Hon. E. S., coll. by. . . . .	1	15	0
Monck, Hon. H. . . . .	-	5	0
Henchy, O'Connor, Esq. . . . .	-	7	4
Stopford, Mrs. Robt. De Cerjat, Master, coll. by. . . . .	-	12	8
Collecting Boxes . . . . .	3	5	3
<b>£40</b>	<b>17</b>	<b>9</b>	
DUNCANNON AND WATERFORD HARBOUR BRANCH.			
Chairman—			
Sir ROBERT PAUL, Bart.			
Honorary Secretary—			
Mr. J. MCGONAGIL.			
Annual Subscriptions.			
Bartlett, S. D. Esq. . . . .	1	1	0
Carew, Dowager Lady . . . . .	2	0	0

	£.	s.	d.
Chichester, Hon. Capt. . . . .	1	0	0
Denny, A. Esq. . . . .	1	0	0
Gough, S. D. Esq. . . . .	1	0	0
Graves, Rev. James. . . . .	-	5	0
Leigh, F. Esq. . . . .	1	0	0
Little, S. Esq. . . . .	1	0	0
Templemore, Lord. . . . .	3	3	0
Waterford, Marq. of . . . . .	2	0	0
Waterford Harbour Commissioners . . . . .	10	0	0
Waterford S. S. Co. . . . .	5	0	0
White Brothers . . . . .	2	0	0
<b>Total . . . . .</b>	<b>£30</b>	<b>9</b>	<b>0</b>

**WEXFORD AND  
ROSSLARE BRANCH.**

Chairman—			
R. J. DEVEREUX, Esq.			
Honorary Secretary—			
WILLIAM COGHLAN, Esq.			
Annual Subscriptions.			
Armstrong, Mrs. . . . .	-	10	0
Armstrong, W. Esq. . . . .	-	5	0
Bacon, John, Esq. . . . .	1	0	0
Barrington, J. Esq. . . . .	-	5	0
Barry & Co. John E. . . . .	1	0	0
Boxwell, Harvy, Esq., J.P. . . . .	1	0	0
Bristol Steam Navi- gation Company . . . . .	1	1	0
Brown, W. Esq. . . . .	1	0	0
Carew, Right Hon. Lord, K.P. . . . .	1	0	0
Codd, Capt. Sallee . . . . .	-	10	0
Devereux, John Thos., D.L. . . . .	1	0	0
Devereux, J. P. Esq. D.L. . . . .	1	0	0
Devereux, L. Esq. . . . .	1	0	0
Devereux, R. Esq. . . . .	1	0	0
Devereux, Richard J. . . . .	1	0	0
Donoughmore, Earl of . . . . .	1	0	0
Ennis, Michael, Esq. . . . .	-	5	0
Faris, David, Esq. . . . .	-	5	0
Gafney, W. J. Esq. . . . .	1	0	0
Goff, S. D. Esq., J.P. . . . .	2	0	0
Hatton, Colonel, D.L. . . . .	1	0	0
Hutchinson, Thos., manager for Maude Annie, J. P. Taylor, British Queen, Sea- flower, &c. . . . .	1	0	0
Lambert, P. Esq. . . . .	-	5	0
Leigh, Miss . . . . .	1	0	0
Leigh, Miss M. A. . . . .	1	0	0
Little, S. Esq. . . . .	1	0	0
Morgan, Hon. Mrs. D. . . . .	1	0	0
Peacock, Chas. H. Esq., J.P. . . . .	1	0	0
Power, Sir John T. Bart., D.L. . . . .	1	0	0
Richards, Mrs. . . . .	1	0	0
Templemore, The Rt. Hon. Lord. . . . .	2	2	0
Walker, Capt. D. L. . . . .	1	0	0
Walker, Mrs. . . . .	1	0	0
Walker, Robt. D. Esq. . . . .	-	10	0
Wexford Harbour Commissioners . . . . .	5	0	0
Contribution Box, Custom House. . . . .	-	12	2
<b>Total . . . . .</b>	<b>£36</b>	<b>10</b>	<b>2</b>
Donation.			
Clayton, R. C. Brown, D.L. . . . .	5	0	0
<b>£41</b>	<b>10</b>	<b>2</b>	

**Co. Wicklow.**

**ARKLOW BRANCH.**

Chairman—			
THE EARL OF CARYSFORT.			
Treasurer—			
PETER J. BLAKE, Esq.			
Honorary Secretary—			
THE EARL OF WICKLOW.			
Assistant Hon. Sec.—			
DR. HALPIN.			
Annual Subscriptions.			
	£.	s.	d.
Bayly, Col. D. L., J.P. . . . .	1	0	0
Bauman, Miss. . . . .	1	0	0
Bryan, Rev. W. B. . . . .	-	5	0
The Earl of Carysfort . . . . .	0	0	0
Daly, Rev. Wm. . . . .	-	5	0
Dowl, Mrs. . . . .	-	5	0
Doyle, Mrs. John . . . . .	-	5	0
Hall, Mr. Job . . . . .	-	5	0
Halpin, Dr. . . . .	-	5	0
Kearon, Mr. Edward . . . . .	-	5	0
Kearon, Mr. Richard . . . . .	-	5	0
Maher, Mr. Patrick . . . . .	-	5	0
O'Grady, Hon. Mrs. . . . .	-	10	0
Ormsby, Rev. W. G. . . . .	1	0	0
Robinson, Hen. Esq. . . . .	-	10	0
Sums under 5s. . . . .	-	6	6
<b>Total. . . . .</b>	<b>22</b>	<b>11</b>	<b>0</b>

*Collected from Out-Pensioners at the undermentioned Stations on behalf of this Lifeboat.*

Donations.			
Birmingham, per Major Fresson . . . . .	13	19	5
Chatham, per Capt. H. G. Rogers . . . . .	9	14	6
Exeter District, per Lt.-Col. Brockman . . . . .	5	0	0
Southampton, per Major D. Beere . . . . .	6	19	8
Bristol, per Col. J. T. Chandler . . . . .	-	6	6
<b>Total Dona. . . . .</b>	<b>36</b>	<b>0</b>	<b>1</b>
<b>Total Subs. . . . .</b>	<b>22</b>	<b>11</b>	<b>0</b>
<b>£58</b>	<b>11</b>	<b>1</b>	

**GREYSTONES  
BRANCH.**

President—			
THE EARL OF MEATH.			
Chairman—			
WM. R. LA TOUCHER, Esq.			
Honorary Secretary—			
PATRICK REID, Esq.			
Annual Subscriptions.			
Corbet, William J. Esq. M.P. . . . .	1	0	0
Burnaby, Mrs. . . . .	2	0	0
Doyle, Mr. John . . . . .	-	5	0
Furlong, Miss . . . . .	-	10	0
Hodson, Sir Geo. Bt. . . . .	1	0	0
La Touche, W.R. Esq. . . . .	3	0	0
Lunel, Misses . . . . .	1	0	0
Macfarlane, Colonel . . . . .	-	10	0
Maziere, Misses . . . . .	-	5	0
M'Clelland, R. Esq. M.D. . . . .	1	0	0
Meade, J. F. Esq. . . . .	-	10	0
Meath, The Rt. Hon. the Earl of. . . . .	3	0	0
Newton, Misses . . . . .	1	0	0
Pennick, Robt. Esq. . . . .	-	5	0
Reid, Patrick, Esq. . . . .	2	0	0

	£.	s.	d.
Scott, J. W. Esq. ....	-	10	0
Streane, Ven. Arch-deacon H. ....	-	10	0
Tombe, G. E. Esq. ....	1	0	0
Sums under 5s. ....	-	5	0
<b>Total.....</b>	<b>19</b>	<b>11</b>	<b>0</b>

*Donations.*

Collecting Box in Life-boat House... -	14	8
<b>£20</b>	<b>5</b>	<b>8</b>

**WICKLOW BRANCH.**

*Patrons—*  
The Right Hon. the EARL FITZWILLIAM and W. W. FITZWILLIAM DICK, Esq. M.P.

*Chairman—*  
H. P. TRUETT, Esq., M.B., J. P.

*Treasurer and Hon. Sec.—*  
S. E. PRIM, Esq.

*Annual Subscriptions.*

Atkinson, Lieut.-Col.	1	0	0
Bank, Hibernian, Wicklow	1	1	0
Billbrough, B. P. Esq.	1	0	0
Collins, Capt. J. S., R.N.	-	10	0
Courtenay, W. Esq., J.P.	-	10	0
Darcy, Mr. Thomas	-	5	0
Dick, W. W. F. Esq.	1	0	0
Doolittle, Capt. E.	-	5	0
Doolittle, Mr. A.	-	5	0
Drought, Rev. J. W.	1	0	0
Drought, Captain R. R., J.P.	1	0	0
Dublin, Archbishop of	1	0	0
Edwards and Sons, Messrs. John	1	0	0
Ellis, R. F. Esq. J.P.	1	0	0
Evans, Capt. E. B., R.A.	1	0	0
Fitzwilliam, Earl	2	0	0
Gregg, Mr. W.	-	10	0
McCaughy, Rev. G.	-	5	0
Nolan, John, Esq.	-	10	0
Pim, S. E. Esq.	-	10	0
Rooke, Rev. Henry	-	5	0
Spinner, Mrs.	-	10	0
Tighe, Lt.-Col. J. S., J.P., D.L.	1	1	0
Tottenham, Lt.-Col. of Ballycurry	1	1	0
Truell, H. P. Esq., M.B., J.P.	1	0	0
<b>Total.....</b>	<b>£19</b>	<b>8</b>	<b>0</b>

**Isle of Man.**

**CASTLETOWN BRANCH.**

*Chairman—*  
J. M. JEFFCOFT, Esq., High Bailiff.

*Honorary Secretary—*  
GEORGE H. QUAYLE, Esq.

*Annual Subscriptions.*

	£.	s.	d.
The Lieut.-Governor	2	0	0
Cary, Lieut.-Colonel	-	10	0
Claque, Mrs.	-	5	0
Crellin, R. Q. Esq.	-	10	0
Cudd, W. H. Esq.	-	10	0
Dodd, Tom M.	-	5	0
Drinkwater, Sir W. L. Deemster	1	0	0
Ferrier, Miss E.	-	5	0
Gawne, Mrs.	1	0	0
Geneste, Captain	-	5	0
Gill, Sir James, Attorney-General	-	10	0
Gill, Fred I.	-	5	0
Gill, Mrs.	-	5	0
Hughes-Games, Rev. J., D.C.L.	-	5	0
Isle of Man Steam- packet Company	2	2	0
McClellan, Miss	-	5	0
Moore, Thos. Esq.	-	5	0
Moore, W. F. Esq.	-	10	0
Newton, Miss	-	10	0
Quayle, Geo. P. Esq.	-	5	0
Quayle, Mrs.	-	10	0
Stevenson, W. B.	-	10	0
The Archdeacon Moore	-	10	0
The Clerk of the Rolls	-	5	0
The High Bailiff	-	5	0
Trafford, Rev. W.	-	5	0
Woodhouse, Mrs.	-	5	0
Sums under 5s.	3	17	6
Amount in Life-boat Boxes	-	7	4
<b>Total.....</b>	<b>£18</b>	<b>6</b>	<b>10</b>

**DOUGLAS BRANCH.**

*Patron—*  
His Excellency the LIEUT.-GOVERNOR.

*President—*  
THE HIGH BAILIFF OF DOUGLAS.

*Treasurer and Hon. Sec.—*  
THOMAS BAWDEN, Esq.

*Annual Subscriptions.*

Lieut.-Governor	3	3	0
Archer, R. Esq.	-	5	0
Bawden, T. Esq.	-	5	0
Bell, R. T. Esq.	-	10	0
Bowman, Mrs.	-	5	0
Brown, Jas. and Son	-	5	0
Callow, T. C. Esq.	-	5	0
Clarke, Sam. Esq.	-	10	6
Clinch, J. W. Esq.	-	5	0
Coole, James, Esq.	-	5	0
Corlett, Capt. T.	-	5	0
Cowell, J. Esq.	-	5	0

Cubbon, Joseph, Esq.	-	5	0
Cubbon, Thos. Esq.	-	5	0
Gill, Capt. P.	-	10	0
Great Laxey Mining Co. (Limited)	2	2	0
Greensill, T. S. Esq.	-	5	0
Hales, James, Esq.	-	5	0
Hall, Mrs. Cecil	5	0	0
Harris, S. Esq., High Bailiff	1	0	0
Harrison, Ridgway, Esq.	-	5	0
Karran, J. J. Esq.	-	10	0
Kermode and Kellett	-	10	0
Killey, Philip, Esq.	-	10	0
Lomas, Sam. Esq.	-	10	0
Moore, W. F. and Son	1	0	0
Okell, Dr.	-	5	0
Quine, Thos. Esq.	-	10	6
Sodor and Man, Lord Bishop of	1	0	0
Steam Packet Co.	5	0	0
Todhunter & Elliot, Messrs.	-	5	0
Torrance and Co. Messrs. G.	-	5	0
Whiteside, Hy. Esq.	-	5	0
Sums under 6s.	1	12	0
<b>Total.....</b>	<b>£28</b>	<b>8</b>	<b>0</b>

**RAMSEY BRANCH**

*President—*  
His Excellency the LIEUT.-GOVERNOR.

*Chairman—*  
J. C. LA MOTHE, Esq., High Bailiff of Ramsey.

*Honorary Secretary—*  
Rev. GEORGE PATON.

*Annual Subscriptions.*

His Excellency the Lieut.-Governor	2	2	0
Allen, T.	-	5	0
Brown, Mr. B.	-	5	0
Brown, Mr. W.	-	10	0
Buckley, N.	-	5	0
Cleator, Mr. R.	-	5	0
Cleucas, Dr.	-	5	0
Corkill, Mr. T.	-	5	0
Cremell, Mr. W.	-	5	0
Cromar, Capt.	-	5	0
Cruickshank, J. M.	-	5	0
Dumbell, Deemster, His Honour the	2	2	0
Farrant, Mr. E. C.	1	0	0
Fletcher, Mrs.	-	5	0
Gibb, Mrs.	-	1	0
Gilmour, Mrs.	-	5	0
Goldsmid & Cowley	-	5	0
Isle of Man Steam Packet Company	2	2	0
Kelly, Mr. R. J.	-	5	0
Kermode, Rev. W.	-	10	0
Lamothe, Mr. J. C.	-	5	0
Leaf, Mrs.	-	1	0
Lucas, Mr. K.	-	1	0
McWhannell, Mr.	-	5	0
Moore, Archdeacon	1	1	0
Paterson, A. C. Mr.	-	5	0
Paton, Rev. George	1	0	0
Roose, Mr. W. D.	-	5	0
Rudd, Mr.	-	5	0
Scott, Mrs., Edinburgh	1	0	0
Skillicorn & Co.	-	7	6

	£.	s.	d.
Stephen, Deemster, His Honour (the late)	5	0	0
Teare and Co.	5	0	0
Theelluson, Colonel	1	0	0
Theelluson, Mr. E.	1	0	0
Wood, Dr.	-	5	0
Sums under 5s.	2	17	0
<b>Total.....</b>	<b>29</b>	<b>13</b>	<b>6</b>

*Donations.*

Miss Roose's Box	-	4	4
Mitre Hotel do.	-	14	0
Mrs. Lucas's do.	-	15	6
Royal Hotel do.	-	2	6
Albert Hotel do.	-	8	9
Swan Hotel do.	-	2	5
Bank do.	-	2	0
House do.	-	14	5
<b>Total Dons.</b>	<b>3</b>	<b>3</b>	<b>11</b>
<b>Total Subs.</b>	<b>29</b>	<b>13</b>	<b>6</b>
<b>£32</b>	<b>17</b>	<b>5</b>	<b>0</b>

**CHANNEL ISLANDS.**

**ALDERNEY BRANCH.**

*President—*  
T. N. BARBENSON, Esq., Judge of Alderney.

*Honorary Secretary—*  
NICOLAS BARBENSON, Esq.

*Donations.*

	£.	s.	d.
Barbenson, T. N. Esq.	-	10	0
Barbenson, N. Esq.	-	5	0
Cottle, Mr. F. J.	-	5	0
Le Mesurier, Rev. John	1	0	0
Ross, Rev. Wm.	-	5	0
<b>Total.....</b>	<b>£2</b>	<b>5</b>	<b>0</b>

**GUERNSEY BRANCH.**

*Chairman—*  
Capt. P. DE SAUSMAREZ, R.N.

*Honorary Secretary—*  
Capt. CAREB, R.N.

*Annual Subscriptions.*

States of Guernsey	28	10	0
Lockett, Mrs. and Misses, in addition to gift of Life-boat	5	0	0
Donation for Life-boat	1	0	0
<b>Total.....</b>	<b>£34</b>	<b>10</b>	<b>0</b>

# Royal National Life-boat Institution.

## DIRECTIONS FOR RESTORING THE APPARENTLY DROWNED.

THE leading principles of the following Directions for the Restoration of the apparently Dead from Drowning are founded on those of the late DR. MARSHALL HALL, combined with those of DR. H. R. SILVESTER, and are the result of extensive inquiries which were made by the Institution in 1863-4 amongst Medical Men, Medical Bodies, and Coroners throughout the United Kingdom. These Directions have been extensively circulated by the INSTITUTION throughout the United Kingdom and in the Colonies. They are also in use in Her Majesty's Fleet; in the Coast-guard Service; at all the Stations of the British Army at home and abroad; in the Light Houses and Vessels of the Corporation of the Trinity House; the Metropolitan and Provincial Police Forces; the Metropolitan School Board Schools; and the St. John Ambulance Association.

### I.

Send immediately for medical assistance, blankets, and dry clothing, but proceed to treat the Patient *instantly* on the spot, in the open air, with the face downward, whether on shore or afloat; exposing the face, neck, and chest to the wind, except in severe weather, and removing all tight clothing from the neck and chest, especially the braces.

The points to be aimed at are—first and *immediately*, the RESTORATION OF BREATHING; and secondly, after breathing is restored, the PROMOTION OF WARMTH AND CIRCULATION.

The efforts to *restore Breathing* must be commenced immediately and energetically, and persevered in for one or two hours, or until a medical man has pronounced that life is extinct. Efforts to promote *Warmth* and *Circulation*, beyond removing the wet clothes, and drying the skin, must not be made until the first appearance of natural breathing; for if circulation of the blood be induced before breathing has recommenced, the restoration to life will be endangered.

### II.—TO RESTORE BREATHING.

TO CLEAR THE THROAT.—Place the patient on the floor or ground, with the face downwards, and one of the arms under the forehead, in which position all fluids will more readily escape by the mouth, and the tongue itself will fall forward, leaving the entrance into the windpipe free. Assist this operation by wiping and cleansing the mouth.

If satisfactory breathing commences, use the treatment described below to promote Warmth. If there be only slight breathing—or no breathing—or if the breathing fail, then—

TO EXCITE BREATHING.—Turn the patient well and instantly on the side, supporting the head, and—

#### 1.—INSPIRATION.



Excite the nostrils with snuff, hartshorn, and smelting salts, or tickle the throat with a feather, &c., if they are at hand. Rub the chest and face warm, and dash cold water, or cold and hot water alternately on them. If there be no success, lose not a moment, but instantly—

TO IMITATE BREATHING—Replace the patient on the face, raising and supporting the chest well on a folded coat or other article of dress.

Turn the body very gently on the side and a little beyond, and then briskly on the face, back again, repeating these measures cautiously, efficiently, and perseveringly, about fifteen times in the minute, or once every four or five seconds, occasionally varying the side.

[By placing the patient on the chest, the weight of the body forces the air out; when turned on the side, this pressure is removed, and air enters the chest.]

On each occasion that the body is replaced on the face, make uniform but efficient pressure with brisk movement, on the back between and below the shoulder-blades or bones on each side, removing the pressure immediately before turning the body on the side.

During the whole of the operations let one person attend solely to the movements of the head and of the arm placed under it.

[The first measure increases the expiration—the second commences inspiration.]

\*\* The Result is *Respiration* or *Natural Breathing*;—and if not too late, *Life*,

## 2.—EXPIRATION.



The foregoing two illustrations show the position of the Body during the employment of Dr. Marshall Hall's Method of Inducing Respiration.

Whilst the above operations are being proceeded with, dry the hands and feet, and as soon as dry clothing or blankets can be procured, strip the body, and cover or gradually reclothe it, but taking care not to interfere with the efforts to restore breathing.

### III.

Should these efforts not prove successful in the course of from two to five minutes, proceed to imitate breathing by Dr. SILVESTER'S method, as follows:—

Place the patient on the back on a flat surface, inclined a little upwards from the feet; raise and support the head and shoulders on a small firm cushion or folded article of dress placed under the shoulder-blades.

Draw forward the patient's tongue, and keep it projecting beyond the lips; an elastic band over the tongue and under the chin will answer this purpose, or a piece of string or tape may be tied round them, or by raising the lower jaw, the teeth may be made to retain the tongue in that position. Remove all tight clothing from about the neck and chest, especially the braces.

To IMITATE THE MOVEMENTS OF BREATHING.—Standing at the patient's head, grasp the arms just above the elbows, and draw the arms gently and steadily upwards above the head, and keep them stretched upwards for two seconds. (*By this means air is drawn into the lungs.*) Then turn down the patient's arms, and press them gently and firmly for two seconds against the sides of the chest. (*By this means air is pressed out of the lungs.*)

Repeat these measures alternately, deliberately, and perseveringly, about fifteen times in a minute, until a spontaneous effort to respire is perceived, immediately upon which cease to imitate the movements of breathing, and proceed to INDUCE CIRCULATION AND WARMTH.

### IV.—TREATMENT AFTER NATURAL BREATHING HAS BEEN RESTORED.

To PROMOTE WARMTH AND CIRCULATION.—Commence rubbing the limbs upwards, with firm grasping pressure and energy, using handkerchiefs, flannels, &c. [*By this measure the blood is propelled along the veins towards the heart.*]

The friction must be continued under the blanket or over the dry clothing.

Promote the warmth of the body by the application of hot flannels, bottles, or bladders of hot water, heated bricks, &c., to the pit of the stomach, the arm-pits, between the thighs, and to the soles of the feet.

If the patient has been carried to a house after respiration has been restored, be careful to let the air play freely about the room.

On the restoration of life, a teaspoonful of warm water should be given; and then, if the power of swallowing have returned, small quantities of wine, warm brandy-and-water, or coffee should be administered. The patient should be kept in bed, and a disposition to sleep encouraged.

### GENERAL OBSERVATIONS.

The above treatment should be persevered in for some hours, as it is an erroneous opinion that persons are irrecoverable because life does not soon make its appearance, persons having been restored after persevering for many hours.

#### APPEARANCES WHICH GENERALLY ACCOMPANY DEATH.

Breathing and the heart's action cease entirely; the eyelids are generally half closed; the pupils dilated; the tongue approaches to the under edges of the lips, and these, as well as the nostrils, are covered with a frothy mucus. Coldness and pallor of surface increase.

### CAUTIONS.

Prevent unnecessary crowding of persons round the body, especially if in an apartment.

Avoid rough usage, and do not allow the body to remain on the back unless the tongue is secured.

Under no circumstances hold the body up by the feet.

On no account place the body in a warm bath unless under medical direction, and even then it should only be employed as a momentary excitant.

By order of the Committee.