

THE LIFE-BOAT,

OR

JOURNAL OF THE NATIONAL LIFE-BOAT INSTITUTION.

(ISSUED QUARTERLY.)

VOL. XI.—No. 116.]

MAY 1, 1880.

[PRICE 1s.

AT the ANNUAL GENERAL MEETING of the ROYAL NATIONAL LIFE-BOAT INSTITUTION, held at Willis's Rooms, King Street, St. James's Square, on Tuesday, the 16th day of March 1880, His Grace THE DUKE OF NORTHUMBERLAND, Lord Privy Seal, *President of the Institution*, in the Chair, the following Report of the Committee was read by the Secretary:—

ANNUAL REPORT.

THE Committee of Management of the ROYAL NATIONAL LIFE-BOAT INSTITUTION have much satisfaction in being able to report its continued prosperity, and to record the successful prosecution, during the past twelve months, of the important and onerous National duty, the direction of which has been entrusted to them.

That such should have been the case during a period of almost unprecedented pecuniary reverses and consequent great depression, is, they trust, an indication both of the general confidence which has been reposed in them, and of the firm root which the Society has taken amongst the permanent institutions of our land.

As has been hitherto their wont, they desire to express their gratitude to the Divine Disposer of Events for the blessing which has attended their labours in carrying out the sacred objects of the NATIONAL LIFE-BOAT INSTITUTION.

Their best acknowledgments are also due to all those who have given them their co-operation or pecuniary aid, and they now confidently appeal for a continuance of that support, which they feel sure will never be withdrawn, so long as the

work of the Institution is conscientiously and successfully performed.

The Committee have the satisfaction to state that Rear-Admiral H.R.H. THE DUKE OF EDINBURGH, K.G., has kindly consented, at their request, to become, in his official capacity as Admiral Superintendent of Naval Reserves, a Member of the Committee of Management, in succession to his predecessors holding the same appointment.

The transactions of the year may be summarised under the usual heads, as follows:—

Life-boats.—Since the last Annual Report twelve new Life-boats have been placed on the coast, one of them to a new Station and eleven to replace other boats.

The following are the Stations to which they have been sent:—

ENGLAND AND WALES.	
NORTHUMBERLAND	Blyth.
YORKSHIRE	Runswick.
"	Uppang.
"	Whitby.
ESSEX	Southend.
SUSSEX	Eastbourne.
ISLE OF WIGHT	Brightstone Grange.
DORSETSHIRE	Poole.
CARMARTHENSHIRE	Ferryside.
ANGLESEY	Penmon.
LANCASHIRE	Fleetwood.
IRELAND.	
LOUTH	Drogheda.

Nine of the above Life-boats have been supplied with transporting-carriages, and for two of them new boat-houses have been built.

The coasts of the United Kingdom, which extend over several thousand miles, being now nearly provided with Life-boats wherever their services would be useful and it would be practicable to work them, the Committee are able to turn their attention to the gradual replacement of old and inferior boats by those of the latest construction.

During the year 1879 the Life-boats of the Institution rescued 637 persons from wrecked or endangered vessels, nearly the whole of them under perilous circumstances, when ordinary boats could not with safety have been employed.

The Committee are thankfully able to record that those invaluable services were performed without loss of life to any of the brave men who formed the Life-boats' crews during the year 1879 or in the preceding year, notwithstanding the fact that during the two years the boats were manned on all occasions of service and quarterly exercise by about twenty-five thousand men.

Unhappily, however, as if to remind them of the honourably perilous nature of the work in which they are engaged, two fatal accidents have happened since the commencement of the present year. On the 20th of January last the Life-boat at Bacton, in Norfolk, was upset by an overwhelming hollow sea breaking on her broadside when boarding a wrecked vessel. On that occasion two of her crew unhappily perished, and of the remainder, 11 in number, 4 went round in the boat, which quickly self righted, 4 were again taken into her, and the remaining 3 were carried safely to the shore supported by their life-belts, although they wore heavy sea-boots and none of them could swim.

Again, on the 1st March the Ardrossan Life-boat, when returning to the harbour in tow of a steamer, with the crew of a wrecked ship on board, was struck by a series of heavy seas, one of which upset her.

There were 25 persons on board her at the time, viz., 13 forming her own crew and 12 rescued men, of which number 2 of the former and 2 of the latter were unfortunately drowned.

Feeling satisfied that the permanent efficiency of a large proportion of the Life-boat Establishments must greatly depend on their frequent inspection by qualified and experienced Officers, and looking to the increased magnitude of the Society's operations, the Committee have, on the recommendation of a Special Committee, increased their staff of inspectors. They have divided the coasts of the United Kingdom into five districts, have appointed one to each, and decided that instead of, as hitherto, living in London, they should each reside in their own districts, with the exception of the Inspector of the Home District, who together with the Chief Inspector will have duties to perform in London as well as on the Coast.

By this arrangement every Life-boat Station will be more frequently inspected. It will necessarily occasion an increased expenditure, but if the result should promote corresponding increased efficiency—which the Committee have reason to believe it has already done—they feel sure that the same will meet with the approval of their supporters throughout the kingdom.

Shipwrecks.—Taking into account the violence of the storms which periodically visit the coasts of the United Kingdom, and the enormous shipping interests of the country, the number of shipwrecks every year on our coasts and in our narrow seas must inevitably be very large.

Accordingly, from the last official returns the number of shipwrecks in one year on our shores amounted to four thousand four hundred and thirty-six, accompanied by the loss of eight hundred and ninety-two lives.

The services of the Life-boats of the

Institution during each month of the year were as follows:—

1879.	Number of Life-boat Launches.	Vessels Saved.	Lives Saved.
January	44	4	170
February	21	3	81
March	21	3	78
April	12	—	46
May, June, and July	22	1	35
August	14	—	47
September	16	1	60
October	10	2	6
November	27	6	58
December	19	1	56
Total	206	21	637

In addition to these Life-boat services, 218 lives were saved from shipwreck by shore-boats and other means, making a total of 855 lives preserved in 1879, for which honorary or pecuniary rewards were made by the Institution.

The Committee would venture, to draw special attention to the number of lives thus saved and reported at each successive Annual Meeting—proving the absolute necessity in a great Maritime Country like ours of a National Institution for the Preservation of Life from Shipwreck.

It is also gratifying to mention that hundreds of lives are saved every year by means of the Rocket Apparatus belonging to the BOARD OF TRADE, and worked so efficiently by the Coastguard and the Rocket Volunteer Brigades.

The number of lives saved during the fifty-six years from the establishment of the Institution, to the end of the year 1879, either by its Life-boats or by special exertions for which it has granted rewards, is 26,906, as shown in the following Table.

It is hardly necessary to dwell on the amount of happiness which the saving of nearly twenty-seven thousand lives must have conferred on the shipwrecked persons themselves and their families; but the community at large has also benefited by the services of the Life-boat Institution in contributing to preserve the lives of so many of that deserving class of men—our sailors,—whose ceaseless toil,

risks, and exposure bring constantly the riches of the world to our shores.

In the Year	No. of Lives Saved.	In the Year	No. of Lives Saved.
1824	124	1853	678
1825	218	1854	355
1826	175	1855	406
1827	163	1856	473
1828	301	1857	374
1829	463	1858	427
1830	372	1859	499
1831	287	1860	455
1832	310	1861	424
1833	449	1862	574
1834	214	1863	714
1835	364	1864	698
1836	225	1865	714
1837	272	1866	921
1838	456	1867	1,086
1839	279	1868	862
1840	353	1869	1,231
1841	128	1870	784
1842	276	1871	832
1843	236	1872	739
1844	193	1873	668
1845	235	1874	713
1846	134	1875	921
1847	157	1876	600
1848	123	1877	1,048
1849	209	1878	616
1850	470	1879	855
1851	230	Total	26,906
1852	773		

Rewards.—A summary is given in the Appendix of the cases where honorary and other rewards have been voted last year. In that period 12 Silver Medals, 13 Votes of Thanks inscribed on vellum, and 2,250*l.* were granted for saving the lives of 855 persons by Life-boats, shore and fishing boats, and by other means, on the coasts and outlying sandbanks of the United Kingdom.

The Committee continue to devote much time and consideration to the investigation and granting of these rewards; and as a rule their decisions give general satisfaction, and encourage our coast population to put forth their utmost exertions to save the lives of others—often at the peril of their own.

Since the establishment of the Institution, it has expended on Life-boat Stations, and other means for saving life from shipwreck, on the coasts of the United Kingdom, upwards of 508,000*l.*, and has voted 93 Gold Medals, 902 Silver Medals, and 60,200*l.* in pecuniary rewards for saving life from shipwreck.

Local Committees.—The Committee again tender their best acknowledgments for the valuable and earnest co-operation afforded them by the Local Branch Committees and their Honorary Secretaries, which constitute so important a part of the work and supervision of the Institution's numerous Life-boat Establishments, and the collection of funds for their support. The Book of *Instructions*, which the Institution has recently issued, on the *Management of a Life-boat Station*, cannot fail to prompt afresh the assiduity and co-operation of the Local Committees and the Life-boat Crews.

Finances.—The donations, subscriptions, and dividends during the year 1879 have been 30,125*l.* 7*s.* 5*d.*, of which sum 5,081*l.* 15*s.* 7*d.* were special gifts to defray the cost of the following eleven Life-boats:—

	£.	s.	d.
Ardmore—Miss A. M. Hooper	500	0	0
Ballycotton—"Oliver Goldsmith" Life-boat Fund	321	12	3
Brightstone Grange—Worcester Cadet Life-boat Fund (in addition to 485 <i>l.</i> 17 <i>s.</i> 9 <i>d.</i> in 1876-8)	88	3	4
Buddon Ness—"D"	850	0	0
Fowey—"Arthur Hill" Testimonial Fund	472	0	0
Giles' Quay and Greencastle—The Misses Brooke, per John Richard- son, Esq., Q.C.	300	0	0
Kingstown—Mrs. Goff	400	0	0
Runswick—Mrs. Fuller	750	0	0
Southend—"Boys of England" Life- boat Fund	300	0	0
—Miss Maria Onslow	600	0	0
—The late Crosby Leonard, Esq.	500	0	0

The Committee take this opportunity to express again their best thanks to CHRISTOPHER BROWN, Esq., of Settle, Yorkshire, for his most valuable and assiduous co-operation since 1862, in contributing and collecting from his friends and others no less than 3,600*l.*—for the establishment of two Life-boats and their endowment, and in aid of the general objects of the Institution.

Also to CHARLES DIBDIN, Esq., F.R.G.S., in acknowledgment of his ceaseless exertions in collecting, in conjunction with the

Committee of the "Civil Service Life-boat" Fund, from 3,842 gentlemen in the various Government Departments 1,150*l.*, being 1,000*l.* for the permanent endowment of the "Civil Service No. 1" Life-boat, and 150*l.* for the general support of their three Life-boats.

The Committee have likewise the gratification to acknowledge the receipt, since the last Report, of the following other special contributions:—

	£.	s.	d.
HER MAJESTY THE QUEEN (annual subscription)	50	0	0
Allen, Capt. Thomas Acland, the late, of the barque <i>Star of Devon</i> , per G. C. Allen, Esq.	5	0	0
Christ's Hospital, Boys of, per Rev. Richard Lee, M.A., additional	4	4	0
Demerara, collected in annual sub- scriptions, per A. Reid, Esq.	11	11	0
Ely, the Marquis of, annual sub- scription	20	0	0
Foresters, Ancient Order of, annual subscription in aid of the support of their two Life-boats, the <i>Forester</i> , at Tynemouth, and the <i>Foresters'</i> <i>Pride</i> , at West Hartlepool	100	0	0
Harvey, Mrs. A., of Bridlington Quay, Rev. G. M. Gorham and Rev. J. Holmes, Executors of the late	20	0	0
Licensed Victuallers' School, Miss English and Officers and Children, in aid of support of the <i>Licensed Victualler</i> Life-boat, additional	4	4	0
"M. L. C., of South Australia, in grateful remembrance of merciful preservation from imminent peril at sea in 1862," additional	20	0	0
Odd Fellows, Independent Order of (Manchester Unity), in aid of the support of their Life-boat at Clec- thorpes, annual subscription	50	0	0
Readers of <i>The Christian</i> , per Messrs. Morgan and Scott, additional	13	0	0
St. Paul's, Clerkenwell, collected after the children's flower sermon on Whit Sunday afternoon, per Rev. A. S. Herring	1	7	6
Underwriters of the cargo by the Austrian barque <i>Andrina V.</i>	26	5	0
<i>Victoria</i> steamer, owners of the, per Henry Page, Esq., Dulwich	5	5	0
Welsh National Eisteddfod, Birken- head, per Mr. E. Jones	50	0	0

LEGACIES IN 1879-80.

	£.	s.	d.
Adolphe, Mrs. Margaret, Dublin	42	14	2
Allan, Robert, Esq., Glenhouse, N.B.	500	0	0
Bagley, William, Esq., Leicester	200	0	0
Beckett, James, Esq., Dublin	10	0	0
Boit, Robt., Esq., Poulton, Gloucester	100	0	0

	£.	s.	d.
Bond, Charles, Esq., Potton, Bedford	19	19	0
Bradberry, Thos., Esq., Finsbury Park	500	0	0
Broadhurst, Hon. Mrs., Richmond	300	0	0
Brookes, J. M., Esq., M.D., Marlborough Road, St. John's Wood	100	0	0
Cathre, Mrs. A. M., Maida Hill	200	0	0
Crosse, Robert, Esq., Southsea	10	10	0
Edmunds, Admiral Charles, Worthing	19	19	0
Evans, Mrs. Louisa, Chesham Street	19	19	0
Firbank, Mrs. Anne, Charlton (Stock)	943	12	10
Fletcher, George Hamilton, Esq., Carshalton	500	0	0
Foley, Miss Mary, Bramley Road, Notting Hill	233	1	6
Gooch, James, Esq., Ipswich	100	0	0
Graham, James, Esq., Cornwall Terrace, Regent's Park	500	0	0
Harcourt, Mrs. Danby Vernon, Swinton, Yorkshire	500	0	0
Holme Sumner, Mrs. H. K., Swaffham	100	0	0
Hope, Mrs. Ellen, Upper Seymour Street, W.	300	0	0
Hunt, Mrs. Maria, Hornsey	500	0	0
Kirkpatrick, Mrs. Harriet, Sutton	100	0	0
Landseer, Charles, Esq., R.A., St. John's Wood	500	0	0
Peck, Mrs. A. E., Plymouth	250	0	0
Price, Dr. Allin Ford, Deptford	100	0	0
Pycock, Miss Jane, Howden, York	50	0	0
Somerville, Miss M. C., Florence	2500	0	0
Travis, Miss Anne, Moston, Lancaster	10	0	0
Vandeleur, Richard, Esq., Baden-Baden	500	0	0
Webb, Miss Ann, Prestonville, Brighton	50	0	0
White, Mrs. Ann, Brockley	90	5	0
Woodward, Miss Sarah, Oldham Place, Farringdon Road	2000	0	0

There were expended during the past year 9,388*l.* 2*s.* 11*d.* on additional Life-boats, Transporting-carriages, Boat-houses, and necessary gear; 14,156*l.* 9*s.* 8*d.* in repairs, painting, refitting, and sundry

charges on Life-boat Establishments, and on the Store-yard at Poplar; and 7,856*l.* 7*s.* 6*d.* in rewards for services to shipwrecked crews, coxswains' salaries, and quarterly practice of the Life-boats' crews; making altogether—including liabilities on Life-boat Houses now in course of construction, and other expenses—a total of 36,546*l.* 3*s.* 6*d.* against receipts amounting to 30,125*l.* 7*s.* 5*d.*

The items of receipt and expenditure are fully detailed in the financial statement, which has been audited as usual by Mr. LOVELOCK, public accountant.

For more than thirty years the Committee have had the satisfaction, year after year, to report that the sphere of operations of the Institution was extending, and that, in proportion to that extension, the support of the Public had liberally corresponded.

They are fortunately in the position to renew that statement this year; and while the Committee and their Officers feel it to be a privilege to be associated with an Institution whose beneficent labours are so generously recognised and appreciated, not only in the United Kingdom but all over the world, they appeal with renewed assurance and confidence to their fellow-countrymen at large to help them, not only to maintain the great Life-saving Fleet which the toil and anxiety of many years have produced, but also to assist them to perpetuate the great work, and to extend it as opportunities are presented.

RESOLUTIONS PASSED AT THE ANNUAL MEETING FOR 1880.

HIS GRACE THE DUKE OF NORTHUMBERLAND, LORD PRIVY SEAL, PRESIDENT OF THE INSTITUTION,
IN THE CHAIR.

1.—Moved by the CHAIRMAN:—

1.—That the following Noblemen and Gentlemen be the Officers of the Institution for the current year:—(*Vide* next page for this list.)

2.—Moved by the Right Hon. the EARL of GALLOWAY.

Seconded by Captain the Hon. F. MAUDE, R.N.

2.—That the Report now read be adopted, printed, and circulated.

3.—Moved by GEORGE LYALL, Esq., *V.P.*, late Governor of the Bank of England.

Seconded by Captain F. J. O. EVANS, R.N., C.B., *F.R.S.*, Hydrographer to the Admiralty.

3.—That this Meeting—recognising fully the great success which continues to mark the progress of the NATIONAL LIFE-BOAT INSTITUTION as shown in its Report, and appreciating the admirable manner in which its affairs are conducted—is desirous to testify, on this annual occasion, to the great and National character of the services performed by the Institution, and to urge again its claims on the sympathy and support of the British Public.

4.—Moved by JOHN LIDDON, Esq., Barrister-at-Law, Ecclesiastical Commissioners' Department, Whitehall.

Seconded by Captain MAITLAND, R.N.

4.—That this Meeting tenders its best acknowledgments to THOMAS CHAPMAN, Esq., *F.R.S.*, *V.P.*, Chairman; to the Committee of Management, and to the Officers of the Institution, for their able and assiduous services.

Also to the Honorary Local Committees and Secretaries of the several Branches of the Institution, for their continued earnest and active co-operation.

5.—Moved by ROBERT BIRKBECK, Esq., Banker, Norwich.

Seconded by Admiral J. B. B. MCHARDY, Chief Constable of Essex.

5.—That this Meeting acknowledges the brave spirit which continues to be displayed by the Coxswains and Crews of the Life-boats, whose undaunted exertions during the stormiest weather are deserving of every encouragement and praise.

6.—Moved by THOMAS CHAPMAN, Esq., *F.R.S.*, *V.P.*, *Chairman*.

Seconded by Sir EDWARD G. L. PERROTT, Bart., *V.P.*

6.—That the best thanks of this Meeting be given to his Grace the DUKE OF NORTHUMBERLAND, Lord Privy Seal, for so ably presiding over the fifty-sixth Annual Meeting of the ROYAL NATIONAL LIFE-BOAT INSTITUTION, and for the continued kind interest he takes in its welfare.

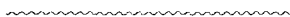

ROYAL NATIONAL LIFE-BOAT INSTITUTION.

For the Preservation of Life from Shipwreck.

(Incorporated by Royal Charter.)

FOUNDED IN 1824.—SUPPORTED SOLELY BY VOLUNTARY CONTRIBUTIONS.

PATRONESS.

Her Most Gracious Majesty the Queen.

VICE-PATRON.

HIS ROYAL HIGHNESS THE PRINCE OF WALES, K.G.

PRESIDENT.

HIS GRACE THE DUKE OF NORTHUMBERLAND, Lord Privy Seal.

VICE-PRESIDENTS.

HIS GRACE THE ARCHBISHOP OF CANTERBURY, F.R.S.
HIS GRACE THE DUKE OF ARGYLL, K.T., F.R.S.
The Most Noble the MARQUIS OF CHOLMONDELEY.
The Right Hon. the EARL OF LEICESTER, K.G.
The Right Hon. LORD HATHERLEY, F.R.S., Late Lord Chancellor of England.
The Right Hon. LORD ROBERTS.
The Right Hon. SIR STEPHEN CAVE, G.C.B.
Admiral SIR GEORGE BROKE-MIDDLETON, Bart., C.B.
Sir EDWARD G. L. FERROTT, Bart.

THOMAS CHAPMAN, Esq., F.R.S., Chairman of Lloyd's Register.
EDWARD BIRKBECK, Esq., M.P.
Colonel TALBOT CLIFTON.
Capt. NICHOLAS DE STE. CROIX, H.C.S.
W. H. HARTON, Esq.
GEORGE LYALL, Esq., late Governor of the Bank of England.
T. B. POTTER, Esq., M.P.
ROBERT WHITWORTH, Esq.

COMMITTEE OF MANAGEMENT.

THOMAS CHAPMAN, Esq., F.R.S., V.P., Chairman.
GEORGE LYALL, Esq., V.P., Deputy Chairman.

Rear-Admiral H.R.H. THE DUKE OF EDINBURGH, K.G.,
Admiral Superintendent of Naval Reserves.
The MARQUIS OF CHOLMONDELEY, V.P.
The Right Hon. SIR STEPHEN CAVE, G.C.B., V.P.
L. T. CAVE, Esq., F.R.G.S.
Sir WILLIAM B. CLAYTON, Bart.
Colonel FITZ-ROY CLAYTON.
Admiral SIR RICHARD COLLINSON, K.C.B., Deputy Master of the Trinity House.
Colonel the Hon. G. F. CRICHTON.
Capt. NICHOLAS DE STE. CROIX, H.C.S., V.P. [Admiralty.
Capt. F. J. O. EVANS, R.N., C.B., F.R.S., Hydrographer to the
The Right Hon. G. J. GÖSCHEN, M.P.
JOHN GRIFFITH, Esq.
WILLIAM H. HARTON, Esq., V.P.
The Right Hon. JOHN GELIBRAND HUBBARD, M.P.
Admiral J. B. B. MCHARDY.

EUGENE F. NOEL, Esq.
Sir FRANCIS BOYD OUTRAM, Bart.
Lord ALFRED H. PAGET.
Colonel GEORGE PALMER.
GEORGE PALMER, Esq.
The EARL PERCY, M.P.
Sir EDWARD G. L. FERROTT, Bart., V.P.
Vice-Admiral AUGUSTUS PHILLIMORE.
The Hon. T. C. AGAR-ROBARTS, M.P.
Admiral A. P. RYDER, Commander-in-Chief at Portsmouth.
Admiral of the Fleet Sir GEORGE R. SARTORIUS, K.C.B.
Admiral Sir J. WALTER FARLETON, K.C.B.
Major-General TULLOH, R.A., C.B.
The Right Hon. the EARL WALDEGRAVE.
Vice-Admiral J. R. WARD.
T. M. WEGUELIN, Esq.

TRUSTEES.

THOMAS CHAPMAN, Esq., F.R.S., V.P. GEORGE LYALL, Esq., V.P. The Right Hon. Sir STEPHEN CAVE, G.C.B., V.P.

BANKERS—Messrs. COURTIS and Co., 59 Strand.

TREASURER—HUGH LINDSAY ANTROBUS, Esq.

SECRETARY—RICHARD LEWIS, of the Inner Temple, Esq., Barrister-at-Law.

CHIEF LIFE-BOAT INSPECTOR—Vice-Admiral J. R. WARD.

DISTRICT LIFE-BOAT INSPECTORS.

Captain the Hon H. W. CHREWYND, R.N.—London.
Commander ST. VINCENT NEPEAN, R.N.—Hull.

Commander G. L. PRIMAUDADE, R.N.—Bristol.
Lieutenant H. A. MONTEITH, R.N.—Edinburgh.
Lieutenant H. T. G. TIPPING, R.N.—Dublin.

HON. ARCHITECT—C. H. COOKE, Esq., F.S.A.

HON. SOLICITORS—Messrs. CLAYTON, Sons, and FARGUS.

AUDITOR—SAMUEL LOVELOCK, Esq., Public Accountant, F.I.A.L.

The object of this Institution, as declared in its title, and in its Charter of Incorporation, is to afford assistance to every shipwrecked person around the Coasts of the United Kingdom.

The chief means by which the Society hopes to carry this object into effect are:—

To build, station, and maintain in repair, Life-boats of the most perfect description; to furnish them with all necessary Appurtenances, including Houses to preserve them in, and Carriages for their conveyance to the spots where their Services are called for; and further, to provide, through the instrumentality of Local Committees, for their proper Management and the occasional Exercise of their Crews.

To confer Honorary Rewards in the form of Medals and Votes of Thanks, and also to make liberal grants of money to all persons who, at the risk of their own lives, save, or attempt to save, those of others on board vessels wrecked, or in distress, upon any part of the Coasts of the United Kingdom.

As an index of the necessity for the provision of such a machinery as the above, it may be stated that the average loss of lives from shipwreck annually on the shores of the United Kingdom is 700.

Dr.

INCOME AND EXPENDITURE.—1st Jan. to 31st Dec. 1879.

Cr.

To LIFE-BOATS, viz. :—	£.	s.	d.	£.	s.	d.
Ardmore	363	0	0			
Ballycotton	328	18	0			
Blyth.	275	0	0			
Brighstone Grange	363	0	0			
Carmarthen Bay	282	0	0			
Eastbourne	363	0	0			
Giles' Quay	363	0	0			
Penmon (Anglesey)	363	0	0			
Poole	363	0	0			
Runswick (Yorkshire)	363	0	0			
Southend	352	18	5			
Tramore (Waterford).	363	0	0			
Uppang (Yorkshire)	282	0	0			
Spare Life-boat	430	0	0			
Alterations and repairs of Life-boats, and Sundry Expenses on the 269 Life-boat Stations	7,700	13	3			
Salaries to Inspectors of Life-boats	2,160	8	4			
Travelling Expenses, &c., of ditto	964	0	1			
Gratuity to Admiral Robertson Macdonald, on his retirement	1,000	0	0			
				16,679	18	1

To LIFE-BOAT HOUSES and SLIPWAYS, viz. :—

Clacton-on-Sea (balance)	114	2	6			
Dartmouth (balance)	61	0	0			
Dover	408	0	0			
Eastbourne	115	5	4			
Hornsea (balance)	86	0	0			
Porthcawl (balance)	55	4	0			
Whitburn	120	0	0			
Painting Life-boat Houses, Repairs, &c.	1,676	15	11			
				2,636	7	9

To LIFE-BOAT CARRIAGES, viz. :—

Ardmore	112	10	0			
Blyth, No. 2	130	15	0			
Brighstone Grange	129	15	0			
Eastbourne	212	11	11			
Giles' Quay	137	10	0			
Poole	110	10	0			
Runswick	141	0	0			
Tramore	129	15	0			
Uppang	129	0	0			
Alterations and Repairs of Life-boat Carriages, &c.	330	5	0			
				1,563	11	11

Carried forward . £20,879 17 9

	£.	s.	d.	£.	s.	d.
By Donations.	8,015	17	7			
By Subscriptions	3,419	16	6			
				11,435	14	1
By Special Gifts, amounting to £5,081 15s. 7d., for the following Life-boats :—						
Ardmore—Miss A. M. Hooper	500	0	0			
Ballycotton—"Oliver Goldsmith" Life-boat Fund	321	12	3			
Brighstone Grange—Worcester Cadet Life-boat Fund (in addition to £485 17s. 9d. in 1876-8)	88	3	4			
Buddon Ness—"D"	850	0	0			
Fowey—"Arthur Hill" Testimonial Fund	472	0	0			
Giles' Quay and Greencastle—The Misses Brooke, per John Richardson, Esq., Q.C.	300	0	0			
Kingstown—Mrs. Goff	400	0	0			
Runswick—Mrs. Fuller	750	0	0			
Southend—"Boys of England" Life-boat Fund	300	0	0			
Miss Maria Onslow	600	0	0			
The late Crosby Leonard, Esq.	500	0	0			
By Contributions from Branches	5,449	19	8			
By Dividends and Interest	8,157	18	1			

Carried forward £30,125 7 5

Dr. INCOME AND EXPENDITURE.—1st Jan. to 31st Dec. 1879—continued. Cr

	£.	s.	d.
Brought forward	£20,879	17	9
To Rewards, Medals, &c., for saving Life, Coxswains' Salaries, and Life-boat Crews for exercising the Boats quarterly . . .	7,856	7	6
Life-boat Stores and Life-belts	2,340	7	9
Life-boat Store Yard and Depôt at Poplar . . .	324	7	1
Printing, <i>Life-boat Journal</i> , Annual Report, Stationery, Books, &c.	243	5	10
Advertisements, Postages, and Parcels . . .	336	12	11
Salaries to Secretary and Clerks	1,752	2	4
Auditor's Fee	31	10	0
Law Expenses on Leases and Bequests . . .	80	9	0
Repairs and Alterations at the House of the Institution	262	10	0
Rent, Taxes, Housekeeper, Fuel, &c.	239	6	5
Annual Meeting, Messengers, &c.	63	17	11
Total Expenditure	34,410	14	6
	<hr/>		
	£34,410	14	6
	<hr/>		

	£.	s.	d.
Brought forward	£30,125	7	5
Total Income	30,125	7	5
	<hr/>		
By Balance, being excess of Expenditure over Income	4,285	7	1
	<hr/>		
	£34,410	14	6
	<hr/>		

Examined and found correct, 7th January 1880.

(Signed) SAMUEL LOVELOCK,
Auditor.



No.	STATION.	Length.	Breadth.	No. of Oars.	When Stationed or Named.
ENGLAND.					
1	NORTHUMBERLAND BERWICK-ON-TWEED - - -	Ft. in. 33 0	Ft. in. 8 0	10	1864
2	HOLY ISLAND—No. 1 - - -	32 0	7 4	10	1865
3	" " No. 2 - - -	32 0	7 4	10	1868
4	NORTH SUNDERLAND - - -	33 0	8 0	10	1865
5	BOULMER - - -	33 0	8 0	10	1866
6	ALNMOUTH - - -	32 0	7 5	10	1865
7	HAUXLEY - - -	34 0	8 4	10	1866
8	CRESSWELL - - -	30 0	8 0	8	1875
9	NEWBIGGIN - - -	34 0	8 4	10	1866
10	BLYTH—No. 1 - - -	33 0	8 0	10	1867
11	" " No. 2 - - -	30 0	8 0	8	1880
12	CULLERCOATS - - -	33 0	8 0	10	1866
13	TYNEMOUTH—No. 1 - - -	37 0	9 0	12	1875
14	" " No. 2 - - -	33 0	8 1	10	1872
15	DURHAM - - - WHITBURN - - -	32 0	7 5	10	1865
16	SUNDERLAND—No. 1 - - -	30 0	8 0	8	1876
17	" " No. 2 - - -	30 3	8 7	10	1866
18	" " No. 3 - - -	33 0	8 2	10	1865
19	" " No. 4 - - -	36 0	9 0	12	1872
20	SEAHAM - - -	33 0	8 6	10	1870
21	HARTLEPOOL—No. 1 - - -	33 0	8 6	10	1876
22	" " No. 2 - - -	35 0	9 0	10	1876
23	" " No. 3 - - -	33 0	8 6	10	1878
24	WEST HARTLEPOOL—No. 1 - - -	33 0	8 6	10	1869
25	" " No. 2 - - -	34 0	8 9	10	1874
26	SEATON CAREW - - -	33 0	8 6	10	1873
27	YORKSHIRE - - - MIDDLESBOROUGH - - -	33 0	8 0	10	1864
28	REDCAR - - -	36 0	9 6	10	1867
29	SALTBURN - - -	30 0	10 0	10	1878
30	STAITHES - - -	32 0	8 0	10	1875
31	RUNSWICK - - -	34 0	8 0	10	1880
32	UPGANG - - -	32 0	7 6	10	1879
33	WHITBY—No. 1 - - -	32 0	7 7	10	1870
34	" " No. 2 - - -	32 0	7 6	8	1879
35	SCARBOROUGH - - -	35 0	9 0	10	1872
36	FILEY - - -	33 0	8 0	10	1863
37	FLAMBOROUGH—No. 1 - - -	33 0	8 6	10	1871
38	" " No. 2 - - -	33 0	8 0	10	1879
39	BRIDLINGTON - - -	34 0	7 7	10	1871
40	HORNSEA - - -	32 0	7 6	10	1875
41	WITHERNSEA - - -	30 0	8 0	8	1878
42	LINCOLNSHIRE - - - CLEETHORPES - - -	33 0	8 6	10	1868
43	DONNA NOOK - - -	34 0	8 0	10	1878
44	THEDDLETHORPE - - -	30 0	8 11	12	1871
45	SUTTON - - -	30 0	8 0	8	1876
46	CHAPEL - - -	30 0	8 0	8	1876
47	SKEGNESS - - -	33 0	8 0	10	1874
48	NORFOLK - - - HUNSTANTON - - -	32 0	7 6	10	1867
49	BRANCASTER - - -	33 0	8 0	10	1879
50	WELLS - - -	33 0	8 6	10	1869
51	BLAKENEY - - -	37 0	9 5	12	1873
52	SHERINGHAM - - -	36 0	9 0	12	1867
53	CROMER - - -	34 0	8 8	10	1868
54	MUNDESLEY - - -	33 0	8 3	10	1866
55	BACTON - - -	33 0	8 1	10	1865
56	HASBOROUGH - - -	32 0	7 6	10	1866
57	PALLING—No. 1 - - -	36 0	8 0	12	1864
58	" " No. 2 - - -	40 0	11 6	14	1870
59	WINTERTON—No. 1 - - -	32 0	10 0	12	1878
60	" " No. 2 - - -	36 0	10 6	14	1879
61	CAISTER—No. 1 - - -	42 0	11 6	14	1878
62	" " No. 2 - - -	33 7	10 0	12	1875

No.	NAME OF BOAT AND DONOR.	NAME AND ADDRESS OF HONORARY SECRETARY.
1	<i>Albert Victor</i> —Manchester Branch	B. G. Sinclair, Esq., Berwick-on-Tweed.
2	<i>Grace Darling</i> —The late Lady Watson	} Rev. W. W. F. Keeling, <i>Holy Island, Beal, R.S.O.</i> Capt. A. Marshall, N. Sunderland, Chathill. Rev. L. J. Stephens, <i>M.A. Long Houghton Vicarage,</i> Lesbury, R.S.O. H. Smith, Esq., Alnmouth,, R.S.O., Northumberland. Rev. A. O. Medd, Amble, Acklington.
3	<i>Bombay</i> —The late Mr. J. G., and Mrs. Frith	
4	<i>Joseph Anstice</i> —The late Mrs. Anstice	
5	<i>Robin Hood of Nottingham</i> —Nottingham	
6	<i>John Atkinson</i> —Miss Wardell	
7	<i>Algernon & Eleanor</i> —Her Grace the Dowager Duchess of Northumberland	Mr. John Robson, Cresswell, Morpeth. Rev. Edward Shortt, M.A., Woodhorn Vicarage, Morpeth.
8	<i>Old Potter</i> —Thos. Hackwood, Esq.	} Mr. James Darling, Blyth, Northumberland.
9	<i>W. Hopkinson, of Brighouse</i> —The late Miss Hopkinson	
10	<i>Safford</i> —Manchester Branch	} Major Adamson, Cullercoats, Newcastle-on-Tyne.
11	<i>Tom and Marion</i> —Mr. & Mrs. T. Jones Gibb	
12	<i>Palmerston</i> —Peter Reid, Esq.	} P. J. Messent, Esq., C.E., Tynemouth, North Shields.
13	<i>Charles Dibdin</i> —Civil Service No. 2 Fund	
14	<i>Forester</i> —A. O. of Foresters	} William Milburn, Esq., 5, Nile Street, Sunderland.
15	<i>Thomas Wilson</i> —R. N. L. B. Institution	
16	<i>Good Templar</i> —That Life-boat Fund	
17	<i>Royal National Life-boat Institution</i>	
18	<i>Florence Nightingale</i> —Town of Derby	
19	<i>John Foulston</i> —The late Mrs. Foulston	[R.S.O.]
20	<i>Sisters Carter, of Harrogate</i> —Misses Carter	} William Warham, Esq., Londonderry Offices, Seaham,
21	<i>Charles Mather</i> —Mrs. Annie Mather	
22	<i>Charles Ingleby</i> —Trust Fund, per G. P. Wragge, Esq.	S. Herbert Belk, Esq., Hartlepool.
23	<i>John Clay Barlow</i> —Miss Barlow	} C. A. Baker, Esq., North Eastern Railway, West Hartlepool.
24	<i>Rochdale</i> —Collected in Rochdale	
25	<i>Foresters' Pride</i> —A. O. of Foresters	
26	<i>Job Hindley</i> —The late Mr. Hindley, per Manchester Branch	Rev. John Lawson, M.A., Seaton Carew, West Hartlepool.
27	<i>Crossley</i> —Messrs. J. Crossley and Sons	M. Murray, Esq., Exchange Place, Middlesborough.
28	<i>Burton-on-Trent</i> —Town of Burton-on-Trent	Mr. J. V. Browning, Chief Officer of Coastguard, Redcar.
29	<i>Thomas and Isabella Firbank, Kingston- upon-Hull</i> —Mr. & Mrs. Firbank's Legacies	Mr. T. G. Pearson, Saltburn-by-the-Sea.
30	<i>Hannah Somerset</i> —Mrs. Yates' Legacy	} Dr. J. V. Laverick, Hinderwell, Saltburn-by-the-Sea.
31	<i>Margaret and Edward</i> —A Lady	
32	<i>Joseph Sykes</i> —Mrs. A. E. Sykes' Legacy	} E. W. Chapman, Esq., Whitby.
33	<i>Robert Whitworth</i> —Manchester Branch	
34	<i>Harriott Forteach</i> —Late Mrs. Forteach	} Mr. Robert Gibson, Harbour Master, Whitby.
35	<i>Lady Leigh</i> —Warwickshire Freemasons	} John Stephenson, Esq., Scarborough.
36	<i>Hollon</i> —Mr. and Mrs. Hollon	} A. E. Hick, Esq., St. Thomas Street, Scarborough.
37	<i>Gertrude</i> —Legacy of John Beckett, Esq.	} W. Hanks, Esq., <i>Filey, R.S.O., Yorkshire.</i>
38	<i>Grace and Lally of Broad Oak</i> —Late J. Hargreaves, Esq.	} Rev. J. F. Wilkinson, M.A., Flamborough, Hull.
39	<i>John Abbott</i> —Mr. Abbott's Legacy	
40	<i>Ellen and Margaret of Settle</i> —Settle Fund	Alfred West, Esq., Garrison St., Bridlington Quay.
41	<i>Admiral Rous</i> —That Life-boat Fund	D. A. Walter, Esq., Hornsea, near Hull. Horatio H. Ayre, Esq., Withernsea, near Hull.
42	<i>Manchester Unity</i> —I. O. of Odd Fels. (M. U.)	F. Dawson, Esq., Victoria Chambers, Grimsby.
43	<i>Richard</i> —Miss Dixon	Mr. Gilbert Houlden, North Somercotes, Grimsby.
44	<i>Dorinda & Barbara</i> —Mrs. B. Caslake	Rev. L. D. Kennedy, <i>M.A., Theddlethorpe, Louth.</i>
45	<i>Caroline</i> —N. R.	Lieut. E. J. V. Pritchard, R.N., Coastg., Mablethorpe, R. Bradshaw, Esq., Hogsthorpe, Alford. [Alford.]
46	<i>Land-seer</i> —Miss Landseer	William Everington, Esq. } Skegness, R.S.O.,
47	<i>Herbert Ingram</i> —Mr. Ingram's Friends	} Mr. P. Donovan, Ch. Officer, C. G., Lincolnshire.
48	<i>Licensed Victualler</i> —Licensed Victuallers	Rev. A. Waller, M.A., Hunstanton, Norfolk. [Lynn.]
49	<i>Lily Bird</i> —Samuel Bird, Esq.	Rev. E. K. Kerslake, M.A., Deepdale Rectory, King's E. Dewing, Esq., Burnham Overy, King's Lynn.
50	<i>Eliza Adams</i> —Penny Readings' Fund	Mr. F. B. Southgate, Post Office, Wells, Norfolk.
51	<i>Hettie</i> —A Friend at Bradford	Rev. R. H. Tillard, M.A., Blakeney, Dereham.
52	<i>Duncan</i> —Mrs. Fraser	Rev. Lethbridge Moore, Sheringham, Cromer.
53	<i>Benjamin Bond Cubbell</i>	W. G. Sandford, Esq., Cromer.
54	<i>Grocers</i> —Grocers of England	Mr. G. Gordon, Mundesley, North Walsham, Norfolk.
55	<i>Recompense</i> —A Lady, per T. J. Gibb, Esq.	Mr. Wm. Cubitt, Bacton, North Walsham, Norfolk.
56	<i>Huddersfield</i> —Huddersfield	Rev. J. Slater, M.A., Hasbrough, Norwich.
57	<i>Parsee</i> —Messrs. Cama and Co.	} Mr. E. French, Chief Officer C. G., Palling, Norwich.
58	<i>British Workman</i> —That Magazine	
59	<i>Edward Birkbeck</i> —R. N. L. B. Institution	} Rev. Wm. Green, M.A., Winterton, Great Yarmouth.
60	<i>Husband</i> —Late Mrs. Davis	
61	<i>Covent Garden</i> —That Life-Boat Fund	} Rev. E. G. H. Murrell, Caister, Great Yarmouth.
62	<i>Godsend</i> —Lady Bouchier	

STATEMENT OF THE SEVERAL LIFE-BOATS BELONGING TO OR IN CONNECTION

No.	STATION.	Length.		Breadth.		No. of Oars.	When Stationed or Named.
		Ft.	in.	Ft.	in.		
63	NORFOLK - - - YARMOUTH—No. 1	42	3	11	9	12	1861
64	" " " " No. 2	28	0	9	0	10	1859
65	SUFFOLK - - - GORLESTON	30	0	10	0	10	1870
66	" " " " LOWESTOFT—No. 1	44	0	12	3	14	1876
67	" " " " " No. 2	32	0	10	0	12	1870
68	" " " " PAKEFIELD—No. 1	46	3	12	0	14	1872
69	" " " " " No. 2	30	0	9	0	12	1871
70	" " " " KESSINGLAND—No. 1	42	0	12	0	14	1870
71	" " " " " No. 2	32	0	10	0	12	1879
72	" " " " SOUTHWOLD—No. 1	40	0	11	6	12	1855
73	" " " " " No. 2	33	0	8	0	10	1866
74	" " " " DUNWICH	30	0	7	8	8	1873
75	" " " " THORPENESS	37	0	9	4	12	1873
76	" " " " ALDBOROUGH	40	0	10	5	12	1870
77	ESSEX - - - HARWICH	35	0	9	0	10	1876
78	" " " " CLACTON-ON-SEA	34	0	8	3	10	1878
79	" " " " SOUTHEND	25	0	7	3	8	1879
80	KENT - - - MARGATE	34	0	8	3	10	1866
81	" " " " KINGSGATE	28	0	6	0	5	1870
82	" " " " BROADSTAIRS	36	0	9	2	12	1868
83	" " " " RAMSGATE	44	0	11	1	12	1877
84	" " " " NORTH DEAL	40	0	10	0	12	1865
85	" " " " WALMER	36	0	9	4	12	1871
86	" " " " KINGSDOWNE	36	0	9	0	12	1871
87	" " " " DOVER	35	0	9	0	10	1878
88	" " " " HYTHE	35	0	9	0	10	1876
89	" " " " NEW ROMNEY	32	0	7	6	10	1871
90	" " " " LYDD, DUNGENESS	33	0	7	9	10	1874
91	SUSSEX - - - RYE	32	0	7	7	10	1866
92	" " " " WINCHELSEA	33	0	8	2	10	1867
93	" " " " HASTINGS	36	4	8	2	12	1863
94	" " " " EASTBOURNE	34	0	8	3	10	1880
95	" " " " NEWHAVEN	37	0	8	2	12	1877
96	" " " " BRIGHTON	32	0	7	8	10	1874
97	" " " " SHOREHAM	33	0	8	1	10	1865
98	" " " " WORTHING	32	0	7	6	10	1866
99	" " " " SELSEY	32	0	7	6	10	1865
100	" " " " CHICHESTER HARBOUR	32	0	7	5	10	1873
101	HAMPSHIRE - - HAYLING ISLAND	32	0	7	5	10	1865
102	ISLE OF WIGHT - BEMBRIDGE	32	0	7	7	10	1867
103	" " " " BRIGHSTONE GRANGE	34	0	8	0	10	1880
104	" " " " BROOKE	32	0	7	6	10	1867
105	ALDERNEY - - - ST. ANNE	33	0	8	6	10	1869
106	GUERNSEY - - - LA LANDE	32	0	7	8	10	1875
107	DORSET - - - POOLE	34	0	8	3	10	1880
108	" " " " SWANAGE	35	0	9	0	10	1875
109	" " " " CHAPMAN'S POOL	30	0	7	1	10	1866
110	" " " " KIMERIDGE	28	0	6	3	5	1868
111	" " " " WEYMOUTH	33	0	8	6	10	1869
112	" " " " LYME REGIS	33	0	8	0	10	1866
113	SOUTH DEVON - - SIDMOUTH	33	0	8	6	10	1869
114	" " " " EXMOUTH	32	0	7	6	10	1867
115	" " " " TEIGNMOUTH	32	0	7	4	10	1864
116	" " " " TORQUAY	33	0	8	6	10	1876
117	" " " " BRIXHAM	34	0	8	6	10	1866
118	" " " " DARTMOUTH	33	0	8	6	10	1878
119	" " " " SALCOMBE	33	0	8	6	10	1869
120	" " " " HOPE COVE	35	0	9	0	10	1878
121	" " " " YEALM RIVER	35	0	9	0	10	1878
122	" " " " PLYMOUTH	34	0	7	9	10	1873

No.	NAME OF BOAT AND DONOR.	NAME AND ADDRESS OF HONORARY SECRETARY.
63	<i>Mark Lane</i> —London Corn Exchange . . .	Mr. J. Petts, 22, Queen's Road, Great Yarmouth.
64	<i>Abraham Thomas</i> —M. B.	
65	<i>Leicester</i> —Town of Leicester.	J. P. Baumgartner, Esq., Gorleston, Great Yarmouth.
66	<i>Samuel Plimsoll</i> —Plimsoll Life-boat Funds	Frederick Morse, Esq., Lowestoft.
67	<i>George</i> —Miss Leicester	
68	<i>The Two Sisters, Mary and Hannah</i> —The late Mr. Thomas Parkin.	Mr. J. Henderson, Lowestoft.
69	<i>Henry Burford, R.N.</i> —Legacy of J. L.	W. F. Larkins, Esq., Holm View, near Lowestoft.
70	<i>Bolton</i> —Town of Bolton [Fund	Mr. C. Rashley, Chief Officer of C. G ^d ., Kessingland, Wangford.
71	<i>St. Michael's, Paddington</i> —That Life-boat	
72	<i>London Coal Exchange</i> —London Coal Exchange	
73	<i>Quiver, No. 2</i> —Quiver Magazine	
74	<i>John Keble</i> —Rev. T. Keble	Mr. J. Sinclair, East Cliff, Southwold, Wangford.
75	<i>Ipswich</i> —Town of Ipswich	Rev. J. F. Noott, Frostenden Hermitage, Wangford.
76	<i>George Hounsfield</i> —Mrs. Hounsfield	James Osborne, Esq., Aldborough, Suffolk.
77	<i>Springwell</i> —Miss Burmester	Mr. A. P. Bray, H.M. Customs, Harwich.
78	<i>Albert Edward</i> —Freemasons of England	
79	<i>Boys of England and Edwin J. Brett</i> —That Life-boat Fund.	
80	<i>Quiver, No. 1</i> —Quiver Magazine	Mr. F. J. Nunn, Clacton-on-Sea, Colchester.
81	<i>Thomas Chapman</i> —R. N. L. B. Institution	William Gregson, Esq., Southend.
82	<i>Samuel Morrison Collins</i> —A Lady	E. Isaacson, Esq., Margate.
83	<i>Bradford</i> —Town of Bradford.	
84	<i>Van Kook</i> —The late E. W. Cooke, Esq., and Friends	Capt. Isacke, North Foreland Lodge, Broadstairs.
85	<i>Centurion</i> —A Friend	Mr. Thomas Jackson, H.M. Coastguard, Broadstairs.
86	<i>Sabrina</i> —Mr. and Mrs. Ferguson	Capt. Richard Braine, Harbour Master, Ramsgate.
87	<i>Henry William Pickersgill, R.A.</i> —His Legacy.	Capt. W. M. Sanctuary, R.N., Walmer, Deal.
88	<i>Mayer de Rothschild</i> —Lady Rosebery	Mr. W. Bailey, H.M. C ^d G ^d ., Kingsdowne, near Dover.
89	<i>Dr. Hatton</i> —Mrs. Hatton	
90	<i>David Hulett</i> —D. Hulett, Esq.	
91	<i>Arthur Frederick</i> —Late Hon. Mrs. Fitz-Roy	Lieut.-General Bruce, C.B., 1, East Cliff, Dover.
92	<i>Storm Sprite</i> —Solicitors and Proctors	George Wilks, Esq., Hythe, Kent.
93	<i>Ellen Goodman</i> —Miss Goodman's Legacy	
94	<i>William and Mary</i> —Friends at Manchester	Henry Stringer, Esq., New Romney, S.O., Kent.
95	<i>Michael Henry</i> —Jewish Scholars' Life-boat Fund.	E. T. Bass, Esq., J.P., Lydd, New Romney, S.O., Kent.
96	<i>Robert Raikes</i> —London Sunday Schools	Henry Burra, Esq., Rye, S.O., Sussex.
97	<i>Ramonet</i> —Miss Robertson.	
98	Royal National Life-boat Institution	Mr. T. S. Hide, Hastings.
99	<i>Four Sisters</i> —Misses Hallam and Mrs. Birt	Thos. Child, Esq., Devonshire Lodge, Eastbourne.
100	<i>Undaunted</i> —The late Richard Thornton West, Esq., and Mrs. West	W. S. Edwards, Esq., Newhaven, S.O., Sussex.
101	<i>Olive Leaf</i> —Messrs. Leaf, Sons, and Co.	W. R. Wood, Jun., Esq., 124, Western Road, Brighton.
102	<i>City of Worcester</i>	Thos. Fuller, Esq., M.D., Longcroft, Shoreham.
103	<i>Worcester Cadet</i> —That Life-boat Fund	Melville Green, Esq., Worthing.
104	<i>George and Anne</i> —Mr. and Miss Marten	Rev. H. Mitchell, M.A., Bosham, near Chichester.
105	<i>Mary and Victoria</i> —The Earl of Strafford.	Rev. H. Chas. Foster, Selsey Rectory, near Chichester.
106	<i>John Lockett</i> —Mrs. and the Misses Lockett	J. Gorham, Esq., Cackham, Chichester.
107	<i>Joseph and Mary</i> —The late Mrs. Boetefeur	Rev. C. Hardy, Hayling Vicarage, Havant, Hants.
108	<i>Charlotte Mary</i> —S. J. Wilde, Esq., for late Miss M. R. Wilde.	Adl. Wilmshurst, C.B., Bembridge, Brading, R.S.O. I.W.
109	<i>George Scott</i> —E. M. S.	Rev. W. E. Heygate, M.A., Brighthelm, Newport, I.W.
110	<i>Mary Heape</i> —Benjamin Heape, Esq.	Rev. Reginald Broughton, Shorwell, Newport, I. W.
111	<i>Agnes Harriet</i> —The Earl of Strafford	Mr. W. Selby, Brooke Farm, Isle of Wight.
112	<i>Wm. Woodcock</i> —H. W., Manchester Branch	Nicolas Barbenson, Esq., Alderney, Guernsey.
113	<i>Rimington</i> —Mrs. Rimington	Capt. Carré, R.N., Valnord, Guernsey.
114	<i>Victoria</i> —Lady Rolle	
115	<i>China</i> —Hong Kong and Shanghai	Mr. Richard Penney, Poole.
116	<i>Mary Brundret</i> —Mrs. Brundret, per Manchester Branch.	Mr. Henry Hixson, Swanage, Wareham.
117	<i>City of Exeter</i> —Collected in Exeter	Rev. Owen Mansel, M.A., Church Knowle, Corfe Castle, Wareham.
118	<i>Maud Hargreaves</i> —Mrs. Hargreaves	
119	<i>Rescue</i> —The late Richard Durant, Esq.	G. H. Price, Esq., Collector H.M. Customs, Weymouth.
120	<i>Alexandra</i> —Freemasons of England	Mr. Wm. Bennett, Lyme Regis.
121	<i>Bowman</i> —"A. B. S."	W. M. Floyd, Esq., Sidmouth.
122	<i>Clemency</i> —Hon. Mrs. Hubbard	
		Capt. Squire, 1, Louisa Terrace, Fxmouth.
		W. Williams, Esq., Teignmouth, Devon.
		Mr. R. G. Cove, Clifton Villa, Warren Road, Torquay.
		Rev. R. F. Elrington, M.A., Lower Brixham, Devon.
		Percy Hockin, Esq., Dartmouth.
		W. H. Webb, Esq., H.M. Cus., Salcombe, Kingsbridge.
		R. Dawson, Esq., Wembury House, near Plymouth.
		John Sadler, Esq., 17, Caprera Terrace, Plymouth.

[Continued.]

No.	STATION.	Length.		Breadth.		No. of Oars.	When Stationed or Named.
		Ft.	In.	Ft.	In.		
123	CORNWALL - - - LOOE - - -	32	0	7	6	10	1867
124	FOWEY - - -	32	0	7	5	10	1879
125	MEVAGISSEY - - -	33	0	8	1	10	1869
126	PORTLOE - - -	33	0	8	1	10	1870
127	FALMOUTH - - -	33	0	8	6	10	1867
128	PORThOUSTOCK - - -	33	0	8	0	10	1869
129	CADGWITH - - -	33	0	8	1	10	1878
130	LIZARD - - -	30	0	7	2	10	1873
131	MULLION - - -	33	0	8	6	10	1867
132	PORThLEVEN - - -	30	0	7	0	10	1869
133	PENZANCE - - -	32	0	7	4	10	1865
134	SENNEN COVE - - -	33	0	8	0	10	1864
135	SCILLY ISLANDS - - - ST. MARY'S - - -	37	0	9	0	12	1874
136	CORNWALL - - - ST. IVES - - -	32	0	7	6	10	1878
137	HAYLE - - -	32	0	7	6	10	1866
138	NEW QUAY - - -	33	0	8	1	10	1873
139	PADSTOW - - -	32	0	7	4	10	1864
140	PORT ISAAC - - -	32	0	7	7	10	1869
141	BUDE - - -	33	0	8	0	10	1863
142	NORTH DEVON - - - CLOVELLY - - -	33	0	8	1	10	1870
143	APPLEDORE—No. 1 - - -	34	0	7	1	12	1862
144	„ No. 2 - - -	30	0	6	7	6	1875
145	BRAUNTON - - -	32	0	7	5	10	1866
146	MORTE BAY - - -	33	0	7	11	10	1871
147	ILFRACOMBE - - -	32	0	7	6	10	1866
148	LYMOUTH - - -	30	0	7	7	8	1869
149	SOMERSET - - - WATCHET - - -	33	0	8	6	10	1875
150	BURNHAM - - -	32	0	7	5	10	1866
SOUTH WALES.							
151	GLAMORGANSHIRE PENARTH - - -	30	0	8	0	8	1875
152	PORThCAWL - - -	32	0	7	9	10	1872
153	SWANSEA - - -	33	0	8	1	10	1866
154	CARMARTHENSHIRE PEMBREY - - -	32	0	7	6	10	1871
155	CARMARTHEN BAY - - -	32	0	7	6	10	1879
156	PEMBROKESHIRE - TENBY - - -	33	0	8	0	10	1863
157	MILFORD - - -	33	0	8	6	10	1868
158	SOLVA - - -	33	0	8	1	10	1869
159	ST. DAVID'S - - -	32	0	7	6	10	1869
160	FISGUARD—No. 1 - - -	30	0	6	8	6	1863
161	„ No. 2 - - -	36	0	8	3	12	1878
162	CARDIGANSHIRE - CARDIGAN - - -	32	0	7	4	10	1864
163	NEWQUAY - - -	35	0	8	0	12	1864
164	ABERYSTWITH - - -	33	0	8	2	10	1876
NORTH WALES.							
165	MERIONETHSHIRE - ABERDOVEY - - -	32	0	7	4	10	1865
166	BARMOUTH - - -	34	0	8	4	10	1867
167	CARNARVONSHIRE PORTMADOC - - -	34	0	8	0	10	1867
168	ABERSOCH - - -	33	0	8	1	10	1869
169	PORThDINLLAEN - - -	37	0	9	0	12	1877
170	ANGLESEY - - - LLANDWYN - - -	32	0	7	6	10	1866
171	RHOSNEIGIR - - -	30	0	7	6	10	1872
172	RHOSCOLYN - - -	33	0	8	0	10	1878
173	HOLYHEAD - - -	37	0	9	1	12	1875

No.	NAME OF BOAT AND DONOR.	NAME AND ADDRESS OF HONORARY SECRETARY.
123	<i>Oxfordshire</i> —Late Sir J. P. Willoughby, Bt.	R. Thomas, Esq., Looe, R.S.O., Cornwall. [Cornwall.
124	<i>Arthur Hill</i> —Arthur Hill, Esq.	W. E. Geach, Esq., Penellick, Par Station, R.S.O.,
125	<i>South Warwickshire</i> —Collected by Sir R. N. Hamilton, Bt.	Capt. J. Ball Farran, Mevagissey, St. Austell.
126	<i>Gorfenkle</i> —Legacy of J. Gorfenkle, Esq.	Rev. Canon Cornish, M.A., Veryan, Grampound, R.S.O.
127	<i>City of Gloucester</i> —Gloucester City	Charles Clift, Esq., Falmouth.
128	<i>Mary Ann Story</i> —Mrs. Story's Legacy	Mr. E. P. Roskrige, St. Keverne, Helston.
129	<i>Joseph Armstrong</i> —That Life-boat Fund	Rev. F. C. Jackson, St. Ruan Rectory, Helston.
130	<i>Anna Maria</i> —Lord Robartes	Rev. P. Vyvyan Robinson, Llandewednack, Helston.
131	<i>Daniel J. Draper</i> —Wesleyan Methodists	Rev. E. G. Harvey, Mullion, Helston.
132	<i>Agar-Robartes</i> —Lord Robartes	R. Sedgman James, Esq., Porthleven, Helston.
133	<i>Richard Lewis</i> —J. C.	} John Mathews, Esq., Lloyd's Agency Office, Penzance.
134	<i>Cousins William and Mary Anne, of Bideford</i> —Mrs. Mary Anne Davis	
135	<i>Henry Dundas</i> —Mrs. Dundas Drummond's Legacy.	John Banfield, Esq., Scilly, R.S.O., Cornwall.
136	<i>Exeter</i> —Mr. W. Kendall's Legacy	T. B. Williams, Jun., Esq., St. Ives, R.S.O., Cornwall.
137	<i>Isis</i> —Oxford University	John Poole, Esq., Riviere, Hayle.
138	<i>Pendock Neale</i> —Late Miss Neale and Miss Herring.	Mr. Rd. Hicks, New Quay, R.S.O., Cornwall.
139	<i>Albert Edward</i> —City of Bristol	Rev. Richard Tyacke, Padstow, R.S.O., Cornwall.
140	<i>Richard and Sarah</i> —The late Richard Thornton West, Esq., and Mrs. West.	Frederick Trevan, Esq., Port Isaac, Wadebridge, R.S.O.
141	<i>Elizabeth Moore Garden</i> —Family of the late R. T. Garden, Esq.	Wm. Rowe, Esq., Stratton, "North Devon Mail."
142	<i>Alexander and Matilda Boetefeur</i> —The late Mrs. Boetefeur.	Mr. J. Bumby, Chief Officer Ct. G ^d , Clovelly, Bideford.
143	<i>Hope</i> —The late Rev. F. W. Hope	} Rev. I. H. Gosset, M.A., The Priory, Westward Ho! Bideford.
144	<i>Mary Ann</i> —The late Mrs. M. A. Walker	
145	<i>George and Catherine</i> —The late G. Jeremy, Esq., and Boat-house, per Mrs. Hartley.	Mr. W. Nicol, H.M. Customs, Appledore, R.S.O., Devon.
146	<i>Grace Woodbury</i> —Mr. Robt. Atton's Legacy	A. J. Law, Esq., Barnstaple.
147	<i>Broadwater</i> —Late R. Broadwater, Esq.	} N. Vye, Esq., J.P., Ilfracombe.
148	<i>Henry</i> —A Lady	
149	<i>Joseph Somes</i> —Mrs. Somes	Mr. John Crook, Valley of Rocks Hotel, Lynton, Barnstaple.
150	<i>Cheltenham</i> —Town of Cheltenham	Edwin Ford, Esq., H.M.Cust., Watchet, R.S.O., Somerst.
		Cuthbert Ritson, Esq., Burnham, Bridgwater.
151	<i>Joseph Denman</i> —Hon. Mrs. Joseph Denman	} Capt. Pengeley, H.M.I.N., Dock Master, Penarth,
152	<i>Chafyn Grove</i> —Miss J. E. Chafyn Grove	
153	<i>Wolverhampton</i> —Town of Wolverhampton.	Rev. W. Jones, Newton Nottage, Bridgend. [Cardiff.
154	<i>Stanton Meyrick, of Pimlico</i> —His Legacy	T. W. Islay Young, Esq., West Cross, Oystermouth, near Swansea.
155	<i>City of Manchester</i> —Manchester Branch	Gerard Elkington, Esq., Pembrey, Llanelly.
156	<i>Carolina Morris's Divine Rescue</i> —Mrs. Morris's Legacy.	John Risley, Esq., Brondeg, Ferryside, R.S.O.
157	<i>Katharine</i> —Titus Salt, Esq.	J. R. Rowlands, Esq., Nat. Provincial Bank, Tenby.
158	<i>Charles and Margaret Egerton</i> —Widow of Capt. Egerton, R.N.	Henry Pattison, Esq., Collector H.M. Customs, Milford.
159	<i>Augusta</i> —Earl of Dartmouth and Tenantry	Mr. C. Browne, H.M. Customs, Solva, R.S.O., Pembroke-
160	<i>Sir Edward Perrott</i> —R. N. L. B. Institution	[shire.
161	<i>Helen of Foxley</i> —Miss Harrison's Legacy	Capt. John Davies, St. David's, R.S.O., Pembrokeshire.
162	<i>John Stuart</i> —Manchester Branch	} Mr. W. Vaughan, Fishguard, R.S.O., Pembrokeshire.
163	<i>Nelson</i> —A Lady	
164	<i>Lady Haberfeld</i> —Her Legacy	John Morgan, Esq., Collector H.M. Customs, Cardigan.
		Capt. Thos. Jones, High Terrace, New Quay, Llandys-
		Mr. John Williams, Bridge Street, Aberystwith. [sil.
165	<i>Royal Berkshire</i> —Berkshire	} [North Wales.
166	<i>Ellen</i> —"E. P. S."	
167	<i>John Ashbury</i> —James Ashbury, Esq., per Manchester Branch.	Mr. D. Williams, H.M. Customs, Aberdovey, R.S.O.,
168	<i>Mabel Louisa</i> —Late R. Barnes, Esq., ditto	Mr. J. Jenkins, H.M. Customs, Barmouth, R.S.O.,
169	<i>George Moore</i> —That Life-boat Fund	[North Wales.
170	<i>John Gray Bell</i> —H.W., Manchester Branch	D. Homfray, Esq., Portmadoc, R.S.O., Carnarvonshire.
171	<i>Thomas Lingham</i> —Mrs. Lingham	} Rev. O. Lloyd Williams, Bodfean, Pwllheli.
172	<i>Ramon Cabrera</i> —The Countess de Morella	
173	<i>Thomas Fielden</i> —Samuel, John, and Joshua Fielden, Esqrs.	John Jackson, Esq., Harbour Office, Carnarvon.
		Mr. J. W. Huws, Brynteg, Llanfaelog, Holyhead.
		J. H. Platt, Esq., Bodior, Holyhead.
		William P. Elliott, Esq., Holyhead.

No.	STATION.	Length.	Breadth.	No. of Oars.	When Stationed or Named.
174	ANGLESEY - - - CEMLYN - - - - -	Ft. in. 32 0	Ft. in. 7 6	10	1877
175	CEMAES - - - - -	30 0	8 0	8	1876
176	BULL BAY - - - - -	32 0	7 7	10	1868
177	MOELFRE - - - - -	32 0	7 5	10	1874
178	PENMON - - - - -	34 0	8 0	10	1880
179	CARNARVONSHIRE ORME'S HEAD	33 0	8 7	10	1867
180	DENBIGHSHIRE - LLANDDULAS - - - - -	33 0	8 6	10	1868
181	FLINTSHIRE - - RHYL (TUBULAR) - - - - -	32 0	8 4	12	1856
182	" No. 2 - - - - -	33 0	8 6	10	1878
183	CHESHIRE - - - NEW BRIGHTON, No. 1 (TUBULAR)	45 0	10 2	14	1876
184	" No. 2 (Ditto) - - - - -	40 0	8 10	12	1878
185	LANCASHIRE - - SOUTHPORT - - - - -	34 0	8 6	10	1874
186	LYTHAM - - - - -	33 0	8 0	10	1878
187	BLACKPOOL - - - - -	33 0	8 0	10	1864
188	FLEETWOOD - - - - -	34 0	8 6	10	1879
189	PIEL - - - - -	36 0	8 1	12	1878
190	CUMBERLAND - - SEASCALE - - - - -	32 0	7 9	10	1875
191	WHITEHAVEN - - - - -	33 0	8 0	10	1866
192	MARYPORT - - - - -	32 0	7 4	10	1865
193	SILLOTH - - - - -	32 0	7 6	10	1867
194	ISLE OF MAN - - RAMSEY - - - - -	33 0	8 6	10	1868
195	DOUGLAS—No. 1 - - - - -	32 0	7 6	10	1868
196	" No. 2 - - - - -	35 0	9 0	10	1874
197	CASTLETOWN - - - - -	32 0	7 6	10	1865
SCOTLAND.					
198	KIRKCUDBRIGHT - KIRKCUDBRIGHT - - - - -	32 0	7 6	10	1879
199	WIGTOWNSHIRE - WHITHORN - - - - -	33 0	8 6	10	1869
200	PORT LOGAN - - - - -	30 0	7 1	10	1866
201	PORT PATRICK - - - - -	37 0	8 6	12	1877
202	AYRSHIRE - - - BALLANTRAE - - - - -	33 0	8 1	10	1871
203	GIRVAN - - - - -	32 0	7 5	10	1865
204	AYR - - - - -	32 0	7 5	10	1867
205	TROON - - - - -	32 0	7 6	10	1871
206	IRVINE - - - - -	33 0	7 6	10	1874
207	ARDROSSAN - - - - -	33 0	8 2	10	1870
208	ISLE OF ARRAN - KILDONAN - - - - -	32 0	7 6	10	1870
209	ARGYLLSHIRE - - CAMPBELTOWN - - - - -	32 0	7 6	10	1876
210	SOUTHEND - - - - -	32 0	7 6	10	1869
211	ORKNEYS - - - STROMNESS - - - - -	33 0	8 0	10	1867
212	LONGHOPE - - - - -	37 0	9 2	12	1874
213	CAITHNESS-SHIRE - THURSO - - - - -	33 0	8 0	10	1871
214	HUNA - - - - -	34 0	8 3	10	1877
215	ACKERGILL - - - - -	30 0	8 0	8	1878
216	NAIRNSHIRE - - MORAY FIRTH - - - - -	34 0	8 3	10	1878
217	ELGINSHIRE - - LOSSIEMOUTH - - - - -	32 0	7 6	10	1866
218	BANFFSHIRE - - BUCKIE - - - - -	33 0	8 1	10	1871
219	BANFF - - - - -	32 0	7 6	10	1870
220	ABERDEENSHIRE - FRASERBURGH - - - - -	33 0	8 6	10	1874
221	WHITELINK BAY - - - - -	33 0	8 6	10	1878
222	PETERHEAD - - - - -	33 0	8 1	10	1865

No.	NAME OF BOAT AND DONOR.	NAME AND ADDRESS OF HONORARY SECRETARY.
174	<i>Good Shepherd</i> —Loyal Order of Ancient Shepherds.	Mr. W. Williams, Fronddu, near Cemaes, Amlwch, R.S.O., Anglesey.
175	<i>Ashtonian</i> —The late George Heginbottom, Esq.	Rev. T. Lloyd Kyffin, Llanbadrig Vicarage, Amlwch, R.S.O., Anglesey.
176	<i>Eleanor</i> —A Lady in Wales	T. F. Evans, Esq., Amlwch, R.S.O., Anglesey.
177	<i>Lady Vivian</i> —Her collection	Rev. J. W. Evans, Llanallgo, Pentraeth, Anglesey.
178	<i>Christopher Brown</i> —Settle fund	William Preston, Esq., Lleinioeg Castle, Beaumaris.
179	<i>Sisters' Memorial</i> —Two Sisters	G. F. Felton, Esq., Mostyn Estate Office, Llandudno.
180	<i>Henry Nixon, No. 2</i> —The late Henry Nixon, Esq., per Manchester Branch.	Rev. John Davies, M.A., Llanddulas Rectory, Abergelle, R.S.O., Denbighshire.
181	<i>Morgan</i> —Miss Ellen Hodgson	Mr. Robert Hughes, Rhyl, North Wales.
182	<i>Jane Dalton</i> —"D."	
183	<i>Willie and Arthur</i> —Joseph Leather, Esq.	Charles H. Beloe, Esq., 13 Harrington Street, Liverpool.
184	<i>Stuart Hay</i> —Messrs. John Hay & Co.	
185	<i>Eliza Fernley</i> —Mr. Fernley's Legacy	Vice-Admiral Barton, Southport.
186	<i>Charles Biggs</i> —Miss Biggs's Legacy	John Edmondson, Esq., Lytham, Preston.
187	<i>Robert William</i> —Mrs. and Miss Hopkins	A. M. Viener, Esq., Blackpool.
188	Royal National Life-boat Institution	Rev. Henry Lings, Queen's Terrace, Fleetwood.
189	<i>William Birkett</i> —Mr. Birkett's Legacy	Capt. E. P. Stokes, Barrow-in-Furness, Lancashire.
190	<i>William Tomlinson</i> —Misses Tomlinson.	Capt. David Borrowdale, Scotch Street, Whitehaven.
191	<i>Elizabeth</i> —Miss Leicester	
192	<i>Henry Nixon—No. 1</i> —The late H. Nixon Esq., per Manchester Branch.	W. H. Eckersley, Esq., Maryport.
193	<i>Mary Louisa</i> —Miss Browne's Legacy	John Stronach, Esq., Silloth, R.S.O., Cumberland.
194	<i>Two Sisters</i> —J. Ryder, Esq., per Manchester Branch.	Rev. George Paton, Ramsey, Isle of Man.
195	<i>Manchester and Salford Sunday Schools</i> —per Manchester Branch	Thos. Bawden, Esq., North Quay, Douglas, Isle of Man.
196	<i>John Turner-Turner</i> —Mrs. Turner-Turner and Family	
197	<i>Commercial Traveller</i>	G. H. Quayle, Esq., Castletown, Isle of Man.
198	<i>Mackie</i> —Dr. Mackie's Bequest	James McMuldrow, Esq., Kirkcudbright.
199	<i>Charlie Peck</i> —A Lady, per the late N. Griffith, Esq.	Alex. Macfie, Esq., Clydesdale Bank, Whithorn, R.S.O., Wigtownshire.
200	<i>Edinburgh and R. M. Ballantyne</i> —Edinburgh Workpeople, and Edinburgh Ladies' Endowment Fund.	Quintin Cochrane, Esq., Port Logan, R.S.O., Wigtownshire.
201	<i>Civil Service, No. 3</i> —Civil Service Fund	[Wigtownshire.
202	<i>William and Harriot</i> —Mrs. Richardson's Legacy.	David A. McClew, Esq., Dinvin, Port Patrick, R.S.O., Mr. Jas. Wason, Postmaster, Ballantrae, Girvan.
203	<i>Earl of Carrick</i> —The late A. Kay, Esq.	Wm. Forsyth, Esq., Girvan.
204	<i>Glasgow Workman</i> —Glasgow Workpeople	John Pollock, Esq., Town Clerk's Office, Ayr.
205	<i>Mary Sinclair</i> —Mrs. Sinclair	Alexander Wyllie, Esq., Troon.
206	<i>Isabella Frew</i> —William Sommerville, Esq.	James Dickie, Esq., Council Chambers, Irvine.
207	<i>Fuir Maid of Perth</i> —Peter Reid, Esq.	John Moffat, Esq., Ardrossan.
208	Royal National Life-boat Institution	James Paterson, Esq., Lamlash, R.S.O., Isle of Arran.
209	<i>Princess Louise</i> —Life-boat Fund	Mr. Alexander Mitchell, H.M. Customs, Campbeltown.
210	<i>John R. Ker</i> —Robert Ker, Esq.	
211	<i>Saltire</i> —The late Sir Titus Salt, Bart.	Capt. G. Bilton, Stromness, S.O., Orkney.
212	<i>Dickinson Edleston</i> —D. Edleston, Esq.	Edward E. Corrigan, Esq., Longhope, Kirkwall.
213	<i>Charley Lloyd</i> —Mr. Lloyd's Legacy	John Swanson, Esq., Thurso.
214	<i>W. M. C.</i> —"X. Y. Z."	Mr. David Dunnet, Quoys, Canisbay-by-Wick.
215	<i>George and Isabella</i> —Miss Bower	G. M. Sutherland, Esq., Bridge Street, Wick.
216	<i>Caulfield and Ann</i> —Mr. Lloyd Williams' Legacy.	H. T. Donaldson, Esq., Nairn.
217	<i>Bristol & Clifton</i> —Bristol Histrionic Club	Mr. Wm. Fraser, Harbour Master, Lossiemouth, Elgin.
218	<i>James Sturm</i> —Mr. Sturm's Legacy	John Shearer, Esq., Bank, Buckie, Fochabers.
219	<i>John and Sarah</i> —J. E. Lightfoot, Esq.	James Watt, Esq., National Bank of Scotland, Banff.
220	<i>Charlotte</i> —William McKerrell, Esq.	Andrew Tarras, Esq., Frithside Street, Fraserburgh.
221	<i>Robert Adamson</i> —Miss Adamson	Mr. A. J. Birnie, Cairdenity, Inverallochy, by Lonmay,
222	<i>People's Journal—No. 1</i> —Subscribers to Dundee "People's Journal."	William Boyd, Esq., F.R.S.E., Peterhead. [Aberdeen.

[Continued.

No.	STATION.	Length.		Breadth.		No. of Oars.	When Stationed or Named.
		Ft.	in.	Ft.	in.		
223	ABERDEENSHIRE - CRUDEN - - - - -	33	0	8	6	10	1877
224	NEWBURGH - - - - -	30	0	8	0	8	1877
225	KINCARDINESHIRE STONERAVEN - - - - -	33	0	8	6	10	1874
226	GOURDON - - - - -	33	0	8	0	10	1878
227	FORFAR - - - - - MONTROSE, No. 1 - - - - -	33	0	8	6	10	1869
228	" No. 2 - - - - -	30	0	8	0	8	1874
229	ARBROATH - - - - -	32	0	7	6	10	1866
230	BUDDON NESS	33	0	8	6	10	1870
231	BROUGHTY FERRY } DUNDEE {	33	0	8	6	10	1876
232	FIFESHIRE - - - - - ST. ANDREW'S - - - - -	33	0	8	0	10	1873
233	ANSTRUTHER - - - - -	32	0	7	4	10	1866
234	HADDINGTONSHIRE NORTH BERWICK - - - - -	30	0	7	7	10	1871
235	DUNBAR - - - - -	33	0	8	0	10	1865
236	BERWICKSHIRE - EYMOUTH - - - - -	30	0	8	0	8	1876
IRELAND.							
237	Co. LONDONDEERRY GREENCASTLE - - - - -	33	0	8	0	10	1871
238	ANTRIM - - - - - PORTRUSH - - - - -	32	0	7	6	10	1876
239	DOWN - - - - - GROOMSPORT - - - - -	32	0	7	6	10	1867
240	BALLYWALTER - - - - -	32	0	7	6	10	1866
241	TYRELLA - - - - -	30	0	8	0	8	1875
242	NEWCASTLE - - - - -	34	0	8	0	10	1880
243	LOUTH - - - - - DUNDALK No. 1.—GILES' QUAY	32	0	7	6	10	1867
244	" No. 2.—BLACKROCK - - - - -	32	0	7	6	10	1867
245	DROGHEDA—No. 1 - - - - -	34	0	7	6	10	1879
246	" No. 2 - - - - -	32	0	7	6	10	1872
247	DUBLIN - - - - - BALBRIGGAN - - - - -	30	0	6	7	6	1875
248	SHERRIES - - - - -	33	0	8	6	10	1873
249	ROGERSTOWN - - - - -	32	0	7	6	10	1874
250	HOWTH - - - - -	33	0	8	0	10	1872
251	POOLBEG - - - - -	32	0	7	6	10	1866
252	KINGSTOWN - - - - -	37	0	8	6	12	1879
253	GREYSTONES - - - - -	33	0	8	0	10	1872
254	WICKLOW - - - - - WICKLOW - - - - -	33	0	8	0	10	1866
255	ARKLOW - - - - -	37	0	9	0	12	1873
256	WEXFORD - - - - - COURTOWN - - - - -	36	0	8	4	12	1876
257	CAHORE - - - - -	34	0	8	0	10	1879
258	WEXFORD—No. 1 - - - - -	40	0	10	6	12	1871
259	" No. 2 - - - - -	34	0	8	3	10	1878
260	CARNSORE - - - - -	32	0	7	4	10	1874
261	DUNCANNON - - - - -	33	0	8	6	10	1869
262	WATERFORD - TRAMORE - - - - -	34	0	8	0	10	1880
263	DUNGARVAN - - - - -	32	0	7	7	10	1871
264	ARDMORE - - - - -	34	0	8	0	10	1880
265	CORK - - - - - YOUGHAL - - - - -	32	0	7	6	10	1867
266	BALLYCOTTON - - - - -	34	0	8	0	10	1880
267	QUEENSTOWN - - - - -	34	0	8	0	10	1866
268	COURTMACSHERRY - - - - -	32	0	7	6	10	1867
269	KERRY - - - - - VALENTIA - - - - -	32	0	7	4	10	1864
270	TRALEE BAY - - - - -	34	0	8	3	10	1879

NOTE.—The Life-boat builders of the Institution

No.	NAME OF BOAT AND DONOR.	NAME AND ADDRESS OF HONORARY SECRETARY.
223	<i>Peep-o'-day</i> —"A Scot Abroad"	James Shepherd, Esq., Aldie, Ellon.
224	<i>Alexander Charles, and William Aird</i> —Miss Birtwhistle's Legacy.	Mr. P. Murray, Newburgh-by-Aberdeen.
225	<i>Star</i> —Mrs. Henry Hearn	David Carr, Esq., Stonehaven.
226	<i>Young George Irlam</i> —Mr. Irlam's Legacy	Rev. John Brown, Bervie, Fordoun.
227	<i>Mincing Lane</i> —Merchants of Mincing Lane	} James Warrack, Esq., Montrose.
228	<i>Roman Governor of Caer Hân</i>	
229	<i>People's Journal</i> —No. 2.—Subscribers to Dundee "People's Journal."	William Cargill, Esq., Arbroath.
230	<i>May</i> —"D."	} James Hunter, jun., Esq., 69 Reform Street, Dundee.
231	<i>English Mechanic</i> —Life-boat Fund	
232	<i>Ladies' Own</i> —Miss Smithers' Life-boat Fund	Mr. G. Murray, Postmaster, St. Andrew's.
233	<i>Admiral Fitz Roy</i> —A Lady (H. H.)	H. B. Mackintosh, Esq., Anstruther.
234	<i>Freemason</i> —Freemasons of England.	{ Walter Malcolm, Esq., North Berwick. D. McCulloch, Esq., British Linen Co., North Berwick.
235	<i>Wallace</i> —The late Lady Cuninghame Fairlie	G. R. Scott, Esq., Bank, Dunbar.
236	<i>James and Rachel Grindlay</i> —Mr. T. Grindlay's Legacy.	Mr. Peter Wilson, Eyemouth, Ayton.
237	Royal National Life-boat Institution	Rev. T. McClellan, Greencastle, Merville.
238	<i>John Whitaker</i> —Late Mr. Whitaker's Trust Fund, per E. Absalom, Esq.	{ Rev. J. Simpson, W. E. Carver, Esq., J.P. } Portrush, R.S.O., Co. Antrim.
239	<i>Florence</i> —A Friend	The Honorary Secretary, Groomsport, Belfast.
240	<i>Admiral Henry Meynell</i> —Misses Meynell Ingram.	Rev. J. O'Reilly Blackwood, Ballywalter, Newtownards.
241	<i>Memorial</i> —Misses Frances and Kate Peach	Rev. John Bingham, Tyrella Rectory, Clough, S.O.,
242	<i>Reigate</i> —Collected in Reigate	Mr. W. Hayward, Newcastle, S.O., Co. Down.
243		} J. F. Farrell, Esq., Harbour Office, Dundalk.
244	<i>Stockport Sunday School</i> —Life-boat Fund	
245	<i>Old George Irlam, of Liverpool</i> —Miss Irlam's Legacy	Mr. N. Halligan, Banktown, Drogheda.
246	<i>John Rutter Chorley</i> —Mr. H. F. Chorley's Legacy	J. H. Brabazon, Esq., Mornington House, Drogheda. Mr. J. M'Namara, Harbour Office, Drogheda.
247	<i>Maid of Annan</i> —Mrs. Langworthy	{ H. A. Hamilton, Esq., } Balbriggan, R.S.O., Co. Dublin. Mr. W. G. Percival, }
248	<i>Laura Platt</i> —Mr. Thos. Platt	H. H. Foster, Esq., Skerries, S.O., Co. Dublin. [Dublin.
249	<i>Tileries, Tunstall</i> —Thos. Peake, Esq.	W. C. Townshend, Esq., Rogerstown, Rush, R.S.O., Co.
250	<i>Clara Baker</i> —A Friend, per Miss Baker	T. A. Montgomery, Esq., Howth, R.S.O., Co. Dublin.
251	<i>G. V. Brooke</i> —Brooke Life-boat Fund	Mr. S. Carr, C.O.C.G ^d , Ring's End, near Dublin.
252	<i>Hector</i> —Late Miss Anderson and Niece	Capt. the Hon. F. G. Crofton, R.N., Harbour Master, Kingstown.
253	<i>Sarah Tancred</i> —Mr. Tancred's Legacy	P. Reid, Esq., Glencarrig, Delgany, Greystones.
254	<i>Robert T. Garden</i> —Late R. T. Garden, Esq.	S. E. Pim, Esq., Wicklow.
255	<i>Out-Pensioner</i> —Out-Pensioners	{ The Earl of Wicklow, Shelton Abbey, Co. Wicklow. Dr. Stopford Halpin, Arklow. }
256	<i>Alfred and Ernest</i> —Manchester Branch	J. S. Scott, Esq., J.P., Levuka, Gorey, Co. Wexford.
257	<i>John Brooke</i> —The Misses Brooke, per J. Richardson, Esq., Q.C.	{ Capt. R. D'Olier George, Cahore, Gorey, Co. Wexford. Mr. J. S. Sinnott, Cahore, Gorey, Co. Wexford. }
258	<i>Ethel Eveleen</i> —J. M. S.	{ Wm. Coghlan, Esq., Collector H.M. Customs, Wexford. Rev. T. W. Manning, Kilsoran Rectory, Tagoat, Wex-
259	<i>Civil Service</i> —No 1.—Civil Service Fund	Capt. Bartlett, Duncannon, Waterford. [ford.
260	<i>Iris</i> —Mrs. A. M. Burdon	
261	<i>Richard and Anne</i> —The late Mrs. and Miss Warner.	Edward Jacob, Esq., Ardview, Tramore, Waterford.
262	<i>Alfred Trower</i> —Henry Trower, Esq., and Friends.	
263	<i>Christopher Ludlow</i> —Dr. Ludlow's Trustees.	Mr. James W. Shaw, Dungarvan.
264	<i>Hooper</i> —Miss Hooper	William C. Poole, Esq., M.D., J.P., Ardmore, Youghal.
265	<i>Wm. Beckett of Leeds</i> —A Leeds Gentleman	J. W. Pim, Esq., Youghal.
266	<i>Oliver Goldsmith</i> —That Life-boat Fund	T. W. Strangman, Esq., Shanagarry, Middleton.
267	<i>Quiver</i> —No. 3.—Quiver Magazine	Capt. Nathaniel Sutton, Harbour Office, Queenstown.
268	<i>City of Dublin</i> —Collected in Dublin	Capt. Townshend, Courtmacherry, Bandon.
269	Royal National Life-boat Institution	{ The Knight of Kerry, } Valentia, Killarney. J. A. O'Driscoll, Esq., }
270	<i>Admiral Butcher</i> —R. G. Butcher, Esq.	Robert M'Cowen, Esq., Lloyd's Agent, Tralee.

are Messrs. Woolfe and Son, of Shadwell, London, E.

INDEX TO THE GIFT LIFE-BOATS OF THE ROYAL NATIONAL LIFE-BOAT INSTITUTION.

(The figures refer to the numbers of the Life-boats detailed on the ten preceding Pages.)

- A. B. S., 121.
 A Friend, 239.
 A Friend at Bradford, 51.
 A Friend, per G. H. Aston, 85.
 A Friend, per Miss Baker, 250.
 A Lady, 31.
 A Lady (H. H.), 233.
 A Lady, per T. Jones Gibb, Esq., 55.
 A Lady, per Capt. Fishbourne, R.N., C.B., 82.
 A Lady, "in memory of a very dear brother," 148.
 A Lady, 163.
 A Lady in Wales, 176.
 A Lady, per the late N. Griffith, Esq., 199.
 Anderson, Miss, the late, and Niece, 252.
 "A Scot abroad," 223.
 A Townsman of Leeds, 265.
 Abbott, the late John, Esq., 39.
 Adamson, Miss, 231.
 Agar, the late Hon. Mrs., 129.
 Ancient Shepherds, Loyal Order of (A.U.), 174.
 Anstice, Mrs., the late, 4.
 Ashbury, Jas., Esq., 167.
 Atton, Rob. Esq., the late, 146.
 Barlow, Miss, 23.
 Barnes, Robt., Esq., D.L., the late, 168.
 Beckett, the late John, Esq., 37.
 Berkshire, collected in, 165.
 Biggs, Miss, the late, 186.
 Bird, Samuel, Esq., 49.
 Birckett, Wm., the late, 189.
 Birtwhistle, Miss, the late, 224.
 Bolton, collected in, 70.
 Bouchier, Lady, 62.
 Bower, Miss, 215.
 Boys of England, 79.
 Bradford, 83.
 Bristol, Collected in, 159.
 Bristol Histrionic Club, 217.
 "British Workman" Magazine, collected from the readers thereof, 58.
 Broadwater, Robert, Esq., the late, and Friends, 147.
 Brooke, G. V., Life-boat Fund, 251.
 Brooke, the Misses, 257.
 Browne, Miss, the late, 193.
 Brundret, Mrs., 116.
 Burton, Mrs. A. M., 260.
 Burmester, Miss, 77.
 Burton-on-Trent, Coll. in, 28.
 Butcher, R. G., Esq., 270.
 Cama and Co., Messrs., 57.
 Carter, Misses, 20.
 Caslake, Mrs. B., 44.
 Cheltenham, collected in, 150.
 Chorley, the late H. F., Esq., 246.
 Civil Service, 13, 201, 259.
 Coal Exchange, London, Members of, the, 72.
 Commercial Travellers, 197.
 Corn Exchange, Mark Lane, Members of, the, 63.
 Covent Garden Life-boat Fund, 61.
 Crossley & Sons, Messrs. J., 27.
 D., 182, 230.
 Dartmouth, the Earl of, and his Tenantry, 159.
 Davis, Mrs. Mary Anne, 134.
 Davis, Mrs. George, 60.
 Denman, Hon. Mrs. Jos., 151.
 Derby, collected in, 18.
 Dixon, Miss, 43.
 Draper, Daniel J., Life-boat Fund, 131.
 Drummond, Mrs. Dundas, the late, 135.
 Dublin, collected in, 288.
 Duncan, Miss, 52.
 Dundee People's Journal, 222, 229.
 Durant, Richard, Esq., the late, 119.
 E. M. S., 109.
 E. P. S., 168. [200.
 Edinburgh Working Men's, Edinburgh Ladies' Endowment Fund, 200.
 Edleston Dickinson, Esq., 212.
 "English Mechanic" Life-boat Fund, 231.
 Egerton, Capt. C. R., R.N., widow of, 158.
 Exeter, collected in, 117.
 Exeter, J., Esq., the late, 185.
 Fielden, Samuel, John, and Joshua, Esqs., 173.
 Firbank, the late Edwd. and Mrs., 29.
 Foresters, Ancient Order of, 14, 25. [late, 34.
 Forthcutt, Mrs. Harriott, the Foulston, Mrs. Eliza, the late, 19.
 Freemasons of England, 78, 120, 234. [35.
 Freemasons of Warwickshire, Friends at Manchester, 94.
 Frith, J. G., Esq., the late, and Mrs. Frith, 3.
 Gibb, T. Jones, Esq., and Mrs., 11.
 Glasgow Workmen's, 204.
 Gloucester, collected in, 127.
 Goodman, the late Miss Ellen, 93.
 Good Templars, Independent Order of, 16.
 Gorfenkle, the late Jacob, Esq., 126.
 Grindlay, Thomas, Esq., the late, 236.
 Grocers of England, 54.
 Grove, Miss J.E. Chalyn, 152.
 H. W., 112, 170.
 Haberfield, Lady, the late, 164.
 Hackwood, Thos., Esq., 8.
 Hallam, the Misses and Mrs. Margaret Birt, 99.
 Hargreaves, John, Esq., the late, 38.
 Hargreaves, Mrs., 118.
 Harrison, Miss, the late, 161.
 Hatton, Mrs. Jane, 89.
 Hay, John, & Co., 184.
 Heape, Benjamin, Esq., 110.
 Hearn, Mrs. Henry, 225.
 Heginbottom, Geo., Esq., the late, 175.
 Hill, Arthur, Esq., 124.
 Hindley, Job, Mr., the late, 26.
 Hodgson, Miss Ellen, 181.
 Hollon, R. W., Esq., and Mrs. Hollon, 36.
 Hong Kong and Shanghai, collected at, 115.
 Hooper, Miss, 264.
 Hopkins, Mrs. and Miss, 187.
 Hopkinson, Miss, the late, 9.
 Hounsfeld, Mrs., 76.
 Hubbard, Hon. Mrs., 122.
 Huddersfield, collected in, 56.
 Hulet, David, Esq., 90.
 Ingleby, Rev. Chas., the late, per G. P. Wragge, Esq., 22.
 Ingram, Herbert, Esq., M.P., Friends of the late, 47.
 Ingram, Misses Meynell, 240.
 Ipswich, collected in, 75.
 Irlam, Geo. Esq., the late, 226.
 Irlam, the late Miss, 245.
 J. C., 133.
 J. L., the late, 69.
 J. M. S., 258.
 Jewish Scholars' Life-boat Fund, 95.
 Joseph Armstrong Life-boat Fund, 129.
 Kay, the late Alex., Esq., 203.
 Keble, Rev. T. 74.
 Kendall, W., Esq., 136.
 Ker, Robert, Esq., 210.
 Ladies' Own Life-boat Fund, 232.
 Landseer, Miss, 46.
 Langworthy, Mrs., 247.
 Leaf, Sons & Co., Messrs., 101.
 Leather, Jos., Esq., 183.
 Leeds, Town of, presented in the name of, 265.
 Leicester, collected in, 65.
 Leicester, Miss, 67, 131.
 Licensed Victuallers, collected from, 48.
 Lightfoot, J. E., Esq., 219.
 Lingham, Mrs., 171.
 Lloyd, the late Chas., Esq., 213.
 Lockett, Mrs. & the Misses, 106.
 London Sunday Schools, 96.
 Louise, the Princess, Life-boat Fund, 209.
 Ludlow, the late Dr., 263.
 Mackie, Dr., the late, 198.
 M. B., 64.
 McKerrell, W., Esq., 220.
 Manchester Branch, 1, 10, 26, 33, 112, 116, 155, 162, 167, 168, 170, 180, 192, 194, 195, 266.
 Manchester and Salford Sunday Schools, 195.
 Marten, G., Esq., and Miss Marten, 104.
 Mather, Mrs. Annie, 21.
 Meyrick, Stanton, the late, 154.
 Mincing Lane Merchants, 227.
 Moore, the late Geo., Esq., Life-boat Fund, 169.
 Morella, the Countess de, 172.
 Morris, the late Mrs., 156.
 N. R., 45.
 Neale, Miss, the late, and Miss Herring, 138.
 Nixon, the late Henry, Esq., 180, 192.
 Northumberland, The Dowager Duchess of, 7.
 Nottingham, collected in, 5.
 Odd Fellows (Manchester Unity), 42.
 Oliver Goldsmith, the, 266.
 Out-Pensioners, 255.
 Oxford University, 137. [68.
 Parkin, Thos., Esq., the late, Peach, Misses Frances and Kate, 241.
 Peake, Thomas, Esq., 249.
 Penny Readings, 50.
 Platt, Mr. Thomas, 248.
 Plimsoll Life-boat Funds, 66.
 "Quiver" Magazine, collected from the readers thereof, 73, 80, 267.
 Reid, Peter, Esq., 12, 207.
 Reigate, collected in, 242.
 Richardson, the late Mrs. Harriot, 202.
 Rimington, Mrs., 113.
 Robartes, Lord, 130, 132.
 Robertson, Miss, 97.
 Rochdale, collected in, 24.
 Rolle, Lady, 114.
 Roman Governor of Caer Hfn, the late, 223.
 Rosebery, Lady, 88.
 Rous, Admiral, Life-boat Fund, 41.
 Ryder, James, Esq., 194.
 St. Michael's, Paddington, Life-boat Fund, 71.
 Salt, Sir Titus, Bart., the late, 211.
 Salt, Titus, Esq., 157.
 Settle, collected in, 40, 178.
 Sinclair, Mrs., 205.
 Sister's Memorial, 179.
 Somes, Mrs., 149.
 Sommerville, W. Esq., 206.
 Stockport Sunday Schools, 24.
 Story, the late Mrs. M. A., 128.
 Strafford, the Earl of, P.C., 105, 111.
 Sturm, the late Jas. Esq., 218.
 Sykes, the late Mrs. A. E., 32.
 Tancred, the late J. Esq., 263.
 Tomlinson, the Misses, 190.
 Trower, Henry, Esq., and friends, 262.
 Turner-Turner, Mrs. and Family, 196.
 Vivian, Lady, coll. by, 177.
 W., Lady, 2.
 Walker, the late Mrs. Mary Ann, 144.
 Wardell, Miss, 6.
 Warner, the late Mrs. and Miss, 261.
 Wesleyan Methodists, 131.
 West, R. Thornton, Esq., the late, and Mrs. West, 100, 140.
 Whitaker, the late John, Esq., trust of the, per E. Abolom, Esq., 238.
 Wilde, S. J., Esq., for the late Miss M. R. Wilde, 108.
 Williams, Mr. Lloyd, the late, 216.
 Wolverhampton, coll. in, 153.
 Worcester Cadets Life-boat Fund, 103.
 Worcester, collected in, 102.
 X. Y. Z., 214.
 Yates, Mrs., the late, 30.

THE EXPENSE OF A LIFE-BOAT STATION IS £1,000. ITS COST IS MADE UP AS FOLLOWS:—

Life-boat and her equipment, including Life-belts for the Crew	
and Transporting-carriage for the Life-boat	£650
Boat-house (average cost)	350
Total	£1,000

The average annual expense of maintaining a Life-boat Station is £70, and the benefactions and contributions of Donors of Life-boats are earnestly solicited in aid of that fund.

GOD HELP OUR MEN AT SEA.



List of the Rewards

FOR SAVING LIFE FROM WRECKS

VOTED BY THE ROYAL NATIONAL LIFE-BOAT INSTITUTION

TO THE CREWS OF ITS LIFE-BOATS, TO SHORE AND FISHING-BOATS' CREWS, AND TO OTHER PERSONS,

FROM THE 1ST JANUARY TO THE 31ST DECEMBER, 1879.

Jan. 3.—A dismasted vessel having been seen off Newhaven harbour, the Life-boat *Michael Henry* proceeded to her. The wind was blowing moderately from W.S.W. and a heavy sea was running. On arriving at the vessel it was found that she had been abandoned by her crew, and the Life-boat, with the assistance of a steam-tug, took her into Newhaven Harbour. She was the schooner *Marie*, of Rostock, bound from Stettin to Exeter, with a cargo of potatoes.

Jan. 4.—Voted the Second Service Clasp of the Institution to the Rev. OWEN LLOYD WILLIAMS, in recognition of his continued intrepid services in the Abersoch and Porthdinllaen Life-boats of the Institution.

Jan. 7.—The *Laura Platt* Life-boat, stationed at Skerries, co. Dublin, was launched during a strong S.E. gale and heavy sea, and saved the crew of three men from the schooner *Elsmore*, of Runcorn, and six men from the brig *Lady Lilford*, of Ardrrossan. Both vessels were on a lee shore, and had exhibited signals of distress; the schooner had lost her boom and gaff, while her bulwarks had been washed away by the heavy seas; the brig's crew had to be hauled into the Life-boat with the aid of a life-buoy, the sea running too high to allow the Boat to go alongside; the vessel afterwards drove ashore to the northward of the Life-boat station, and became a wreck.—Expense of service, 16*l.* 11*s.* 6*d.*

Jan. 7.—A messenger arrived at Swanage from Studland stating that a vessel was in distress near the entrance to Poole Harbour. The Swanage Life-boat *Charlotte Mary* was at once launched and proceeded to the spot, when it was found that the ketch *Effort*, of Portsmouth, had parted from her anchors and gone ashore, the sea making a complete breach over her. The Life-boat, with great difficulty and danger, succeeded in rescuing the crew of two men and landed them at Poole.—Expense of service, 14*l.* 5*s.*

Jan. 8.—The Swansea Life-boat *Wolverhampton* saved the crew of ten men from the barque *Sarah Ann*, of Sunderland, which had sunk in Swansea Bay during a gale from E.S.E. She was on a voyage from Swansea to Monte Video, with a cargo of coal.—Expense of service, 14*l.* 12*s.*

Jan. 10.—The *Hannah Somerset* Life-boat, stationed at Staithes, Yorkshire, put off and rendered assistance to several fishing cobbles which were in danger during a very strong E.N.E. wind and heavy sea. With the help of the Life-boat all the boats were taken into port.

Jan. 11.—At 10.30 p.m. the passenger-ship *Lough Sunart*, of Glasgow, struck on Skulmartin Reef. The night was clear, with light N.W. wind and smooth sea. Signals of distress were shown from the vessel, and the Ballywalter Life-boat *Admiral Henry Meynell*, a coast-guard galley, and other boats

at once put off to her assistance. The women and children, twenty in number, were taken into the Life-boat, and the remaining twenty-five passengers were brought ashore by the other boats. As there was no immediate danger, the master and crew remained on board the ship.

At about 6 o'clock on the following evening, however, signals of distress were again shown from the vessel, the weather by that time having changed, the wind blowing very hard from the S.W., accompanied by heavy rain and sleet squalls, and a very heavy sea. The Life-boat promptly put off, and, in two trips, brought off the crew and workers, thirty-five in number, leaving the master and three men in charge of the ship.—Expense of services, 22l.

Jan. 12.—At about 11 A.M., information was received at Courtmacherry, co. Cork, that a large barque was embayed. On arriving at the Harbour point she grounded on the bar in about 18 feet of water. The wind was blowing from S.W. at the time, and a heavy sea was running. The Life-boat *City of Dublin* was quickly manned and launched and brought ashore the crew of eighteen men from the vessel, which proved to be the *General Caulfield*, of Newcastle, bound from New York to Dunkirk, with wheat. She became a total wreck.—Expense of service, 9l. 5s.

Jan. 13.—At 4.15 A.M. the barque *Cleopas*, of South Shields, bound from Liverpool to South Shields with a cargo of salt, was observed on the Barnard Sand during a S.W. wind and rough sea. In reply to her signals of distress the Kessingland No. 2 Life-boat proceeded to her, and with great difficulty rescued the crew of ten men, and landed them on the beach at Kessingland. The vessel became a total wreck.—Expense of service, 16l.

Jan. 13.—At about 7 P.M., it having been reported that a vessel was ashore at Portobello, about 4 miles distant from Newhaven, the Life-boat went to her assistance. A light S.S.W. wind was blowing at the time, and the weather was foggy. She was found to be in considerable danger, being close to the cliffs, and the Life-boat therefore remained by her. She proved to be the brigantine *True*, of Faversham, bound to Newhaven with coal. At about 2.45 A.M. the sea was breaking heavily over her, and as she was filling with water, the crew, consisting of seven men, were taken on board the Life-boat and safely landed at Newhaven.—Expense of service, 21l. 10s.

Jan. 14.—The brig *Allison*, of Whitby, stranded near Jury's Gap, off the coast of Sussex, during a strong S.S.W. wind and heavy sea. The crew were then in no danger, and it was hoped that the vessel would get off with the rising tide; but in the course of the day the wind and sea increased, and they signalled for the Life-boat. The Rye Life-boat was therefore launched, and brought safely ashore the crew, consisting of four men. The vessel subsequently became a total wreck.—Expense of service, 11l. 6s.

Jan. 14.—The Life-boat *Mincing Lane*, stationed at Montrose, N.B., rendered assistance to some Ferryden fishing boats which had been overtaken by heavy seas and were in danger near the harbour mouth. The Life-boat also assisted several other vessels which were in dangerous positions.—Expense of service, 3l. 18s.

Jan. 15.—At 7.30 A.M., during squally weather, a vessel was observed ashore on the Hasborough Sand. The Palling No. 2 Life-boat *British Workman* was launched and proceeded to the distressed vessel, which proved to be the Russian barque *Marie*, maize laden, from New York to Hull. With the assistance of a steam-tug she was got off the sand and taken to Yarmouth. She had a crew of twelve men.

Jan. 16.—In the evening, during hazy weather,

the s.s. *H. B. Brightman* struck on the rocks north of Staithees. Although the sea was comparatively smooth on the rocks round the steamer, it was too rough for any of the cibles to go out, and it was, therefore, thought advisable to launch the Life-boat. The boat accordingly proceeded to the vessel, and, at the request of the master, remained by her until she floated, and for about an hour and a half afterwards, and then returned ashore. The steamer, which was bound from the Tyne to Alexandria, returned north, but foundered before reaching the Tyne; her crew were fortunately saved in their own boats.—Expense of service, 10l. 15s.

Jan. 16.—At 2 A.M. the barquentine *Annie*, of Salcombe, bound from Bahia with a cargo of sugar, struck on Salcombe Bar during stormy weather. The *Rescue* Life-boat, stationed at Salcombe, went to her assistance and brought ashore the master and mate, the crew of nine men having left in the ship's boat. The vessel became a total wreck.—Expense of service, 17l. 10s.

Jan. 16.—The Montrose Life-boat *Mincing Lane* rendered assistance to several fishing-boats which were in distress off Montrose during stormy weather.

Jan. 17.—The smack *Wisdom*, of Shoreham, in attempting to leave the harbour at about 6 P.M. got foul of the new extension works, and hung by her shrouds. The crew were unable to get the vessel clear, and even if they had, she must have gone ashore, being on the W. side of the pier, and as the sea was breaking against her, the crew, six in number, were in great danger. Several shore boats attempted to render assistance, but failed on account of the heavy sea. The Life-boat *Ramonet* then put off and succeeded in laying out at anchor, and so enabled the crew of the smack to leave their vessel off.—Expense of service, 6l. 5s.

Jan. 17.—The Caister No. 2 Life-boat *Godsend* put off and remained by the brig *John*, of Hartlepool, until the vessel, which had stranded on the Barber Sand, was, with the assistance of a yawl, extricated from her perilous position.

Jan. 19.—The schooner *Fanny Bailey*, of Dundalk, bound from Troon to that port with coal and iron, stranded on the bar during a gale from S.E. and heavy sea. The Dundalk Life-boat *Stockport Sunday School* put off to her and rescued the crew, consisting of five men. The vessel struck the bar at 9 A.M. and at 8 P.M. was a total wreck.—Expense of service, 7l. 17s. 6d.

Jan. 23.—The fishing smack *Excelsior*, of Grimsby, stranded about 150 yards N. of Withernsea Pier, having mistaken the pier light for that of a vessel at anchor. She burnt a large flare light as a signal of distress, in response to which the Life-boat *Admiral Rous* was launched at about 3.15 A.M., and reached the smack, but being caught by heavy breakers, which broke three oars, she was driven back broadside on to the beach. With much difficulty she was, however, again launched and then succeeded in getting alongside the smack, and rescued the crew of five men. The Life-boat-men were completely drenched in rendering these services, the smack being exactly in the breakers, and the seas going right over the Life-boat.—Expense of service, 25l. 10s.

Jan. 24.—In reply to signals from the Swin Middle Light-ship, the Clacton-on-Sea Life-boat *Albert Edward* was launched, and proceeding in a S. direction sighted a dismasted ship—the *Hebe*, of Frederickstadt—on the east end of the Swin Middle Sand, the sea making a complete breach over her. On nearing the wreck, the crew were seen standing in a group near the port quarter. The Life-boat dropped anchor and veered down to the vessel. After seven attempts to get the crew, the Boat having filled three times, she succeeded in

taking eleven men on board. The ship had by that time altered her position, and as it was impossible to approach her again on account of the wreckage alongside, the remaining three men had to be hauled through the breakers by means of life-lines. After getting the crew on board it was found that the wreck had fouled the Life-boat's cable; this, however, was slipped, and the Boat then made for the shore. The rescued men were much exhausted, more especially the captain, who had been injured on board the vessel before being hauled through the breakers. The Life-boat, on account of the water being low, had to be drawn some distance into the sea before she could be launched, the heavy seas breaking completely over the horses and men in charge.—Expense of service, 17l. 11s.

Jan. 27.—The s.s. *Edith Owen*, of London, bound from Bristol to Liverpool with a general cargo, struck on the Coal Rock, off the coast of Anglesey, during foggy weather, the wind blowing moderately from the E. at the time. Signals of distress being exhibited from the steamer, the Cemlyn Life-boat *Good Shepherd*, the Cemaes Life-boat *Ash-tonian*, and a steam-tug, proceeded to her assistance. The passengers, five in number, were taken into the Cemaes Boat and landed at that Life-boat station. The Cemlyn Boat remained some time by the steamer while the tug attempted to tow her off. Eventually the Life-boat returned ashore at about midnight, and soon after she had gone, the vessel's crew left in their own boats. The steamer eventually became a total wreck.—Expense of service, 14l. 13s.

Jan. 28.—At 3 A.M. signal lights were seen from Caister, Norfolk, in the direction of the Barber Sand. A yawl proceeded there and found the schooner *Hermann*, of Berwick, bound from Hull to London with deal boards, ashore. As it was feared that the sea would increase with the flood tide, the wind being easterly, signals were made for the Life-boat to come and remain by the vessel. The Caister No. 2 Life-boat *Godsend* accordingly proceeded out at about 4.30 A.M., and stayed by the schooner until 1 P.M., when the crew of six men were taken ashore by the Life-boat, the master and mate deciding to remain on board. The Boat returned to the vessel, which was then dismantled, and was got off on the next flood tide.

Feb. 1.—At 10.40 P.M., during a fresh breeze from S.E., signals were fired from the Gull Light-ship. On the Ramsgate Life-boat *Bradford* and steam-tug *Vulcan* proceeding to her, it was ascertained that a large flare light had been seen in a south-easterly direction. They then went round the North Sand Head and found a vessel ashore. On getting alongside, the master stated that he had engaged the services of some Deal boatmen to assist to get the vessel off; she was then beating heavily on the sand, her anchor was let go, but as the tide flowed she beat further up. The master then requested additional help, and a signal was made for the tug, which backed in towards the vessel, her large towing hawser was attached, and the steamer then attempted to tow her off, but after a short time the hawser broke. She again backed in, and the tow-rope having been made fast, she went ahead, and the vessel floated. The cable was then slipped, and she was towed round the North Sand Head and taken into harbour, the pumps being kept going all the time. The vessel proved to be the brig *Margaret*, of West Hartlepool, from Boulogne to Hartlepool, in ballast.

The Broadstairs Life-boat also put off to this vessel, and remained by her until she was got off the sand.—Expense of service, 16l. 10s.

Feb. 4.—At about 10 P.M., during a fresh breeze from S.S.W., the schooner *Sarah Ann Dickinson*,

of Fleetwood, in approaching Ardrossan Harbour, ran on the Eagle Rock. A steam-tug proceeded to her and made an unsuccessful attempt to get her off. As the breeze had increased to a fresh gale, it was impossible for the crew to land in their own boat, and the Life-boat *Fair Maid of Perth* was therefore towed out by the steamer, and brought ashore the crew, consisting of five men, and a labourer, who had gone on board before the vessel struck. Great difficulty was experienced in effecting this rescue, the shipwrecked men having to drop from the vessel's main boom over the starboard quarter into the Life-boat. The Boat struck twice heavily on the rock; but fortunately sustained no damage.—Expense of service, 15l. 2s. 6d.

Feb. 6.—Voted 228l. 15s. 8d. to pay the expenses of the Life-boats at Rhyl, Porthdinllaen, Weymouth, Penzance, Montrose, Bude, Clovelly, Deal, Padstow, Winchelsea, Carmarthen Bay, Hartlepool, Skegness, Courtmacsherry, Kessingland, Wexford, Swanage, Tenby, Montrose, and Filey, in assembling their crews or putting off in reply to signals of distress shown by vessels not ultimately needing assistance.

The Ramsgate Life-boat had also been taken out in reply to distress signals, but her services were not eventually needed.

Voted a binocular glass, with a suitable inscription, to Mr. M. MURPHY, late Coxswain of the New Romney Life-boat. He had held the office of coxswain more than ten years, and had always given every satisfaction to the Local Committee.

Also 10l. to Mr. JOHN GARVEY, late Coxswain of the Drogheda No. 2 Life-boat, in acknowledgment of his long services, and especially in consideration of the exposure he underwent through being washed overboard from the Life-boat while endeavouring to rescue the crew of the s.s. *Urania*, of Swansea, on the 18th January, 1877.

Feb. 9.—The Life-boat *Stanton Meyrick of Pimlico*, stationed at Pembrey, S. Wales, proceeded to the aid of the brigantine *Levette*, of St. Malo, which was lying at anchor near the Lynch Sands with a signal of distress flying. On arriving at the vessel she was found to have been abandoned by her crew, but some of the crew of a steam-tug had gone on board a few minutes previously, and four of the Life-boatmen also boarded her, and with their joint assistance the chain cables were hove in, a tow rope attached from the steamer, and the vessel was then taken into Llanelly Harbour.

Feb. 9.—The barque *Alpheus Marshall*, of Digby, N.S., bound from New York to London, with a general cargo, went ashore on Atherfield Ledge, Isle of Wight, during a fog. The wind was blowing from S.W., and the sea was very heavy. The Brightstone Grange Life-boat *Rescue* proceeded to her assistance, and with great difficulty got near her; she lay head-to-sea, and was submerged with the exception of the starboard side of poop; soon the hatches blew up, and she began to go to pieces. The crew of fourteen men were taken into the Life-boat one by one from the spanker boom, having to be hauled by means of ropes through the surf, and during the whole of the time the Life-boat was almost under water, and the men were nearly washed out of her. On her return the sea was so heavy and the shore so steep that those on the land could not hook the Boat's bow as she beached, so she swung round, and a huge sea striking her threw all the crew and the saved men, twenty-seven in all, into the surf. Some of them were nearly washed out to sea, but all were happily rescued with the aid of those on shore.—Expense of service, 28l. 4s.

Feb. 9.—At 4.45 A.M., during thick weather, blue lights were seen in the direction of the Scroby Sand. The Caister No. 2 Life-boat proceeded there; found the s.s. *Matin*, of Dundee, ashore, and, at the master's request, remained by her until she floated. She was bound from Boulogne to the Tyne, in ballast.

On the afternoon of the following day, the No. 2 Life-boat was again launched and rescued twelve men, including the crew of the dandy *William*, of London, which was wrecked on the North Scroby Sand, and six beachmen who had gone on board to try to save the vessel. Considerable difficulty was experienced by the Life-boatmen in effecting this rescue, it being very dark at the time, and the sea breaking completely over the wreck. The smack was lying on her starboard side, her lee rigging being in the water, and the crew and beachmen were clinging to the wreck; a few minutes later, and they must have been lost.—Expense of service, 18*l*.

Feb. 15.—During a fresh E. breeze the Ramsgate Life-boat *Bradford* and steam-tug *Aid* proceeded, in reply to signals from light-ships, and found the ketch *Richard Willson*, of London, bound from Goole to Exmouth with coal, ashore on the N.E. part of the Goodwin Sands. On arriving near the spot, the Life-boat was slipped and sailed towards the vessel, which was found to be striking heavily and fast sinking. The master, his wife and two children, and the crew of three men, were at once taken on board the Boat, which then made sail across the sand, through a rough sea, to the harbour. The tug being on the off side of the sand steered round the North Sand Head, and followed into the harbour.

Feb. 16.—At 6 P.M. information was brought to Harwich by a Ramsgate smack that a large vessel was ashore on the Long Sand, and that the crew were in great danger. The Life-boat *Springwell* immediately proceeded there, but, on account of the low state of the tide, she could not then get alongside the wreck. At high tide the steam-tug *Harwich* came up, and, with the aid of the Life-boat, managed to get a rope fast to the stranded ship; she was, however, unable to get her off. The wind subsequently freshened, and a heavy sea sprung up, breaking over the vessel amidships in consequence of her having heeled over, her ballast having been thrown overboard. Signals were then made by the men on board for the Life-boat to come to their aid, and accordingly she went alongside and succeeded in taking off thirteen of the crew and ten smacksmen who had gone on board to assist. Two of the men fell between the vessel and the Life-boat as they were trying to get into the Boat, but were fortunately rescued. The Life-boat then remained by the wreck until daylight, when it was found that the steward was missing, and on looking at the vessel he was seen in the mizzen rigging. The shipwrecked sailors were then put on board a smack, and on the Life-boat returning to the ship, the steward lowered himself by a rope from the mizzen boom into the Boat, and she was then towed back to Harwich. The vessel was the barque *Pasithea*, of Liverpool, bound from Hamburg to Cardiff, in ballast.

Feb. 17.—A sudden E.S.E. gale sprang up while the fishing cobles were out, and as they were in great danger on account of the tremendous sea breaking on the bar, the *Staites* Life-boat was launched, and was very useful in helping the boats safely ashore.

Feb. 18.—The schooner *Apollo*, of Bandholm, bound from London to Cette with a cargo of currants, drove on to the rocks near Rock-a-Nore in a N.W. wind and heavy swell. The Hastings Life-boat proceeded to her, and as it was found

impossible to get the vessel afloat, the crew, consisting of five men, were taken into the Boat and brought ashore.—Expense of service, 19*l*. 3*s*.

Feb. 18.—The fishing smack *Esmeralda*, of Grimsby, was, owing to there being no wind and a very heavy sea, driven helplessly towards the shore a little to the N. of Cayton Bay. Her signal of distress, made by burning a flambeau, was seen at Scarborough, and the Life-boat *Lady Leigh* at once went to her aid. It was found that she was in extreme peril, for she had anchored, and the cable having parted she was already amongst the broken water, the seas breaking right over her. The Life-boatmen ran out a kedge and a hundred fathoms of warp from the vessel, by which she was brought up. She was afterwards towed out of danger by the Life-boat, and brought into harbour in safety at midnight. She had a crew of five men. Had the Life-boat been a quarter of an hour later, the smack must have been wrecked, and her crew would doubtless have perished, the breakers being very heavy, and the place abounding with sunken rocks a long way from the shore.

Feb. 24.—At about 6.30 P.M., while a strong breeze from E.N.E. was blowing, accompanied by a heavy sea, signals of distress were observed from the fishing lugger *Dolphin*, of Wexford, which had just struck on the leeward side of the bar in running for the harbour during a heavy snow squall. The Wexford Life-boat *Civil Service* was immediately launched, and on arriving alongside found the lugger full of water, and the sea breaking heavily over her. The crew, consisting of five men, were with some difficulty taken into the Life-boat and landed safely at Rosslare Fort. The vessel was totally wrecked.—Expense of service, 14*l*. 1*s*. 6*d*.

Feb. 27.—It having been reported that a vessel was in a very dangerous position at Morte, the *Broadwater* Life-boat, stationed at Iffracombe, was launched and proceeded to the place, a dense fog prevailing at the time. On arriving at the spot, the schooner *Bertha*, of Stettin, was found riding in the breakers at a single anchor, close under the cliffs, and showing lights as a signal of distress. She had been aground, and the crew, after having taken to their boat with a view of ascertaining where they were, had returned to the schooner when she floated again. At the master's request some of the Life-boatmen boarded her, weighed the anchor, and brought her safely into Iffracombe Harbour. She carried a crew of four men.—Expense of service, 3*l*. 16*s*.

March 2.—In reply to signal guns from the Gull Light-ship the Broadstairs Life-boat *Samuel Morrison Collins* proceeded to the Goodwin Sands, and found the three-masted schooner *Ocean Queen*, of Plymouth, ashore on the E. part of the Sand, with a London tug in attendance on her. The services of the Life-boat were also accepted; and eventually the vessel was got afloat and taken to Ramsgate Harbour. She had a crew of seven men.

March 2.—At 10.10 P.M. signal guns and rockets were fired by the Gull Light-ship. The *Vulcan* steam-tug and *Bradford* Life-boat went out from Ramsgate, and were informed that a large flare light had been seen on the sands. They steered in the direction indicated for some distance, when the vessel in distress was seen, and the Life-boat was slipped and sailed towards her. She was the brigantine *Fraternity*, of Krageroe, Norway, bound from Watchet to that port in ballast, with a crew of six men. The master engaged the Life-boatmen's assistance to get the vessel off the sand and into a place of safety; accordingly they went on board, clewed up and furled the sails, and then

signalled for the tug, which steamed up and attached her hawser, and after towing for a short time the vessel came afloat, and was taken into Ramsgate Harbour.

March 6.—Voted 14*l.* 7*s.* to defray the expenses of the Life-boats at Hythe, Abersoch, Deal, Montrose, Caister, Kingsdowne, Gorleston, Great Yarmouth, Carmarthen Bay, and New Brighton, in either assembling their crews or putting off to the assistance of vessels which did not ultimately require their help.

The Ramsgate Life-boat had also been taken out with the view of assisting a vessel in distress.

March 12.—At about 1 P.M., the s.s. *Lorentzen*, of London, was seen to become unmanageable, and to be fast drifting on to Whitby Rocks. As the crew were in great peril, the *Robert Whitworth* Life-boat proceeded to their aid. With great difficulty and danger the crew of seventeen men were taken off the steamer, which by that time had gone on the rocks. She was rapidly filling with water, and shortly after the crew were landed she parted amidships, and in a very few hours was a complete wreck.—Expense of service, 11*l.* 5*s.*

March 20.—The s.s. *Darlington*, of Stockton, bound from Dundee to Middlesborough in ballast, struck on the rocks at the N.E. corner of Holy Island, called False Emmanuel Head, during a dense fog. Fortunately, her signals of distress were observed, and the *Grace Darling* Life-boat, stationed at Holy Island, put off to her and brought safely ashore the crew of nine men. The steamer afterwards became a total wreck.—Expense of service, 17*l.* 10*s.*

March 23.—In the afternoon the brig *Die Manten*, of Arendal, Norway, bound thence to Leith with a cargo of pit props, arrived off Lunan Bay. The captain and two men put off from the vessel in a boat to try to ascertain where they were; but finding the sea very heavy they endeavoured to pull back again, but could not succeed. The Montrose *Mincing Lane* Life-boat thereupon put off under canvas, and rescued the three men, who were by that time about a hundred yards from the rocks at Usan, their boat being half full of water and the men much exhausted. As the vessel was then about seven miles distant, the men were taken to Montrose.—Expense of service, 12*l.* 0*s.* 6*d.*

March 24.—Intelligence having been received that a barque was ashore on the Kentish Knock Sand, and that a shipwrecked crew were on board the Knock Light-ship, which is about twenty-six miles from Ramsgate, the Ramsgate Life-boat *Bradford* and steam-tug *Aid* proceeded out to the Sand. A fresh E. gale was blowing, and the sea was heavy at the time. On arriving near, a barque was observed driving over the Long Sand. The Life-boat was slipped and sailed towards the vessel, which was found to be waterlogged and abandoned. She then sailed to the tug and was taken in tow to the lightship, steered alongside, and with great difficulty, on account of the heavy sea, succeeded in taking off a shipwrecked crew of eight men and a lad. The master stated that the barque which had been seen was their vessel, which had struck on the Galloper Sands at 8 P.M. on the previous day. They had left her at 11 o'clock on the same night, and after being four hours in the boat, made for the light-ship, but, unfortunately, in attempting to get on board, one man was drowned, their boat having been swamped alongside. The Life-boat and tug then proceeded back to the harbour, arriving at 10 P.M. The vessel was the barque *Lina*, of Tonsberg, Norway, bound from Porsgrund to London, with a cargo of deals and battens.

March 24.—The schooner *Ann*, of Colchester, was seen about 6 A.M. making for Hartlepool,

apparently in distress. When she was within about two miles of the harbour the No. 3 Life-boat *John Clay Barlow* put off to her, and found that she was leaking badly; she had by that time struck on the Beacon Shoal. The crew of five men were on the deck ready to leave when the Life-boat arrived alongside, and were taken on board the boat and safely landed at about 9 A.M. The schooner was bound from Seaham to Colchester, with coal.—Expense of service, 7*l.*

March 25.—The brig *Die Manten*, of Arendal, drove ashore on the Fife Coast, between Crail and Anstruther. On the wreck being observed among the breakers the *Admiral Fitzroy* Life-boat stationed at Anstruther put off and found there was only one man on board, clinging to the wreck. The other two men having become benumbed had lost their hold and dropped into the sea during the night. The survivor was at once taken into the Life-boat and brought safely ashore. There was a strong S.E. wind blowing, and the sea was heavy at the time.—Expense of service, 10*l.* 13*s.*

March 25.—At 7 A.M. a man arrived at Caister from Winterton, and reported that a dismasted vessel was lying just outside Hasborough Sand, and that the sea at Winterton was so heavy that the Life-boat there could not be launched. The Caister No. 1 Life-boat—the *Covent Garden*—was, with much risk and labour, more than forty men assisting, then hauled through the surf, and proceeded through a very heavy sea in the direction of Winterton. On arriving at the wreck a large steamer was found to be lying by her, but she was unable to render any assistance. The Life-boat, with great difficulty and risk, sailed alongside and succeeded in rescuing the crew, seven in number. The vessel was the brig *Cito*, of Arendal, bound thence to Calais with a cargo of deals. Her masts had been carried away, the spars, &c., hanging all about the vessel; her stern-post had been completely knocked out, and the sea was breaking heavily over her, the deck being level with, if not under, the surface of the water. On the following morning, the weather having moderated, the Life-boat again proceeded to her, and with the aid of a steam-tug, the wreck was taken to Caister and beached there.—Expense of service, 35*l.* 15*s.*

March 27.—At about 2 A.M. the Poole Life-boat was launched in reply to signals of distress shown by the ship *Mariaban*, of Greenock, which had stranded on the Hook Sand, and found that six of her crew had left her in one of their boats. The Life-boat remained by her until about 1 P.M., when the remainder of the men, eleven in number, were taken into the boat and landed at Poole at about 2.30 P.M.—Expense of service, 18*l.* 7*s.*

March 28.—At about 10 P.M. the Holyhead Life-boat *Thomas Fielden* went off in reply to signals, and found the schooner *Wellington*, of Carnarvon, in distress near the Breakwater. She had just been run into by another vessel, her bowsprit had been carried away, and her bows were considerably damaged. The Life-boat put four men on board to assist at the pumps and slip the cables, when, with the aid of a steam-tug, the vessel was taken into the Old Harbour. She had a crew of three men.—Expense of service, 10*l.* 5*s.*

April 3.—Voted 55*l.* 5*s.* to pay the expenses of the Life-boats at Ballyvaughan, New Brighton, St. Andrews, Broadstairs, Drogheda, Brancaster, Clacton-on-Sea, Queenstown, and Porthdinllaen, in either assembling their crews, or putting off in reply to signals of distress exhibited by vessels not ultimately requiring assistance.

The Ramsgate and Hartlepool Life-boats had also been taken out, but their services had not been needed.

Voted the Silver Medal of the Institution, and

a copy of the vote inscribed on vellum, to Mr. MATTHEW KYLE, Coxswain of the Holy Island Life-boats, and to Mr. GEORGE KYLE, assistant coxswain, in acknowledgment of their long and gallant services in saving life from shipwreck.

April 9.—At 10 P.M., during a strong N.E. wind and heavy sea, a large vessel was observed to be driving towards the beach at Great Yarmouth. The *Abraham Thomas* Life-boat proceeded to her, and found she was the barque *Guiseppina N.*, of Genoa, bound from Hull to Cardiff, in ballast. The Life-boat remained alongside of her until she eventually drove on to the beach, when the crew of seventeen men were taken into the boat and brought safely ashore, although in a very exhausted state. The seas were then breaking heavily over the barque, which afterwards became a total wreck.—Expense of service, 20*l.*

April 10.—At 9.30 P.M. during a heavy gale from E.S.E., the s.s. *Baroi*, of Newcastle, anchored outside the proper roadstead in Porthdinllaen Bay. The wind afterwards shifted to E.N.E., and a heavier sea sprang up, which caused her chain to part, and she then hoisted a signal of distress. The Porthdinllaen Life-boat *George Moore* promptly proceeded to her, and, after remaining by her for about two hours, brought the crew of six men ashore. The vessel, however, fortunately rode out the gale, and on the following morning the Life-boat put the men on board again.—Expense of service, 13*l.* 5*s.*

April 10.—The Cromer Life-boat was launched during an easterly gale and rough sea, and proceeded to the sloop *Hesperus*, of Copenhagen, which had shown signals of distress when about three miles from the Life-boat Station. On reaching the vessel, it was found that she was leaking badly, and that she had lost her main-boom. She was bound from Copenhagen to Hull with barley. Some of the Life-boatmen boarded her, and with their assistance she was safely taken into the Humber. In the absence of the services of the Life-boat, the vessel would in all probability have been lost.

April 11.—Signals of distress were observed in the direction of Scotstonhead, whereupon the *People's Journal* No. 1 Life-boat, stationed at Peterhead, N.B., proceeded out, and found the schooner *Sunshine*, of Wick, stranded on the rocks. The crew of three men, the master, one of the owners, and six passengers, were taken into the Life-boat and brought safely to Peterhead. When the Life-boat arrived, they were contemplating making an attempt to land in their own boat, a proceeding which, owing to the heavy surf breaking on the shore, would probably have been attended with serious loss of life. At high water a steam-tug and a pilot-boat proceeded to the vessel, and succeeded in getting her afloat, after which she was taken into Peterhead Harbour.—Expense of service, 13*l.* 18*s.*

April 11.—At 4.15 A.M. during a strong gale of wind from the east, with a heavy sea, a vessel was observed on the beach at Waxham. With all despatch the Palling No. 1 Life-boat, the *Parsee*, was launched and taken to the spot; with some difficulty she succeeded in getting alongside, and rescued the crew of twelve men from the vessel, which proved to be the Norwegian barque *Christiania*, bound from Fredericstadt to London, with a cargo of firewood. The ship broke up immediately after the crew had been rescued, and, but for the great promptitude displayed by the Life-boat men, the crew would in all probability have perished.—Expense of service, 20*l.* 17*s.*

April 19.—At 3 P.M. a schooner was seen entering Ballycotton Sound with a signal of distress flying. The pilot-boat was manned and put off,

but was driven back by the S.E. gale then blowing, without having been able to render any assistance. The Ballycotton Life-boat *St. Clair* then put off and brought the vessel to anchor, after which she returned ashore. At midnight the Life-boat again proceeded to the schooner, signals having again been shown, and placed five men on board to assist in pumping her, as she had taken the ground and was leaking. The vessel was ultimately enabled to proceed on her voyage. She was the schooner *Mary Lloyd*, of Portmadoc, bound from Rochester to Haulbowline, with cement.

May 1.—Voted 46*l.* 6*s.* 6*d.* to pay the expenses of the Montrose, Broughty Ferry, Exmouth, Piel, and Harwich Life-boats, in putting off in reply to signals of distress exhibited by vessels which did not ultimately require the services of the boats.

The Ramsgate Life-boat had also been taken out with the view of aiding a distressed vessel.

May 14.—At about 11 P.M. signals of distress were shown from a vessel in Carnarvon Bay, apparently at a distance of seven or eight miles from Porthdinllaen. The wind was blowing a strong gale from the N.N.E., and a heavy sea was running at the time. The Porthdinllaen Life-boat's crew were at once assembled, and the boat taken out, but just as she was being launched, other signals of distress were shown from a vessel close at hand; she was the schooner *Jane Ann*, of Llanellhaearn, at anchor in Porthdinllaen Bay. The Life-boat went to her, and found that she was dragging her anchor. After taking off her crew of three men, and having landed them at Porthdinllaen, the Life-boat proceeded in search of the other vessel, and at daybreak the Life-boat men observed a large barque which had evidently been embayed, and which was unable to beat out of the bay without assistance. A fishing boat, however, was in attendance on her, and as the services of the Life-boat were not required, she returned to her station.—Expense of service, 15*l.* 5*s.*

May 17.—Soon after 10 A.M. a mounted messenger arrived at Penzance with the news that a brig was ashore at Perran, five miles eastward of that port. The wind was blowing strongly from S., and the sea was somewhat heavy at the time. The rocket apparatus at Marazion was at once got out and taken to Perran, and several rockets were fired over the vessel, which was from five hundred to six hundred yards from the shore, but the crew appeared unacquainted with the method of using it, for they merely hauled in the hawser, and fastened it on board without hauling in the block. One of the men, however, got ashore over the line. A barge manned by young fishermen put off from St. Michael's Mount and went to the vessel, but the crew refused to leave her. At Penzance it was feared that the rockets could not reach her, and therefore the Life-boat was launched and proceeded under sail to the spot; she went alongside, but no notice was taken of her, the master being unwilling for the crew to leave the ship. The sea, however, was gradually increasing, the wind veering to the west, and the vessel was in a most dangerous position, she being in the breakers, full of water, and surrounded by rocks. The Life-boat remained by her for some considerable time, and finally five of the sailors got into the boat, leaving the master alone on board. He positively declined to leave the vessel. The boat then rowed off some distance to seaward, and after waiting some time, the wind continuing to veer to the westward, and the sea increasing, they returned to the brig, and the captain was again urged to come on board. He still refused to do

so, and as the boat had been struck by several heavy seas which nearly filled her, and three oars had been broken, it was thought advisable to return ashore with the five Frenchmen. The five rescued men were accordingly safely landed at Penzance. Soon after the boat left the wreck, Commissioned Boatman GOULD, of H.M. Coast-guard, who was with the rocket apparatus, volunteered to undertake the perilous duty of going out along the rocket line with a letter from the French Vice-Consul urging the captain to leave the vessel. He succeeded in getting under the bows of the brig; but the master still determined to remain where he was, and GOULD, who had been washed away from the rope by the heavy seas and nearly lost, was hauled back to shore in a most exhausted state. Meanwhile the vessel was fast breaking up, the masts fell over the side, and the master, who had by that time taken refuge in the rigging, was hurled down and buried in the *débris*. For some minutes it was feared that he was lost, but he was then seen amongst the wreckage, and eventually got hold of the foreyard, the sail on which somewhat sheltered him. The coastguard then fired more rockets over the wreck; the captain seized the line attached to one of them, with great difficulty he then hauled off a life-buoy from the shore, and placing himself in it, he was hauled ashore. On his nearing the land the coast-guard men formed a line hand in hand, waded as far as they could into the surf, and when he got within reach they firmly grasped him and brought him safely ashore. After landing the five men the Life-boat was again on her way to the wreck to make another effort to induce the master to avail himself of the services of the boat, when she was recalled by signals indicating that he had been rescued.

The vessel proved to be the French brig *Ponthieu*, bound from Pomaron to Liverpool with a cargo of iron ore.—Expense of service, 22l. 3s. 10d.

June 5.—Voted 61l. to defray the expenses of recent launches of the Porthdinllaen, Watchet, Porthleven, Walmer, Deal, Kingsdowne, and Lizard Life-boats, with the view of helping vessels in distress, which, however, did not eventually need their services.

The Ramsgate Life-boat had also been taken out with the view of aiding a vessel in distress.

June 15.—The Lizard Life-boat proceeded to the aid of the brig *Scotseraig*, of Dundee, which had grounded directly below the Lizard light-houses during a thick fog. After some hours' labour the vessel was extricated from her perilous position and was enabled to resume her voyage. She was bound from Falmouth to Greenock with rum and sugar. She carried a crew of nine men.

June 21.—The Looe Life-boat was launched, it having been proposed to lay the foundation stone of the Eddystone new lighthouse on this day. As the weather was very stormy, it was feared that some accident might occur to vessels which would go to witness the proceedings; but the Life-boat's services were not eventually needed, as the ceremony had to be postponed.

July 1.—A gale from E.S.E. sprang up at Newbiggin-by-the-Sea, Northumberland, at about 4 A.M. Seven fishing cobles had left about four hours previously for the fishing-ground, which is about fifteen miles from the shore, and considerable anxiety was felt for their safety, a heavy ground sea having set in. The Newbiggin Life-boat *William Hopkinson of Brighouse* was launched at 9.30 A.M., before any of the cobles were in sight, and remained in a very heavy sea off the point, for three hours, assisting the boats as they came in one by one until all had got safely ashore.

July 7.—The Porthdinllaen Life-boat, *George*

Moore, went out in reply to signals of distress, during a W.N.W. wind and rough sea, and remained by the schooner *Weaver*, of Carnarvon, until she was out of danger, she having stranded near Llanaelhaiarn.—Expense of service, 15l. 6s.

July 13.—At about 11.30 P.M., during a strong N.E. wind and moderate sea, the pilot smack *Marion*, while cruising between Lamlash and Ailsa Craig, had her jib carried away; she afterwards stranded on the Carlin Rock, off Kildonan, Isle of Arran, N.B. The Life-boat *Hope*, stationed at Kildonan, put off to her assistance, and brought ashore her crew, consisting of two men.—Expense of service, 13l. 14s.

July 20.—At 7 P.M. the Porthdinllaen Life-boat was launched during a very heavy N.W. gale, in response to signals of distress shown from the schooner *Adroit*, of Aberystwith, at anchor in Porthdinllaen Bay. At the request of the master, his wife, who was very ill, and a little boy, were taken into the Life-boat, and landed at Porthdinllaen.—Expense of service, 6l. 8s. 6d.

July 20.—The Rhosneigr Life-boat *Thomas Lingham* proceeded to the assistance of the barque *Zephyrus*, of Plymouth, which had struck on the rocks at Cymyran, near Rhoscolyn, during a strong S.S.W. wind and heavy sea. The vessel's crew, fourteen in number, had placed their luggage in the long-boat, and intended coming ashore in her, but as this would have been attended with some risk, they were taken on board the Life-boat; their boat was taken in tow, and all were brought safely ashore.—Expense of service, 18l. 2s.

July 21.—The *Mincing Lane* Life-boat, stationed at Montrose, N.B., rendered some assistance to the Dutch fishing-smack *Nooit Polmak*, which had gone too far to the northward while running for the harbour, and had stranded on the Annat Bank during a fresh E.N.E. wind and heavy sea.—Expense of service, 8l. 2s. 6d.

Aug. 7.—Voted 57l. 11s. to pay the expenses of the Life-boats at Porthdinllaen, Appledore, Braurton, Porthoustock, Queensdown, and Broadstairs, in assembling their crews, or putting off to the aid of vessels which did not eventually require assistance.

Voted a binocular glass and 10l. to Mr. BENJAMIN HERRINGTON, who had lately resigned the office of Coxswain of the Southold Life-boats, in acknowledgment of his valuable services during the past forty years, in which period he had assisted to save one hundred and sixteen lives from various wrecks.

Aug. 13.—On the 13th August, during a fresh wind from the S.E., the *British Workman* Life-boat at Palling, Norfolk, was launched to the assistance of the barque *Zurich*, of North Shields, which had stranded on Hasborough Sands. The Life-boat remained alongside until the vessel began to break up, when the crew of fifteen men, and the master's wife, were taken into the boat and landed at Palling. The barque was on a voyage from North Shields to Spezzia, with a cargo of coal and coke.—Expense of service, 11l. 16s.

Aug. 19.—The Looe and Plymouth Life-boats were present at the ceremony of laying the foundation stone of the Eddystone new lighthouse by their Royal Highnesses the Prince of WALES and the Duke of EDINBURGH.

Aug. 21.—During a strong wind from the S.W. and a rough sea, the yacht *Y. Deryon*, of Carmarthen, was observed to be dashed and in dangerous proximity to the Langharne Sands, Carmarthen Bay. The Life-boat *City of Manchester*, stationed at the Ferryside, went out to her, and found that her mast was broken off

about twelve feet above the deck; the crew had, however, succeeded in setting a small sail to the remains of the mast, and had weathered the Sands. At the request of the crew of the yacht, the Life-boat then accompanied her, and indicated the best position to take the beach, and that having been safely accomplished, those on board were helped ashore.—Expense of service, 8*l.* 12*s.*

Aug. 25.—At about 3 A.M. signals were shown from the Gull Light-ship, and the Ramsgate Life-boat *Bradford*, in tow of the steam-tug *Aid*, and the *Van Kook* Life-boat, stationed at Deal, proceeded to the Goodwin Sands. The wind was blowing fresh at the time from the S.W., and a heavy sea was running. On arriving at the Sand, the barque *Mia Madre E.*, of Genoa, was found ashore there, with some London steamers and a Deal boat close at hand. The Life-boats remained by the vessel, their crews assisting to lighten her by discharging some of her cargo of wheat. On the tide flowing, the steamer *Aid*, which had returned to Ramsgate, again came out, and, in conjunction with the other steamers, made repeated attempts to tow the vessel off the Sands. The towing-hawsers frequently broke, but were again made fast to the barque, and every effort was used to save her; it was, however, found hopeless, and, as she was leaking badly, and all her pumps had been disabled, it was eventually decided to abandon her. The master and thirteen men, with the Italian Vice-Consul, were accordingly taken into the Ramsgate Life-boat, and the mate, one seaman, and four Deal boatmen into the Deal Life-boat, and all were safely landed. The barque was of 892 tons register, was bound from Baltimore to Hull, and ultimately became a total wreck.—Expense of service, 18*l.*

Aug. 27.—In the afternoon the coxswain of the Swansea Life-boat received a telegram stating that three vessels were ashore between Swansea and Neath. The wind was then blowing a gale from the W.S.W., and the sea was rough. The *Wolverhampton* Life-boat was promptly launched, and proceeded to the spot. She first reached the schooner *Glena*, which had stranded, but the master and crew decided to remain by their vessel, as the tide would allow them to walk ashore at low water. The boat then proceeded about half a mile further to leeward, and went alongside the brig *Queen of Britain*, of Carnarvon, and succeeded in taking off her crew, consisting of six men. By that time the third vessel had driven well in shore, and the crew were saved with some assistance from those on the beach. The Coastguard boat was launched from the Mumbles at the same time as the Life-boat, but was compelled to put back as she was unable to contend against the heavy sea running at the time. The gale was very severe, and the Life-boat crew did their work nobly. A large crowd of people assembled on the Swansea Sands to witness the return of the boat, by whom the crew were loudly cheered.—Expense of service, 10*l.* 19*s.*

Aug. 29.—At about 5 A.M. it was reported that a vessel was in distress on Bernard's Wharf, a sandbank situated about 2½ miles E.N.E. of Fleetwood, and the Life-boat *Edward Wasey*, which is stationed at Fleetwood, was accordingly launched. On reaching the spot she found the schooner *Elizabeth Ellen Fisher*, of Fleetwood, bound from Ardrossan to Fleetwood with a cargo of pig-iron, had stranded on the sand. It was hoped that the rising tide would float her off again, and the Life-boat therefore remained by her for nearly an hour. However, the schooner began to fill with water, and her crew, numbering four men, were then with some difficulty taken into the Life-boat and landed at Fleetwood. The wind was very squally from

the N.W., and the sea was running heavily.—Expense of service, 6*l.* 12*s.* 6*d.*

Sept. 4.—Voted 62*l.* 14*s.* 8*d.* to pay the expenses of the Southport, Rhyl, Cahore, Kingsdowne, Walmer, and Barmouth Life-boats, in either assembling their crews, or putting off in reply to signals of distress exhibited by vessels not ultimately needing their assistance.

Sept. 6.—The *Joseph Armstrong* Life-boat, stationed at Cadgwith, Cornwall, went out twice and rescued forty persons from the Cunard steamer *Brest*, of Glasgow, which, while on a voyage from Havre to Liverpool with a large number of passengers and a general cargo, went ashore between Cadgwith and the Lizard during a fog. Several shore boats also put off to the vessel and rescued the remainder of the passengers; the crew were saved by means of the ship's boats.—Expense of service, 14*l.* 2*s.*

Sept. 9.—The Cardigan Life-boat *John Stuart* with some difficulty brought ashore the crew, consisting of three men, of the schooner *Ellen*, of Beaumaris, which had parted her cables during a heavy N.W. gale and tremendous sea near Quay Bach, in Cardigan Bay. The vessel, however, rode out the gale, and on the following morning the crew went on board again.—Expense of service, 7*l.* 1*s.*

Sept. 23.—At about 1 A.M., a southerly gale suddenly sprang up at Blyth, Northumberland, increasing in violence until about 3 o'clock, when it became very severe. A large fleet of fishing-boats which had gone out during the night to follow the herring fishery, the weather being then very fine, and there being every prospect of a successful night's fishing, were caught by the storm, and at about 4.30 the whole coast was lighted up for two or three miles with signals of distress, and the wives and relatives of the fishermen were in a state of great tribulation. The Life-boat *Salford* was promptly launched, and proceeded first to a signal on the Seaton Sea Rock, and found the coble *Sons of the Wear*, of Sunderland, on the rock. Her crew of four men, who were in great danger, were taken into the Life-boat and landed. The Life-boat then again went out, rendered assistance to several other boats, and towed one disabled coble, with a crew of six men on board, safely into the harbour.—Expense of service, 6*l.*

Sept. 23.—In the morning a heavy gale sprang up at Newbiggin, accompanied by a very rough sea. About fifty-two of the herring-boats were then out at sea, but several of these landed; others, however, held on by their nets, hoping that the gale would abate. The storm still continued, and as the boats were in much danger, the Life-boat was launched and proceeded to their assistance, and remained by them until all, with one exception, were safely landed. This one boat dragged her anchors and drove on the rocks. In order to launch the Life-boat the women of the place had to lend a hand, on account of so many of the men being away at the time, and they waded up to their middle in order to get the boat well and speedily afloat from its carriage. About an hour afterwards the Life-boat again went out and rescued the crew, consisting of seven men, from the schooner *Union T.*, which struck on the Out Carr Rocks, north of Newbiggin Point. The master had cut away the foremast, and endeavoured to get the vessel off the rocks; but all efforts to do so failed, and as she began to leak he signalled for the Life-boat. The vessel, which was on a voyage from Calais to Warkworth Harbour in ballast, became a total wreck.—Expense of service, 10*l.* 10*s.*

Oct. 2.—Voted 99*l.* 3*s.* to pay the expenses of the Kingstown, Brightstone Grange, Flamborough, Clacton-on-Sea, Howth, Harwich, and Peterhead Life-boats in assembling their crews or putting off

in reply to signals of distress shown by vessels not ultimately needing the aid of the Boats.

The Ramsgate Life-boat had also been launched twice to the aid of distressed vessels, but her services had not been eventually required.

Oct. 7.—In the afternoon the s.s. *Arabian*, of Liverpool, bound from Liverpool to Gibraltar with a general cargo, went ashore about a mile and a half westward of the East Mouse, near Bull Bay, during a dense fog. The Bull Bay Life-boat *Eleanor* proceeded to the vessel and remained by her at the request of the captain until she was got afloat at about 1 o'clock on the following morning. After going out to sea with the steamer, the Life-boat had great difficulty in finding her way back to her station, on account of the density of the fog.—Expense of service, 14*l.* 6*s.*

Oct. 8.—The schooner *Haleswell*, of Bridgwater, went ashore outside the Harry Furlongs Rocks, off the Anglesey coast, during a fog. She was observed at 7 A.M., and a boat came ashore from her with two of her crew to ask for the assistance of the Life-boat. The Cemlyn Life-boat *Good Shepherd* went out to her aid, and rendered material assistance in carrying out the anchors and tugging at the vessel, and at about 3 o'clock in the afternoon the schooner was got afloat. She was on a voyage from Liverpool to Bridgwater with coal.

Oct. 15.—At about 1 P.M. the *Augusta* Life-boat, stationed at St. David's, Pembrokeshire, was launched, it having been reported that the brigantine *Messenger*, of Exeter, bound from Teignmouth to Runcorn with a cargo of clay, had had all her sails blown away on the previous night, and was drifting down towards the north end of Ramsey Sound. The tide was very strong at the time, and a strong N.N.E. breeze was blowing. The brigantine struck on a rock called Wain Garrig, about two miles to the north of Ramsey Island. Three of her crew managed to get on the rock, but the vessel then slid off with the master and two men on board, and drifted down to the west of Ramsey Island. The Life-boat proceeded towards the rock, and, after a hard pull against wind and tide, succeeded in taking the men off and landed them at St. Justinian. The Life-boat then proceeded to Ramsey Island, but could not find the vessel. It was subsequently found that she had made for Milford Haven, but foundered when about half-way. The captain and two men landed safely at St. Anne's Head, at the entrance to Milford Haven.—Expense of service, 8*l.* 1*s.*

Oct. 27.—At about 10.15 A.M. a telegram was received at Queenstown from the Coastguard Station at Robert's Cove, stating that a yacht was in distress off Cork Head. The *Quiver* Life-boat was promptly launched, and proceeded, in tow of a steam-tug, through a heavy sea to the vessel, which proved to be the yacht *Gilded Age*. On reaching her it was found that she had lost her rudder and both anchors, and had been dismasted. Her crew of three men were taken into the Life-boat, which also assisted to save the yacht, she being towed into harbour.—Expense of service, 9*l.* 8*s.*

Nov. 1.—During a strong gale from E.N.E. signals were observed from a vessel which had stranded on the Dogger Bank. The Wexford Life-boat *Civil Service No. 1* was immediately launched, and proceeded to render assistance. On arriving alongside the vessel, she was found to be the lugger *Liberator*, of Wexford; she was riding to her anchor, with her rudder carried away, her crew having succeeded in getting her off the bank by means of the anchor and cable. She had a crew of six men, and had on board the gunner of the Tuskar Light-house, who was being taken ashore in consequence of being ill. He was taken

on board the Life-boat and landed at Wexford. The crew refused to leave their vessel, but she shortly afterwards dragged her anchor and went ashore.—Expense of service, 13*l.* 17*s.*

Nov. 6.—Voted 62*l.* 18*s.* to pay the expenses of the Life-boats at Carnsore, Wexford, Porthdinllaen, Wells, Maryport, Rhyl, Mullion, and Arklow, in assembling their crews or putting off with the view of assisting vessels which did not ultimately need the aid of the boats.

Nov. 11.—At about 5 P.M. the smack *Menai Packet*, of Carnarvon, bound from Swansea to Newry, with coal, which was riding at anchor in Porthdinllaen Bay, showed a signal of distress. As the wind was not blowing very strongly at the time, a shore-boat went off to her and found that she had lost the stock of one anchor, and required the loan of another anchor. The shore-boat then returned ashore to get one; but by the time it had been procured, a strong N.N.W. gale had sprung up, accompanied by a heavy sea. As it was then unsafe for the shore-boat to venture out alone, the Porthdinllaen Life-boat *George Moore* was launched, and took the boat in tow. On getting alongside, the captain requested the boat's crew to re-moor the vessel. Having done this, and the gale increasing, the crew, consisting of three men, begged to be brought ashore; they were consequently taken into the Life-boat and landed at Porthdinllaen. The smack, in the course of a few hours, parted her chains and came ashore.

After watching during the night, the coxswain of the Life-boat observed at 8 o'clock on the following morning a signal of distress, displayed from a schooner at anchor in the Bay. The wind was still blowing a heavy gale from N.N.W., and the sea was heavy. The Life-boat, which had been kept in the water, was at once manned, and again proceeded out, and found the schooner *Mary Roberts*, of Nefyn, had parted one chain, and was riding heavily to the other. The crew, consisting of five men, were afraid that the vessel would strike on the ebb, and therefore wished to be brought ashore. They were accordingly taken on board the Life-boat and safely landed.—Expense of service, 7*l.* 10*s.*

Nov. 11.—At 3 A.M. signal rockets were fired from the Gull Light-ship, and were answered by a rocket from Ramsgate pier-head. The Ramsgate Life-boat *Bradford* and steam-tug *Aid* were at once manned, left the harbour at 3.15, and proceeded towards a large flare light on the N.W. part of the Goodwin Sands. On arriving abreast, the Life-boat was slipped and made sail for the light, but took the ground about half a cable's length from the distressed vessel. The Life-boatmen then hailed the crew, and told them they would come alongside directly the tide flowed, and that the steamer would assist to get her off. On the Life-boat floating, she attempted to get alongside, but as the vessel was lying in a swatchway, and the tide was running very strong to S.W., it was some time before she succeeded in getting to her. In the meanwhile a Deal galley rowed alongside. At about daylight the Life-boat was able to put a man on board. As the tide flowed, the vessel floated and drove in more on the shoal part of the sand; her anchor was then let go, but the chain parted, and although her other anchor was let go, she still continued driving in and striking heavily. The master then seeing the dangerous position of his vessel, hailed the tug to come to his assistance. The *Aid* then backed in as near as possible to her, and took her tow-rope on board; the chain was slipped, and she was towed clear of the sand and into Ramsgate, arriving at about 8.30 A.M. The vessel was leaking very badly, and the pumps were kept constantly going in order to keep her afloat.

She was the schooner *Albion*, of Wells, bound from Llanely to Wells, with a cargo of coal. She had a crew of three men.

Nov. 12.—At about 11.40 A.M. the brig *Lavinia*, of Guernsey, bound thence to Sunderland, in ballast, was seen to be between the Scroby and Cross Sands with colours flying union downwards. The Caister Life-boat *Covent Garden* proceeded to her assistance, and found her riding with both anchors down, but one cable had parted; she had three feet of water in her hold, and her ballast had shifted to the lee side. The Life-boatmen dared not board the vessel while at anchor, the sea being too heavy, they therefore shouted to the crew to slip the cable, and boarded her while under weigh. The brig was taken between the Scroby and Cross Sands, a steam-tug was engaged, and she was towed into Yarmouth Harbour. She had stranded on the Hasborough Sands on the previous night.

Nov. 12.—At about 8 A.M. signals of distress were seen to be shown by a schooner at anchor in Scarborough Bay during a very strong N. gale. The Life-boat *Lady Leigh* was immediately launched and proceeded to the vessel, which proved to be the *Alert*, of Scarborough, which had left that port on the previous day in ballast to proceed to the North for coals. Her crew, consisting of two men, were very anxious to be taken off, and with considerable difficulty, as the tide was low, and the waves were very high, they were taken into the Life-boat and brought safely ashore.

After landing these men, the smack *Hester*, of Ipswich, was seen to be in extreme peril riding amongst the breakers, with a signal of distress flying. The Life-boat at once proceeded to her assistance, and having placed two men on board, managed to get two warps from the pier, and attached them to her, by which means she was then hauled into the harbour with assistance from those on the pier.

The Life-boat afterwards went out a third time, and proceeded again to the *Alert*, in tow of a steam-tug. The gale had by that time somewhat abated, and two of the Life-boatmen having been put on board, the anchor was slipped, and she was safely towed into harbour.—Expense of service, 10*l.* 10*s.*

Nov. 13.—At about 4 A.M. signals of distress were perceived on Skullmartin Reef. The Ballywalter Life-boat *Admiral Henry Meynell* was promptly manned and proceeded to the reef, where she found the schooner *Lady Land*, of Glasgow, which had struck there while under a press of canvas. There was a heavy sea rolling in from N.E., and as the vessel was striking heavily, the crew of six men were taken into the Life-boat and brought ashore.—Expense of service, 13*l.* 12*s.*

Nov. 13.—Signals of distress were seen in a N.E. direction, and rockets were fired from the St. Nicholas Light-ship, in response to which the Gorleston Life-boat *Leicester* was launched, and found the *Violet* trawling smack had been in collision with the schooner *Evelyn*, of Fraserburgh. The wind was blowing hard from N.N.E., with considerable sea, and the crew of the *Violet* had abandoned their vessel, thinking she would founder, and had gone on board the *Evelyn*. The smack had already, on the same night, met with an accident, and was leaking badly. The Life-boat slipped the schooner's chain, and after clearing the two vessels, put the *Violet's* crew on board their own craft, remained by her until daylight, and then assisted her into the harbour.

Nov. 14.—At about 2.30 A.M. two flares were seen on the Scroby Sand, and rockets were fired from the St. Nicholas Light. The Gorleston

Life-boat immediately put off, and on reaching the Sand a vessel was discovered sunk, with the crew on the mast and in the rigging. The Life-boat anchored and veered down until under the mast of the wreck, from which the crew, consisting of five men, lowered themselves into the boat. They had been three hours and a half in the rigging, and were much exhausted; in fact, it was feared that one of them would have died, but he happily recovered after reaching the land. On hauling the Life-boat off, after the last man was saved, the cable parted, the boat having been struck by a heavy sea. Fortunately she was then clear of the wreck; had this happened a few minutes sooner the consequences would probably have been very serious to the Life-boat, and no doubt fatal to any of the men left in the rigging of the wreck. The water was very shallow on the Sand, and the sea very heavy, the Life-boat being many times filled with water. The wrecked vessel was the *Ann Wilmot*, trawling smack, belonging to Lowestoft.—Expense of service, 15*l.*

Nov. 20.—The *Reliance* fishing-coble, which had gone out from Cullercoats at 4 A.M. for the purpose either of piloting or fishing, was returning to the harbour at about 9.30, by which time the sea had much increased, and it was considered dangerous for her to attempt to cross the bar. The Cullercoats Life-boat *Palmerston* was therefore launched, and accompanied her in.

Nov. 20.—During a heavy breeze from the E., rockets were observed in the direction of Foulness Shoal, or Cromer Rock, about two miles to the eastward of Cromer. The Cromer Life-boat was launched during a heavy snowstorm, at about 5.30 A.M., and proceeded in the direction of the ship's lights, which were then visible. The tide running to leeward it was some time before the boat could reach the vessel; but on arriving alongside she was found to be the s.s. *Moidart*, of Glasgow, bound from the North of England to Odessa with railway iron. The steamer was fast on the shoal, and the sea was making a clean breach over her at times. As the tide flowed, she fortunately floated off, and was brought up at anchor in deep water, but in a disabled state, having lost her rudder and part of her sternpost. The captain requested the Life-boat to remain by the steamer until a tug, or other assistance, came from Yarmouth, and the Boat therefore stayed by her until about 12.30, when she was compelled to leave and go ashore, on account of the state of the tide. A good look-out was kept from the shore during the night, as the gale increased, and at daylight the Life-boat again went off, and remained by her until steam-tugs arrived and towed her away.—Expense of service, 33*l.* 10*s.*

Nov. 25.—At about 7.15 A.M. the Ramsgate Life-boat and steamer again proceeded to sea in reply to signal guns fired from the Gull Light-ship. A large barque was seen to be ashore on the N.E. part of the Goodwin Sands, to which the Life-boat and tug steered, and, on arriving near, the Life-boat was slipped, and sailed towards her. On getting alongside, she was found to be the barque *Osprey*, of Arendal, bound from that port to Plymouth, with timber. The master at once engaged the services of the Life-boat and tug, and the steamer then backed in, put her tow-ropes on board, and commenced towing, the vessel striking very heavily on the sand. After towing for about half an hour, it being then nearly high water, the services of the *Ulysses* steam-tug were also engaged. After towing for about an hour the vessel was got afloat, assisted by her fore and aft sails, which had been set by the Life-boat crew. She was then towed round the North Sand Head, and through the Gull stream to an anchorage in the Downs.

Nov. 25.—A heavy gale of wind from E.S.E. sprang up in the morning at Scarborough, causing a very heavy sea. At about 10 o'clock eight Scotch fishing-vessels, on their way from Yarmouth fishing-grounds to Scotland, were seen running for Scarborough, seeking refuge; and as the sea was mostly broken water, and the vessels were open boats, containing a large number of men, the Life-boat was launched and proceeded to protect and guide them into the harbour, where they eventually arrived in safety by about 12.30 P.M.—Expense of service, 8*l.* 4*s.*

Dec. 1.—At 4 P.M. the *British Workman* Life-boat, stationed at Palling-by-the-Sea, Norfolk, proceeded out during a strong E.S.E. wind and heavy sea, to the aid of a vessel which was signalling for assistance. The vessel proved to be the barque *Onward*, of London, bound from Hartlepool to the East Indies, with coal. As she was in a very leaky condition, having been ashore on the Leman and Ower Sands, the Life-boat, at the request of the master, assisted to take her into Yarmouth Roads. She had a crew of sixteen men.

Dec. 2.—Four fishing-cobles were observed to be making for Whitby harbour, and as the wind and sea increased, the *Harriott Forreath* Life-boat went out, supplied the crews of the cobles with Life-belts, and attended each of the boats over the bar. By the time the cobles and Life-boat had got safely in, the wind and sea had risen to a great height.

Dec. 4.—Voted 12*l.* 3*s.* 2*d.* to pay the expenses of the Life-boats at Walmer, Donna Nook, North Sunderland, Great Yarmouth, Withernsea, Kingsdowne, Deal, and Southend (Essex), in assembling their crews or putting off with the view of rendering assistance to vessels not ultimately needing their aid.

The Ramsgate Life-boat also put off to the aid of a distressed vessel, but her services were not eventually required.

Voted the Silver Medal of the Institution to Mr. GEORGE MARKWELL, formerly Coxswain of the Holy Island Life-boat, in acknowledgment of his generally valuable and brave services in saving many lives from shipwreck.

Dec. 21.—At 2.15 A.M. a vessel was reported to be stranded in Churchtown Bay. The Carnsore Life-boat *Iris* proceeded there promptly, and found the barque *Cheverest*, of Havre, ashore there. The wind was blowing from the S.E., accompanied by a rough sea. The master at first refused to leave his ship, and requested the Life-boat to remain alongside; the Boat accordingly stayed by her for about two hours, but as the sea was then getting very heavy, the master, the crew, consisting of twelve men, and the pilot, decided to abandon her, and were brought safely ashore in the Life-boat. The barque, which was on a voyage from Africa to Glasgow with dye-wood, became a total wreck.—Expense of service, 20*l.* 15*s.*

Dec. 28.—About 1 o'clock a gun from the South Sand Light-ship, on the Goodwins, distant about seven miles from Deal, gave warning that a ship was on the dreaded sands. It was blowing a whole gale from the S.W., and vessels even in the comparative shelter of the Downs were riding at both anchors. Just then, in answer to the boom of the distant gun, the bell rang to man the Life-boat, and the Deal boatmen gallantly answered to the summons. There were three vessels on the Goodwins. The crew of one took to their boats, and not being on the worst part of the Sands, got safe round the North Foreland to Margate. Another schooner, supposed to be a Dane, disappeared and was lost with all hands. The third, a German barque, the *Leda*, with a crew of seventeen "all told," was stuck fast on the worst part of the Sands, viz., the South Spit, on which even on a fine day there is a dangerous and peculiar boil or tumble of seas.

The barque's main and mizzen masts by this time were gone, and the crew were clinging to the weather bulwarks, while the sea made a clean breach over them—so much so that from cold and long exposure the captain was almost exhausted. The Deal Life-boat fetched a little to windward of the devoted barque, and dropping anchor, veered down on her. One cable being too short, another was bent to it, and closer and closer came the Life-boat. If the cable parted and the Life-boat struck the ship with full force, not a man would probably have survived to tell the tale; or if they got to leeward of the barque the crew of the wreck would have been lost, as the Life-boat could not again have worked "to windward" to drop down as before. No friendly steam-tug was at hand to help the boat again to windward in case of failure in their first attempt, and both the crew in distress and their rescuers were well aware of the stake at issue, and that this was the last chance. But the Life-boat crew said, "We're bound to save them," and with coolness, yet "daring all that men dare do," they concentrated their energies on getting close enough to the wreck to throw their line, and yet to keep far enough off to ensure the boat's safety. They were now beaten and hustled by the tremendous seas breaking into and over them, and no other boat could have lived a moment in the cauldron of waters seething and raging around them. Notwithstanding the self-emptying powers of the Life-boat, the seas broke into her in such quick succession that she was and remained full up to her thwarts, while near the vessel, and as each cataract came on board the coxswain sang out, "Look out, men," and they grasped the thwarts and held on with both hands, breathless for dear life. One sea hurled the Life-boat against the ship, and stove in her fore air-case, so that the safety of all made it necessary to sheer off. Another sea prostrated two men under her thwarts. The Life-boat's heaving-line and grappel was at last got on board the barque, and communication being established, the crew were drawn on board the Life-boat through the raging waves by ones or twos, as the seas permitted. Thus saved from the jaws of death, so astonished were the rescued crew at the submerged condition of the Life-boat and the awful turmoil of water around them that some of them wished to get back to their perishing vessel, but the coxswain and crew knew the powers of their gallant boat. "Up foresail and cut the cable," and with its goodly freight of thirty-four souls, the Life-boat, hurled like a feather, sometimes dead before the wind, and the next moment "taken aback," plunged into the surf for home. One of the rescued crew had twice before been saved by the same boat, and encouraged his comrades with a recital of his previous deliverances. And so at last, exhausted, but gloriously successful, they landed the staggering and grateful Germans on the Deal beach, where, despite the storm, crowds met them with wondering and thankful hearts.—Expense of service, 17*l.* 2*s.* 6*d.*

Dec. 28.—At 4 A.M. large flares were seen in the direction of the Cross Sand. The Caister Life-boat *Covent Garden* was launched, and proceeded to the Cross Sand, on which a very heavy sea was running, and found a brig ashore on the Sand. The boat's anchor was let go, but she could not reach the vessel; the position of the anchor was then shifted, and the crew, consisting of eight men, were fortunately rescued, the sea breaking over the brig as high as the foretop, and over the boat the whole time. She proved to be the *Rival*, of Blyth, bound from Gravesend to Newcastle in ballast.—Expense of service, 25*l.*

Dec. 31.—Voted 194*l.* 6*s.* 6*d.* to pay the expenses of the Life-boats at Sunderland, Whitby,

Caister, Carnsore, Winterton, Brighstone Grange, Broadstairs, Kingsdowne, Great Yarmouth, Queens-town, Banff, Cullercoats, Porthdillacn, Mullion, and Portrush, in either assembling their crews or putting off in reply to signals of distress shown

by vessels which did not ultimately require the aid of the boats.

The Ramsgate Life-boat had also proceeded to the assistance of distressed vessels, but her services had not been eventually needed.

SHORE-BOAT SERVICES REWARDED IN 1879.

Jan. 2.—Voted the Silver Medal and 1*l.* to Mr. JAMES MACKAY for saving two boys by swimming at great risk to a boat, which had been swamped while attempting to cross the Bar of Tongue, Sutherland, in a fresh gale and heavy sea, on the 16th November; 2*l.* 10*s.* were also granted to five men who put off in a ferry-boat and tried to rescue the boys.

Jan. 10.—Mr. P. KENNEDY, Chief Boatman in charge of H.M. Coastguard at Warren Point, co. Down, and three others, put off in a boat and saved seven persons from the barque *Nelson*, of Maryport, which had capsized in Warren Point Roads, during a gale from the S.E.—Reward, 4*l.*

Jan. 16.—Two fishermen of Ilfracombe rescued two men, whose boat had upset off that place, during a fresh E. wind. One of the rescued men unfortunately died soon after being landed, from the effects of the immersion in the water.—Reward, 1*l.*

Jan. 17.—Five men put off in a boat and, at risk of life, saved five men from the lugger *Friends*, which had stranded at the mouth of North Bay Harbour, Inverness, during a strong S.E. gale.—Reward, 5*l.*

Jan. 21.—Mr. DENNIS CONNOR, Chief Officer of H.M. Coastguard at Rosslare, Ireland, and his crew of eight men, put off in their boat and saved the crew of twelve men from the barque *Hellen*, of Liverpool, which had stranded near Rosslare during a strong wind from the S.E.—Reward, 10*l.*

Feb. 6.—Voted the Silver Medal of the Institution, a copy of the vote inscribed on vellum, and 1*l.*, to Mr. WILLIAM WEST, Chief Boatman in charge of H.M. Coastguard, and 6*l.* 10*s.* to his crew, for saving, at considerable risk, five of the crew of the schooner *Marie Louise*, of Gothenburg, which was wrecked at Dymchurch, Kent, during a fresh E.S.E. gale, on the 8th January.

Also the Silver Medal of the Institution, a copy of the vote inscribed on vellum, and 1*l.*, to HENRY STEVENS, gunner, 10th Brigade Royal Artillery, for swimming out twice, at very great risk, to the brigantine *Princess Royal*, with the view of saving some of her crew, that vessel having been wrecked at Camden Fort, near Cork, on the night of the 24th December.

Also 2*l.* to the Master of the steam-tug *Nelson*, and 10*s.* each to his crew of nine men, for rescuing nineteen men from the barque *Charles Challoner*, of Fleetwood, Lancashire, which had stranded on Barnard's Wharf, near Fleetwood, during a fresh gale, on the 18th September.

Also 3*l.* to six men for putting off in a boat from Southwold, Suffolk, and saving ten men from the brig *Cowen*, of South Shields, which had struck on the Kentish Knock Sands, during a strong S.W. wind, on the 31st December.

Also 2*l.* 10*s.* to three men for saving three men from a ship's boat which had been capsized between Knightstone and Anchor Head, in Weston Bay, on the 21st December.

Also 2*l.* to eight men for putting off in a boat and saving the crew of seven men of the brig-

antine *Margaret*, of Rye, which was wrecked on Blakeney Sands, off the coast of Norfolk, on the 15th December.

Feb. 15.—Five men put off in a boat and saved three men from a fishing-boat which had been upset by a sudden squall near the Coastguard Station at Greencastle, co. Londonderry.—Reward, 2*l.*

March 6.—Voted the thanks of the Institution to Mr. F. S. PERRY, Mr. HORATIO E. PRITCHARD, Mr. W. LEIGH, and Mr. J. ELFORD SMYTHE, for wading into the sea, and, at considerable risk, assisting to save the crew of four men of the French lugger *Ange*, which was wrecked at Porthcurnow Sands, Cornwall, during a S.S.E. gale and heavy sea on the 1st February.

March 12.—Three Penmon pilots put off in a boat and saved the crew of five men from the brigantine *Hawendale*, of Aberystwith, which sunk on the Prince Regent Rocks during a strong N. wind and heavy sea.—Reward, 3*l.*

March 20.—Some Newbiggin men put off in a coble from that place, and rescued the crew of seven men from the wrecked schooner *Carl*, of Holmestrand, Norway, during a strong S.S.E. wind.—Reward, 3*l.* 5*s.*

March 28.—Five men saved a man from a boat which had been water-logged in Galway Bay, during squally weather.—Reward, 3*l.*

April 3.—Voted the thanks of the Institution to EDWARD HUMBY, of H.M. Coastguard at Southsea, for rescuing from the water and restoring a woman who was apparently drowned, she having rushed into the sea from Southsea beach on the night of the 14th March.

April 9.—JOHN and THOMAS BOUND saved a man whose boat had sunk after striking on the Munkston Rock in the Bristol Channel. He took refuge on the rock, but he was in great danger there, as the flowing tide was rapidly coming in, and the surf was breaking over the rock when he was rescued.—Reward, 2*l.*

April 10.—JAMES PARSONS, of Clevedon, put off in a small boat, at much risk, and saved the engineer of the steam-tug *Elf*, during very cold and stormy weather.—Reward, 2*l.*

June 5.—Voted 3*l.* to four of the Dover Life-boat men, forming the crew of the galley punt *Corsair's Bride*, of that port, for saving the crew of nine men and a pilot from the barque *Lyder Sagen*, of Bergen, Norway, which foundered after coming into collision with a steamer in Dover Roads, during a strong wind and heavy swell, on the 6th December.

June 24.—Three persons put off in a boat and rescued two other persons who, while crossing the ford at Inny river, co. Kerry, with a horse and cart, between two and three o'clock in the morning, had been carried away towards the sea, the river being at the time in a swollen state through heavy rain.—Reward, 3*l.*

July 1.—Eleven men put off in a fishing-boat and brought ashore three men from the smack *Margaret*, of Hillswick, Shetland, which was in a

perilous position off Stromness during a S.E. gale and hazy weather.—Reward, 5*l*.

July 12.—Four men saved another man from a boat which had been capsized off Warren-point, co. Down.—Reward, 1*l*, 5*s*.

July 24.—Three men put off in a boat, at some risk, and saved a man from the lugger *Nicholas*, of Wexford, which had struck upon a rock and while running for the shore foundered off Greenore Head, co. Wexford, during a strong S.W. breeze.—Reward, 2*l*.

Voted the thanks of the Institution to Capt. J. THOMAS, and 1*l*. each to the first mate, and two of the crew of the steamer *Prince of Wales*, of Liverpool, for saving two men from a canoe which had sunk in Rock Channel during a strong N.W. breeze on the 5th July. The two men, who were quite unconscious, were got into the steamer's boat, and with difficulty taken on board and landed at Menai Bridge.

Aug. 15.—Seven men and two boys put off in a boat and saved seven of the crew of the barque *Julie*, of Drammen, which had struck on a rock on the west side of Fair Isle, Shetland, and sank during a dense fog.—Reward, 5*l*.

Aug. 20.—Two men proceeded through the surf in a small Life-boat kept at Tramore, Ireland, for the purpose of rendering assistance to bathers in distress, and saved a man who was in danger of being drowned.—Reward, 1*l*.

Aug. 25.—Six men put off in a Coastguard boat from Ballydavid, Ireland, and, at some risk, saved six persons from the yacht *Vesta*, of Queenstown, which had parted one of her cables, and was in a dangerous position off Smerwick, co. Kerry, during a N.N.W. gale.—Reward, 6*l*.

Sept. 5.—Three men put off in a boat and rescued, at some risk, two other men from a boat which had been capsized off Harwich, in a heavy sea.—Reward, 3*l*.

Sept. 25.—Four men put off in a boat and saved, at considerable risk, in a rough sea, three persons who had taken refuge on a small island called Booster, Shetland, their boat having struck upon a rock, and been totally wrecked during hazy weather.—Reward, 4*l*.

Oct. 2.—Voted the Silver Medal of the Institution, and a copy of the vote inscribed on vellum, to Miss ELLEN FRANCES PRIDEAUX BRUNE, Miss GERTRUDE ROSE PRIDEAUX BRUNE, Miss MARY KATHERINE PRIDEAUX BRUNE, Miss BEATRICE MAY PRIDEAUX BRUNE, and Miss NORA O'SHAUGHNESSY, in acknowledgment of their intrepid and prompt services in proceeding,

through a heavy surf, in their rowing-boat and saving, at considerable risk of life, a sailor from a boat which had been capsized by a squall of wind off Bray Hill, Padstow Harbour, Cornwall, on the 9th August. When the accident occurred, the ladies' boat was being towed astern of a fishing-boat, and Miss ELLEN PRIDEAUX BRUNE, with great gallantry and determination, asked to be cast off, and, with her companions, she proceeded with all possible despatch to the rescue of the drowning sailor. All the ladies showed great courage, presence of mind, and marked ability in the management of their small boat, and ran great risk in getting the man into it, on account of the strong tide and sea on at the time.

Voted also the thanks of the Institution to the Hon. J. G. P. VEREKER, and to SAMUEL BATE, late Coxswain of the Institution's Padstow Life-boat, who were also instrumental in saving a boy who had been thrown out of the same boat.

Also the thanks of the Institution, inscribed on vellum, to GEORGE REYNOLDS, Commissioned Boatman of H.M. Coastguard, at Goodwick, Pembrokeshire, and 1*l*. each to three other men, for putting off in a Coastguard boat, at very great risk (their boat being filled twice by the heavy seas before getting to the vessel), and saving the crew of three men from the smack *Jane and Margaret*, of Newport, Pembrokeshire, which had been driven on the rocks while attempting to make Newport harbour during a fresh N.N.W. gale on the night of the 16th August.

Also the thanks of the Institution, inscribed on vellum, to the Rev. P. VYVYAN ROBINSON, and 25*l*. to forty-one fishermen and Coastguardmen at Cadgwith and the Lizard, Cornwall, for putting off in shore-boats and saving at some risk sixty-nine persons from the steamer *Brest*, of Glasgow, which was wrecked between Cadgwith and the Lizard, during a fog, on the 6th September.

Oct. 14.—Three men put off in a boat, during a gale of wind from the N.N.E., and saved eight of the crew of the ketch *Notre Dame*, of Boulogne, which had stranded on the East Sands, off Blakeney, on the Norfolk Coast.—Reward, 1*l*, 10*s*.

Oct. 17.—Three men also put off in a boat and saved the crew of two men from the flat *Sarah*, of Carnarvon, which was totally wrecked off Rhyll, North Wales, during a strong N.W. wind and heavy sea.—Reward, 1*l*, 10*s*.

Oct. 20.—Four men put off in a boat and saved two men from a boat which had been struck by a sudden squall and capsized in Poole Harbour, Dorset.—Reward, 1*l*, 10*s*.

The following is a copy of a Handbill circulated on the Coasts of the United Kingdom by the Institution, for the purpose of informing Boatmen and others that it encourages laudable exertions to save Life from Shipwrecks:—

TO BOATMEN AND OTHERS.

To encourage prompt and energetic exertions in time of Danger on the part of Boatmen and Others, by quickly putting off to save Life in CASES

of WRECKS on the Coasts of the British Isles, either by

SHORE-BOATS OR OTHER MEANS,

The Royal National Life-boat Institution

GRANTS

Rewards of Money or Medals. In all cases the Rewards are given without further delay than is necessary to obtain proof of the merits of each case, and to ensure their being paid to the right parties.

Application to be made to the Secretary.

By Order of the Committee.

THE
MEDAL OF THE ROYAL NATIONAL LIFE-BOAT INSTITUTION,
 FOR THE PRESERVATION OF LIFE FROM SHIPWRECK.

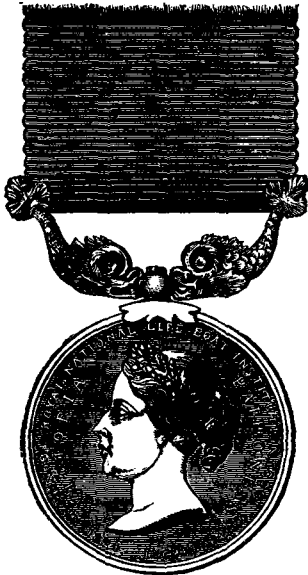

Obverse.—Bust of Her Majesty Queen Victoria; beneath, in minute letters, "L. C. WYON." Double legend, "Royal National Life-boat Institution. Founded in 1824. Incorporated 1860. Victoria, Patroness."
Reverse.—Three sailors in a Life-boat,—one of whom is in the act of rescuing an exhausted mariner from the waves on a fragment of the wreck. "W. Wyon, Mint." Inscription, "Let not the deep swallow me up."

THE beautiful obverse of this medal, executed by L. C. WYON, Esq., represents the bust of QUEEN VICTORIA, Her Majesty's locks gracefully waving and gathered in a knot behind, from which issues a wreath of oak clustering over the forehead. This life-like portrait of the QUEEN, in high relief, conveys a truly pleasing and faithful likeness of HER MAJESTY at that period (1862), combining the dignity of aspect and benevolence which have always characterised the Queen throughout her long and prosperous reign.

The reverse, representing the Life-boat, in which there are three Seamen, rescuing a fourth from the sea, is a work of great merit. Two of the men are steadying the boat, while the other, stooping, draws in the Shipwrecked Sailor, whose figure is given so as to show the form in the most natural manner; and the expression thrown into his countenance looking up to his preserver is supplicating in the extreme, while the easy flowing lines of this sailor are finely contrasted by those of his companions: the whole displaying a perfect knowledge of the human frame, and a command of the graver to embody what he had shadowed out to himself.

But there is another pleasing motive for admiration of this beautiful Medal, as the figure who is so humanely extending his relief to the drowning Mariner is a portrait of the Artist, the late WILLIAM WYON, Esq., R.A., himself.

The following is a List of the GOLD and SILVER MEDALS that have been voted by the Committee of the Institution, since its establishment in 1824, to persons whose humane and intrepid exertions in saving Life from Shipwreck on our Coasts have been deemed sufficiently conspicuous to merit that honourable distinction. The Cases will be found recorded in detail in the several Annual Reports of the Institution.

The total number of Medals granted by the Institution up to the present time is 995; 93 of which were in Gold, and 902 in Silver.

Note.—The asterisk (*) after the name denotes the reception of a Gold Medal. The figure after the name signifies the number of honorary distinctions received from the Institution. Abbreviations.—Ct. G^d.—Coast Guard. R. C.—Revenue Cruiser. M. M.—Master Mariner.

Acraman, Mr. J., Fishguard.	Alexander, W., Coxswain of the Thorpeness Life-boat.	Armstrong, R., Newbiggin.	Bacon, Mr. James, M. M.
Adair, Mr. W., Ct. G ^d , Dundrum.	Allan, Jas., Holy Island.	Armstrong, Mr. W., Blyth.	Bailey, Jas., Boatman, Deal.
Adam, Mr. J., Ct. G ^d , Newcastle. (2)	Allen, Mr. Luke Jas., M. M., Wivenhoe.	Armstrong, W., Newbiggin.	Baillie, Lieut. Henry, R.N.
Adams, Mr. Thomas, M. M.	Amis, Edward, late Coxswain of the Palling Life-boat.	Askin, J., Ct. G ^d , Ballywalter.	Baillie, Lieut. H., R.N.
Agar, J., Ct. G ^d , Morris Castle.	Anderson, Mr. John G., R.N.	Atkins, T., Ct. G ^d , Wainfleet.	Bain, Alex., Seaman, Skerries.
Agnes, Samuel, Wivenhoe.	Annis, Mr. M., Ct. G ^d . (2)	Autridge, Lieut., R.N., Doonbeg.	Bake, Lieut., R.N., Ct. G ^d .
Ahern, John, Ct. G ^d , Kilmore.	Anthony, Mr. Owen, M.M., Holyhead.	Avisse, Mr. J. N., M. M., Boulogne.	Baker, Lt. G. S., R.N., Ct. G ^d .
Aikin, J., Ct. G ^d , Cusbendall.			Baker, Mr. T., Ct. G ^d , Brooke.
			Banyard, Mr. John, Ct. G ^d .
		Bacon, Henry, Harwich.	Barlach, Mr. Henry, M. M. 7

- Barnard, A., C. G^d. (2)
 Barnes, George, Christchurch.
 Barrett, Mr. J., C. G^d.
 Carnrose, (2)
 Barrett, W., C. G^d, Balbriggan.
 Barrett, W., jun., ditto.
 Barron, R. N., Esq., Dun-
 garvan.
 Barry, Lt. G., R.N., Kinsale.
 Bartholomew, R. J., Esq.,
 Rothesay, N.B.
 Bate, Samuel, Second Cox-
 swain of Padstow Life-boat.
 Bates, Mr. Thos., C. G^d.
 Batist, J., C. G^d, Dymchurch.
 Beatson, G. B. M., Esq., C. G^d.
 (2)
 Beaclerck, The late Lord
 Charles.
 Beck, Robert, Point of Ayr.
 Beddoe, D., Fishguard.
 Bedwell, Mr. Wm., M. M.
 Begg, Mr., M. M.
 Bennett, Capt. C. C., R.N.*
 Berriman, Mr. James, M.M.
 Bevan, Mr. John, M. M.
 Bickerstaffe, Mr. R., Cox-
 swain Blackpool Lifeboat.
 Billelt, Mr. R., C. G^d, Cox-
 swain of Lydd Life-boat.
 Bingham, Mr. Wm., Bell-
 muntlett. [ter.
 Bishop, Mr. S., C. G^d, Cais-
 Black, A., C. G^d, Strangford.
 Blackmore, Mr. Wm., Chief
 Officer C. G^d, Penzance. (2)
 Blair, Lt. Horatio, R.N., C. G^d.
 Blampped, Mr. C., Jersey.
 Blanco, John, Shetland.
 Blissendon, William M.
 Blois, Capt. J. R., R.N.*
 Bolitho, Simon, C. G^d, Bude.
 Bongourd, H., Pilot, Guernsey.
 Bonner, G., C. G^d, Colliester.
 Bouchard, John, St. Martin's.
 Bowen, Lieut. C. H., R.N.*
 Boyd, Henry, C. G^d.
 Boyd, Mrs. Captain, R.N.
 Boyle, Marcus, Coxswain of
 Wexford Life-boat.
 Boyle, Lieut. Hon. R. F., R.N.
 Bries, W., C. G^d, Greenacres.
 Bridle, Mr. W. M. M., Lyme.
 Brine, Thos., Esq., Douglas.
 Brinkmead, Mr. W., M. M.
 Brittain, Lieut. G. S., R.N.,
 C. G^d. (2)*
 Britton, Mr. J., Master of the
 American Ship *Rochester*.
 Broad, W., Esq., Falmouth.*
 Brooks, A., C. G^d, Dungeuss.
 Brown, Henry, Newbiggin.
 Brown, James, Dunbar.
 Brown, Thos. Crosswell.
 Browne, Mr. P. R. M. (2)*
 Brune, Miss E. M. Frideaux.
 Brune, Miss E. F. Frideaux.
 Brune, Miss G. R. Frideaux.
 Brune, Miss M. K. Frideaux.
 Brunton, Lt. J., R.N. (2)*
 Buck, W. C., Esq., R.N., C. G^d.
 Buckett, J., Coxswain Briston-
 stone Grange Life-boat.
 Budd, James, Esq., Tramore.
 Bulkeley, J. B., Coxswain of
 Teignmouth Life-boat.
 Bulley, Lieut. J., R.N. (4)*
 Bumbly, Mr. J., C. G^d, Clovelly.
 Bunt, Mr. John, C. G^d.
 Burnard, Mr. T., Bideford. (2)
 Burne, J., C. G^d, Penzance.
 Burne, John, Sen., Shields.
 Burney, Mr. R., C. G^d, Banff.
 Bury, Lt. Viscount, P.C., M.P.
 Butcher, James, Lowestoft.
 Butcher, Rich., Lowestoft.
 Byrne, Mr. Lawrence, C. G^d.
 Cabill, D. F. S., Esq., M.D.
 Cain, Wm., Isle of Man.
 Callaway, W., Seaman, Lyme.
- Campbell, James, Leeston.
 Campbell, Miss J., Drogheda.
 Campbell, Mr. Angus, Cutter
Princess Royal.
 Cameron, Capt. Orford S.,
 R.N., C. G^d.
 Candlish, J., Coxswain of the
 Lytham Life-boat.
 Cannell, T., Isle of Man.
 Carberry, Patrick, Wexford.
 Carbis, Thos., Coxswain of
 the Penzance Life-boat. (2)
 Carey, H., Esq., Shrove Head.
 Carr, C.S., Gunner R.C. *Sylvia*.
 Carr, Mr. Henry, H.M. Cus-
 toms, Wexford.
 Carr, John, C. G^d, Dunmanus.
 Carrington, Mr. J., Master of
 Steam-tug *Liverpool*, of
 Harwich.
 Carrington, Lieut., R.N.
 Carrington, W. H., Esq.
 Carter, Mr. J., C. G^d.
 Casey, M., Newcastle, Ireland.
 Castel, G., Broadstairs.
 Cay, Capt. R. B., R.N. C. G^d.
 Chadcock, J., C. G^d.
 Chaplin, Mr. M. M.
 Chappell, Mr. T., Bideford.
 Chappell, Capt. W., Bideford.
 Chard, J., Boatman, Thorpe.
 Cheesnut, George, Skegness.
 Chittenden, E., Broadstairs.
 Clark, George, Seaman.
 Clark, Lieut. Joseph, R.N.*
 Clayburn, T., Scarborough. (2)
 Clayton, Lt., R.N., C. G^d.
 Cleave, Mr. R. M. M., Wivenhoe
 Cloke, W., Pilot, Mevagissey.
 Cobb, Rev. C., M.A., Dym-
 church.*
 Cockrom, W., H.M.S. *Eagle*.
 Coffey, P., Tramore, Waterford.
 Colby, Nathaniel, Coxswain of
 the Pakefield Life-boat.
 Cole, J., Seaman, Wivenhoe.
 Collard, Mr. S., Pilot.
 Collins, Mr. J., Master of the
 American ship *Roscus*.
 Collison, Mr. R., M. M.
 Collypy, J., C. G^d, Fortbcawl.
 Combe, Lt. M., R.N.
 Coneya, Mr. Anthony, Clifden.
 Connick, Mr. J., Dundalk.
 Cooper, Mr. Hugh, C. G^d.
 Cromaine Point.
 Coppin, Lt. F., R.N., C. G^d.
 Corbert, W., Coxswain of the
 Ardmore Life-boat.
 Corbet, P., Pilot, Guernsey.
 Corbett, W., Esq., Isle of Man.
 Cork, W., C. G^d, Fort George.
 Corkhill, W., Coxswain of the
 Padstow Life-boat. (2)
 Cornish, Lt. J., R.N., Bovis.
 Costello, M., Esq., Rosslare.
 Coul, Alexander, Montrose.
 Coul, Charles, Montrose.
 Cowin, J., Isle of Man.
 Cox, Lt. H., R.N., C. G^d. (2)*
 Cox, Joseph, Coxswain of the
 Appledore Life-boat. (3)
 Cox, J., jun., Second Cox-
 swain of the Appledore
 Life-boat.
 Cox, W., Kimlore.
 Craggs, J., C. G^d, Devonport.
 Cragie, J., Coxswain of the
 Southwold Life-boat.
 Cronne, Dennis, Ballycoiton.
 Cropper, Peter, Liverpool.
 Crosby, Nicholas, Dundalk.
 Crosswell, Mr. T., Fowey.
 Crouch, J., Broadstairs.
 Crouch, R., Broadstairs.
 Crowden, Mr. J., Chief-Officer
 of C. G^d at Muchals, N.B.
 Cubitt, Mr. W., Bacton. (2)
 Cubitt, Mr. W. jun., Bacton.*
 Culmer, Mr., C. G^d, Leigh.
 Cummins, Mr. J., Coxswain
 of the Arklow Life-boat.
- Cunningham, Mr. J., New-
 castle.
 Curnow, Mr. Paul, Coxswain
 of the St. Ives Life-boat.
 Curtels, Mr. W., C. G^d.
 Curtis, Steph., Christchurch.
 Dabine, Lieut., R.N., C. G^d.
 Dand, M. H., Esq., Hauxley.
 (2)
 Dark, Mr. William, M. M.
 Darling, Wm., Light-house
 keeper, Fern Islands.
 Darling, Grace, his daughter.
 Darragh, H., C. G^d, Innis
 Bofin.
 Davies, the late Vice-Admiral
 George. (4)*
 Davies, Capt. Thomas, R.N.
 Davies, George, Hoylake.
 Davison, W., Sunderland.
 Dawson, Mr. T., Hartlepool.
 Day, Chir., Middlesborough.
 Day, Mr. Thomas, Bideford.
 Deane, Mr. Henry, C. G^d.
 Delpierre, Jean A., Boulogne.
 Dent, J., Newbiggin.
 Desmond, John, Limerick.
 De St. Croix, Mr. F., Jersey.*
 De St. Croix, Mr. J., Jersey.*
 De St. Croix, Mr. P., Jersey.*
 Devereux, M., Master Pilot,
 Rosslare. (3)
 Dillon, Jas. C. G^d, Arklow.
 Dolson, T., Coxswain of the
 Donna Nook Life-boat.
 Donkin, A., Cullercoats. (2).
 Donovan, Dennis, C. G^d. (2)
 Donovan, J., C. G^d, Boatman.
 Dooley, Lt. D., R.N., C. G^d.
 Douglas, Alexander, C. G^d.
 Dower, Capt. A., Dungarvan.
 Downing, Nicholas B., Esq.
 Drayson, D., C. G^d.
 Duffy, M., Mullaghmore.
 Dunmore, The Right Hon.
 The Earl of.
 Dunn, Mr. William, M. M.
 Durban, John, Walmer.
 Dyer, B., Seaman, Wivenhoe.
 Dyer, B., Seaman, Wivenhoe.
 Dyer, Lt. H. McNeill, R.N.
 Dyer, Mr. John, Stratton.
 Earle, Lt. E. C., R.N., Rye.*
 Eastaway, R., Boatman, C. G^d.
 Eddy, R. Pilot, Plymouth. (3)
 Edington, Mr. Chas., C. G^d.
 Edwards, Mr. D., Montrose.
 Ellis, Henry, C. G^d, Bude.
 Elphinstone, Geo., Dundalk.
 Else, Lieut., R.N., Fowey.*
 Elton, Lt. W. H., R.N., C. G^d.
 Elwin, Lt., R.N., Lynton.
 Elyard, Major J., 2nd Royal
 Surrey Militia. (2)*
 Erridge, E., Boatman, Deal.
 Essell, Lieut. Wm. F., R.N.*
 Evans, Capt. Thomas.
 Evans, Mr. J., M. M., Fish-
 guard.
 Evans, Lieut. Thomas, R.N.
 Evans, T., sen., New Bright-
 on. (2)
 Evans, T., jun., New Bright-
 on.
 Evans, Wm., New Brighton.
 Evans, Wm., Pilot, Neath.
 Evison, Lt. J. C., R.N., C. G^d.
- Farmer, David, Hayling.
 Farrin, Mr. G., H.M.S. *Ajax*.
 Fellowes, Capt. T. H. B., K.N.
 Festing, Lieut., R.N.
 Festing, Colonel Sir F. W.,
 C.B., K.C.M.G., R.M.A.
 Field, Lieut. Wm. Geo., R.N.
 Field, Mr. W., Milford Haven.
 Finlay, G., C. G^d, Lambay.
 Finlay, William, Montrose.
 Fish, Chas., Coxswain of the
 Ramsgate Life-boat.
- Fish, John, Southwold.
 Fisher, Mr. S., Horseferry-rd.
 Fisher, Mrs., North Ferris
 Islands.
 Fitzjames, Mr., R.N., Eu-
 phrates Expedition.
 Fitzpatrick, J., C. G^d, Malin
 Head.
 Flamm, Wm., Portland.
 Fleming, George, Gortleston.
 Fletcher, T., C. G^d, Rosslare.
 Flynn, P., C. G^d, Kiltush.
 Foley, Mr., M. M.
 Foley, Mr. J., Port Talbot.
 Forbes, Mr. A., Peterhead.
 Formby, Joseph, Formby.
 Forward, Mr. T. R., Com-
 mander R. C. *Sylvia*.
 Foster, J., C. G^d, Aldboro'.
 Found, Mr. W., M. M.
 Fowell, John, Seaman.
 Fowler, Mr. James, M. M.
 Fox, Mr. John, Fleetwood.
 Foy, Thomas, Rossglass.
 Frankish, T. H., Bridlington.
 Franklin, Lt. E., R.N., Hove.
 Franklyn, Lieut. G., R.N.
 Freeman, Henry, Whitby.
 Freeman, John, Seaman.
 Freeman, James, Helston.
 Freemantle, Capt. C. W.,
 R.N.*
 Freney, John, Killiney.
 French, Mr. Charles, C. G^d.
 Fulton, Mr. Robert, R.N.
 Furlong, A., Fishguard.
- Galbraith, Mrs. E., Barking.
 Gale, Mr. W., M.M., Whiting.
 Gallagher, P., Co. Down.
 George, Philip, Coxswain of
 Caister Life-boat.
 Gerrard, Mr. R., Pilot, Fleet-
 wood.
 Giles, Mr. W. M. M., Pad-
 stow.
 Gillespie, Andrew, Gunner.
 Gilmer, Mr. Wm., Dundalk.
 Gison, Lt. T. A. R.N., C. G^d.
 Gimar, Mr. E., Master of the
 French brig *Le Normas*.
 Gln, N. Francois, Boulogne.
 Gleeson, R. F., Wexford.
 Glover, Mr. J., M.M., Gun-
 fleet Sand.
 Goldring, Mr. W., M.M.,
 Hayling.
 Gordon, Mr. John, Second
 Coxswain of the Tyrella
 Life-boat.
 Goss, Capt. T., R.N., C. G^d.
 (2)*
 Gough, J., Fisherman, Water-
 ford.
 Gould, Lt. Wm., R.N., C. G^d.
 Graham, G., Lt. R.N., C. G^d.
 Graham, Capt. Philip, R.N.*
 Granby, Mr. Charles, M. M.
 Grandy, Mr., of the R. C.
Happy.
 Grandy, Lieut. S., R.N. (2)*
 Grant, Mr. W., Coxswain of
 the Margate Life-boat. (2)
 Graves, Mr. J., M. M., Car-
 lisle.
 Gray, A., C. G^d, Fort George.
 Gray, D., C. G^d, Kilmore.
 Gray, Mr. Geo. Bridlington.
 Gray, Mr. J., M. M., Peter-
 head.
 Gray, E. W. D., Esq., Dublin.
 Gregory, J., C. G^d, St. An-
 drew's.
 Grey, George, Hartlepool.
 Griffith, David, Beaumaris.
 Griffith, Robert, Anglesey.
 Griffiths, Mr. B., M. M., Port-
 madoc.
 Griffiths, G., Pilot, Anglesey.
 Griffiths, T., C. G^d, Mulbay.
 Gruer, Wm., C. G^d, Lossie-
 mouth.

- Guy Mr. Philip, Bideford.
- Halse, Mr. R., C. G^d, Ardmore.
- Hamilton, Mr. Geo., C. G^d.
- Hamilton, H. A., Esq. (3)*
- Hamono, Mr. A., M. M.
- Hanning, N., C. G^d, Dingle.
- Hansell, P. S., Broadstairs.
- Hansford, John, Weymouth.
- Harrington, Mr. Dennis, Bere Island, Cork.
- Harrington, Mr. Jas., Bridlington Quay.
- Harrington, T., C. G^d.
- Harris, F., Esq., Inspecting Officer, C. G^d, Seafeld.
- Harrison, Jacob, Shields.
- Hayden, Mr. F., Sandown.
- Heal, J., Fisherman, Atherfield.
- Heard, Rich., Esq., C. G^d.
- Heath, Mr. Joshua, Coxswain of the Fowey Life-boat.
- Heavy, P., Constable, Knock.
- Hein, Mr. F. J., M. M.
- Henin, P., Boulogne-sur-Mer.
- Hennessy, J., C. G^d.
- Henry, Lieut., R.N., C. G^d.
- Henslow, Lt., R.N., C. G^d.
- Henwood, T., C. G^d, Fowey.
- Herbert, The Hon. Auberon.
- Herrington, B., Southwold. (2)
- Hick, Mr. M., Scarborough.
- Hicks, Bernard, Scilly.
- Hicks, Geo., C. G^d, Tyrella.
- Hicks, Samuel, Seaman.
- Higgs, S., jun., Esq., Penzance. (2)
- Higgins, W., Second Coxswain Penzance Life-boat.
- Highland, Owen, Anglesey.
- Hildebrand, H., Esq. Cliffield. (2)
- Hill, Mr. J., Coxswain, Newcastle, Madrum, Life-boat.
- Hill, Mr. W., Mate.
- Hillary, Sir A. Wm., Bart.
- Hillary, Sir Wm., Bt. (4)****
- Hills, W., late Coxswain of the Padstow Life-boat. (2)
- Hipplewhite, Mr. T., M. M., Warkworth.
- Hodgson, J., Carver, Sunderland.
- Hoed, Mr. F. P., M. M., ship *Phenome*.*
- Hogben, J., late Coxswain of Ramsgate Life-boat.
- Hogg, Mr. William, C. G^d.
- Holborn, S., Broadstairs.
- Holland, Lieut. John, R.N.
- Holman, Lieut. T., R.N.
- Hood, R., Coxswain of the Seaton Carew Life-boat.
- Hood, Mr. W., Seaton Carew.
- Hook, R., Coxswain of Lowestoft Lifeboat. (2)
- Houghton, H., Hartlepool.
- Howe, R., C. G^d, Ballygerig.
- Howell, Mr. J., Port Talbot.
- Howorth, Capt. Wm., R.N.
- Hughes, E., Sen., Cwmernan.
- Hughes, G., Pilot, Guernsey.
- Hughes, Mr. John, Liverpool.
- Hughes, T., Pilot, Holyhead.
- Hughes, Mr. W., Fisherman, Pittenween, N.B.
- Humphreys, Mr. D., Liverpool.
- Hurry, Mr. Stephen, M. M.
- Huss, Mr. T., H.M.S. *Rover*.
- Hutchinson, Mr. H., C. G^d.
- Hutchison, Lt., Kingstown.
- Hutchison, Lieut. W., R.N.*
- Hyde, James, Scilly.
- Hynds, Mr. John Dundalk.
- Hynes, B., C. G^d, Galway.
- Iles, The late Mr. John, Scarborough.
- Inkster, Mr. Peter, M. M., Shetland.
- James, Lieut. Horatio, R.N.*
- James, Lieut. Wm., R.N.*
- Japp, Robert, Montrose.
- Jarman, Isaac, late Coxswain of Ramsgate Life-boat. (2)
- Jeffers, Rich., C. G^d, Dingle.
- Jefferson, P., Newbiggin. (2)
- Jellard, Mr. John, M. M.*
- Jenkins, L., Pilot, Port Talbot.
- Jenkins, Mr. W., Fishguard.
- Jennings, Mr. Wm., M. M., Harwich.
- Jennings, W., C. G^d, Looe.
- Jeese, Commander R., R.N.
- Jinks, Mr. R., Chief Officer of Coast Guard, Cardigan.
- Joachim, Capt., R.N. (4)
- Jobson, Lt. C., R.N. (2)**
- John, Mr. W., Breaksea.
- Johns, Mr. Rich., Mevagissey.
- Johns, Rich., Seaman, Fowey.
- Johns, R. O., Coxswain of the *Tramore* Life-boat. (3)
- Johns, Mr. W., M. M.
- Johnson, Lieut. W. W. P., R.N.*
- Johnson, Wm., Yarmouth.
- Johnston, Mr. B., M. M.
- Jones, Capt. C. Gray, R.N., the late. (2)
- Jones, Mr., C. G^d, Wicklow.
- Jones, Mr., C. G^d, Swords.
- Jones, Mr. E., M. M.,
- Jones, Henry, Penzance.
- Jones, J., Pilot, Porthcawl.
- Jones, Owen, Anglesey.
- Jones, Lt. R., R.N., C. G^d. (3)**
- Jones, Mr. T., M. M., Port Talbot.
- Jones, Mr. T. M. M., Cardiff.
- Jones, Mr. Thos., Holyhead.
- Joy, Mr. George, M. M.*
- Juniper, Wm., Mundesley.
- Kavanagh, Peter, Coxswain of the Arklow Life-boat.
- Keaton, Capt. Edw., Arklow.
- Kelly, Lieut. E., R.N.
- Kelly, J. M., Appledore.
- Kendall, W., C. G^d.
- Kennedy, Inspecting-Lt. A., R.N., C. G^d, Ballyheige. (2)
- Kennedy, E., C. G^d.
- Kennedy, Mr. H., Belfast.
- Kennedy, Master J., Belfast.
- Kerley, T., C. G^d, Penzance.
- Kerruish, Mr. John, C. G^d.
- Kidd, D., Fisherman, Dundee.
- Kinch, H., Newcastle.
- King, Mr. T., M. M., Harwich.
- King, Lt. S., R.N., Southend.
- Kisbee, Com. Thos., R.N.
- Knight, J. T., C. G^d, Sunderland.
- Kyle, Geo., Assist. Coxswain Holy Island Life-boat.
- Kyle, Matthew, Coxswain Holy Island Life-boat.
- Lake, Mr. A., Chief Officer of C. G^d, Wick, N.B.
- Lambert, John, Harwich.
- Lambeth, Benj., Harwich.
- Landells, Mr. Thos., Milford.
- Lane, Lt., R.N., Dartmouth.
- Langan, Mr. Michael, First Officer of Steamer *Princess Alexandra*.
- Langton, Lieut. T. W., R.N., C. G^d.
- Large, Mr. J., Master Gunner, R.A.
- Larkin, Thomas, Seaman.
- Lawington, Lt. Thos., R.N.
- Lazou, Lieut. of the French Marine at Dieppe.
- Leask, Mr. Robert, jun., Ireland, near Stromness.
- Leese, Charles, Gunner, R.A.
- Le Geyt, Miss A. B., Bath.
- Leggett, Edw., Gunner.
- Leigh, Lt. T., R.N., C. G^d. (3)**
- Leslie, Mr. J., M. M., Stonehaven, N.B.
- Lett, Lt. S. J., R.N., C. G^d.
- Levett, Mr. N., late Coxswain of the St. Ives Life-boat.
- Lewis, E., Seaman, Barmouth.
- Lewis, Mr. G., C. G^d, Newport, Pembroke.
- Lewis, J., Seaman, Harwich.
- Lewis, Mr. Thos., Dundalk.
- Lewis, W., Seaman. (2)
- Lewis, W., Aberystwith.
- Ley, J., Pilot, Mevagissey.
- Liften, Thomas, Lowestoft.
- Likely, Henry, Limerick.
- Linaker, Mr. Hiram, New Brighton.
- Lindsay, Lieut. Jas., R.N.*
- Lingard, Lieut. J., R.N., Whitby.*
- Lithaby, P., C. G^d, Boatman.
- Llewellyn, Mr. David, C. G^d.
- Llewellyn, M., Fishguard.
- Llewellyn, Martha, ditto.
- Lloyd, O., C. G^d, Lulworth.
- Lloyd, Lt. S., R.N., C. G^d.*
- Lose, Mr. John, C. O., C. G^d, Swanage.
- Louchet, L. P. A. B., Anthie.
- Loughor, Rees, Monkash.
- Love, Private Robert, 63rd Regiment.
- Lovell, Patrick, Belmullett.
- Ludlow, Mr. I., Master of the American ship, *Monmouth*.*
- Lusk, Mr. A., Raeberry, N.B.
- Lyons, Lieut. Wm., R.N. (2)
- Macalister, Mr. Robt., Wick.
- Macdonald, George, C. G^d.
- Mackay, Mr. James.
- Mackell, Mr. Patrick, C. G^d.
- Mackintosh, Mr. Alex., M. M.
- MacMahon, Lieut. H., M. M., East Clare Militia.
- Macnamara, Lt. T., R.N., C. G^d.*
- McArdle, Thomas, Dundalk.
- McCarthy, J., C. G^d, Dundrum.
- McCarthy, Jas., C. G^d, Kilrush.
- McCombie, Mr. Thos., Second Officer of Steamer *Princess Alexandra*.
- McCulloch, K., C. G^d, Elie. (2)
- McDonald, Mr. Wm., Irvine.
- McGenis, G., barque *Albany*.
- McGlavery, Lt. J., R.N., C. G^d.
- McKenzie, J., C. G^d, Galway.
- McKinnon, Mr. J., M. M., Greenock.
- McMillan, J., Kintyre.
- McNamee, P., C. G^d, Dunmanus.
- McNaughten, Neil, C. G^d.
- McQueen, Alex., Seaman.
- Maddick, Mr. H., M. M.
- Manby, Capt. G. W.*
- Manifold, Mr. William, Assist. Coxswain of the Arklow Life-boat.
- Mann, Lieut., R.N., C. G^d.
- Mariote, J. B., French Pilot.
- Mark, Wm., C. G^d, Dingle.
- Markwell, George, Holy Island.
- Marsh, Capt. D., R.N., C. G^d.*
- Marsball, Capt. J., Bideford.
- Marshall, Mr. John, Jun., Second Coxswain of the Seaham Life-boat.
- Martin, Mr. Chas., C. G^d, St. Ives, Cornwall.
- Mason, J., C. G^d, Elie.
- Matthews, Lt. R. B., R.N.*
- May, Mr. A. C., H.M.S. *Rover*.
- May, W. R., C. G^d, Boscawle.
- Mearns, Wm., Coxswain of Montrose No. 1 Life-boat.
- Mearns, Wm. Jun., Coxswain of Montrose No. 2 Life-boat.
- Mearns, Mr. R., jun., M. M., Montrose.
- Metherell, Lt. R. R., R.N., C. G^d.*
- Mewse, A., Boatman, Lowestoft.
- Middleton, John, Deal.
- Milburn, John, Shields.
- Milburn, Wm., Isle of Man.
- Miler, J., C. G^d, Devonport.
- Miller, W., Ramsgate.
- Milligan, Mr. G., Yarmouth.
- Mills, C. C. G^d, Clifden.
- Minter, O., Boatman, Deal.
- Mitchel, J., Pilot, Guernsey.
- Mitchell, C., Port Isaac. (2)
- Mutin, Philip, Wexford.
- Moar, Mav-Stout H. Burra.
- Monger, Mr. Thomas, Coxswain of Tenby Life-boat.
- Moody, Samuel, Skegness.
- Moody, Samuel, Coxswain of Skegness Life-boat. (2)
- Moore, Gunner Jas., Coast Brigade Royal Artillery.
- Moreno, Mr., Master of the Austrian Barque *Eva*.
- Morgan, John, Thurso, N.B.
- Morgan, Lt. R., R.N., C. G^d.
- Morgan, Mr. T. R., C. G^d, Stork.
- Morris, Capt. J., Row, R.N.*
- Morris, R., Seaman, Holyhead.
- Morris, Mr. W. E., Port Madoc.
- Morrison, Lt., R.N., C. G^d.
- Morrison, W., Ballywalter.
- Morrison, Mr. Silvester, C. G^d, Sennen Cove.
- Mortley, Mr., C. G^d, Padstow.
- Moss, J., Boatman, Walmer.
- Mudd, Wm., Harwich.
- Mulligan, James, Sligo.
- Murphy, James, C. G^d, St. Ives, Cornwall.
- Murphy, Mr. Adam, Coxswain of Tyrella Life-boat.
- Murphy, Mr. Michael, C. G^d, Coxswain of New Romney Life-boat.
- Murray, A., C. G^d, Elie.
- Nelson, Mr. W., R.N., C. G^d.
- Newnham, Lt. N., R.N., C. G^d.
- Newsom, Mr. W., M. M., Harwich.
- Nichol, Mr. J., M. M., Montrose.
- Nicholas, Matt., Coxswain of the Sennen Cove Life-boat.
- Nicholson, M., Knock.
- Niebolson, Mr. Philip, Jersey.
- Norcock, Capt. G. L., R.N.
- Norris, Benj., Boatman, Deal.
- Norris, Mr. James, M. M.
- Norris, Martin, R.N.R.
- Nott, Capt. E. B., R.N. (2)
- O'Neil, Patrick, Scilly.
- Orr, Mr. Robt., Irvine, N.B.
- O'Shaughnessy, Miss Nora.
- O'Sullivan, Mr. M., Bere.
- O'Sullivan, D., C. G^d.
- Owen, Capt. Wm., Holyhead.
- Owen, Mr. William, M. M.*
- Owen, Richard, Anglesey.
- Palmer, G., Esq., M.P. (2)**
- Farker, Mr. Edwin, C. G^d, Mothecombe.
- Farker, Mr. J., Flamboro'.
- Farker, Mr. Wm., M. M.
- Parrott, Mr. R., C. G^d, Tenby. (2)

- Parry, Lieut. R.N.*
 Parry, Mr. Henry, Anglesey.
 Parry, Mr. R., M. M., Port-
 mado.
 Parsons, Lieut. Thos., R.N.
 Parsons, Lieut. Rich., H.M.
 35th Regiment.
 Parsons, Lt. W., R.N., C. G.
 Partridge, Capt. W. L., R.N.,
 C. G.
 Pascoe, Peter, Porthleven.
 Paul, Thos., C. G.², Bude.
 Payne, Mr. John, C. O.,
 C. G.², Skerries.
 Paynter, Capt. Richard.
 Peake, Admiral T. L.*
 Peake, James, Esq., H.M.
 Dockyard, Devonport.*
 Pearce, Rich., Esq., Penzance.
 Pearce, Jas. Pilot, Porthcawl.
 Pearse, T., Pilot, Porthcawl.
 Peart, John, Montrose.
 Pedder, Lt. W., R.N., C. G.
 Peebles, Mr. John, Irvine.
 Peebles, Mr. T., M.M., Irvine.
 Peirson, S. H., C. G.², Bally-
 gerig.
 Pepper, J., C. G.², Lymington.
 Perkins, Jas., C. G.², Bude.
 Perrott, Sir Edward G. L.,
 Bart., V.P.*
 Petrie, Ellen, Shetland.
 Phillips, J., Newcastle, Ireld.
 Picard, Mr. P., French M. M.
 Pilcher, Mr. Stephen, Cox-
 swain Tramore Life-boat.
 Pillar, W., Gunner, H.M.S.
Eagle.
 Pincomb, T., Pilot, Exmouth.
 Pitt, E., C. G.², Atherfield.
 Pomeroy, H., C. G.², Meva-
 gisey.
 Porter, William, Seaman.
 Powell, Mr. John, M. M.
 Pratt, Lt. Jas., R.N., C. G.
 Prattent, Lieut. John, R.N.*
 Preston, Mr., C. G.², Newton.
 Prewel, R., C. G.², Kiltrush.
 Price, Thos., Beaumaris.
 Pride, C., C. G.², Christchurch.
 Prior, Lt. T. H., R.N., C. G.
 Prosser, Mr. H., C. G.
 Purdy, H., C. G.², Tyrella.
 Puxley, H., Esq., Dunbo.
 Pym, Lt. R. E., R.N., Whiboy.*
- Quadling, Mr. B. E., C. G.² (2)*
 Quayle, Capt. E., Isle of Man.
 (2)
 Quigley, Mr. W. T., C. G.
 Quirke, G., Esq., Douglas.
- Rae, Wm., Whitburn.
 Randall, Lt. H., R.N., C. G.²,
 (2)**
 Randle, Mr. J., Bristol.
 Rawstone, Lt. R.N., C. G.
 Ray, J., Boatman, Tenby.
 Raye, Lieut. H. R., R. M.
 Read, Lieut. J., R.N., C. G.
 Reade, W. M., Esq., Framore.
 Reading, Mr. Daniel, Master
 of Ramsgate Har. stm. tugs.
 Redford, J., Cullercoats.
 Rees, Mr. A., Port Talbot.
 Rees, Mr. T. M., St. David's.
 Rees, Mr. W., Fishguard.
 Reeve, Mr. J., Swansea.
 Regan, D., C. G.², Kilmore.
 Renowden, J., C. G.², Dingle.
 Richards, Mr. E., M. M.
 Richards, Mr. T., M. M.
 Richards, James, Penzance.
 Richards, Henry, Penzance.
 Richardson, Mr. A., M. M.
 Richardson, W., Esq., Cole-
 raine.
 Ridge, Capt. G. A. E., R.N.
 Ridge, Mr. J., Mate of R.C.
Kite.
 Ridge, Mr. J., C. G.², Cadg-
 with.
- Rioch, R., C. G.², Collieston.
 Ritchie, Mr. Sanda.
 Rivers, T., C. G.², Lydd.
 Roberts, Mr. John, Clogwyn.
 Roberts, Mr. R., Carnarvon.
 Roberts, O., Pilot, Anglesey.
 Robertson-Macdonald, Rear-
 Admiral D.
 Robertson, Lieut. R., R.N.*
 Robertson, Lt. J. H. M., R.N.
 Robins, Mr. J., Gunn, C. G.
 Robinson, Mr. J., Aberdeen.
 Robinson, Lieut., R.N.
 Robinson, T., Whiboy.
 Rockcliffe, W., Southport.
 Roderick, E., C. G.², Dun-
 manus.
 Roderick, J. S., Esq., Ardmore.
 Rodgers, J., *Royal Charter*.
 Roe, R., Esq., J. P., Lymington.
 Rose, W., Boatman, Lowestoft.
 Ross, Capt. Sir Thos., R.N.*
 Ross, R., C. G.², Curracloe.
 Ross, R., C. G.², Dunmore.
 Rossiter, T., Wexford.
 Rothery, Lieut. J., R.N.
 Rowe, W., C. G.², Dingle.
 Rowe, W., Scilly.
 Rowe, W., Seaman, Helston.
 Rowlands, Mr. T., M. M.,
 Newport, Pembroke.
 Rowlands, Mr. W., Coxswain,
 Holyhead Life-boat. (2)
 Ruddock, J., Boatman, Fley.
 Russell, R., Esq., J. P.
 Rutter, Mr. J., Scarborough.
 Rymer, Lt. D., R.N., C. G.²*
- Salmon, C., Fisherman, Gor-
 leston.
 Sanderson, Lieut. J. P., R.N.,
 C. G.², Bridge of Don.
 Sands, Mr. R., M. M., Bahamas.
 Sarony, Mr. O., Scarborough.
 Sauvage, Mr., French Fish-
 ing-boat *Isabelle*.
 Sawtell, Mr. Edwin, C. G.
 Scarlett, R., Harwich.
 Scott, Mr. G. R., *Beethoven*.
 Scott, Mr. J., M. M.
 Selly, W. H., C. G.², Pen-
 zance. (2)
 Sergeant, Lt. J., R.N., C. G.
 Sewell, Lt. H. F., R.N., C. G.
 Sewell, Master John, Belfast.
 Shanahan, Mr. Michael, Bere
 Island, Cork.
 Shankey, R., C. G.² (2)
 Shannon, P., C. G.², Kiltrush.
 Sharrock, J. P., C. G.², Bos-
 castle.
 Shaw, Lt. C., R.N., C. G.
 Shea, D., Coxswain of the
 Padstow Life-boat. (3)
 Shea, D., C. G.², Porthcawl.
 Sheldon, Robt., Redcar.
 Simpson, Mr. Jas., late Mate
 of Ramsgate H. Steamtugs.
 Sims, J., C. G.², Dungeness.
 Sims, Lt. And., R.N. (2)
 Sinclair, Mr. B., Thurso, N.B.
 Sinnott, R., C. G.², Mullagh-
 more.
 Smallridge, Mr. J. H., Cox-
 swain Braunton Life-boat.
 Smith, F., Boatman, Lowestoft.
 Smith, J., Shields.
 Smith, Mr. J., Thurso.
 Smith, Mr. Owen, Bideford.
 Smith, Peter, C. G.², Lydd.
 Smith, T., C. G.², Ballina.
 Smith, Mr. W., Aldborough.
 Smyth, H., C. G.², Kilmore.
 Snell, Lt. G., R.N., C. G.
 Somerville, Lt. J., R.N., C. G.
 (2)*
 Southey, Lt., R.N., C. G.
 Spark, Mr. A., M. M.
 Spraggs, J., Seaman, Hayling.
 Stables, R., Holyhead.
 Stannard, Mr. F., M. M., South-
 wold.
- Stap, Mr. R., C. G.², Dunbar.
 Stark, Lt. P., R.N., C. G.² (2)*
 Starke, Mr. J., C. G.², Queens-
 town.
 Steane, Lt. J., R.N., Rye.*
 Steel, Mr. C., C. G.²*
 Stephens, A., Tramore.
 Stephenson, Mr. B., Coxswain
 of the Boulmer Life-boat.
 Stevens, Henry, Gunner R.A.
 Stewart, W., C. G.², Ardmore.
 Storr, J., Whiboy.
 Stone, J., C. G.², Boscastle.
 Stragnell, Lt., R.N.
 Strahan, Mr. H., Pilot.
 Strains, Mr. J., C. G.².
 Streader, Mr. W. T., H.M.
 Customs, Shoreham.
 Strong, Mr. Fran. F. M.
 Stuart, Lt. J., R.N., C. G.
 Stuart, Lt. T., R.N., C. G.² (2)
 Stubbs, C., Seaman.
 Stubbs, H., Atherfield.
 Stuggins, Mr. W., Second
 Coxswain of Teignmouth
 Life-boat.
 Sullivan, J., Newhaven.
 Sumner, Mr. R., Forny.*
 Superville, Mr., M. M., Bor-
 deaux.
 Surry, W., Penzance.
 Sutherland, D., C. G.², Kater-
 line.
 Sutter, Mr. J., M. M.
 Sutton, Mr. C., Port Talbot,
 M. M.
 Swarbrick, Mr. W., M. M.
 Symmes, Lt. H. A. S., R.N.,
 C. G.²*
 Syngé, The Rev. A., Balbriggan
- Tait, Grace, Shetland.
 Talbot, C. R. M., Esq., M.P.
 Taylor, J., C. G.², Dunderum.
 Taylor, Mr. W., C. O., C. G.²,
 Dunny Cove. (3)
 Tegg, Mr. T., M. M., Cornwall.
 Terrett, T., Constable, Knock.
 Thomas, J., C. G.², Atherfield.
 Thomas, J., C. G.², Rocken,
 Isle of Wight.
 Thomas, R. J., Coxswain of
 New Brighton Life-boat.
 Thompson, D., Thurso, N.B.
 Thompson, Mr. G., Annalong.
 Thompson, Mr. R., Kirkpat-
 rick, C. O., C. G.² (3)*
 Thompson, W., Apprentice,
Smack Ruby of Hull.
 Thorp, Mr. T., Newcastle.
 Tindall, Mr. Smith, M. M.,
 Scarborough.
 Tindall, The late W., Esq.,
 Scarborough.
 Toole, Capt. W., Curracloe.
 Toomey, J., Kingstown.
 Town, J., C. G.², Folkestone.
 (2)
 Town, J., C. G.², Castle-
 gregory.
 Tredwen, Mr. R., Padstow.
 Tregidgo, Mr. W. H., C. G.²,
 Newquay. (3)
 Trent, J., Atherfield.
 Trestlian, Mr. R.
 Triphook, Mr. R., R. C.
Hamilton, Dumworldy.
 Trott, T., Boatman, Deal.
 Tuckfield, Mr. T., Bideford.
 Tudor, Capt. J., R.N., Wick. (2)
 Tully, W., Newcastle. [bar.
 Turnbull, R., Fisherman, Dun-
 turner, Lt. C., R.N.
 Turpin, Mr. J., C. G.², Sal-
 combe.
 Tutt, E., C. G.², Dunmanus.
 Tuvache, Mr. M. M., French.
 Urell, Mr. Joseph, C. O., C.
 G.², Hope Cove.
 Usher, Mr. J., Bridlington.
 Van Houten, Mr. W., Rotter-
 dam. (2)
- Vicary, Lt. W., R.N., Ather-
 field.*
 Vondy, I., Isle of Man. (3)
- Waddy, Dr., Churchtown.
 Wade, Mr. M., Padstow.
 Wake, Mr. Baldwin, Arden,
 Mid. H.M.S. *Forester*.
 Wales, G., Broadstairs.
 Wales, J., ditto, ditto.
 Walker, Lieut., R.N.
 Walker, Mr. J., Brigg.
 Walker, Mr. W. Lewis, Beau-
 maris. (2)
 Wallace, Mr. J., M. M.
 Walsh, J., Esq., Lloyd's
 Agent, Dublin.
 Walsh, Mr. Martin, M. M.*
 Ward, J., R. C. *Sylvia*.
 Ward, Rear-Admiral J. R.
 Warde, D. T., C. G.
 Warn, W., sen., Atherfield.
 Warn, W., jun., ditto.
 Warren, Lt. C. D., R.N.
 Wassey, Capt. E. F. N. K., R.N.
 (3)
 Waters, Wm., Southwold.
 Watt, A., Montrose.
 Watts, Lieut. W. S., R.N.*
 Watts, Mr. Charles, M. M.
 Watts, Mr. William, M. M.
 Waugh, E., C. G.², Wexford.
 Weblin, J., C. G.², Tramore.
 Webster, Mr. John, Cox-
 swain of Maryport Life-
 boat.
 Wedge, W., C. G.², Salcombe.
 Weekes, Wm. Wall, Seaman.
 Wedrake, E., Spurn Point.
 Welsh, Mr. M., M. M.
 West, Mr. Wm., C. G.²,
 Dymchurch.
 Westbrook, Lieut., R.N.
 Wharrier, Mr. William, En-
 gineer of Ramsgate Har-
 bour Steam-tugs.
 Wheeler, C., Atherfield.
 Wheeler, J., ditto. (2)
 Wheeler, K., ditto.
 Wheeler, W., Pilot.
 White, Jas., Coxswain of the
 Fishguard Life-boat. (3)
 White, John, Coxswain of
 Howth Life-boat.
 White, Joseph, Portland.
 White, J., Kearney, Esq.,
 C. G.² (2)
 Whitley, Mr. Elias, Jersey.
 Wilds, Mr. Robert, Coxswain
 of the Deal Life-boat.
 Wilkie, Mr. C., M. M.
 Willcox, J., C. G.², Lydd.
 Williams, Mr. D., Aberdovey.
 Williams, Mr. J., Swansea.
 Williams, Owen, Cemlyn.
 Williams, Rev. O. Lloyd. (2)
 Williams, Rev. J., Anglesey.*
 Williams, Mr. J., Bideford. (2)
 Williams, Mr. J. M., Padstow.
 Williamson, Mr. B., M. M. (2)
 Williamson, Robert, Thurso.
 Williamson, W., Pilot, Wick.
 Wilson, J., Pilot, St. Andrew's.
 Wilson, Mr. J., M. M.
 Wilson, Ralph, Holy Island.
 Wilson, T., Esq., M. P.*
 Wilson, T., Pilot, Holy Island.
 Wilson, W., Pilot, Holy Island.
 Wishart, J., Wick, N.B.
 Wood, Mr. T. L., C. G.² (2)
 Woodham, Lt., R.N., Banff.
 Wordley, S., Harwich.
 Wright, John, Seaman.
 Wright, Mr. J., M. M.
 Wyatt, G., Seaman, Harwich.
 Wyde, Lt. S., R.N., C. G.
 Wyrill, H., Boat*, Scarboro'.
- Young, A., C. G.², Shoreham.
 Young, A. H., C. G.², Blatch-
 ington.
 Young, Lt. T., R.N., C. G.²

BYE-LAWS

OF THE

Royal National Life-boat Institution.

I. THE Annual General Meeting prescribed by the Charter shall be held on the 4th day of March, or as soon after as may be convenient, and the same and all other General Meetings shall be held at such time and place as the Committee of Management shall appoint.

II. A Special General Meeting of the Governors of the Institution may, at any time, be called by the Committee of Management.

III. Notice of every Annual Meeting, and of every Special General Meeting, shall be given by advertisement in three of the daily newspapers published in London ten days at least before the day for holding the same. And in case of a Special General Meeting, the object of it shall be stated in the Notice.

IV. Every Annual and every Special General Meeting shall have power to adjourn to a future day.

V. A statement of the receipts and disbursements of the Society for the preceding year shall be made out by the Committee of Management, and signed by the Secretary and by the Auditor, and shall be left in the Office for the inspection of the Governors for six days prior to the day appointed for the Annual General Meeting, and such account shall be submitted by the Committee of Management to the Meeting.

VI. At every Annual Meeting an election of the President, Vice-Presidents, Treasurer, and Committee of Management, and of an Auditor, shall take place; but the President, Vice-Presidents, Treasurer, Committee of Management, and Auditor, shall be considered as in office, not only until the Meeting shall break up or adjourn, but until others shall be respectively elected in their place.

VII. No other business shall be transacted at a Special General Meeting than the business for which it shall have been expressly called, and no other business shall be transacted at any adjourned Meeting than the business left unfinished at the Meeting from which such adjournment took place.

VIII. At the Annual General Meetings, the order of business shall be as follows:—

1. The Chair shall be taken by the President, if he shall be present, and if not, then by some other person to be chosen by the Committee.

2. The President, or Chairman, shall then state the names of the persons proposed to fill the offices of President, Vice-Presidents, Treasurer, Committee of Management, and Auditor for the year ensuing, and if no other persons shall have been named, the persons so proposed shall be deemed and declared to be elected.

3. The election shall be determined by a show of hands, unless a ballot shall be demanded by any ten Governors present; in which case the same shall take place immediately, and the President, Vice-President, or Chairman, shall appoint two or more scrutineers among the Governors present to superintend the ballot during its progress, and to report the result to the Meeting.

4. No ballot shall be kept open for more than two hours.

5. Immediately after the elections have taken place, or the ballot shall have commenced, the report of the receipts and disbursements of the Society, as signed by the Auditor, shall be read, and submitted to the Meeting for approval.

6. The Committee of Management shall then present a Report of their proceedings for the past year, and particularly (in all cases in which they may have voted a reward) a statement of the number of persons who may have been saved from shipwreck, with the names of the vessels to which they belonged; also a list of the persons to whom medals or rewards may have been voted, with the particulars of the services they rendered; also the particulars of the cases, if any, in which the Committee may have voted assistance to the wives or families of persons who may have perished in an attempt to save the lives of others. Also a return of all the Life-boats belonging to, or established by, or in connection with the Institution, their actual state and condition, and that of the Boat-houses, Carriages, and Stores appertaining to them.

7. Any business which the Committee of Management shall think proper to introduce shall then be entered upon and discussed, and the opinion of the Meeting shall, if necessary, be taken thereon.

8. After all business introduced by the Committee of Management shall have been disposed of, it shall be competent for any Governor to make any proposition which may legally be entertained at such Meeting, and to give any notice he may think fit of a proposition to be considered at a future Meeting.

9. In case the Meeting shall be adjourned, the business to be transacted at the adjourned Meeting shall be specified previously to the adjournment taking place, and shall be entered on the Minutes, and no business shall be transacted at the adjourned Meeting which shall not have been so specified and entered.

10. In all cases of dispute, or doubt, or difficulty, an appeal shall be made to the President, or Chairman, and his decision thereon shall be final and conclusive.

IX. At the Special General Meetings, the order of the proceedings shall be as follows:—

1. The Chair shall be taken as directed for the Annual General Meetings.

2. The object for which the Meeting has been called shall then be stated by the President, or Chairman.

3. The business to be transacted shall be taken in the order stated in the Notice calling the Meeting.

4. All elections, ballots, and debates, shall be conducted in the same manner as at the Annual General Meetings.

X. At all adjourned Meetings the business to be transacted shall be taken in the order in which it shall have been entered on the Minutes of the Meeting from which the adjournment took place.

XI. No motion by any Governor for the repeal or alteration of any existing bye-law, or for the

enactment of any new bye-law, shall be entertained at any General Meeting, unless the same shall have been previously approved by the Committee of Management, or unless notice in writing of such motion shall have been given at some previous General Meeting by the Governor intending to move the same; or unless notice in writing containing the substance of the intended alteration shall have been given to the Committee of Management by the Governor intending to move the same, twenty-one days at least before the day on which such General Meeting shall be held.

XII. If the repeal or alteration of any existing bye-laws, or the enactment of any new bye-law, shall be proposed by the Committee of Management, such repeal or alteration, or such new bye-law, if carried at the Meeting at which it shall have been proposed, shall be binding without confirmation; but if proposed by any Governor, the same shall not be binding unless it shall be confirmed at a subsequent General Meeting, to be held for the purpose, at a distance of not less than three weeks from the preceding General Meeting, which Meeting shall appoint the time for holding the second Meeting.

XIII. Notice of any motion for the repeal or alteration of any existing bye-law, or the enactment of any new bye-law, whether originating with the Committee of Management or otherwise, shall be given by advertisement in three of the daily newspapers published in London ten days at least before the Meeting at which such motion is intended to be made; and if it shall be necessary to confirm such repeal or alteration, or such new bye-law, a similar notice thereof shall be given.

XIV. Minutes of the proceedings at every General Meeting shall be entered in a book, to be provided for that purpose, and signed by the person in the Chair.

XV. In case any irregularity shall occur in the convening or holding of any General Meeting, or in any election or other proceedings at any such Meeting, and the same shall not be publicly noticed and objected to at such Meeting, all proceedings of such Meeting shall be of the same force and validity as if no such irregularity had occurred; but if any irregularity shall be publicly noticed and objected to, the Meeting shall decide thereon, and such decision shall be final and conclusive.

XVI. The President, Vice-Presidents, Treasurer, and Committee of Management, shall be chosen from among the Governors of the Institution. The Auditor shall be a professional Accountant, and his remuneration shall be fixed by the Committee of Management.

XVII. The Committee of Management shall consist of forty Members, but shall be competent to act until reduced by any means below the number of fifteen.

XVIII. The President, Vice-Presidents, Treasurer, Committee of Management, and Auditor going out of office on the day of the Annual Meeting, shall be immediately re-eligible.

XIX. The name of every person intended to be proposed by any Governor as President or Vice-President of the Institution, or Treasurer, or as a Member of the Committee of Management, or Auditor, shall be transmitted in writing to the Secretary seven days at least before the day of election, and a list of the persons so proposed, together with the name of the Governor proposing each such person, shall be fixed up in the Office of the Institution six days before the Meeting, and no person shall be capable of being elected Pre-

sident or Vice-President of the Society, or Treasurer, or a Member of the Committee of Management, or Auditor, whose name shall not have been so transmitted.

XX. The Committee of Management may make such regulations, not inconsistent with the charter or bye-laws, as may appear to them expedient for conducting the proceedings of their own Meetings.

XXI. The Committee of Management shall pay to the Secretary, Inspector of Life-boats, and all other officers, clerks, attendants, and servants of the Institution, such salaries and wages, or make them such recompense as they shall from time to time think proper.

XXII. The Committee of Management shall have the custody of the common seal of the Society. The funded property of the Institution shall be invested, either in the name of the Institution, in its corporate capacity, or in the names of three Trustees to be appointed by the Committee of Management, as the Committee of Management shall, from time to time, think fit; and if the investment shall be made in the names of Trustees, the order of the Committee of Management shall be their sufficient discharge in all cases.

XXIII. Minutes of the proceedings of every Meeting of the Committee of Management shall be taken by the Secretary, or in case of his absence by some other person whom the President, Vice-President, or Chairman shall appoint for the occasion, which Minutes shall afterwards be copied fairly into a minute-book, to be kept for that purpose, and, after having been read, shall be signed by the President, Vice-President, or Chairman of that or the next succeeding Meeting.

XXIV. If any vacancy shall occur in the office of Auditor by death or resignation, or by any other cause than that of going out of office on the day of the Annual Meeting, such vacancy shall be filled up by the election of a new Auditor at a Special General Meeting, to be called for that purpose by the Committee of Management within the space of three calendar months next after such vacancy shall occur, unless the Annual Meeting shall be held within that period, and in that case the new Auditor shall be appointed by the Committee of Management.

XXV. The Governors of the Institution shall consist of the persons who shall have subscribed to the funds either in one sum of ten guineas or upwards, or by an annual payment of one guinea or upwards, and of such other persons as shall be elected to be Governors by a General Meeting, as having rendered essential service to the Institution.

XXVI. Donors of ten guineas and Annual Subscribers of one guinea, to be entitled at all General Meetings to one vote each.

Donors of twenty guineas and Annual Subscribers of two guineas, to two votes each.

Donors of thirty guineas and Annual Subscribers of three guineas, to three votes each.

Donors of fifty guineas and Annual Subscribers of five guineas, to four votes each.

Donors of a hundred guineas and upwards, and Annual Subscribers of ten guineas and upwards, to six votes each.

Governors selected in respect of essential services to the Institution shall be entitled to one vote each.

XXVII. No person claiming to be a Governor, in respect of an annual subscription, shall be entitled to vote at any General Meeting unless he shall have paid his subscription for the current year.

LIFE-BOAT REGULATIONS.

THE following Regulations are intended for the guidance of the Local Committee to be formed at each place at which a Life-boat is stationed by the NATIONAL LIFE-BOAT INSTITUTION, and to whose care and control the Life-boat, her Crew, and everything connected with her management and maintenance, will be entrusted.

1. The Local Committee to consist, if practicable, of not less than five persons usually resident, to be elected annually. The Inspecting-Commander of Coastguard of the division, or in his absence the nearest Coastguard Officer to the spot, to be invited to become a member of the Local Committee.

2. The Local Committee at each station are requested to meet at the expiration of each quarter, and then to forward the usual Quarterly Report to the Institution, on the printed sheet provided for the purpose, as to the behaviour of the Boat during exercise, &c., pointing out any defects that may require to be remedied, and offering any suggestions that may conduce to the efficiency of the service. Also generally to report on the state and condition of the Boat, the Carriage, the Boat-house, and all the Life-boat gear. Should occasion for immediate repairs arise, the Local Committee are authorised to make them to the extent of 5*l.*: more extensive repairs to be referred, with an estimate, to the Parent Institution.

3. An entry is to be made, in the journal supplied for the purpose, of the particulars of all services performed by the Life-boat in saving or attempting to save life, being a duplicate of the official reports of the same forwarded to the Institution, which journal will be retained at the station as a complete record of all the services which have been performed by the Life-boat.

4. There should be three keys to the Boat-house, kept in different places, with the *address of each painted on the door*; one in the possession of the Coxswain, and the others as the Local Committee may decide.

5. A signal shall be agreed on by which the Life-boat crew can be called together when required, such as a flag hoisted by day, and the firing of a carronade (or other alarm signal) by night.

6. As at each Life-boat station there will be a Local Committee, the Coxswain will act under their immediate directions, and the Boat, except in case of wreck or other disaster, is never to be taken afloat without their sanction. It is desirable that each Local Committee should appoint one of their members, resident on the spot, to specially represent them, in conjunction with the Honorary Secretary, on such emergencies.

7. The Coxswain-superintendent will be held responsible for the efficiency and general good order of the Boat-house, the Boat, and her gear; and it is hoped that a sense of the trust confided to them in the cause of humanity will lead the Coxswains and Crews to be most careful on these points, and to distinguish themselves by their zeal and readiness, and by the seaman-like manner in which their Boats are handled.

8. The Life-boat's Crew to consist of a Coxswain-superintendent, an Assistant Coxswain, a Bowman, and as many Boatmen in addition as the Boat pulls oars. On service a Bowman should always go in the Boat, but he is not required on occasions of exercise.

9. For every Boat, at least double the number of men required (if they can be found at or near the spot) should be invited to become members of her Crew.

10. Such men to consist of Fishermen or other Boatmen who are usually resident and (with permission of the Admiralty) of any Coastguardmen of the station who may volunteer for the service.

11. As the efficiency of a Life-boat may often depend on the good training and discipline of her Crew, the strictest attention must be paid by them to the directions of the Coxswain on all occasions connected with the service. The Boat shall be taken afloat for exercise, fully manned, once during each quarter, sometimes in *rough weather*, unless the Boat has been out in that quarter, either on service or with one of the Inspectors.

12. The Boat is to be kept on her carriage in the Boat-house, with all her gear in her ready for use, except articles which may require to be secured from damp.

13. It being the sole object of the Institution to Save *Life*, the Life-boat is to be reserved for cases involving risk of life; and is not to be used for taking off an anchor; nor for the purpose of salvage; nor for taking off stores, a pilot, or orders to a ship, *so as to interfere with private enterprise*, except in cases of emergency, when valuable property would be lost without such aid.

14. Immediately on intimation of a wreck, or of a vessel in distress, the Coxswain is to use his utmost exertions to assemble his Crew, launch the Boat and proceed to her assistance; and in the event of a sufficient number of his Crew not being present, he is to select the best volunteers he can get to supply their places. The Coxswain is held responsible for every man who goes into the Life-boat on occasions of service and of quarterly exercise, without having on a Life-belt. In the absence of the Coxswain the Assistant Coxswain will take charge of the Boat.

15. No one besides the Coxswain and Crew is to be allowed to go out in the Life-boat when going to a wreck, except with the express sanction of the Local Committee.

16. If a wreck occur at some distance from the station, so as to require the Boat to be transported along the coast, the Coxswain is to send to procure sufficient horses (which, by the Wreck and Salvage Act, any Magistrate, Constable, or Revenue Officer may demand the use of), attach them to the Carriage, and lose no time in making the best of his way, with the Crew, to the scene of the wreck.

17. On boarding wrecks, the Preservation of Life is to be the Coxswain's *sole consideration*, and he is on no account to take in goods or merchandize which might endanger the safety of his Boat, and the lives of those entrusted to his charge. And should any be brought in, contrary to his remonstrance, he is fully authorized to throw them overboard.

18. On returning from service, the Boat is not to be left in the surf on the beach, but as soon as possible, is to be got on her carriage, and placed in the Boat-house.

19. The salary of the Coxswain-superintendent shall be 8*l.*, and that of the Assistant Coxswain 2*l.* annually. On every occasion of going afloat to save life, the Coxswains and each of the Crew will receive alike from the Parent Institution, 10*s.* by day, and 1*l.* by

night; and for every time of going afloat for exercise, 4*s.* The Committee, however, reserve to themselves the power to add to those amounts on any special occasions when unusual risk or exposure has been incurred, or to modify, or withhold the usual payment in cases where the launching of Life-boats was manifestly unnecessary before they were put afloat.

20. A reward of 7*s.* to be given to the man who first brings intelligence of a wreck at such a distance along the coast as not to be in sight from the Coastguard or other look-out.

21. In the event of money being received by the Life-boat for salvage of property, or similar service, a proportion equal to the shares of two of the Crew shall be paid to the Institution to cover risk of damage to the Boat; the remainder being equally shared amongst the Coxswain and Crew. For such service the Life-boat men are to look to the owners of the vessels, and not to the Institution, for payment.

22. If voluntary Local Subscriptions or other payments be raised or made to reward any special act of gallantry or exertion, the Institution recommends that the whole of the money be paid to the Crew, in equal shares. The Coxswain and Crews of Life-boats are strictly prohibited from making any claim on Owners of Vessels, or others, for Saving Life.

MEMORANDUM.

The rule of the NATIONAL LIFE-BOAT INSTITUTION for the distribution of Salvage payments to the Life-boat men *when they have saved vessels with their crews on board*, having been at some places misunderstood, the Committee refer the several Honorary Secretaries to the last clause of the Circular on the salvage of property by Life-boats, May 1872, as follows:—

“In those cases when vessels and their crews are saved by the Life-boats, and when the salvage payments made by the owners are less in amount than the usual award of the Institution for saving lives, the Institution will make up the deficiency to the Life-boat men.”—See *Coxswain's Book of Instructions*, p. 17.

It should be distinctly understood that it is optional to the Coxswain and Crew of a

Life-boat, on boarding a wrecked vessel, to endeavour to save the vessel, as well as her crew, when practicable, or not to do so.

In the event, however, of their success in saving the vessel or cargo, and being thereby entitled to salvage payment, the Life-boat men will consider that the service has assumed a distinct character, and that they must look solely to the owners of the property to pay all expenses, including those for launching the Life-boat, subject to the proviso in the clause above quoted.

All claims on the Owners of Vessels for saving their property to be made in their own names, by the Coxswains and Crews of Life-boats, to whom the Life-boats are lent for such service, and on no account in the name of the Institution.

By order of the Committee.

14, JOHN STREET, ADELPHI,
LONDON, W.C.

THE LIFE-BOAT STATION.



THE following brief description and diagrams illustrative of a complete Life-boat Establishment, including the House for the protection of the boat, will serve to convey an idea of the general character of one of the 270 Life-boat Stations of the NATIONAL LIFE-BOAT INSTITUTION.

It will be seen that it is a work of a costly nature, and that not only in the first instance, but that a large permanent expense is entailed in keeping the whole machinery in an efficient state, in the re-supply of any part of it which may be destroyed or worn out, in the exercise of the boats' crews, in launching and working the boats, and in remunerating them for their services in saving their fellow-creatures. Yet, looking to the vast importance of the result effected, and the responsibility of calling on men to risk their lives in effecting the same, it is felt that few if any persons will be found who will consider that expense to be incurred in vain.

THE LIFE-BOAT.

(See Diagrams on next page.)

The following figures show the general form, the nature of the fittings and air-chambers of one of these boats, 33 feet in length and 8 feet in breadth. In figs. 1 and 2, the elevation and deck plans, the general exterior form of the boat is shown with the sheer of gunwale, length of keel, and rake of stem and stern-posts. The dotted lines of fig. 1 show the position and dimensions of the air-chambers within board, the relieving-tubes, and ballast. In fig 2, A represents the deck, B the relieving-tubes (6 inches in diameter), C the side air-cases, D the end air-chambers, E ballast, F scuttles to admit of a free current of air under the water-tight deck, G scuttle for air, and to receive pump. In fig. 3, the exterior form of transverse sections, at different distances from stem to stern, is shown. Fig. 4 represents a

midship transverse section, A being sections of the side air-cases, B the relieving-tubes, of the same depth as the space between the deck and the boat's floor. C, C, C, C, are spaces beneath the deck, placed longitudinally, at the midship part of the boat, with cases packed with cork, forming a portion of the ballast; d scuttle for ventilation, having a pump fixed in it, by which any leakage beneath the deck can be pumped out by one of the crew whilst afloat. The festooned lines in fig. 1 represent exterior life-lines attached round the entire length of the boat, to which persons in the water may cling till they can be got into the boat; the two central lines are festooned lower than the others, to be used as stirrups, so that a person in the water, by stepping on them, may climb into the boat without assistance.

Fig. 1.

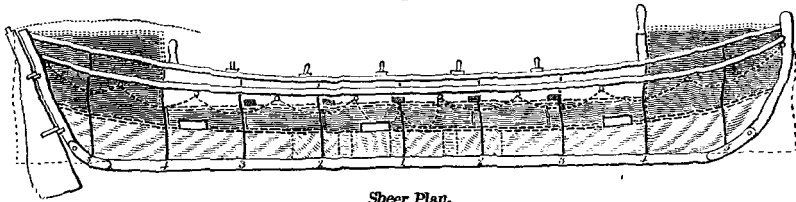

Sheer Plan.

Fig. 2.

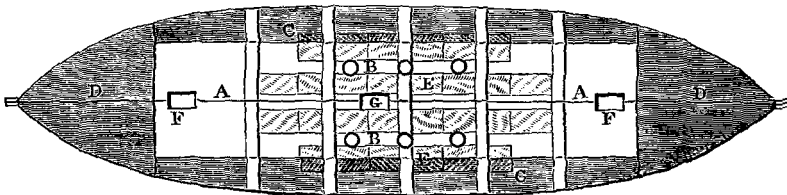

Deck Plan.

Fig. 3.

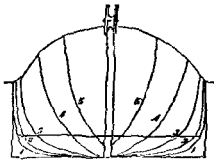

Body Plan.

Fig. 4.

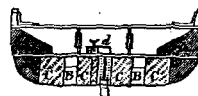

Midship Section.

This Life-boat possesses in the highest degree all the qualities which it is desirable that a Life-boat should possess:—

1. Great lateral stability, or resistance to upsetting.
2. Speed against a heavy sea.
3. Facility for launching and taking the shore.
4. Immediate self-discharge of any water breaking into her.
5. The important advantage of self-righting if upset.
6. Strength.
7. Stowage room for a large number of passengers.

THE LIFE-BOAT TRANSPORTING-CARRIAGE.

The Life-boat transporting-carriage is a very important auxiliary to the boat. Every Life-boat, except a few of the larger size, is provided with a carriage, on which she is kept in the boat-house ready for immediate transportation to the most favourable position for launching to a wreck. A Life-boat is thus made available for a greater extent of coast than she otherwise would be; and even when launched from abreast of the boat-house, can be much quicker conveyed to the water's edge than she could be if not on a carriage. In addition to this ordinary use, a carriage is of immense service in launching a boat from a beach, to that extent, indeed, that one can be readily launched from a carriage through a high surf, when without one she could not be got off the beach.

The carriage consists of a fore and main body. The latter is formed of a keelway, and of side or bilgeways attached to the keelway, and resting on the main axle, the

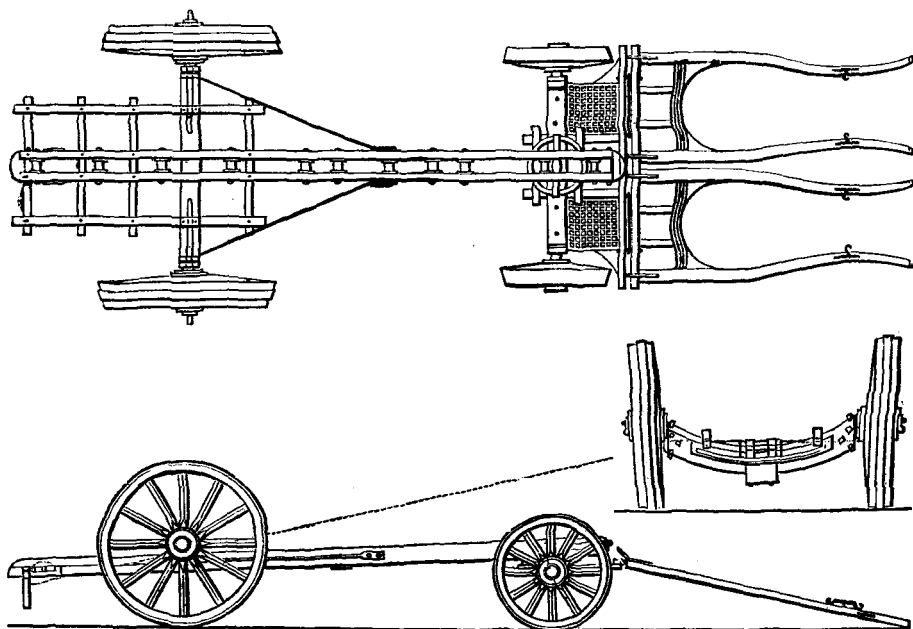

boat's weight being entirely on the rollers of the keelway. Its leading characteristic is that, on the withdrawal of a forelock pin, the fore and main bodies can be detached from each other. The advantages of this arrangement are that, whilst on the one hand the weight of the boat when she is launched from the rear end forms an inclined plane by elevating the keelway and fore-carriage; on the other hand, to replace her on the carriage she can be hauled bow foremost up the fore end or longer incline, by disconnecting the fore-carriage, and letting the end of the keelway rest on the ground, thus forming an inclined plane up which the boat is easily drawn. The bilgeways are needed at the rear end, that the boat may be launched in an upright position, with her crew on board, but they are not required at the fore end of the carriage.

A very full equipment of stores is supplied to the Life-boats of the Institution—such as cork life-belts, anchors and cables, grappels and lines, life-buoys, lanterns, rockets, and many other articles, together with portable or launching-skids.

THE LIFE-BOAT HOUSE.



The boats of the NATIONAL LIFE-BOAT INSTITUTION, and all belonging to them, are kept in roomy and substantial boat-houses, under lock and key, in charge of paid coxswains, under the general superintendence of local honorary committees of residents in the several localities. Each boat has its appointed coxswain at a salary of 8*l.*, and an assistant at 2*l.* a year. The crew consists, in addition, of a bowman, and as many boatmen as the boat pulls oars. The members of the volunteer crews are registered, and wherever practicable, at least double the number of men required are entered on the register. Such men are mostly resident boatmen, fishermen, or Coastguardmen. On every occasion of going afloat to save life, the coxswain and each of the crew receive alike from the funds of the Institution (whether successful or not) 10*s.*, if by day, and 1*l.*, if by night; and 4*s.* each for every time of going afloat for exercise.

A reward of 7*s.* is given to the man who first brings intelligence of a wreck at such a distance along the coast as not to be in sight of the Coastguard Station or other look-out.

A flag hoisted by day, and the firing of a carronade (or other alarm signal) by night, are the well-known signals for calling the crew together.

On boarding wrecks, the preservation of life is the sole consideration. Should any goods or merchandize be brought into the life-boat, contrary to the coxswain's remonstrance, he is authorised to throw them overboard.

The expense of a Life-boat Station averages 1,000*l.*, and is made up as follows:—

Life-boat and her equipment, including Life-belts for the Crew,	
Skids, and Transporting-carriage	£650
Boat-house (average cost)	350
Total	£1,000

The average Annual Expense of maintaining a Life-boat Station is 70*l.*

Such is a brief summary of the chief of the Regulations under which the Life-boats are worked. How faithfully and with what result they are carried out let the journals of each Life-boat Station and the annals of the Institution tell.

The NATIONAL LIFE-BOAT INSTITUTION has now 270 Life-boats under its charge. Every one of these has been specially presented to it, and they save every year from 600 to 700 shipwrecked sailors. Altogether, the Institution has contributed to the saving of 26,906 lives.

Despite, however, this fleet of 270 Life-boats, and of 30 others locally provided and supported, and despite the numerous rocket and mortar stations on our coast, there remains the melancholy fact that an average of 700 lives are lost annually on and around our own shores alone, proclaiming solemnly, though silently, that, for humanity's sake, and for the national credit, no exertions should be spared in providing every possible means for the conveyance of succour to the shipwrecked.

The Institution needs a permanent income of about 40,000*l.* to maintain its great Life-saving Fleet; and the Committee feel assured that it will never lack it so long as it maintains its boats in the state of thorough efficiency that they are in at the present time, and manned as they are on every emergency by as fearless and noble a class of men as ever our Nelsons and Collingwoods led to battle to uphold our country's honour and glory.

LIST OF LEGACIES

PAID TO THE

ROYAL NATIONAL LIFE-BOAT INSTITUTION.

[Legacies of £50 and under are omitted after having been published two years.]

	Amount received.		
	£.	s.	d.
1871—ABBOTT, JOHN, Esq., Halifax (Free of Duty)	2,078	13	4
1879—ADOLPHE, MRS. MARGARET, Dublin	42	14	2
1868—ALDRED, DR. G. E., Richmond (Free of Duty)	100	0	0
1880—ALLAN, ROBERT, Esq., Glenhouse, N.B. (Ditto)	500	0	0
1877—ANDERSON, MISS MARGARET, Leamington	450	0	0
1874—ANNANDALE, ALEXANDER, Esq., Bolton, Lasswade, N.B. (Free of Duty)	199	7	6
1866—ANSTICE, GEORGE, Esq., Chipping Norton	90	0	0
1870—ANSTICE, MRS. ELEANOR, Tynemouth (Free of Duty)	700	0	0
1865—APPLEYARD, JOHN, Esq., Halifax	1,800	0	0
1878—ARMSTRONG, THOMAS, Esq., Ore, near Hastings (Free of Duty)	200	0	0
1878—ARMSTRONG, MRS. HANNAH, Skerton, Lancaster (Ditto)	19	19	0
1877—ARNOLD, MISS ANN, Tavistock Hotel, Covent Garden	1,118	1	11
1879—ATKINSON, MISS ALICE, Giggleswick, York	19	19	0
1872—ATTON, ROBERT, Esq., Taunton (Free of Duty)	800	0	0
1878—BACK, Admiral Sir GEORGE, F.R.S.	90	0	0
Ditto (Special Bequest)	180	0	0
1872—BAKER, MISS ELIZABETH, Stutton, Suffolk (Free of Duty)	100	0	0
1872—BAKER, MISS HARRIET, Stutton, Suffolk (Ditto)	100	0	0
1879—BAKER, MRS. C. H., Acton	19	19	0
1879—BALL, JAMES, Esq., Reading (Free of Duty)	50	0	0
1875—BARKER, ALEXANDER, Esq., Piccadilly	1,800	0	0
1879—BARNICOT, RICHARD, Esq., Dorking (Free of Duty)	200	0	0
1868—BARROW, ROGER, Esq., Newcastle-on-Tyne	90	0	0
1879—BATHO, JOSEPH ALEXANDER, Esq., Brighton	90	0	0
1867—BEBB, MISS MARTHA, Bootham, York	1,570	16	0
1869—BECKETT, J. S., Esq., Tormoham, Devon	625	10	3
1880—BECKETT, JAMES, Esq., Dublin	10	0	0
1877—BECKETT, MISS A., Farnham-St.-Martin (Free of Duty)	600	0	0
1879—BECKWITH, MRS. MARY, Tynemouth (Ditto)	800	0	0
1870—BELL, MATTHEW, Esq., Glasgow (Ditto)	200	0	0
1865—BENNETT, MISS JEMIMA, Sloane Street, Chelsea (Ditto)	90	0	0
1875—BENTINCK, LADY CHARLES CAVENDISH	339	6	0
1871—9—BERGER, MR. GEORGE, Newcastle Street, Strand	5	1	11
1875—BERGONZI, Madame, Boulogne (Free of Duty)	200	0	0
1871—BERRY, ARTHUR, Esq., Liverpool (Ditto)	100	0	0
1874—BEWLEY, JOHN, Esq., Kingsland Road	118	18	4
1878—BIFFIN, JAMES, Esq., Hillingdon	45	0	0
1859—BIGGS, GEO. Esq., Strand (Free of Duty)	100	0	0
1877—BIGGS, MISS L. M., St. John's Wood (Ditto)	1,900	0	0
1877—BIRKETT, WILLIAM, Esq., Newton-in-Cartmell	720	0	0
1876—BIRTWHISTLE, MISS M.A., Cheltenham	900	0	0
1879—BOETEFEUR, ALEX., Esq., Bayswater	8,020	6	2
1879—BOLT, ROBT., Esq., Poulton, Gloucester (Free of Duty)	100	0	0
1868—BOLTON, MISS ELIZABETH, Chelsea	415	2	6
1860—BOWERBANK, Captain, R.N.	90	0	0
1876—8—BOWLES, Admiral Sir WILLIAM K.C.B., Hill Street	180	12	0
1877—BOYS, THOMAS, Esq., Hove	5,447	14	9
1879—BRADBERRY, THOS., Esq., Finsbury Park (Free of Duty)	500	0	0
1880—BROADHURST, Hon. Mrs. H. M., Richmond (Ditto)	300	0	0
1865—BRODIE, Miss, York Place, Portman Square (Ditto)	400	0	0
1869—BRODIE, MRS. MARY ANN, Harley Street	90	0	0
1868—BROMEHEAD, E. A., Esq., Thornthwaite, Cumberland (Free of Duty)	100	0	0
1879—BROOKES, J. M., Esq., M.D., St. John's Wood	90	0	0
1864—BROWN, Capt. HUGH, Kilmarnock, N.B. (Free of Duty)	99	18	6
1869—BROWN, THOMAS, Esq., Ludgate Hill (Ditto)	500	0	0
1877—BROWNE, MISS MARY, Liverpool (Ditto)	250	0	0
1867—BROWNRIGG, Dr. THOMAS, Keighley, York	180	0	0
1871—BURD, MRS. MARY, Wantage (Free of Duty)	1,500	0	0
1878—BURRELL, Miss F. A., Durham (Ditto)	100	0	0
1877—BURY, CHARLES, Esq., Nazing (Ditto)	500	0	0
1876—8—CAMERON, Miss E.	1,330	8	10
1877—CAMERON, MISS MARGARET	356	19	11
1864—CAMPBELL, DAVID, Esq., Rothesay, N.B.	107	18	31

[Continued.]

LIST OF PAID LEGACIES—*continued.*

	Amount received.		
	£.	s.	d.
1877—CARLILE, Miss H. E., Clifton, Bristol	90	0	0
1868—CHAPMAN, Mrs. MARY, Aldborough (Free of Duty)	60	0	0
1876—CHELLINGWORTH, Miss A. W., Upton Bishop (Ditto)	103	19	0
1872—CHORLEY, HENRY F., Esq., Eaton Place West (Ditto)	600	0	0
1858—CHURCH, Miss, Berkeley	90	0	0
1869—CLARK, Mrs. M. E., Addison Road, Kensington	450	0	0
1868—CLAYTON, THOMAS, Esq., Wakefield (Free of Duty)	250	0	0
1877—COATES, P. E., Esq., Stanton Court, Somerset	450	0	0
1855—COLES, B., Esq., Tunbridge Wells	155	18	0
1878—CORKER, C. J., Esq., Ramsgate	449	10	0
1872—COSENS, WILLIAM, Esq., Langdon, Dawlish (Free of Duty)	200	0	0
1870—COSTELLO, DUDLEY, Esq., Acacia Road, St. John's Wood	399	17	3
1876—CRANHAM, CHARLES, Esq., Audlem, Chester	450	0	0
1879—CROSSE, ROBERT, Esq., Southsea	10	10	0
1872—CROYDEN, Mrs. LUCY, Portswood, Southampton	69	10	8
1863—CURRIE, WILLIAM, Esq., Cornhill	180	0	0
1862—CUTTO, Mrs. ANN, Old Kent Road (Free of Duty)	1,000	0	0
1866—DALTON, RICHARD, Esq., Wigton (Ditto)	100	0	0
1873—DANFORD, WILLIAM, Esq., Highweek, Devon (Ditto)	100	0	0
1868—DANGAR, WILLIAM, Esq., Cheltenham (Ditto)	200	0	0
1872—DAVIDSON, Mrs. ISABELLA, Conway (Ditto)	100	0	0
1857—DAVIES, Miss JANE, Clapham	90	0	0
1872-9—DEAN, W. H., Esq., Stratford	307	8	5
1867—DEANE, Mrs. MARIA, Cheltenham (Free of Duty)	100	0	0
1880—DEIGHTON, Miss SARAH, Peckham	180	0	0
1874—DEWAR, EBENEZER, Esq., Leith, N.B.	89	8	0
1876—DEWAR, Mrs., Vogrie, N.B. (Free of Duty)	500	0	0
1875—DICKMAN, Captain W. H., R.N., Holloway	368	16	1
1875—DOLLING, Miss, Shrewsbury	90	0	0
1869—DONCASTER, Mrs. ELIZA, Winthorpe, Nottingham (Free of Duty)	100	0	0
1870—DORSET, Miss SARAH, Reading (Ditto)	100	0	0
1873—DOUGLAS, Miss E. HOUSTON, Eaton Place (Ditto)	250	0	0
1878—DOUGLAS, Mr. JOHN, Skirbeck, near Boston	1,343	6	3
1872—DRUMMOND, Mrs. S. J. DUNDAS, Kensington (Free of Duty)	2,500	0	0
1832—DUPPA, Mrs., Homerton, Middlesex	1,000	0	0
1873—EDDISON, Mrs. H. M. Adel, Leeds (Free of Duty)	200	0	0
1879—EDMONDS, Admiral CHARLES, Worthing	19	19	0
1873—ELWOOD, Mrs. A. K., Clayton Priory, Hurstpierpoint	90	0	0
1877—EVERARD, Miss GRACE, Laverstock, Wilts (Free of Duty)	1,000	0	0
1870—EVANS, ALFRED SMITH, Esq., Edgbaston (Ditto)	500	0	0
1877-8—FAIRLIE, Lady CUNNINGHAM	893	6	2
1879—FARMER, JOHN, Esq., Darlington	270	0	0
1864—FARNELL, JOHN, Esq., Isleworth (Free of Duty)	1,000	0	0
1877—FARTHING, MICHAEL, Esq., Hartlepool (Ditto)	120	0	0
1876—FERGUSON, The Misses, Edinburgh	4,500	0	0
1873—FERNLEY, JOHN, Esq., Southport (Free of Duty)	500	0	0
1874—FINDLATER, ALEXANDER, Esq., Kingstown (Ditto)	200	0	0
1876—FINNIE, JOHN, Esq., Bowdon Lodge, near Altrincham	666	13	4
1877—FIRBANK, EDWARD, Esq., Uplyme, Devon (Free of Duty)	1,000	0	0
1880—FIRBANK, Mrs. Anne, Charlton (3 per Cent. Consols)	908	5	0
1879—FISHER, EDWARD, Esq., Ashby-de-la-Zouch (Free of Duty)	100	0	0
1872—FITCH, Mrs. FRANCES, Bath	500	0	0
1856—FITZGERALD, Captain HAMILTON, R.N., V.P.	9,551	14	2
1864—FITZROY, The Hon. Mrs., Upper Grosvenor Street (Free of Duty)	400	0	0
1879—FLETCHER, G. H., Esq., Carshalton	450	0	0
1879—FOLEY, Miss MARY, Bramley Road, Notting Hill	233	1	6
1858—FOSTER, GEO. HOGATE, Esq., V.P., Moorgate Street (Free of Duty)	1,000	0	0
1875—FOULSTON, Mrs. ELIZA, South Kensington	83	0	6
1869—FOX, ROBERT, Esq., Falconhurst, Kent (Free of Duty)	100	0	0
1878—FOXTON, Mrs. C. D., Pendlebury, near Manchester (Ditto)	1,000	0	0
1867—FRYTH, Mrs. ANNE, Deptford	90	0	0
1868—FYDELL, R. S., Esq., Morcott Hall (Free of Duty)	100	0	0
1873—GARDEN, R. J., Esq., South Kensington	1,193	6	0
1862—GEDGE, Miss ALICE, Great Yarmouth	304	16	0
1876—GIBB, B., Esq., Deptford	90	0	0
1878—GIBBON, L. F., Esq., Pembroke	450	0	0
1875—GIBBONS, Mrs. SILLS, Bath (Free of Duty)	500	0	0
1874—GIBSON, Capt. ROBERT, R.N., C.B., Lancaster (Ditto)	100	0	0
1877—GIBSON, Dr. ALEXANDER, Auchenroch, N.B.	802	16	0
1866—GILBERT, JOHN GRAHAM, Esq., Yorkhill (Free of Duty)	100	0	0
1877—GILBERT, Mrs. JANE GRAHAM, Yorkhill, N.B. (Ditto)	250	0	0
1875—GOADSBY, Mrs. M. A., Fallowfield	450	0	0
1875—GODIN, Miss SARAH, Maids Vale (Free of Duty)	100	0	0
1879—GOOCH, JAMES, Esq., Ipswich (Ditto)	100	0	0

[Continued.]

LIST OF PAID LEGACIES—continued.

	Amount received.		
	£.	s.	d.
1866—GOODMAN, Miss ELLEN, Eversholt	540	0	0
1877—GORDON, Capt. J. A., R.N., Ittington, N.B.	271	19	2
1868—GORFENKLE, JACOB, Esq., Liverpool (Free of Duty)	500	0	0
1872—GOVER, Miss ELEANOR, Pimlico (Ditto)	94	9	0
1872—GRAHAM, JOHN, Esq., Ide Hill, Sevenoaks (Ditto)	1,000	0	0
1877-9—GRAHAM, JAMES, Esq., Cornwall Terrace, Regent's Park	2,500	0	0
1877—GRAHAM, Miss ANN MAXWELL, Williamswood (Free of Duty)	500	0	0
1851—GRANTHAM, Mrs. JANE, Altrincham, Cheshire	100	0	0
1871—GREENE, JOHN, Esq., Gateshead (Free of Duty)	200	0	0
1877—GRIFFITH, H. DAVIES, Esq., Caer Hûn, Carnarvon (Ditto)	2,000	0	0
1875—GRIFFITHS, Miss REBECCA, Dudley	180	0	0
1874—GRINDLAY, THOMAS, Esq., Edinburgh (Free of Duty)	1,000	0	0
1866—GROVE, WILLIAM CHAFFN, Esq., Mere, Wiltshire	90	0	0
1875—HABERFIELD, Lady, Clifton (Free of Duty)	640	0	0
1868—HALL, Miss LOUISA, Maida Vale (Ditto)	945	0	0
1867—HALL, WILLIAM JOHN, Esq., Trinity Square	580	11	10
1873—HAMILTON, Miss MARY ANN, Harrogate (Free of Duty)	200	0	0
1864—HARCOURT, Admiral O. V., Swinton Park (Ditto)	1,000	0	0
1880—HARCOURT, Mrs. A. H. DANBY VERNON, Swinton (Free of Duty)	500	0	0
1873-4—HARRIS, Capt. E. W., Roehampton	8,342	8	0
1876—HARRISON, Miss H. M., Bath (Free of Duty)	500	0	0
1868—HARRISON, Miss SARAH, Edge Hill (Ditto)	100	0	0
1834—HAYMAN, Mrs., Topsham, Devon	88	0	0
1825—HECKER, JOHN HENRY, Esq., Finsbury Square	1,000	0	0
1860—HEMINGTON, THOMAS FISHER, Esq., Uplyme, Devon (Free of Duty)	100	0	0
1877—HENLEY, Mrs. ANN, Plymouth	180	0	0
1879—HINDLEY, Miss ELIZABETH, Heaton Norris	90	0	0
1879—HODSON, Miss HARRIET, Lewes	45	0	0
1878—HOLGATE, JOHN, Esq., Burton-in-Lonsdale (Free of Duty)	200	0	0
Ditto, for the widows and families of men lost or injured while engaged in Life-boats (Free of Duty)	200	0	0
1865—HOLLINS, Wm., Esq., Over Wallop, Southampton (Ditto)	511	11	6
1880—HOLME-SUMNER, Mrs. H. K., Swaffham (Ditto)	100	0	0
1872—HOLME, THOMAS, Esq., City Road	4,545	0	0
1867—HOOPER, Mrs. MARIANA, Andover (Free of Duty)	100	0	0
1880—HOPE, Mrs. ELLEN, Upper Seymour Street	270	0	0
1869—HORTON, Miss MARY ANN, Highbury (Free of Duty)	100	0	0
1865—HORTON, SAMUEL, Esq., Prior's Lee (Ditto)	100	16	10
1872—HOWARD, THOMAS, Esq., Rotherhithe (Ditto)	100	0	0
1874—HOWELL, JOHN, Esq., Cadogan Place (Ditto)	210	13	9
1879—HOYLE, DUNCAN, Esq., Orme Square, Bayswater (Ditto)	1,000	0	0
1868—HUDSON, JOSEPH, Esq., Barrow-upon-Soar	90	0	0
1879—HUGHES, Miss HANNAH, Budleigh-Salterton	214	5	9
1879—HUNT, Mrs. MARIA, Hornsey	450	0	0
1873—HYDE, Colonel J. C., Timbercombe Lodge, Somerset (Free of Duty)	247	7	6
1873—INGLEBY, Rev. CHARLES, Cheadle, Stafford (Ditto)	100	0	0
1877—IRLAM, GEORGE, Esq., North Row, Park Lane (Ditto)	1,000	0	0
1867—IRLAM, Miss MARIA, Dibbinsdale (Ditto)	1,000	0	0
1876—IRVINE, Mrs. S., Geneva	270	0	0
1878—JACKSON, Miss A. C., Croydon (Free of Duty)	100	0	0
1877—JEFFERSON, EDWARD, Esq., Pontefract (Ditto)	400	0	0
1875—JEREMY, Mrs. C. A., Axminster (Ditto)	1,000	0	0
1863—JOLLY, Mr. JOHN, Farmer, Enstone, Oxford	189	0	0
1868—JONES, CHARLES WILLIAM, Esq., Norwich	180	0	0
1879—JONES, EDWARD, Esq., Port Hope, Ontario	(\$3000)	611	5 11
1861—JUDKIN, J. R., Esq., Hackney (Free of Duty)	105	0	0
1870—J. L., Esq., Horsham	450	0	0
1864—KEATE, Miss EMMA, Kensington (Free of Duty)	300	0	0
1869—KEMP, Miss E. S., City Road (Ditto)	100	0	0
1878—KENDALL, Wm., Esq., Exeter (Ditto)	1,000	0	0
1877—KENDRICK, Mrs., Philpot Street (Ditto)	100	0	0
1875—KERR, MALCOLM, Esq., Glasgow (Ditto)	250	0	0
1879—KERR, Miss MARY, Dumfries	45	18	4
1868—KINGSTON, FRANCIS HOUSE, Esq., Harpenden	431	2	0
1874—KIPLING, Mrs. S. E., Kentish Town	450	0	0
1874—KIRBY, Mrs. F. S., Dublin	180	0	0
1880—KIRKPATRICK, Mrs. HARRIET SUTTON (Free of Duty)	100	0	0
1864—KITCHING, JOHN, Esq., Stamford Hill (Ditto)	100	0	0
1872—KNIGHT, Miss MARIA, Hathern, Leicester	90	0	0
1875—LAMBERT, JAMES, Esq., Alloa, N.B.	502	11	6
1877—LEE, Miss MARY, Foleshill, Warwickshire (Free of Duty)	250	0	0
1872—LEEVES, EDWARD, Esq., Venice (Ditto)	100	0	0
1876—LEWTHWAITE, Miss SARAH, Bowdon, Chester	450	0	0
1877—LEWTHWAITE, Miss F. J., Colton, Lancashire (Free of Duty)	200	0	0
1876—LIDDELL, HENRY, Esq., Kingston-upon-Hull (Ditto)	100	0	0

[Continued.]

LIST OF PAID LEGACIES—continued.

	Amount received.		
	£.	s.	d.
1870—LLOYD, CHARLES, Esq., Kennington (Free of Duty)	500	0	0
1876—LONG, MISS CATHERINE, Chipping Norton	172	16	6
1876—LONSDALE, HENRY, Esq., M.D., Carlisle	90	0	0
1854—LOWE, SAMUEL J., Esq., Shadwell	871	15	0
1862—LUPTON, WILLIAM, Esq., Salford (Free of Duty)	100	0	0
1872—LYON, MRS. JANE, Knightsbridge (Ditto)	500	0	0
1869—MACKIE, Dr., Greenock	359	12	5
1864—MACNAB, JAMES, Esq., Guildford (Free of Duty)	99	4	6
1879—MACNAMARA, Admiral Sir BURTON, Kingstown	525	3	0
1864—MAGENIS, F. R., Esq., Grosvenor Place (Free of Duty)	1,000	0	0
1878—MALTBY, MISS JANE, Southwell (Ditto)	50	0	0
1875—MARKLAND, MISS ELLIN, Notting Hill (Ditto)	200	0	0
1875—MARSHALL, ROBERT, Esq., Edinburgh	270	0	0
1879—MASON, MISS ELIZABETH, Necton	900	0	0
1877—MAY, Dr. H. S., Exeter	180	0	0
1869—MCALLEY, WILLIAM, Esq., Stirling, N.B.	99	1	10
1874—MCKINNEL, OF HANNAY, Mrs., Kirkcudbright, N.B.	91	11	0
1872—MEREDITH, Mr. THOMAS, Edgware Road	52	10	0
1874—METGE, PETER PONSONBY, Esq., Athlumney, Navan	180	0	0
1871—MEYNELL-INGRAM, MISS LOUISA E., Hoar Cross (Free of Duty)	300	0	0
1871—MEYRICK, STANTON, Esq., Brompton	611	7	6
1863—MILLER, JAMES, Esq., Glasgow (Free of Duty)	100	0	0
1878—MILLOTT, MISS EMILY, Pendleton, near Manchester (Ditto)	100	0	0
1877—MITCHELL, JAMES, Esq., Kincairney, N.B. (Ditto)	506	5	0
1864—MONTAGU, Captain M., R.N., Bath (Ditto)	98	13	4
1865—MORGAN, Mrs., Cheltenham (Ditto)	204	11	10
1876—MORRIS, Mrs. C. H., Hammersmith	463	14	4
1877—MOSTYN, T. A. B., Esq., St. James's Place (Free of Duty)	100	0	0
1875—MYTTON, Miss C. H. A., Shelton, near Shrewsbury	450	0	0
1868—NAYLOR, WILLIAM, Esq., Twickenham (Free of Duty)	500	0	0
1871—NEALE, Miss ELIZA, Hayes, towards the building of a "Pendock Neale" Life-boat	£246	16	7
1872-5—Also donations from Miss J. E. HERRING, Newport, I. W., in aid of same Life-boat, in memory of de- parted friends	353	3	5
1876—NEWEN, GEORGE, Esq., Cambridge Terrace (Free of Duty)	600	0	0
1878—OVEY, MISS JANE, Henley-on-Thames (Ditto)	100	0	0
1867—OXENHAM, Miss C. N., Kensington	500	0	0
1875—PARK, WILLIAM, Esq., Torwoodhill, N.B. (Free of Duty)	180	0	0
1875—PARK, Mrs. Do. Do.	148	18	5
1877—PARKER, Mrs. M. D., Whippingham, Isle of Wight (Ditto)	500	0	0
1878—PATON, Wm., Esq., Greenock	300	0	0
1857—PETERSON, Miss MARIA, Bromley	30	0	0
1876—PHELPS, Mrs. MARGARET, Chichester (Free of Duty)	90	0	0
1876—PICKERSGILL, H. W., Esq., R.A., Blandford Square	101	18	3
1879—POPHAM, Mrs. J. E. M., Ardchattan, N.B.	900	0	0
1880—PRICE, ALLIN FOORD, Esq., M.D., Deptford (Free of Duty)	464	8	7
1830—PRIOR, WILLIAM, Esq., Herne Hill, Camberwell	160	0	0
1878—PUCKLE, Miss CAROLINE, Camberwell (Free of Duty)	1,827	14	8
1879—RADCLIFFE, H. J., Esq., Eastbourne	20	0	0
1875-6—RANDELL, JAMES, Esq., Mark Lane	570	14	5
1874—RATTRAY, Miss MARY GRAY, Tavistock Square	483	15	11
1867—RAWSON, Miss MARIA, Sheffield	200	0	0
1876—RAYMENT, Mrs., Dartford (Free of Duty)	90	0	0
1874-5—REEVE, JOHN, Esq., Reading (Ditto)	100	0	0
1848—RENNELL, THOMAS THACKERAY, Esq., Enfield	948	15	0
1830—RHODES, W. B., Esq., Hounslow (3 per Cent. Consols)	360	0	0
1869—RICHARDSON, Mrs. HARRIOT, Greenwich	20,000	0	0
1874—RICHARDSON, Miss MARY, Edinburgh (Free of Duty)	4,412	0	6
1877—RIDEOUT, W. J., Esq., Charles Street, Berkeley Square (Ditto)	500	0	0
1876—RIGDEN, The Misses, Chespatow (Ditto)	1,000	0	0
1877—ROBERSON, CHARLES, Esq., Long Acre	100	0	0
1870—ROBERTS, JOHN, Esq., Morningson Road (Free of Duty)	450	0	0
1873—ROBERTSON, Mrs. M. J., Kelso, N.B.	200	0	0
1863—ROBINSON, Mr. THOS., Cheetham, Manchester	450	0	0
1879—ROE, Mrs. MARY, Nutley, Co. Dublin (Free of Duty)	189	0	0
1870—ROLLESTON, Mrs. HARRIET, Swindon (Ditto)	400	0	0
1874—ROYOU, WILLIAM, Esq., Tottenham	450	0	0
1874—RUSSELL, Lady FRANKLAND, Thirkleby, Yorkshire	501	11	11
1880—SAUNDERS, Miss ELLEN	106	19	8
1869—SCOTT, SAMUEL, Esq., Cavendish Square (Free of Duty)	23	18	1
1858—SELL, Mr. CHARLES, Hoxton	1,000	0	0
1867—SHARPE, Miss JANE, Whitburn	66	2	11
	89	6	8

[Continued.]

LIST OF PAID LEGACIES—*continued.*

	Amount received.		
	£.	s.	d.
1866—SHAW, JAMES DAVIDSON, Esq., Newcastle-on-Tyne	449	1	8
1879—SHAW, JAMES, Esq., Brighton (Free of Duty)	100	0	0
1876—SHEPPARD, FREDERICK, Esq., Folkington, Sussex (Ditto)	2,000	0	0
1868—SILVER, THOMAS TEMPLE, Esq., Woodbridge (Ditto)	650	0	0
1868—SINCLAIR, DAVID, Esq., Thurso (Ditto)	100	0	0
1869—SINCLAIR, WILLIAM, Esq., Sowerby, York (Ditto)	138	18	3
1874—SKURRAY, W. H., Esq., Leamington	1,155	12	4
1868—SLADE, FELIX, Esq., Lambeth (Free of Duty)	300	0	0
1866—SMALL, MRS. SARAH, Brighton	76	7	6
1865—SMITH, MISS ANN FRANCES, Greenwich	50	15	0
1875—SMITH, JOHN, Esq., Hull (Free of Duty)	200	0	0
1867—SMITH, MRS. MARY ANN, Greenwich (Ditto)	1,000	0	0
1875—SMITHEMAN, JOHN, Esq., Hertford	90	0	0
1879—SNAGG, SIR WILLIAM, Georgetown, Demerara	10	0	0
1864—SPENCER, RICHARD, Esq., Gower Street	180	0	0
1878—STANTON, J. J., Esq., Meadowcroft, Lewisham	107	8	10
1874—STANNAH, SAMYNTAS, Esq., Gower Street	450	0	0
1873—STANTON, WILLIAM, Esq., Bramly Wharf, Surrey	473	17	5
1875—STEAD, MRS., Helensburgh (Free of Duty)	100	0	0
1876—STONE, RICHARD, Esq., Ulceby, Lincolnshire	101	11	1
1866—STORY, MRS. MARY ANN, Kensington (Free of Duty)	500	0	0
1870—STUART, CHARLES, Esq., Norfolk Street (Ditto)	200	0	0
1865—STUBBS, THOMAS, Esq., Hulme, Manchester (Ditto)	500	0	0
1869—STURM, JAMES, Esq., High Holborn (Ditto)	500	0	0
1865—SYKES, CAPT. JOHN, R.N., Bolsover Street (Ditto)	100	0	0
1878—SYKES, MRS. ANN ELIZABETH, Butharlyp, How Grasmere (Ditto)	600	0	0
1871—TANCRED, J. J., Esq., Pearville, Co. Dublin (Ditto)	1,350	0	0
1866—TAYLOR, THOMAS TRAVERS, Esq., Southport (Ditto)	500	0	0
1879—THOMAS, MISS LOUISA, Bowdon, Chester	900	0	0
1874—THOMPSON, JOHN, Esq., Nottingham (Free of Duty)	500	0	0
1878—THOMPSON, MISS SARAH, Bellevue, Manghold, Isle of Man (Ditto)	50	0	0
1859—THOMPSON, MRS. ANN, Greenwich	82	8	1
1865—THORNTON, RICHARD, Esq., Old Swan Wharf (Free of Duty)	2,000	0	0
1878—TINKLER, MRS. ELIZABETH, Brixton	5	0	0
1875—TOMKINSON, THOS., Esq., Bath	90	0	0
1866—TRAVIS, SAMUEL, Esq., Cheltenham (Free of Duty)	100	0	0
1873—TREDWELL, WM., Esq., Handsworth, Staffordshire (Ditto)	105	0	0
1878—TROWELL, WM., Esq., Fletton, Hunts (Ditto)	100	0	0
1869—TUCKETT, MISS LUCRETIA, Osnaburgh Street (Ditto)	100	0	0
1880—VANDELEUR, RICH. J. O., Esq., Dublin	425	0	0
1863—VENABLES, THOMAS ARUNDEL, Esq., Worcester	450	0	0
1872—WALDRON, MISS MARIA, Trowbridge (Free of Duty)	100	0	0
1867—WALKER, CHARLES, Esq., Southport (Ditto)	100	0	0
1870—WALKER, MISS MARY, Coates, N.B. (Ditto)	500	0	0
1869—WALKER, MRS. MARY ANN, Onslow Square (Ditto)	500	0	0
1879—WALLACE, WM., Esq., Curtain Road, Shoreditch	550	19	4
1872—WALMESLEY, MRS. C. E., Connaught Square (Free of Duty)	300	0	0
1869—WARNER, MRS. ANNE, Lyncombe, Somerset	224	10	0
1869—WARNER, MISS ELIZABETH SOPHIA (Free of Duty)	350	0	0
1876—WATKINS, CAPT. W., R.N., Croydon (Ditto)	100	0	0
1871—WATSON, MRS. ELIZA, Loughton, Essex (Ditto)	100	0	0
1861—WATSON, MRS. WILHELMINA, Berwick-on-Tweed	450	0	0
1880—WEBB, MISS ANN, Brighton (Free of Duty)	50	0	0
1864—WEBSDALE, W., Esq., Ipswich (Ditto)	79	16	0
1862—WEST, DR. CHARLES TURNER, Hull	90	0	0
1879—WEST, RICHARD THORNTON, Esq., Streatham Hall, Exeter (Free of Duty)	500	0	0
1864—WHEELHOUSE, G., Esq., Deptford (Ditto)	260	0	0
1880—WHITE, MRS. ANN, Brockley	90	5	0
1877—WHITTINGHAM, MRS. J. P., Manchester Street, Manchester Square	303	4	4
1875—WILLIAMS, MRS. ROBINA, Edinburgh (Free of Duty)	1,000	0	0
1877—WILLIAMS, C. T. LLOYD, Esq., Cheltenham	540	0	0
1870—WOOD, MISS MARY ANN, Bath (Free of Duty)	100	0	0
1877—WOOD, GEORGE, Esq., Chelsea (Ditto)	1,000	0	0
1865—WOODBURN, MISS MARY FRANCES, Kensington Park Gardens	270	0	0
1875—WOODHOUSE, MRS. S. D., Upper Grosvenor Street (Free of Duty)	127	13	3
1879—WOODWARD, MISS SARAH, Oldham Place	1,800	0	0
1879—WRIGHT, MISS M.A., Cottingham, York	268	19	0
1875—WRIGHTSON, MRS. C. R., York	180	0	0
1875—YATES, MRS. HANNAH, Sheffield	300	0	0
1879—YEARSLEY, E. H., Esq., Roma, Queensland	46	7	6

LIST OF DONATIONS AND ANNUAL SUBSCRIPTIONS.

** Donations of £5 and under are omitted after having been published *once* in the Report.

HER MOST GRACIOUS MAJESTY THE QUEEN (Annual, £50) (1853) £100 0 0
 HIS ROYAL HIGHNESS THE PRINCE OF WALES, K.G. 135 0 0

	Ann. Subs.	Donations.		Ann. Subs.	Donations.
	£. s. d.	£. s. d.		£. s. d.	£. s. d.
A. B.	0	5	0	Adam, Messrs. John and James and Co.	1 1 0
A. B., per Williams, Deacon, & Co. (1864-8)		90	0 0	Adams, A., Esq., Skelwith	0 10 0
A. B., Penryn (1872-9)		8	0 0	Adams, Edgar T., Esq., Halstead	1 1 0
A. C., Croydon (1859-79)		115	0 0	Adams, Mr. J., Brecknock Rd.	0 10 6
A. C., In Memoriam (1871)		20	0 0	Adams, R., Esq., St. Ives	1 1 0
A. C. S. (1875)		10	0 0	Adamson, A., Esq.	1 1 0
A. D. M., Mrs., born Hawkins, in memory of two Officers Indian Army (Madras), Hawkins and Spinks (many years deceased) (1876)	1,000	0	0 0	Addington, Mrs. Henry (1873)	10 0 0
A. J., Eastbourne (1868)		100	0 0	Agar, W. T., Esq. (1870-80)	30 0 0
A. L., Guildford (1863-79)		80	0 0	Aldam, William, Esq.	1 0 0
A. L., A. W., and M. W., Wimbledon (1877-80)		46	4 3	Alexander, T. H., Esq. (1873-5)	21 0 0
A. M. B. (1877)		10	0 0	Alexander, The Misses	1 1 0
A. M. T. (1878-80)		0	10 0	Allen Bros. and Co., Messrs.	1 1 0
A. O. E. (1864-74)		150	0 0	Allen, Captain Thomas Acland, the late, of the barque <i>Star of Devon</i> , per G. C. Allen, Esq. (1879)	5 0 0
A. P. R.	1	0	0 0	Allen, C. F. R. Esq. (1869-76)	10 0 0
A. S. W. (1875-7)		31	10 0	Allen, Hanbury, & Co. Messrs.	1 1 0
A Friend. In memory of E. B. C. (1879)		0	10 0	Allen, J., Esq., Cornhill	1 1 0
A Friend, per Miss English (1878-79)		1	0 0	Allen, Murray, & Co., Messrs.	1 1 0
A Friend (1879)		5	0 0	Alloa Branch (1880)	30 14 11
A Friend (1872)		15	0 0	Alrutz, R., Esq.	1 1 0
A Friend at Edinburgh (1880)		5	0 0	Alston, Chas. H., Esq.	2 2 0
A Friend at Leominster (1869-78)		37	0 0	Alston, Hamilton, & Co. Messrs.	1 1 0
A Friend at Llangollen	1	0	0 0	Almouth Branch (1880)	5 0 0
A Friend at the Annual Meeting (1872)		10	0 0	Amos, Mrs. M., St. Ibbs	1 1 0
A Friend, in aid of the cost of the new Boat House for Worthing (1874)	100	0	0 0	Amphlett, Rev. J.	1 1 0
"A Gift, in the event of being lost at Sea, by the late Mr. John Beverley Pilley, of Boston, Lincolnshire. He subsequently perished in a cyclone in the Gulf of Mexico, with all hands, in the schooner <i>Challenger</i> , on his passage from New Orleans to Jamaica, October, 1873" (1875)		26	5 0	Anderson, C. A., Esq.	2 2 0
A Lady, per John Eden, Esq. (1868)		50	0 0	Anderson, Mrs. J., Dalhousie	2 2 0
A Lady, per J. B. Parker (1863-73)		135	0 0	Anderson, Thomson, & Co. (1868)	10 0 0
A Lady, per W. H. Moore, Esq. (1876)		10	0 0	<i>Andrimu V.</i> , Austrian barque, Underwriters of the cargo of the (1879)	26 5 0
A Mother whose Son was Lost at Sea (1869-74)		12	0 0	An old Sailor, Native of Faversham, now of Canada (1875)	40 0 0
A Sailor's Sister (1880)		1	0 0	Anonymous (1872)	10 0 0
A Shipowner, Greenock		5	0 0	Anonymous (1873-4)	10 0 0
A Sympathiser (1879)		1	0 0	Anonymous, per Messrs. Barclay, Bevan, & Co. (1874-6)	350 0 0
A Thank-offering for a Son's preservation at Sea (1870)		10	0 0	Anonymous, "W." (1878)	100 0 0
Ditto, for safe return of Sons from long Voyages (1874)		10	0 0	Anson, Miss, Chester (1875)	10 0 0
A Thank-offering from F. R. A. (1879)		100	0 0	Antrobus, Hugh Lindsay, Esq., <i>Treasurer</i> (1878)	10 10 0
A Thank-offering, from T. H. L. (1867-76)		54	0 0	Antrobus, Miss C. H. (1865-79)	17 4 0
A Thank-offering, per Rev. R. T. Taylor (1880)		0	10 0	Ditto	2 0 0
A Thank-offering ("Let not the deep swallow me up") (1871)		25	0 0	Appleyard, Mrs., Bath (1879)	1 0 0
Aberdeen Ship-masters Society (1871-9)		8	8 0	Archer, J., Esq.	1 1 0
Abney, Rev. Canon		1	1 0	Arden, C. W. Esq., Hull (1879)	1 0 0
Ackers, Mrs., Hyde Park		5	0 0	Ardressan Branch (1880)	15 0 0
Acland, Sir T. Dyke, Bart., M.P. (1875)		10	0 0	Arkwright, J. C., Esq.	1 1 0
Acocks Green and Yardley Branch (1880)		32	2 5	Armitage, Miss H., Bath	1 1 0
Acton, Miss, Teston (1879)		2	0 0	Armourers & Braziers, Worshipful Company of (1880)	10 10 0
				Armstrong, Mrs., Huntingdon	0 10 6
				Armstrong, Henry, Esq.	1 1 0
				Armstrong, Sir W. G., F.R.S.	1 1 0
				Arnold, Mrs. Francis	1 1 0
				Artill, J. D., Esq.	0 5 0
				Ash, Hy., Esq., Weston	0 10 0
				Ash, W., Esq., Weston	0 10 0
				Ashby, Capt., Naseby	1 1 0
				Ashby, James, Esq.	0 10 6
				Ashtown, Lord (1867-80)	110 0 0
				Ashwood, John, Esq.	1 1 0
				Astell, Mrs. H. D. (1866-73)	13 10 0

	Ann. Subs.		Donations.			Ann. Subs.		Donations.			
	£.	s. d.	£.	s. d.		£.	s. d.	£.	s. d.		
Astley, Miss, Princes Gardens	2	0	0		Barnett, John, Esq. (1867-80)			55	0	0	
Atkinson and Co., Messrs.	2	2	0		Barnett, Mrs. Meopham Court (1874-7)	20	0	0	0		
Atkinson, G. C. W., Esq.	2	2	0		Barningham, Thos., Esq. (1873-7)	20	0	0	0		
Atkinson, Lieut.-Col. Ralph (1873)			10	0	0	Barras, Mrs., Farnacres	2	2	0		
Atkinson, W., Esq., Beckenham	1	1	0		Barrett, H., Esq.	1	1	0			
Attenborough, R., Esq., Sawtry	1	0	0		Barrington, R., Esq.	0	10	0			
Attwell, T. M., Esq.	1	1	0		Barron, F., Esq.	2	2	0			
Auerbach, Emil, Esq.	1	1	0		Barron, W. T., Esq.	1	1	0			
Auldjo, Henry, Esq., Cowes (1851-80)	45	13	0		Barrow, A. M., Esq.	1	1	0			
Austin, F., Esq., Aubert Park	2	2	0		Barry, F. T., Esq., for the barques <i>Mertola, Snowden, and Umgeni</i>	3	3	0			
Ditto (1880)	10	0	0		Barton, Bertram F., Esq. (1873-5)			10	10	0	
Austin, G., Esq., London St.	1	1	0		Barton, Daniel, Esq. (1868-73)			20	10	0	
Austin, Mrs., Bethnal Green	1	1	0		Bartram, William, Esq.	1	1	0			
Austin, Mrs., Clifton	1	0	0		Bastard, T. Horlock, Esq.	1	0	0			
A Well Wisher and Regular Subscriber (1880)			30	0	0	Bates, Colonel Robert	1	1	0		
					Bath Branch (1879)			18	1	6	
B. B., per Mrs. Dalton (1880)			1	1	0	Batten and Edwards, Messrs.	1	1	0		
B. H. C. (1872-9)			80	0	0	Batten and Ginner, Messrs.	1	1	0		
B. Y.	1	1	0		Batthyany, Count Edmund	1	0	0			
Baber, Harry H., Esq. (1870)			10	10	0	Bax, E., Esq., Cockspur St.	1	1	0		
Backhouse, James E., Esq.	5	0	0		Bax, H. A., Esq.	1	5	0			
Bacup Co-operative Stores (1868-79)	115	0	0		Baxter, John George, Esq.	1	1	0			
Badcock, H., Esq.	1	0	0		Bayley and Ridley, Messrs.	1	1	0			
Badcock, H. J., Esq.	0	10	0		Baylis, T. C., Esq.	2	2	0			
Bagehot, Hicks, and Co.	1	1	0		Bayly, Miss, Plymouth (1875)			10	0	0	
Bagehot, T. W., Esq. (1873)			50	0	0	Bazett, Lieut.-Col. C. G. (1867-79)			12	0	0
Bailey, E., Esq., Berners St.	1	1	0		Beach, Messrs. & Co.	1	1	0			
Bailey, E. H., Esq., ditto	1	1	0		Beachcroft, Miss, Talbot Sq.	1	1	0			
Baillie, Mrs. E. F., Leicester	1	1	0		Beart, Mrs., Godmanchester	1	1	0			
Baily, Miss A. L., Sudbury	1	1	0		Beaumont, G., Jun., Esq.	1	1	0			
Baily, Miss E., ditto	1	1	0		Beaumont, Mrs., Durham Terrace			0	10	6	
Bainbridge, E. M., Esq., Disington	1	1	0		Beckett, Rev. W. P., B.A.			0	10	0	
Baines, Charles J., Esq.	1	1	0		Beckett, James, Esq., Senr., Rathmines (1876-8)			20	0	0	
Baker, John, Esq., Clapham	1	0	0		Beddoes, Mrs. C. C.	1	1	0			
Baker, Mrs., ditto	0	10	0		Beddoes, Miss A. F. E.	2	0	0			
Baker, Gen. Sir W. E.	2	2	0		Bedford, Henry, Esq.	1	1	0			
Baker, Rev. Sir T. H. B., Bart.	1	1	0		Beech, W. T., Esq., Holloway	1	1	0			
Baker, Sir George, Bart. (1865-74)	25	0	0		Begbie, T. S., Esq.	0	10	6			
Balderson, Mrs., Hanover Sq.	1	1	0		Begley, Mrs., Hammersmith (1862-79)	21	0	0			
Baldwin, Alfred, Esq. (1877)	10	10	0		Belcher, Lady (1864-73)			12	6	0	
Balézeaux, Captain Ed., Inspector, French Lifeboat Society	1	1	0		Belcher, Lady	1	1	0			
Balfour, John B. Esq. (1868-75)	10	14	0		Ditto (1880)			1	1	0	
Balkwill, Robt. Coad, Esq.	1	1	0		Belcher, Miss H.	2	2	0			
Ball, Mr. William (1878-80)			0	12	6	Belfast & Groomsport Branch (1880)	49	18	3		
Ballard, George, Esq., the late, Residuary Legatees of, per Mrs. Ballard (1875)	50	0	0		Bell, Alex., Esq., Tooting	1	1	0			
Ballycotton Branch (1880)	25	0	0		Bell, Messrs. Alexander, & Co.	1	1	0			
Banff and Macduff Branch (1880)	20	0	0		Bell, Mrs. L.	1	0	0			
Banfield, R., Esq.	1	1	0		Bell, Mrs. Mary, Maldon	1	1	0			
Bannockburn Branch (1880)	11	8	6		Bellamy, Miss	2	2	0			
Barber, V., Esq.	0	5	0		Ditto (1880)			1	1	0	
Barber and Co., Messrs. J.	1	1	0		Belli, W. H., Esq., The Courtlands (1861-74)			31	2	0	
Barclay and Sons, Messrs.	2	2	0		Belper Branch (1879)			15	0	6	
Baring Bros. & Co., Messrs.	5	0	0		Belsham, J., Esq., Heybridge	0	10	0			
Barker, F. C., Esq., Leigh (1871-80)	9	0	0		Benecke, Otto A., Esq. (1873)			10	10	0	
Barker, Miss, Cornwall Terrace (1880)	2	0	0		Benefink, S. A. & Co., Messrs.	0	10	6			
Barkworth & Spaldin, Messrs.	1	1	0		Benham, John, Esq.	1	1	0			
Barkworth, J. B., Esq., Hull (1873)	50	0	0		"Benjamin," per C. Few, Esq. (1869)	100	0	0			
Barkworth, Miss M., Tunbridge Wells (1879)	50	0	0		Bennetts, Miss Olympia (1864-79)	50	0	0			
Barlow, Miss, Kersal	2	2	0		Bentinck, Lady	25	0	0			
Barnard, Rev. Thomas (1879)	10	0	0		Ditto			10	0	0	
Barnard, Rev. Wm. (1878-9)	10	0	0		Bentley, Mrs. S. C., Croydon (1873-80)	3	0	0			
Barnardiston, N. C., Esq.	1	1	0		Beresford, Mrs. L.	1	1	0			
Barndillon, E. D., Esq.	0	10	0		Berman's Charity, Trustees (1879)	10	10	0			
Barnes, O., Esq.	0	0	5	0	Berry, George, Esq.	0	10	6			
Barnett Bros., Messrs.	2	2	0		Best, Mrs. W.	1	1	0			
					Bettell, Wm., Esq., Brixton (1874-80)	19	19	0			
					Bevan, Geo. J., Esq.	1	1	0			
					Beveridge, Capt.	1	1	0			
					Bicknell, Rev. C. Brooke, M.A. (1868)	25	0	0			
					Bieber & Co., Messrs. (1879)	1	1	0			
					Billingsley, Capt., R.N.	0	10	0			

	Ann. Subs.		Donations.	
	£.	s. d.	£.	s. d.
Bulkeley, Miss Louisa, Brighton (1866-80)			150	0 0
Bullard, King, & Co., Messrs.	1	1 0		
Bulloch, Messrs. J. & G., & Co.	3	3 0		
Bunbury, Sir Charles, Bart.	3	0 0		
Bunn, Mrs. Sydenham	2	2 0		
Bunn, Miss, Sydenham	0	10 6		
Burbidge, Pritchard, and Bartleet, Messrs.	1	1 0		
Burchell, J. D., Esq.	1	0 0		
Burden, Stephen, Esq.	1	0 0		
Burgess, the Misses	0	10 0		
Burgoyne, Montagu G., Esq.	2	2 0		
Burgoyne, Thos., Esq. (1871)			10	10 0
Burmester, Miss	1	1 0		
Burn, S., Esq.	1	1 0		
Burnaby, Rev. F. G.	2	0 0		
Burnett, D. W., Esq.	0	5 0		
Burnett, E. L., Esq.	1	1 0		
Burnett, W. H. W., Esq.	1	1 0		
Burney and Co., Messrs.	2	2 0		
Burr, D. Higford D., Esq.	2	0 0		
Burrell, H., Esq., Gravesend	1	1 0		
Burrell, Hy., Esq., New Square	2	2 0		
Burslem Branch (1879)			39	19 6
Burton-on-Trent Branch (1879-80)			63	14 0
Burton, Rev. R. C.	0	5 0		
Burton, W. E., Esq. (1859-70)			15	0 0
Burton, W. Hally, Esq.	1	1 0		
Busfield, Capt. J.	1	1 0		
Busk, Capt. Hans	1	1 0		
Busk, Mrs. (1869-78)	27	4 0		
Butcher, Mrs. M. A., Islington, towards support of Margate and Yarmouth Life-boats (1873)	200	0 0		
Butler, C., Esq., Drury Lane	0	10 0		
Butler, Paul, Esq. (1873-4)			11	0 0
Butler, S., Esq., Fen Court	2	2 0		
Butlin, C., Esq., Nottingham	1	1 0		
Butlin, Thomas, Esq.	0	10 0		
Butterworth, Edward, Esq. (1878)	20	0 0		
Buxton, Fras. W., Esq. (1874)	10	0 0		
Byng, Admiral J. L.	1	1 0		
C., Mrs. M. L., South Australia, "In grateful remembrance of her merciful preservation from imminent dangers by sea in 1862" (1866-79)	110	0 0		
C. H. A. C.	0	10 0		
C. L. (1865-9)			50	0 0
C. S. (1860-8)			80	0 0
C. S. and G. S. (1874)			11	0 0
C. T. (A Seaman's Daughter, produce of her Needlework) (1864-72)	60	0 0		
Cain, Geo., Esq.	0	5 0		
Cain, Miss, Edmonton	0	5 0		
Caldwell, J., Esq., Starcross (1878)	100	0 0		
Calrow and Son, Messrs. J.	1	1 0		
Cameron, A. W., Esq., Liverpool (1879)	1	1 0		
Cameron, Miss, Hillwood	2	0 0		
Campbell, Arthur E., Esq. (1871)	50	0 0		
Campbell, C. M., Esq., Stoke	2	2 0		
Campbell, Mrs. Emma R.	1	1 0		
Candler, P. W., Esq. (1872-5)	40	0 0		
Cann, James, Esq.	1	1 0		
Capel, Frank C., Esq.	5	5 0		
Capel, J. D., Esq.	1	1 0		
Capel, Messrs. Arthur & Co.	1	1 0		
Carbutt and Co., Messrs.	1	1 0		
Cardale, Rev. E. T.	0	10 0		
Carew, Mrs. G., Mytton Hall	2	2 0		
Carew, Rev. Gerald	1	1 0		
Carew, Mrs. Hallowell (1870-80)	100	0 0		

	Ann. Subs.		Donations.	
	£.	s. d.	£.	s. d.
Carew, T., Esq., Colli priest	1	0 0		
Carew, Capt. R. Pole	1	0 0		
Carey and Browne, Messrs.	1	1 0		
Carey, S. W., Esq., New York, \$100 (1876)	18	16 4		
Carlingford, The Right Hon. Lord			2	0 0
Carlisle, The Bishop of	1	1 0		
Carmichael, Sir W. G., Bart.	2	0 0		
Carmarthen Bay Branch (1879-80)			10	0 0
Carr, W. J., Esq.	1	1 0		
Carrera, C. L., Esq.	1	1 0		
Carson and Sons, Messrs. W. (1879)	10	10 0		
Carter, Rev. S. R., B.D. (1875)	10	10 0		
Cartwright, Col. H.	1	1 0		
Cartwright, Capt. R. Norton	1	0 0		
Cartwright, Miss, Bury St. Edmunds (1862-79)			140	0 0
Cartwright, Mrs., Ellingham	0	10 0		
Cartwright, Rev. R.	1	0 0		
Cassell, Smith, & Co., Messrs.	1	1 0		
Cator, Miss S. H. Bertie (1861-73) Ditto			18	13 0
Cator, Mrs. Wm. A.	1	1 0		
Cator, Sir J., & Sons	1	1 0		
Cave, B., Esq., Wigmore St.	0	10 6		
Cave, L. T., Esq., F.R.G.S.	2	2 0		
Cave-Browne-Cave, Mrs. Ed- ward F.	2	2 0		
Cave, The Rt. Hon. Sir S., G.C.B.	2	2 0		
Cave, W., Esq., Wigmore St.	0	10 6		
Chads, Admiral	1	0 0		
Chadwick, Mrs.	1	1 0		
Chalmers, Guthrie, and Co. (1871)	10	10 0		
Chalmers, Sir David, Demerara	1	1 0		
Chamberlain, Herbert, Esq.	2	2 0		
Chamberlain, Lieut. T. J.	1	0 0		
Chamberlain, Miss C.	1	1 0		
Chamberlain, Richard, Esq.	1	1 0		
Chamberlain, Tankerville J., Esq. (1870-9)			12	2 0
Champion, F. C., Esq., Clap- ham	1	1 0		
Chance, E., Esq., Lawnside	2	2 0		
Chaplin, E., Esq., Hamburg (1867-74)	26	5 0		
Chapman, T., Esq., F.R.S., Chairman			21	0 0
Chardless, H., Esq. (1867-80)			42	13 0
Charles, Mrs., Finchley	1	1 0		
Charley, E., Esq., Lisburn	0	10 0		
Charley, Mrs., and Family, Dunmurry			1	0 0
Charrington, Miss E., Woodsleigh (1875)	10	0 0		
Chatterton, Miss J., Dublin	1	0 0		
Chavasse, Mrs. Horace	1	1 0		
Chayter & Webster, Messrs.	1	1 0		
Cheape, G. C., Esq., Wellfield (1864-78)	51	10 0		
Cheesman, G., Esq., Camden Rd.	3	3 0		
Cheetham, C., Esq.	2	2 0		
Cheltenham Branch (1879)			10	11 0
Chetwynd, Capt. the Hon. C. C.	1	1 0		
Chester Branch (1880)			21	19 0
Chester, C., Esq.	5	0 0		
Chichester Harbour & Selsey Branch (1880)			30	0 0
Child and Co., Messrs.	2	2 0		
Childers, Rt. Hon. H. C. E., M.P.	1	1 0		
Childers, Miss L.	1	1 0		
Cholmondeley, The Marquis of	2	2 0		
Chorlton, Isaac, Esq., With- ington			1	1 0
Christy and Co., Messrs., Grace- church Street			1	1 0
Christie, Mrs. (1878)			10	10 0
Chudleigh, Mrs.	2	2 0		
Church and Son, Messrs.	0	10 0		

	Ann. Subs.	Donations.
	£. s. d.	£. s. d.
Church, Rev. G. L.	0 10 6	
Chuter, Mrs., Croydon	2 2 0	
Civil Service Life-boat Fund, <i>vide p.</i> 94.		
Clark, W., Esq., Brompton	2 2 0	
Clarke and Rowe, Messrs.	1 1 0	
Clarke, H. M., Esq.	2 0 0	
Clarke, Mrs. Cowden	1 1 0	
Clarke, Stephenson, Esq. (1868)		10 0 0
Clarke & Co., Stephenson	2 2 0	
Clarke, The Misses, Carlisle	2 0 0	
Clatworthy, J., Esq.	1 0 0	
Clayton, Colonel Fitz-Roy	2 0 0	
Clayton, C. H., Esq.	1 1 0	
Clayton, F. S., Esq.	1 1 0	
Clayton, Sir Wm. R., Bart.	10 10 0	
Clayton, T. W., Esq., Ryde (1859-73)		15 0 0
Clegram, W. B., Esq., J.P.	2 2 0	
Clerk, Major-Gen. H., R.A.	1 1 0	
Clermont, Lord	2 2 0	
Clermont, Lady	1 1 0	
Clevedon Life-boat Fund, <i>vide p.</i> 94.		
Clifford, Messrs. C., & Son	1 1 0	
Clifford, Colonel	2 0 0	
Clinton, Lady Charlotte P.	1 1 0	
Cloid, Routledge, and Co.	2 2 0	
Close, Rear-Admiral F. A.	1 1 0	
Clothworkers, Worshipful Company of (1879)		10 10 0
Clowes, R., Esq., Stockwell (1861-79)		19 17 6
Clutterbuck, Mrs. C. F.	2 2 0	
Coal Factors' Society	5 5 0	
Coal Merchants' Society	5 5 0	
Coates, James, Jun., Esq., Paisley (1874)		20 0 0
Coates, Jos., Esq., North Bank	1 1 0	
Cock, Miss E. A. (1868-80)		65 0 0
Cockey, E., Esq. & Mrs., Frome	0 10 0	
Coffin, Admiral H. E. (1867-78)		34 10 0
Cole, A. C., Esq., Lee	1 1 0	
Coleman, Capt. G., Sandwich	1 1 0	
Coleman, Rev. W. (1863-79)		6 10 0
Coles, J., Esq., Throgmorton Street	1 1 0	
Coles, Miss A., West Hove	0 10 6	
Coller, Mrs. (1878)		50 0 0
<i>Ditto</i>	1 1 0	
Collet, W. W., Esq.	1 1 0	
Collie, Dr. G. D. Milne	1 0 0	
Collier, Messrs. F. H. & A.	1 1 0	
Collin, J., Esq., Lewisham	1 1 0	
Collin, Miss, Gower St.	2 2 0	
Colling, Joseph, Esq., Islington (1875)		10 10 0
<i>Ditto</i>	1 1 0	
Collingwood, Miss M. A.	1 1 0	
Collinson, Admiral Sir R., K.C.B.	1 1 0	
Collinson, Miss A. M., Weston (1865-80)		67 9 0
Colonial Company (Limited)	2 2 0	
Colvill, Colonel (1873-80)		1 10 0
Colville, Lord	2 2 0	
Colvin, Miss E. H.	2 2 0	
Commeline, Thomas, Esq.	0 10 0	
Commercial Union Assurance Company (1879)		10 10 0
Comptoir d'Escompte de Paris	3 3 0	
Conlan, F. P., Esq., Lincoln	1 1 0	
"Continental Daily Parcels Express"	1 1 0	
Conyngnam, Marquis of	2 2 0	
Cooch, Mrs. R.	2 2 0	
Coode, Sir John	1 1 0	
Cook, Mrs. A.	0 5 0	
Cooke, Mrs. Martha (1865-71)		20 0 0
Cooper, Cooper, & Co., Messrs.	1 1 0	
Cooper, J. E., Esq., Milford	2 2 0	
Coote, Thomas, Esq.	1 1 0	
Coplestone, Rev. W. C. (1878-9)		0 15 6

	Ann. Subs.	Donations.
	£. s. d.	£. s. d.
Copley, Miss E. M. (1879)		2 2 0
Corbett, Miss, Brighton	1 1 0	
Cordes, T., Esq., Bryn Glas (1869)		10 10 0
<i>Ditto</i>	2 2 0	
Cordwainers, Worshipful Company of (1875)		21 0 0
Cork and Queenstown Branch (1880)		50 0 0
Cornell, Geo., Esq., Coleshill	1 1 0	
Cornell, R., Esq., New Cross	1 1 0	
Cornell, Samuel, Esq., Chelsea	1 11 6	
Cornish-Bowden, Admiral W.	2 2 0	
Corrie, Mackie, & Co., Messrs.	2 2 0	
Corrie, Rev. E. S., in memory of E. B. C.		0 10 0
Corrie, A. J., Esq., Dunrod	1 1 0	
<i>Ditto</i> (1880)		1 1 0
Corscaden, Mrs., Holland Park	5 5 0	
Cory, Miss, Stamford	1 0 0	
Coster, Capt.	1 1 0	
Cotesworth, Mrs., Cowdenknows (1867)		10 0 0
Cotesworth, W., Esq., <i>Ditto</i>	1 1 0	
Coupland, J. M., Esq., Tinsley (1859-71)		15 0 0
Courage and Co., Messrs., Horse-lydown (1859-69)		30 0 0
Court, A., Esq., R.N.	0 5 0	
Court and Co., Messrs.	0 5 0	
Courtenay, Messrs. J. & W. J.	2 2 0	
Courthope, G. C., Esq.	1 1 0	
<i>Ditto</i> , in aid of Sussex Life-boats	1 0 0	
Courtney, J. W., Esq., Chelsea	1 1 0	
Courtney, Miss, Stoney Cross	1 0 0	
Coutts and Co., Messrs.	10 0 0	
Covent Garden Life-boat Fund, <i>vide p.</i> 94.		
Cowie, T. S., Esq. (1863-74)		21 0 0
Cowie, Mrs. In remembrance of little Alfred's 13th birthday (1880)		1 1 0
<i>Ditto</i> , and Family (1872-80)		9 6 6
Cox and Co., Messrs.	5 5 0	
Cox, Henry, Esq., Trevereux (1864-77)		50 0 0
Cox, Miss	1 1 0	
Cracklow, General	2 0 0	
Cranfield, Wm. Esq.	1 1 0	
Craven, Miss S.	0 5 0	
Crawley, Edmund, Esq.	0 5 0	
"Credo," Exon.	0 10 0	
Crichton, Alexander, Esq. (1864-71)		10 10 0
Crichton, Lieut.-Col. Hon. C.F.	2 0 0	
Crichton, Viscount	2 0 0	
Croggon & Co., Messrs. T. J.	0 5 0	
Crosse, Mrs. St. Croix	1 1 0	
Crosse & Blackwell, Messrs.	5 5 0	
Crossley, Messrs. John & Sons (Limited), Halifax		10 0 0
Crowley, J. S., Esq., Croydon	1 1 0	
Croxall, R. F. T., Esq.	2 2 0	
Cruddas, Charles J., Esq.	1 1 0	
Cruddas, W. D., Esq.	1 1 0	
Crum-Ewing, J. D., Esq.	1 1 0	
Cuff, Miss (1872-9)		10 0 0
Cullingford, W. H., Esq.	2 2 0	
Cumberlege, Miss A. T.	1 0 0	
Cunynghame, Hugh, Esq. (1864-80)		62 0 0
Curling, Miss Martha, Camberwell (1880)		5 0 0
Curme, Admiral C. T.	0 10 0	
Curry, Miss, Charlton Kings	1 0 0	
Curteis, Whitworth, and Co., Messrs.	1 1 0	
Curtis, R. Mayne, Esq.	1 1 0	
Curwen, Mrs. Ewing	1 1 0	
Cutbill, Reginald, Esq.	0 10 0	
Cutbill, W. J., Esq.	1 1 0	
Cutler, Palmer, & Co., Messrs.	1 1 0	

	Ann. Subs.		Donations.			Ann. Subs.		Donations.	
	£.	s. d.	£.	s. d.		£.	s. d.	£.	s. d.
Da Costa, Miss, Oxford Terrace (1875)	500	0 0			Donaldson, George, Esq., New Bond Street (1873-8)	23	2 0		
Daggett, Mrs. P.	1	1 0			Donkin, R. S. Esq.	10	0 0		
Dalgety, Du Croz, and Co., Messrs.	2	2 0			Douglas, Sir Percy, Bart.	0	10 0		
Dallas, Sir George (1873-80)			32	0 0	Dovers, George, Esq.	1	1 0		
Dalkeith Branch (1879)			13	0 0	Dowling, E. S., Esq.	1	0 0		
Dalton, General Edward T.	1	0 0			Downes, Edward, Esq.	0	5 0		
Dalton, H., Esq., Tunbridge Wells (1874-80)			18	0 0	Downshire, Marchioness of	1	1 0		
Dalton, Mrs. H. (1874-80)			17	0 0	Doxat, Miss C., Newcastle	0	10 6		
Dalton, Miss, Clapham	1	1 0			Doyle, P. W., Esq.	2	2 0		
Dalton, Miss Hannah, ditto	1	1 0			Drake, J. V., Esq.	0	10 0		
Dalton, Mrs. Segrave (1869)			20	0 0	Drake, T., Esq. (1867-74)			14	0 0
Dalton, T. Masters, Esq.	1	1 0			Draper, John, Esq.	0	10 6		
Daly, Hon. R.	1	0 0			Drapers, Worshipful Company of (1877)			52	0 0
Dampier, Mrs M.S., Winchester (1867-9)	10	0 0			Drogheda Branch (1880)			10	0 0
Dand, J., Esq., Sutton	1	1 0			Drummond, Capt. Alfred M.	2	0 0		
Daniel, Miss Emma	1	1 0			Drummond, Capt. C. G. A.	2	2 0		
Danson, Dr.	2	2 0			Drummond, Lady E. E. F.	2	0 0		
Darling, Lt.-Col. A.	1	1 0			Drummond, George F., Esq.	2	2 0		
Darling, Mrs., Cornwall Gds.	2	2 0			Drummond, Messrs.	10	0 0		
Darnley, The Earl of.	1	0 0			Drury, H. D., Esq.	0	10 0		
Davey, Rev. W. H.	0	5 0			Drysdale, R. P., Esq., Demerara	1	1 0		
Davis, Frederick, Esq.	3	3 0			Duarte, Miss	5	0 0		
Davison, A., Esq., Dudley	0	10 6			Duberly, Mrs.	1	1 0		
Davison, Newman, and Co.	1	1 0			Dublin Branch (1879)			20	0 6
Davson, G. L., Esq., Demerara	1	1 0			Dublin Port and Docks Board	75	0 0		
Davson, J.W., Esq., Demerara	1	1 0			Du Croz, F.A., Esq. (1880)			10	0 0
Davy, F., Esq., Topsham	1	0 0			Dugmore, Lieut.-Col.	1	1 0		
Davy, Yates, and Routledge.	1	1 0			Duncan, G., Esq., East India Avenue	5	5 0		
Dawber, Robert, Esq.	1	1 0			Duncan, Miss, Bath	2	2 0		
Dawlish Branch (1880)			31	4 11	Duncombe, G. T., Esq.	3	3 0		
Dawson & Son, Messrs.	0	5 0			Dundee Branch (1879)			80	0 0
Dawson-Scott, Lt.-Col., R.E.	1	1 0			Dunfermline Branch (1880)			23	2 11
Day, John, Esq.	1	1 0			Dunn and Co., Messrs. W.	1	1 0		
Day, Mrs. F.	1	0 0			Dunn, Ernest H., Esq.	0	10 6		
Dayman, C. O., Esq.	3	0 0			"Dunsappie" (1874)			10	0 0
De Chaville, Mrs. G. (1880)			2	2 0	Dunsford, Miss (1873-80)			8	8 0
Deacon, Messrs. E. and A.	1	1 0			Durnford, Rev. Edmund.	1	1 0		
Deacon, W. M., Esq.	0	10 6			Durrant, Capt. F., R.N.	2	0 0		
Dean, Albert A. & Co., Messrs.	1	1 0			Dyas, Capt. R. H.	3	0 0		
Dean, Rosser S., Esq.	1	0 0			Dyer, Wm., Esq.	3	3 0		
Deane, Mrs., Chelsea (1879)			1	0 0					
Deane and Co., Messrs., King William Street	1	1 0			E. (1869)			50	0 0
Deans, Mrs., Stockwell	1	1 0			E. A. (1870)			10	16 0
De Kantzow, Rear-Adm. H. P.	3	3 0			E. A. B. (1872-5)			17	0 0
De la Granja, The Marquis	1	0 0			E. A. V. (1879)			3	0 0
Dell, L., Esq., Pelham Crescent	1	1 0			E. B., a Thank-offering for mercies received (1869)			100	0 0
Delmé-Radcliffe, Comr., and Mrs.	2	0 0			E. C., Lancaster Gate	1	0 0		
Denison, Alfred, Esq.	2	2 0			E. C. (1872-5)			20	0 0
Denison, Lady	5	0 0			Ditto, a Thank-offering (1876)			10	0 0
Dennistown, A. H., Esq.	1	1 0			E. C. W. (1863-80)			7	0 0
Denny, T. A., Esq. (1867-8)			10	0 0	E. G. (1876-80)			19	0 0
Dent and Co., Messrs. E.	3	3 0			E. H. (1869)			10	0 0
Dent, George, Esq. (1872-4)			10	10 0	E. H. (1873)			10	0 0
Ditto	1	1 0			E. S., Nantwich (1880)			0	10 0
Dent, W., Esq., Streatham	10	10 0			E. V. A. (1875-7)			45	0 0
De Ste. Croix, Capt., H. C. S.	2	2 0	10	10 0	East and West India Dock Co. (1869)			52	10 0
Desborough, C. J., Esq.	1	1 0			East, Sir Gilbert A. C., Bart.	5	0 0		
Devall, Miss	0	10 0			Eastbourne Branch (1879-80)			23	19 10
Deverell, J., Esq.	1	1 0			Easton, John, Esq., M.D.	1	1 0		
Devey, The Misses	5	0 0			Eastwood, John F., Esq.	1	1 0		
Devitt and Hett, Messrs.	1	1 0			Ecroyd and Sons, Messrs.	3	3 0		
Devon, H. C., Esq.	1	1 0			Eden, Mrs. Henry	2	0 0		
Devon, The Earl of	2	0 0			Edge, W. M., Esq.	1	1 0		
Dew, Rev. E. Parker, M.A.	1	1 0			Edgeworth, M. P., Esq.	0	10 0		
Dickson, Mrs.	2	2 0			Edinburgh, Leith, and Granton Branch (1879)			263	6 4
Dickson, Rev. W. R.	1	0 0			Edwardes, T. D., Esq.	1	0 0		
Dixon and Harris, Messrs.	2	2 0			Edwards, J., Esq., Record Office	1	1 0		
Dixon, Mrs. R. R., Beltoft (1878-80)			7	0 0					
Domecq and Co., Messrs. P.	1	1 0							
Domville, Sir J. G., Bart.	1	1 0							

LIST OF DONATIONS AND ANNUAL SUBSCRIPTIONS.

	Ann. Subs.	Donations.		Ann. Subs.	Donations.
	£. s. d.	£. s. d.		£. s. d.	£. s. d.
Edwards, Miss, Clifton . . .	1 1 0		Fanning and Co., Messrs. W.	1 1 0	
Edwards, Miss M. (1871) . . .		50 0 0	Fanshawe, Mrs. F., Uckfield	0 10 0	
Edwards, S., Esq., Fenchurch Street	1 1 0		Fanshawe, Rev. Arthur A. (1872)		20 0 0
Edwards, S., Esq., Lewisham	1 1 0		Fanshawe, Adm. E. G., C.B.	1 1 0	
Egan, T. Selby, Esq.	1 1 0		Farmer, Capt. Wm. R. G. . . .	1 1 0	
Egerton, Capt. C. R., R.N., Widow of the late	5 0 0		Farnell, Mrs., Colchester . . .	1 1 0	
Egerton, Miss G. C.	2 0 0		Farquhar, Captain H. R., 24th Regt. (1865-74)		70 0 0
Egerton, Rev. J. C.	0 10 6		Favell, J. Milnes, Esq., Gates- head (1861-8)		20 0 0
Ekins, Mrs. P. J.	5 5 0		Featherstonhaugh, C., Esq. . .	1 0 0	
Elam, Miss	2 10 0		Feehey, John, Esq.	1 1 0	
Elder, A. L., Esq.	1 1 0		Fellows, H. D., Esq.	5 0 0	
Elias and Co., Messrs.	1 1 0		Fellows, C. F., Esq. (1868-9)		10 0 0
Eliot, Hon. H. C.	2 0 0		Felton, W. V., Esq. (1873) . . .		10 0 0
Ellen and Co., Messrs.	0 10 6		Fenwick, C. F., Esq.	5 0 0	
Elliot, Geo. Esq., Croydon (1873-7)		10 0 0	Fenwick, Capt. John	1 1 0	
Elliot, Sir Walter	1 0 0		Fenwick, Mrs. S. C.	1 0 0	
Elliott, Mrs., Bournemouth . .	2 2 0		Few, Rev. Charles E., M.A. . . .	1 1 0	
Elliott, Wm., Esq.	1 1 0		Field, Capt. E., R.N.	1 0 0	
Ellis and Sons, Messrs. H. . . .	1 1 0		Field, Rev. F., Heigham	1 1 0	
Ellis, Alderman (of London) . .	1 1 0		Field, J. P., Esq.	2 0 0	
Ellis, Capt., Lymington	2 0 0		Figgis, Samuel, Esq.	2 2 0	
Ellis, Mrs., Hampstead	1 1 0		Filliter, Freeland, Esq.	1 1 0	
Ellis, Miss, Hampstead	1 1 0		Findlater, Mackie, and Co. . . .	2 2 0	
Ellis, Mrs., Bognor	0 10 6		Finnis and Fisher, Messrs. . . .	1 1 0	
Elwes, J. H., Esq.	2 0 0		Fisher, Mrs., St. Neot's (1870-8)		7 13 0
Ely, The Most Noble the Marquis of	20 0 0		Fishmongers, Worshipful Company of (1873)		105 0 0
Emery, William, Esq.	0 10 6		Fishwick, J. H., Esq. (1871-80)		10 9 0
Emmerson, Mrs. Susan (1873-9)		6 4 0	Fishwick, S. E., Esq. (1875-80)		6 5 0
Engelhardt, L. A., Esq.	1 1 0		Fisk, Rev. J. H. (1857-71)		45 0 0
English, Arthur, Esq.	1 1 0		FitzRoy, Captain C. C. (1869)		10 0 0
English, Capt., R.E.	1 0 0		Fladgate, Mrs., Staines	1 1 0	
Engström, George, Esq.	1 1 0		Fleetwood Branch (1880)		60 0 0
Entwistle, Thomas, Esq.	3 0 0		Fletcher, G. Hamilton, Esq. . . .	3 3 0	
Epps, Jas., Esq., Norwood	1 1 0		Fletcher, W., Esq., Chelten- ham		2 0 0
Erne, The Earl of, K.P.	1 0 0		Flood, Frederick, Esq.	5 5 0	
Erne, The Countess of	1 0 0		Flower, C. E., Esq. (1859-69)		21 0 0
Ernsthausen and Oesterley, Messrs	1 1 0		Ford, Mrs., Croydon (1872-9)		12 5 0
Esse, F., Esq. (1877-9)		3 3 0	Foreman, Mr. Owen	0 5 0	
Estridge, Edward, Esq.	1 1 0		Foresters, Ancient Order of, <i>vide p. 94.</i>		
Evans, Capt. F. J. O., R.N., C.B., F.R.S.	2 2 0		Forrester, Major-General	1 1 0	
Evans, Mrs., Seymour Street . .	2 0 0		Forrester, Miss (1870-9)		40 0 0
Evans, Mrs. W., Chesham St. . .	2 2 0		Forrow, B. A., Esq., and Edwin Taffs, Esq., Poplar (1874)		10 10 0
Evatt, Miss C. Hanning (1878)		10 10 0	"For those in peril on the Sea" (1872-9)		36 0 0
Eversfield, C. G., Esq.	1 1 0		Fortnum, Mason, and Co., Messrs.		2 2 0
Ewart, Macaughy, and Co. Messrs.	2 2 0		Foster, James L., Esq. (1875-8)		20 0 0
Ewart, Miss Mary A.	3 3 0		Foster, Rev. Sir C., Bart.	2 2 0	
Ewart, William Lee, Esq.	10 0 0		Foster, Richard, Esq.	5 0 0	
Ewing, W. Orr, Esq.	5 0 0		Fowler, John, Esq., Sheffield (1874-7)		11 6 0
Exmouth Branch (1880)		20 0 0	Fowler, Wm., Esq.	1 1 0	
Eyre, G. J., Esq. (1872-80)		90 0 0	Fox, Rev. G. T.	1 1 0	
Eyre, Lieut.-Commr. R.N. (1878)		5 5 0	France-Hayhurst, Rev. T.	1 0 0	
Eyre, Rev. H. S.	1 0 0		Franklyn, H. W., Esq.	2 2 0	
Eyre, Mrs. Robert, Totton (1879)		0 10 6	Fraser, E., Esq., Insch (1872-8)		35 0 0
F. G. R. (1878)		10 0 0	Frazer, Miss Florence M.	1 1 0	
F. P. H. (1871)		10 0 0	Frazer, John, Esq., Cornhill . . .	1 1 0	
F. R. (1869)		50 0 0	Freeland, Messrs. J. and A. B. 1 1 0		
Faber and Co., Messrs. A.	2 2 0		Freeling, Mrs. (1869-79)		36 15 0
Fair, J., Esq.	2 2 0		Freeman, C., Esq., Leamington (1874)		10 0 0
Fairbank, H., Esq., Willenhall . .	1 1 0		Freeman, Miss, Canterbury (1872-9)		40 0 0
Fairthorne, E., Esq.	2 2 0		Freer, Rev. T. H., M.A.	1 1 0	
Fairthorne, Miss A.	5 0 0		Freshfield, Miss	1 1 0	
Fairthorne, Miss E.	1 1 0		Fribourg and Treyer, Messrs. . . .	0 10 0	
Falcon, Mrs. (1867-71)		15 0 0	Frith, Rev. Wm. A., M.A. (1871-80)		9 9 0
Falcon, Rev. R. S.	2 2 0		Frost Brothers, Messrs.	1 1 0	
Falmouth, The Viscount	5 0 0		Fry, The Hon. Justice	1 0 0	
Fane, W. D., Esq.	2 2 0		Fryer, Captain, Kingsworthy . . .	1 1 0	
			Ditto (1880)		10 0 0
			Fuller, Mrs. Trayton	2 0 0	
			Furley, Geo., Esq., Canterbury (1879)		5 0 0

LIST OF DONATIONS AND ANNUAL SUBSCRIPTIONS.

	Ann. Subs.	Donations.	
	£. s. d.	£. s. d.	
Haddington, The Earl of	1 0 0		
Haigh & Son, Messrs. W.	0 10 6		
Halford, Lady	1 1 0		
Hall, John, Esq., Addiscombe	2 2 0		
Hall, Miss M. S.	0 10 0		
Hall, Miss, Davenham	1 1 0		
Hall, Richard, Esq., Wigton	1 1 0		
Hallam, C. T., Esq.	0 10 0		
Hambro & Son, Messrs. C. J.	1 0 0		
Hamilton, F. A., Esq.	10 10 0		
Hamilton, John, Esq.	3 0 0		
Hamilton, Rear-Admiral, C.B.	1 0 0		
Hamilton, Major T. B.	1 1 0		
Hammick, Mrs. W. M.	1 1 0		
Hand, Vice-Adm. G. S., C.B.	1 1 0		
Hankey, Capt. F. T. B., R.N.	1 0 0		
Hankey, George, Esq.	1 1 0		
Hankey, Capt. Walter A. (1879)		10 10 0	
Hankey, Wm. Barnard, Esq.	1 0 0		
Hanmer, Capt. J. G. J., R.N.	0 10 0		
Hanson, Mrs.	0 10 6		
Harcourt, Adm. F. E. Vernon	1 1 0		
Hardie, Mrs. Peter, Bayswater (1874-80)		25 0 0	
Hardie, Thos. Kincaid, Esq., do. (1874-80)		35 0 0	
Hardwick, Mrs. F. W.	1 1 0		
Hardy, Mrs.	1 1 0		
Hardyman, Miss C. J.	1 1 0		
Hare, John, Esq., Stonehouse	1 1 0		
Harker & Co., Messrs. G.	1 1 0		
Harlow, Capt., Aberystwith (1879)		2 0 0	
Harper, E. N., Esq.	1 1 0		
Harris, J., Esq., Thames St.	0 10 0		
Harris, Miss, Clapton	1 1 0		
Harrison, C. A., Esq., Lincoln	2 2 0		
Hart, Henry, Esq., Rother-			
ham	0 10 0		
Hartley & Co., Messrs. James	2 2 0		
Hartley, F., Esq., Exeter	0 5 0		
Harton, Samuel, Esq.	1 1 0		
Harton, W. H., Esq., V.P.	2 2 0	15 10 0	
Harvey and Greenacre, Messrs. (1875-8)		15 0 0	
Ditto	5 0 0		
Harvey, Charles, Esq.	1 1 0		
Harvey, George, Esq., Fairfield (1868)		50 0 0	
Harvey, H. M., Esq., Hex-			
worthy (1866-79)		90 0 0	
Harvey, Miss B. A., Ickwell			
Bury	1 0 0		
Harvey, (the late Mrs. Alicia), Exors.			
of, Rev. G. M. Gorham and Rev. J.			
Holmes (1879)	20 0 0		
Harvie, Miss Hannah (1877)		50 0 0	
Harwood, Knight, and Allen,			
Messrs.	1 1 0		
Haslam, Appleton, and Co.,			
Messrs.	1 1 0		
Haslam, Henry, Esq., Croydon	1 1 0		
Hassell, Mrs., Cheltenham (1879)		5 0 0	
Hastings and St. Leonards			
Branch (1879)		50 0 0	
Haswell, Rear-Admiral W. H.	1 0 0		
Hatcher, D., Esq.	0 5 0		
Hatherton, Lord	1 1 0		
Hatton, Mrs., Leamington	0 10 0		
Haverfield, Rev. W. R., M.A.	0 10 0		
Haves and Hertz, Messrs.	0 10 0		
Hawker, Charles, Esq.	1 1 0		
Hawkins, Clement, J., Esq.	1 1 0		
Hawkins, Rev. Bradford D.,			
in memory of E. B. C.	0 10 6		
Hay, Adm. J. B. L.	2 2 0		
Hay, Adm. J. B. P.	1 0 0		
Hay, Mrs., Carshalton (1879-80)		1 0 6	
Haycock, Miss H., Clifton (1862-79)		16 0 0	
Hayes, Mrs. L., New Hampton	2 0 0		
Ditto (1877-80)		11 0 0	

	Ann. Subs.	Donations.	
	£. s. d.	£. s. d.	
Hayne, Chas. Scale, Esq.,			
Eaton Square	1 0 0		
Haynes, Edmund C., Esq.	1 1 0		
Hays, John W., Esq. (1859-69)		12 12 0	
Hay's Wharf, Proprietors of.	1 1 0		
Hayter and Hayter, Messrs.	1 1 0		
Hayward, J. Fred., Esq. (1873-9)		30 15 0	
Head and Co., Messrs. H.	2 2 0		
Headfort, The Marquis of	2 0 0		
Headly, J. Ind., Esq.	2 0 0		
Hearne, T. P., Esq. (1869)		10 10 0	
Heathcote, J., Sen., Esq.	1 1 0		
Heathcote, J. M., Esq.	1 1 0		
Heathorn, W., Esq., and Lady			
Prinn	2 2 0		
Heatley and Son, Messrs.	1 1 0		
Heinekey, Messrs. R. and Co.	1 1 0		
Helcke, C. Esq., Alderney (1879)		0 10 0	
Hemery, C., Esq.	0 10 6		
Hemmas, H. A., Esq. (1879)		1 0 0	
Henckell, Du Buisson, and Co.,			
Messrs.	2 2 0		
Henderson, Miss F., in memory of the			
late J. Henderson, Esq., R.N.	1 1 0		
Heneage, Major	5 5 0		
Henley-on-Thames Branch (1880)		9 17 8	
Hennell, Thomas, Esq.	0 10 0		
Henning, Mrs., Orsett Ter.	1 1 0		
Henry, Lieut.-Col.	1 1 0		
Hepburn, Mrs. Emily M.	1 1 0		
Herbert, Dennis, Esq.	1 1 0		
Hereford, Miss Lucy (1874-80)		28 0 0	
Herring, Messrs. G. & A., & Co.	1 1 0		
Herring, Miss J. E.	1 0 0		
Herschell, Mrs., Westbourne			
Terrace	1 1 0		
Hertford, The Marquis of (1879)		10 10 0	
Ditto	2 2 0		
Heseltine, Mrs. Ernest (1880)		1 0 0	
Hetherington, John M., Esq. (1871)		115 10 0	
Hewett & Co., Messrs. J. D.	2 2 0		
Hewetson, Thos. Esq.	1 1 0		
Ditto (1873-79)		5 5 0	
Hewitt, The Misses, Lytham (1873-7)		500 0 0	
Heywood, E. S., Esq.	2 2 0		
Hibbert, Miss, Ramsgate (1879)		1 0 0	
Hichens, A. K., Esq.	1 1 0		
Hickes, Miss F., Bath	1 0 0		
Hickes, Mrs. A. J., the late,			
per Miss Hickes, Bath (1875)		100 0 0	
Hickman, Mrs. (1869-79)		11 10 0	
Hickman, Miss (1869-79)		15 15 0	
Ditto	1 1 0		
Higham, W. S., Esq.	0 10 0		
Hilhouse, Messrs. R. and			
Sons	2 2 0		
Hilhouse, Miss	0 10 6		
Hilhouse, Miss Harriet	0 10 6		
Hill and Sons, Messrs. J.	1 1 0		
Hill, A., Esq., Bruce Grove (1868)		10 10 0	
Hill, F., Esq., Hampstead	1 0 0		
Hill, Jas. D., Esq.	3 3 0		
Hill, Lord Arthur William	5 5 0		
Hill, Major	1 1 0		
Hillier, Miss M. A.	1 0 0		
Hillier, W. G., Esq. (1868)		10 0 0	
Ditto	2 0 0		
Hillman, Mrs. Clark	1 0 0		
Hills and Underwood, Messrs.	1 0 0		
Hills, F. C., Esq., Deptford	1 1 0		
Hills, F. Ernest, Esq., Redleaf	1 1 0		
Hilton, Anderson, and Co.,			
Messrs.	0 10 6		
Hilton, Jas., Esq., Shawhall	1 1 0		
Hindley, W. H., Esq.	1 1 0		
Hinkley, John, Esq.	1 1 0		

	Ann. Subs.		Donations.			Ann. Subs.		Donations.			
	£.	s. d.	£.	s. d.		£.	s. d.	£.	s. d.		
Hirsch, J. F. Esq.	0	10	0	0	Hughes, Miss, East Bergholt	1	0	0			
Hoblyn, Jas., Esq. (1869-79)			9	9	0	Hughes, Mrs. Marsh (1875-9)			2	10	0
Hodd and Son, Messrs. R.	1	1	0		Hughes, W., Esq., Meole	1	1	0			
Hodgkinson, W. S., and Co., Messrs.	1	1	0		Hughes, Fred., Esq. Reigate (1879-80)	2	0	0			
Hodgson, E. D., Esq., Temple Street	1	1	0		Hull Branch (1830)			102	6	7	
Hodgson, F. C., Esq., Downing Street	1	10	0		Hunt, C. Brooke, Esq.	1	0	0			
Hodgson, F. W., Esq., Friday Street	1	1	0		Hunter, G., Esq.	1	1	0			
Hoggard, Mrs. (the late)	1	0	0		Hunter, John & Co., Messrs.	2	0	0			
Holden, E. T., Esq.	1	1	0		Hunter, Mark William, Esq. (1872-7)	29	8	0			
Holder, Chas. V., Esq., Maida Vale	5	0	0		Hurst, T. G., Esq.	0	10	6			
Holdich, Capt. J. P., barque <i>Overdale</i> (1879)			2	0	0	Husey and Son, Messrs. R. A.	1	1	0		
Holland, Commander S. C., R.N.	1	1	0		Hussey, R. H., Esq. (1859-69)			20	0	0	
Holland, Edmund, Esq., Hyde Park Square (1872-80)			26	0	0	Hutchins, Mrs., Portland Place	1	0	0		
Holland, The Hon. Mrs. F.	1	1	0		Hutchinson, A., Esq. (1860-79)			190	0	0	
Holliday, Miss A. S., (1878-80)			6	0	0	Hutchinson, Miss C. (1863-79)			27	0	0
Holmes, Sancroft, Esq.			1	0	0	Hutchinson, Miss Fanny (1871-9)			18	0	0
Holt, W. J., Esq., Bangor (1872-4)			30	0	0	Hutchinson, Miss, Great Malvern (1877-80)			16	1	0
Ditto	10	0	0		Hutchinson, Rev. J. R., B.D.	1	0	0			
Home, Mrs. (1876-9)			2	0	0	Huth and Co., Messrs. F. (1864-73)			21	0	0
Home, The Rt. Hon. Earl of	5	0	0								
Homer, C. G., Esq.	1	1	0		I. W. (1877)			10	0	0	
Homer, Rev. H. (1875-80)			8	8	0	I'Anson, Charles, Esq.	1	1	0		
Honychurch, Mrs.	0	10	6		Image, Mrs., Mildenhall (1879)			5	5	0	
Honychurch, T., Esq., Executors of (1879)			4	13	4	Image, W. E., Esq., Mildenhall			1	1	0
Hood, Admiral, C.B.	2	0	0		Ditto (1877-9)			3	3	0	
Hood, Miss Jacomb (1864-71)			91	0	0	Imlock, R. W., Esq., Demerara	1	1	0		
Hooper, A., Esq., Royal Institution (1863-73)			25	0	0	Ingilby, William, Esq.	1	1	0		
Ditto	1	1	0		Inglis, J., Esq., Colchester	1	1	0			
Hooper, A. D., Esq., Lloyd's	0	10	0		Inglis, Mrs., Southend	1	0	0			
Hooper, Miss E., Gloucester	0	10	0		Ingram, Mrs. Herbert	5	5	0			
Hooper, Mrs. H., Blackheath	1	1	0		Ingram, Rev. H. M.	1	0	0			
Hooper, T. W., Esq., Southsea	1	1	0		"In Memoriam" (1875-6)			150	0	0	
Hope, Charles, Esq.	1	1	0		"In Memoriam"	25	0	0			
Hope, Mrs. W. C., Bath (1873-9)			25	0	0	"In Memoriam"	1	1	0		
Hopkins, Mrs., Northleigh	1	1	0		"In Memory of a Sister who was an Annual Subscriber to the Life-boat Institution" (1877)			59	0	0	
Hopkins, Miss R. (1873)			10	0	0	Ipswich Branch (1830)			39	6	3
Hopkins, Rev. Canon	1	1	0		Irby, Rev. The Hon. L. C. R.	1	1	0			
Hopkins, Rev. F.	2	2	0		Iredell, Chas., Esq.	1	1	0			
Hopkins, The Misses, Nottingham	5	0	0		Iredell, Major J. S.	1	0	0			
Hopkins, Joshua Scales, Esq. (1874)			50	0	0	Ironmongers, Worshipful Company of (1863-73)			21	0	0
Hopkinson, Mrs., Ilchester	2	2	0		Irving, Mrs. Colonel (1860-80)			21	9	0	
Hopton Chapel Sick and Funeral Society	3	3	0		Iver, Capt.	1	1	0			
Horn, Mr. J. E.	1	1	0								
Horniman, John, Esq.	1	1	0		J. A. (1869)			50	0	0	
Horrockses, Miller, and Co.	2	2	0		J. B. S.	5	0	0			
Horschitz and Co., Messrs.	1	1	0		J. B. W. (1879)			50	0	0	
Horsea Branch (1879-80)			134	3	6	J. C. (Birmingham) (1870)			20	0	0
Horton, Rear-Admiral W.	1	0	0		Ditto	2	2	0			
Horton, T. E., Esq.	3	3	0		J. C. and J. S. C. (1869-78)			15	0	0	
Hotchkiss, Mrs.	1	0	0		J. C., per Mrs. Dalton (1880)			1	1	0	
Hotham, Beaumont, Esq.	1	0	0		J. E. D.	1	1	0			
Hotham, The Hon. Lady	2	2	0		J. D. (1870-9)			14	10	0	
Hovell, J. R., Esq. (1872-80)			7	6	0	J. G. (1877)			100	0	0
Hovenden, F. P., Esq. (1872-83)			80	0	0	J. S.	10	0	0		
Howard, Dr.	1	1	0		J. S. (1878)			10	0	0	
Howard and Escombe, Messrs. (1879)	10	10	0		J. S. A. (1872-9)			13	7	0	
Howell, Mrs. Bennett, Withington (1879)			0	10	0	J. T. C. (1862-75)			73	10	0
Howson, F. J., Esq.	1	1	0		J. W. (1878)			20	0	0	
Hoyland, J., Esq., Brierley	1	1	0		Jackson and Till, Messrs.	1	1	0			
Hubbard, Colonel C. J.	1	0	0		Jackson, Miss H. A., Glo'ster	1	1	0			
Huddersfield Branch (1879-80)			107	2	0	Jackson, Rev. J.	0	5	0		
Hudson, Mrs. W.	1	1	0		Jackson, W., Esq., Tower St.	1	1	0			
Hudson, Thos., Esq.	1	1	0		Jacomb, Charles, Esq. (1868-72)			21	0	0	
Hudson, C. E., Esq., Southport (1830)	1	0	0		Jaffray and Co., Messrs.	5	0	0			
					James, F., Esq., Kensington (1877)			50	0	0	

LIST OF DONATIONS AND ANNUAL SUBSCRIPTIONS.

	Ann. Subs.		Donations.	
	£.	s. d.	£.	s. d.
James, Mrs., in memoriam				
Major C. D. James, H.M.				
36th Regt.	5	0 0		
James, Robert, Esq., Store				
Street	1	1 0		
Janson, R., Esq.	1	1 0		
Jarrett, Chas., Esq., Croydon (1876-9)	2	15 6		
Jeffery, Miss S.	1	0 0		
Jeffrey, Alex., Esq.	0	5 0		
Jenkin and Phillips, Messrs. .	1	1 0		
Jenkins, A. H., Esq. (1877)			50	0 0
Jenner and Sons, R. and H. .	5	5 0		
Jenson, John, Esq.	1	1 0		
"Jehoiada Walters" (1869).			10	0 0
Jersey Swimming Club	1	0 0		
Jessop, Mrs., Henley	1	1 0		
Jewish Scholars' Life-boat Fund, <i>vide</i> p. 95.				
Jobson, W. W., Esq.	1	1 0		
Johnson, Admiral.	1	0 0		
Johnson, F., Esq.	0	5 0		
Johnson, David, Esq., Wrex-				
ham	1	1 0		
Johnston, T., Esq.	2	2 0		
Johnston and Son, Messrs.,				
Botolph Lane	1	1 0		
Johnston & Sons, Messrs. N.,				
Seething Lane	1	1 0		
Johnston, Sons, & Co., Messrs.				
E., Great St. Helen's	1	1 0		
Jones, C.W., Esq., Cheltenham	1	1 0		
Jones, H. Cadman, Esq.	1	1 0		
Jones, James, Esq., Ramsey. .	1	1 0		
Jones, Miss S., Cheltenham .	1	1 0		
Jones, Mrs., Faversham (1878)	25	0 0		
Jones, Winslow, Esq., Exeter	1	1 0		
Joy, Mr. W. J.	0	10 6		
Jubb, John, Esq., J.P. (1879)	10	0 0		
Jubb, Samuel, Esq., Batley (1875)	10	0 0		
K. and E. C. (1873-6)	30	0 0		
K. W. (1878)	20	0 0		
"Kattey," per Mrs. Dalton (1830)	1	1 0		
Kaye, C., Esq., Northwich . . .	1	1 0		
Kaye, Miss E. F.	2	2 0		
Keal, Miss, Hereford	1	1 0		
Keeling, Rev. Wm., B.D.	1	1 0		
Keighley Branch (1880)	31	6 9		
Keiller, William, Esq.	2	0 0		
Kellock, Messrs. C.W., & Co. .	1	1 0		
Kelly, Mrs., Ealing	1	1 0		
Kelso Branch (1879-80)	17	13 0		
Kemble, Mrs. Henry	10	10 0		
Kemmas, H. A., Esq. (1879) . . .	1	0 0		
Kemble, William, Esq.	5	0 0		
Kempster, John, Esq., and Mrs. .	1	1 0		
Kennard and Co., Messrs. S. . .	2	2 0		
Kennedy, Rear-Adm., C.B. . . .	2	0 0		
Kent and Co., Messrs. G. B. . . .	0	10 6		
Kent, Henry, Esq., Shepherd's				
Bush	1	1 0		
Kent, Mrs. Henry, Shepherd's				
Bush	1	1 0		
Kent, T. J., Esq. (1871)	10	10 0		
Keppel, Admiral the Hon. Sir				
Henry, K.C.B.	1	1 0		
Kidd, Miss Pringle (1877-9) . . .	25	0 0		
Kidd, Mrs., Skipton	1	1 0		
Kilvert, N., Esq., Manchester	1	1 0		
Kinahan and Co., Messrs.	5	5 0		
King, G., Esq., Algiers	2	2 0		
King, Mrs., Algiers	2	2 0		
King, Miss Louisa A.	1	0 0		
King, Miss Sarah, Skipton . . .	1	0 0		

	Ann. Subs.		Donations.	
	£.	s. d.	£.	s. d.
King, Messrs. H. S., & Co.	2	2 0		
Kinglake, Rev. F. C.	1	1 0		
King's Lynn Branch (1880)			32	13 5
Kinloch, Miss, Gilmerton	1	0 0		
Kirk, Miss, Guildford	0	10 0		
Kirkliston Branch (1879)			5	8 6
Knight, Fred., Esq.	0	10 0		
Knight, Rev. H. C.	1	1 0		
Knill and Co., Messrs. J.	2	2 0		
Knowles and Foster, Messrs. (1851-70)			102	10 0
Knowles, the late Miss M.	5	0 0		
Knox, B. D., Esq., Ardmillan	2	0 0		
Ditto (1872)			10	0 0
Kopke, H., Esq.	1	1 0		
"L." (1875)			10	5 0
L. A. R. (1873)			50	0 0
L. E. W., Croydon	0	10 0		
Labordette de, Dr., Nice	1	1 0		
Laddie, Mr., per Mrs. Dalton	18	18 0		
Ladds, Capt. Wm.	0	10 6		
Lambert Bros., Messrs.	2	2 0		
Lambert, F. D., Esq.	5	0 0		
Lambert, T., Esq.	2	2 0		
Lampard & Foster, Messrs. . . .	1	1 0		
Lampson, George C., Esq.	2	2 0		
Lancaster Branch (1880)			133	13 5
Lancaster, Mrs. Mary	1	1 0		
Lance, Mrs., Redhill	1	0 0		
Land, Philemon, Esq. (1874-7) . . .			200	0 0
Landon, Mrs., Putney	2	2 0		
Landseer, Miss (1874)			105	0 0
Lane, Rev. T. L.	1	0 0		
Lanerton, Admiral, the Lord	5	0 0		
Langley, Charles, Esq.	1	1 0		
Langley, Miss	1	1 0		
Langton, Miss Maria	1	1 0		
Langton, Rev. Charles	5	0 0		
Langton, W. Gore, Esq. (1865-72)			250	0 0
Langton and Bicknell, Messrs. . . .	2	2 0		
Lansdell, Mr. G.	1	1 0		
Lanyon, J. C., Esq.	1	1 0		
Larcom, Mrs. Capt.	1	0 0		
Larden, Rev. G. F., D.C.L.	1	10 0		
Larking, Alfred J., Esq.	2	2 0		
Larwill, Miss F. R.	1	1 0		
Laurie, Mrs., St. George's				
Place, per Rev. Sir Emilius				
Bayley, Bart., B.D. (1876)			500	0 0
Law, The Hon. H. S.	1	1 0		
Law, Markham, Esq.	1	0 0		
Lawrence, G. H., Esq. (1870-8) . . .			34	0 0
Ditto	3	0 0		
Lawrence, Gen. H.	1	1 0		
Lawrence, Mrs.	1	1 0		
Lawrence, Miss J., Wimbeldon	0	10 0		
Lawrence, Rev. H., Gerald-				
ton, Western Australia	0	10 0		
Lawson, Miss Elizabeth	10	0 0		
Laye, Mrs., Southsea	1	0 0		
Le Bailly, H. J., Esq., Jersey	2	0 0		
Ditto (1880)			3	0 0
Le Cocq, Lieut. W. G., R.N.	5	0 0		
Le Lacheur, John A., Esq.	2	2 0		
Ditto (1866-9)			40	0 0
Le Marchant, Lady	1	1 0		
Lea, M., Esq. (1865-80)			16	16 0
Leathersellers, Worshipful Com-				
pany of (1874)			10	10 0
Leckie, Messrs. J. B., & Co.	1	1 0		
Ledger, J. W., Esq.	1	1 0		
Ledoux, M. Henri, Demerara	1	1 0		
Ledward, C. O., Esq.	2	2 0		

	Ann. Subs.		Donations.			Ann. Subs.		Donations.	
	£.	s. d.	£.	s. d.		£.	s. d.	£.	s. d.
Lee, James, Esq., New Cross Road (1876-9)			2	0 0	Loveday, J. T., Esq., Norwood	1	1 0		
Lee, Miss, Kinfare	2	2 0			Lovegrove and Co., Messrs.	1	1 0		
Lee, Mrs., Towcester (1876-80)			7	0 0	Low, Alex. F., Esq.		2 2 0		
Lee, Son, and Co., Messrs. Wm. (1873)	21	0 0			Lowdell, Miss, Baldwyns (1871)			10	10 0
Leeds Branch (1880)			82	15 3	Lowdell, Mrs., Bedales (1873)			50	0 0
Leek Branch (1879)			24	13 6	Lowndes, Rev. E. S.	1	1 0		
Legge, Gen. the Hon. A. C.	2	0 0			Lowndes, W. D., Esq.	0	5 0		
Legge, Lieut.-Col. the Hon. E. H.	1	1 0			Loyd, Mrs. Lewis (1859-80)			40	5 0
Leicester Branch (1879)			60	0 0	Luad, Mrs., Hampstead	3	3 0		
Leigh, Mrs. D. H.	1	1 0			Luca, Mrs. C. H.	1	1 0		
Leiningen, Capt. H. S. H. the Prince, R.N., G.C.B.	1	1 0			Luscombe, Mrs.	2	0 0		
Leishman, Inglis, & Co.	1	1 0			Lushington, Mrs. J. D.	2	0 0		
Leman, Henry, Esq. (1876-80)			13	10 0	Luttrell, Miss, St. Katherine's (1861-70)			36	10 0
Lethbridge, Mrs. A. G.	3	3 0			Lutwidge, C. R. Fletcher, Esq.	1	1 0		
Lethbridge, Rev. J. K., M.A.	0	10 0			Lyall, George, Esq., Deputy-Chairman	2	2 0	31	10 0
Ditto, and Friends (1879-80)			1	0 0	"Lydia," Southampton (1874-9)			3	1 0
Levesley, B. Esq.		0 10 0			Lyell, Miss C., Shielhill (1877-8)			20	0 0
Levi, Miss C.		0 10 0			Ditto	1	0 0		
Lewis, Professor Hayter (1872)			10	10 0	Lyell, The Misses (1871)			10	0 0
Lewis, R., Esq., Inner Temple	1	1 0			Lytham Branch (1879)			20	0 0
Lewis, Mrs. Richard, Glo'ster Place	1	1 0							
Lewis, Richd., Esq., Colwell	0	10 6			M. (1863-80)			17	17 0
Lewis, Miss, Folkstone (1880)			0	10 0	M. (1873-4)			150	0 0
Liddell, H. T., Esq. Colwall (1860-79)	108	0 7			M., per Messrs. Couatts & Co. (1867-79)			37	0 0
Liddon, E., Esq.	1	1 0			M. A. F.	1	1 0		
Liddon, J., Esq., Wimbledon	1	1 0			M. A. S. (1879)			2	0 0
Liddon, W., Esq.		0 10 0			M. B. T. W. (1869-75)			150	0 0
Liebenrood, Capt. J., R.N. (1866-80)	44	10 0			Ditto (1877)			50	0 0
Lightfoot, Mrs. General		1 10 0			M. C. M. (1869-73)			10	0 0
Lightfoot, Miss		1 10 0			M. E. C.	2	2 0		
Lightfoot, J. E., Esq., Ac-crington	1	1 0			M. E. I.	1	1 0		
Lighton, Sir C. R., Bart.	1	1 0			M. E. W. E. C. (1877-9)			3	0 0
Lighton, Lady (1879)		0 10 6			M. M. M., In Memory of	10	0 0		
Lighton, A. H. Digby, Esq. (1878-9)	1	10 6			M. N.	1	10 0		
Lincolnshire Coast Shipwreck Association Branch (1880)			50	0 0	M. R.	5	0 0		
Linford, Mrs. W. T.	1	1 0			M. R., "A Thank-offering" (1872)			20	0 0
Lingen, Sir R. Ralph W., K.C.B.	2	2 0			M. S. S.	0	10 6		
Lingham, Mrs.	1	1 0			M. T. (1865-75)			25	0 0
Linney, Albert, Esq.	0	10 0			M. W. (1880)	1	0 0		
Lintott, W., Esq., Horsham	1	1 0			Macan, Lieut.-Gen. H., C.B.	2	0 0		
Lister, Beck, and Co., Messrs.	1	1 0			Mac Andrew & Co., Messrs. R.	2	2 0		
Little, Ernest M., Esq.	1	1 0			Macdonald, D., Esq., Larne (1875-9)			25	0 0
Littleboro' Co-operative Soc.	2	2 0			MacDonald, The Misses	1	0 0		
Littledale, C. R., Esq. (1876-89)			12	6 0	Mackenzie, Colonel	2	2 0		
Littledale, Major (1861-9)			250	0 0	Mackenzie, Mrs. E.	2	2 0	21	0 0
Ditto		10 10 0			Mackeson, H. B., Esq.	1	1 0		
Littlehales, Capt. E., R.N.	1	0 0			Mackinlay, Mrs., Regents Park	1	1 0		
Liveing, Miss C.	0	5 0			Mackreth and Fosters, Messrs.	1	1 0		
Liverpool and New Brighton Branch (1880)			500	0 0	Maclean, Maris & Co., Messrs.	1	1 0		
Lloyd, Matheson, & Co., Messrs.	1	0 0			Macleod, Capt. R. B. E., R.N.	2	2 0		
Lloyd, Mrs. G. J. M.	1	1 0			Macmillan and Sons, Messrs.	1	1 0		
Lloyd, Miss, Twickenham	0	10 0			MacWhirter, John, Esq., and Miss MacWhirter (1871-9)			34	17 0
Lloyd's, The Committee of	10	10 0			Magrath, Rev. J. R.	0	10 0		
Lockhart, Miss Macdonald (1868)	20	0 0			Mahon, R. H. D. Esq.	2	0 0		
Lockitt, Miss, Macclesfield (1871-80)	2	0 0			Mahon, Mrs.	2	0 0		
Lockwood, Miss	1	1 0			Maingay, Mrs.	2	0 0		
London Assurance Corporation (1870)	31	10 0			Maitland, Capt. H. I., R.N.	1	1 0		
Londonderry and Greencastle Branch (1880)			10	0 0	Major and Field, Messrs.	1	1 0		
Long, Captain S., R.N.	5	0 0			Major, C. M., Esq.	1	1 0		
Long, Miss D. T., Arundel (1867-8)	21	0 0			Malcolm, W. E., Esq.	1	0 0		
Longland, John, Esq.	1	1 0			Mallam, Richard, Esq.	1	0 0		
Longridge, the Misses	1	1 0			Mallett, Thos. H., Esq. (1879)			2	2 0
Longstaff, Messrs. F. & Sons, Limehouse	1	1 0			Manchester Branch (1880)			318	9 4
Longton Branch (1879)			29	8 0	Manley, A. E., Esq.	2	0 0		
Lonsdale, W., Esq. (1872)			20	0 0	Mann, Mrs. Dixon	1	1 0		
Looe Branch (1880)			10	0 0	Mannock, W. M. S. P., Esq.	1	1 0		
Love, Mr. William, Paisley (1860-79)	20	0 0			Mansel, J. C., Esq.	1	1 0		
					Marcet, W., Esq., M.D., Cannes (1869-79)	13	13 0		
					March, Lieut., Santander	0	10 0		
					Margate Branch (1879)			25	0 0

	Ann. Subs.		Donations.			Ann. Subs.		Donations.	
	£.	s. d.	£.	s. d.		£.	s. d.	£.	s. d.
Margetts, Charles, Esq.	1	1	0		Mellish, Mrs. Leigh	1	1	0	
Margetts, Mrs. H.	1	1	0		Mellor, the Hon. Justice (1878)	50	0	0	
Marine and General Mutual Life Assurance Society	10	0	0		Melrose Branch (1880)	14	16	6	
Mark Lane Life-boat Fund, vide p. 95.					Melville, Lady F.	3	3	0	
Markby, Alfred, Esq. (1878)			10	0	0	Menars, Major H. (1863-69).	22	15	6
Marks, J. C., Esq., Swansea (1880)			2	10	0	Mercers, Worshipful Co. of (1868)	52	10	0
Marples, R. M., Esq., Worship Street (1879)			1	1	0	Merchant Taylors, Worshipful Com- pany of (1857-76)	147	0	0
Marriott, Capt. Edwd.	1	1	0		Meredith, Miss Emma (1870-9)	20	3	0	
Marryat and Sons, Messrs. J.	2	2	0		Merrick, Colonel (1880)		1	0	0
Marryat, Charles, Esq.	1	1	0		Metcalf, E. C., Esq.	0	10	6	
Marsh, Miss, Gloucester	1	0	0		Methuen, Rev. H. H.	0	10	0	
Marshall, A., Esq., Huntingdon	1	0			Meux, Sir Henry, & Co.	5	5	0	
Marshall, C., Esq., Huntingdon	1	1	0		Michell, Rev. T. H.	1	1	0	
Marshall, Rev. E. (1854-77).			33	14	6	Michie, A. S., Esq.	1	0	0
Ditto	1	0	0		Michie, Mrs. A. S.	1	0	0	
Marshall, J. M., Esq., Wal- lingford	1	1	0		Middleton, The Misses (1860-76, in addition to 30l. 5s. collected)	42	12	6	
Marter, Miss Mary B.	1	1	0		Miland, Mrs., Wimbledon	2	0	0	
Marter, Wm. Ingram, Esq.	1	1	0		Milburn, Messrs. William, & Co.	5	5	0	
Martin, Capt. W. L., R.N.	1	0	0		Miles, William, Esq.	1	1	0	
Martin, Dowager Lady (1880)			10	0	0	Miller, R. M., Esq.	1	1	0
Martin, E. M., Esq.	5	5	0		Miller, Mrs., Roehampton (1880)	2	2	0	
Martin, Rev. G. (1875-8)			5	3	0	Millington & Co., Messrs. W.	1	1	0
Martin, J. Stapleton, Esq.	0	10	6		Millington, C., Esq.		1	1	0
Martin, J. B., Esq., Lombard St. (1873)	10	10	0		Mills, H. J., Esq.	0	5	0	
Martin, James, Esq., Salisbury	1	1	0		Mills, J., Esq., Yateley	1	1	0	
Martin, Lieut. Leslie, 12th Lancers (1873)	25	0	0		Mills, Mark, Esq. (1864-80)	85	5	0	
Martin, Mrs., West Buckland	2	2	0		Mills, Wm., Esq., Clapham	1	1	0	
Martin, The Misses, Bloomsbury (1869-75)	18	12	6		Millward, Wm., Esq.	1	1	0	
Martin, T., Esq., St. Austell	1	1	0		Milne, J. D., Esq., Aberdeen (1877-9)	3	0	0	
Martin, Rev. Glanville	1	1	0		Milne, Mrs. J. D., Aberdeen (1864-75)	12	0	0	
Martineau, Miss F., Clapham	2	2	0		Mitcalfe, W. B., Esq.	1	1	0	
Martyn, Miss Jane A., Carthew	5	0	0		Mitchell, A. C., Esq.	1	1	0	
Ditto (1879)			1	0	0	Mitchell, F. H., Esq. (1876)	21	0	0
"Mary" (1880)			1	0	0	Mitchell, F. J., Esq., Newport	1	1	0
Mason, Miss, Audenshaw Hall	0	10	6		Mitchell, G. W., Esq.	0	10	6	
Massey, Richard, Esq., Hand- forth	2	0	0		Mitchell, J. H., Esq.	2	2	0	
Massy-Beresford, Very Rev. John M.	1	0	0		Mitchell, W. R., Esq., Wim- pole Street	1	1	0	
Masterman, N., Esq.	5	0	0		Mitchell, Yeames, and Co., Messrs.	5	0	0	
Mathews, G. H., Esq.	2	2	0		Moir, Mrs. M. T.	1	1	0	
Mathews and Luff, Messrs.	1	1	0		Moline and Co., Messrs. (1865-73)	41	10	0	
Matveieff and Co., Messrs.	1	0	0		Molyneux, Lady Georgina (1874-7)	13	0	0	
Maude, Capt. Hon. F., R.N.	1	1	0		Molyneux, Miss	0	10	0	
Maudslay, Chas., Esq.	1	0	0		Moncrieff, Colonel.	1	0	0	
Maudslay, Son, and Field	2	2	0		Monk, Commander J., R.N. (1868-75)	47	7	6	
Mawe, F. E., Esq.	1	1	0		Montague, A., Esq., Penton	1	1	0	
Maxwell, Rev. E.	2	0	0		Montague, James, Esq. (1859-67).	20	0	0	
Maxwell, Col. G. Shirley	1	0	0		Montgomerie & Workman, Messrs.	1	1	0	
Maxwell, Lieut.-Gen. H. H., R.A.	10	0	0		Montgomerie, F. B., Esq.	2	2	0	
May, George, Bracondale (1878)			2	0	0	Montgomery, John, Esq.	5	0	0
Mayne, Capt. R. C., R.N., C.B.	1	1	0		Montgomery, Sir G., Bt.	2	0	0	
McArthur, Messrs. W. & A.	2	2	0		Montrose Branch (1879)		15	0	0
McBayne, Miss Frances (1875-80)			12	0	0	Moody, Miss, Derby	0	5	0
McDonogh, Mrs., Molesey	2	2	0		Moon, R., Esq., Stanmore	2	2	0	
McDougall Bros., Messrs.	1	1	0		Moore, Rev. G. B., Tunstall (1857-80)	42	0	0	
McEwan and Co., Messrs. J.	1	1	0		Moore, Capt. Richmond, R.N.	1	1	0	
McHardy, Admiral	1	1	0		Moore, The late Lieut.-Gen. R. C., C.B.	2	0	0	
McKerrell, Wm., Esq. (1863-72)			80	0	0	Ditto, and Mrs. Moore (1871-6)	12	0	0
McNeill, Sir J., G.C.B.	1	0	0		Moore, W., Esq., Bury St.	0	10	6	
Mead, Joseph B., Esq.	1	1	0		Moore, W., Esq., Wierton	1	1	0	
Meadows, T., and Co., Messrs.	1	1	0		Moore, W. E., Esq. Royal Exchange (1876)	100	0	0	
Meares, Thos., Esq.	1	1	0		Moorsom, Rev. J. R.	1	1	0	
Medlycott, Capt. M. B., R.N.	1	1	0		Morehead, Dr. C.	1	1	0	
Medwin, Dr. A. G.	1	1	0		Moreland Brothers, Messrs.	5	0	0	
Mee, Mrs. J. H.	1	1	0		Morgan & Co., Messrs. J. S.	1	1	0	
Meggeson and Co., Messrs.	1	1	0		Morgan & Medhurst, Messrs.	1	1	0	
Melhuish, Sons, & Co., Messrs.	1	1	0		Morice, John C., Esq.	1	1	0	
Meller, Capt. A., Ipswich (1874-9)			30	0	0	Morland and Sons, Messrs. J.	1	1	0
Mellish, Henry, Esq.	1	1	0						

	Ann. Subs.			Donations.				Ann. Subs.			Donations.		
	£.	s.	d.	£.	s.	d.		£.	s.	d.	£.	s.	d.
Morley, Francis, Esq., Breadsall Priory	2	2	0				Nixon, C. J., Esq., Bourne- mouth	1	1	0			
Morley, Mrs., Derby	1	1	0				Noble, John, Esq. Park Place	2	0	0	20	0	0
Morphew, J., Esq., Jermyn Street	1	1	0				Noble, R. H., Esq., Caver- sham Hill	3	0	0			
Morrice, R. E., Esq., Eltham (1872-6)				10	10	0	Noel, Eugene F., Esq.				10	10	0
Morrison, Col. Robert	2	2	0				Nolloth, Dr. E., R.N.	1	0	0			
Morris, Prevost, & Co., Messrs. (1864-73)	15	10	0				Norfolk Branch (1880)				120	17	9
Morris, Mrs., Lee (1879)				0	10	0	Norsworthy, G., Esq.	1	1	0			
Morton, Mrs. (1864-79)				31	10	0	Norsworthy, H., Esq. (1866-77)				100	0	0
Morton, Rose, & Co., Messrs.	1	1	0				Northampton Branch (1880)				25	5	6
Mosenthal, Sons, and Co., Messrs. J.	1	1	0				Northampton, the Marquis of	5	0	0			
Moser and Sons, Messrs. (1878)				10	0	0	Northey, E. K., Esq., Epsom (1878)				10	0	0
Moss and Co., Messrs. C.	2	2	0				Northumberland, Duke of	2	0	0			
Moss, Mrs. G. W.	2	2	0				Nottingham Branch (1880)				54	2	6
Moules, G., Esq., Lombard St. (1865-72)	21	0	0				Nottingham, Mrs., in memory of her late uncle, A. Worthing- ton, Esq., Whitchurch (1874)				250	0	0
Moysey, Rev. F. L.	1	1	0				Nunn, H. W., Esq. (1868)				10	10	0
Muff, F. B., Esq., Ilkley	0	10	0				Nuthall, Major-Gen. Thos. J.	1	1	0			
Mullens, J. A. Esq., Lom- bard Street (1880)				31	10	0	Nutter, James, Esq.				0	10	6
Mullens, Mrs. A. (1880)				1	10	0							
Müller, C. J., Esq.	1	1	0				Oakes, Arthur, Esq.	1	1	0			
Mundy, Thos., Esq., the late (1877)				50	0	0	Oakes, Mrs. (1871-9)				7	7	0
Munnings, Mrs. A. A.	2	0	0				Oakley, Christopher, Esq.	1	1	0			
Munnis, Colonel E. C. (1874-9)				6	5	0	Odd Fellows, Independent Order of (M.U.), <i>vide</i> p. 95.						
Munnis, Mr., Wrexham	1	1	0				O'Donovan, The	1	1	0			
Mure, Mrs. Geo. Herringwell (1873)	10	0	0				Offley, Forrester, and Co., Messrs.				2	2	0
Murphy, I. J., Esq., Lisburn	1	0	0				Oliver, George, Esq.	1	1	0			
Murphy, J. J., Esq., ditto	1	0	0				Oliver Goldsmith Life-boat Fund, <i>vide</i> p. 95.						
Muspratt, Henry, Esq., "A Thank- offering for mercies bestowed on him- self and family" (1875)	10	0	0				O'Neil, The Viscount	5	0	0			
Musselburgh Branch (1880)	15	15	0				O'Neil, The Viscountess	5	0	0			
Mytton, Miss, Welshpool	2	2	0				Oram, Jas., Esq. (1863-80)				85	0	0
							Ord, W. G. H., Esq.	1	1	0			
N., per Messrs. Morris, Pre- vost, and Co.	5	0	0				Orde, Miss A. M. F. (1865-77)				30	0	0
N. B. A. (1875)				30	0	0	Ditto	1	1	0			
N. F. H.	1	1	0				Ormerod, G. W., Esq., Brookbank (1875)	15	15	0			
N. L., Dublin (1861-79)	80	0	0				Ormston, R., Esq. (1861-70)				42	0	0
Napier, Rev. J. W.	1	1	0				Osborn, Mrs. C., Down End	1	1	0			
Nash, C., Esq., Kensington (1878-80)	2	0	6				Osborne, Martin, Esq.	1	1	0			
Nash, F., Esq., Ludlow	1	1	0				Osborne, Rev. Philip				2	10	0
Naylor, Benzoin, & Co., Messrs. 5	5	5	0				Ostell, Mrs.	1	1	0			
Naylor, Joseph Ulysses, Esq.	1	1	0				Otter, Mrs. H. C., Oban	1	1	0			
Neale, Miss C., Brighton	0	10	6				Otway, Rear-Adml. R. J.	5	0	0			
Neilson & Sons, Messrs. Claud 2	2	2	0				Outram, Sir Francis, Bart.	5	0	0			
Nelson, Dale, & Co., Messrs.	1	1	0				Outram, the Dowager Lady	2	0	0			
"Nemo"	5	0	0				Ouvry, F., Esq., Queen Anne St. 2	2	2	0			
Nesbitt, Messrs. A. & W.	1	1	0				Overstone, The Rt. Hon. the Lord (1878)				50	0	0
Nesbitt, Miss Downing (1877-8)	10	0	0				Ovey, The Misses (1865-72)				90	0	0
Neve, Mrs. R.	0	5	0				Owen and Graham, Messrs. (1866-77)	56	5	0			
Newark Branch (1880)	30	10	9										
Newbon, Robt. Alger, Esq.	1	1	0				P. P. (1879)				10	0	0
Newcastle Trinity Board	10	10	0				Pacific Steam Navigation Co.	5	5	0			
Newcastle, Tynemouth and Cullercoats Branch (1879-80)	205	0	0				Padbury, Mr. James, Bishop's Waltham (1880)				0	10	0
Newman, Mrs., Sen.	0	10	0				Paine, J., Esq., Springfield	2	2	0			
Newquay (Cardiganshire) Branch (1880)	5	0	0				Paine, Wm. Esq., St. Neot's.	1	1	0			
New River Company	1	1	0				Painter, T., Esq., Wrexham	1	0	0			
Newson, Thomas, Esq.	1	1	0				Palmer, Colonel G.	1	1	0			
Newton, F. W., Esq.	1	0	0				Palmer, George, Esq.	1	1	0			
Newton, Lieut. W. H., R.A. (1873-5)	20	0	0				Palmer, Miss, Manton (1860-80)				20	10	0
Ditto	5	0	0				Palmer, Richard, Esq. (1870-4)				35	0	0
Newton, Miss	2	3	0				Pantin, Messrs. W. & C.	1	1	0			
Nicholl, Henry F., Esq., Henley	5	5	0				Parbury, Mrs.	1	1	0			
Nicholson, G.P., Esq., Wath (1869-80)	25	4	0				Parker, F., Esq. (1877)				10	0	0
Nicholson, W. L., Esq., Blackheath	1	1	0				Parker, Miss (1875)				10	0	0
Nicolson, Admiral Sir F. W., Bart., C.B.	1	0	0				Parker, Miss, St. Clear's (1862-71)	20	0	0			

LIST OF DONATIONS AND ANNUAL SUBSCRIPTIONS.

	Ann. Subs.		Donations.	
	£.	s. d.	£.	s. d.
Parker, Rev. Wm. (1858-77)			41	0 0
Parker, Mrs. and Friends, Fifehead	1	0 0		
Parkin, Miss, Leconfield	1	1 0		
Parkin, Miss M. J., ditto	1	1 0		
Ditto (1879)			5	5 0
Parkin, W., Esq., Blaithwaite	1	1 0		
Parnell, John, Esq., J.P., Waltham Abbey	1	0 0		
Parnell, Louis, Esq.	2	0 0		
Parnell, Mrs. Gervas, Fetcham	1	1 0		
Partington, E., Esq.	1	1 0		
Partridge, C., Esq., exors. of	2	0 0		
Pasley, Adm. Sir T. S., Bart., K.C.B.	1	0 0		
Paterson, Laing, & Bruce, Messrs.	1	1 0		
Paul, H. T., Esq.	2	2 0		
Paulet, Lady Henry (1862-72)			32	0 0
Paulin, G., Esq., Lloyd's	1	1 0		
Pawle, J. D., Esq.	1	1 0		
Pawle, Frederick O., Esq., Bainfield (1868-9)			15	5 0
Payne, Miss H., Glenfield	1	0 0		
Payne, W. H., Esq., Bolton	0	10 6		
Peach, The Misses, Langley Hall, further in aid of <i>Memorial</i> Lite-boat (1877)			50	0 0
Peacock and Buchan, Messrs. (1862-8)			18	13 0
Ditto	2	2 0		
Peacock Bros., Messrs., Sunder- land: 1 <i>l.</i> each, annually, for the s.s. <i>Ash</i> , s.s. <i>Larch</i> , and brig <i>Emma</i>	3	3 0		
Peacock, Thos. B. Esq., Finsbury (1877)	10	10 0		
Peale, W., Esq., Loose (1865-71)	100	0 0		
Pearce, Maresco, Esq.	1	1 0		
Pearson, Miss Sophia	1	1 0		
Peart, H. B., Esq.	2	0 0		
Pease, E., Esq.	2	0 0		
Pease, Hy., Esq., Pierremont (1860-74)	100	0 0		
Peckover, A., Esq., Wisbeach (1857-75)	30	0 0		
Peckover, J., Esq., ditto	1	1 0		
Peckover, W., Esq., ditto (1857-74)	80	0 0		
Peebles Branch (1880)	15	0 0		
Peek, Winch & Co., Messrs.	5	5 0		
Peel, Sir Robert, Bart., G.C.B. (1871)	20	0 0		
Peel, Edmund Yates, Esq.	1	0 0		
"Peeps," per Mrs. Dalton (1880)	2	2 0		
Pelham, Lord (1876)	10	10 0		
Pemberton, E. L., Esq., M.P. (1868-73)	31	0 0		
Pembroke and Montgomery, The Earl of (1875)			250	0 0
Penarth Branch (1880)			25	0 0
Penfold, E. H., Esq.	2	2 0		
Penfold, Mrs. W. M.	1	1 0		
Peninsular and Oriental Steam Navigation Company	5	5 0		
Penn and Sons, Messrs. John	5	0 0		
Pennington, Mrs., Thickthorn	1	1 0		
Penson, Miss	0	10 6		
Penson, Mrs.	3	3 0		
Pepys, J. A., Esq. (1880)			10	10 0
Percy, Lady Louisa (1870-8)			150	0 0
Percy, The Right Hon. The Earl, M.P.	2	0 0		
Percy, Lord J. W.	2	0 0		
Perot, A. W., Esq., Demerara	1	1 0		
Perrott, Sir E.G.L., Bart., <i>V.P.</i>	1	1 0		
Pertwee, Joseph, Esq. (1867-71)	130	0 0		
Peters, Rev. M. Nowell	0	10 0		
Petre, John Berney, Esq.	2	2 0		
Pettitt, G., Esq.	0	5 0		
Philips & Co., Messrs. J. & N.	10	10 0		
Philips, Dr. Lovell, Torquay (1868-9)	15	0 0		

	Ann. Subs.		Donations.	
	£.	s. d.	£.	s. d.
Philips, J. W., Esq.	2	2 0		
Philips, Miss, Leamington	1	1 0		
Phillips, W. W., Esq.	1	0 0		
Phillimore, Capt. W. B. (1859-80)	205	10 0		
Phillimore, Vice-Admiral A.	3	0 0		
Phillips and Graves, Messrs.	1	1 0		
Phillipotts, W. F., Esq.	1	1 0		
Pick, Edgar S., Esq.	1	1 0		
Pickering, Leonard, Esq. (1872)	200	0 0		
Pickernell Brothers, Messrs.	1	1 0		
Pickernell, F. C., Esq.	1	1 0		
Piel Branch (1880)			20	0 0
Pigeon, Henry, Esq. (1864-79)			52	10 0
Pike, Mrs. Justine (1873-8)			20	0 0
Pilgrim, C. H., Esq.	2	2 0		
Pirie and Co., Sir John	2	2 0		
Pitt, Miss E., Ossington Street (1874-80)	3	0 0		
Pixley, Stewart, Esq.	1	1 0		
Platt, Fredk., Esq., Oldham (1873)	90	0 0		
Platt, Owen, Esq., Manchester	1	1 0		
Playne, Peter, Esq. (1860-79)			95	0 0
Plymouth Branch (1879)			50	0 0
Poë, Rev. J. Leslie	1	1 0		
Pol, Paris, Esq. (1871)			10	10 0
Pollard, Wm., Esq., Windermere (1880)			5	0 0
Poole, Mrs. E., Canonbury (1880)			1	0 0
Port Logan Branch (1879)			11	9 0
Port of Rochester Branch (1880)			16	12 10
Porteous & Senior, Messrs.	2	2 0		
Porter, Rev. C. F.	0	10 0		
Porter, Capt. H. R.	1	1 0		
Postans and Sons, Messrs.	0	10 0		
Potter and Co., Messrs.	1	1 0		
Potter, J. D., Esq.	2	2 0		
Powell, Messrs. T. J. and T.	1	1 0		
Poyer, J. P., Esq.	1	1 0		
Poynder, William, Esq., Hartham Park (1874)			500	0 0
Prall, Z. E., Esq.	2	2 0		
Pratt, Mrs. H., Leamington (1863-80)	210	10 0		
Prescott, H. W., Esq.	2	2 0		
Preston, Miss L. F. M.	5	0 0		
Price and Pierce, Messrs.	5	5 0		
Price, Mrs. Admiral (1879)			10	0 0
Price, Alfred, Esq., St. Leonards	1	1 0		
Priestley, Wm., Esq.	1	1 0		
Primrose, The Hon. B. F., C.B.	2	2 0		
Prince, John, Esq.	2	2 0		
Prince, Ogg, and Co., Messrs.	1	1 0		
Pritchard, J., Esq.	1	1 0		
Pritchard, Mrs., Astley Abbots	1	1 0		
Prowse, Capt. G. J. W.	1	1 0		
Psaila, Linga, Demerara	1	1 0		
"Psalm 107"	2	0 0		
Pugh, Miss, Leighton	1	0 0		
Purdie, Capt. John (the late)	1	1 0		
Queensberry, Marquis of	2	2 0		
Quick, Rev. R. H., M.A.	2	2 0		
R. B. and Co. (1867-80)			102	7 0
R. B. J. (1879)			5	0 0
Rabbetts, Rev. F. D., M.A.	0	5 0		
Rackham, Willoughby, Esq.	2	2 0		
Radcliffe, John, Esq., Furlane	1	1 0		
Rahn and Co., Messrs.	2	2 0		
Ralli Brothers, Messrs.	2	2 0		
Ralph, Charles, Esq.	2	2 0		
Ralph, Rowland W., Esq.	1	0 0		
Ram, Rev. Stopford J.	1	0 0		

	Ann. Subs.			Donations.				Ann. Subs.			Donations.		
	£.	s.	d.	£.	s.	d.		£.	s.	d.	£.	s.	d.
Ramsay, Capt. John, R.E.	2	0	0				Rochester, Thomas, Esq. (1870)	1000	0	0			
Randell, Edward, Esq., Mark Lane	1	1	0				Rockley, J., Esq., Boro'	1	1	0			
Randells, Howells, and Co.	1	1	0				Rodocanachi, Sons, and Co.	1	1	0			
Randolph, Admiral G. G.	5	0	0				Rodwell, Mrs. Helen, Winchester (1863-77)				91	9	8
Rawlins, Colonel	1	1	0				Rogers, Mrs., Westbourne Sq.	1	1	0			
Rawson, Miss, Tilney Street (1879)	100	0	0				Roget, Mrs., Maida Hill.	1	1	0			
Rawson, Miss E., Nydd Hall (1880)	100	0	0				Röhrweger, J. C., Esq.	1	1	0			
Ray, Brisco, Esq., in memory of the late Richard Glaister, Esq. (1875)				10	0	0	Rolle, The Hon. Mark	10	0	0			
Ray, Capt. H. R. (1873)				10	0	0	Rolleston, Miss, Bath	1	1	0			
Ray, Rev. Henry, B.A.	1	1	0				Rolt and Co., Messrs. Peter	2	2	0			
Raymond and Reid, Messrs. (1873)	50	0	0				Ropes, W. H., Esq.	1	1	0			
Reading Branch (1880)	123	13	10				Rose, Alderman Sir W. A.	1	1	0			
Reay, Capt., Leith (1879)				0	10	0	Rose, Mrs. A. M., Fulham	1	1	0			
Redfern, Alexander, and Co.	5	0	0				Ross, Wm. Lewis, Esq.	2	2	0			
Reece, Miss (1869-77)				24	0	0	Rosse, Dowager Countess of Rothery, H. C., Esq., M.A. (1880)				25	0	0
Reeves, A., Esq.	0	5	0				Rothschild, Messrs. N. M., & Sons	10	0	0			
Regent's Canal Company	3	3	0				Rotton, Major-General	1	1	0			
Reid, Alex., Esq., Demerara	1	1	0				Routh, Miss A.	1	0	0			
Reid, P., Esq., Stock Exchange (1879)	50	0	0				Routh, W. D., Esq.	5	0	0			
Reinachs, Nephew, and Co.	0	10	6				Rowbotham, Dr. Wm.	0	10	6			
Reiss Bros., Messrs.	2	2	0				Rowlandson, Miss Ann	1	1	0			
Remington, Rev. T. M.	2	2	0				Rowley and Davies, Messrs.	1	1	0			
Rendell, Jas. & Sons, Messrs.	1	1	0				Rowley, Col. Sir C., Bart.	2	2	0			
Reneau, Mr. & Mrs. R. P. W.	1	1	0				Royal Harwich Yacht Club	2	2	0			
Reynardson, Rev. G. B. (1865-72)	15	0	0				Royal Mail Steam Packet Co. (annual)				10	0	0
Ditto				2	0	0	Royal Yacht Squadron	10	0	0			
Reynardson, Rev. J. B.	1	1	0				Rubie, J. P., Esq., Cowes	1	1	0			
Reynolds, Rear-Admiral	0	5	0				Ruck Bros., Messrs.	0	10	0			
Reynolds, E. M. Esq.	1	1	0				Rudge, Miss, Oxford Square	1	0	0			
Reynolds, J., Esq.	0	10	6				Rudge, W. N., Esq. (1865-72)				31	10	0
Rich, H. T., Esq., Hounslow	0	10	6				Rufford, F. T., Esq.	1	1	0			
Richards, M., Esq.	1	1	0				Rugg, Mrs., Detling	1	1	0			
Richardson, Brothers and Co.	1	1	0				Runcorn Branch (1880)				12	1	8
Richardson, James G., Esq.	1	0	0				Ruskin, Professor, M.A.	5	0	0			
Richardson, Jonathan, Esq.	1	0	0				Rust, George J., Esq.	1	1	0			
Richardson, Miss	0	10	6				Rutherford Brothers, Messrs.	1	0	0			
Richardson, T., Esq.	1	0	0				Rycroft, Chas. A. W., Esq. (1863-71)	25	0	0			
Richardson, Walter, Esq. (1879)				10	0	0	Ryder, Admiral A. P.	1	0	0			
Rickett, Smith, & Co., Messrs.	1	1	0										
Ricketts, Miss Frederica	1	1	0										
Riddell, Miss, Beaufort Grdns.	2	2	0										
Ridge, Henry, Esq., Stock Exchange (1876-80)				12	12	0							
Ridgway & Co., Messrs.	2	2	0										
Ridpath, E., Esq.	1	1	0				S. C. H. (1859-77)				41	11	0
Rigge, H. F., Esq.	1	1	0				Ditto	1	1	0			
Riley, C., Esq.	1	0	0				S. H. H., "Little Colonial"	1	1	0			
Rivaz, Charles, Esq.	1	1	0				S. M., Kensington	1	1	0			
Rivington, Septimus, Esq.	1	1	0				S. M. J. (1880)				1	0	0
Robartes, The Rt. Hon. Lord	5	0	0				S. S., Tunbridge Wells	2	2	0			
Robartes, Hon. T. C. Agar, M.P.	2	2	0				S. Y. N. (1872-8)				30	0	0
Robarts, Henry C., Esq.	1	1	0				Sabel, Max, Esq.	1	1	0			
Roberts, C. W., Esq.	1	1	0				Saddlers, Worshipful Company of (1877-8)				30	10	0
Roberts, Miss, Brightwell	0	10	6				Sadler, Harrison, and Co.	2	2	0			
Robertson, Jas., Esq., Colombo (1880)	2	0	0				St. Ives Harbour Comm ^{rs}	10	10	0			
Robertson-Macdonald, Vice-Admiral D.	1	1	0				Saker, W. E., Esq.	2	2	0			
Robertson, Capt. G. M.	5	0	0				"Sally-forth," per Mrs. Dalton (1878-80)	12	12	0			
Robertson, Henry, Hull (1873)				100	0	0	Salmon, Capt. Henry Thomas (1875)	10	0	0			
Robertson, Mrs., Girtton (1863-79)	17	0	0				Salt, John Chas., Esq. (1879)				10	10	0
Robertson, Miss S.	1	1	0				Salters, Worshipful Company of 5	5	0	0			
Robertson, J. C. Esq.	1	0	0				Samuelson, Miss F. A.	0	10	6			
Robilliard, John, Esq., R.N. (1879)				0	10	0	Sancton, Philip, Esq. (1860-8)				25	15	0
Robins, Miss, Woburn Place	1	0	0				Sanders, F., Esq., Cross Keys	1	1	0			
Robins, Miss G., ditto	1	0	0				Sandwich, The Countess of (1872-80)				70	0	0
Robinson, F. J., Esq., Chester St.	2	2	0				Sandwich, The Earl of	1	1	0			
Robinson, G., Esq., Skipton	1	1	0				Sandys-Lumsdaine, Mrs.	1	1	0			
Robinson, Lawson, Esq.	1	1	0				Santley, Charles, Esq. (1879)				20	0	0
Robinson, Miss Emma	0	10	0				Sartoris, Alfred, Esq.	5	0	0			
Robinson, Rev. Henry (1874)				10	0	0	Sartorius, Sir G. R., Admiral of the Fleet, K.C.B.	1	1	0			
Robinson, Rev. T. B. B.	1	1	0				Sassoon and Co., Messrs. D.	2	2	0			
Rochdale Branch (1879)				85	17	9	Saul, G. T., Esq., Bow	1	1	0			

LIST OF DONATIONS AND ANNUAL SUBSCRIPTIONS.

87

	Ann. Subs.	Donations.		Ann. Subs.	Donations.		
	£. s. d.	£. s. d.		£. s. d.	£. s. d.		
Saunders, Miss Jane	2	2	0	Simpson, The Misses, Hadley	0	10	0
Saunders, Mrs., Durham Ter.	2	2	0	Sinclair, Mrs., Greenock (1874)	20	0	0
Savage and Hill, Messrs.	2	2	0	Singleton, Rev. R. Corbet,			
Savery and Moore, Messrs. . .	3	3	0	R. T. Y. C. (1857-77)	26	0	0
Saxe-Weimar, General H.S.H.				Ditto	1	1	0
Prince Edward of	1	0	0	Sismey, Mrs., Hadley Green.	2	2	0
Scales and Rogers, Messrs.	0	10	0	Skinnners, Worshipful Com-			
Scarborough Branch (1880) . . .	100	0	0	pany of (1865-77)	52	10	0
Scarth, W., Esq., Highbury . . .	1	1	0	Slater, Henry, Esq.	1	1	0
Schilizzi and Co., Messrs. (1867-74)	37	16	0	Slater, John, Esq., "A Thank-offer-			
Schwind, C. Esq., Broomfield . . .	1	1	0	ing to Almighty God for his late mer-			
Schloss Brothers, Messrs.	0	10	0	cies"	10	0	0
Scholey, Mrs.	1	1	0	Ditto	1	1	0
Schon, Master Percy (1880)	0	10	0	Smith and Co., Messrs. F.	2	2	0
Schroder & Co., Messrs. J. H. . . .	2	2	0	Smith and Sons, Messrs. G.	2	2	0
Scoer, A., Esq.	1	1	0	Smith, Colonel J. (1866-80)			
Scott, E., Esq., Colchester (1869-79)	6	4	0	Smith, Elder, and Co., Messrs. (1879)	6	6	0
Scott, Patrick, Esq.	1	1	0	Smith, Geo., Esq., St. John's			
Scott, Rev. Canon	1	1	0	Wood	1	1	0
Scott, Rev. M. R., M.A., & Mrs. . . .	1	1	0	Smith, Heathfield, Esq., Epsom (1864-72)	21	0	0
Scott, R. H., Esq., M.A.	1	1	0	Smith, J. B., Esq., Wood			
Scovel, Geo., Esq., Grosvenor				Green.	1	1	0
Place (1879)	2	0	0	Smith, J. Etherington, Esq., and Mrs.			
Scrimgeour, Mrs., Highgate (1872-9)	36	5	0	Smith, in aid of <i>Joseph Sykes</i> Life-boat			
Scrimgeour, Miss, Dorking (1866-79)	4	14	0	(1880)	3	3	0
Scriveners, Worshipful Com-				Smith, J. MacLaren, Esq.	10	0	0
pany of (1860-78)	37	7	0	Smith, J. W., Esq., Oundle	1	1	0
Seager, Charles H. Esq. (1872-8) . . .	15	15	0	Smith, Miss, as executrix of the			
Sebag, Joseph, Esq. (1877)	10	0	0	late R. Bryan Smith, Esq.	0	10	6
Seely, Chas., Esq., M.P. (1872) . . .	20	0	0	Smith, Miss F. L. C., North-			
Selborne, The Lord	2	0	0	ampton (1873-80)	41	0	0
Semple, A., Esq., Maida Vale	1	1	0	Ditto	1	1	0
Senior, J., Esq., Streatham	2	2	0	Smith, Mr. G., Walsall	0	5	0
Senior, Julian, Esq. (1877-9)	31	0	0	Smith, Mrs., Old Park	1	1	0
Settle Branch (1879-80)	347	14	10	Smith, Mrs. Peplow	5	0	0
Seyern, J. P., Esq.	3	3	0	Smith, Samuel, Esq., Bungay	2	2	0
Sewell, Mrs., Brompton	1	1	0	Smith, T. H., Esq., Regina			
Sewell, W., Esq., Kilburn	1	1	0	Road	1	1	0
Seyd and Co., Messrs.	1	1	0	Smith, Thomas Valentine,			
Shackleton, Richard, Esq.	3	3	0	Esq., Grosvenor Road (1878)	10	10	0
Shafto, Mrs. J. D.	1	0	0	Smith, W. Arthur, Esq., Bir-			
Ditto in aid of Swanage				mingham (1873)	10	10	0
Lifeboat (1875)	50	0	0	Smith, The Rt. Hon., W. H.,			
Sharp, Sidney, Esq.	2	0	0	M.P.	5	5	0
Sharpe and Co., Messrs. R.	1	1	0	Smith, Wm., Esq., Woodfield	10	0	0
Sharpe, Sutton, Esq.	3	0	0	Smith, Philip T., Esq., Nice (1880)			
Sharps and Wilkins, Messrs.	1	1	0	Smitheman, Mrs. E., Guildford (1879)	2	2	6
Shaw, Miss L. C.	0	5	0	Smithers, H. W., Esq., Amsterdam (1872)	10	0	0
Shaw, Rev. F.	1	1	0	Smithers, H. W., Esq., Moor-			
Shaw, Savill, and Co., Messrs.	1	1	0	gate Street	1	1	0
Sheffield Branch (1880)	39	1	4	Smythies, G., Esq.	2	2	0
Sheepshanks, W., Esq.	1	1	0	Soame, The Misses	2	2	0
Shepard & Co., Messrs.	2	2	0	Soames, E., Esq. (1876)	10	10	0
Shepherd, Arthur, Esq. (1869-74) . . .	41	0	0	Soames, Miss L. K., Greenwich	0	5	0
Shepherd, Major Howell (1859-71) . . .	46	10	0	Soames, W., Esq., Blackheath	2	2	0
Sherwood, Mrs., the late,				Society for the Discharge and Relief			
Reading (1877)	50	0	0	of Persons Imprisoned for Small			
Sherwood, Joseph, Esq. (1862-73) . . .	15	15	0	Debts (1877)	50	0	0
Shewell, Rev. Frank, M.A.	1	1	0	Soden, Rev. A. J.	0	5	0
Shiffner, Miss J. P. (1871-80)	21	0	0	Solly, Capt. L. B., R.N.	2	0	0
Shiffner, Mrs.	1	1	0	Sommer, Chas., Esq., New-			
Shipp, T. P., Esq.	1	1	0	castle-on-Tyne	1	1	0
Short, F. B., Esq., Buckham (1878)	10	0	0	Somes, Mrs. Joseph	1	1	0
Short, Mrs., Hastings	2	0	0	Somes and Co., Messrs.	1	1	0
Ditto (1869-75)	55	0	0	Soper, Joseph, Dawlish (1873)			
Shotton and Bouts, Messrs.	0	10	6	Souter, Miss, Norwood	1	1	0
Shuckburgh, Sir Geo., Bart.	2	2	0	South Devon Shipping Co.	3	3	0
Ditto, Contribution Box	18	6	5	South Metropolitan Gas Light			
Sibthorp, Colonel	2	0	0	and Coke Company (1864-79)	63	0	0
Sim, Captain Alexander	1	1	0	Southard and Co., Messrs.	2	2	0
Simes, N. P., Esq., Horsham	1	1	0	Southport Branch (1880)	10	6	9
Simon and Dale, Messrs.	2	2	0	Spaldin, Miss, Hull	1	1	0
Simonds, Robt. Henville, Esq.	1	1	0	Sparks, Mrs. Wm.	0	10	0
Simper, Mrs., Salisbury	1	1	0	Spartali and Co., Messrs.	1	0	0
Simpson, B. W., Esq.	1	1	0	Spawforth, Joseph, Esq.	5	5	0
Simpson, Lightly, Esq.	1	1	0	Spawforth, Mrs. E.	2	2	0

	Ann. Subs.		Donations.			Ann. Subs.		Donations.	
	£.	s. d.	£.	s. d.		£.	s. d.	£.	s. d.
Spencer, Maitland, Esq., Underleigh (1875-6)			30	0 0	Sullivan, Capt. T. B. M., R.N.	1	0 0		
Spencer, W., Esq.	2	2 0			Summerson, T. R., Esq.	0	7 6		
Sperling, Arthur, Esq.	1	1 0			Surr, Watson, Esq.	1	1 0		
Sperring, Henry John, Esq. (1878)			10	0 0	Surrey Commercial Dock Co.	5	5 0		
"Spes" (1879)			1	0 0	Sutherland, H., Esq., Dulwich	1	1 0		
Spicer, J. J., Esq.	1	1 0			Sutherland, His Grace the Duke of	5	0 0		
Spies Bros. and Co., Messrs. (1879)			10	0 0	Sutherland, R., Esq., Egham	5	0 0		
Spottiswoode, James, Esq., Perth (1859-73)			30	0 0	Swanzy, Messrs. F. and A.	1	1 0		
Spreckley, White, and Lewis	2	2 0			Swinburne, Sir J., Bart., F.R.S.	5	0 0		
Sprigens, Miss, Bow	1	1 0			Sykes, J., Esq.	2	2 0		
Staig, Capt., Leith (1879)			0	10 0	Sykes, Miss, Bristol	1	1 0		
Stallebrass, Mrs., South Hackney	0	10 6			Symonds, F., Esq., M.A. (in aid of the Isis Life-boat)	3	3 0		
Stalschmidt, E. E., Esq. (1872)			10	10 0	Symonds, Wm. Thos., Esq.	2	2 0		
Stamp, Mrs. Ann G., Hull	1	1 0							
Standen, Wm., Esq.	0	10 0							
Standidge and Co., Messrs.	1	1 0							
Standing Brothers and Co.	1	1 0							
Standing, Geo. C., Esq.	0	10 6							
Stanhope, General	2	2 0							
Stanley, J., Esq.	1	1 0							
Stanley, W. F., Esq.	1	1 0							
Stanton, J. T., Esq.	1	1 0							
Starkie, Mrs. (1867-75)			21	0 0					
Starky, Mrs., Bromham	1	0 0							
Stead, J. J., Esq.	0	5 0							
Steains and Co., Messrs. J.	1	1 0							
Stedman, Miss	1	1 0							
Stechford Branch (1880)			25	17 5					
Steel, Mrs., Cockermouth (1877)			10	0 0					
Steinmetz, J. H., Esq.	1	1 0							
Stennett, J. H., Esq., Miningsby (1877-9)	9	10 0							
Stephen, Mrs. Leslie	2	2 0							
Stephens, P. S., Esq., and Mrs. Scott	2	2 0							
Stericker and Co., Messrs.	1	1 0							
Sterling, Miss Julia	5	5 0							
Stern, Baron Herman De, per M. Lea, Esq. (1878)			10	0 0					
Stern Brothers, Messrs. (1876-7)			47	5 0					
Stevenson, Miss H. B., Iver	3	3 0							
Steward, Rev. C. H.	1	1 0							
Stewart, Com. Duncan, R.N., One Day's Half-pay	0	8 6							
Stewart, Mrs. Duncan (the late)	1	1 0							
Stewart, Rev. J., Lisburn	1	0 0							
Stiebel Brothers, Messrs.	1	1 0							
Stilwell, Thomas, Esq. (1862-75)			42	0 0					
Stirling Branch (1830)			57	5 9					
Stock, Mrs., Bristol	2	0 0							
Stocken, F., Esq., Pimlico	1	1 0							
Stocks, Major, Halifax	2	2 0							
Stone, E. M., Esq., and Mrs. Stone	5	5 0							
Stone, J., Esq., Broad St.	1	1 0							
Stone, Mrs. John, Ashburton	1	0 0							
Stopford, Mrs. Grosvenor	1	0 0							
Stowers, Rev. H. M.	1	1 0							
Strahan, W. S., Esq., Buxton	2	2 0							
Strange, Mrs. Mary Ann	1	1 0							
Streafteild, R. J., Esq.	5	5 0							
Street, George, Esq.	1	1 0							
Strickland, A. E. C., Esq.	1	1 0							
Stripling, Miss, Lichfield.	2	0 0							
Ditto (1879)			25	0 0					
Stuart, Colonel	2	0 0							
Stuart, Geo., Esq. (1865-79)			42	0 0					
Stucley, Lieut.-Colonel	1	0 0							
Sturrock, Archibald, Esq.	2	2 0							
Stutfield, W., Esq.	1	1 0							
Stutfield, Mrs. (1867-76)			45	0 0					
Suart, Mrs. Alfred	1	0 0							
Sugden, Richard, Esq.	1	1 0							
					T. H. N., Thanksgiving for a safe voyage (1870)			16	0 0
					T. J. M. (1877-9)			50	0 0
					T. J. S.	0	5 0		
					Taddy and Co., Messrs.	3	3 0		
					Taitte, Charles, Esq.	1	1 0		
					Talbot, Lady	1	1 0		
					Tallow Chandlers, The Workshopful Company of (1869-70)			21	0 0
					Tangye Brothers & Holman	0	10 6		
					Tanqueray & Co., Messrs. C.	2	2 0		
					Taplin, Thomas, Esq., the late (1859-73)			26	5 0
					Tapling and Co., Messrs. Thos.	2	2 0		
					Tapper, A. A., Esq.	1	1 0		
					Tarleton, Admiral Sir Walter, K.C.B.	1	1 0		
					Turner, A. T., Esq.	1	0 0		
					Turner, E. T., Esq.	1	0 0		
					Turner, G. Edward, Esq.	1	1 0		
					Turner, H. T., Esq.	1	0 0		
					Turner, Miss C. T.	0	10 0		
					Turner, Miss L. T.	0	10 0		
					Tarratt, Josh., Esq.	2	2 0		
					Tarratt, Mrs., Ashford Hall (1877)	300	0 0		
					Tassell, Mr. F.	0	5 0		
					Tate, Miss C. E.	1	1 0		
					Tatham, Admiral E., C.B.	1	1 0		
					Tattersall, John, Esq., one year's maintenance of a Life-boat station (1877)	70	0 0		
					Tatton, Lees W., Esq., Manchester			1	1 0
					Tatton, Mr. Samuel	0	10 0		
					Taunton, Miss, in memory of the late Lady Taunton	1	1 0		
					Tawke, A., Esq., and Mrs. Tawke, The Lawn, Rochford	0	10 0		
					Taylor and Sons, Messrs. J.	1	1 0		
					Taylor, Charles, Esq., Manningtree	1	1 0		
					Taylor, J. D., Esq. (1865-79)			85	0 0
					Taylor, Mrs., Liverpool (1878-9)			1	10 0
					Taylor, Mrs. W., Hampton Court (1866)	20	0 0		
					Taylor, Rev. Alfred R.	1	1 0		
					Taylor, Wm., Esq., Lee	1	1 0		
					Taylor, W., Esq., Jun., Lee	1	1 0		
					Taylor, W. R., Esq.	0	10 0		
					Teevan, Major G. J.	1	0 0		
					Temperleys, Carter, & Darke	1	1 0		
					Tempest, J., Esq., Derby	1	1 0		
					Templer, R. B., Esq.	1	1 0		
					Terry, John, Esq.	3	3 0		
					Tesdorpf & Co., Messrs. A.	2	2 0		
					Tetley and Co., Messrs. J.	0	10 0		
					Tetley and Son, Messrs. E.	1	1 0		
					Tetley, The Misses, Halffield (1869-78)			70	0 0

	Ann. Subs.		Donations.			Ann. Subs.		Donations.					
	£.	s. d.	£.	s. d.		£.	s. d.	£.	s. d.				
Thames & Mersey Marine Insurance Co., Royal Exchange	5	5	0		Union Steam Ship Company (1877)			10	10	0			
Thomas, Capt. Montague, R.N. (1868-80)			59	0	0	Unite, W. O., Esq.	1	1	0				
Thomas, Charles, Esq.		0	10	6	Upton, H., Esq., Petworth (1859-69)			54	12	0			
Thomas, D. C., Esq.		0	10	6	Ditto			3	3	0			
Thomas, John C., Esq.		1	1	0	Urwick, W. H., Esq.			1	1	0			
Thomas, Mr. W., Caerphilly		0	10	0	Usborne and Sons, Messrs.			1	1	0			
Thompson, Adam, Esq.		1	1	0	Usborne, Miss A. M. (1869)			10	0	0			
Thompson, Vice-Adm. T. P.		1	0	0	Usherwood, Miss			2	2	0			
Thompson, Henry, Esq.		1	1	0									
Thompson, Messrs. W. J. & H.		2	2	0	Vacher, E. P., Esq. (1871)			10	10	0			
Thorley Rectory, Bishop's Stortford		2	2	0	Vacher, H. P., Esq. (1871)			10	10	0			
Thorngate, W., Esq. (the late), Trustees of		80	0	0	Valpy, R. H., Esq., Newbury	3	0	0					
Threlfall, Chas., Esq. (1867-9)				20	10	0	Vanner and Prest, Messrs.	1	1	0			
Ditto		5	5	0	Vansittart, A. A., Esq. (1859-79)			155	10	0			
Threlfall, Mrs.		1	1	0	Vardon, Miss E.	1	1	0					
Thresher, Capt. W. (1871-80)				15	15	0	Vardon, Mrs. F. (1863-77)			10	10	0	
Thwaites, D., Jun., Esq. (1868-70)				15	0	0	Vardon, H., Esq.			1	1	0	
Tidd, Frederick A. Esq. (1870)				10	10	0	Varnam, Miss H., Pailton			0	10	6	
Tidd, Walter R., Esq. (1873)				10	10	0	Vaughan, Henry, Esq. (1870-3)			30	10	0	
Tillard, Edward, Esq.		1	1	0	Vaughan, Mrs., Westbourne Terrace			5	5	0			
Tindall, Riley, & Co., Messrs.		1	1	0	Venning, Edgecombe, Esq.	1	1	0					
Tindall, W. H., Esq.		1	1	0	Verney, Capt. E. H., R.N.			1	1	0			
Tinley, Mr. R. R.			0	10	0	Vernon, Miss Emma P.			1	1	0		
Tisdall, Mr. Sidney, and Friends (1874-80)	6	15	0		Vernon, Rev. H. J., B.A.			0	10	0			
Toke, Major		1	1	0	Verrall, Miss Laura, Southover (1873)			50	0	0			
Tollemache, Hon. Algernon Grey (1867-77)			250	0	0	Verulam, The Earl of (1876)			10	0	0		
Tomkinson, Thomas, Esq. (1861-74)			115	0	0	Vesey, Capt. R.N. (1864-78)			21	0	0		
Toms and Co., Messrs.		0	10	0	Victoria, steamer, Owners of the (1879)			5	5	0			
Toppin, Miss, Putney		1	1	0	Vigne, John, Esq.			1	1	0			
Torquay Branch (1879)				60	19	10	Vincent, J., Esq.			1	1	0	
Towgood, Alfred, Esq.		1	1	0	Violet (1880)					3	0	0	
Towgood, Edw., Esq.			2	2	0	Vivian, Younger, and Bond, Messrs.			1	1	0		
Townend and Co., Messrs. T.		1	1	0									
Toynbee, Capt. H.		1	1	0	W. (1862-78)					80	0	0	
Tramore Branch (1879)				10	0	0	W. A. D. (1875-80)			50	0	0	
Treherne, H., Esq., Ashperton		0	10	0	W. F. S., Lloyd's (1877)					25	0	0	
Treherne, Mrs. Hy., ditto		0	10	0	W. J. H. (1879)					0	10	0	
Trigg, Mrs. James		0	10	6	W. M., Woodford			1	1	0			
Trotter, Mrs., Thurloe Sq.		5	0	0	Wace, J. R., Esq., Baker Street	1	1	0					
Trotter, William, Esq. (1872)				10	0	0	Waddington, Mrs. J. T. (1869-78)			52	10	0	
Trower, Alfred, Esq., The late (1878-9)	10	10	0		0	Wagstaff, James, Esq.			1	1	0		
Troyte, C. A. W., Esq.		1	1	0	Wain, R., Esq., Clifford St.			1	1	0			
Tryon, Hon. Mrs.		1	0	0	Wakefield Branch (1880)					33	0	0	
Tudor, E. O., Esq.		1	1	0	Wakefield, Miss M. R. (1860-73)					76	5	0	
Tudor, Henry, Esq.		1	1	0	Waldegrave, the Earl			5	5	0			
Tudor, Mrs. Langley		1	1	0	Walker, Geo., Esq.			1	1	0			
Tufton, Sir Henry J., Bart.		3	3	0	Walker, G. J. A., Esq.			1	0	0			
Tulloch, General, R.A.		1	1	0	Walker, J. L., Esq.			1	0	0			
Tulloch, Miss		1	1	0	Walker, John, Esq., Halifax (1876)			20	0	0			
Tunstall Branch (1879-80)				12	12	0	Walker, Lady			1	1	0	
Tupp, Mr. J., Tottenham Court Road (1874-9)				6	3	0	Walker, Philip A., Esq.			1	1	0	
Turle, James, Esq., M.D.		1	1	0	Walker, Thos., Esq., M.D., Peterborough			1	1	0			
Turle, Mrs.		0	10	6	Walker, W. N., Esq. (1873-6)					15	0	0	
Turner, Miss, Holloway		1	11	0	Ditto			1	1	0			
Turner, Miss, in continuation of the late Major		1	1	0	Wallace Brothers, Messrs.			3	3	0			
Turner, Mrs., Liverpool (1877)				100	0	0	Walrond, C. T., Esq.			1	1	0	
Tweddle, Mrs. (1872-80)				15	15	0	Walsh, Mrs., Winchester			0	10	0	
Twining, H. H., Esq.		1	1	0	Walters, Rev. A. V., B.A.			0	5	0			
Two Friends, per Miss Worsencroft (1879)				1	0	0	Walton, Charles, Esq.			1	0	0	
Ditto		1	0	0	Walton, Francis, Esq., Lloyd's			1	1	0			
Two Sisters (1877-80)				8	0	0	Walton, Geo., Skipton (1873)				10	0	0
Tylden, Mrs., Oxford		1	1	0	Wanklyn, J. B., Esq. (1872)					10	10	0	
Tyndall, W. H., Esq.		1	1	0	Ward, Vice-Admiral J. R.			1	1	0			
Tyser, G. D., Esq., Lloyd's		1	1	0	Ward, C. B., Esq.			1	1	0			
					Ward, H. C., Esq.			1	1	0			
					Ward, Miss, St. Leonards			0	5	0			
					Wardlaw, Major-Gen. R.			1	0	0			
Uhthoff & Co., Messrs.		1	1	0									
Ulph, Messrs. J. B., and Son		1	1	0									

	Ann. Subs.		Donations.			Ann. Subs.		Donations.		
	£.	s. d.	£.	s. d.		£.	s. d.	£.	s. d.	
Warner, F., Esq., Hoddesdon	0	10	0	0	Whyte, Capt. W. H., R.N.	1	0	0		
Warner, R., Esq.	2	0	0		Wickens, Rev. H. (1861-9)			35	10	
Warner, W. H. Lee, Esq. (1879)			3	3	0	Wieting and Richter, Messrs., Demerara	1	1	0	
Warren and Jones, Messrs.	0	10	6		Wilbe, R. H. Esq., M.D. (1877-9)			2	2	
Warren, Mrs., Leamington (1861-79)	19	0	0		Wilde, Spencer C., Esq.	1	1	0		
Waterall, Nathaniel, Esq.	1	1	0		Wilkinson, J. R., Esq.	1	1	0		
Waterall, Roby, Esq.	1	1	0		Wilkinson, Mrs. M. D. P. "In remembrance of a dear friend" (1874)			10	0	
Waterfield, Mrs.	1	0	0		Wilkinson, O. R., Esq.	1	1	0		
Waterfield, The Misses (1869-80)	17	17	0		Willans, Mrs. Russell	1	1	0		
Waters and Co., Messrs. Jas.	1	1	0		Willans, Overbury, & Co., Messrs.	2	2	0		
Watney, Norman, Esq. (1864-9)			15	15	0	Williams, Admiral W. J. (1871-80)			20	0
Watson, C., Esq., Halifax	2	2	0		Williams, J., Esq., Mark Lane	0	10	0		
Watson, J., Esq.	1	1	0		Williams, O. J., Esq.	1	1	0		
Watson, Lieut. H. J. (1875)			12	12	0	Williams, Robert, Esq., Wrexham	0	10	6	
Watson, Col. W. H., R.A., in aid of Holy Island Life- boat	5	0	0		Williamson, A. D., Esq., Haxby (1861-73)			31	15	
Watson, Mrs., Holland Park (1876-80)	55	0	0		Willmott, Miss E. A.	1	1	0		
Watson, Rev. G. Bowes	1	1	0		Willmott, W., Esq. (1877)			21	0	
Watts and Manton, Messrs.	2	2	0		Willink, W. W., Esq.	2	2	0		
Watts, Ward & Co., Messrs.	5	5	0		Willis, Com. G. H. R., R.N.	1	0	0		
Waugh, James, Esq.	1	1	0		Willis, H. B., Esq.	1	1	0		
Wayet, Rev. W.	2	2	0		Willis, Henry, Esq. (1876)			10	10	
Webb, Rev. R. Holden (the late)	0	10	6		Willis, J. E., Esq. (1864-70)			65	0	
Webb, Mrs. Holden	0	10	6		Willis, Major W.	1	1	0		
Webb, R. T., Esq.	2	2	0		Willis, Mrs.	1	1	0		
Webb, W. L., Esq.	1	1	0		Willis, A., Esq., Alderney (1879)			0	10	
Webber, C. Sanicroff, Esq.	1	0	0		Wills, Mrs., Shaftesbury	0	10	0		
Weber, Arthur, Esq.	1	1	0		Wilmott, E. W., Esq.	1	1	0		
Webster, George, Esq., Fins- bury Street, on account of a Life-boat (1864-78)			200	0	0	Wilson, Capt. J. E. M., R.N.	1	1	0	
Webster, Mrs., Ealing	1	0	0		Wilson, John R., Esq.	1	1	0		
Webster, W., Esq.	0	10	0		Wilson, J., Esq., Hackney	1	1	0		
Weddell, W., Esq., Leith (1879)			0	10	0	Wilson, Lieut. William, R.N. (1874-9)			23	0
Wedge, Fras., Esq. (1866-72)			30	0	0	Wilson, Miss, Maidenhead (1878)			10	0
Wedgwood, Miss S. E. (1863)			15	0	0	Wilson, Miss A. S.	2	2	0	
Welch, Henry, Esq., Bright- on (1870-7)			31	0	0	Wilson, Miss H. J.	2	2	0	
Welch, Margetson, and Co., Messrs.	1	1	0		Wilson, Rev. Robert (1858-75)			102	10	
Wells, Wm., Esq., Redleaf	1	0	0		Wilson, Wm., Esq., Highbury	1	1	0		
Welsh, A., Esq. (1878-9)			10	0	0	Wilson, Rev. Roland (1880)			2	0
Wentworth, Miss L. M. H. V. (1870-9)	70	0	0		Winckworth, Lewis, Esq.	2	2	0		
Ditto	2	2	0		Windley and Barwick, Messrs.	2	0	0		
Wentworth, Vernon, Esq. (1876)	10	0	0		Windsor, Miss E.	0	5	0		
Were, Josh., Esq., Broadchist (1861-77)	170	0	0		Wing, Thomas, Esq., Bos- more Hall (1875)			10	10	
Were, Mrs. Bouville (1860-75)	33	12	0		Winter, The Misses M. E. and E. (1869-80)			25	4	
Ditto	2	2	0		Wire, Travers B., Esq.	1	1	0		
Western Central Counties Branch (1879)	21	10	9		Wire, Mrs. Travers B.	1	1	0		
Westmore, Rev. H. H., M.A.	1	1	0		Wise, H. C., Esq.	1	1	0		
Weston, Ambrose, Esq. (1872-5)	31	10	0		Wise, Richard, Esq., St. Ives	1	1	0		
Weston, Jas., Esq., St. Leonards (1879)	1	1	0		Wolverhampton Branch (1880)			42	4	
Weston and Westall, Messrs.	1	1	0		Wood, F., Esq., Sidcup	0	10	6		
Weston-super-Mare Branch (1879-80)	37	9	10		Wood, J. Garthorne, Esq.	5	0	0		
Weston, W., Esq., Bramley (1880)	10	0	0		Wood, Mrs. B., The Lodge (1854-76)			235	0	
Whalley, F. R., Esq.	2	2	0		Wood, W. N., Esq., (1876-80)			3	0	
Wheeler, E., Esq., Stock Exch.	1	1	0		Woodcock, Henry, Esq., Bol- nore	2	2	0		
Wheeler, George, Esq.	1	1	0		Woodhouse, Rev. E.	0	10	0		
Wheeler, H. S., Esq.	1	1	0		Woodroffe and Westrope, Messrs.	1	1	0		
Whichcote, Mrs. Francis.	2	0	0		Woodruff, Rev. Thos., M.A.	1	1	0		
Whish, Admiral (1879)	25	0	0		Woods, Mrs. H. T.	1	1	0		
Whitaker, T. S., Esq.	1	1	0		Woolcott, Wm., Esq.	1	1	0		
Whitby, Messrs. W. and G.	1	1	0		Woolfe and Son, Messrs.	2	2	0		
White Brothers, Messrs.	1	1	0		Woolley, Miss, Kensington (1877)			15	0	
White, J., Esq., Gt. St. Helens	1	1	0		Worcester Branch (1880)			29	6	
White, John, Esq., Cowes	1	1	0		Worms, Messrs. G. and A.	1	1	0		
White, Miss M. C., Brighton (1868-80)	16	10	0							
Whitehaven & Seascale Branch (1880)	20	0	0							
Whitehead, T. S. & Co., Messrs.	0	10	6							
Whiteley, George, Esq. (1871)	50	0	0							
Whiteman, Stephen, Esq.	1	0	0							
Whiteron, J., Esq. (1869)	11	0	0							
Whiting, R. M. & H., Messrs.	0	10	0							
Whitley, C., Esq., Smithfield (1880)	1	0	0							

Ann. Subs.		Donations.		Ann. Subs.		Donations.	
£.	s. d.	£.	s. d.	£.	s. d.	£.	s. d.
Worsley, Rev. P. R., M.A. (1876-9)		4	0 0	Yates, Capt. R. B.	1	1	0
Worthing Branch (1880)		10	0 0	Yates, J., Esq., Rotherham	0	10	0
Wright, Henry E., Esq.	2	2	0	York Branch (1880)			55 18 6
Wyndham, Mrs., Salisbury	1	1	0	Youle, F., Esq. (1863-73)			55 5 0
X. I. V.		1	0 0	Young and Lark, Messrs.	1	1	0
X. Y. Z. (1867-75)		215	0 0	Young, Capt. Sir A. W.	1	1	0
				Zulueta and Co., Messrs.	1	1	0

FORM OF BEQUEST OF MONEY, STOCK, OR OTHER PERSONAL ESTATE.

I give and bequeath to the ROYAL NATIONAL LIFE-BOAT INSTITUTION for the Preservation of Life from Shipwreck, founded in 1824, London, the sum of £ _____ *for the use of the said Institution; and I do hereby direct that the same be paid exclusively out of such part of my Personal Estate as may lawfully be appropriated to such purpose, and that the receipt of the Treasurer for the time being of the said Institution shall be a sufficient discharge to my Executors for the same.*

ROYAL NATIONAL LIFE-BOAT INSTITUTION,
14 John Street, Adelphi, London,
1st May, 1880.

The Royal National Life-boat Institution

Is prepared to establish and maintain a Life-boat Station on any part of the coast of the United Kingdom where it can be shown, from previous disasters, that a Life-boat is required. It is requisite that there should be a sufficient number of men (fishermen, or others accustomed to the management of boats at sea) to man the Life-boat, and a Committee formed from the residents in the neighbourhood to superintend the Station and obtain such small Annual Subscriptions as may contribute towards a portion of the expense of the Life-boat Station.

Communications may be addressed to

THE SECRETARY OF THE INSTITUTION,
14 JOHN STREET, ADELPHI, LONDON, W.C.

LIST OF GENERAL COLLECTIONS, ETC., 1879-80.

	£.	s.	d.		£.	s.	d.
Aberford Alms Box, one month, per Rev. Canon Eden	0	17	0	Netheravon Church, collection per Rev. W. H. Heaven, M.A.	1	3	6
Adderley Church, offertory, per Rev. A. Corbet, M.A.	4	8	6	Newton-by-Sudbury, share of harvest thank-offering, per Rev. Reginald Smith.	1	1	0
Ashford, Alexander Academy, Schoiars and Family of Mr. T. H. Vie	2	0	0	Nicholson, Master A., Totteridge, collected by	0	10	0
Biddestone, near Chippenham, proceeds of Penny Readings, per Rev. J. Emra	1	7	0	Nunn, Rev. F. J., Maidenhead, pupils of	1	2	0
Bird, Mrs. G. A., collected by	1	2	0	Odd Fellows, Independent Order of (M.U.), Loyal Hope of Bloomsbury Lodge	1	1	0
Bromley, Mrs. W., Penge, collected by Brompton Sunday Schools, collected at, per Mr. F. M. Bryant	10	11	0	Ditto, Nelson Lodge, Norwich (Annual)	2	2	0
Chilton Parish Church, portion of Harvest Festival collection, per Rev. Herbert Smith, M.A.	1	5	0	Ditto, Prosperity Lodge, Norwich (Annual)	1	1	0
<i>Christian, The</i> , Readers of, per Messrs. Morgan and Scott	13	0	0	Oxford Gas Works employes, per J. Eldridge, Esq.	3	17	0
Clare, Miss Constance Leigh, col. by Demerara, West Indies, collected by Alexander Reid, Esq. (Annual)	1	16	6	Park Chapel Boys' Sunday School, per Mr. Arthur Gunn	1	1	0
Elvetham Church, offertory on Christmas Day, per Rev. W. Gill	7	0	0	Penny Life-boat Fund, per Sir Thomas Tobin (additional)	4	0	0
Fazakerley, Miss, collected by	1	8	0	Pin-cushions. Patent Life-boat, portion of profits by their sale, per Miss M. A. Rich, Neston.	0	9	6
Fines of a Mutual Improvement Society, per Miss Stolterfoht	0	10	0	Price, Master Arthur, collected by	0	7	6
Forrest, Miss S. F., Sparkbrook, collected by	0	10	0	Rowland, Edwin, Esq., Bristol, penny subscriptions, collected by	4	12	0
Freemasons, Leigh Lodge of, in aid of <i>Lady Leigh</i> Life-boat (Annual)	1	1	0	S. Michael's Life-boat Fund, per Rev. G. F. Prescott, M.A., towards support of Kessingland No. 2 Life-boat	1	1	7
Ditto, Temperance Lodge 739 (Ann.)	2	2	0	Shaboe, Rev. D., in aid of Masonic Life-boat	2	0	0
Ditto, Lodge 809, Wisbeach (Ann.)	2	2	0	Sinclair, T. B., Esq., Liverpool, collected by	1	2	6
Hadnall Church, near Shrewsbury, per Rev. Brooke C. Mortimer	5	4	11	St. Paul's, Clerkenwell, collection after the Children's Flower Sermon on Whit Sunday, 1879, per Rev. A. S. Herring	1	7	6
Harby Church, collection on 1st Sept. per Rev. M. O. Norman	1	0	0	Stubton Church, offertory at, per Rev. P. R. Worsley, M.A.	2	0	0
Hayes, C., Esq., Clapham Park, collected by	0	10	0	Swearing Club fines	0	5	0
Holloway, Upper, chapel, Young Men's Christian Union, per Mr. P. Terry, jun.	0	10	0	Temple, Mr. M. H., further on account of his Life-boat fund	4	0	0
Hotham, F. W., Esq., Buckland Rectory, collected by	2	13	3	Tilney Church, King's Lynn, collected at, per Rev. J. S. Phillips.	1	0	0
Howlett, Capt. E. W., steamer <i>Stork</i> , proceeds of lecture	0	10	0	Tupp, Mr. J., Tottenham Court Road, employes of	0	18	0
Huddersfield, Mount Pleasant Board School, per Mr. F. Jackson	0	10	0	West, Miss, Woburn	1	6	6
Hunter, Mr. Jno. Buncrana, collected by Johnson, Miss, Wrexham, collected by Licensed Victuallers' School, Miss English, Matron, and Officers, and Children, in aid of <i>Licensed Victualler</i> Life-boat	3	0	6	Wolverhampton, proceeds of entertainment, per Thomas Skidmore, Esq.	5	0	0
Ling, Miss, Lincoln, collected by	0	9	6	Wyndham, F., Esq., collected by	0	16	0
Ludford Church, collected at, per Rev. Charles Kent	1	13	5				

CONTENTS OF PILLAR AND OTHER CONTRIBUTION BOXES, 1879-80.

(In addition to those included under "SEAMEN'S COLLECTIONS.")

	£.	s.	d.		£.	s.	d.
Alexandra Palace Pillar Box	3	0	0	Cox and Son, Messrs., Chancery Lane.	1	6	0
Allen, Ashton C., Esq.	7	16	3	Crystal Palace Pil. Boxes, per Dr. Price	7	1	11
Barker, R. E., Esq., Shepherd's Bush.	0	11	3	Dashwood, C. G., Esq.	7	1	10
Bristol, Royal Hotel, College Green, per Mr. F. Swanson	1	14	0	Day and Son, Messrs. R., Cork	0	10	3
Brittain, John, Esq., Swindon	0	5	6	East India Docks Pillar Box, per Capt. Marrable.	1	6	1
Burnley, Thorn Hotel, per Mr. G. C. Ogden	1	1	0	Exeter, Albert Memorial Museum and Free Library	1	12	9
Calcott Church, contents of box, and Children of National School, per Miss Henniker	1	16	0	Farrar, Miss, Brixton	2	2	1
Cloves, Mrs. R., Stockwell Park Road	0	10	4	Fenchurch Street Railway Station	3	7	0
Conlon, F. P., Esq., Lincoln	1	7	6	Gaskell, G. V., Esq., New Leeds, collected after Lecture	0	12	9
				Geary, Mr. W. N., Cadogan Place.	2	0	0

LIST OF COLLECTIONS FROM SEAMEN.

93

	£.	s.	d.		£.	s.	d.
Greet, Miss, Old Charlton	0	11	1	Payne, Miss	1	4	0
Gore, Mrs., Brighton	2	0	0	Peacock, Mrs., Cardiff	3	0	8
Harris, Master Josh. C.	0	11	0	Plymouth, Duke of Cornwall Hotel, per			
Horn, Mr. J. E., West India Dock Road	0	7	9	Mr. Budd	3	14	0
Jackson, G. R., Esq., Great Driffield .	1	1	0	Ramsgate Pillar Box, per Captain			
King's Head, Fenchurch Street, London,				Braine	16	1	9
per Mr. H. D. Davies	1	15	2	Do. Contribution Boxes at Hotels, &c.	2	16	8
Jersey, Pillar Box, per J. Sullivan, Esq.	2	9	0	Ramsgate—Contribution Box at South-			
Johnson, Mrs.	16	10	4	Eastern Railway Station	0	15	9
Keal, Miss, Hereford	0	15	0	Robinson, H. P., Esq.	3	1	0
Lambeth Police Ct., per G. A. Bird,				Roskrow, Mrs., Redruth	0	10	0
Esq.	1	2	0	Shuckburgh, Sir G., Bart.	1	0	0
Liverpool Street, Great Eastern Rail-				Skinner, Mrs., Cambridge	0	10	0
way Station	2	11	6	Slade, S., Esq., Polruan	1	0	0
London Bridge Railway Station	1	16	3	Southampton Pillar Box, per C. A.			
London Docks Pillar Box, per Mr.				Jellicoe, Esq.	3	7	7
Cox	4	2	1	Stones, Miss, Herne Bay	0	13	0
Maitland, J. N. Esq., Kensington . . .	2	5	0	Trowbridge, Mr. T.	0	5	0
Martin, J. S. Esq., Montague Place . .	2	0	0	Victoria Railway Station	2	6	8
Nottingham, Roebuck Hotel, per Mr.				Waterloo Railway Station	2	2	4
R. Hill	0	17	6	Watson, Thomas, Esq., Row	3	8	0
Old Bell Hotel, Holborn, per Miss				West India Docks Pillar Box, per Capt.			
Bunyer	3	0	0	Hussey	1	1	2

COLLECTIONS FROM SEAMEN AND OTHERS, BY COLLECTORS OF CUSTOMS, BY THE AGENTS OF THE SHIPWRECKED MARINERS' SOCIETY, AND BY OTHERS, IN 1879-80.

	£.	s.	d.		£.	s.	d.
Belfast, per T. Gray Jones, Esq.	6	5	5	Inglis, Mr. Alexander, Aberdeen . . .	102	4	6
Blyth, per Mr. J. Robinson, Jun.	5	3	5	Ipswich, per J. Walker, Esq.	4	2	10
Borrowstoness, per John Campbell,				Jersey, per George Clayton, Esq. . . .	2	10	0
Esq.	3	14	3	Jumna, H.M.S., Canteen Fund, per			
Boston, per Mr. J. E. Ridlington	0	13	6	Lieut. M. L. Kelham, R.N.	5	0	0
Bristol, per G. C. Whitwell, Esq.	6	12	5	King Ermyn, s.s., of Southampton, col-			
California, s.s., per Capt. Donaldson . .	4	10	3	lected on board, per Captain Harlow	5	0	0
Cardiff, s.s., crew of the, per Capt.				King's Lynn, per J. Scott, Esq.	10	4	4
Peacock	0	15	0	Kirkwood, Ship, of Liverpool, Captain			
Carnarvon, per John Jackson, Esq. :—				J. Sinnott & Crew	1	7	0
	£.	s.	d.	Lady Josyan, s.s., collected on board,			
Carnarvon Castle, Sergeant				per Capt. P. Maret	2	16	0
Watkins	0	4	7	Leigh, per H. Thompson, Esq.	2	12	5
Custom House Tavern, per				Leith, per A. M. Ross, Esq.	10	5	9
Capt. Roberts	0	6	7	Liverpool, per W. G. Stewart, Esq. . .	2	15	10
Drum Hotel, per Mr. Edwards	0	5	6	London Custom House, per J. W.			
Prince of Wales Hotel,				Douglas, Esq.	0	6	9
per Mr. J. Lloyd	0	5	7	Maldon, per A. McNab, Esq.	0	13	6
Roberts, Captain, Port				Manitoba, s.s., collected on board,			
Dinorwic	0	6	5	per Capt. McDougall	3	15	7
Roberts, Mr. Hy.	0	5	10	Montrose, per Lawrence S. Smith, Esq.	1	5	7
Roberts, Capt. R., Llanberis	0	14	1	Newport, Monmouth, per Caleb Cox,			
Ship and Castle, per Mrs.				Esq.	5	18	0
Williams	0	11	6	Newry, per William Dear, Esq.	2	5	0
Three Crowns, per Mr. I.				Phaenician, s.s., collected by Capt. J.			
Peters	0	3	7	Scott	0	13	1
Williams, Moses, On Snowdon	0	12	4	Poplar, Board of Trade Offices, per			
Collections under 2s. 6d.	1	1	6	Capt. Jas. Furnell, R.N.R.	6	15	5
	4	17	6	Portsmouth, per Robert Raggett, Esq.	1	0	0
Dover, per T. W. Clarke, Esq.	0	17	6	Port William, per Thomas Whyte, Esq.	0	12	0
Dublin, per M. Lapfern, Esq., and				Silloth, per Mr. W. Smith	1	3	0
M. J. O'Connor, Esq.	7	12	8	St. Andrew's, per N. McLeod, Esq. . .	0	9	3
Faversham, per John Smith, Esq. . . .	4	15	6	St. Katherine's Docks, Mercantile			
Fowey, per Emra Holmes, Esq.	1	12	6	Marine Office, per Capt. J. Watson .	4	11	8
Glasgow, per T. Miller, Esq.	72	15	9	Sunderland, per Messrs. R. Hudson and			
Gloucester, per T. Cumming, Esq. . . .	4	17	1	Sons	2	4	2
Grangemouth, per E. Snell, Esq.	3	11	9	Waldensian, steamer, collected on			
Greenock, per Thos. Avery, Esq.	0	8	0	board, per Captain Le Gallais	0	17	0
Grimby, per J. Edwards, Esq.	2	9	6	Westport, per J. Marriand, Esq. . . .	0	12	5
Guernsey, per A. Richardson, Esq. . . .	5	5	1	Wigtown, per R. Chalmers, Esq. . . .	0	10	6
Hankow, s.s., collected on board, per				Wisbeach, per R. J. Weaver, Esq. . . .	5	12	7
Capt. W. Symington	1	16	4	Woodbridge, per H. Fisher, Esq. . . .	1	1	0
Hull, per J. W. Day, Esq.	13	0	0	Worcester Cadet Life-boat Fund, per			
Hull, per B. Empson, Esq.	1	3	0	Capt. J. H. Smith (additional)	150	0	4

SPECIAL LIFE-BOAT CONTRIBUTIONS.

CIVIL SERVICE LIFE-BOAT FUND.

Patron—
His ROYAL HIGHNESS THE DUKE OF
EDINBURGH, K.G., K.T. &c.

Treasurer—
CHARLES G. TURNER, Esq.

Hon. Secretary—
CHARLES DIBDIN, Esq., F.R.G.S.

Annual Subscriptions of 2s. 6d. have
been promised in aid of the above
Fund by 3867 gentlemen in the follow-
ing Government Departments:—

Admiralty.....	231
Board of Trade.....	35
British Museum.....	25
Charity Commission.....	43
Chatham Dockyard.....	17
Civil Service Commission.....	29
Copyhold Commission.....	35
Court of Bankruptcy.....	56
Customs.....	215
Devonport Dockyard.....	27
Ecclesiastical Commission.....	46
Education Department.....	63
Exchequer and Audit Office.....	72
Foreign Office.....	48
Gazette Office.....	5
General Post Office.....	617
High Court of Justice.....	258
Home Office.....	49
House of Commons.....	36
House of Lords.....	31
India Office.....	119
Inland Revenue.....	376
Local Government Board.....	112
Miscellaneous Post Offices.....	20
National Debt Office.....	112
Nautical Almanac Office.....	36
Office of Commissioners in Lu- nacy.....	6
Office of Parliamentary Counsel.....	1
Office of Woods and Forests.....	52
Office of Works.....	48
Paymaster-General's Office.....	40
Portsmouth Dockyard.....	23
Public Record Office.....	29
Public Works Loan Office.....	17
Queen Anne's Bounty.....	16
Record Office of Seamen.....	36
Registrar-General's Office.....	70
Registry of Friendly Societies.....	11
Royal Chelsea Hospital.....	10
Royal Clarence Yard, Gosport.....	9
Royal Mint.....	90
Royal Victoria Yard, Deptford.....	11
Science and Art Department.....	34
Stationery Office.....	30
Treasury.....	29
War Office.....	113
Miscellaneous.....	6

SCOTLAND.

Auditor of the Court of Session Office.....	1
Bankruptcy, Office of Accountant Board of Lunacy.....	6
Board of Super-vision.....	11
Chancery Office.....	3
Court of Session.....	9
Crown Office.....	6
Customs, Greenock.....	6
Exchequer.....	8
Fishery Board.....	10
General Post Office.....	3
Miscellaneous Post Offices.....	67
General Registry Office.....	62
Horning Office.....	5
Inland Revenue.....	1
Justiciary Office.....	62
Lord Clerk Register's Office.....	5

Northern Lighthouse Board.....	4
Offices of Works.....	1
Prison and Judicial Statistics.....	15
Sasine Office.....	40
Science and Art Department.....	2
IRELAND.	
Customs.....	11
General Post Office.....	118
General Survey and Valuation Office.....	43
Miscellaneous Post Offices.....	32
Office of National Education.....	43
Total.....	3,867

CLEVEDON LIFE-BOAT FUND.

Honorary Secretary—
Mrs. E. LAVINGTON, Belgrave House,
Clevedon, Somerset.

Donations.	
Proceeds of Soirée Musicale (Dec. 1872).....	25 0 0
Ditto do. do. (1874).....	26 17 0
Ditto do. do. (1875).....	26 6 0
Collected by Mrs. Lavington's Pupils during the half-year ending June 1875.....	20 18 7
Ditto half-year ending June 1876.....	10 4 9
Collected by Miss Wrigley, Holbeck, Windermere, dur- ing the half-year ending June 1876.....	15 15 0
Sale of Work and Christmas Tree, December 1876.....	27 4 0
Sale of Pupils' Work 1878.....	35 4 2
Penruddocke, Miss, Fyfield, Wilts, contributions from the sale of work (1875-9).....	4 7 3
Ditto, 1880.....	- 11 0
Harrison, Miss, French coins - 3 2	
Collected by Miss Ettie Lovi- bond, Bridgwater.....	4 0 0
Contents of Life-boat Box, and collections during the year 1877.....	6 11 6
Contents of Life-boat Box to Christmas 1878.....	2 2 6
Sale of Pupils' Work, 1879.....	46 4 2
Sale of Clevedon Wild Flowers.....	16 16 6
Total.....	£271 5 7

THE "COVENT GARDEN"
LIFE-BOAT FUND.

Amounts handed to the NATIONAL
LIFE-BOAT INSTITUTION by the Stew-
ards of this Fund, being the Contri-
bution for the year 1879, in aid of the
support of the Covent Garden Life-
boat, now stationed at Caister, near
Great Yarmouth.

Austin, A. Esq.....	£. s. d.
Brown, F. C. Esq.....	3 3 0
Comberlege, Rev. S. F. M.A.....	10 6 0
Hill, C. J. Esq.....	1 1 0
Lloyd, E. Esq.....	1 1 0
Norman, W. Esq.....	5 5 0
Parker, H. Esq.....	1 1 0
Patey, Mme.....	1 1 0
Ransome, Bouverie & Co.....	5 5 0
Messrs.....	10 10 0
Robinson, W. Esq.....	10 0 0
Sawyer, —, Esq.....	1 1 0
Willis, —, Esq.....	12 6 0
Tebbutt, G. Esq.....	10 0 0

Collections.

Barringer, W. Esq.....	£. s. d.
Buck, H. R. Esq.....	1 15 0
Dickson, T. A. Esq.....	10 0 0
Smith, A. Esq.....	1 8 0
Webber, J. Esq.....	15 0 0
Part Proceeds of Entertain- ment.....	1 2 6
	12 19 6
	£50 0 0

THE "FORESTER" AND
"FORESTERS' PRIDE"
LIFE-BOATS FUND.

List of Voluntary Contributions re-
ceived for the Fund from the following
DISTRICTS, COURTS, &c., of the ANCIENT
ORDER OF FORESTERS, from JANUARY
31, 1879, to JANUARY 31, 1880, per SA-
MUEL SHAWCROSS, Esq., P.S.

Amount previously pub- lished in Foresters' Re- ports from 1863 to Jan. 31, 1879.....	£. s. d.
	2,933 2 3

DISTRICTS.

Ashby-de-la-Zouch.....	- 10 0
Ashton-under-Lyne.....	1 0 0
Beverley.....	1 0 0
Bridport.....	- 10 0
Brighton.....	3 16 2
Bucks, &c.....	2 9 2
Cape Town.....	2 15 0
Cirencester.....	- 19 0
Denny.....	1 0 0
Failsworth, &c.....	2 0 0
Flintshire.....	1 1 0
Hyde, &c.....	- 11 4
Leicester.....	1 10 6
Luton.....	1 0 0
Nottingham, P. C. R.....	- 5 0
Seaham Harbour.....	3 0 6
South London.....	4 8 4
South Western.....	2 10 3

COURTS.

70.....	1 4 0
124.....	- 10 6
128.....	- 15 0
159.....	- 5 0
681.....	- 14 9
757.....	- 9 10
851.....	- 5 0
854.....	- 10 0
888 and 1116.....	- 5 2
957.....	- 10 0
1007.....	- 6 3
1142.....	- 9 4
1169.....	- 12 6
1193.....	- 11 3
1442.....	- 5 0
1548.....	1 1 0
1556.....	1 1 0
1586.....	- 10 0
1618.....	- 17 0
1911.....	- 28 2
1952.....	- 10 0
2138.....	- 7 6
2140.....	- 10 0
2157.....	1 0 0
2239.....	- 5 0
2340.....	1 0 0
2349.....	- 10 0
2505.....	- 6 0
2634.....	6 12 1
2732.....	- 10 0
2879.....	1 1 0
2918.....	- 6 0
2932.....	- 10 0
2940.....	- 6 0
2950.....	- 6 5
2992.....	- 7 0

	£.	s.	d.
3044	9	7	
3083	13	7	
3102	6	0	
3111	5	0	
3336	1	2	5
3366	5	3	
3475	1	1	0
3177	7	6	
3529	2	2	6
3597	7	6	
3641	10	0	
3656	5	0	
3715	9	0	
3742	10	3	
3832	6	1	
3896	5	0	
3967	5	0	
4105	10	0	
4148	10	0	
4195	5	0	
4527	1	1	6
4565	5	6	
4566	19	1	
4640	5	0	
4987	9	6	
5106	12	0	
5154	12	0	
5205	5	0	
5180	10	0	
5481	5	0	
5501	9	0	
5581	10	4	
5621	5	4	
5626	13	6	
5694	9	0	
5807	5	0	
5836	1	9	6
5836	1	3	6
5956	6	9	
6020	8	1	
6021	6	0	
6046	5	8	
6113	5	6	
One Year's Dividend on New			
3 per Cents.	13	10	0
Sums under 5s.	7	1	5
Total	£3,038	0	7

THE JEWISH SCHOLARS' LIFE-BOAT FUND.

Honorary Secretary—
HERBERT BENTWICH, Esq., LL.B.
Contributions in aid of the maintenance of the *Michael Henry* Life-boat at Newhaven.

Annual Subscriptions.

	£.	s.	d.
A Friend	5	0	
Bentwitch, Herbert, Esq., LL.B.	1	1	0
Bentwitch, Mrs. M.	10	6	
Cohen, Miss Lucy	2	2	0
Favis, B. Esq.	1	0	0
Davis, Lionel M. Esq.	10	6	
Friedlander, Dr.	5	0	
Friends in Sheffield and London, per Lionel M. Davis, Esq.	2	0	0
Gollancz, Rev. H.	5	0	
Jacobs, A. M. Esq.	1	1	0
Jewell, Mrs. S.	10	0	
Joseph, Delissa, Esq.	1	1	0
Levy, Arthur, Esq.	10	6	
Levy, Maurice, Esq.	10	6	
Lindo, Mrs. Billah	5	0	
Meyer, T. Esq.	5	0	
Mocatta, F. D. Esq.	1	1	0
Myers, Asher J. Esq.	5	0	
Polack, J. Esq.	5	0	
Total	13	13	0

THE "MANCHESTER UNITY" LIFE-BOAT FUND.

Contribution from The INDEPENDENT ORDER of ODD FELLOWS (Manchester Unity) FRIENDLY SOCIETY, for the year 1879, per THOMAS COLLINS, Esq., Secretary.
£50 0 0

"MARK LANE" LIFE-BOAT FUND.

Hon. Sec.—H. KAINS-JACKSON, Esq.

Subscriptions at Christmas, 1879-80.

	£.	s.	d.
A. B.	1	0	0
Agerup, Petersen, & Co. Messrs.	5	0	0
Allen and Sons, Messrs. Alex.	10	0	0
Anderson and Boyd, Messrs. G. and A.	10	0	0
Ardley, Messrs. R. and J.	10	0	0
Aste, Son, and Kerchevall, Messrs.	1	1	0
Baucher, Mr. B. L.	10	0	0
Beane and Newton, Messrs.	10	6	
Begbie, Ross, and Gibson, Messrs.	10	0	0
Bellamy, Mr. W. C. B.	10	6	
Borrowman & Phillips, Messrs.	1	1	0
Bovill and Co., Messrs.	1	1	0
Bovill and Sons, Messrs. Benj.	10	0	0
Bowyer, Messrs. S. and H.	10	0	0
Carter, Mr. J. J.	10	0	0
Child, Messrs.	10	0	0
Church, Mr.	10	0	0
Claudius and Chattaway, Messrs. C. F.	10	6	
Clippingdale, Mr. S. D.	10	6	
Cole, Mr. R.	10	6	
Colman, Messrs. J. and J.	10	6	
Corder, Mr. F. J.	10	6	
Coventry and Sheppard, Messrs.	10	0	0
Cowan, Mr.	10	0	0
Dell, Mr. J. H.	1	0	0
Dell and Sons, Messrs. R.	10	0	0
Denny, Messrs. C. and J.	10	0	0
Dewar and Webb, Messrs.	1	1	0
Do, Mr. G.	1	0	0
Doo Brothers, Messrs.	7	6	
Dunham's List	10	0	0
Dunham, Wm. ("The Miller")	10	0	0
Easton, Messrs. T. and W.	10	0	0
Edwards Brothers, Messrs.	10	6	
Gade and Co., Messrs.	10	0	0
Girdwood and Co., Messrs.	10	6	
Gregory and Co., Messrs.	10	6	
Grimesdale and Sons, Messrs.	10	0	0
Gripper and Son, Messrs.	10	6	
Hall and Sons, Messrs.	10	0	0
Harris Brothers, Messrs.	1	1	0
Harvey, Mr. J.	10	0	0
Henry and Barker, Messrs.	10	0	0
Hewitson R. and J., Messrs.	10	0	0
Hopkinson, Mr. C.	5	0	0
James and Sons, Messrs.	10	0	0
Johnson and Son, Messrs.	10	0	0
Jones and Sons, Messrs. R. P.	10	0	0
Judkins, Connorton, and Son, Messrs.	10	0	0
Kains-Jackson, Mr. H.	10	6	
Kelly, Mrs.	10	0	0
Klein, Mr. Wm.	10	0	0
Ledger, Mr. E. W.	10	0	0
Leinders and Co., Messrs. F.	1	1	0
MacInnes, Mr. M.	1	1	0
Maidlow and Sons, Messrs.	10	6	
Marshall, Mr. J.	10	6	
Meeson, Mr. W. M.	10	0	0
Mongredien, Ellerby, and Co., Messrs.	10	0	0
Muggeridge, Mr. T. B.	10	0	0
Muggeridge and Co., Messrs. Wm.	10	0	0
Mumford, Messrs. S. P. & C.	4	6	

	£.	s.	d.
Nixon, Gower, and Co., Messrs.	10	0	0
Patent Granary Company	1	1	0
Peck, Freen, and Co., Messrs.	10	0	0
Rathbone, Edward, and Son, Messrs.	10	6	
Roberts and Co., Messrs.	10	6	
Robins, Mr. H.	10	6	
Robinson, Mr.	10	6	
Roffey and Son, Messrs.	1	1	0
Rumford, Messrs. L. M. and C.	10	0	0
Schacht, Mr. T.	10	0	0
Sibbald and Evans, Messrs.	1	1	0
Skelton, Mr. T. W., col. by	18	1	0
Ditto names, distributed (£10 ls.)			
Smith, Mr. Walter	10	6	
Spartali and Co., Messrs.	1	1	0
Stokes, Mr. R.	10	0	0
Stuckenschmidt, Mr.	1	1	0
Taylor, Mr. Seth	10	0	0
Tyser and Pechey, Messrs.	5	0	0
Usborne and Son, Messrs.	10	6	
Vokins, Mr. W.	10	6	
Watney and Keene, Messrs.	10	6	
Watson, Medill & Co. Messrs.	1	1	0
Webster Brothers, Messrs.	10	6	
Woodley and Co., Messrs.	10	0	0
Wright, Mr. T. W.	1	1	0
Sums under 5s.	5	6	
Total	£69	19	6

THE "OLIVER GOLDSMITH" LIFE-BOAT FUND.

Treasurer—
Lieut.-Gen. A. T. TULLOH, R.A., C.B.
Honorary Secretary—
Miss ADA GOLDSMITH TULLOH,
West Malvern.

A Friend at West Malvern	1	0	0
Adey, Gen. Sir John, K.C.B.	1	0	0
Aldrich, H., Esq.	1	1	0
Allsopp, Henry, Esq.	10	0	0
Allsopp, S. Charles, Esq.	2	0	0
Alston, F. B., Esq.	1	0	0
Alston, Mrs. Sydney, collected by	2	11	0
Andrews, C. Esq.	1	1	0
"Anonymous"	2	0	0
"Anonymous"	10	0	0
Archer, Mr. Edward	10	0	0
Armstrong, Sir William, C.B., F.R.S.	3	0	0
Armstrong, Lady	2	0	0
Askwith, Maj.-General, R.A.	1	0	0
Austin, Alfred, Esq.	1	1	0
Aylmer, Maj.-General, R.A.	1	0	0
Ball, Major Francis	1	0	0
Banbury, Fred, Esq.	3	3	0
Banbury, William, Esq.	1	1	0
Barker, D. Esq.	1	1	0
Barrows, J. Hill, Esq.	2	2	0
Bell, Mrs.	2	0	0
Bent, Rev. John	10	0	0
Bird, Admiral E. L.	1	0	0
Bloomfield, Rt. Hon. Lord, G.C.B.	1	0	0
Bloomfield, Lady	1	0	0
Bloomfield, General Sir John, G.C.B., R.A.	1	1	0
Bowman, Mrs.	1	0	0
Boxer, Maj.-Gen. R.A., F.R.S.	2	2	0
Boxer, Miss	10	6	
Brandreth, Admiral, R.N.	1	0	0
Brenner, Bruce, Esq.	1	0	0
Brenner, Miss, collected by	2	0	0
Brenner, Thomas, Esq.	10	0	0
Bright, Miss	10	0	0
Brine, Capt. Lindsay, R.N. and Officers of H.M.S. Lord Warden	1	10	0
Briscoe, Mrs.	2	0	0
Brooks, G. H., Esq.	1	1	0
Browning, Miss, collected by	1	5	0
Buckle, Captain C. M., R.N.	1	0	0
Burra, James S. Esq.	2	0	0

	£.	s.	d.		£.	s.	d.		£.	s.	d.
Burra, Mrs. J. S.	2	0	0	Gage, The Hon. Mrs.	1	0	0	O'Brien, Mrs. Henry Donatus	1	0	0
Burra, William Pomfret, Esq.	1	0	0	Gambier, Admiral	1	0	0	O'Grady, Major Honourable T.	1	0	0
Caffin, Vice-Admiral Sir J.	1	0	0	Gascogne, General Charles	1	0	0	Owen, Tom, Esq.	-	10	0
Crawford, K.C.B.	1	0	0	Geaves, G. Richard, Esq.	1	1	0	Panoramic Sketches	1	17	9
Cameron, Com. V. Lovett, C.B., R.N.	1	1	0	Giffard, Vice-Admiral Sir G., K.C.B.	-	10	0	Parry, Mrs.	-	10	0
Cator, Miss	2	0	0	Goldsmith, Staff-Comm. R.N., collected by	7	13	5	Paulet, Admiral Lord George	1	0	0
Chance, Edward, Esq.	1	1	0	Gordon, General Sir H. W., K.C.B.	2	2	0	Peacock, Miss	-	10	0
Chance, R. L., Esq.	2	2	0	Graham, Lt.-Gen. Hope, C.B.	1	0	0	Peel, Rev. F., M.A.	1	1	0
Cheese, John, Esq.	1	1	0	Guille, Mrs.	-	10	0	Perfect, Rev. Robert, M.A.	1	1	0
Christie, Alexander, Esq.	0	10	6	Guy, Gen. Sir Phillip, K.C.B. (the late)	2	0	0	Perrins, J. Dyson, Esq.	5	5	0
Clerk, Major-Gen. H., F.R.S., R.A.	2	0	0	Hall, Miss	1	0	0	Proceeds of Concerts given at School of Gunnery, Shoeburyness	8	8	0
Ditto (second donation)	3	0	0	Hallowes, Admiral	1	1	0	Provost, Trinity Coll. Dublin	1	0	0
Codd, Admiral E., R.N.	1	1	0	Harris, J. D., Esq.	1	0	0	Raglan, Lord	1	1	0
Cockburn, General, R.A., collected by	1	8	0	Hartland, A. H., Esq.	1	1	0	Rendel, George, Esq.	3	3	0
Cockburn, Lt.-Col. C. F., R.A.	-	10	0	Hartland, Mrs.	1	1	0	Renny, General	1	0	0
Conacher, A. Esq.	-	10	0	Hatchett, John, Esq., Jun.	1	1	0	Rideout, Major, R.H.A.	2	2	0
Cooper, W. T. Esq.	1	0	0	Hay, Admiral J. B. L.	-	10	0	Rigden, Mrs.	-	10	0
Corbett, John, Esq., M.P.	1	1	0	Hayes, Admiral John, C.B.	1	1	0	Robinson, Rev. John	1	1	0
Cork, the Right Rev. the Lord Bishop of	2	2	0	Hays, E. R. C. Esq.	1	1	0	Rowan, Maj.-Gen., C.B., R.A.	1	0	0
Coxwell, C. Roger, Esq.	1	1	0	Heneage, Capt., R.N.	1	0	0	Sabine, General Sir Edward, K.C.B.	-	10	0
Cradock, Rev. E. H., D.D.	3	3	0	Henry, Colonel C., C.B., R.H.A.	1	1	0	St. George, Lt.-Gen. Sir John, K.C.B., R.A.	2	0	0
Crawford, General Copland, R.A.	1	1	0	Henry, Honourable Mrs.	1	1	0	St. George, Lady	1	0	0
Crozier, Admiral	-	10	0	Hopton, Mrs. James	-	10	0	Salt, Lady	1	1	0
Crozier, Mrs.	-	10	0	Hopton, The Misses	2	0	0	Selwyn, Admiral and Mrs.	1	0	0
D'Aguiar, Lt.-Gen. Sir Chas., K.C.B., R.A.	1	1	0	Hudson, G. H. Esq.	1	0	0	Serjeantson, Mrs.	-	10	0
Dalton, Lieut.-Gen. R.A.	1	1	0	Hudson, General S.	1	1	0	Shelton, Captain	-	10	0
Davidson, Captain, R.N.	1	0	0	Hudson, Miss	1	0	0	Shibley, Capt.-General, C.B.	1	0	0
Dawson, W. H. Esq.	0	10	6	Hudson, Miss Tilt	1	0	0	Smith, Col. Phillip, Gren. Grds.	-	10	0
Deane, Mrs.	1	1	0	Hutson, Mrs., Woolwich	1	1	0	Smith, Miss	1	0	0
Deane, Nav.-Lt. Berkeley, R.N.	1	1	0	Hutson, Com. R.N.	1	1	0	Smith, Rev. Henry	1	0	0
Dennis, John, Esq.	1	1	0	Hutchinson, Gen. W. N.	1	1	0	Soame, The Misses	1	0	0
Dennis, Mrs., collected by	3	10	0	Hutchinson, Com. R.N.	0	10	0	Solly, N. Neal, Esq.	1	0	0
Dennis, William, Esq.	1	1	0	Ditto, collected by	0	10	0	Spencer, Col. Hon. R., R.A.	1	0	0
Dennis, William, Esq., Jun.	5	0	0	Hutchinson, Miss	1	1	0	Spurling, Rev. Walter, M.A.	1	0	0
Devas, Mrs.	1	0	0	Hyde, Miss	1	0	0	Strickland, Mrs.	-	10	0
Dorville, Admiral	1	1	0	Inglis, Colonel, R.E.	1	0	0	Styan, Miss	-	10	0
Douglas, Gen. Sir Percy, Bart.	1	0	0	"Interested"	-	10	0	Suckling, Captain, R.N.	5	0	0
Doyle, General Sir Hastings, K.C.M.G.	1	0	0	Janasz, D. L. Esq.	1	1	0	Sydney, Rt. Hon. Earl, G.C.B.	1	0	0
Douglas, Mrs.	1	0	0	Jones, Admiral Sir L. Tobias, G.C.B.	1	1	0	Symington, Captain	1	1	0
Dunn, Mrs.	1	0	0	Jones, General H. R., C.B.	1	0	0	Ditto, collected by	-	10	0
Dunn, Mrs., collected by	2	10	0	Jones, Miss Jane	-	10	0	Talbot, Admiral John, R.N.	-	10	0
Dunsany, Vice-Admiral Lord.	2	0	0	Keane, Capt. the Hon. John	-	10	0	Talbot, Major F. S., R.H.A.	1	1	0
Duntze, Admiral	1	0	0	Lake, Col. Sir Atwell, K.C.B.	1	0	0	Taylor, Colonel Right Hon. T. E., M.P.	2	0	0
Dyer, Colonel, R.A.	1	0	0	Larcom, Gen. Rt. Hon. Sir Thos.	1	0	0	Teesdale, Col. C., C.B., V.C., R.A.	1	1	0
Dyer, Sir Thomas, Bart. (the late)	5	0	0	Layton, Admiral	2	2	0	Tebbit, Henry, Esq.	1	1	0
Edenborough, Mrs.	10	0	0	Lea, Mrs. Charles	2	2	0	Thomas, Colonel H. T., R.A.	1	0	0
Elliot, Admiral the Hon. Chas., C.B.	-	10	0	Lechmere, Sir E. A. H., Bt., M.P.	2	2	0	Thomson, Captain Frank, R.N.	1	0	0
England, General Sir Richard, G.C.B.	1	1	0	Leslie, Mrs.	1	0	0	Thompson, Colonel	2	2	0
Faber, Rev. Arthur, M.A.	1	1	0	Listowel, Right Hon. Earl of Little, General Sir Archibald, K.C.B.	1	0	0	Thompson, Major J. L.	2	0	0
Fanshawe, Admiral, C.B., and Officers Royal Naval College, Greenwich	4	10	0	Lowe, Admiral Arthur	1	0	0	Tolloh, Lt.-Gen. A. T., C.B., R.A.	10	0	0
Farquhar, Sir Walter, Bart.	1	0	0	McClintock, Rear-Admiral Sir Leopold, Kt., F.R.S.	-	10	6	Tulloch, Gen. J. S., C.B., R.A.	1	0	0
Farrell, Major, R.A.	-	10	0	McDowall, Rev. Charles, M.A.	2	0	0	Vaughan, Rev. C. J., D.D.	1	1	0
Ferguson, Rev. R.	1	1	0	Malcolm, General George	-	10	0	Verschoyle, Mrs. Hamilton, Sen.	1	0	0
Field, Col. R.A.	1	1	0	Markham, Captain A. H., R.N.	1	1	0	Verschoyle, Rev. H.	1	0	0
Fitzmayer, General Sir J., K.C.B., R.A.	1	0	0	Marrlott, Maj.-General, R.A.	1	1	0	Walker, John, Esq.	-	10	0
Fitzmayer, Lady	1	0	0	Martin, Admiral Sir W. F., Bart., G.C.B.	1	0	0	Warleigh, Lieut. G. A., R.N.	-	10	0
Flood, Solly, Esq.	1	0	0	Mason, Mrs. Oliver	1	0	0	Weir, Dr.	1	1	0
Foley, Rt. Hon. Lady Emily	2	0	0	Matthews, M. Esq.	1	1	0	Welsh, Richard, Esq.	-	10	0
Forbes, Mrs. T. G.	-	10	6	Matthews, Mrs.	5	0	0	Wengierski, Countess	1	0	0
Foster, Mrs. C.	-	10	0	Ditto (second donation)	2	0	0	Whinyates, General F., R.A.	2	0	0
Foster, Mrs. John	1	0	0	Maude, Captain the Hon. F.	-	10	0	Wilmot, Lieut.-General	1	1	0
Fowle, Rev. W., M.A.	-	10	0	Maude, Colonel G., R.A., C.B.	-	10	0	Williams, General Sir F., Bart., G.C.B.	5	0	0
Franklyn, Major-Gen., R.A.	1	0	0	Middleton, Admiral Sir G. Broke, Bart.	5	0	0	Wilson, Mrs.	1	1	0
Freeman, Rev. C. E., M.A.	-	10	0	Milne, Admiral Sir Alexander, Bart., G.C.B.	2	0	0	Wood, General Sir David	1	0	0
Ditto (second donation)	1	0	0	Milner, Captain F., R.A.	-	10	0	Wood, General Sir David, G.C.B.	1	1	0
Freeth, Mrs.	1	1	0	Mount Edgcombe, Lady Victoria	-	10	0	Woolcombe, Captain, R.N.	-	10	0
Frome, General, M., R.E.	-	10	6	Munn, Mrs.	-	10	0	Sums under 10s.	10	4	6
Fry, Augustine B., Esq.	1	0	0	Munn, Mrs. Henry	1	1	0	Bank Interest	2	0	0
Fyers, General W. A., C.B.	1	0	0	Newton, Colonel, R.A.	-	10	0				
Gage, Gen. Hon. E., R.A.	1	0	0	Noble, Captain, R.A., F.R.S.	2	2	0				

Total£360 14 2

BRANCHES OF THE ROYAL NATIONAL LIFE-BOAT INSTITUTION,

WITH NAMES OF THE CONTRIBUTORS.

Amounts acknowledged in these Lists are those chiefly received between 1st April, 1879, and 1st April, 1880.

Donations contributed locally for the erection of Boathouses are omitted after having been once published.

		INDEX.			
	PAGE		PAGE		PAGE
ABERDOVEY	121	FISHGUARD	125	PADSTOW	102
ABERYSTWYTH	99	FLAMBOROUGH	134	PALLING	123
ACOCK'S GREEN AND YARDLEY	133	FLEETWOOD	116	PRELES	148
ALDBOROUGH AND THORPE	128	FOWEY	101	PENARTH	112
ALDERNEY	156	FRASERBURGH	139	PENZANCE AND SENNEN COVE	102
ALLOA	141	GRYVAN	140	PETERHEAD	139
ALNMOUTH	123	GLASGOW	146	PIEL	119
ANGLSEY	98	GOODWIN SANDS AND DOWNS	114	POOLE	109
ANSTRUTHER	144	GORLESTON	128	PORTHCAWL	112
ARBROATH	145	GOURDON	146	PORTHDELLAEN AND ABERSOCH	100
ARDMORE	154	GURENOCK	148	PORTHLEVEN	103
ARROSSAN	139	GREYSTONES	155	PORRHOUSTOCK	103
ARKLOW	155	GUERNSEY	156	PORT ISAAC	103
ARY	140	HARTLEPOOL	110	PORTLOE	103
BACTON	121	HARWICH	111	PORT LOGAN AND BAY OF LUCE	150
BALLANTRAE	140	HARBOROUGH	122	PORTMADOC	100
BALLYCOTTON	151	HASTINGS AND ST. LEONARDS	131	PORT OF PLYMOUTH	107
BALLYWALTER	151	HAUXLEY	124	PORT OF ROCHESTER	115
BANFF AND MACDUFF	140	HAYLE	101	PORT OF RUNCORN	106
BANNOCKBURN	149	HENLEY-ON-THAMES	125	PORT PATRICK	150
BARNOUTH	121	HOLYHEAD	98	PORTRUSH	151
BARNSTAPLE AND BRAUNTON	104	HOLY ISLAND	124	PORTSMOUTH AND HAYLING ISLAND	113
BATH	126	HORNSEA	134	RAMSEY	156
BELFAST AND GROOMSPORT	150	HUDDERSFIELD	135	READING	98
BELPER	104	HULL	135	RHYL	111
BEMBRIDGE	113	HUNA	141	ROCHDALE	119
BERWICK	123	HUNSTANTON	122	ROGERSTOWN	153
BIDEFORD AND APPLEDORE	105	HYTHE	114	RUNSWICK	136
BIRMINGHAM	132	ILFRACOMBE AND MORTE	106	RYE AND WINCHELSEA	132
BLACKBURN	115	IPSWICH	128	SALCOMBE AND HOPE COVE	167
BLACKPOOL	115	IRVINE	140	SCARBOROUGH	186
BLAKENY	121	ISLE OF ARRAN	141	SCILLY ISLANDS	103
BLYTH	124	ISLE OF PURBECK	109	SEAHAM	110
BOLTON	116	ISLE OF WHITHORN	150	SEATON CAREW	110
BOSTON	120	ISLE OF WIGHT	113	SETTLE	137
BOULMER	124	KEIGHLEY	135	SHEFFIELD	137
BRADFORD	133	KELSO	149	SHERINGHAM	123
BRANCASTER	122	KINGSGATE	114	SHREHAM	132
BRIDGWATER AND BURNHAM	126	KING'S LYNN	122	SIDMOUTH	107
BRIDLINGTON	134	KINGSTOWN	152	SKERRIES AND BALBRIGGAN	153
BRIDPORT	109	KIRKCUDBRIGHT	146	SOUTHEND	111
BRIGHTON	129	KIRKLISTON	148	SOUTHPORT	119
BRISTOL	112	LANGCASTER	116	SOUTHWOLD	129
BROADSTAIRS	113	LEEDS	136	STAFFORDSHIRE POTTERIES	127
BUCKIE	140	LEEK	127	ST. ANDREW'S	145
BUDE	100	LEICESTER	119	ST. DAVID'S AND SOLVA	126
BURTON-ON-TRENT	127	LIMERICK	153	ST. IVES (CORNWALL)	103
CADGWTH	101	LINCOLNSHIRE SHIPWRECK ASSO- CIATION	120	STAITHES	137
CAHORE	154	LIVERPOOL AND NEW BRIGHTON	116	STECHEFORD	133
CAMPBELLTOWN AND SOUTHEND	139	LIZARD (POLPEAR)	101	STIRLING	149
CARDIGAN	99	LLANDUDLAS	104	STONEHAVEN	146
CARLISLE AND SILLOTH	103	LLANDEUDNO	100	STROMNESS	148
CARMARTHEN BAY	99	LLANELLY AND PEMBREY	140	SUNDERLAND AND WHITBURN	110
CARNSORE	155	LONDONDERRY AND GREENCASTLE	153	SWANAGE	110
CASTLETOWN	156	LONGHOPE	148	SWANSEA	112
CHELTENHAM	112	LOOE	101	TEES BAY	138
CHESTER	100	LOSSIEMOUTH	144	TRIGNMOUTH	168
CHICHESTER HARBOUR & SELSEY	129	LOWESTOFT AND PAKFIELD	129	TENBY	126
CLACTON-ON-SEA	111	LYDD, DUNGENESS	114	THURSO	141
CLEETHORPES	121	LYME REGIS	109	TORBAY	108
CLOVELLY	105	LYNMOUTH	106	TORQUAY	108
CORK AND QUEENSTOWN	151	LYTHAM	118	TRALEE BAY	153
COURTMACSHERRY	151	MANCHESTER	118	TRAMORE	154
COURTOWN	155	MARGATE	114	TROON	140
CRESSWELL	124	MARTPORT	103	TRELLA	152
CROMER	122	MELROSE	149	VALENTIA	153
CRUDEN BAY	139	MEVAGISSFY	102	WAKFIELD	138
DALKEITH	142	MILFORD HAVEN	126	WATCHET	127
DARTMOUTH	105	MONFROSE	145	WELLS	123
DAWLISH	105	MORAY FIRTH	148	WESTERN CENTRAL	109
DERBY	104	MULLION	102	WEST HARVILEPOOL	111
DOUGLAS	156	MUNDESLY	122	WESTON-SUPER-MARE	127
DOVER	114	MUSSELBURGH	144	WEXFORD AND ROSSLARE	165
DROGHEDA	154	NEWARK	125	WEXMOUTH	110
DUBLIN	152	NEWBIGGIN	124	WHITBY AND UPGANG	128
DUNBAR	146	NEWBURGH	139	WHITEHAVEN AND SEASCALDE	104
DUNCANNON AND WATERFORD	155	NEWCASTLE (DUNDRUM)	152	WHITELINK BAY	139
DUNDALK	154	NEWCASTLE, TYNEMOUTH, ETC.	124	WICK AND ACKERGILL	141
DUNDEE	145	NEWHAVEN	132	WICKLOW	155
DUNFERMLINE	145	NEWQUAY AND ABERATRON	99	WINTERTON	123
DUNGARVAN	154	NEWQUAY (CORNWALL)	102	WITHERNSEA	138
DUNWICH	128	NEW ROMNEY AND DUNGENESS	115	WOLVENHAMPTON	128
EASTBOURNE	131	NEWTON ABBOT	106	WOBCESTER	133
EDINBURGH AND LEITH	142	NORFOLK	121	WORKINGTON	104
EXETER	106	NORTHAMPTON	123	WORTHING	132
EXMOUTH	106	NORTH BERWICK	146	YARMOUTH AND CAISTER	123
EYMOUTH	141	NORTH SUNDERLAND	125	YEALM RIVER	109
FALMOUTH	101	NOTTINGHAM	125	YORK	138
FILEY	134			YOUGHAL	151

SPECIAL LIFE-BOAT CONTRIBUTIONS.—CIVIL SERVICE, p. 94; CLEYDON, p. 94; COVENT GARDEN, p. 94; FORRESTERS', p. 94; JEWISH SCHOLARS', p. 95; MARK LANE, p. 95; ODD FELLOWS, p. 95; "OLIVER GOLDSMITH," p. 95.

ENGLAND AND WALES.

Anglesey.

ANGLESEY BRANCH.

Treasurer and Hon. Sec.—
WILLIAM PRESTON, Esq.

Annual Subscriptions.

	£.	s.	d.
Atkinson, John, Esq.	10	0	0
Bangor, Bishop of	2	0	0
Barber, H. Esq.	10	6	0
Beever, J. F. Esq.	1	1	0
Boston, The Right Hon. Lord	2	0	0
Davies, R. Esq. M.P.	2	2	0
Davies, Robert, Esq.	2	2	0
De Broke, Lady W.	5	0	0
Docker, F. W. Esq.	10	0	0
Duff, C. G. Esq.	10	0	0
Duff, Mrs.	1	0	0
Duncuft, J. Esq.	10	0	0
Edwards, Miss E. W.	1	0	0
Evans, T. F. Esq.	10	0	0
Eyton, T. Wynne, Esq.	1	1	0
Gartside, J. H. Esq.	1	1	0
Gartside, Mrs.	1	1	0
Griffith, H. T. D. Esq.	1	1	0
Griffith, Miss Conway	1	0	0
Griffith, W. G. Esq.	1	0	0
Hall, J. Esq.	1	1	0
Hampton, Miss	10	0	0
Herbert, Rev. E.	10	0	0
Higgins, G. Esq.	1	1	0
Hughes, General	10	0	0
Hughes, J. W. Esq.	10	6	0
Hughes, W. B. Esq. M.P.	1	1	0
Hughes, R. Jones, Esq.	1	0	0
Hussey, Horace, Esq.	1	0	0
J. W.	1	7	0
James, R. L., Lieut. R.N.A.V.	1	0	0
Jones, Archd. Wynne	10	0	0
Jones, R. Wynne, Esq.	10	0	0
Jones, T. Nicholls, Esq.	1	1	0
Lewis, Capt. Hampton	1	0	0
J. W.	1	0	0
Lewis, Miss	10	0	0
Lewis, Wm. P. Esq.	1	0	0
Lingham, F. H. Esq., per Rhosneigr Life-boat	1	1	0
Lingham, Mrs., per Rhosneigr Life-boat	1	1	0
Luck, Richard, Esq.	10	6	0
Mason, Rev. Wms.	10	0	0
Massey, Mrs.	10	0	0
Massey, W. Esq.	10	0	0
Meyrick, Sir George, Bart.	2	0	0
Millington, Jno. Esq.	10	0	0
Mitchell, H. B. Esq.	1	0	0
Mitchell, Mrs. H. B.	1	0	0
Morgan, Rev. B.	1	1	0
Neave, The Hon. Lady	10	0	0
Nunn, J. P. Esq., per Rhosneigr Life-boat	1	1	0
Ogle, Admiral	10	6	0
Owen, John, Esq.	1	0	0
Owen, Rev. H. D., D.D. Trevdraeth	1	1	0
Owen, Rev. H. D., M.A., Penrynnydd	1	1	0
Owen, E. Brisco, Esq.	1	0	0
Owen, R. E. Esq.	10	0	0
Owen, W. H. Esq.	2	2	0
Pacey, J. Esq.	1	1	0
Paynter, J. W. Esq.	10	0	0
Penrhyn, Lord	5	0	0
Platt, Robert, Esq.	2	0	0
Platt, J. H. Esq. Hon. Sec. Rhoscolyn	0	0	0

	£.	s.	d.
Platt, Mrs.	0	0	0
Poole, Henry R., Esq.	1	1	0
Preston, N. Francis, Esq. Swainston	10	0	0
Price, Mrs. Hugh	1	0	0
Price, J. B. Esq.	10	0	0
Prichard, Rev. H.	10	0	0
Prichard, Hen. Esq.	10	0	0
Rayner, Captain G. Pritchard	5	0	0
Roberts, Arthur, Esq.	1	0	0
Roberts, Mr. J., Brynhyfryd	10	0	0
Roberts, J. Esq., Tyddyn Mawr	10	6	0
Roberts, Mr. David, Rhyd	10	6	0
Roberts, Robert, Esq.	2	2	0
Roose, B. Esq.	10	0	0
Roscoe, Mrs.	1	1	0
Scofield, W. J. Esq., per Rhosneigr Life-boat	1	1	0
Slater, Mr. J.	10	0	0
Smith, Asherton, Esq.	2	0	0
Smith, Branston, Major	1	1	0
Souter, Miss, per Rhosneigr Life-boat	1	1	0
Souter, Miss F., per Rhosneigr Life-boat	1	1	0
Spargo, Nicholas, Esq.	10	0	0
Sparrow, J. Bodychan, Esq.	1	1	0
Spode, Josiah, Esq.	2	0	0
Staples, Mr. E.	10	0	0
Thomas, Mr. E. R.	10	0	0
Thomas, Lieut.-Col. Wm. Beamaris	10	6	0
Trevor, Rev. Warren	1	0	0
Trevor, Mrs.	10	6	0
Verney, Captain E., R.N.	1	0	0
Warner, Thos. Esq.	2	0	0
Weldon, W. H. Esq.	1	0	0
Whitehead, J. D., Esq.	5	5	0
Williams, Rev. Robt.	1	1	0
Williams, Rev. W. Wynne, Jun.	10	0	0
Williams, Miss, Tanygraig	1	0	0
Williams, Mrs., Tros-y-afon	1	1	0
Williams, Mrs. H. O.	10	0	0
Williams, W. Esq.	2	0	0
Williams, Rev. John	10	0	0
Williams, Rev. J. Evan	5	0	0
Wynne, Mrs. Henry	10	0	0
Sums under 5s.	4	0	0
Total	122	12	0

Donations and Collections, 1878-9.

	£.	s.	d.
Amount of burial fees by Rev. Robt. Williams, received for interment of five bodies of shipwrecked sailors in Llanfaeloch churchyard, March 1878.	1	13	4
Bealey, A. F. Esq.	1	0	0
Collected by Behrens, Miss Netty	1	15	0
Ditto per Miss Amy Wood, Kingstown, Ireland	1	0	0
Collected per Miss M. Wynne Jones, Trierwerth	15	2	0

	£.	s.	d.
Ditto per Miss Netty Behrens, Manchester	10	0	0
Ditto per Mr. D. Hughes, Jun.	1	12	6
Coll. in Box at Penmon Life-Boat Ho.	8	7	0
Ditto in ditto at Garth Ferry, per Mr. Thos. Morgan	17	6	0
Ditto at Rhosneigr, per Mr. J. W. Haws	2	5	2
Ditto boxes at Bulkley Arms Hotel, per Messrs. Baker	8	7	0
Llanfaes & Penmon churches, per Rev. T. W. Trevor	12	9	6
Coll. in Llanhadrig Church, after a sermon by Rev. J. Foster	2	8	0
Pritchard, Miss, Trecawen	1	0	0
Roberts, Miss, Maelog	1	0	0
Vivian, Lady, Special Fund for Moolfra Lifeboat	17	1	0
Total Dons	39	10	5
Total Subs.	122	12	0
Total	162	2	5

	£.	s.	d.
Weston, Mr. John	5	0	0
Williams, Mr. Hugh	10	0	0
Williams, Mr.	5	0	0
Total	30	11	6

Donations.

	£.	s.	d.
Coles, A. J. Esq.	10	10	0
Collecting Boxes	0	7	9
Liverpool Underwriters	26	0	0
McVeagh, Belfast	17	0	0
Proceeds of Concert, per Dr. Maguire and H. A. Iveit, Esq.	10	0	0
Thompson, Capt. of ship Great Admiral	25	0	0
Total Dons	88	17	9
Total Subs.	30	11	6
Total	119	9	3

Werkshire.

READING BRANCH.

Honorary Secretary—
C. STEPHENS, Esq.

Annual Subscriptions.

	£.	s.	d.
Andrews, C. J. Esq.	10	6	0
Austen, Capt. R.N.	1	1	0
Bailey, Mr. J. S.	1	1	0
Barnett, F. C. C. Esq.	1	1	0
Baile, Lansdowne, Esq.	1	1	0
Bernton, R. Esq.	3	3	0
Biggs, Mr. W.	10	6	0
Birch, Capt. R.N.	1	0	0
Blackwell, Messrs. E. and F.	10	6	0
Blagrade, J. H. Esq.	1	1	0
Blandy, F. J. Esq.	1	1	0
Blandy, H. B. Esq.	1	1	0
Blandy, W. F. Esq.	1	1	0
Blowers and Son, Messrs.	10	6	0
Bourne, J. Esq.	10	6	0
Brown, Mr. G. J.	1	0	0
Butler, Capt. A., R.N.	10	0	0
Butler, Mr. G. R.	10	0	0
Bracher and Sydenham, Messrs.	10	6	0
Bradley, Mr. R.	10	0	0
Cameron, Rev. A. A.	1	0	0
Cantrell, Mr. W. S.	10	0	0
Catchpool, Mr. R. D.	10	6	0
Cobham, Capt. A. W.	2	1	0
Cobham, A. C. Esq.	1	0	0
Cocks, Messrs. C. and Co.	10	6	0
Cocks, Mrs. C.	10	0	0
Collins, Chas. Esq.	10	6	0
Collins, Henry, Esq.	10	6	0
Cooper, Messrs. J. O. and Son	10	0	0
Cooper, Mr. Lewis	10	0	0
Cowslade, H. H. Esq.	1	1	0
Cowslade, W. W. Esq.	1	1	0
Crawshaw, Mrs.	5	0	0
Edge, Jno. Esq.	1	1	0

HOLYHEAD BRANCH.

President—
The Hon. W. O. STANLEY.

Chairman—
Rev. Chancellor BRISCO, D.D.

Treasurer and Hon. Sec.—
W. P. ELLIOTT, Esq.

Annual Subscriptions.

	£.	s.	d.
Barber, H. T. Esq.	10	6	0
Beaumont, Capt.	10	0	0
Briscoe, Rev. Chancellor, D.D.	10	0	0
Cay, Capt. R.N.	10	0	0
City of Dublin Steam Packet Co.	5	0	0
Davis, Richd., Esq. M.P.	1	1	0
Elliott, W. P. Esq.	10	6	0
Ellis, Mr. John	5	0	0
Griffith, Rev. Wm.	5	0	0
Griffith, J. Lloyd, Esq.	1	1	0
Haldane, Capt.	1	0	0
Hughes, Mr. John	5	0	0
Hughes, Mr. H. G.	5	0	0
Jones, Capt. J. E., R.M.S. Ulster	1	0	0
Jones, Mr. Jos.	5	0	0
Jones, R. E. Capt.	10	0	0
Kendall, Captain of R.M.S. Connaught	10	0	0
Lewis, Capt. Geo.	10	0	0
Lloyd, Morgan, Esq., Q.C. M.P.	1	1	0
London and North Western Railway Co.	10	0	0
Mackenzie, Admiral	1	0	0
Peters, Mr. John	5	0	0
Fritchard, J. M. Esq., N. P. Bank	1	1	0
Fritchard, Mr. R.	5	0	0
Fughe, W. J. Esq.	10	6	0
Stanley, Hon. W. O.	1	1	0

	£.	s.	d.
James, Rev. D. O.	5	0	0
Jennings, R. Esq.	1	1	0
Jones, C. W. Esq., Mayor of Carmarthen	10	6	
Jones, J. Esq.	1	1	0
Lester and Co., Messrs. T.	1	1	0
Morgan, Mr. W. J., "Welshman"	10	6	
Morgan, Mr. D. M.	5	0	
Morris, T. C. Esq.	1	1	0
Nevill, W. H. Esq.	1	1	0
Norton, Henry, Esq.	10	6	
Norton, Mrs. W.	1	1	0
Narnell, Robert, Esq.	2	0	
Peel, Mrs.	10	0	
Peel, R. W. Esq.	10	0	
Richards, R. W. Esq., Mayor	10	6	
Risley, J. B. Esq.	1	1	0
Scott, J. J. Esq.	10	0	
Sinnett, Rev. W. H.	10	0	
Spurrell, George, Esq.	10	0	
St. David's, The Bishop	2	2	0
Thomas, George, Esq.	10	0	
Thomas, Thos. Esq.	10	0	
Tregoning, J. S. Esq.	1	1	0
Vaughan, Mr. E.	5	0	
Warburton, Mrs.	1	0	
Wienholt, Fred. Esq.	1	1	0
Wilkins, Messrs., Bank	1	1	0
Williams, B. T. Esq., Q.C., M.P.	10	6	
Williams, Mrs. H.	1	1	0
Total	35	15	0

Donations.
Contribution Boxes. - 19 9
£36 14 9

LLANELLY AND PEMBREY BRANCH.

President—
GENERAL MALCOLM, C.B.
Vice-President—
CHARLES NEVILL, Esq.
Chairman—
Capt. LUCKRAFT, R.N.
Honorary Secretary—
GERARD ELKINGTON, Esq.
Annual Subscriptions.
Ashburnham, Right Hon. the Earl of . . . 5 0 0
Bevan, Mr. Samuel . . . 10 6
Ball, Capt. P. 5 0
Broom, Mr. C. N. . . . 10 6
Buckley, Dr. 10 6
Buckley, Mr. James J. 1 0
Burry Port and Gwent-dreath Valley Co. . . 2 2 0
Burgman, Mr. Chas. . . 10 6
Bythway, Mr. W. . . . 10 6
Caysh, Mr. Joseph . . . 5 0
Elkington, Mr. G. B. . . 1 1 0
Elkington, Mr. H. . . . 1 1 0
Elkington, Mr. J. B. . . 1 1 0
Evans, Mr. Evan 7 6
Gausson, Mr. C. W. . . 1 0 0
Hand, Mr. J. Kenneth I 1 0
Jenkins, Mr. John . . . 1 1 0
Jones 1 1 0
Johnson, Mr. Thos. . . 10 6
Jones, Mr. B. 10 0
Jones, Capt. T. 5 0
Lewis, Mr. C. W. . . . 2 0 0
Mansel 2 0 0
Llanelly Harbour Commissioners . . . 5 0 0
Lloyd, Mr. E. H. . . . 5 0 0
Luckraft, Capt. J. P., R.N. 10 0

	£.	s.	d.
Maclaran, Mr. Rowland	1	1	0
Malcolm, General, C.B.	2	2	0
Margrave, Mr. Robt.	10	6	
Mason & Elkington, Messrs.	2	2	0
Mitchell, Mr. J.	5	0	
Nevill, Druce & Co., Messrs.	3	0	0
Pemberton, Mr. H. W.	2	2	0
Phillips, Mr. Edward	1	1	0
Randell, Mr. John	5	0	
Rees, Mr. David	10	6	
Rees, Mr. Mansel	1	1	0
Risley, Mr. J. B.	1	1	0
Rogers, Mr. W.	1	0	0
Rogers, Mr. John H.	10	6	
Samuel, Capt. Simon	10	0	
Samuel, Mr. W.	10	6	
Stepney, Sir A. K.	3	0	0
Cowell 3 0 0			
Thomas, Mr. Henry	1	1	0
Thomas, Mr. R. Goring	1	1	0
Thomas, Mr. Wm.	1	1	0
Tregoning, Mr. J. S.	1	1	0
Turnock, Mr. J. Rushton	5	5	0
Waddle, Mr. J. R.	10	6	
Wise, Mr. A. J. P.	1	1	0
Total	58	16	0

Carmarvonshire.

ORME'S HEAD (LLAUDNOD) BRANCH.

Chairman—
Rev. J. MORGAN, Llandudno.
Treasurer—
J. ADEY WELLS, Esq. N.P. Bank, Llandudno.
Honorary Secretary—
G. F. FELTON, Esq.
Annual Subscriptions.
Allen, F. Esq. 1 1 0
Allen, R. F. Esq. 1 1 0
Carden, Capt. 1 1 0
Elgie, Miss 10 0
Greene, R. Esq. 10 6
Hagerdine, H. Esq., J.P. 1 1 0
Morgan, Rev. J. 10 6
Stanistreet, W. Esq. 10 6
Watter, Mrs. 10 0
Williams, Dr. Bold 10 0
Wolferstan, Miss 10 6
Woodward, W. Esq. . . . 2 2 0
Total 9 18 6

Donations.
A. Evans, Esq., District Bank 10 6
Collecting Boxes—
Adolph Hotel 8 2
J. A. Cheesman (Pier Master) 19 7
R. Hughes 5 0
Capt. Lester 9 0
Queen's Hotel 6 6
Stuns under ss 1 0 6
Pillar at Boat House 1 2 0
Pillar on Parade 17 15 7
Total Dons . . . 22 16 10
Total Subs. . . . 9 18 0
£32 14 10

PORTHDINLLAEN AND ABERSOCH BRANCH.

Honorary Secretary—
Rev. O. LLOYD WILLIAMS.
PORTHDINLLAEN BRANCH.

Annual Subscriptions.
Asheton-Smith, G. W. D. Esq. 2 0 0
Finch, Col. Wynne 3 0 0
Hughes, W. Bulkeley, Esq. M.P. 2 0 0
Lloyd-Edwards, F. W. Esq. 5 0 0
Parry, Love Jones, Esq. 5 0 0
Pwllheil and Nefyn Mutual Marine Insurance Society (1 year) 1 12 6
Total 18 12 6

Donations.
Moore, Mrs. George 5 0 0
Powell, E. G. Esq. 1 0 0
Wilkinson, Rev. W. F. . . . 10 0
Concert at Nefyn 9 18 3
£35 0 9

ABERSOCH BRANCH.

Annual Subscriptions.
Asheton-Smith, G. W. D. Esq. 3 0 0
Evans, O. Esq. 2 2 0
Nanney, H. J. Ellis, Esq. 1 0 0
Pearson, G. Esq. 2 2 0
Port Madoc Mutual Marine Insurance 5 0 0
13 4 0

Donations.
Cotton, W. G. Esq. 1 1 0
Powell, E. G. Esq. 1 0 0
Concert at Pwllheil 12 13 3
Total £27 18 3

PORTMADOC BRANCH.

Chairman—
Major E. W. MATHEW.
Honorary Secretary—
D. HOMFRAY, Esq.
Annual Subscriptions.
Breese, Edwd. Esq. 5 0 0
Do. for Tremadoc Estate 1 1 0
Cwmorthin Slate Co. 1 1 0
Dunlop, A. M. Esq. 10 6
Ellis-Nanney, H. J. Esq. 1 0 0
Evans, Owen, Esq. 1 1 0
Greaves & Sons, John W. 1 0 0
Griffith, O. Esq. 10 6
Hartech, The Rt. Hon. Lord 1 1 0
Holland, S. Esq. M.P. . . . 1 0 0
Homfray, D. Esq. 10 0
Jones, J. H. Esq. 5 0 0
Jones, William, Esq. . . . 1 0 0
Lloyd, Mr. W. 2 6
Minshull, Mrs. F. 1 0 0
Mutual Insurance Society 10 0 0
Oakley, W. E. Esq. 5 0 0
Owen, Capt. G. H. 1 0 0
Percival, F. S. Esq. 1 0 0
Priestley, Miss 1 0 0
Spooner, C. E. Esq. 10 6
Welsh Slate Co. 1 0 0
Total £30 18 0

Donation.

Mathew, Major 2 0 0
£32 18 0

Cheshire.

CHESTER BRANCH.

Hon. Secretary—
THOMAS H. DIXON, Esq.
Annual Subscriptions.
Brassey, J. E. Esq. 10 6
Garnett, W. 1 1 0
Dixon, Mrs. A. M. 1 1 0
Dixon, T. H. Esq. 3 3 0
Fleming, Dr., the late 1 1 0
Garnett, W. 10 6
Massie, Admiral 1 0 0
Parry, C. T. W. Esq. 1 1 0
Potts, Esq. 3 3 0
Tilston, Miss 1 1 0
Townshend, C. Esq. 1 1 0
Walker, Parker, and Co. Messrs. J. 2 2 0
Wood, Albert, Esq. 1 1 0
Total £17 16 0

PORT OF RUNCORN BRANCH.

Honorary Secretary—
Annual Subscriptions.
Anderson, Capt. "Four Brothers" . . . 10 6
Brundrit, John, Esq. . . . 1 1 0
Clark, Capt. 1 1 0
Finlay, E. Esq. 10 6
Hayes, Wm. Esq. 1 1 0
Hazlehurst & Sons, Messrs. 1 1 0
Higson, J. Esq. 1 1 0
Price, J. Esq. 10 6
Simpson, Davies, & Sons, Messrs. 1 1 0
Speakman, Philip, Esq. (2 years) 1 1 0
Stock, Samuel, Esq. 1 1 0
Contribution Box at Custom House . . . 2 2 2
Total £12 1 8

Cornwall.

BUDE BRANCH.

President—
SIR T. DYKE AGLAND, BART., M.P.
Treasurer—
Rev. E. HIGHROY.
Honorary Secretary—
WILLIAM ROWE, Esq.
Annual Subscriptions.
Acland, Sir T. D. Bart., M.P. 5 0 0
Carnsew, Rev. T. S. 10 0
Carnsew, Mrs. 5 0
Chaucer, E. Esq. 1 0 0
Davey, Oliver, Esq. 5 0 0

BRANCHES—LIST OF ANNUAL SUBSCRIPTIONS AND DONATIONS. 101

Highton, Rev. E.	£.	s.	d.
Hockin, John, Esq. . .	1	0	0
Hockin, Mrs. Frank . .	5	0	0
King, J. Esq.	5	0	0
Thynne, Rev. Lord			
John	5	0	0
Sums under 5s.	2	6	
Total	£13	17	6

CADGWITH BRANCH.

President—
Captain SYMONS, R.N.
Chairman—
Mr. Cox, Cadgwith.
Honorary Secretary—
Rev. F. C. JACKSON.
Annual Subscriptions.
Davis, Thomas, Esq. 1 1 0
Rogers, Henry, Esq. . - 10 6
Total £11 6

FALMOUTH BRANCH.

President—
R. R. BROAD, Esq., J.P.
Chairman and Treasurer—
THOMAS WEBBER, Esq., J.P.
Honorary Secretary—
CHARLES CLIFT, Esq.
Annual Subscriptions.
Basset, G. L. Esq. 3 0 0
Broad and Sons,
Messrs. 1 1 0
Bull, Col. M. - 10 0
Carne, Messrs. W. and
E. C. 1 1 0
Carter, Mr. R. - 5 0
Chard, Mr. A. - 5 0
Cheesman, Mr. R. G. - 10 6
Clift, Mr. C. - 5 0
Clinton, Lord. 2 2 0
Corfield, Mr. T. - 2 6
Corfield, Mr. W. - 5 0
Cole, Mr. M. P. 2 2 0
Cox & Sons, Messrs. - 10 6
Fox and Co., Messrs.
G. C. 2 2 0
Fox, Mrs. Alfred. 1 1 0
Freeman, Mrs. Joan. - 10 0
Freeman, Mr. J. D. . - 10 0
Genn, Mr. W. J. - 10 6
Halliway, Mr. J. W. . - 6 0
Hosken, Mrs. S. 1 0 0
Jenkins, Mr. D. J.,
M.P. 2 2 0
Jenkins, Mr. G. A. . - 10 6
Jenkins, Mr. W. - 5 0
Kemble, Mrs. 5 0 0
Kimberley, Earl of. . 1 1 0
Kennerley, Mr. J. C. 1 1 0
Lean, Mr. W. H. - 10 6
Melville, Mr. P. 1 1 0
Mitchell, Mr. N. - 5 0
Olver, Mrs. J. - 5 0
Pollard, Mr. H. - 5 0
Sellew, Mrs. Wm. - 5 0
Solomon, Mr. W. H. . - 5 0
Snow, Mr. R. - 5 0
St. Aubyn, Sir John,
Bart., M.P. 1 1 0
Symons, Mr. G. W. H. - 10 0
Tilly, Mr. H. - 5 0
Tremayne, Col. 1 1 0
Vivian, Mr. Pen-
darves, M.P. 1 1 0
Webber, Mr. T. - 10 6
Williams and Co.,
Messrs. 1 1 0
Willmore, Mr. A. - 5 0
Collecting Boxes ... 1 13 4
Total £38 6 10

FOWEY BRANCH.

President—
JONATHAN RASHLEIGH, Esq.
Chairman—
The Rev. Dr. TREFFERT.
Treasurer—
ARTHUR COODE, Esq.
Honorary Secretary—
W. E. GRACH, Esq.
Honorary Collector—
W. LOWRY, Esq.
Annual Subscriptions.
Bate, Mr. John £. s. d.
Carlyon, E. Esq. 1 1 0
Carnall, R. Esq. - 10 0
Cocks, Lieut.-Col. ... 1 1 0
Coode, Arthur, Esq. . 1 1 0
Coode, Edward, Esq. . 1 1 0
Coode, John, Esq. . . 1 1 0
Crowder, A. E. Esq. 2 12 6
Davis, A. A. M.D. - 5 0
Dingle, W. W. Esq. . . 1 1 0
Fortescue, Capt. 1 0 0
Freeth, George, Esq. . 1 1 0
Hays, James, Esq. - 10 0
Hext, Thos. Esq. 1 1 0
Martyn, W. L. Esq. . . 1 1 0
Peard, Colonel 1 0 0
Purcell, Rev. H. N. . - 10 0
Rashleigh, Jonathan,
Esq. 2 2 0
Robartes, Lord 1 1 0
Sartoris, E. J. Esq. . 2 12 6
Stonford - Sackville,
Mrs. 2 2 0
Treffry, George, Esq. . - 5 0
Treffry, Rev. Dr. 1 1 0
Truscott, Chas. Esq. . - 10 6
West, William, Esq. . 1 1 0
White, Mrs. S. - 10 0
Wreford, W. Esq. - 5 0
Total £27 11 6

HAYLE BRANCH.

Chairman—
Rev. F. HOCKIN, Rector.
Honorary Secretary—
JOHN POOLE, Esq.
Annual Subscriptions.
Bain, D. W. Esq. - 5 0
Bassett, G. L. Esq. 2 0 0
Bazeley, Mr. Jas. - 5 0
Bolitho, Sons and Co.
Messrs. 1 1 0
Bural, Mrs. J. H. - 10 0
Floyd, Mr. Ed. - 5 0
Goldsworthy, Mr. F. . - 5 0
Gyles, Capt. Richard - 5 0
Harvey and Co. 5 0 0
Harvey, Frank, Esq. . 1 1 0
Harvey, Wm. Esq. . . 1 1 0
Hichens, M. T. Esq. . - 5 0
Hockin, G. C. Esq. . . 1 1 0
Hockin, Rev. F. 1 1 0
Hosken, Wm. Esq. . - 10 0
Husband, W. Esq. . . 1 1 0
Mills, Miss - 15 0
Minors, Richard, Esq. - 5 0
Mudge, James, Esq. . - 10 0
Nicholls, Mr. Loam. - 10 0
Olver, Miss - 5 0
Preece, Mr. G. - 5 0
Polkinghorne, Mr. T. - 5 0
Pool, Capt. F. H. - 10 6
Pool, Henry, - 5 0
Poole, Messrs. J. F. . - 5 0
Praed, C. Esq. 2 2 0
Rawlings, W. J. Esq. - 10 0
Rodd, F. Esq. 1 1 0
Spray, Capt. P. B. . . - 10 6
St. Aubyn, Sir John,
Bart., M.P. 1 1 0

St. Aubyn, Rev. St.

Aubyn H. Molesworth 1 1 0
The Trevethoe Estate 2 2 0
Trevithick and Sons,
J. H. 1 1 0
Vivian, John, Esq. . - 10 0
West, Nichs. J. Esq. - 10 0
West, William, Esq. - 10 0
Total 30 10 0

Donations.

Box at Custom House,
White Hart Hotel,
and Boat-house ... - 5 9
Sums under 5s. - 7 6
£31 3 3

LIZARD (POLPEAR) BRANCH.

President—
The LORD ROBARTES.
Honorary Secretary—
Rev. P. VIVIAN ROBINSON.
Annual Subscriptions.
Janvrin, Misses 1 0 0
Gregory, Mrs. (Madagascar) 2 2 0
Robartes, Lord 10 10 0
Spencer, Rev. E. 1 1 0
St. Aubyn, Sir John,
Bart., M.P. 1 1 0
Western Morning
News, Proprietors
of 1 1 0
Total 16 15 0

Donations.

Lugg, Mrs. John. - 10 0
Friend, by Misses
Janvrin - 5 0
Donation from Cey-
lon, through Misses
Janvrin 1 8 0
Collection Boxes:—
Hill's Hotel. - 15 6
Lugg's Hotel. 1 7 0
Boat House. 1 15 9
Mrs. Rowe's - 6 6
Total Dons. ... 6 7 9
Total Subs. ... 16 15 0
Total £23 2 9

LOOE BRANCH.

President—
W. H. POLE CAREW, Esq.
Chairman—
G. KERSWILL, Esq.
Honorary Secretary—
ROBERT THOMAS, Esq.
Annual Subscriptions.
Allen, Misses - 5 0
Barrett, Mr. R. - 5 0
Bawden, Mr. - 5 0
Bewes, Rev. T. A. . . 1 0 0
Bishop, James, Esq. . 1 1 0
Buller, J. F. Esq. 5 0 0
Bush, Rev. Paul - 10 0
Campbell, Rev. Ed. . - 5 0
Campbell, John, Esq. - 10 0
Campbell, Mrs. T. . . - 10 0
Campbell, T. Esq. . . - 10 0
Campbell, Truman,
Esq. - 10 0
Carew, W. H. P. Esq. 1 0 0
Caunter, Henry, Esq. - 10 0

Childs, Borlase, Esq. £. s. d.

Clogg, S. Esq. - 10 0
Clymo, Mrs. James. - 10 0
Coad, J. L. Esq. - 5 0
Congdon, Mr. J. - 10 0
Crichton, M. F. Esq. . - 10 0
Davy, Capt. Henry. . - 5 0
Fisher, Rev. J. F. . . - 10 0
Foster, E. C. Esq. - 10 0
Foster, Rd. Esq. 1 1 0
Furieux, Rev. A. - 5 0
Garrett, Rev. S. - 10 0
Gill, Dr. - 5 0
Glanville, Rev. H. C. - 10 0
Glencross, Rev. Ed. . - 10 0
Glencross, Rev. Jas. - 10 0
Grigg, John, Esq. - 10 0
Hawke, Rd. Esq. - 10 0
Hicks, Mr. B. - 5 0
Hicks, Mr. J. S. - 5 0
Hicks, Mr. William . - 5 0
Hill, Capt. John. - 5 0
Hooppell, Mrs. - 5 0
Iago, Mr. - 5 0
Jenkins, Rev. D. - 5 0
Jenkins, S. W. Esq. . - 10 0
Jones, Rev. E. D. - 10 0
Kelly, E. Esq. - 10 0
Kemble, Rev. A. 1 1 0
Kerswill, Geo. Esq. . - 10 0
Kerswill, Mrs. Esq. . - 5 0
Kerswill, J. B. Esq. . - 10 0
Kerswill, Robt. Esq. . - 10 0
King, Rev. Joseph . . - 10 0
Kitson, Rev. J. F. . . - 10 0
Kitson, Mrs. - 10 0
Little, Mr. Rd. - 5 0
Marshall, Capt. John - 5 0
Marshall, L. Carrington, Esq. - 10 0
Marshall, Wm. Esq. . 1 0 0
Martin, Rev. Canon. . 1 1 0
Martin, Rev. R. 1 1 0
Medland, James, Esq. - 10 0
Mores, Col. de. - 10 0
Nicholas, John, Esq. . - 10 0
Norris, Mrs. - 10 0
Norton, Rev. F. C. . . - 10 0
Olver, Mr. Thomas . . - 5 0
Peel, W. Esq. 1 0 0
Poad, Mr. John - 5 0
Pole, Henry, Esq. 1 0 0
Polkinghorne, Wm.
Esq. - 10 0
Roberts, Rev. John. . 1 1 0
Secombe, Mrs. - 10 0
Squire, E. D. Esq. 1 0 0
Tatham, Mrs. - 5 0
Thomas, Robert, Esq. - 10 0
Trelawny, Sir John . 1 1 0
Trelawny, W. L. S.
Esq. 1 1 0
Tucker, Mr. W. T. . . - 5 0
Walters, Mr. James. . - 5 0
Walters, Capt. John. - 5 0
Walters, Capt. John. - 5 0
Walters, Capt. Sam. . - 5 0
White, J. Esq. - 10 0
White, Mrs. J. - 10 0
Wilcocks, Isaac, Esq. - 10 0
Wilkes, C. Esq. - 10 0
Wren, W. Esq. - 10 0
Wynhall, Mr. E. - 5 0
Sums under 5s. - 5 0
Total 47 8 0

Donations.

The Earl of St. Ger-
mans 5 0 0
Pillar boxes and
Small sums 1 14 2
£54 2 2

MEVAGISSEY BRANCH.

President— JOHN TREMAYNE, Esq., J.P.

Chairman— Capt. WILLIAM BALL.

Honorary Secretary— Capt. J. BALL FARRAN.

Annual Subscriptions.

Table with 3 columns: Name, £, s., d. Includes Bailey, Edward, Esq. 2 0 0; Coode, Arthur, Esq. 10 6; Duncalf, Mr. William 5 0; Farran, Capt. J. B. 5 0; Higman, H. W. Esq. 10 0; Mt. Edgencombe Lord 3 0 0; Tremayne, J. Esq. 5 0 0; Williams, John M. Esq. 3 0 0; Small sums 4 1. Total £14 14 7

MULLION BRANCH.

President— The LORD ROBERTS.

Chairman— J. SYDNEY DAVEY, Esq., J.P.

Honorary Secretary— E. G. HARVEY, Vicar.

Annual Subscriptions.

Table with 3 columns: Name, £, s., d. Includes Davey, J. Sydney, Esq. 1 1 0; Davey, Richard, Esq. 1 0 0; Head, Mrs. 5 0; Jose, Mr. Jer. 5 0; Kempthorne, Mr. J. B. 10 0; Lyle, Miss. 5 0; Roberts, Lord 5 5 0; Shepherd, Mr. T. 5 0; Thomas, Mr. Joseph 5 0; Thomas, Mr. Fredk. 5 0; Vvygan, Rev. Sir Vyell, Bart. 2 0 0; Williams, Mr. Peter 10 0; Sums under 5s. 1 0 0. Total 12 16 0

Total 12 16 0

Donations.

Collection Box 2 10

£12 18 10

NEWQUAY BRANCH.

Chairman— W. E. MICHELL, Esq.

Honorary Secretary— Mr. RICHD. HICKS.

Annual Subscriptions.

Table with 3 columns: Name, £, s., d. Includes Boyle, Mr. 5 0; Carter, Capt. W. J. 5 0; Carus-Wilson, E. S. Esq. 10 0; Clark, Esq. 5 0; Collins, J. B. Esq. 1 1 0; Criddell, M. Esq. 5 0; Crocker, Capt. John 5 0; Edwards, Miss. 1 1 0; Edwards, Mr. J. V. 5 0; Ennor, Mr. J. 5 0; Hawke, Miss. 5 0; Hicks, Mr. W. 5 0; Hicks, Mr. R. 5 0; Hooper, Mr. J. 5 0; Jenkin, Mr. Albert 5 0; Jenkin, Capt. Thomas 5 0

Table with 3 columns: Name, £, s., d. Includes Jenkin, Capt. James 5 0; Jewel, Mr. Alfred 5 0; Kendall, Mr. R. 5 0; Martyn, Mr. S. E. 1 1 0; Michell, Mrs. W. 1 1 0; Michell, W. E. Esq. 1 1 0; Moleworth, Sir P. Bt. 10 0; Oates, Richd. 5 0; Oliver, Mr. R. S. 5 0; Pearce, Miss. 1 0 0; Prout, Capt. Thomas 5 0; Reynolds, Mr. Jno. 5 0; Rodd, F. Esq. 2 0 0; Shuckford, Mrs. 1 1 0; Thomas, Capt. Wm. 5 0; Tonkyn, Capt. W. 5 0; Trebilcock, Capt. T. 5 0; Tredwen, Mr. R. 5 0; Treffry, Rev. E. J., D.C.L. 1 1 0; Wellington, Mr. B. 5 0; Weston, Mr. Fredk. 5 0; Wilyams, A. Esq. 10 0; Wilyams, B. Esq. 1 0 0; Sums under 5s. 5 0. Total 19 12 0

Donations.

Table with 3 columns: Name, £, s., d. Includes John Bellamy, at Boscastle 2 6 8; Herbert, Hon. A. and Lady F. 1 0 0; Sanderson, Captain Henry 10 0; Box at Commercial Hotel, Newquay 5 0; Do. at Life-boat House 7 4; Do. at Post Office, Newquay 5 6; Do. at Red Lion Hotel, Newquay 6 6; Do. at Wellington Hotel, Boscastle 14 0. Total 42 5 7

PADSTOW BRANCH.

Chairman— C. G. PRIDEAUX BRUNE, Esq.

Honorary Secretary— Rev. RICHARD TYACKE.

Annual Subscriptions.

Table with 3 columns: Name, £, s., d. Includes Roberts, Lord 1 1 0; Beatrice, Lady Moleworth 10 6; Moleworth, Sir Paul W. Bart. 1 1 0; Sawle, Dowager Lady Graves 1 1 0; Allport, Mr. Samuel 10 0; Allport, Mr. W. S. 5 0; Bishop, Mr. 1 0 0; Broad, Mr. Arch. J. B. 10 0; Brune, Prideaux, C. G. Esq. 2 0 0; Carlyon, the Rev. J. 5 0; Gurney, Rev. Golds-worthy 1 0 0; Guy, Mrs. 10 6; Hellyar, Miss 1 1 0; Hicks, Mr. 7 6; Langford, Capt. R. 5 0; Langford, Mr. Sussex 5 0; Lloyd, Mr. 5 0; Mann, Rev. C. N. 5 0; Marley, Mr. Hen. F. 5 0; Martyn, Mr. Henry 1 0 0; Martyn, Miss G. 10 6; Martyn, Mr. I. 1 0 0; Martyn, Mr. S. Symons 1 1 0; Martyn, Mrs. S. Symons 5 0; Martyn, Mr. Thomas 10 0

Table with 3 columns: Name, £, s., d. Includes Paynter, Rev. Samuel 1 0 0; Peter, Mrs. 1 1 0; Peter, Miss 1 0 0; Phillippis, Mr. H. N. 2 2 0; Potter, W. R. C. Esq. 1 0 0; Rawle, Capt. 10 6; Rawlings, the Misses 1 0 0; Rolleston, Mrs. 5 0; Stephens, Mrs. 10 0; Tregaskis, Mr. Saml. 5 0; Tremaine & Clemow, Messrs. 1 1 0; Tyacke, the Rev. R. 10 6; Wilson, Capt. 1 1 0. Total 28 1 0

Donation.

Table with 3 columns: Name, £, s., d. Includes West of England Club, Padstow 5 0 0. Total 5 0 0

PENZANCE AND SENNEN COVE BRANCH.

Chairman— The MAYOR.

Treasurer— JOHN R. BRANWELL, Esq.

Honorary Secretary— JOHN MATHWS, Esq.

Annual Subscriptions.

Table with 3 columns: Name, £, s., d. Includes Adkins, J. C. Esq. 1 0 0; Aitkin, Rev. R. W. 5 0; Bazeley and Son, Messrs. George 5 0; Bedford, Capt. D. B. 10 0; Bennett, W. S. Esq. 5 0; Boase, Francis, Esq. 10 0; Bodilly and Sons, Messrs. T. H. 10 6; Bolltho, Edw. Esq. 1 0 0; Bolltho, R. F. Esq. 1 1 0; Bolltho, T. S. Esq. 1 0 0; Bolltho, T. Robins, Esq. 10 0; Bolltho, T. Bedford, Esq. 10 0; Bolltho, W. Esq. 1 0 0; Bolltho, Mrs. W. 5 0; Borlase, Rear-Adm. 10 0; Borlase, Walter H. Esq. 10 0; Borlase, W. Copeland, Esq. 10 0; Botcher, Capt. R. N. 5 0; Branwell and Sons, Messrs. R. M. 10 0; Branwell, Miss. 5 0; Brittain, F. W. Esq. 10 0; Carne, Miss. 2 0 0; Carter, Mrs. 5 0; Cholmeley, Dowager Lady Georgiana Wentworth 5 0 0; Clarke, Mr. F. J. 5 0; Cook, W. M. 5 0; Cornish, Thomas, Esq. 5 0; Corporation of Penzance 5 0 0; Coulson, Messrs. Tho. and Co. 5 0 0; Davy, Messrs. E. & H. 5 0; Davy, Messrs. R. V. and H. 5 0; Dennis, Wm. Esq. 10 0; Doble, Mr. E. 5 0; Dodge, W. H. Esq. 5 0; Edmonds, Miss. 5 0; Elliott, G. L. Esq. 5 0; Fearon, Mrs. 5 0; Field, T. W. Esq. 10 0; Fisher, Mrs. 5 0; Grindall, the Misses 5 0; Harvey, Mrs. Nichs. 10 0

Table with 3 columns: Name, £, s., d. Includes Harvey, Mr. S., St. Sennen 5 0; Hedgland, Rev. P., M.A. 10 0; Hodge, Hy. Esq., St. Sennen 5 0; Holbrook, Mr. A. 5 0; Holman, Fred. Esq. 1 1 0; Hora, Mr. A. H. 5 0; Jago, the Misses 5 0; James, Mr. John 5 0; James, Mr. S. H., St. Just 10 0; King, T. Esq. 10 0; Lach-Szyma, Rev. W. S. 5 0; Laity, Mr. Hy., St. Sennen 5 0; Lanyon, Mr. J. J. 5 0; Lavin, Mr. Chas. 5 0; Le Grice, D. P. Esq. 10 0; Longhurst, Miss. 5 0; Magor, Mr. Esq. 10 0; Marrack, Mr. Philip 10 6; Mathews, Mr. F. C. 5 0; Mathews, Messrs. W. D. and Sons 10 0; Michell, A. O., Esq. 10 0; Michell, Mr. A. H. 5 0; Millett, Miss 10 0; Milton, J. P. Esq. 10 0; Moody, Miss. 5 0; Moody, Miss S. 5 0; Moleworth, Sir P. W. 10 0; Olver & Sons, Messrs. 5 0; Olver and Symons, Messrs. 5 0; Pagan, W. Esq. 5 0; Pascoe, H. and Son 5 0; Peel, Miss 5 0; Peel, Miss S. M. 5 0; Peters, Rev. M. N. 10 0; Polson, Mr. J. 5 0; Pool, Mr. George 10 0; Preston, Geo. H. Esq. 5 0; Quick, Messrs. J. R. and J. 5 0; Roberts, Mr. Thos., St. Sennen 5 0; Rodd, E. H. Esq. 10 0; Rudd, W. H. Esq. 5 0; Roe, Rev. R. J., St. Sennen 1 0 0; Rogers, Miss (Trevethian) 1 1 0; Rogers, the Misses 5 0; Roscorla, J. Esq. 5 0; Ross, C. C. Esq. (Mayor) 1 1 0; Ross, Mrs. 10 0; Roughhead, T. C. Esq. 5 0; Ruck, Mr. John 5 0; Scobell, Geo. Esq. 1 0 0; St. Aubyn, Sir John, Bart., M.P. 1 1 0; Sterling, Rev. C. J. 10 0; Thomas, Henry, Esq. 5 0; Tonkin, Rev. John, St. Buryan 10 0; Travers, Major 5 0; Trelawney, Colonel 5 0; Trenweman, Mr. N., St. Sennen 5 0; Trevethick, Mrs. 10 0; Trythall, W. Esq. 10 0; Victor, Messrs. R. R. and H. 5 0; Vigers, Mrs. Louis 10 0; White, W. Todd, Esq. 10 0; Williams, Mrs. 5 0; Wills, Mrs. 5 0; Wingfield, Rev. W. W. 10 0; Sums under 5s. 13 8 0. Total 68 9 0

Table with 3 columns: Name, £, s., d. Includes King, T. Esq. 10 0; Lach-Szyma, Rev. W. S. 5 0; Laity, Mr. Hy., St. Sennen 5 0; Lanyon, Mr. J. J. 5 0; Lavin, Mr. Chas. 5 0; Le Grice, D. P. Esq. 10 0; Longhurst, Miss. 5 0; Magor, Mr. Esq. 10 0; Marrack, Mr. Philip 10 6; Mathews, Mr. F. C. 5 0; Mathews, Messrs. W. D. and Sons 10 0; Michell, A. O., Esq. 10 0; Michell, Mr. A. H. 5 0; Millett, Miss 10 0; Milton, J. P. Esq. 10 0; Moody, Miss. 5 0; Moody, Miss S. 5 0; Moleworth, Sir P. W. 10 0; Olver & Sons, Messrs. 5 0; Olver and Symons, Messrs. 5 0; Pagan, W. Esq. 5 0; Pascoe, H. and Son 5 0; Peel, Miss 5 0; Peel, Miss S. M. 5 0; Peters, Rev. M. N. 10 0; Polson, Mr. J. 5 0; Pool, Mr. George 10 0; Preston, Geo. H. Esq. 5 0; Quick, Messrs. J. R. and J. 5 0; Roberts, Mr. Thos., St. Sennen 5 0; Rodd, E. H. Esq. 10 0; Rudd, W. H. Esq. 5 0; Roe, Rev. R. J., St. Sennen 1 0 0; Rogers, Miss (Trevethian) 1 1 0; Rogers, the Misses 5 0; Roscorla, J. Esq. 5 0; Ross, C. C. Esq. (Mayor) 1 1 0; Ross, Mrs. 10 0; Roughhead, T. C. Esq. 5 0; Ruck, Mr. John 5 0; Scobell, Geo. Esq. 1 0 0; St. Aubyn, Sir John, Bart., M.P. 1 1 0; Sterling, Rev. C. J. 10 0; Thomas, Henry, Esq. 5 0; Tonkin, Rev. John, St. Buryan 10 0; Travers, Major 5 0; Trelawney, Colonel 5 0; Trenweman, Mr. N., St. Sennen 5 0; Trevethick, Mrs. 10 0; Trythall, W. Esq. 10 0; Victor, Messrs. R. R. and H. 5 0; Vigers, Mrs. Louis 10 0; White, W. Todd, Esq. 10 0; Williams, Mrs. 5 0; Wills, Mrs. 5 0; Wingfield, Rev. W. W. 10 0; Sums under 5s. 13 8 0. Total 68 9 0

Donations.

Table with 3 columns: Name, £, s., d. Includes Pillar Box, Promenade, and Box at the Life-boat Station, Penzance 6 4 10

	£.	s.	d.
Tomlinson, J.....	5	0	0
Tyson and Hobson, Messrs.....	2	1	0
Wilson, Robert, Esq. 1	0	0	0
Wilson, Mr. Wm.....	5	0	0
Wood, Mr. J. H.....	5	0	0
Wood, Wilton, Esq...-	5	0	0
Total.....	16	8	6
<i>Donations.</i>			
Banks, J. H.....	5	0	0
Boyd, T.....	5	0	0
Total.....	£16	18	6

WHITEHAVEN AND SEASCALE BRANCH.

Patron—
The Right Hon. the EARL OF
LONSDALE.

Treasurer and Hon. Sec.—
Capt. DAVID BORROWDALE.

Annual Subscriptions.

Lonsdale, The Right
Hon. The Earl of, 5 5 0

Adair, Mr. J..... 5 0 0

Adair, Mr. J. M..... 5 0 0

Ainsworth, Mr. D..... 5 0 0

Ainsworth, Mr. T..... 1 1 0

Atkinson, Mr. H..... 5 0 0

Atter, Mr. E..... 10 6 0

Barker, Mrs. A..... 1 0 0

Bedford, Mr..... 5 0 0

Bentinck, Right Hon.
G. A. C., M.P..... 1 1 0

Brockbank, Mr. Jas..... 10 0 0

Brown, Mr. T..... 10 0 0

Buckham, Mrs..... 10 0 0

Burnyeat, Mr. W..... 10 6 0

Cameron, Mr. Peter, 1 7 0

Collins, Mr. J..... 5 0 0

Collis, Mr. Isaac..... 10 0 0

Cousins, Mr. R..... 5 0 0

Crossfield Iron Ore Co. 1 1 0

Davis, Mr. John..... 5 0 0

Deas, Mr. James G..... 10 0 0

Dickinson, Mr. J. N..... 5 0 0

Dixon, Mr. T. C..... 10 0 0

Fisher, Mr. Charles 1 1 0

Furness Railway Co. 2 2 0

Gordon & Todhunter,
Messrs..... 5 0 0

Hampson Brothers,
Messrs..... 5 0 0

Hellon, Mr. John S..... 10 0 0

Helder, Mr. A..... 5 0 0

Hodgetts, Mr. A..... 1 1 0

Hodgson, Capt. Isaac 10 0 0

Howson, Mr. Thos..... 10 0 0

Hudson, Mr. T..... 1 1 0

Ianson, Dr..... 10 0 0

Jackson, Mr. George 5 0 0

Jackson, Mr. John 5 0 0

Jackson, George, & Co. 5 0 0

Jackson, Mr. T..... 5 0 0

Jacques, Mr. J..... 1 1 0

Jefferson, Messrs. R.
and H..... 1 0 0

Jenkins, Mr. John..... 10 0 0

Johnson, the Misses 1 1 0

Leonfield, Lord..... 1 1 0

Lindow, S. & J..... 2 2 0

Little, James & Co.,
Barrow (per Mr. E.
Eddis)..... 1 1 0

Lumb, Mr. W. W..... 10 0 0

Mackenzie, Mr. H. M. 1 1 0

McKelvie, Mr. John 10 0 0

McGowan, Messrs. J.
A. & W..... 5 0 0

Metcalf and Jackson,
Messrs..... 5 0 0

Moore & Co. Messrs. 10 0 0

Mossop, Mr. J. B..... 5 0 0

Munster, Lord..... 5 0 0

	£.	s.	d.
Murray, Miss.....	5	0	0
Musgrave, Mr. John 1	0	0	0
Musgrave, Mr. J. R.....	10	0	0
Nicholson, Mr. T.....	5	0	0
Pearson, John & Son.....	5	0	0
Poslethwaite, Mr. J.....	10	0	0
Poslethwaite, Mr. M.....	10	0	0
Rigg & Co., Messrs. C.....	5	0	0
Robinson, Mr. J. H. 1	0	0	0
Robinson, Mr. R. A.....	10	0	0
Russell, Mr. John.....	5	0	0
Scott, Mrs.....	5	0	0
Senhouse, Miss.....	10	0	0
Sparrow, Mr.....	5	0	0
Spencer, Major.....	1	1	0
Sterling, Mr. John 2	2	0	0
Thompson, Mr. A.....	10	0	0
Vivian, Mr. John.....	5	0	0
Walker, Mrs. R.....	1	0	0
Walker, Mr. Wm.....	10	0	0
Whiteside, Mr. H. J.....	5	0	0
Whittle, Messrs.....	5	0	0
Wilson and Kitchen, Messrs.....	10	0	0
Wilson, Mr. John.....	5	0	0
Winder Iron Ore Co. 1	1	0	0
Whitehaven, Trustees of the Port of.....	10	0	0
Sums under 5s.....	3	7	6
Total.....	73	13	6

Donations.

Box at Seascale Hotel - 14 8

Do. at do. Boat House - 5 8

do. Custom House,
Whitehaven..... 0 8

Total...£74 14 6

WORKINGTON BRANCH.

Chairman—
CHARLES J. VALENTINE, Esq.

Honorary Secretary—
J. C. THOMPSON, Esq.
1878-9.

Annual Subscription.

Bowness, Capt. Rich. - 5 0

Donations.

Alexander, Jas..... 10 0

Bain, Jas. C..... 10 0

Barnes, Robt..... 5 0

Bell, Capt. Thos..... 5 0

Bowes, Henry..... 5 0

Broatch, J. A..... 10 0

Brooker, G..... 5 0

Brown, John P..... 5 0

Clifton, Rev. C. W..... 10 0

Crosthwaite, T..... 10 0

Davidson, Joseph..... 5 0

Derwent Iron Co..... 10 0

Dickinson, W..... 10 0

Douglas, T. M..... 10 0

Dunn, J. S..... 5 0

E. F. and H. G. S..... 5 0

Falcon, M..... 10 0

Fell, J. T..... 10 0

Fisher and Sprott... 1 1 0

Froudell, S. T..... 5 0

Gamble, J..... 10 0

Graham, G..... 5 0

Griffiths, W..... 10 0

Harrison, K. M..... 5 0

Hill, Rowland..... 5 0

Hoare, Henry..... 5 0

Hour, J..... 5 0

Iredell Brothers..... 1 0 0

Key, Joseph..... 5 0

Kirk Brothers..... 10 0

Litt, Chas..... 10 0

Melton, Wm..... 5 0

Mordy, John..... 5 0

Mordy, Wm..... 1 0 0

Ormsrod, F..... 10 0

Peile, A..... 10 0

Quirk, P. G..... 10 0

	£.	s.	d.
Robinson, Capt. R.....	10	0	0
Salter, M.....	5	0	0
Saunders, G. F.....	5	0	0
Scott, Josh.....	10	0	0
Scott, W. G.....	10	0	0
Scrugham, Hy.....	10	0	0
Sewell, T.....	10	0	0
Simpson, J. S.....	10	0	0
Snelus, G. J.....	10	0	0
Sprott, Capt. J.....	10	0	0
Thoruley, Rev. J. J.....	10	0	0
West Cumberland Works.....	10	0	0
Williamson, Thos.....	5	0	0
Wilson, Wm.....	10	0	0
Worton, J.....	10	0	0
Contribution Box at Custom House.....	8	2	0
Sums under 5s.....	1	3	0
Total.....	£24	7	2

Denbighshire.

LLANDULAS BRANCH.

Chairman—
ANDREW DOYLE, Esq.

Honorary Secretary—
Rev. J. DAVIES, M.A.

Annual Subscriptions.

Beckett, Mrs..... 1 0 0

Davies, Rev. J..... 1 0 0

Doyle, A. Esq..... 2 0 0

Hecketh, R. B. Esq. 5 0 0

Kneeshaw & Co.,
Messrs..... 5 0 0

Llandulas Quarry
Company..... 5 0 0

Total.....£19 0 0

Derbysire.

BELPER BRANCH.

Chairman—
H. LOMAS, Esq.

Treasurer—
W. WINTERBOURNE, Esq.

Honorary Secretary—
W. P. ADHEAD, Esq.

Annual Subscriptions.

Adhead, Mr. W. P. 1 1 0

Adhead, Mrs. W. P. 10 6

Adhead, Miss W. P. 10 6

Anthony, Mr. W. B. 10 6

Bourne, Mrs..... 1 1 0

Bowler, Mr..... 5 0

Calvert, Mr..... 5 0

Friend, Rev. F..... 5 0

Hanson, Mr..... 10 6

Hogg, Mr. F..... 5 0

Hogg, Mr. J. M..... 5 0

Hunter, Mr. J..... 1 0 0

Lichfield, Miss..... 5 0

Lloyd, Rev. R. L..... 10 0

Lomas, Mr. H..... 10 0

Robinson, Mr. J..... 10 0

Smedley Bros..... 10 0

	£.	s.	d.
Smedley, Mr. J.....	10	6	0
Stone, Mr. S.....	5	0	0
Tomlinson, Mr.....	5	0	0
Topham, Miss.....	10	6	0
Wheeldon, Messrs.....	5	0	0
Whittaker, Mr. W.....	5	0	0
Sums under 5s.....	2	9	6
Collecting Boxes.....	1	16	0
Total.....	£15	0	6

DERBY BRANCH.

Treasurer—
WILLIAM PEAT, Esq.

Honorary Secretary—
T. H. HARRISON, Esq.

Annual Subscriptions.

Bakewell and Wilson,
Messrs..... 1 1 0

Curzon, Hon. Mrs..... 1 1 0

Curzon, N. C. Esq. 1 1 0

Harrison, T. H. Esq. 1 1 0

Howitt, Mrs..... 1 1 0

Moody, John, Esq..... 10 6

Morley, F. Esq..... 2 2 0

Newbold, J. W. Esq. 10 6

Newton, C. E. Esq. 1 1 0

Peach, Mrs. Edward. 2 2 0

Peat, Wm. Esq..... 2 2 0

Schwind, Chas. Esq. 1 1 0

Walters, Mrs..... 1 1 0

Total.....£15 15 0

Devonshire.

BARNSTAPLE AND BRAUNTON BRANCH.

Vice-Patron—
THE EARL FORTESCUE.

Chairman—
Rev. A. E. SEYMOUR.

Treasurer—
T. W. GUPPY, Esq.

Honorary Secretary—
A. J. LAW, Esq.

Annual Subscriptions.

Avery, Mrs. Alice - 5 0

Avery, W. Esq. 10 0

Bassett, Rev. Francis - 10 0

Bangh, Col..... 10 0

Besley, H. T. Esq..... 10 0

Brady, Mr. J..... 10 6

Chanter, J. R. Esq. - 5 0

Chichester, C. Esq. 1 0 0

Chichester, B. Esq. - 10 0

Crang, John, Esq..... 10 0

Crosse, R. J. Esq. 5 0 0

Davie, Mrs..... 10 0

Day, G. H. Esq..... 5 0 0

Dennis, T. J. Esq..... 10 0

Fletcher, Miss..... 5 0

Fletcher, W. Esq. 1 1 0

Fortescue, Rt. Hon.
Earl..... 2 2 0

Gifford, —, Esq..... 1 0 0

Gould, W. Esq..... 10 0

Gribble, the Misses - 5 0

Haggard, Rev. C..... 1 1 0

Hall, Rev. W. C..... 5 0

Harper, Jos. Esq..... 10 0

Harris, W. P. Esq. 5 0

EXETER BRANCH.

President—
The Right Hon. the EARL OF DEVON.
Honorary Treasurers and Secretaries.
T. B. GIBBS, Esq.
COURTENAY H. EDMONDS, Esq.

Annual Subscriptions.

Table listing names and amounts for Exeter Branch annual subscriptions, including Acland, Arden, Barnes, Barton, Belfield, etc.

Total 42 5 0

Donation.

Offertory at St. Mary Arches, per Rev. A. H. Hamilton 7 3

£42 13 3

EXMOUTH BRANCH.

Patroness—
The Right Hon. LADY ROLLE.
Chairman—
CHARLES PRETTIJOHN, Esq.
Honorary Secretary—
Capt. C. SQUIRE.

Collector—

Mr. E. GARD.

Annual Subscriptions.

Table listing names and amounts for Exmouth Branch annual subscriptions, including Abbott, Adams, Agazis, Allen, etc.

Table listing names and amounts for Exmouth Branch donations, including Wippell, Wood, Sums under 5s.

Total 57 5 0

Donation.

Abbott, Miss F. 2 10 0

£59 15 0

ILFRACOMBE AND MORTE BRANCH.

Chairman—
P. STONEHAM, Esq.
Honorary Secretary—
N. VYE, Esq. J.P.

Annual Subscriptions.

Table listing names and amounts for Ilfracombe and Morte Branch annual subscriptions, including Adams, Blandy, Broughton, etc.

Total 25 2 0

Donations.

Table listing names and amounts for Ilfracombe and Morte Branch donations, including Alpha, Bailey, Basset, etc.

Table listing names and amounts for Ilfracombe and Morte Branch donations, including Richards, Robertson, Robinson, etc.

Total Dons. 35 18 3

Total Subs. 25 2 0

£61 0 3

LYNMOUTH BRANCH.

Honorary Secretary—
Mr. JOHN CROOK.

Annual Subscriptions.

Table listing names and amounts for Lymouth Branch annual subscriptions, including Baker, Bevan, Crook, etc.

Total 7 16 0

Donations.

Table listing names and amounts for Lymouth Branch donations, including Lawson, Sykes, Symons, etc.

£14 19 0

NEWTON ABBOT BRANCH.

Honorary Secretaries—
Major YARRES.
Mr. R. L. LLOYD.

Annual Subscriptions.

Table listing names and amounts for Newton Abbot Branch annual subscriptions, including Baker, Bewes, Bearne, etc.

Total 8 4 6

Donations.

Table listing names and amounts for Newton Abbot Branch donations, including Armstrong, Beachey, Harris, etc.

Total Dons. 6 13 0

Total Subs. 8 4 6

£14 17 6

TEIGNMOUTH BRANCH.

President— SIR LAWRENCE PALK, BART.
Chairman— B. A. ARNOLD, Esq.
Treasurer and Hon. Sec.— W. WILLIAMS, Esq.

Annual Subscriptions.

Table listing annual subscriptions for Teignmouth Branch, including names and amounts in £, s., and d.

Donations.

Table listing donations for Teignmouth Branch, including Station boxes, etc. and other contributions.

TORBAY BRANCH.

President— The Rt. Hon. LORD CHURSTON.
Honorary Secretary— Rev. R. FENWICK ELLINGTON.

Annual Subscriptions.

Table listing annual subscriptions for Torbay Branch, including names and amounts in £, s., and d.

TORQUAY BRANCH.

President— SIR LAWRENCE PALK, BART.
Vice-President— R. S. CARY, Esq.
Secretary and Collector— Mr. R. G. COVE, of the Post Office. Residence: Clifton Villa.

Annual Subscriptions.

Table listing annual subscriptions for Torquay Branch, including names and amounts in £, s., and d.

Table listing names and amounts for the central part of the document, including Cary, R. S., Cary, Mrs. Stanley, Cassavitt, John, etc.

Table listing names and amounts for the right side of the document, including Midgley, S., Mills, Robert F., Mills, Mrs., etc.

BRANCHES—LIST OF ANNUAL SUBSCRIPTIONS AND DONATIONS. 109

Pillar Box	£. s. d.
Collected at Custom House	2 13 9
Boxes with Small Amounts	1 0 6
Total Dons	17 13 8
Total Subs.	114 4 6
<hr/>	
	£131 18 2

WESTERN COUNTIES CENTRAL BRANCH.

President—
The Right Hon. the EARL OF DEVON.

Honorary Treasurer—
THOMAS B. GIBBS, Esq.

Annual Subscriptions.

Barnard, Admiral	1 1 0
Bere, Mrs. Sen.	10 6
Ewens, G. D. Esq.	2 6
Knight, Rev.	1 1 0
Lowe, Miss	5 0
Newmann, G. Esq.	1 0 0
Simcoe, Capt., R.N.	2 2 0
<hr/>	
Total	6 2 0

Donations.

Burnard, A. J. Esq.	5 0
Belman, Rev.	5 0
English, J. T. Esq.	5 0
Knight, H. Esq.	5 0
Lindsey, J. Esq.	10 0
Lowe, Rev.	10 0
Lowe, Miss E.	5 0
Miller, Mr. Seaton	1 11 6
Patch, Rev.	5 0
Porter, W. Esq.	10 0
Sharpe, J. Esq.	10 0
Sidmouth, Rt. Hon. Viscount	1 0 0
Simcoe, Capt., R.N.	5 0 0
Warry, Major	5 0 0
Sums under 5s.	1 17 6
Contribution boxes on G. W. R.	2 5 0
Ditto on L. & S. W. Railway	3 1 2
Ditto on Somerset & Dorset Railway	3 0 0
Ditto on South Devon Railway	9 9 2
Pillar boxes	12 5 10
<hr/>	
Total Dons	40 8 2
Total Subs.	6 2 0
<hr/>	
	£46 10 2

YEALM RIVER BRANCH.

Hon. Secretary—
RALPH DAWSON, Esq.

Annual Subscriptions.

Baring, Edward C.	1 1 0
Bastard, J. P.	1 1 0
Collinsplatt, Hawtrey	1 0 0
Collinsplatt, Henry	1 1 0
Cory, Richard	1 1 0
Dawson, Ralph	1 1 0
Dawson, Mrs.	1 1 0
Hicks, Col., C. B.	1 0 0
Hicks, Miss	1 1 0
Holberton, T. & V.	1 1 0
Lane, Rev. Richard	1 1 0
Roe, Rev. Henry F.	1 1 0
Yonge, Rev. Duke	1 1 0
<hr/>	
Total	£13 11 0

Dorsetshire.

BRIDPORT DISTRICT BRANCH.

President—
THOMAS COLFOX, Esq.

Secretary and Collector—
Mr. H. Good.

Annual Subscriptions.

Beach, Thomas	10 0
Chick, W. H.	5 0
Colfox, T.	1 0 0
Colfox, W.	1 0 0
Cox, E.	10 0
Crocker & Son, W.	5 0
Down, Mrs.	5 0
Edmunds, C.	5 0
Edmunds, T.H., Mayor	5 0
Good, F.	5 0
Gundry, F. W.	5 0
Gundry, J. P. F.	1 0 0
Hounsell, H.E. (Lim.)	5 0
Hounsell, J.	5 0
Hounsell, R.	5 0
Hounsell, T.	10 0
Hounsell, W.	10 0
Howell, H.	5 0
Knight, W.	5 0
Legg, Job.	10 0
Manley, W. H.	5 0
Ralli, P. M.P.	2 0 0
Suttil, J. P.	5 0
Tucker, C.	5 0
Tucker, Frank	5 0
Tucker, Harry	5 0
Tucker, W. A.	5 0
Waldron, Capt.	5 0
Waldron, Miss	5 0
Wansey, Miss	5 0
Collecting Box	8 6
Sums under 5s.	2 6
<hr/>	
Total	£13 6 0

ISLE OF PURBECK BRANCH.

President—
The EARL OF ELDON.

Vice-President—
Lieut.-Col. MANSEL.

Honorary Secretary—
Rev. OWEN L. MANSEL, M.A.

Annual Subscriptions.

Earl of Eldon	15 0 0
Bankes, Albert, Esq.	1 0 0
Bankes, Rev. Prebend.	1 0 0
Bennett, S. Esq.	10 0 0
Best, Mr.	5 0 0
Bond, George, Esq.	1 0 0
Bond, Nath. Esq.	1 10 0
Bond, Rev. Prebend.	1 0 0
Bond, Thos. Esq.	10 0 0
Boreham, Dr.	5 0 0
Cann, Mr. R.	5 0 0
Coulson, Miss	5 0 0
Cust, Mr.	5 0 0
Digby, G. Wingfield, Esq.	2 2 0
Derrick, Mr.	5 0 0
Drew, Mr.	10 0 0
Karrer, Mrs.	1 0 0
Filliter, F. Esq.	1 0 0
Fyler, J. Esq.	1 0 0
Gower, Mr. H.	10 0 0
Hoare, Mrs. C. B.	1 0 0
Hooper, Mr.	10 0 0
Horlock, Mr.	5 0 0
Jackson, Miss	1 0 0
Kent, Mr. J.	5 0 0

Lacey, Mr.	5 0
Lester, Rev. Lester	1 0 0
Mansel, Lieut. Col.	1 0 0
Mansel, Rev. O. L.	1 0 0
Marshall, Mr. J.	10 0 0
Marshall, Mr. F.	10 0 0
Oakley, Mr.	5 0
Panton, J. Esq.	10 6
Pearce, Rev. J.	2 2 0
Pike, W. J. Esq.	1 0 0
Pryce, Mrs.	5 0 0
Rodgett, Mrs.	2 0 0
Rowe, Mrs.	10 6
Scavill, Rev. J.	5 0
Selby, Mr.	10 0
Trenchard and Smith	7 6
Whittle, Mr.	5 0
Willshire, Mr.	5 0
Small Sums	1 7 0
<hr/>	
Total	45 19 6

Donations.

Collected by Eustace Mansel, Esq., 52nd Regt.	1 10 0
Collected in Mrs. Serrell's Sunday Schoolrooms	1 10 0
Collected by Miss Hunt, East Stoke	2 2 0
Entertainment at Tyneham	10 0
Collected by Miss Yearsley	18 8
Small Sums	5 5
<hr/>	
Total Dons	6 16 1
Total Subs.	45 19 6
<hr/>	
	£52 15 7

LYME REGIS BRANCH.

Chairman—
WILLIAM HINGESTON, Esq.

Honorary Secretary—
Mr. WILLIAM BENNETT.

Annual Subscriptions.

Ames, E. L. Esq.	1 1 0
Bank, late Delamark, Esq.	10 0
Brandram, Col.	1 0 0
Bullen, Capt. C. R.N.	1 0 0
Chalmers, A. J. Esq.	5 0 0
Egerton, Rev. B.	5 0 0
Hayward, Miss	10 0
Henley, Miss	10 0
Henning, Miss	5 0 0
Hingeston, Wm. Esq.	1 0 0
Ingram, Hughes, Esq.	1 0 0
Landon, Mrs.	5 0 0
Lean, Mrs.	10 0 0
Luttrell, Miss	1 0 0
Marsh, Isaac, Esq.	5 0 0
Norris, H. E. Esq.	5 0 0
Patton, Capt. L., R.N.	10 0
Peek, Rev. Edward	1 0 0
Peel, Edmund, Esq.	5 0 0
Preston, I. W. Esq.	10 0
Rendall, late Mrs.	5 0 0
Radford and Radford	5 0 0
Shore, Mrs.	5 0 0
Skinner, Dr.	5 0 0
Stanger Leathes, the Misses	7 6
Symons, Mrs.	10 0
Tucker, Henry, Esq.	10 0
Vizard, Mrs. H. B.	1 0 0
Wallis, Mrs. W. B.	5 0 0
Waring, Mrs.	5 0 0
Williams and Co.	1 1 0
Wrey, Mrs.	10 0
<hr/>	
Total	21 19 6

Donations.

Coke, W. S. Esq.	10 0
Hodges, the Rev. Dr.	10 0
Homan, E. Esq.	10 0
Hussey, Capt. W. H.	5 0
Lister, Professor	10 0
Marder, Miss	5 0
Matthey, Chas. Esq.	10 0
Munro, Capt.	10 0
Palgrave, F. T. Esq.	5 0
Talbot, Reginald, Esq.	10 0
Sums under 5s.	2 9 6
Contribution Boxes	3 19 0
<hr/>	
Total Dons	10 13 6
Total Subs.	21 19 6
<hr/>	
	£32 13 0

POOLE AND BOURNEMOUTH BRANCH.

President—
LORD SIDNEY GODOLPHIN OSBORNE.

Honorary Secretary and Treasurer—
Mr. RICHARD PENNEY.

Annual Subscriptions.

Alington, Lord	2 0 0
Ashley, Hon. Evelyn	1 0 0
Belben, G. Esq.	10 6
Belben, T. Esq.	10 6
Bennett, Rev. A. M.	10 6
Christy, Edmund, Esq.	1 1 0
Colquhoun, Sir Jas., Bart.	2 2 0
Damer, Rev. L. Dawson	1 0 0
Digby, G. D. W. Esq.	5 0 0
Dugmore, Rev. E. E.	1 1 0
Durrell, J. B. Esq. J.P.	5 0 0
Glyn, Sir R. G. Bart.	2 0 0
Glyn, Rev. C. J.	10 0
Grey, Admiral	10 0
Guest, Sir Ivor B., Bart.	2 2 0
Kemp, Rev. A.	1 0 0
Kemp, Miss	1 0 0
Kettle, Miss	10 0
Lang, Major	10 0
Lawson, Rev. J. A.	5 0 0
Meredith, H. Esq.	5 0 0
Onslow, Rev.	10 6
Penney, Rd.	5 0 0
Pelphs, Miss	10 0
Portman, Hon. W. H. B.	1 0 0
Sladen, Rev. E. H. M.	10 6
Sullivan, Admiral Sir B.J., K.C.B.	1 0 0
Welch, M. Kemp- Esq.	10 6
West, Miss	10 0
Wood, M., Esq.	5 0 0
<hr/>	
Total	28 14 0

Donations.

Harrison, J. Esq.	5 0
Box at Boat-house	4 6
Pillar Boxes, Bournemouth Pier	2 9 11
Arcade	1 12 6
<hr/>	
	£33 5 11

SWANAGE BRANCH.

President—	
G. Burr, Esq.	
Treasurer—	
G. C. DE LA MORRE, Esq.	
Honorary Secretary—	
Mr. H. J. HIXSON.	
Annual Subscriptions.	
£. s. d.	
Banks, W. R. Esq.	1 0 0
Bloxson, J. B. Esq.	10 0 0
Burt, G. Esq., Sheriff	2 0 0
Colson, Miss	5 0 0
Crawford, Dr.	1 0 0
Digby, Capt. M.P.	1 1 0
E. P.	5 0 0
Filliter, Freeland, Esq.	1 1 0
Marsh, Mr. S.	5 0 0
Randall, Mrs.	1 0 0
Robinson, J. C. Esq.	2 0 0
Scavill, Mr.	5 0 0
Slater, R. Esq.	1 0 0
Wilde, S. Esq.	3 0 0
Wilde, Miss	2 0 0
Total	16 16 0

Donations.	
Bloxson, J. B. Esq.	10 0 0
Horne, Miss	5 0 0
Horner, Mrs.	5 0 0
J. B. W.	5 0 0
J. C. R.	10 0 0
Lloyd, Mrs. Watkiss	5 0 0
Martineau, Miss.	5 0 0
Mallins, J. P.	5 0 0
Travers, Rev. R. D.	10 0 0
Walrod, Mr.	5 0 0
Woburn, Henry	5 0 0
Other Sums	5 0 0
Collected in Mrs. Serrell's Sunday Schoolrooms	1 10 0
Pillar Box & Collected at Royal Victoria Hotel	2 2 11
Proceeds of Concert.	18 16 1
Total Dons	26 4 0
Total Subs.	16 16 0
	£43 0 0

WEYMOUTH BRANCH.

Patron—	
The Right Hon. the EARL OF STRAFFORD.	
President—	
The Right Hon. LORD ASHLEY.	
Honorary Secretary—	
G. H. PRICE, Esq.	
Annual Subscriptions.	
Bauntou and Sons, Messrs.	5 0 0
Bayley, E. Esq. J.P.	1 1 0
Blampied, Capt. E.S. s.s. Great Western	4 0 9
Church, Mrs. J.	5 0 0
Devenish and Co. Messrs. J. A.	10 6 0
Elliot & Co. Messrs.	1 1 0
Elliot, George, Esq.	10 6 0
Erskine, Miss	5 0 0
Falle, Capt. steamer Brighton	1 5 0
Fisher, Capt. steamer Aquila	1 9 4
Goodden, H. C. Esq. J.P.	10 0 0
Greaves, Rev. T.	5 0 0
Groves, Mr. T. B.	5 0 0

Groves, Mr. J.	5 0 0
Hawes, Major.	5 0 0
Hodges, J. F. Esq.	10 6 0
Hopkins, Mr. B.	10 6 0
Howard, R. N. Esq.	5 0 0
Lynes, Rev. J.	5 0 0
May, Captain R.N., Inspecting Commander.	10 6 0
Moorhead, Dr.	10 0 0
Pearn, Capt. s.s. South of Ireland.	1 11 6
Penny, Colonel.	5 0 0
Phelips, Capt.	1 0 0
Pidgeon and Sons, Messrs.	5 0 0
Pigou, Rev. H. C.	10 0 0
Pretor, Capt.	5 0 0
Roberts, W. and Co.	7 6 0
Simpson, R. P. Esq.	5 0 0
Smith, Dr. M.D.	10 0 0
Tizard, Dr.	5 0 0
Welsford, G. B. Esq.	5 0 0
Williams, Messrs. H. and H. and Co.	1 1 0
Total	£21 4 7

Durham.

HARTLEPOOL BRANCH.

Honorary Secretary—	
S. HERBERT BELK, Esq.	
Annual Subscriptions.	
£. s. d.	
Belk, Thos. Esq.	1 1 0
Coverdale, J.	1 1 0
Huntley, B. R. Esq.	1 1 0
Marshall, Mr. Johu.	10 6 0
Richardson, T. Esq.	2 2 0
Ropner, R. Esq.	1 1 0
Withy, E. & Co.	1 1 0
Total	7 17 6
Donations.	
Voluntary contributions from shipping	52 4 9
	£60 2 3

SEAHAM BRANCH.

President—	
The MARQUESS OF LONDON-DERRY.	
Chairman—	
Rev. A. BETHUNE.	
Honorary Secretary—	
WILLIAM WARHAM.	
Annual Subscriptions.	
Londonderry, The Marquess of	3 3 0
Bethune, Rev. A.	10 6 0
Brough, Mrs. T.	10 0 0
Brown, J. B. Esq.	10 0 0
Brydon, R. Esq.	5 0 0
Candlish, H. Esq.	10 0 0
Chilton, Thos. Esq.	5 0 0
Clazey, J. O. Esq.	5 0 0
Colling, Rev. J.	5 0 0
Corbett, V. W. Esq.	5 0 0
Ditchfield, S. J. Esq.	5 0 0
Elliot, Thos. Esq.	5 0 0
Eminson, J. B. Esq.	10 6 0
Lough, W. Esq.	5 0 0

Mann, Major.	10 6 0
North Hetton Coal Company.	2 2 0
Pallister, W. Esq.	10 6 0
Phillips, E. A. Esq.	10 0 0
Reid, Geo. Esq.	1 1 0
Scott, Rev. W. A.	5 0 0
Sheridan, W. Esq.	10 0 0
Smith, T. & W. Messrs.	1 1 0
Stratford, W. Esq.	5 0 0
The South Hetton Coal Company.	2 2 0
Thorman, Robt. Esq.	10 6 0
Turnbull, T. S., Esq.	5 0 0
Warham, William.	5 0 0
Watson, Kipling & Co. Messrs.	2 2 0
Woods & Co. Messrs.	1 1 0
Wright, H. B. Esq.	10 0 0
Young, Ehlers, & Co. Messrs.	2 2 0
Collecting Box	12 3 0
Collected from ships.	8 9 6
Total	£32 8 3

SEATON CAREW BRANCH.

Chairman—	
M. PEARSE, Esq.	
Treasurer—	
JOHN BAKEWELL, Esq.	
Honorary Secretary—	
REV. JOHN LAWSON, M.A.	
Annual Subscriptions.	
Eldon, The Earl of.	5 0 0
Appleby, Thos. Esq.	1 1 0
Backhouse, A. Esq.	1 0 0
Backhouse, E. Esq. (the late).	1 0 0
Backhouse, Edmund, Esq.	2 2 0
Bakewell, John, Esq.	1 1 0
Barclay, Mrs.	1 1 0
Boyne, Viscount.	3 3 0
Clarke, George, Esq.	1 1 0
Dale, David, Esq.	1 1 0
Dalton, Rev. C. W.	1 1 0
Dalton, Miss.	2 2 0
Fawcus, Henry, Esq.	2 2 0
Fawcus, Robt. Esq.	1 1 0
Fawcus, R. S. Esq.	1 1 0
Garbutt, E. W. Esq.	1 1 0
Hodgkins, J. B. Esq.	1 1 0
Hudson, T. S. Esq.	1 1 0
Hulton, W. R. L. Esq.	1 1 0
Ingilby, Lady Amcotts.	1 1 0
Kell, John, Esq.	1 1 0
Lawson, Professor.	1 1 0
Lawson, Rev. John.	2 2 0
Longbotham, J. Esq.	1 1 0
Lucas, Albert, Esq.	1 1 0
McIntire, Rev. T.	1 0 0
Michell, John J. Esq.	1 1 0
Mounsey, E. B. Esq.	1 1 0
Pearse, M. Esq.	1 1 0
Reay, Thomas M. Esq.	1 1 0
Rogers, Mrs. (late).	1 1 0
Surtees, W. Esq.	2 2 0
Swanson, W. Esq.	1 1 0
Tilly, Harry T. Esq.	1 1 0
Tone, Miss.	1 1 0
Vivian, Mrs.	1 1 0
Total	48 18 0
Donation.	
Dalton, General	1 1 0
Barometer Pillar	3 0 0
Life-boat House Box	14 0 0
Total	£50 16 0

SUNDERLAND AND WHITBURN BRANCH.

Chairman—	
ALDERMAN REED.	
Treasurer—	
J. C. FORRETT, Esq.	
Honorary Secretary—	
WILLIAM MILBURN, Esq.	
Annual Subscriptions.	
£. s. d.	
Alderson, C. Esq.	10 0 0
Alison, J. J. and W. H. Messrs.	1 0 0
Anderson, T. Esq.	1 0 0
Armstrong, Addison & Co. Messrs.	1 0 0
Anstin, S. P.	10 6 0
Backhouse and Co.	1 1 0
Barnes, T. Esq.	3 0 0
Blain, Thomas Esq.	10 6 0
Blumer and Co.	5 0 0
Booth, George R. Esq.	10 0 0
Bramwell and Co.	1 1 0
Briggs and Sons.	10 0 0
Christal, J. and Sons.	10 0 0
Clarke, George Esq.	1 1 0
Craven and Speeding.	1 0 0
Cross, John, per N.P. Bank, Sunderland Branch.	1 1 0
Davison, R. G. Esq.	5 0 0
Doxford, J. Esq.	10 0 0
Dunlop, Rev. R.	5 0 0
Durham, Right Hon. Earl of.	2 2 0
Elliot, Thomas, and Sons.	10 0 0
Fairley, T. W. and C.	7 6 0
Fairman, J. C.	5 0 0
Featherstonhaugh, A. W. and E.	10 0 0
Forster, John.	5 0 0
Friend.	5 0 0
Gayner, R. H.	1 1 0
Gowland, G.	10 6 0
Graham, John.	10 0 0
Graham, Mr. Henry.	5 0 0
Greives, J. W.	5 0 0
Grimshaw and Sons.	10 0 0
Harrison Brothers.	5 0 0
Harrison, T. E.	1 10 0
Harrison, W. B.	10 0 0
Hartley, James, Esq.	1 1 0
Hay, James.	5 0 0
Hill, J. G.	10 0 0
Hills, James.	5 0 0
Hills, John.	5 0 0
Hills, W. H.	5 0 0
Hitchcock, Rev. W.M.	2 2 0
Hodgson, Mrs.	10 0 0
Horan, James.	10 0 0
Hudson, R. & Sons.	10 0 0
Kayl, J. J.	10 6 0
Laing, James.	1 1 0
Lambton and Co.	1 1 0
Lumsdon, Byers, and Co.	1 1 0
Meier, C.W. and Co.	5 0 0
Modlin, T.	5 0 0
Morton, H. T.	10 6 0
Newbiggin, E. J.	5 0 0
Oliver, R.	10 0 0
Peckett, G. C.	5 0 0
Pemberton, R. L.	1 0 0
Porrett, R. B.	1 1 0
Potts, J. Jun.	1 1 0
Potts, R. H. & Bros.	1 0 0
Reay, T. J.	5 0 0
Reed, Alderman.	1 1 0
Ritson, Henry.	5 0 0
Ritson, John & Sons.	10 0 0
Robson, E. C. & Son.	10 0 0
Robson, W. W. and Sons.	5 0 0
Rutter, R. P.	5 0 0
Service and Phillips.	5 0 0
Sheraton, Richard.	5 0 0

BRANCHES—LIST OF ANNUAL SUBSCRIPTIONS AND DONATIONS. 111

	£.	s.	d.
Smith, Alexander...	10	0	
St. John, William...	1	1	0
Steel, Thomas.....	5	0	
Stobart, William....	10	0	
Thompson, Alder-			
man William.....	10	0	
Thompson, J. and H.			
H.....	10	0	
Thompson, John....	5	0	
Tone, William.....	10	0	
Tyzack, S.....	1	0	0
Vaux, Cuthbert.....	5	0	
Watson, George.....	10	0	
Watson, J. H.....	5	0	
Wayman, J. W.....	10	6	
Wiener, Martin.....	1	1	0
Williamson, Sir H.,			
Bart.....	4	0	0
Wilson, C. Stanley..	10	6	
Wilson, W. C.....	10	6	
Woods & Co.....	1	1	0
Woodcock, Mrs., In-			
terested on the legacy	2	19	0
Total.....	£61	4	6

WEST HARTLEPOOL BRANCH.

Chairman—
R. SCOTT, Esq., H.M.C.

Honorary Secretary—
C. A. BAKER, Esq.

Annual Subscriptions.

Subscriptions collected by Mr. Garthwaite during 1879, viz.:

Appleby, T. & Co.....	2	2	0
Cory, Lohden & Co.	1	1	0
East Coast Insurance Co.....	2	2	0
Fryer, E.....	5	0	0
Gray, W. & Co.....	2	2	0
Groves, Maclean & Co.....	1	1	0
Herskind, F.....	10	6	
Irvine, R. & Co.....	2	2	0
Lauder, R. & Co.....	10	6	
May & Hassell.....	1	0	0
Middleton & Co.....	1	1	0
Pease, J. W. & Partners.....	1	1	0
Pyman, George.....	2	2	0
Robinson, T.....	10	6	
Sadler, W.....	10	6	
Steam Navigation Co.	2	2	0
Turnbull, E.....	1	0	0
Withy, E.....	10	6	
Total.....	£21	13	6

Donations.

Sundry donations per H.M. Customs.....	16	5	6
Pillar Boxes.....	18	10	
Voluntary Tolls collected at the Dock Office.....	47	11	0
Total.....	£86	8	10

Essex.
CLACTON-ON-SEA BRANCH.

President—
Rev. HENRY LAW.

Chairman—
JAMES HARMAN, Esq.

Honorary Secretary—
Mr. FRED. J. NUNN.

Annual Subscriptions.

	£.	s.	d.
Agate, W.....	10	6	
Ager, George.....	10	6	
Baker, W. S.....	5	0	
Bawtree, Octavius, Esq.....	1	1	0
Bland, W.....	1	1	0
Chambers, George..	10	6	
Chapman, James....	10	6	
Cortauld, Samuel, Esq.	1	1	0
Cox, J.....	10	6	
Ellis, J.....	10	6	
Fowler, J. T.....	10	6	
Harman, Jauce.....	1	1	0
Harman & Mathews	10	6	
Hayes, T. D.....	10	6	
Hudson, Matthews, Lopez, and Co.....	3	3	0
Jackson, W. P.....	10	6	
Law, Rev. Henry....	2	2	0
Law, Mrs.....	1	1	0
Macbride Crofts, Rev. J. D.....	1	1	0
Main, W.....	10	6	
Mann, Fred.....	10	6	
Mitchell, James....	10	6	
Newman, Rev. T. Harding, D.D.....	1	1	0
Nichols, F. M. Esq. J. P.....	1	1	0
Nunn, F. J.....	5	0	
Osborne, A. T.....	10	6	
Page, Henry James.	1	1	0
Penfold, A.....	10	6	
Phillips, J.....	2	6	
Reynolds, Burford, and Co.....	10	6	
Round, James, Esq. M. P.....	1	1	0
Rutherford, W.....	5	0	
Smith, J.....	10	6	
Tabrum and Jones..	10	6	
Topp, J.....	10	6	
Vincent, W. T.....	5	0	
Walton and Atwood	1	1	0
Total.....	27	18	0

HARWICH BRANCH.

President—
EDGAR WALTER GARLAND, Esq., High Steward of the Borough of Harwich.

Chairman—
J. R. FRANKS, Esq.

Honorary Secretary—
Mr. A. P. BRAY.

Annual Subscriptions.

Barnes, It. S. Esq....	10	0	
Bevan, Mr. C. F.....	10	0	
Brady, H.....	1	0	0
Burmeister, Rev. G. and Family.....	2	0	0
Cartlingford, Lord	2	0	0
Cottingham, F.....	10	0	
Eley, Chas. Esq.....	1	0	0
Franks, J. R.....	10	0	
Garland, E. W. Esq.	10	0	
Groom, W. Esq.....	10	0	
Grice, Mr. J. J.....	10	0	

	£.	s.	d.
Hammond, Misses...	10	0	
Jackson, G. L.....	2	6	
Marsden, Canon....	1	1	0
Nichols, F. M. Esq..	2	0	0
Nalborough, W. J..	10	6	
Patrick and Son, Messrs.....	1	1	0
Tomline, Colonel...	5	0	0
Tyler, Sir Henry....	1	0	0
Vaux, J. H. Esq.....	10	0	
Watson, T. C. Esq..	1	1	0
Watts, John, Esq....	10	0	
Worts, Mr. A.....	10	0	
Total.....	£32	15	6

Donations.

Mrs. Berners.....	5	0	0
Contribution Boxes at railway station, per Mr. Sanders....	9	1	
Do. at Messrs. Groom & Sons.....	2	5	
Do. at boathouse....	4	10	11
Do. at Custom House, per Mr. J. W. Wood.....	1	11	3
Do. on board G. E. R. steamers, per Capt. Howard.....	2	10	10
Total Dons.....	14	4	6
Total Subs.....	32	15	6
Total.....	£47	0	0

SOUTHEND BRANCH.

Chairman—
Rev. F. THACKERAY.

Honorary Secretary—
Wm. GREGSON, Esq.

Annual Subscriptions.

Beard, Mr.....	10	0	
Bell, Miss L.....	10	6	
Browne, Rev. R. C..	5	0	
Davies, Mrs.....	5	0	
Dettmar, Mr.....	10	0	
Dettmar, Miss.....	5	0	
Dettmar, Miss May.	5	0	
Dowsett, Mr.....	10	0	
Dyer, Mrs.....	1	1	0
Layard, Rev.....	10	6	
Merritt, Mr.....	10	0	
Richmond, Mr.....	10	0	
Smith, Mr. T.....	10	6	
Swaine, Mrs. G.....	10	0	
Verrall, Mr.....	10	0	
Wilnot, Rev.....	10	0	
Wood, Mr. F.....	1	1	0
Woodsman, Mr.....	10	6	
Total.....	9	4	0

Donations.

Bateman, Rev. J....	1	0	0
Baker, Mrs.....	1	0	0
Keightley, Rev.....	10	0	
Total.....	£11	14	0

Flintshire.
RHYL BRANCH.

President—
R. BAMFORD HESKETH, Esq.

Chairman—
T. GRIFFIES DIXON, Esq.

Treasurers—
NORTH AND SOUTH WALES BANK.

Honorary Secretary—
Mr. ROBERT HUGHES.

Annual Subscriptions.

	£.	s.	d.
Buddicom, W. B. Esq. (2 years).....	4	0	0
Butterton, Rev. G. A., D.D.....	10	0	
Churton, John, Esq. (2 years).....	1	0	0
Conwy, Major Conwy Rowley.....	5	0	0
Dawson, John, Esq. (2 years).....	2	2	0
De Broke, Lady Wiloughby.....	2	0	0
Dixon, T. Griffies, Esq.....	2	2	0
Fuller, Mrs. (2 years)	2	2	0
Gladstone, Rev. S. E.	1	0	0
Hesketh, R. Bamford, Esq. (2 years).....	10	0	0
Hughes, H. R. Esq. Kimmel (2 years).....	10	0	0
Johnson, G. Esq. (2 years).....	10	0	0
Jones, Mrs. E. Olinda (2 years).....	2	2	0
Jones, W. Price, Esq.	10	6	
Jones, Mrs. Price....	10	6	
Luxmoore, Miss (the late).....	1	1	0
Mainwaring, T. Esq.	5	0	0
Mountfield, W. B. Esq.	10	6	
Penn, Major.....	10	6	
Pennant, P. P. Esq. (3 years).....	3	0	0
Richardson, Rev. T. M. A.....	10	0	
Roberts, J. Esq. M. P.	1	1	0
Roberts, R. Price, Esq. (2 years).....	2	0	0
Sisson, R. J. Esq....	1	1	0
Sneyd, Miss.....	1	0	0
St. Asaph, Dean of	1	0	0
Wilkin, W. Esq.....	1	1	0
Winston, Thos. Esq.	1	1	0
Wynn, Mrs. Wms..	1	1	0
Yorke, P. W. Esq....	2	0	0
Total.....	65	6	0

Donations.

Girdlestone, Dr.....	10	0	
Boxes:—			
Belvoir Hotel....	14	0	
Clarke's Ford.....	8	4	
Dudley Hotel.....	4		
Northampton do..	1	7	
Mona do.....	7		
Parade Pillar Box	3	18	10
Pier Refreshment Rooms.....	7	2	
Queen's Hotel.....	19	0	
Koyal Hotel.....	2	6	
Sun Hotel.....	5	0	
Ye Windsor.....	3	4	
Westminster Hotel	11	5	
Total Dons.....	8	2	1
Total Subs.....	65	6	0
Total.....	£73	8	1

Glamorganshire.

PENARTH BRANCH.

Patron— C. R. M. TALBOT, Esq. M.P. Chairman— Colonel E. S. HILL. Treasurer— JAS. EDWARDS, Esq. Penarth. Honorary Secretary— Commander W. M. PENGELLEY, H.M.'s late Indian Navy.

Subscriptions for 1879.

Table of subscriptions for 1879 in Glamorganshire, Penarth Branch. Lists names and amounts in £, s, d. Includes Aberdare Coal Co., Adams, Wilson, and Co., Alexander, Mr. D. T., etc.

Table of subscriptions for 1879 in Glamorganshire, Penarth Branch (continued). Lists names and amounts in £, s, d. Includes Ogden, Mr. W. S., Page & Co., Messrs., Parry Bros., etc.

PORHCRAWL BRANCH.

Patron— C. R. M. TALBOT, Esq. M.P. President— J. C. NICHOLL, Esq. Honorary Secretary— Rev. W. JONES. Annual Subscriptions. Brogden, James, Esq. 1 1 0 Bute, Marquis of ... 5 0 0

Gloucestershire.

BRISTOL BRANCH.

Chairman— M. WHITWILL, Esq. Honorary Secretary— Capt. HUTCHINS. Collector— Mr. Z. JONES, 19 College Green.

Annual Subscriptions.

Table of annual subscriptions for Bristol Branch in Gloucestershire. Lists names and amounts in £, s, d. Includes Bligh, Mrs. R., Bush, J. and R., Butterworth, McArthur & Co., etc.

SWANSEA BRANCH.

Honorary Secretary— T. W. ISLAY YOUNG, Esq.

Annual Subscriptions.

Table of annual subscriptions for Swansea Branch. Lists names and amounts in £, s, d. Includes Bath, Henry & Son, Biddulph, J., Brewery Co., etc.

Donations.

Table of donations for Swansea Branch. Lists names and amounts in £, s, d. Includes Bristol Marine Association, Custom House, Hascocks, R., etc.

Total Dona. 26 4 8 Total Subs. 39 0 6

CHELtenham BRANCH.

Collector— Mr. W. WITCHELL.

Annual Subscriptions.

Table of annual subscriptions for Cheltenham Branch. Lists names and amounts in £, s, d. Includes Bell, W. E. Esq., Busfield, Mrs., Dandridge, Mrs. (the late), etc.

DOVER BRANCH.

Chairman— Major SCOTT.
Honorary Secretary— Lieut.-Gen. BRUCE, C.B.
Annual Subscriptions.
Austen, Mr. 5 0
Ayers, Mr. 5 0
Back, Mr. 5 0
Baird, Dr. 5 0
Barnard 5 0
Boyle, the Ladies 5 0
Bradley Brothers 10 0
Bruce, Capt. R.N. 5 0
Cannon, Capt. 10 0
Court, P. S. Esq. 10 0
Cow, Capt. 5 0
Crosby, Mrs. 1 0
Finnis, S. Esq. 5 0
Flashman, Mr. 5 0
Graves, — 5 0
Goren, James, Esq. 1 1 0
Goren, James N. Esq. 1 1 0
Hayward, — Esq. 5 0
Hills, Mr. 5 0
Hyde, W. Esq. 5 0
Igglesden, Mr. B. A. 5 0
Iron, R. Esq. 5 0
Joyce, Messrs. 5 0
Marsh, Cullen 10 0
Morgan, E. D. Esq. 1 0
Pearce, Rev. B. 1 0
Rose, Miss. 1 1 0
Schuyott, N. Esq. 5 0
Scott, Major 1 0
Sisco, Mr. 5 0
Smitheth, Capt. W. 10 0
Stillwell, J. Esq. 5 0
Stuart, G. Esq. 1 1 0
Warsford, — Esq. 5 0
Wilson, Mr. 5 0
Wissenden, Miss E. S. 10 0
Wrighton, Mr. 5 0
Sums under 5s. 12 6
Total 17 11 6
Donations.
Collecting Boxes 9 7 6
£26 19 0

GOODWIN SANDS AND DOWNS BRANCH.

Patrons— The Right Hon. the EARL GRANVILLE, K.G., P.C. SIR WALTER JAMES, BART.
Chairman— Capt. G. DOUGLAS, R.N.
Treasurer and Hon. Sec.— Captain SANCTUARY, R.N.
Local Hon. Secretary at Kingsdown— Mr. W. BAILEY.
NORTH DEAL LIFE-BOAT.
Annual Subscriptions.
A Friend, per J. Henderson, Esq. 1 0 0
Chennell, F. A. Esq. 10 6
Cinque Ports Pilots, 30 Subs. under 5s. 3 10 0
Clanwilliam, Earl of 2 0 0
Cullen and Son Messrs. 5 0
Darby, Mrs. 5 0
Edwards, J. B. Esq. 5 0
Frost Bros., Messrs. 10 0
Griffith, Rev. T. Ll. 10 6

Hammond and Co. Messrs. G. 10 6
Harvey, J. J. Esq. 10 6
Henderson, J. Esq. 10 6
Hilton, Dr. 1 0 0
Hulke, Dr. 10 6
Iggulden, John, Esq. 1 0 0
James, Sir W. C. Bart. 3 3 0
Kemball, J. B. 10 0
Laplough, H. Esq. 10 0
Morris, Mrs. 1 1 0
Nethersole, Jno. Esq. 10 6
Pitcock, Mr. W. 10 0
Roope, T. Esq. 10 6
Watt, Miss 5 0
Wood, H. D. Esq. 10 0
Donations.
Bray, Miss. 1 0 0
Hicks, G. M. Esq. (1880) 31 10 0

WALMER LIFE-BOAT.

Annual Subscriptions.
Granville, Earl, K.G. P.C. 5 0 0
A Lady, per J. Hurebosch 1 0 0
Benson, Rev. E. W. 10 6
Boys, T. S. Esq. 1 0 0
Brassey, H. Esq. M.P. 5 5 0
Brooke, Miss 15 0
Bushe, Capt. R.N. 10 0
Cannon, Vice-Adm. E. St. Leger 1 10 0
Cullen and Sons, Messrs. 5 0
Douglas, Capt. J. 10 0
Douthie, Miss 10 0
Elliott, Rev. E. 1 1 0
Fisher, The Misses 5 0
Friend, per J. Henderson 1 0 0
Green, A. Esq. 1 0 0
Griffith, Rev. T. Ll. 10 0
Halse, Miss 5 0
Harvey, Vice-Adm. 1 0 0
Hill, Miss 1 0 0
Hilton, Rev. G. S. 1 0 0
Huggesen, Knatchbull Esq., M.P. 1 0 0
James, Sir W. Bart. 2 0 0
Kemball, J. B. 10 0
Kenrick, Mrs. 1 0 0
Monins, Mrs. 5 0
Nethersole, Mr. W. 5 0
Samler, Mrs. 5 0
Simpson, Miss. 10 0
Smith, Arbur, Esq. 1 0 0
Thompson and Sons, Messrs. 1 0 0
Watt, Miss 5 0
Woodruffe, Mrs. 1 1 0
Total £86 6 0

HYPHE, SANDGATE, AND FOLKESTONE BRANCH.

Chairman— Capt. G. USBORNE, R.N.
Treasurer— J. R. DAVY, Esq., N. P. Bank, Folkestone.
Honorary Secretary— GEORGE WILKS, Esq., Hythe.
Annual Subscriptions.
Andrews, J. B. Esq. 10 0
Ashdown, Mr. Ed. 5 0
Barton, Mrs. 5 0
Beall, W. L. 10 0
Bligh, Lady 10 0
Brockman, F. Esq. 1 1 0

Burden, Mrs. 5 0
Cobb, Mr. J. V. 5 0
Cobb, Thomas, Esq. 5 0
Davy, J. R. Esq. 5 0
Deedes, Major 5 0
Deedes, William, Esq. 1 0 0
Du Boulay, J. Esq. 10 6
Edwards, J. B. Esq. 10 6
Fitness, John, Esq. 10 6
Godden, Mr. Stephen 5 0
Hankey, General 1 0 0
Harrison, W.G.S. Esq. 10 6
Hart, Miss. 5 0
Holden, Mr. 10 0
Jenkins, Rev. Canon 10 6
Jones, Captain 10 6
Jones, Rev. J. 5 0
Kingsford, K. Esq. 10 6
Kirkpatrick, Major 10 6
Lonsdale, J. Esq. 10 6
Mackeson, H. B. Esq. 10 6
Morton, Major 5 0
Nelson, John, Esq. 10 6
Ovenden, Mr. George 5 0
Pledge, W. Esq. 10 6
Rigden, Mr. R. 10 6
Russell, G. Esq. 10 6
Sampson, Mrs. 10 0
Sherwood, John, Esq. 10 6
Shipwash, Mr. E. 5 0
Shuttleworth, W. S. Esq. 10 6
Side, Mrs. 10 6
Smith, W. S. Esq. 5 0
Thompson, Robert, Esq. 5 0
Tolputt, Mr. J. B. 10 6
Tournay, Tournay W. Esq. 1 1 0
Usborne, Capt. G., R.N. 10 0
Walton, Mr. E. C. 5 0
Ward, Rev. V. 5 0
Watkin, Sir E. M.P. 10 6
Wildash, Dr. 10 6
Wilks, George, Esq. 10 6
Williamson, Rev. 10 6
Wilson, Rev. 5 0
Wilson, Mr. William 5 0
Sums under 5s. 3 8 6
Total £26 16 6

KINGSGATE BRANCH.

Honorary Secretary— Capt. ISACKE, H.C.S.
Annual Subscriptions.
His Grace the Archbishop of Canterbury 1 1 0
Alexander, C. Esq. 2 2 0
Cotton, Mrs. 1 0 0
Edmeades, Rev. W.H. 1 1 0
Fearon, Capt. 1 0 0
Hannam, G. E. Esq. 10 0
Harris, T. N. Esq. 1 1 0
Hodgson, Rev. J. G. 1 1 0
Isacke, Capt. H.C.S. 1 0 0
Levy, Jonas, Esq. 5 0 0
Metcalfe, Col. C.B. 1 1 0
Rammell, Mr. G. 5 0 0
Scott, Mrs. 10 6
Webb, Major 10 0
Whish, G. T. 1 1 0
Whish, Mrs G. T. 1 1 0
Whitehead, Rev. A. 10 0
Total 19 14 6
Donations.
Pillar Boxes (1879) 4 5 1
£23 19 7

LYDD DUNGENESS BRANCH.

Chairman— ALURED DENNE, Esq., D.L.
Honorary Secretary— E. T. BASS, Esq., J.P.
Annual Subscriptions.
Bartholomew, Mrs. William 1 1 0
Bass, E. T. Esq. 10 0
Blacklocks, Mr. J. 5 0
Blacklocks, Mr. Wm. 10 0
Burra, James, Esq. 10 0
Burton, Rev. Chancellor. 2 0 0
Denne, Alured, Esq. 10 0
Denne, Col. R.H.A. 1 0 0
Finn, Mr. Edwin 10 0
Finn, Thomas, Esq. 10 0
Finn, Mrs. George. 5 0
Finn, Miss Mary 5 0
Howson, Miss. 5 0
Prescott, Mr. Wm. 5 0
Procter, J. C. Esq. 10 0
Selmess, Messrs. 10 0
White, Mrs. C. 5 0
Wingate, Rev. W.C.L. 10 0
Wood, Field, & Hanbury, Messrs. 1 0 0
Young, E. D., Esq. R.N. 10 0
Total £11 11 0
Donations.
Collecting Boxes 1 1 7
Collected on board Allon Tower 2 1 0
£14 13 7

MARGATE BRANCH.

Chairman— J. T. FRIEND, Esq., J.P.
Honorary Secretary— EGERTON ISAACSON, Esq.
Annual Subscriptions.
Akhurst, Mr. G. H. 5 0
Andrews, Mrs. O. 5 0
Bayly, Mr. John. 5 0
Bentley, Messrs. D. and W. and Son 5 0
Bower, W. G. Esq. 10 6
Bouden, Rev. A. W., M.A. 10 0
Bradley, Mrs. 5 0
Carroway, Mr. John 5 0
Chancellor, Mr. S. S. 5 0
Chapman, Mr. F. 5 0
Chubb, Mr. J. F. (1878-79) 10 0
Cobb, A. B. Esq. 10 0
Cobb, F. C. Esq. 1 0 0
Cobb, T. F. Esq. 1 0 0
Cotton, H. H. P. Esq. 1 0 0
Crawford & Co. Messrs. 1 0 0
Cutlack, R. and A. 5 0
Darby, Mr. W. 5 0
Davis, Mrs. 5 0
Dentry, James, Esq. 10 0
Dering, Sir E. C. Bart. 2 2 0
Edgar, Miss E. 10 0
Emptage, Mr. D. 5 0
Eveling, Mr. M. 10 6
Fagg, Mr. W. A. 5 0
Ford-Kelcey, Geo., Esq. 10 6
Franklin, Mr. T. 5 0
Friend, J. T. Esq. 1 0 0
Galindo, Miss 5 0
Goodyear, Mr. T. 5 0
Gray, Mr. W. G. 5 0

BRANCHES—LIST OF ANNUAL SUBSCRIPTIONS AND DONATIONS. 115

Table listing subscriptions for the NEW ROMNEY BRANCH. Columns include names (e.g., Green, Walter, Esq.), amounts (£, s., d.), and a total of £57 3 2.

NEW ROMNEY BRANCH.

Chairman— Captain COBB, R.N. Honorary Secretary— HENRY STRINGER, Esq. Annual Subscriptions.

Table listing individual subscriptions for the NEW ROMNEY BRANCH with names and amounts, totaling £18 12 10.

PORT OF ROCHESTER BRANCH.

President— His Worship the MAYOR. Honorary Secretary— Mr. J. H. CROCKFORD.

Table listing individual subscriptions for the PORT OF ROCHESTER BRANCH, including names like Aldridge, Mr. W., and a total of £13 0 6.

Table listing subscriptions for County Chatham Branch, including names like Do. Old Manor House and amounts.

£17 1 10

Lancashire. BLACKBURN BRANCH.

President— His Worship the MAYOR. Treasurer— J. S. POLLITT, Esq., Manchester and County Bank.

Honorary Secretary— JOSEPH BRIERLEY, Esq. C.E. Donations and Subscriptions.

Table listing individual subscriptions for the BLACKBURN BRANCH, including names like Appleby and Son and amounts, totaling £3 2 6.

BLACKPOOL BRANCH.

Chairman— T. McNAUGHTAN, Esq., M.D., Mayor. Treasurer— J. PICKOP, Esq.

Honorary Secretary— A. M. VIENER, Esq. Annual Subscriptions.

Table listing individual subscriptions for the BLACKPOOL BRANCH, including names like Aspinwall, Miss and amounts, totaling £10 0 0.

Table listing subscriptions for Sharples, Mr. George and other names, totaling £26 19 6.

Table listing late Miss Mellett's contribution of £100 0 0 and a total of £126 19 6.

BOLTON BRANCH.

Chairman— HENRY MARRIOTT RICHARDSON, Esq., Mayor of Bolton. Honorary Secretary— THOMAS H. WINDER, Esq.

Table listing individual subscriptions for the BOLTON BRANCH, including names like Abbott, Mr. Wm., and amounts, totaling £10 0 0.

Table with columns £. s. d. containing names and amounts like Walsley, T. Esq. J.P., Wilkinson, Mr. T., Winder, R. and T. H., Winkworth, S. Esq., J.P., Total 51 1 6

Table with columns £13 2 containing Donations, Box in Free Library - 11 8, £51 13 2

FLEETWOOD BRANCH.

Table containing Patron—F. KEMP, Esq., J.P.; Chairman—J. WIGNALL, Esq.; Treasurer—THOS. DREWRY; Honorary Secretary—REV. H. LINGS; Annual Subscriptions with names and amounts

Table with columns £. s. d. containing names and amounts like Turner, Mr. Philip, Warbrick, Mr. Richard, Ward, Mr. John, Wignall, Mr. John, Total 60 19 0

Table with columns £. s. d. containing Donations, Fine in condonation of a Game Trespass, Rev. Herbert A. James, B.D., Offer-tory at Rossall School, Soldiers of the 31st Regiment, per H. Lings, Mr. James Bennett, Mrs. Elizabeth Aldred, Small Sums, Total Dons 25 3 3, Total Subs. 60 19 0, £86 2 3

Table with columns £. s. d. containing Boats, Steamers, Customs, Life-boat House, Whitworth Institute, Total Dons 25 3 3, Total Subs. 60 19 0, £86 2 3

LANCASTER BRANCH.

Table containing President—Lieut.-Col. GREENE; Honorary Treasurer—J. C. MOON, Esq.; Honorary Secretary—M. SIMPSON, Esq.; Annual Subscriptions with names and amounts

Table with columns £. s. d. containing names and amounts like Dickinson, John, Diggins, James, Dixon, Miss., Donaldson, J. H., London, Eastwood, L., Edmondson, T. Lon-don, Edmondson, Mrs. do., Fielding, Mrs., Ford, A., Ford, W., Friend, A., Greene, Lieut.-Col. T., Greene, Rev. T. H., Greene, T. P., Greg, Albert, Greg, John, Hadwen, H., Hall, Dr., Hall, Richard, Hall, S., Harris, S. J., Harrison, J. S. (late), Hatch, James, Hathornthwaite, Rev. Dr., Hinde, Misses, Hodgson, Thomas, Hornby, Mrs., Howitt, Thomas, Jackson, George, Jackson, Edmund, Johnson, C., Johnson, Dr., Lancaster Quay Com-missioners, Lancaster Banking Co., Langshawe, Mrs., Leeming, Miss., Leeming, Mrs. Joha, Leeming, R., Lewtas, James, Lowndes, Miss, Lowndes, Miss Kate, Macnicol, Miss., Mansergh, R., Masonic Lodge of Fortitude, 281., Maxsted, G. W., Moon, J. C., Moon, Jas. London, Moon, Geo. London, Moore, Dr., Moser, R. P., Moss, W. E., Noon, Mrs., Old Woman, Ormrod, Mrs., Paget, Miss, Parker, James, Parr, H. W., Peacock, Mrs., Pedder, Rev. E., Peebles, Mrs., Pritt, Rev. F. D., Pritt, Mrs., Procter, W., Pryke, Rev. W. E., Ripley, Mrs., Roper, W., Rothwell, Miss., Royds, Rev. C. T., Royds, Mrs., Heysham Cottage., Saunders, C. M., Seward, Abram., Sharp, Jno. (the late), Sherson, Miss, Simpson, M., Smalley, R., Smith, Joseph, Starkie, J. P. C. M.P., Storey, Edward., Storey, J., Storey, Thos., Storey, Wm. (late), Swainson, Thos., Swainson, W., Sykes & Co., Liver-pool., Taylor, Messrs. R. & J.

Table with columns £. s. d. containing names and amounts like Threlfall, Misses, Townley, Miss, Townley, John, Southport., Tunstall, Mrs., Walker, J., Walker, Rev. Canon, Watson, J., Wearing, S. W., Welch, W. G., Welch, Misses, Whimpray, J., Williamson, Jas., Woods, Mrs., Wright, Mrs., Total 110 7 6

Table with columns £132 12 5 containing Donations, Bank interest, Paget, Miss, Seward, A. C. (Model Life-boat), Sherson, Mrs. (late), St. Anne's Church, Moiey of Offering at., St. John's Church, Moiey of Collection at Harvest Festi-val., Total Dons 22 4 11, Total Subs. 110 7 6, £132 12 5

LIVERPOOL & NEW BRIGHTON BRANCH.

Table containing Chairman—A. BOWEN, Esq.; Treasurer—HAROLD L. BOWER, Esq.; Hon. Secretary at Liverpool—CHARLES H. BELOE, Esq.; Hon. Sec. at New Brighton—J. L. C. HAMILTON, Esq.; Assistant Secretaries—MR. MATTHEW HENDRIE, MR. JOHN COLE; Annual Subscriptions with names and amounts

BRANCASTER BRANCH.

President— The Earl of ORFORD.

Chairman— SIMMS REEV, Esq.

Honorary Secretaries— Rev. E. K. KERSLAKE. E. DEWING, Esq.

Table with columns for names and amounts (£. s. d.). Includes Bircham, Mr. B., Calver, Mr. Henry, Cook, Mr. Dennis, etc.

Total.....£36 2 0

CROMER BRANCH.

Chairman— Right Hon. LORD SUFFIELD.

Honorary Secretary— Mr. W. G. SANDFORD.

Annual Subscriptions.

Table with columns for names and amounts (£. s. d.). Includes The Right Hon. Lord Suffield, Barclay, R. Esq., Birkbeck, Edward, etc.

Total.....£24 17 6

HASBOROUGH BRANCH.

President— R. S. BAKER, Esq.

Honorary Secretary— Rev. J. SLATER, M.A.

Annual Subscriptions.

Table with columns for names and amounts (£. s. d.). Includes Baker, R. S. Esq., Birkbeck, Edward, Faulke, Mr., etc.

Total.....£14 7 0

HUNSTANTON BRANCH.

President— H. LE STRANGE, Esq.

Honorary Secretary— Rev. A. WALLER.

Annual Subscriptions.

Table with columns for names and amounts (£. s. d.). Includes Ainslie, Miss., Beckett, Rev. W. T., Beckett, Miss., etc.

Table with columns for names and amounts (£. s. d.). Includes Wells, R. Esq., Wharton, Mr. L., Whitmore, G. Esq., etc.

Total..... 45 5 0

Table with columns for Donations. Includes Boxes, &c. - 12 0, £45 17 0

KING'S LYNN BRANCH.

Treasurer— F. J. CRESSWELL, Esq.

Honorary Secretary— Mr. WILLIAM HITCHCOCK.

Annual Subscriptions.

Table with columns for names and amounts (£. s. d.). Includes Archer, T. G. Esq., Bagge, T. E. Esq., Bird, Mr. J. M., etc.

Total.....31 9 0

Table with columns for Donations. Includes Cresswell, F. J. Esq., Boat..... 2 5 0, Messrs. Laws and Co.'s Boat..... - 11 3

Total Dons. 3 2 8

Total Subs.31 9 0

£34 11 8

MUNDESLEY BRANCH.

Chairman— Sir H. ROBINSON. Honorary Secretary— Mr. G. GORDON.

Annual Subscriptions.

Table with columns for names and amounts (£. s. d.). Includes Athill, Mrs., Atkinson, C. Esq., Back, Mr. P., Barcham, T. Esq., etc.

Total30 5 0

Donations.

Table with columns for names and amounts (£. s. d.). Includes Taylor, Rev. A., Tipping, Mr., Wild, Mr. E., etc.

£30 13 5

PALLING BRANCH.

Honorary Secretary—
Mr. E. FRENCH,
Chief Officer of Coastguard.
Annual Subscription.
£. s. d.
Birkbeck, Edward,
Esq., M.P. 5 5 0

SHERINGHAM BRANCH.

Chairman—
HENRY R. UPCRER, Esq.
Honorary Secretary—
Rev. L. MOORE, M.A.
Annual Subscriptions.
Barclay Gurney, Esq. 5 0 0
Birkbeck, Edward,
Esq., M.P. 5 5 0
Buxton, Sir Fowell . . . 2 2 0
Duncan, Miss 5 0 0
Hoare, Joseph, Esq., . . . 1 1 0

Total 18 8 0

Donation.
Lord Orford 5 0 0

£23 8 0

WELLS BRANCH.

Patron and President—
The Right Hon.
The EARL OF LEICESTER.
Honorary Secretary—
Mr. F. B. SOUTHGATE.
Annual Subscriptions.
Bellett, Lieut. E. T. . . . 10 0 0
Birkbeck, Edward,
Esq., M.P. 5 5 0
Bygott, —, Esq. 10 0 0
Chad, J. Scott, Esq. . . . 1 0 0
Dewing, Herbert Esq. . . . 5 0 0
Doggitt, J. R. Esq. . . . 10 0 0
Dugmore, J. Esq. . . . 1 1 0
England, R. Esq., J.P. . . . 10 0 0
Everitt, G. Esq. . . . 5 0 0
Everitt, J. Esq. . . . 5 0 0
Foot, Dr. 10 0 0
Gurney & Co. Messrs. 2 0 0
Hudson, Wm. Esq. . . . 5 0 0
Jones, Rev. H. . . . 1 0 0
Lacon, Sir E. Bart. . . . 3 0 0
Leicester, Earl of . . . 5 0 0
Mack, J. 5 0 0
Marriott, Messrs. J.
and R. 1 1 0
Middleton, C. Esq. . . . 10 0 0
Middleton, E. P. Esq. . . . 10 0 0
Rippingall, W. Esq. . . . 1 0 0
Shelabear, S. Esq. . . . 1 0 0
Smith, Messrs. F. & G. . . 2 0 0
Southgate, F. B. . . . 5 0 0
Warner, H. Lee, Esq. . . 1 0 0
Sums under 5s. 10 0 0

Total 29 19 0

Donations.
Boxes at Life-boat
House, Hotels, &c. . . . 15 9

£30 14 9

WINTERTON BRANCH.

Honorary Secretary—
Rev. W. GREEN, M.A.
Annual Subscriptions.
£. s. d.
Birkbeck, Edward,
Esq., M.P. 10 10 0
Copeman, Mrs. 1 0 0
Green, Rev. W. 1 1 0
Harden, Rev. H. W. . . . 10 0 0
Mrs. Hume 2 2 0
Lucas, Rev. Charles. 2 2 0
Lucas, Rev. G. J. . . . 1 1 0
Nelson, H. G. Esq. . . . 10 0 0
Rising, Robert, Esq. . . . 1 0 0
Waters, Wm. Esq. . . . 10 0 0

Total £20 6 0

GREAT YARMOUTH AND CAISTER BRANCH.

Chairman—
Wm. WOZSHIP, Esq.
Honorary Secretaries—
Rev. E. G. H. MURRELL, M.A.
Mr. JOHN PETTS.
Annual Subscriptions.
Aldred, C. C. Esq. . . . 10 6
Beeching Brothers. . . . 2 2 0
Bracey, J. Esq. 10 0 0
Burton, H. E. Esq. . . . 1 0 0
Dugmore, Mrs. 1 1 0
Fellows, J. H. Esq. . . . 10 0 0
Ferrier & Co. 10 0 0
Galnays & Co. 2 2 0
Purgrave, R.H.I. Esq. . . . 10 0 0
Shingles, G. S. Esq. . . . 10 6
Steward, T. Burton . . . 10 6
Venables, Rev. G. . . . 10 6
Walpole, R.H.V. Esq. . . 1 1 0
Walpole, Mrs. R.H.V. . . 1 1 0
Watling, R. S. Esq. . . . 1 1 0
Woolverton, C. 10 6
Worship, W. Esq. . . . 1 1 0

Total 15 1 6

Donations.
Bellamy, C. Esq. . . . 10 0
Captain Thorp, Offi-
cers and Crew,
Trinity steamer
Beacon 2 2 0
Collection at St.
John's Church, by
the Rev. A. J.
Spencer 3 12 3
Collected by Messrs.
Turrell and Tor-
kildsen 5 18 6
Collecting Boxes. . . . 19 10 10
Messrs. Squirell and
Utting 2 2 0

Total 33 15 7

Legacies.
Chadd, Mrs. M. S.
(the late) 19 19 0
Morley, Mrs. Mary
(the late) 3 15 9

Total Legacies 23 14 9
Total Dons. 33 15 7
Total Subs. 15 1 6

£72 11 10

Northamptonshire.

NORTHAMPTON BRANCH.

Chairman—
Rev. S. J. W. SANDERS, M.A.
Treasurer—
A. KEMPSON, Esq.
Collector—
Mr. E. LAW.
Annual Subscriptions.
£. s. d.
Aris, Mr. Thos. 1 1 0
Barnes, Mr. T. R. . . . 10 6
Barry, Mr. Jas. 1 0 0
Becke, Mr. John. . . . 10 0
Blencowe, Mrs. C. . . . 1 0 0
Bohem, Mr. M. A. . . . 5 0
Bostock, Mr. F. 10 0
Chandler, Mr. H. P. . . . 10 0
Chapman, Mr. Thos.,
the late. 10 0
Clifton, Mr. A. C. . . . 1 1 0
Grafton, Duke of 1 0 0
Hensman, Mr. H. P. . . . 10 0
Hosleden, Mr. B. . . . 5 0
Hill, Mr. W. 1 1 0
Hollis, Capt. 5 0
Jeffery, Mr. W. 5 0
Kempson, Mr. A. . . . 1 1 0
Kenning, Mr. C. 1 1 0
Law, Mr. E. F. 10 6
Law, Mr. W. A. 5 0
McKinnell, Mr. W. . . . 5 0
Osborn, Mr. G. 5 0
Osborn, Mr. Thos. . . . 5 0
Page, Mr. A. 5 0
Peirce, Mr. W. J. . . . 5 0
Perry, Mr. P. P. . . . 5 0
Phipps, Mr. J. 10 0
Phipps, Mr. P. 1 1 0
Phipps, Mr. W. 10 0
Portal, Mr. W. T. . . . 1 1 0
Robinson, Mr. J. . . . 10 6
Rust, Mr. B. 10 0
Sanders, Rev. S. J. W. . . 1 0 0
Saul, W. and Son,
Messrs. 5 0
Scriven, Mr. T. 5 0
Sheffield, Mr. D. . . . 10 6
Shipman, Mr. L. . . . 2 2 0
Shipman, Mr. W. . . . 1 1 0
Shoosmith, Mr. W. . . . 10 0
Spoor & Son. 5 0
Stanton, Mr. J. U. . . . 5 0
Turner Bros., Messrs. . . 10 6
Vernon, Mr. J. M. . . . 5 0
Walker, Mr. W. 10 6
Ward, Mr. H. W. . . . 5 0
Wilson, Mr. John 5 0

Total £26 13 0

Northumberland.

ALNMOUTH BRANCH.

Chairman—
Rev. E. L. MARRETT, Vicar.
Honorary Secretary—
H. SMITH, Esq.
Annual Subscriptions.
£. s. d.
Northumberland, The
Duke of 2 0 0
Armstrong, Sir W. G.
Kt. C.B. 1 1 0
Blair, Mr. H. Hunter . . . 5 0

£. s. d.
Browne, A. H. Esq. . . . 1 0 0
Browne, Major 1 0 0
Burrell, Bryan, Esq. . . . 10 0
Buston, R. Esq. 10 0
Cadogan, C. H. Esq. . . . 1 0 0
Chrisp, L. C. Esq. . . . 1 0 0
Crewe, Lord, Trustee of 1 1 0
Dickson, W. Esq. . . . 1 1 0
Granville, Lady C. . . . 1 1 0
Gray, John, Esq. 10 0
Grey, Lt.-Col. Alfred 1 0 0
Hindmarsh, W. T. Esq. . . 1 0 0
Lisle, Mrs. 1 0 0
Marrett, Rev. E. L. . . . 1 1 0
Maule, Mr. 5 0
Moore, Rev. David . . . 10 0
Paynter, H. Esq. . . . 5 0
Pease, J. W. Esq. . . . 2 2 0
Purvis, Mr. H. T. . . . 10 0
Richardson, Mr. G. . . . 5 0
Riddell, Sir W. B. Bt. 2 2 0
Robertson, Mr. T. . . . 5 0
Ryle, Mrs. 10 0
Shilbottle Colliery,
Lessees of. 10 0
Simpson, Mrs. Anne . . . 10 0
Smith, Henry 1 0 0
Stephenson, W. 5 0
Strother, Wm. Esq. . . . 5 0
Tate, G. Esq. 10 0
Tate, John, Esq. 10 0
Tate, T. Esq. 10 0
Thew, Arthur H. Esq. . . 10 0
Wilkin and Dickman,
Messrs. 5 0
Wilkinson, Capt. J. F. . . 10 6

Total £27 19 6

BERWICK BRANCH.

Chairman—
Rev. J. G. ROWE, Vicar.
Honorary Secretary—
B. G. SINCLAIR, Esq.
Annual Subscriptions.
Agent, Shipwrecked
Mariners' Society. 1 3 0
Allan Bros. Messrs. . . . 5 0
Allan, Thomas, Esq. . . . 5 0
Askew, Watson, Esq. . . . 1 0 0
Berwick Salmon
Fisheries Company 1 0 0
Bolam, R. G. Esq. . . . 10 0
Border Brewery Co. . . . 10 6
Cahill, Dr. F. 5 0
Clay and Son. 10 0
Crossman and Paulin 1 0 0
Darling, Thomas, Esq. . . 5 0
Dodds, R. Esq. 5 0
Fleming, L. T. & J. . . . 10 0
Forbes, Capt. R. N. . . . 1 1 0
Forster, Capt. James 1 1 0
Forster, R. Esq. J.P. . . 1 1 0
Harbour Commissioners. 2 2 0
Henderson, G. & Son . . . 10 0
Innes, J. H. Esq. 10 0
Johnston, Thos. Esq. . . 1 1 0
Lowrey, A.R. Esq. J.P. . . 10 0
Norman, Capt. 10 0
Paxton and Purves . . . 5 0
Purves, James D. Esq. . . 10 0
Richardson, Dr. R. N. . . 10 0
Riddell, Mrs. W. E. . . . 5 0
Robertson, A. Esq. J.P. . . 10 0
Rutter, Rev. Evan . . . 5 0
Sanderson, S. Esq. . . . 10 0
Sinclair, B. G. Esq. . . . 5 0
Thompson, A. Esq. . . . 5 0
Vicar of Berwick 5 0
Woods & Co. Bankers 1 1 0
Sums under 5s. 1 17 6

Total 22 3 0

Donations.		£.	s.	d.
<i>(1879.)</i>				
Amateur Musical Entertainment, per H. J. McFarlane	2	10	0	
Collecting - box at Boat-house	7	1		
Do. at Custom House, per G. Charlton Cole	8	9	0	
Miss Kinnear's collecting-box	6	7		
Total Dons	11	12	8	
Total Subs.	22	3	0	
	£33	15	8	

BLYTH BRANCH.

Chairman—
JOHN DENT, Esq.
Honorary Secretary—
MR. JAMES DARLING.

Donations.		£.	s.	d.
Arkless, Bell, & Co.	10	0		
Cole, John	5	0		
Darling, James	10	0		
Dawson, George R.	10	0		
Dent, G.	10	0		
Dent, John	10	0		
Dixon, John	5	0		
Dobson, John	5	0		
Dromgoole, Rev. P. O.	5	0		
Eccles, Thomas	10	0		
Gray, Robert, & Co.	10	6		
Hedley, John	1	0		
Herron, John	5	0		
Hodgson, Joseph	10	0		
Hodgson, Richard	10	0		
Keenlyside, Jacob	5	0		
Laws, John	10	0		
Lund, G.	5	0		
Lynn, J. R. D.	5	0		
Nichol, John W.	10	0		
Ridley, Sir M. W. Bt.	5	0		
Robinson, Edw. A.	5	0		
Robinson, William	5	0		
Saunders & Co.	10	0		
Sidney & Son	10	0		
Smith, Thomas A.	5	0		
Smith, William R.	10	0		
Trustees Thornton & Craft Estates, per William Gough	2	2	0	
Ward, Dr. G.	10	0		
Ward, William M.	5	0		
Watson, Edward	5	0		
Watts, Ward & Co.	2	2	0	
Wilson, John	5	0		
Winship, William	5	0		
Wood, James	5	0		
Sums under 5s.	5	17	0	
Total	£27	11	6	

BOULMER BRANCH.

Chairman—
JOHN CRASTER, Esq.
Honorary Secretary—
REV. L. J. STEPHENS, M.A.
Annual Subscriptions.
Northumberland, The Duke of 2 0 0
Browne, A. H. Esq. 1 1 0
Grey, The Earl. 2 0 0
Grey, Sir G. Bart. M.P. 1 0 0
Tankerville, Earl of. 1 0 0

Percy, Earl, M.P.	1	0	0
Allgood, Hunter, Esq.	10	0	
Bolan, Mr.	10	0	
Bosanquet, Rev. E. W.	2	0	
Brown, Rev. Dixon.	1	0	
Brown, Robert, Esq.	10	0	
Burrell, Bryan, Esq.	10	0	
Collinson, Mr.	10	0	
Crafter, John, Esq.	10	0	
Gandy, Capt.	1	0	
Grey, Mr. James	10	0	
Horsley, Mr. John	5	0	
Lombard, Mrs.	3	0	0
Ronaldson, James T. Esq.	10	6	
Sanderson, Mr.	5	0	
Smith, Mr. Mark	5	0	
Streatfeild, Rev. W. C.	10	0	
Tate, John, Esq.	10	0	
Thorpe, Mrs.	10	0	
Yeaman, Mr.	5	0	
Total	£21	13	6

CRESSWELL BRANCH.

Chairman—
REV. J. E. LERFE, M.A.
Honorary Secretary—
MR. JOHN ROBSON.
Annual Subscriptions.
Annett, Mr. J. 10 0
Baker-Cresswell, A. J. Esq. 10 0
Baker-Cresswell, Miss J. 2 10 0
Baker-Cresswell, Miss J. 2 10 0
Baker-Cresswell, Maj. O. C. 5 0 0
Bell, Mr. Thos. 5 0 0
Chirney, Messrs. G. and J. 5 0 0
Cranston, Mr. Thos. Senior. 5 0 0
Cranston, Mr. Thos. Junior. 5 0 0
Cresswell, Francis, Esq. 1 0 0
Hindhaugh, Mr. John 5 0 0
Hodson, Mr. Wm. 10 0 0
Leeffe, Rev. J. E. 1 0 0
Matheson, Mr. Thos. 5 0 0
Slater, Mrs. Jane. 10 0 0
Total £25 0 0

HAUXLEY BRANCH.

Chairman—
S. F. WIDDRINGTON, Esq.
Honorary Secretary—
REV. A. O. MEDD.
Annual Subscriptions.
Northumberland, His Grace the Duke of 2 0 0
Atkinson, G. C. Wilson, Esq. 1 0 0
Browne, General. 1 1 0
Carr, Rev. T. W. 1 1 0
Clutterbuck, T. Esq. 1 1 0
Currie, Dr. 10 0
Dand, M. H. Esq. 1 1 0
Dand, Robert, Esq. 10 6
Dand, James, Esq. 10 0
Dand, Rev. J. J. 10 0
Dunn, Rev. J. W. 10 6
Forster, Col. 1 1 0
Ilderton, Rev. Thos. 1 0 0
Maling, C. Esq. 1 1 0

Riddell, J. G. Esq.	1	0	0
Shotton, Jas. Esq.	10	0	0
Thomson, Rev. G. S.	1	0	0
Warkworth Harbour, Commissioners of	10	0	0
Widdrington, S. F. Esq.	2	2	0
Sums under 5s.	5	6	
Box at Life-boat House	5	2	
Total	£27	19	8

HOLY ISLAND BRANCH.

Chairman—
ROBERT CROSSMAN, Esq.
Honorary Secretary—
REV. W. W. F. KEELING.
Annual Subscriptions.
Armstrong, Sir W. G. Bart. 1 1 0
Askew, Watson, Esq. 1 1 0
Border Railway Co. 10 6
Crewe's, Lord, Trustees 2 2 0
Crossman, R. Esq. 2 2 0
Cruddas, W. D. Esq. 1 1 0
Douglas, Mrs. 1 1 0
Grey, Grey, Jas. Esq. 10 6
Knight, V. Esq. 1 0 0
Ridley, Sir M. W. Bart. 1 0 0
Tankerville, Earl. 1 0 0
Waterford, Louisa, Marchioness of ... 2 2 0
Wilson, Mrs. R. A. 10 6
£15 1 6

NEWBIGGIN BRANCH.

Chairman—
J. C. REID, Esq. M.D.
Honorary Secretary—
REV. E. SHORTT, M.A.
Woodhorn Vicarage.
Annual Subscriptions.
Dent, Mrs. Hedley. 1 1 0
Foster, Robert, Esq. 1 1 0
Lawson, Rev. E. 1 1 0
Mitford, Col. 1 1 0
Nesham, T. C. Esq. M.D. 1 1 0
Northumberland, His Grace the Duke of 2 0 0
Parker, Thos. Esq. 1 1 0
Shortt, Rev. E. 1 1 0
Trevelyan, Miss. 1 1 0
Waddilove, Major. 1 1 0
Watson, Robt. Esq. 2 0 0
Total £13 9 0

NEWCASTLE, TYNE-MOUTH, & CULLERCOATS BRANCH.

Vice-Patrons—
RT. HON. EARL RAVENSWORTH.
RIGHT HON. LORD HASTINGS.
W. B. BEAUMONT, Esq. M.P.
Treasurer—
HUGH TAYLOR, Esq.
Hon. Sec. at Tynemouth—
P. J. MESSENT, Esq. C.E.
Hon. Sec. at Cullercoats—
Major WILLIAM ADAMSON.
Collector—
MR. J. A. STEPHENSON,
1 Queen Street, Newcastle.
Annual Subscriptions.

Annual Subscriptions.		£.	s.	d.
Northumberland, His Grace the Duke of, P.C. (Patron)	2	0	0	
Adam Brothers & Co.	5	0		
Adamson, Wm.	10	6		
Alexander, J. B.	10	6		
Angus, George	1	1	0	
Annamdale, James	5	0	0	
Bainbridge, E. M.	1	1	0	
Barras & Co. John	1	1	0	
Boddington Coal Co.	2	2	0	
Benson, W.	1	1	0	
Bessler, Waechter & Co.	1	1	0	
Bilton, Williams & Co.	1	1	0	
Borries, Craig, & Co.	10	6		
Breyen, Richardson & Co.	5	0		
Brown, George	10	6		
Brown, Ralph	2	2	0	
Burn, R. B.	5	0		
Burnup, W. & C.	10	0		
Burradon & Coxlodge Coal Co.	1	1	0	
Carr and Co.	10	6		
Carr, John, & Son	10	6		
Carver & Co.	10	6		
Clapham, Henry	10	6		
Clayton & Armstrong	10	6		
Clayton, John	1	1	0	
Cook Brothers	10	6		
Coppin, John, J.P.	1	1	0	
Corporation of Newcastle	10	10	0	
Crawhall & Son, J.	1	1	0	
Cully, Edward	5	0		
Curry, Carrs, and Co.	10	6		
Dees, R. R.	10	6		
Diezinger and Co.	10	6		
Dixon, S. & C.W. & Co.	1	1	0	
Eichholtz, R. & Sons	10	6		
Farley, Clark & Berkley	1	1	0	
Foster, Robert, Esq.	1	1	0	
Fedden Brothers and Co.	10	6		
Fenwick, George	2	2	0	
Finney, Saml. & Co.	1	1	0	
Forster, G. B.	1	1	0	
Forster, James	5	0		
Forster, Blackett and Wilson	10	6		
Goddard, D. H.	1	1	0	
Greene & Sons, John Haansbergen and Usher	10	6		
Haggie, Peter	1	1	0	
Hall, John & Co.	1	1	0	
Harrison, A. P.	1	1	0	
Hart, J. De	1	1	0	
Harton Coal Co.	1	1	0	
Havelock, M.	10	0		
Hawks, Crawshaw, & Co.	1	1	0	
Hawthorn, R. & W.	1	1	0	
Herring, John	10	6		
Hodgkin, Barnett & Co.	3	3	0	
Hodgson, R. W.	5	0		
Holmes, Wm. Henry	1	1	0	
Houen, A. C. and Co.	10	6		
Hume and Sons	10	6		
Hunter, William	10	6		

BRANCHES—LIST OF ANNUAL SUBSCRIPTIONS AND DONATIONS. 129

	£.	s.	d.
Ransome, R. J. Esq.	10	6	
Reeve, Mrs.	1	0	
Ridley, F. Esq.	10	0	
Ridley, Messrs. G. and O.	1	0	
Schulens and Boby, Messrs.	10	0	
Sims, W. D. Esq.	1	0	
Turner, Messrs. E. K. and F.	1	0	
Turner, Messrs. W. and A. J.	1	0	
Tidbury, H. Esq.	1	0	
Weathorp, S. Esq.	10	0	
Wright, C. Esq.	10	0	
Wrinch, Mr. A.	10	0	
Total	42	14	6

Donations.

Foresters' and Odd Fellows' Amalgamated Fête Committee, 1878, per Wm. B. Jeffries, Esq. (Total contributions from this Committee, 1867-78, £85 5s.)

£47 14 6

LOWESTOFT AND PAKEFIELD BRANCH.

Chairman—
J. J. COLMAN, Esq., M.P.

Honorary Secretaries—
FREDERICK MONSE, Esq. Lowestoft.
W. F. LARKINS, Esq. Pakefield.

Hon. Superintendent of Life-boats—
MR. JOHN HENDERSON.

Collector—
MR. J. E. COOK.

Annual Subscriptions.

Andrews, Rev. W. H.	1	0	
Ayerst, Mrs.	10	0	
Barne, Fred. Esq.	1	0	
Base, Sam. Esq.	1	0	
Birbeck, H. Esq.	1	0	
Birbeck, Wm. Esq.	1	0	
Buxton, H. E. Esq.	2	0	
Clemence, J. L. Esq.	5	0	
Clubbe, W. H. Esq.	10	6	
Colman, J. J. Esq. M.P.	2	0	
Crossley, Lady	2	0	
Cubitt, Rev. F. W.	1	0	
Davey, Miss M.	1	0	
Denny, Rev. R. C.	1	0	
Devereux, John	5	0	
Eastaugh, J. D. Esq.	10	0	
Eden, Adm. Henry	1	0	
Edwards, George, Esq.	1	0	
Edwards, Rev. Frank	10	0	
Everitt, William, Esq.	1	0	
Fisher, James, Esq.	5	0	
Fiske, Edward B. Esq.	10	6	
Fiske, Rev. R. W.	10	6	
Fowler, E. W. Esq.	1	0	
Fowler, G. G. Esq.	1	0	
Fowler, Mrs. R. C.	1	0	
Gowing, J. J. W. Esq.	1	0	
Gurneys and Co.	2	0	
Harvey, E. K. Esq.	1	0	
Henderson, John	5	0	
Hurst, Samuel	1	0	
Huwet, Mrs.	10	0	
Jodrell, Rev. Hy.	10	0	
Johnson, William	5	0	
Johnson, Mrs.	1	0	
Larkins, Capt. W. F.	2	0	

	£.	s.	d.
Leathes, Lt.-Col. H. M.	1	0	
Lucas, C. T. Esq.	1	0	
Lucas, Thomas, Esq.	1	0	
Massingham, R. W.	10	6	
Morse, Frederick, Esq.	1	0	
Palmer, G. W. D. Esq.	10	6	
Peto, James, Esq.	1	0	
Preston, Benj. Esq.	10	6	
Preston, Capt. T. R. N.	1	0	
Price, Rev. L.	1	0	
Reeve, Rev. J. F.	1	0	
Roddam, Mrs.	1	0	
Seppings, Henry, Esq.	10	6	
Stebbings, A.	5	0	
Steward, Rev. Chas. J.	1	0	
Thirtle, T. E.	5	0	
Watson, J. T. Esq.	10	6	
Warman, Wm. Esq.	10	0	
Wingfield, Mrs.	1	0	
Woods, Henry G. Esq.	10	6	
Woods, Thomas R.	1	0	
Worthington, W. C. Esq.	10	6	
Youngs, Jos. Esq.	1	0	
Youngman, W. Esq.	10	6	
Total	52	15	6

Donations.

Pillar Contribution Box on the Lowestoft Pier

Pakefield Life-boat Boxes

Other Boxes

Total Dons. 11 0 7
Total Subs. 52 15 6
£63 16 1

SOUTHWOLD BRANCH.

Chairman—
J. L. EWEN, Esq.

Treasurer—
MR. H. J. DEBNEY.

Honorary Secretary—
MR. JOHN SINCLAIR.

Annual Subscriptions.

Allen, H. R. Esq.	10	0	
Blacket, J., Esq.	1	0	
Bosanquet, Miss	1	0	
Brook, J. W. Esq.	2	0	
Burleigh, R. W. Esq.	10	6	
Cantley, Rev. F. L.	10	0	
Chester, Colonel	1	0	
Crabtree, Misses	2	0	
Crowfoot, Mrs.	1	0	
Debney, Mr. H. J.	10	6	
Eeles, Miss	10	0	
Ellis, Colonel	1	0	
Ewen, J. L. Esq.	1	0	
Ewen, Rev. F.	10	0	
Foster, Charles, Esq.	2	0	
Gannon, E. M. Esq.	1	0	
Gausson, Mrs.	1	0	
Girling, R. C. Esq.	10	0	
Grubbe, J. W. Esq.	1	0	
Grubbe, E. E. Esq.	2	0	
Grubbe, Rev. Esq.	1	0	
Holland, Rev. E.	2	0	
Marsden, Mrs.	10	6	
Middleton, Adm. Sir G. N. Broke, Bart.	5	0	
Powell, Capt.	10	0	
Remnant, F. W. Esq.	2	0	
Riches, Mr. B.	5	0	

Sawyer, Mr. John	2	6	
Steele, T. D. Esq.	10	0	
Symonds, Rev. N.	1	0	
Vincent, J. L. Esq.	10	6	
Wilmer, B. W. Esq.	1	0	
Total	35	8	6

Donations.

Howard, Dr.

Lamont, J. Esq.

Box at Life-boat

House

Pillar Box

£39 2 6

Sussex.

BRIGHTON BRANCH.

Chairman—
MR. ALDERMAN COX, J.P.

Treasurer—
WILLIAM JOHNSTON, Esq.

Honorary Secretary—
W. R. WOOD, Jun., Esq.

Annual Subscriptions.

	£.	s.	d.
Ashbury, J. Esq., M.P.	10	0	
Ashby & Co. Messrs.	1	0	
Ashton, Mrs.	1	0	
Attree, Geo. Esq.	10	6	
Barnston, Miss	1	0	
Beaumont, Dr.	10	6	
Revis & Co. Messrs.	1	0	
Booth, E. Esq.	1	0	
Bovill, Miss.	1	0	
Bowen, Mrs. P.	1	0	
Boys, Jacob, Esq.	10	0	
Clarke, Somers, Esq.	10	6	
Cox, Alderman	1	0	
Estridge, Lieut.-Col.	1	0	
Eyre, G. J. Esq.	5	0	
Forster, Capt. R.N.	1	0	
Gore, Miss	5	0	
Hannington, G.S. Esq.	1	0	
Howlett, J. W. Esq.	10	6	
Jenner, H. N. Esq.	10	6	
Johnston, W. Esq.	1	0	
Lomas, Rev. Holland	1	0	
London and County Bank	1	0	
Lyon & Hall, Messrs.	1	0	
Mason, Mrs.	1	0	
Ogilvie, Mrs.	1	0	
Oldham, J. Esq.	1	0	
Partridge, Mr. A.	10	6	
Penton, Colonel	1	0	
Poundall, W. L. Esq.	10	6	
Reade, Rev. F.	1	0	
Robertson, Miss L.M.	1	0	
Shodes Children, Mrs.	3	0	
Skirrow, Miss	1	0	
Sutherland, A. H. Esq.	10	6	
Sutton, Mrs.	1	0	
Syrett & Grandel	1	0	
Tamplin, Mr. C.	1	0	
Tuffnel, Miss	10	6	
Vallance and Catt, Messrs.	2	0	
Wallis and Hack, Messrs.	1	0	

Wilkinson & Son	1	0	
Willett, G. W. Esq.	1	0	
Willett, H. Esq.	1	0	
Wood, Mr. W. R. Jun.	10	6	
Yates, Rev. H. W.	5	0	
Total	54	14	0

Legacy.

Knowles, — (the late)

100 0 0

Donations.

Boxes on Piers and Esplanade and at Aquarium

Eyre, J. J. Esq.

Kenmorriss, Mrs.

£212 3 5

CHICHESTER HARBOUR AND SELSEY BRANCH

President—
The Right Rev. the LORD BISHOP OF CHICHESTER.

Chairman of General Central Committee—
C. LENNOX TEESDALE, Esq.

Chairman of Local Committee—
Rev. H. MITCHELL, F.S.A.

Honorary Secretaries—
Rev. H. MITCHELL,
Rev. HERBERT C. FOSTER,
MR. JAMES GORHAM.

Treasurers—
Messrs. DENDY and Co.

Annual Subscriptions.

	£.	s.	d.
Bayton, Mr.	5	0	
Bethell, Miss.	5	0	
Buckner, Mrs.	5	0	
Burnett, Rev. W.	5	0	
Clement, Rev. T.	5	0	
Cogan, Mr. T. S.	5	0	
Cogan, Rev. H.	5	0	
Collins, Mr. H.	1	0	
Collins, Mrs. H.	10	6	
De Bathe, Maj.-Gen. Sir H. P. Bart.	10	0	
Denman, Hon. R.	1	0	
Ergmont, the Earl of	2	0	
Fetherstonhaugh, Miss-Fletcher, Sir Henry, Bart.	10	6	
Fletcher, Mr. C. J.	2	0	
Foster, Rev. R.	5	0	
Gaisford, Rev. G.	5	0	
Garnham, Lt.-Colonel	1	0	
Hall, Mr. C. H.	1	0	
Herington, Mr. E.	5	0	
Hobgen, Mr. C.	10	0	
Hobgen, Mrs. T.	5	0	
Hornby, Admiral Sir G.T. Phippe, K.C.B.	1	0	
Jarman, Captain	10	0	
Johnson, Rev. E. H. (the late)	1	0	
Kent, Mr.	5	0	
Langdale, Rev. G. A.	5	0	
Leconfield, Lord	1	0	
Lewis, Rev. H. C.	5	0	
Long, Miss Tyline	1	0	
Miller, Rev. J. Webber	5	0	
Oldfield, Col. B. E.	5	0	
Peckham, Mrs. (the late)	5	0	
Prime, Capt.	1	0	
Raikes, Mr. C.S.I.	10	0	
Randall, Mr. J.	10	0	
Richmond and Gordon, The Duke of, K.G.	2	0	

£. s. d.		£. s. d.		£. s. d.		£. s. d.	
Robinson, Mr. A.	10 0	BOSHAM, per Rev. HENRY MITCHELL:—		Curtis, Captain, R.N.	5 0	Dixon, Mr. H. H. W.	5 0
Smith, Mrs. F.	1 0 0	Apps, Mr. George	5 0	Denny, Mrs. G. T.	5 0	Fellowes, Mr. W. B.	5 0
Stanford, Mr. E.	10 0	Apps, Mrs. W.	5 0	Denny, Mr. E.	5 0	Hipkin, Mrs. W.	5 0
Sutton, Rev. R.	5 0	Baker, Mr. J.	5 0	Dilke, Mr. W.	10 0	King, Mr. W.	5 0
Upton, Mr. H.	5 0	Baker, Rev. R.	5 0	Duke, Mr. W.	5 0	Liot, Mrs.	5 0
Welllesley, The Lady		Baker, Mrs.	5 0	Edgell, Mrs.	10 0	Lyon, Miss	5 0
Victoria Long.	2 0 0	Baring, Mr. John	1 0 0	Farenden, Miss	5 0	Wackie, Mrs.	5 0
Woods, Mr. John W.	10 0	Berkeley, Hon. C.P.F.	10 0	Frampton, Rev. C. T.	1 0 0	Martin, Mr. G. P.	
		Berkeley, Hon. Mrs. C. P. F.	10 0	Francis, Mrs.	5 0	R.N.	
ARUNDEL, per Mr. C. BART- LETT, Jun.:—		Bosham, The Cham- berlain of	5 0	Fraser, Rev. J.	5 0	Matson, Miss	5 0
Butt, Rev. Canon	5 0	Bosham, The Vicar of	5 0	Freeland, Mr. H. W.	10 0	Munday, Lady	5 0
Constable, Mr. G. S.	10 0	Boys, Mr. T.	5 0	Gadd, Mr. E.	5 0	Norris, Rev. W.	10 0
Coots, Mr. G. C.	5 0	Bridges, Mr. E.	5 0	Gadd, Mr. H.	5 0	Norris, Rev. W. B.	5 0
Drewitt, Mr. R. D.	10 0	Cheestman, Mrs. Sen.	5 0	Gambling and Sons, Messrs.	5 0	Orsborn, Mr. J.	5 0
Duke, Mr. F.	10 0	Davey, Rev. H. M.	5 0	Garland, Mr. S.	5 0	Omond, Mr. J. H.	5 0
Evans, Mr. T.	1 1 0	Dawkins, Mrs.	5 0	Gatehouse and Son, Messrs.	10 0	Pawlick, Mr. H.	1 1 0
Evershed, Mr. C. L.	10 0	Douglas, Mrs.	5 0	Gibbings, Mrs.	5 0	Rawson, Mr.	5 0
Evershed, Mr. G. T.	5 0	Douglas, Miss	5 0	Gibbings, Mr. H. W.	5 0	Rawson, Mrs.	5 0
Fogden, Mr. John	5 0	Fardell, Mr. H.	5 0	Glennie, Rev. A. H.	5 0	Saithill, Mr. R.	5 0
Fry, Mr. E.	5 0	Fardell, Mrs.	5 0	Greene, Mr. T.	5 0	Scale, G. T.	10 0
Fry, Mr. William	10 0	Farne, Mr. C. H.	5 0	Gruggen, Mr. F. W.	5 0	Shawe, Mrs. R.	5 0
Holmes, Mr. E.	5 0	Fuller, Rev. A.	5 0	Gruggen, Mrs. J.	5 0	Shearn, Rev. H. S.	5 0
Holmes, Mr. Richard	10 0	Gatehouse, Mr. T.	5 0	Gruggen, Rev. G. S.	5 0	Sheppard, Rev. H. W.	10 0
Lambert, Mr. Cowley	1 1 0	Habin, Mr. J.	5 0	Habin, Mr. E.	5 0	Smith, Mrs. E.	5 0
Lewis, Mr. D.	5 0	Haines, Mr. W.	5 0	Halsted, Mr. C. T.	5 0	Spencer, Capt.	1 0 0
Long, Mr. John, The Firs.	5 0	Hancock, Mr. B.	5 0	Hardy, Maj.-Gen.	5 0	Thompson, Mrs.	5 0
Mitchell, Mr. W. W.	5 0	Heaver, Mr. John	5 0	Hayler, Mr. G.	5 0	Wide, Rev. R.	5 0
Mostyn, Captain	5 0	Inkson, Mr. W.	5 0	Hayllar, Miss	10 0	Wildor, Mr. G.	1 1 0
Norfolk, The Duke of, E.M.	2 2 0	Jardine, Mr. W.	10 0	Hayllar, Mrs. C.	10 0	Sums under 5s.	3 2 6
Thompson, Rev. A. S.	5 0	Jarrad, Mr. John	5 0	Henty, Mr. G.	10 0	MIDHURST, per Rev. E. P. COOK:—	
Tompkins, Mr. John	5 0	Jeffery, Mr.	5 0	Hill, Rev. J.	5 0	Gosden, Mr. J.	5 0
Uppfold, Mr. R.	5 0	Jenkins, Mr. Thos.	5 0	Irving, Mr. G.	10 0	Johnson, Mr. Thomas (2 years)	10 0
Watkins, Mr. E.	5 0	Lewis, Mr. W.	5 0	Johnson, M. J. J., Q.C.	10 0	Robinson, Mr. John, M.D. (2 years)	10 0
Webb, Mr. W. L.	5 0	Martin, Messrs.	5 0	Johnson, Rev. S.	5 0	Sandham, Miss	5 0
		Peachey, Mrs.	5 0	Johnson, Messrs.	5 0	Warren, Mrs. H.	10 0
		Pearson, Rev. G. F.	5 0	Johnson, Captain J. Luttman	5 0	Weekes, Mr. (2 years)	1 0 0
LITTLEHAMPTON, per Mr. GEORGE LEGGETT:—		Pudney, Mr.	5 0	Jones, Mr. C. S.	5 0	MUNDHAM, per Rev. T. J. TORR:—	
Barker, Mr. C. J.	5 0	Reynolds, Mr. T.	5 0	Lennard, Miss	5 0	Andrews, Mr. T.	5 0
Biden, Mrs.	5 0	Richardson, Mr. Jas.	5 0	Long, Mr.	5 0	Bowler, Mr. C. (the late)	10 0
Bruzard, Mr.	5 0	Shepherd, Mr. Jas. Sen.	5 0	Matthews, Miss	5 0	Caldwell, Mr. (2 yrs.)	10 0
Bushby, Mr. E.	5 0	Singer, Mr.	5 0	Newland, Miss	5 0	Covert-Freund, Mrs.	5 0
Butt, Mr. J.	10 0	Smart, Mr. Thomas	5 0	Nicolls, Miss L.	10 0	Gravey, Rev. H. F. (2 years)	10 0
Butt, J. E. & Sons, Messrs.	10 0	Smith, Mr. William	5 0	Norman, Mr. W.	1 0 0	Hobgen, Mr. F. N.	5 0
Butt, Mrs. J. E.	5 0	Spencer, Mrs.	5 0	Olden, Mr.	5 0	Hodson, Mrs.	5 0
Candy, Dr.	5 0	Titchener, Mr. J. J.	5 0	Partington, Mr.	5 0	Nunns, Rev. R. A. L.	5 0
Candy, Mrs.	5 0	Trevett, Mrs. E.	5 0	Pasco, Mr.	5 0	Peachey, Mr. James	5 0
Constable, Mr. Thos.	5 0	Trevett, Mrs. J.	5 0	Paul, Mr. G.	5 0	Peasdale, Mr. C. L.	10 0
Downer, Miss	5 0	Trevett, Mr. O.	5 0	Pearce, Mr. E.	5 0	Torr, Rev. T. J.	5 0
Duke, Messrs.	10 0	Walker, Miss	5 0	Percival, Mr.	1 0 0	Sums under 5s.	7 6
Evans, Mr. Thomas	5 0	Walker, Rev. G. A.	5 0	Phipps, Mrs.	5 0	SELSEY, per Mr. JAMES LAWRENCE:—	
Harvey, Messrs. J. & W. B.	10 0	Walker, Mr. T. L.	5 0	Pinnix, The Misses	5 0	Bateman, Mr. E. H.	5 0
Ion, Mr.	5 0	Walker, Mr. W.	5 0	Pratt, Capt. R.	10 0	Chase, Mr. R.	5 0
Lear, Mrs.	10 0	Wallis, Admiral Sir Provo, G.C.B.	5 0	Purchase, Mr. R.	5 0	Foster, Rev. H.	5 0
Lefroy, Captain, R.N.	5 0	Warren, Capt.	5 0	Raper, Mr. R. G.	5 0	Foster, Rev. Herbert C.	5 0
Leggett, Mr. G.	5 0	Woodman, Capt. C. E. S., R.N.	5 0	Riadore, Rev. G.	5 0	Penfold, Mr. H.	5 0
Looker, Mr.	5 0	Wood, Mr. John	5 0	Richardson, Mr. J.	5 0	Pullingar, Mr. C.	5 0
Moore, Miss	10 0			Russell and Sons, Messrs.	5 0	Woodman, Mr. W.	5 0
Neame, Mr. G.	5 0	CHICHESTER, per Mr. W. NORMAN:—		Russell, Mr. G.	5 0	Yeatman, Capt.	10 0
Neame, Mrs. G.	5 0	Adames, Mrs.	10 0	Sayers, Mr. J.	5 0	SINGLETON, per Rev. F. A. BOWLES:—	
Neame, Mr. N.	5 0	Adames, Mr. F.	5 0	Shippam, Mr. C.	5 0	Bower, Mr. F.	1 1 0
Philpot, Rev. W. B. (two years)	10 0	Anderson, Mr.	5 0	Silverlock, The Misses	5 0	Bowles, Rev. F. A.	10 0
Robinson, Mr. G.	5 0	Arnold, Mr. E.	10 0	Smith, Mr. G.	5 0	Buckell, Mr.	5 0
Robinson, Mr. Joseph	5 0	Atkey, Mr. C. J.	5 0	Smith, Mrs. H.	5 0	Deedes, Miss	10 0
Smith, Mr. C.	5 0	Ballard and Son, Messrs.	5 0	Smith, Mr. T.	5 0	Legge, Rev. H. E. (the late)	10 0
Sparks, Mr. G.	5 0	Benwell, Mr.	10 0	Smith, Messrs.	5 0	WEST WITTERING, per Mr. JOHN TRUST:—	
Stansfield, Rev. E.	5 0	Brown, Major	5 0	Sowton, Mr. M. J.	5 0	Andrews, Mr. John	5 0
Walthow, Mrs.	5 0	Brunton, Rev. W.	5 0	Swainson, Rev. Dr.	5 0	Aylmore, Mr. Thos.	5 0
Whitehead, Mr.	5 0	Buckell, Dr.	5 0	Temple, Mr. (the late)	10 0	Binstead, Mr. B.	10 0
Sums under 5s.	7 7 6	Buckle, Mr.	5 0	Teulon, Rev. J. S.	5 0	Combes, Mr. Charles	10 0
		Caffin, Mr. J.	5 0	Tyacke, Dr.	5 0	Gorham, Mr. J.	10 0
BOGNOR, per Mr. G. E. KERR.		Caffin, Mr. W. J.	5 0	Vick, Mr. F. M.	5 0	Sparkes, Mr. R. H.	5 0
Bingham, Lord	5 0	Campbell, Mrs.	10 0	Walker, Ven. Arch- deacon	5 0	Underwood, Rev. W. D.	5 0
Bray, Mrs.	5 0	Cavill, Rev. G.	5 0	Wilmshurst, Mr.	5 0		
Davenport, Mr.	5 0	Charge, Miss	5 0	Wilson, Mr. T.	5 0		
Keates, Capt.	5 0	Chichester, the Lord Bishop of	10 0	Wright & Son, Messrs.	5 0		
Lewis, Mr. C. G.	10 0	Chichester, the Dean of	10 0	Sums under 5s.	8 19 0		
Mair, Mrs.	5 0	Church, Mr.	5 0	EMSWORTH, per Mr. BULL:—			
Taylor, Admiral	5 0	Comper, Mr. H. (the late)	1 1 0	Allen, Rev. R. P.	10 0	Allen, Rev. R. P.	10 0
Tritton, Rev. E. B.	5 0	Cover, Messrs.	5 0	Aylward, Miss	5 0	Aylward, Miss	5 0
Weld, Mr.	5 0			Boyd, Mr. C. P.	5 0	Boyd, Mr. C. P.	5 0
Wilson, Mr. James	5 0			Castle, Mrs.	5 0	Castle, Mrs.	5 0
Sums under 5s.	3 17 6			Cox, Mr. J. E.	5 0	Cox, Mr. J. E.	5 0
				De Kawlyon, Mr. W. S.	5 0	De Kawlyon, Mr. W. S.	5 0

Table with 3 columns: Name, £, s, d. Includes Williams, Mrs. P., Wolfe, Mrs. Birch, Wollaston, E. O. Esq., Wood, Mrs., Young, H., Young, W. B. Esq., Hastings, Corporation, Boxes.

NEWHAVEN BRANCH.

Table with 3 columns: Name, £, s, d. Includes Chairmen R. T. Dolan, Esq. and W. S. Edwards, Esq.; Honorary Secretary W. S. Edwards, Esq.; Annual Subscriptions list; Donations list.

Table with 3 columns: Name, £, s, d. Includes Donations: Iron Pillar Box and other boxes.

RYE AND WINCHELSEA BRANCH.

Table with 3 columns: Name, £, s, d. Includes President T. S. Pix, Esq.; Honorary Secretary Henry Burra, Esq.; Annual Subscriptions list; Donations list.

Table with 3 columns: Name, £, s, d. Includes Frewen, Edward, Esq.; Gladstone, Rev. D. T.; Hardy, Hon. J. S.; Gathorne; Hilder, Mr. George; Lord, Rev. J. O.; Mayor of Rye; Meryon, C. P. Esq.; Pix, Thomas S. Esq.; Plomley, J. F. Esq.; Skinner, R. V. Esq.; Sileman, Major; Sileman, Miss; Symonds, Miss; Vidler, Messrs. J. and Sons.

Table with 3 columns: Name, £, s, d. Includes Donations: Rye Commercial Association, Collected by F. Bellingham, Box at Boat-house.

SHOREHAM BRANCH.

Table with 3 columns: Name, £, s, d. Includes Chairmen Hugh Gorringe, Esq. and T. L. Stapledon, Esq.; Honorary Secretary Thos. Fuller, Esq. M.D.; Honorary Collector D. Pilmore; Annual Subscriptions list; Donations list.

WORTHING BRANCH.

Table with 3 columns: Name, £, s, d. Includes Patron Sir W. W. Burrell, Bart. M.P.; Chairman H. Hargood, Esq.; Honorary Secretary Melvill Green, Esq.; Annual Subscriptions list; Donations list.

Table with 3 columns: Name, £, s, d. Includes Collet, G. B. Esq.; Cortis, Mr. A.; Cortis, Mr. C.; Cripps, Mr. F.; Cruse, Rev. F.; Curry, Mrs.; Davey, Mrs.; Dawes, R. Esq.; Dennett, Miss; Elliott, Rev. E. H.; Ferguson, Miss; Field, Mrs. J. K.; Field, J. L. Esq.; Goldsmith, Dr.; Graham, T. G. Esq.; Green, F. Esq.; Green, M. Esq.; Gresson, Rev. J. G.; Hargood, Admiral.; Hargood, H. Esq.; Harris, W. J. Esq.; Harris, W. Esq.; Henty, E. Esq.; Hopkins, H. Esq.; Loder, R. Esq.; Maxwell, General.; Morton, Mrs.; Newland, the Misses.; Nicholls, Mrs.; Ough, Rev. C.; Parr, Rev. J. O.; Parry, Major.; Patching, Mr. E. C.; Patching, W. Esq.; Patrick, Rev. J. B.; Paull, H. Esq.; Potter, Mr. W.; Pryce, T. D. Esq.; Puckle, Mrs. R.; Richards, Capt. G.; Roberts, Chas. Esq.; Saunders, W. Wilson Esq.; Skindle, Mr. W.; Smart, H. Esq.; Smith, Cleveland, Esq.; Smith, Mr. G. H.; Stocker, Misses.; Tayler, Mrs.; Thornton, A. J. Esq.; Traill, Miss.; Vansittart, Rear Admiral, C. B.; Verrall, W. Esq.; Watson, J. L. Esq.; Welsh, C. J. Esq.; West, Mrs. P.; Wickham, A. Esq.; Wisden, Major.; Wright, Mrs.; Young, A. Esq.; Sums under 5s.

Table with 3 columns: Name, £, s, d. Includes Donations: Post Office Box, Pillar and Wall, Boxes, Total Doms, Total Subs.

Warwickshire.

BIRMINGHAM BRANCH.

Table with 3 columns: Name, £, s, d. Includes Chairman J. H. Chance, Esq.; Honorary Secretaries Messrs. Charles and William Barwell; Annual Subscriptions list; Donations list.

Table with 3 columns: Name, £, s, d. Includes Donation: J. Shorthouse, Esq.

BRANCHES—LIST OF ANNUAL SUBSCRIPTIONS AND DONATIONS. 133

Worcestershire.

WORCESTER BRANCH.

Chairman— CAPT. TINKLAR, R.N. Treasurer— FRAS. SPOONER, Esq. Honorary Secretary— F. W. SEAMAN, Esq.

Annual Subscriptions.

Table of annual subscriptions for Worcester branch with names and amounts in £, s., d.

Total 36 12 9

Donation.

Table of donations for Worcester branch.

STECHEFORD BRANCH.

Treasurer and Hon. Sec.— MR. WILLIAM MORGAN.

Annual Subscriptions.

Table of annual subscriptions for Stecheford branch.

Table of annual subscriptions for ACOCK'S GREEN AND YARDLEY BRANCH, continued.

Collecting Cards.

Table of collecting cards for ACOCK'S GREEN AND YARDLEY BRANCH.

Donations.

Table of donations for ACOCK'S GREEN AND YARDLEY BRANCH.

Summary table for ACOCK'S GREEN AND YARDLEY BRANCH, including Annual Meeting, Readings, and Total Subs.

ACOCK'S GREEN AND YARDLEY BRANCH.

Chairman— MR. BARROWS. Treasurer and Honorary Secretary— REV. A. BUTLER, LL.D.

Annual Subscriptions.

Table of annual subscriptions for ACOCK'S GREEN AND YARDLEY BRANCH.

Per Miss TOMKINS:— DUDLEY, Mrs. 5 0 BUTLER, Rev. A. 5 0

YARDLEY, per Miss WHITAKER:—

Table of annual subscriptions for YARDLEY branch.

Summary table for ACOCK'S GREEN AND YARDLEY BRANCH, including Donations and Total.

Donations.

Table of donations for ACOCK'S GREEN AND YARDLEY BRANCH.

Collecting Cards.

Table of collecting cards for ACOCK'S GREEN AND YARDLEY BRANCH.

YARDLEY, per Miss HOSKINS:—

Table of annual subscriptions for YARDLEY branch.

Total 6 10 5

Total Subs. 22 13 0

Total Dons. 3 14 8

Collecting Cards 6 10 5

£32 18 1

Yorksire. BRADFORD BRANCH

Chairman— FREDK. PRIESTMAN, Esq.

Honorary Secretary— J. A. GODWIN, Esq.

Annual Subscriptions.

Table of annual subscriptions for Bradford branch.

£.	s.	d.
Jennings, Mr. Jon.	1	1 0
Keighley, Mr. S.	1	1 0
Laycock, Mr. T. B.	1	1 0
Laycock, Mr. Wm.		
(Carrier)	5	0
Laycock, John Wm.	1	1 0
Lund, Wm. and Son,		
Messrs.	2	2 0
Marriner, B. and W.		
Messrs.	2	2 0
Rhodes, Mr. John	5	0
Rhodes, Mary	5	0
Rushworth Brothers,		
Messrs.	1	1 0
Smith and Sons,		
Messrs.	10	6
Smith, John	5	0
Smith, Jonas	5	0
Smith and McLaren.	1	1 0
Smith, P. and Son	2	2 0
Spencer, G. E.	1	1 0
Sugden Jones, Bros.	1	1 0
Sugden, Wm.	5	0
Summerscales, W. &		
Son, Messrs.	2	2 0
Sunderland, John	5	0
Wall, Mr. James	5	0
Wall, Thos.	10	0
Waterhouse, Wm.	5	0
Waterworth, Wm.	5	0
Weatherhead and W.		
and G. Burr, Messrs.	1	1 0
Weatherhead, Wm.	10	6
Whitley, Mr. J.	5	0
Wilkinson, Mr. C. H.	5	0
Total	£32	6 0

LEEDS BRANCH.

President—
W. BECKETT DENISON, Esq.

Honorary Secretary—
HERMAN LUDOLF, Esq.

Annual Subscriptions.

Appleyard, T. Esq.	1	1 0
Ashworth, S. P. Esq.	1	1 0
Atkinson, D. H. Esq.	10	0
Atkinson, Miss.	1	1 0
Baines, E. Esq.	1	1 0
Baines, M. Esq.	10	0
Barran, J. Esq.	1	1 0
Bedford, James, Esq.	5	0
Beverley, Mrs. Wm.	10	0
Birchall, J. D. Esq.	1	1 0
Briggs & Co. Messrs.	1	1 0
Briscall, Henry, Esq.	10	6
Brown, S. J. Esq.	2	2 0
Browne, Rev. R.	10	6
Buckley and Sons.	2	2 0
Buckton, R. & Sons.	1	1 0
Burkill, J. H. Esq.	1	1 0
Cattaneo & Co. Messrs.	10	6
Charlesworth, Miss C.	5	0
Conder, Rev. E. R.	10	6
Conyers, W. H. Esq.	5	0
Craven, H. Esq.	1	1 0
Croft, Samuel, Esq.	1	1 0
Crothwaite, Rev. B.	10	6
Darwin, F. Esq.	1	1 0
Dawson, Thos. Esq.	10	6
Dayson, J. O. Esq.	10	6
Denison, W. B. Esq.	2	2 0
Denny, Mr. C. E.	5	0
Dixon, J. Esq.	10	6
Douglas, John, Esq.	1	1 0
Dyson, John, Esq.	1	1 0
Fitch, J. J. & Son,		
Messrs.	1	1 0
Fraser, J. B. Esq.	10	6
Gaines, Thomas, Esq.	5	0
Galsworthy, R. Esq.	10	6
Greenwood & Batley,		
Messrs.	1	1 0

RUNSWICK BRANCH

Patron—
The Most Noble the MARQUIS OF NORMANBY.

President—
C. M. PALMER, Esq.

Honorary Secretary—
Dr. J. V. LAVERICK.

Annual Subscriptions.

£.	s.	d.
Chaloner, Admiral	2	0 0
Chomley, Mrs. H.	1	1 0
Hildyard, Rev. H. S.	1	0 0
Kerr, John, Esq.	10	6
Laverick, Dr. J. V.	10	6
Logan, W. Esq.	1	0 0
Morehead, Rev. G. J.	1	0 0
Palmer, C. M. Esq.	3	3 0
Stephens, Capt. D. W.	10	6
Webster, Robt. Esq.	10	6
Total	11	7 0

Donations.

Sums under 5s.	4	0 0
£11	11	0 0

SCARBOROUGH BRANCH.

Chairman—
PRESIDENT OF TRINITY HOUSE.

Treasurer—
J. W. WOODALL, Esq.

Honorary Secretaries—
JOHN STEPHENSON, Esq.
A. E. HICK, Esq.

Annual Subscriptions.

Alderson-Smith, G.		
Esq.	10	0
Alan, Alex. Esq.	1	0 0
Blunt, Ven. Arch-		
deacon	5	0 0
Bottomley, Misses	5	0
Bright & Sons	5	0
Burnard, Miss	1	0 0
Caine, W. S. Esq. M.P.	2	0 0
Calvert, F. W. Esq.	5	0
Cankrien, Miss	5	0
Cathcart, Earl	1	0 0
Clapham, A. Esq.	1	0 0
Collinson, R. Esq.	5	0
Craven, Miss Mary	5	0
Cross, Dr.	5	0
Denby, Jesse, Esq.	5	0
Ellershaw, R. J. Esq.	1	1 0
Forster, H. H. Esq.	1	1 0
Forster, R. Esq.	5	0
Fowler, Benj. Esq.	5	0
Graton, Colonel	5	0
Hamerton, Rev. C.	10	0
Harrison, Mrs.	10	0
Hebden, E. H. Esq.	1	1 0
Hemsworth, B. Esq.	10	0
Hick, M. Esq.	5	0
Hick, P. Esq.	5	0
Hick, T. Esq.	5	0
Holroyd, Miss Eliz.	1	1 0
Holroyd, Miss Emma	1	1 0
Hugill, Mr. Thos.	5	0
Inglis, Major	10	0
Jack, Miss	10	0
Jackson, Geo. Esq.	1	0 0
Johnstone, Sir Har-		
court, Bart. M.P.	2	2 0
Jones, Mrs.	10	0
Lea, George, Esq.	5	0
Leigh, Hon. Augusta	5	0
Locke, Wm. Esq.	1	0 0
Marshall, Mrs.	10	0
Morris, R. M. & Co.	5	0
Newton, E. H. Esq.	10	0

£.	s.	d.
Owen, R. Esq.	10	0
Parkinson, A. Esq.	1	1 0
Peacock, C. J. Esq.	10	6
Petrie, Josh. Esq.	5	0
Porrett, G. Esq.	5	0
Reed, Mr.	5	0
Robinson, Colonel	5	0
Rodham, Mrs. J.	10	6
Rowntree, J. Esq.	10	6
Rowntree, W. Esq.	10	6
Sarony, Mrs.	5	0
Sharpin, J. F. Esq.	5	0
Sitwell, Dowager Lady	5	0
Sitwell, Lady	5	0
Stead, Samuel, Esq.	5	0
Stephens, T. B. Esq.	10	6
Teale, J. W. Esq.	5	0
Theakstone, S. W. &		
Co.	5	0
Tindall, Mrs.	10	6
Tindall, Mrs. R. H.	10	6
Tindall, John, Esq.	1	1 0
Uppley, Mrs.	10	0
Vassalli, Mr. J.	5	0
Wailes, Misses	5	0
Walker, H. Esq.	5	0
Ward, Rev. G. A.	5	0
Weddell, Mrs.	5	0
Wharton, John, Esq.	5	0
Whittaker, Mr. T.	5	0
Windle, Miss	5	0
Woodall, J. W. Esq.	1	1 0
Wortley, Hon. F. S.	10	0
Wray, Mrs.	5	0
Sums under 5s.	2	2 6
Total	40	0 6

Donations.

Ashton, John W. Esq., Newton Lodge, Cheshire	20	0 0
Bateman, S. Esq.	5	0
Bush, Wm.	5	0
Crompton, Miss	5	0
Greenbury, M. S.	10	0
Hanbury, R. Esq.	10	0
Irving, Miss	5	0
Pierce, C. H. Esq.	5	0
Rudgard, R. Esq.	5	0
R. C.	10	0
Stanwell, Mrs.	10	0
Taylor, T. E. Esq.	5	0
Waddington, W. A.	5	0
Winter, Mr.	5	0
Wright, J. F. Esq.	5	0
Sums under 5s.	26	19 2

Cards.

60 Eastborough	6	0 0
Dozes.		
Boat-house Box	4	9 0
Pillar Box, Esplanade	3	13 4
" Old Cliff	17	0
Railway Station Box	2	3 9
Mr. Wray's, box at	7	7
Smaller sums	5	11

Hotels.

Brunswick Hotel	1	14 0
Cambridge Hotel	3	14 6
Crown Hotel, Visitors at	7	6 6
Prince of Wales Hotel	6	6 3
Swift's Hotel, Visitors at	3	4 7

Total Dons.	90	12 7
Total Subs.	40	0 6

£130 13 1

BRANCHES—LIST OF ANNUAL SUBSCRIPTIONS AND DONATIONS. 137

SETTLE BRANCH.

President—	
WALT. MORRISON, Esq.	
Honorary Secretary—	
C. BROWN, Esq.	
Annual Subscriptions.	
<i>£. s. d.</i>	<i>£. s. d.</i>
Abbottson, Chas. Esq. 1 1 0	A Friend 5 0
A Friend 5 0	Alcock, Wm. Esq. 1 1 0
Amblor, Mr. 5 0	Armistead, Mr. H. 5 0
Batten, Mrs. 10 0	Battersby, Miss 5 0
Birkbeck, John, Esq. 1 1 0	Birkbeck, J. Jun. Esq. 1 0 0
Birkbeck, Jos. Esq. 1 1 0	Birkbeck, Capt. R. S. 1 1 0
Boyd, Rev. Canon. 10 0	Brayshaw, Mrs. 10 6
Brayshaw, T. Esq. 1 1 0	Brennard, Mrs. 5 0
Brockbank, Mr. E. 5 0	Bromley, Mr. John 10 0
Brown, Chris. Esq. 2 2 0	Burrow, Mrs. 10 6
Butterfield, Mr. John 5 0	Chamley, Mr. W. 5 0
Charlesworth, C. H. Esq. 1 1 0	Christie, Hector, Esq. 2 2 0
Clapham, T. R. Esq. 1 1 0	Clark, Mr. 10 0
Clayton, Miss 1 0 0	Clayton, Mrs. 1 0 0
Coulthurst, Rev. W. H. 10 0	Craven Bank Compy. 2 2 0
Crossley, J. S. Esq. 1 1 6	Dawson, W. Moseley, Esq. 1 1 0
Deighton, Chris. Esq. 5 0	Delves, Mr. G. 5 0
Dudd, Wm. Esq. 5 0	Duckett, Mr. R. 5 0
Ellis, Mr. Francis. 10 0	Foster, John, Esq. 10 0
Foster, Miss, Settle. 10 0	Foster, Mrs. E. T. 10 0
Foster, Mrs. J. W. 1 1 0	Foster, W. Esq. 10 0
Westward Pk. 10 0	Gibson, Mr. G. H. 5 0
Gill, Mrs. 1 1 0	Golland, Mrs. 1 0 0
Gore, Mr. H. 5 0	Grime, Mr. R. 1 0 0
Grisedale, Mrs. 5 0	Hammond, J. Esq. 1 1 0
Hammond, Miss. 10 0	Hammond, Mrs. 5 0
Handby, Mr. John 5 0	Hargraves, John, Esq. 5 0
Hargraves, Mr. T. 1 0 0	Hartley, Mrs. George (the late) 1 0 0
Hartley, James, Esq. 10 6	Hartley, Mr. Jas. 5 0
Hartley, John, Esq. 10 0	Hartley, Robt. Esq. 10 0
Hartley, Mr. Thos. 5 0	Hawkins, Mr. 10 0
Hick, Edw. Esq. 10 6	Hinde, Mr. Robert. 5 0
Hird, Mr. A. 5 0	Holden, Mr. T. 10 0
Holgate, Miss 10 0	Holgate, Miss E. 10 0
Holgate, T. Esq. (B.) 10 0	Holgate, T. Esq. (N.H.) 1 0 0
Hook, Sergeant-Maj. 5 0	Horner, Mr. Thos. 5 0
Howarth, Mr. Jas. 5 0	Howarth, Mr. Wm. 5 0
Hubble, Wm. Esq. 1 1 0	Hunter, Mr. Wm. 5 0
Ingham, Mr. W. 5 0	Ingleby, Chris. Esq. 1 1 0

Ingleby, John, Esq. 1 1 0	Ingleby, Mrs. R. 10 6	Ingleby, Mrs. Thos. 10 6	Ingram, Rev. Rowld. 10 6	Jackson, Mr. C. 5 0	Jackson, Mr. J., Sd. 5 0	Jackson, Mr. T. 5 0	Jarry, Misses 5 0	Johnson, Mr. H. 5 0	King, Mr. Hy. 5 0	King, Mrs. 10 0	Knowles, Mrs. 1 1 0	Knowles, T. F. Esq. 2 2 0	Laycock, Mr. James. 5 0	Leeming, Mr. Thos. 5 0	Lister, Mr. John 5 0	Lister, Mrs. (L. P.) 5 0	Marchbank, Mrs. 5 0	Marshall, Mrs. 10 0	Marshall, T. and J. 10 0	Metcalfe, Mr. F. 5 0	Metcalfe, Mr. J. 5 0	Metcalfe, Mr. R. 5 0	Metcalfe, Wm. Esq. 10 0	Morley, R. Esq. 2 2 0	Morrison, Walt. Esq. 5 0 0	Moser, Mrs. 1 1 0	Nock, Mrs. 10 0	Nowell, Mr. M. 5 0	Parkinson, A. Esq. 1 1 0	Parkinson, J. Esq. 1 0 0	Perfect, Mrs. 1 1 0	Pierson, Rev. W. F. 10 6	Preston, J. Esq. 1 0 0	Procter, Miss (L. P.) 10 0	Ralph, Mr. Wm. 5 0	Ray, Mr. R. 5 0	Ray, Mr. W. B. 1 1 0	Robinson, Mrs. D. 1 0 0	Robinson, Rev. Jno. 1 0 0	Robinson, Thos. Esq. 5 0	Robinson, Wm. Esq. 1 1 0	Sedgwick, Miss. 1 0 0	Sedgwick, Mrs. C. 10 0	Sedgwick, Mrs. L. 1 1 0	Shepherd, Mrs. 5 0	Slinger, Jonath. Esq. 5 0	Slinger, Miss, Studf. 5 0	Smith, Mr. A. 12 6	Smith, Mr. Joseph. 5 0	Smith, Mrs. Lau. 5 0	Stackhouse, Mrs. 10 0	Stackhouse, Mrs. 10 0	Stansfeld, Miss. 1 1 0	Stansfeld, Rev. J. 5 0	Starkie, Rev. H. A. 1 1 0	Style, Rev. George. 1 1 0	Sutcliffe, Miss. 1 1 0	Tatham, Mrs. 10 0	Tatham, Mrs. J. 10 0	Tattersall, W. Esq. 5 0	Taylor, Edward, Esq. 10 0	Thompson, H. J. J. Esq. 5 0	Thompson, Jno. Esq. 5 0	Thornton, Mrs. 2 2 0	Titterington, T. Esq. 10 0	Towler, Wm. Esq. 10 6	Turner, Mr. Joseph. 5 0	Vant, Mr. J. Henry. 5 0	Wildman, Mr. W. 7 6	Willis, J. J. Esq. 1 1 0	Winder, Mr. J. 5 0	Winskil, Mr. 5 0	Yorke, T. E. Esq. 1 1 0	51 Annuals at 2s. 6d. 6 7 6	Sums under 5s. 6 6
---------------------------	----------------------------	-------------------------------	-------------------------------	--------------------------	-------------------------------	--------------------------	-------------------------	--------------------------	------------------------	----------------------	--------------------------	---------------------------	------------------------------	-----------------------------	---------------------------	-------------------------------	--------------------------	--------------------------	-------------------------------	---------------------------	---------------------------	---------------------------	------------------------------	----------------------------	----------------------------	------------------------	----------------------	-------------------------	--------------------------	--------------------------	--------------------------	-------------------------------	-----------------------------	---------------------------------	-------------------------	----------------------	---------------------------	------------------------------	---------------------------	-------------------------------	--------------------------	----------------------------	-----------------------------	------------------------------	-------------------------	--------------------------------	--------------------------------	-------------------------	-----------------------------	---------------------------	----------------------------	----------------------------	-----------------------------	-----------------------------	---------------------------	--------------------------------	-----------------------------	------------------------	---------------------------	------------------------------	--------------------------------	----------------------------------	------------------------------	---------------------------	---------------------------------	----------------------------	------------------------------	------------------------------	--------------------------	-------------------------------	-------------------------	-----------------------	------------------------------	-----------------------------	-------------------------

Donations and Legacy.

1879.	A Friend 10 0	Atkinson, Miss (the late) Legacy 19 0	Banks, Mr. John 5 0	Barnett, Mr. W. H. 5 0	Bateson, Mr. Giles. 5 0	Brayshaw, Miss 10 0
-------	---------------------	---	--------------------------	-----------------------------	------------------------------	--------------------------

Brown, Chris. Esq. 105 0 0	Brown, Mr. John, Settle 5 0	Bury, Mrs. 10 0	Bryning, Miss E. M. 5 0	Bryning, Miss Mary 5 0	Carr, Mr. John. 5 0	Christie, Lor. Esq. 10 0	Clapham, T. R. Esq (col. box, 1878) ... 5 9	Do. (col. box, 1879) 17 6	Commercial Hotel, col. box. 2 1	Concert by Band of 15th W. Y. R. V. 9 2 2	Craven Bank Com-pany (interest) ... 2 15 0	Davis, Mr. Thomas. 10 0	Entertainment at Stainforth 3 13 3	Gornall, Mr. James. 5 0	Hartley, Mr. W., Skipton 5 0	Hearn, Mrs. (the late) 5 0 0	Holgate, Mrs. 10 0	Holmes, Mr. Thos. 10 0	Jackson, Geo. Esq. 1 0 0	Jackson, John, Esq. Ulverston 33 6 8	Knowles, T. F. Esq. 10 10 0	Lion Hotel, Settle, col. box 6 8	Morphet, Mr. John. 5 0	Petty, Mr. John. 1 0 0	Pierson, Lieut. J. E. 5 0 0	Preston, Miss J. 5 0 0	Procter, Mr. A. Stain. 5 0	Procter, Mr. J. (Fr.) 5 0	Procter, Thos. Esq. (C. H.) 33 6 8	Routh, Rev. C. 10 0	Scott, John, Esq. 10 0	Sedgwick, Mrs., Lon-don 2 2 0	Slinger, Miss M. M. 5 0	Small Sums and Wrecks 1 9 3	Small Sums (col. by J. W. E.) 6 0	Snell, Mr. John 5 0	Stackhouse, Miss (B. E.) 10 0	Swinbank, Mr. Thos. 6 0	Taylor, Mr. David. 3 0	Thornton, Mrs. 2 2 0	Whalley, Chas. Esq. 5 0	Whinray, Mr. J. 5 0	Wood, Mr. Rd., Leeds 5 0	21 Dns. at 2s. 6d. ... 2 12 6
----------------------------	-----------------------------------	----------------------	------------------------------	-----------------------------	--------------------------	-------------------------------	---	--------------------------------	--------------------------------------	--	--	------------------------------	--	------------------------------	------------------------------------	------------------------------	-------------------------	-----------------------------	--------------------------	--	-----------------------------	--	-----------------------------	-----------------------------	-----------------------------	-----------------------------	---------------------------------	--------------------------------	--	--------------------------	-----------------------------	-------------------------------------	------------------------------	-----------------------------------	---	--------------------------	-------------------------------------	------------------------------	-----------------------------	---------------------------	------------------------------	--------------------------	--------------------------	-------------------------------

Total Dons. 254 10 6
Total Subs. 103 19 6

£358 10 0

Earlier Donations.

A Friend (1875) ... 20 0 0	Brown, C. Esq. (1869-70) 12 12 0	Ditto (1875-6-7-8) 420 0 0	Farrer, J. Esq. (the late) (1866-8) ... 30 0 0	Foster, Mr. G. H. (the late, 1866-9-70) ... 17 0 0	Hardacre, Mrs. T. (the late, 1875) ... 20 0 0	Hearn, Mrs. (the late) (1876-7-8) ... 26 10 0	Lambert, Miss (1864) 20 0 0	Starkie, Dowr. Mrs. (1875) 10 10 0	Willis, J. J. (1865-8, 1873-7) 17 0 0
----------------------------	--	----------------------------	--	--	---	---	-----------------------------	--	---

SHEFFIELD BRANCH.

President—
The Right Hon. the EARL FITZ-WILLIAM.

Secretary—
Mr. W. H. BECKETT.

Annual Subscriptions.

<i>£. s. d.</i>	<i>£. s. d.</i>
Butcher, W. and S. 2 2 0	Chadburn Brothers. 1 1 0
Chapman, Samuel. 1 1 0	Chesterman and Co. 1 1 0
Cole Brothers. 1 1 0	Dixon and Sons. 2 0 0
Firth, T. and Sons. 2 0 0	Fowler, Fred. 10 0 0
Fox, Samuel, & Co. (Limited) 5 0 0	Gilmour, D. and Co. 1 1 0
Jessop, Thomas 2 2 0	Kenyon and Co. 1 1 0
Law, Mr. 10 6 0	Marrion, Thomas. 1 1 0
Marsh Brothers & Co. 1 1 0	Martin, Hall, and Co. 1 1 0
Newton, F. and Sons 1 1 0	Roberts and Belk. 1 1 0
Roberts, Miss. 1 1 0	Roberts, S. Esq. 1 1 0
Rodgers and Sons. 2 0 0	Russell, H. 1 1 0
Smith, Dr. 1 1 0	Sorby and Sons. 1 1 0
Speare and Jackson. 1 1 0	Stephenson, J. and S. 10 6 0
Tennant Brothers. 1 1 0	Turton, T. and Sons 1 1 0
Vickers, Sons, & Co. 2 2 0	Walker and Hall. 1 1 0
Watson and Co. 5 0 0	Wilks, Miss. 1 1 0
Wilson, Hawksworth, Ellison, and Co. 1 1 0	Wilson, Thomas. 1 1 0
Wostenholm, Mrs. George 2 2 0	Wright, John. 10 6 0

Total 45 17 6

Donation.

Webster, Wm. 2 2 0

£47 19 6

STAITHES BRANCH.

President—
C. M. PALMER, Esq., M.P.

Chairman—
Rev. G. J. MOREHEAD, J.P.

Honorary Secretary—
Dr. J. V. LAVERICK.

Annual Subscriptions.

Brotchie, George, Esq. 10 6	Hon. Secretary 10 6	Laverick, Capt. G. D. 10 6	Morehead, Rev. G. J. 1 0 0	Palmer, C. M. Esq., M.P. 3 3 0	Ryder, Mr. William. 10 6	Spinks, Mr. Jas. 10 6	Verrill, Mr. Josh. 10 6
----------------------------------	---------------------------	---------------------------------	----------------------------	-------------------------------------	-------------------------------	----------------------------	------------------------------

Total 7 6 0

Donations.

Black Lion Hotel. 3 0

£7 9 0

TEES BAY BRANCH.

Patron— The EARL OF ZETLAND.

President— JOSEPH PEASE, Esq.

Treasurer— EDMUND BACKHOUSE, Esq.

Honorary Secretary— MATTHEW MURRAY, Esq., Middlesbrough.

Annual Subscriptions.

Table of annual subscriptions for Tees Bay Branch with names and amounts.

Total35 2 0

Donations.

Table of donations for Tees Bay Branch.

Total Dons.33 8 11

Total Subs.35 2 0

£68 10 11

WAKEFIELD BRANCH.

Honorary Secretary— HENRY ROBINSON, Esq.

Annual Subscriptions.

Table of annual subscriptions for Wakefield Branch.

Table of annual subscriptions for Tees Bay Branch (continued) with names and amounts.

Donation.

Table of donations for Tees Bay Branch.

£36 18 5

WHITBY AND UP-GANG BRANCHES.

Honorary Secretaries— E. W. CHAPMAN, Esq. Mr. ROBERT GIBSON.

Annual Subscriptions.

Table of annual subscriptions for Whitby and Up-gang Branches.

Table of annual subscriptions for Tees Bay Branch (continued) with names and amounts.

Total31 4 6

Donations.

Table of donations for Tees Bay Branch.

£42 12 4

WITHERNSEA BRANCH.

Honorary Secretary— H. H. AYBE, Esq.

Annual Subscriptions.

Table of annual subscriptions for Withernsea Branch.

Table of annual subscriptions for Tees Bay Branch (continued) with names and amounts.

Total£34 9 0

YORK BRANCH.

Treasurer and Honorary Secretary— Dr. DUNHILL.

Annual Subscriptions.

Table of annual subscriptions for York Branch.

Table with 3 columns: Name, £. s. d., Total. Includes names like Craig, John, Esq., and Kinsie, John, Esq.

Sundry Donations... Total £42 16 10

AYR BRANCH.

Chairman— THOMAS STERLE, Esq. Provost of Ayr. Honorary Secretary— JOHN POLLOCK, Esq.

Annual Subscriptions.

Table of annual subscriptions for Ayr Branch with 3 columns: Name, £. s. d., Total. Includes Alexander, Colonel, Baird, John, of Knoy-dart.

Total41 5 0

Donations.

Table with 2 columns: Name, £. s. d. Includes Box at Life-boat, House.

Total£42 17 6

BALLANTRAE BRANCH.

Patron— JAMES HUNTER, Esq., Glenapp. President—

Rev. F. J. WILLIAMSON. Honorary Secretary—

Mr. WASON. Annual Subscriptions.

Table of annual subscriptions for Ballantrae Branch with 3 columns: Name, £. s. d., Total. Includes Hunter, James, Esq., M'Connel, W. Esq., Stair, The Earl of.

GIRVAN BRANCH.

Patron— The Right Hon. the EARL OF STAIR, K.T. Treasurer—

ALEXANDER MARTIN, Esq. Honorary Secretary—

WILLIAM FORSYTH, Esq. Annual Subscriptions.

Table of annual subscriptions for Girvan Branch with 3 columns: Name, £. s. d., Total. Includes Aitken, Robert, Stair, Right Hon., Earl of (2 years), Young, J. G. K., of Glendoune.

IRVINE BRANCH.

President— GEORGE BROWN, Esq., Provost. Vice-Presidents—

Capt. DAVID BOYLE, R.N., of Shevalton, &c. JOHN PATERSON, Esq., of Knothead.

Honorary Secretary— JAMES DICKIE, Esq. Annual Subscriptions.

Table of annual subscriptions for Irvine Branch with 3 columns: Name, £. s. d., Total. Includes Alexander, Hugh, Alston, Chas. H., Armour, James, Begg, John S., Boyle, Captain, R.N., Boyd, H. F., Brown, Geo., Brown, Capt. James., Brown, J. C., Calderwood, Hugh., Christie, Wm., Clark, Capt., Dalzell, A. C., Drummond, J., Eglinton, Earl of, Eglinton, Chemical Co., Limited, Finnie, Archibald, Springhill, Galloway, And. C. E., Harrett, Capt., Gilmour, Alexander, Gilmour, John, Goudie, James, Gray, David, Hamilton, Alexander, Henderson, Robert, Henderson and Co., Wm., Hight, H. M., Holmes, Miss, Jaffrey, Rev. H., Johnston, John, Longmuir, Alex., Macgregor, Capt., Mackie, James.

Total£41 5 0

Table of annual subscriptions for other branches including Macredie, Mrs. Mure, Perceton, Marr, Capt., Mathieson, Baillie, M'Jannet, Wm., M'Kinlay, William, Morris, Capt. A. F., Paterson, John, Knowe-head, Pipe, James, Porteous, Mrs., Rose, Mrs., Ross, Z. M., Smith, A. B., Sommerville, Rev. Jas., Stewart, James, Wilson, Dr., Wilson, Jas., Wyllie, John, Young, Mrs., Sums under 5s., Total £34 11 0.

TROON BRANCH.

Honorary Secretary— ALEXANDER WYLLIE, Esq. Subscription.

Gilmour, Allan, £1 0 0. Donations.

Table of donations for Troon Branch with 3 columns: Name, £. s. d., Total. Includes Alexander, Col., M.P., Calderwood, H., Cook, Duncan, Cowan, Rev. A. H., Craig, J. & M., Kil-marnock, Cunningham, W. S., of Caprington, Finnie, Archd. & Son, Finnie, Miss, Fleming, Rev. Jas., Galloway, John, Kil-marnock, Guthrie, James, Horne, John, & Sons, Houldsworth, W. H., Kirkwood, Rev. Jno., Logan, Jno., Russell, E., Troon Shipbuilding Company, Wood, James, Boxes in Custom House and Post Office, Total £18 7 2.

Total£18 7 2

Table of annual subscriptions for other branches including Ainslie, A. D. Esq., Allan, John, Esq., Banff Shipping, Bow, Alex. Esq., Bryson, W. G. Esq., Campbell, F. G. Esq., Coutts, Provost, Cumming, Geo. Esq., Cumming, Gordon, Colonel, Diggins, Mrs., Duff, M. E. Grant, Esq. M.P., Duff, Hon. G. Skene, Duff, R. W. Esq. M.P., Duff, Major Gordon, Forbes, Colonel, Geddie, Rev. J. W., Gordon, W. and C., Hannay, John, Esq., Harvey, John, Esq., Hunter, Rev. Wm., M'Connell, M. P., M'Connell, Donald, Esq., Natal, Macduff, Cmercl. Co., Macduff Shipping, Macfarlane, Alex. Esq., Manson, Dr., Martin, Provost, Milne, Dr., Moncrieff, Sheriff Scott, Morison, Mrs. of Bog-nie, Murray, G. W. & Co., Nicol, Andrew, Esq., Nisbet and Co., Russell, Trustees of late Misses, Scott, Alex. Esq., Simpson, J. Esq., Sinclair, Arthur, Esq., Tayler, W. J. Esq., Walker, Rev. George, Watt, Alex. Esq., Watt, Capt. James., Box at Boat-house, Sums under 5s., Bank Interest, Total £52 14 3.

Total£52 14 3

BUCKIE BRANCH.

President— The Right Hon. the EARL OF SEAFIELD. Chairman—

W. R. DUGUID, Esq., M.D. Honorary Secretary—

JOHN SHEARER, Esq. Donations.

Table with 2 columns: Name, £. s. d. Includes Russell's Trust, Misses, Aberdeen, £5 0 0.

Total£5 0 0

Banffshire.

BANFF AND MACDUFF BRANCH.

President— THE EARL OF FIFE. Chairman—

WILLIAM COUPTS, Esq., Provost of Banff. Deputy Chairman—

JAMES MARTIN, Esq., Provost of Macduff. Treasurer and Hon. Sec—

JAMES WATT, Esq. Annual Subscriptions.

Table of annual subscriptions for Banff and Macduff Branch with 3 columns: Name, £. s. d., Total. Includes Fife, Earl of, Seafield, Earl of, K.T., Abercromby, Sir R. Et., Mackie, James.

Total£5 0 0

Edinburgh.

DALKEITH BRANCH.

President—
ALEXANDER MITCHELL.
Vice-President—
WILLIAM PORTEOUS.
Treasurer—
JOHN CRAIG.
Secretary—
ALEX. BALLANTYNE, M.D.

Table with columns for names and amounts. Includes 'Annual Subscriptions 1877' and a 'Total' of £16 10 6.

EDINBURGH AND LEITH BRANCH.

Chairman—
ADM. SIR ALEXANDER MILNE, BART., G.C.B.
Honorary Secretary—
ROBERT SINCLAIR, Esq., 18 Waterloo Place.

Table with columns for names and amounts. Includes 'Annual Subscriptions' and a list of names with their respective contributions.

Table with columns for names and amounts. Lists names such as Alston, Anderson, and various Messrs. with their contributions.

Table with columns for names and amounts. Lists names such as Brown, Bruce, Bryden, and various Messrs. with their contributions.

Table with columns for names and amounts. Lists names such as Cunningham, Dalziel, Davidson, and various Messrs. with their contributions.

£.	s.	d.	£.	s.	d.
Scott Brothers	5	0	Tod, J. H., Esq.	10	0
Scott, T.	5	0	Tod, J. W., Esq.	5	0
Scottish Iron S.S. Insurance Association	5	0	Tod, Robert, Esq.	1	0
Seymour, Mrs.	5	0	Torry, John, Esq.	5	0
Shand, Hon. Lord	1	0	Trinity House, The	2	0
Suand, Mrs.	1	0	Trotter, Mrs.	5	0
Shepherd, Mrs.	5	0	Trustees of the late James Dalgleish, Esq.	10	0
Shiels, J. S., Esq.	1	0	Turnbull, John, Esq.	5	0
Sibbald, John, Esq.	5	0	Turnbull, Mr. & Mrs.	10	0
Shields, Robert & Son	5	0	Turnbull and Wilson, Messrs.	5	0
Sidey, Charles, Esq.	5	0	Tytler, G. M., Esq.	1	0
Sidey, Dr.	5	0	Usher and Co. Messrs.	1	0
Sim and Barclay, Messrs.	5	0	Andrew	1	0
Simpson, Jno. A., Esq.	1	0	Usher, Messrs. J. & T.	2	0
Simpson, Mrs.	1	0	Urnistoun, Mrs.	10	0
Simpson, Mrs.	5	0	Waddell, Mrs. Peddie	5	0
Simon, David, Esq.	5	0	Waddie & Co. Messrs.	5	0
Simon, Mrs.	10	0	Waddilove, Miss	5	0
Simon, Mrs.	5	0	Waldie and Son, Messrs. James	5	0
Sinclair, R., Esq.	10	6	Walker, A., Esq.	5	0
Silmon, Messrs. R. and D.	5	0	Walker, James, Esq.	1	0
Smith and Co. Messrs. D.	5	0	Walker, Mrs.	5	0
Smith and Son, Messrs. John	10	6	Walker, Messrs. G. and J.	10	0
Smith, J., Esq.	5	0	Warden and Co. Messrs. William	5	0
Smith, Messrs. T. and H.	10	0	Warrack and Co. Messrs. John	1	0
Smith, Miss	5	0	Warrick and Son, Messrs.	10	6
Smith, Miss C. R.	1	0	Waterson, Sons, and Stewart, Messrs.	1	0
Smith, Mrs.	5	0	Watson, H. G., Esq.	2	0
Sommerville and Co. Messrs. John	10	0	Watson, Mrs. D.	5	0
Sommerville, Miss	5	0	Watson, John, Esq.	1	0
Spence, Mrs.	5	0	Watt, James, Esq.	10	6
Sprague, T. B., Esq.	5	0	Wauchope, Moodie, and Hope, Messrs.	1	0
Sprot, Misses	5	0	Weir, Mrs. G.	5	0
Steel, Coulson, and Co. Messrs.	5	0	Weir and Co. Messrs. R. M. Rolland	10	0
Steven, Miss	10	0	White, Burns, & Co. Messrs.	10	0
Stevenson, Miss	10	0	White & Co. Messrs.	5	0
Stevenson, Mrs.	5	0	White, John, Esq.	5	0
Stevenson, Rev. R. H. D.D.	5	0	White, Mr. John	5	0
Stewart, Chas., Esq.	5	0	White, Moir, and Co. Messrs.	5	0
Stewart, Clapperton, and Co. Messrs.	5	0	Whyte and Son, Messrs. A.	5	0
Stewart, Messrs. J. and G.	5	0	Whyte, Miss	5	0
Stewart, James, Esq.	5	0	Williamson, Charles, Esq.	10	6
Stewart, John, Esq.	5	0	Wilson, A. H., Esq.	1	0
Stewart, Mrs.	5	0	Wilson, Dr.	5	0
Stewart, Mrs. Grainger-Sirling, Mrs.	5	0	Wilson, W. S., Esq.	10	0
Stuart, Miss	5	0	Wishart and Sons, Messrs. James	1	0
Stuart, R. L., Esq.	1	0	Wishart, D. F., Esq.	10	6
Swan & Son, Messrs. J.	5	0	Wood & Co. Messrs.	5	0
Syme, Miss	10	6	Wood, John A., Esq.	5	0
Syme, Mrs.	5	0	Wood, Misses	5	0
Syme, Mrs.	5	0	Wood, W., Esq.	1	0
Sums under 5s.	36	12	Wren, Mr. George	5	0
T. H. O.	5	0	Wright, Messrs. P. and R.	5	0
Tainsh, James, Esq.	10	0	Wright, Miss H.	5	0
Taylor & Co. Messrs. W.	1	0	Wright, Gutrie	10	0
Taylor, Arch., Esq.	5	0	Wright, John P., Esq.	5	0
Taylor, Mr. William	5	0	Wright, J. Christie, Mrs.	5	0
Taylor, MacLeod and Co. Messrs.	5	0	Young, James, Esq.	5	0
Tennant, R.	10	0	Young, J. W., Esq.	10	0
The Singer Machine Manufacturing Co.	5	0	Young, Mrs.	10	0
Thomas, Capt. F. W. L., R.N.	10	0	Young, Mrs. R.	5	0
Thomson, Chas. W., Esq.	5	0	Younger, Mr. John	5	0
Thomson and Co. Messrs. R. H.	10	6	Younger, Robt., Esq.	10	0
Thomson and Co. Messrs. W.	10	6	Younger and Co. Messrs. W.	1	0
Thomson, J. G., Esq.	10	0			
Thomson, Miss	5	0			
Thomson, W. T., Esq.	10	0			
Thomson & Co. Messrs. T. J.	10	6			
Tod, Henry, Esq.	5	0			

London & Edinburgh Shipping Co.	2	0	0
Milne, Admiral, Sir Alexander, G.C.B.	3	3	0
Total Dons.	10	6	6
Total Subs.	391	8	0
£401	14	6	

MUSSELBURGH BRANCH.

President—Admiral Sir ALEXANDER MILNE, BARR., G.C.B.
Vice-President—The Right Hon. LORD ELPHINSTONE.
Chairman—PROVOST KAIR.
Treasurer and Hon. Secretary—JOHN RAMSAY, Esq.

Annual Subscriptions.

Aitchison, Colonel	5	0	
Banks, Mrs. Thomas	5	0	
Beveridge, Rev. J. G.	5	0	
Black, A. D. M., Esq.	10	0	
Caird, Mr. Alexander	5	0	
Carse, Mr. Thos.	5	0	
Currie, Mr. John	5	0	
Deans and Moore, Messrs.	5	0	
Fergusson, Mrs. J. A. D.	5	0	
Hope, Major-Gen.	10	0	
Home, Mr. A. M.	10	0	
Hope, Sir Archibald, Bart.	1	0	
Hunter, Mr. Henry H.	5	0	
Kemp & Co. Messrs. J.	5	0	
Legat, Mr. John	5	0	
Livingstone, Mr. John	10	0	
Macfarlane, Mr. A. D.	5	0	
Menzies, Mrs.	5	0	
Millar, Mrs., Spring Bank	5	0	
Millar, Mr. James	5	0	
Milne, Adm. Sir Alex. Bart.	2	6	
Mitchell, Mr. Alex.	5	0	
Ramsay, John	5	0	
Smart, Mr. Charles	5	0	
Smith, Rev. C.	10	0	
Stirling, Brothers	5	0	
Stuart, Messrs. J. & W.	1	0	
Thomson, Mrs. C. J.	5	0	
Whitelaw, Mr. David	5	0	
Wilkie, Messrs. J. & A.	10	0	
Contributions under 5s.	4	13	0
Total	217	16	6

Elginshire.

LOSSIEMOUTH BRANCH.

Chairman—Capt. J. B. DUNBAR BRANDEE of Pitgavay.
Honorary Secretary—Mr. WILLIAM FRASER.

Annual Subscriptions.

Anderson, Capt.	5	0
Anderson, Wm., Esq.	1	0
Brander, Capt. Dunbar	2	0
Brander, R., Esq.	5	0

Cameron, Alex., Esq.	10	6	
Forsyth, D., Esq.	5	0	
Forsyth, Miss	5	0	
Gatherer, Geo., Esq.	5	0	
Jameson, James, Esq.	5	0	
Johnstone, Major	5	0	
Levack, Mr. John	5	0	
Macdonald, Wm.	10	6	
Maitland, Miss	10	6	
McLean, Dr.	5	0	
Milne, J., Esq.	5	0	
Morrison, A.	5	0	
Munro, John	5	0	
Priest and Co. Messrs. Wm.	5	0	
Richmond, His Grace the Duke of	1	0	
Robertson, Miss	7	6	
Sellar, J. and Sons	5	0	
Smith, Sheriff	5	0	
Stuart, J. P., Esq.	5	0	
Webster, Dr.	5	0	
Weir, Rev. Wm.	5	0	
Wood, Mrs.	10	0	
Sums under 5s.	5	4	6

Total 15 19 0

Donations.

Vessels entering Harbour	6	17	0
Total	422	16	0

Fi eshire.

ANSTRUTHER BRANCH.

President—His Worship the Provost.
Honorary Secretary—H. B. MACKINTOSH, Esq.

Annual Subscriptions.

Adamson, John, Esq.	10	0	
Cook, David, Esq.	5	0	
Darste, Mrs. G.	10	6	
Darste, J. R., Esq.	1	0	
Ellice, E., Esq.	1	0	
Forbes, R., Esq.	7	6	
Fowler, G. S., Esq.	1	0	
Fowler, Miss	7	6	
Irvine, W. D., Esq.	1	0	
Jamieson, W. T., Esq.	7	6	
Lloyd, Rev. F. K.	5	0	
Mackintosh, H. B., Esq.	10	6	
Martin, John, Esq.	5	0	
Murray, Wm., Esq., J.P.	10	6	
Olyphant, P., Esq.	10	6	
Sea Box Society	1	1	0
Sharp and Murray, Esqrs.	10	0	
Watson, Provost	5	0	
Williamson, Milligan and Co. Messrs.	2	0	0
Williamson, Mrs.	10	0	
Williamson, S., Esq. M.P.	1	0	0
Woodcock, Dr. R.N.	5	0	
Contribution Box	12	0	
Sums under 5s.	5	14	0

Total £20 8 6

BRANCHES—LIST OF ANNUAL SUBSCRIPTIONS AND DONATIONS. 145

DUNFERMLINE BRANCH.	
President—	
EX-PROVOST MATHIESON.	
Honorary Secretary—	
ROBERT STREEDMAN, Esq.	
Annual Subscriptions.	
£.	s. d.
A Lady Friend	1 0 0
Alexander, Daniel	5 0 0
Alexander, Thomas	1 0 0
Barclay, John	5 0 0
Bardner, Henry	5 0 0
Beveridge, Erskine	10 0 0
Beveridge, H.	10 0 0
Clark, W. and Son	5 0 0
Donald, Robert	1 0 0
Dunbar, Rev. J. W.	5 0 0
Hay, James	5 0 0
Hay, Mrs.	5 0 0
Hay and Robertson	1 0 0
Landale, John	1 0 0
Macfarlane, James	1 0 0
McLaren, John and William	10 0 0
Mathieson, K.	5 0 0
Mathewson, James	10 0 0
Mathewson, William	1 0 0
Morris, Dr.	5 0 0
Nicholson, W.	5 0 0
Ramsay, Robert	5 0 0
Reid, Robert	5 0 0
Reid, Wm.	5 0 0
Romanes, Archibald	5 0 0
Rutherford, D. G.	5 0 0
Sampson, John	5 0 0
Seath, Alexander	5 0 0
Scobie, Andrew	5 0 0
Smith, Adam	5 0 0
Spewart, Thomas	1 0 0
Steedman, Robt.	5 0 0
Stewart, R. W.	5 0 0
Taylor, Mrs. Peter	5 0 0
Walker, Thomas	1 0 0
Wallace, Andrew	1 0 0
Walls, James	5 0 0
Wardlaw, Jas. L.	5 0 0
Westwood, Wm.	5 0 0
Wilson, John	5 0 0
Wilson, Robert M.	10 0 0
Sums under 5s.	6 11 6
Total	£25 1 6

ST. ANDREW'S BRANCH.	
Chairman—	
Capt. JACKSON.	
Treasurer—	
ANDREW SYME, Esq.	
Honorary Secretary—	
GEO. MURRAY, Esq.	
Annual Subscriptions.	
£.	s. d.
Brown, Misses	5 0 0
City of St. Andrew's	5 0 0
Jackson, Capt.	5 0 0
McGregor, Gregor	5 0 0
Melville, J. W.	10 0 0
Olyphant, T. T.	10 0 0
Purtie, T.	10 0 0
Small, J. L.	5 0 0
Total	12 5 0
Donations.	
A Friend	2 6
Alexander, P. P.	5 0
Allen-Allen, Colonel	5 0
Balfour, J. H.	10 0
Bell, John	10 0
Bennett, J. L.	5 0
Bethune, Major	5 0
Boyd, A. K. H.	5 0
Brand, W.	1 0

£.	s.	d.
Bruce, Hon. H. P., M.P.	5	0
Campbell, J. S.	10	0
Carnegie, Hon. C.	1	0
Cathcart, R.	10	0
Christie, Gen.	10	0
Dalyell, R. A.	5	0
Elgin, Lord	10	0
Gillon, A.	5	0
Jackson, G. H.	10	0
Jamieson, J. A.	10	0
Kennard, E. H.	5	0
Lamb, Henry A.	5	0
Mansfield, A.	10	0
Mansfield, J. C.	1	0
McLaren, J. C.	5	0
Oswald, J. T.	10	0
Robertson, D. Argyle	5	0
Skene, W. B.	5	0
White, J. Logan	5	0
Wilson, W.	5	0
Collecting Box	1	0
Total	30	0
Annual Subscriptions in aid of "Ladies' Own" Life-boat, per Miss Smithers—		
A Friend, through Mrs. Prince	1	1
Clegg, E. A.	1	1
Hayward, Mrs.	5	0
Kershaw, J. S.	1	1
Law, Alfred	1	1
Law, William	1	1
Mayor, Miss (2 years)	5	0
Prince, Rev. W.	5	0
Prince, Mrs.	5	0
Smithers, Miss	5	6
Total	£36	16 0

Forfarshire.

ARBROATH BRANCH.	
Chairman—	
GEORGE SHIELD, Esq., Provost of Arbroath.	
Honorary Secretary—	
WM. CARGILL, Esq.	
Annual Subscriptions.	
£.	s. d.
Aitken, Mr.	5 0
Anderson, Mr. David	5 0
Balfour & Cummings, Messrs.	10 0
Binney, Mr. Andrew	10 0
Boyd, Mr. James	5 0
Briggs, W.	5 0
Burnet, Mr. William	5 0
Cargill, Mr. David	5 0
Carnegie, H. F. Lindsay, Esq.	10 0
Chapel, Mr. David	5 0
Christie, Miss	5 0
Corsar, Mr. Chas. W.	10 0
Corsar, Mr. Wm. H.	10 0
Corsar Bros. Messrs.	10 0
Dickson, Mr. Jas. A.	10 0
Dickson, Mr. J. F.	5 0
Donaldson, Mr. Robt.	5 0
Duncan, Mr. John	10 0
Ferguson, Messrs. J. and A.	5 0
Forbes, Mr. Thos.	5 0
Fraser and Sons, Messrs. D.	10 0
Fraser, Mr. Pat. A.	1 0
Gordon, A.	10 0
Guthrie and McCotquodale	5 0

£.	s.	d.
Jamieson, J.	5	0
Laird, Mr. George	10	0
Lowson, Mr. Andrew	10	0
Macdonald, J. & W.	10	0
Mitn, Mr. George	5	0
Muir, Mr. James	10	0
Munro and Co.	5	0
Nicol & Co. Messrs. A.	5	0
Pierson, Mrs.	1	0
Raitt, Mr. Jonathan	5	0
Reid, Mr. Alex.	5	0
Robertson, Geo.	5	0
Roy, Messrs. Adam & Sons	5	0
Salmond and Son, Messrs. W.	10	0
Salmond, Mr. Jos.	5	0
Shanks, Mr. James	5	0
Shield, George	10	0
Smart and Ogg	5	0
Stenhouse, John	5	0
Webster, Messrs. F. and Sons	10	0
Webster, Mr. Wm.	10	0
Weir, Mr. James	5	0
Sums under 5s.	3	12 6
Total	£21	2 6
Donations.		
Representatives of late Mrs. Gordon	10	0
Collected at Shore Dues Office	6	0
Collected in Box at Life-boat House	1	11
Parr, B.	2	1 1
Proceeds of old Stores	£39	5 6

DUNDEE BRANCH.

Chairman—	
WM. O. DALGLEISH, Esq.	
Treasurer—	
WM. CRAIGTON, Esq.	
Honorary Secretary—	
JAMES HUNTER, Jun., Esq.	
Annual Subscriptions.	
£.	s. d.
Alison, G. L. Esq.	1 1 0
Anderson, Alex. Esq.	1 0 0
Armitstead and Co. Messrs. G.	1 1 0
Baxter Brothers and Co. Messrs.	3 0 0
Baxter & Co., Messrs. W. E.	1 1 0
Couper, Thomas, Esq.	10 6
Don Brothers, Buist, and Co. Messrs.	1 1 0
Dundee Harbour Trustees	10 10 0
Dundee Shipping Insurance Association	2 2 0
Dundee, Perth, and London Shipping Company	1 1 0
Gibson, Joseph, Esq.	10 6
Gilroy, Sons and Co. Messrs.	1 1 0
Gourlay Brothers and Co. Messrs.	2 2 0
Grimond, Messrs. J. and A. D.	1 1 0
Laing, John, Esq.	10 6
Lowson, Wm. Esq.	1 1 0
McGavin, R. Esq.	1 1 0
Martin & Co. Messrs. D.	1 1 0
Masters and Seamen, Fraternity of	5 5 0
Miller, O. G. Esq.	1 1 0
Mollison, Mrs. F.	5 5 0
Myles, David, Esq.	1 1 0
Ogilvy, Sir J. Barr.	1 1 0

£.	s.	d.
Pearce, Mrs. A. M.	1	0 0
Popham, Mrs. Brunswick	1	0 0
Sandeman, C. S. Esq.	10	6
Sharp, John, Esq.	1	1 0
Smieton and Sons, Messrs. James	1	1 0
Smith & Co. Messrs. Henry	1	1 0
Stephen, Mrs. George	1	1 0
Union Association of Underwriters	5	5 0
Yeaman, James, Esq.	1	1 0
Total	£57	9 0

Donations.		
T. H. Whitson, Esq. Blairgowrie	10	0 0
Messrs. Kennedy & Rae	7	0
D. Pirie, Esq.	10	0
Box at Broughty Ferry	8	6
Dundee Harbour, Life-boat Dues on Shipping	57	8 1
Collected by John Machan, Esq. from Seamen frequenting the Port	7	19 0
Total Dons.	£76	12 7
Total Subs.	£57	9 0
Total	£134	1 7

MONTROSE BRANCH.

Chairman—	
PROVOST MITCHELL.	
Honorary Secretary—	
JAS. WARRACK, Esq.	
Annual Subscriptions.	
£.	s. d.
Abertein, F. Esq.	1 0 0
Anderson, Messrs. J. & Co.	5 0 0
Arkley, Robt. Esq.	2 2 0
Baxter, David, Esq.	5 0 0
Burnett, Alex. Esq.	5 0 0
Burrell, Geo. Esq.	5 0 0
Byers, Wm. Esq.	5 0 0
C. S.	10 6
Carnegy, Miss Elizabeth	2 0 0
Chalmers, Geo. C. Esq.	5 0 0
Dickson, Arthur, Esq.	10 6
Furfor, Capt.	5 0 0
Gibbons, R. Esq.	5 0 0
Gordon, Mrs. W.	1 0 0
Greig, A. Esq.	10 6
Interest from Harbour Trustees	30 0 0
Johnston, J. & Sons	5 5 0
Key, Dr. A.	10 6
Largie, Capt. A.	10 6
Lindsay and Son, Messrs. John	10 6
Low, George, Esq.	5 0 0
Lyall & Fell, Messrs.	5 0 0
Mackenzie & Sons, Messrs.	5 0 0
Mearns, Alex. Esq.	1 0 0
Middleton and Sons, Messrs. C.	7 6
Middleton, Thos. Esq.	10 0
Millar, R. & Sons	2 2 0
Milne, J. & Sons	10 0
Mitchell, David, Esq.	5 0 0
Mitchell, Wm. Esq.	1 0 0
Moir & Son, Messrs. Wm.	5 0 0
Montrose Lime Co.	10 0
Murray & Co.	10 6
Myers, Geo. C. Esq.	10 6
Reid, Capt. Henry	7 6

	£.	s.	d.
Renny, The Misses	1	0	0
Samson, James, Esq.	5	0	0
Savege, James, Esq.	10	6	0
Stansfeld, Capt. R.A.	2	0	0
Steele, Dr. H.	5	0	0
Walker, George, Esq.	5	0	0
Walker, R. Esq.	1	0	0
Warrack, J. and Co.	1	0	0
Watt, Alexr. Esq.	5	0	0
Whimster, W. S. Esq.	5	0	0
Small Subscriptions 1 19 4			
Total	63	17	10

Donations.
 Anonymous, per W. D. Johnston, Esq. 2 10 0
 Captain McLeay, Liverpool. - 10 0
 Messrs. Adams and Petrie - 10 6
£67 8 4

Haddingtonshire.

DUNBAR BRANCH.

President—
 THE DUKE OF ROXBURGH.
Chairman—
 RICHARD W. HUNTER
 of Thurston.
Honorary Secretary—
 G. R. SCOTT, Esq.
Annual Subscriptions.
 1878.

	£.	s.	d.
Anderson, W.	5	0	0
Brand, Provost	10	0	0
Buchanan, Rev. R.	5	0	0
Dodds, Rev. James	5	0	0
Hay, Capt. Baird	1	0	0
Hunter, Major	1	0	0
Kirkwood, J. J. and T.	10	0	0
Purves, Lt.-Col.	10	0	0
Scott, G. R. Esq.	1	0	0
Sums under 5s.	1	9	0
Total	£6	14	0

NORTH BERWICK BRANCH.

President—
 The Right Hon. LADY MARY HAMILTON.
Chairman—
 SIR HEW DALRYMPLE, BART.
Honorary Secretaries—
 WALTER MALCOLM, Esq.
 DAVID MACCULLOCH, Esq.
Annual Subscriptions.
 Campbell, W. Esq. 1 1 0
 Cree, James, Esq. 1 0 0
 Malcolm, Walter, Esq. 1 0 0
 McCulloch, D. Esq. 10 0
 Menzies, John, Esq. 1 1 0
 Woodrow, T. Esq. 10 6
Total 5 2 6

Donations.
 Collected at annual exercise of Life-boat on 31st August, including £5 from the Right Hon. Lady Mary Hamilton, the Earl of, £5; and Lady R. £5. 58 16 0

	£.	s.	d.
Beveridge, W. Esq.	10	0	0
Griegel, D. Esq.	10	0	0
Laurie, W. Esq.	10	0	0
Russell, Miss, Ashiesteil	10	0	0
Wedderburn, Sir D. M.P.	1	0	0
From Collecting Box at Boat-house	9	7	0
Total Dons.	62	5	7
Total Subs.	5	2	6
£67 8 1			

Wincadineshire.

GOURDIN BRANCH.

President—
 JAMES FARQUHAR, Esq.,
 Halgreen.
Chairman—
 HERCULES SCOTT, Esq.,
 Brotherton.
Honorary Secretary—
 Rev. JOHN BROWN,
 Bervie.

	£.	s.	d.
Anderson, Mr. David	5	0	0
Anderson, Mr. Wm.	5	0	0
Boath, Mr. David	5	0	0
Brown, Rev. John	10	0	0
Bryden, Mr. Wm.	10	0	0
Collins, Dr. A.	10	0	0
Cryden, Mr.	10	0	0
Craighead, Mr.	10	0	0
Dickson, Patrick, Esq.	10	0	0
Edwards, Mr. James	5	0	0
Farquhar, James, Esq.	5	0	0
Farquhar, Captain H. R., 24th Regt.	3	3	0
Forbes, Mr. Hector	5	0	0
Gibb, James, Esq.	10	0	0
Gladstone, Sir Thos.	3	0	0
Glegg, Messrs.	10	0	0
Legg, Mr. D.	1	0	0
Legg, M. A.	10	0	0
McKenzie, Mr. Wm.	5	0	0
Mollison, Mr.	10	0	0
Scott, Hercules, Esq.	10	0	0
Shand, T. L. R., Esq.	1	0	0
Somerhill, Mr.	10	0	0
Thom, Mr. John	5	0	0
Urquhart, Mr. Duncan	5	0	0
Will, Mr. George	5	0	0
Wilson, Provost	5	0	0
Total	31	8	0

STONEHAVEN BRANCH.

Patron—
 SIR THOS. GLADSTONE, BART.,
 Lord-Lieut. of the County.
President—
 JAMES G. SOUTAR, Esq.,
 Banker.
Treasurer & Hon. Secretary—
 DAVID CARR, Esq.

Annual Subscriptions.
 Baird, Alex. of Ury. 2 2 0
 Crockett, James. 5 0
 Davidson, late Mrs., interest on legacy of - 12 6
 Duff, R. W. Esq. 1 1 0
 Falconer, Robert 5 0
 Gladstone, Sir Thos. Bart. 2 0 0
 Greig, George A. 5 0
 Innes, Major 1 0 0
 Kinnear, A. W. 10 0

	£.	s.	d.
Jack, James	5	0	0
Lumsden, Mrs.	5	0	0
Martin, Thomas	5	0	0
M'Inroy, Colonel	2	0	0
Mowat, Wm.	5	0	0
Reddie, Captain J.G.	1	0	0
Ritchie, Wm.	1	1	0
Ross, Alex.	10	0	0
Scott, James	10	0	0
T. S.	5	0	0
Tindal, Robert	10	0	0
Watt, Rev. John	5	0	0
Wood, Alex.	5	0	0
Wyllie, George.	5	0	0
Sums under 5s.	4	19	6
Total	20	11	0

Donations.
 Sir Geo. Balfour, M.P. 2 0 0
 Collection Box at Boat-house - 8 6
£22 19 6

Kirkcudbright.

KIRKCUDBRIGHT BRANCH.

Patron—
 THE EARL OF SELKIRK.
Treasurer and Hon. Sec.—
 JAMES McMULDROW, Esq.
Annual Subscriptions.

	£.	s.	d.
Selkirk, Right Hon. the Earl of	3	3	0
Barbour, William, Esq.	1	1	0
Byrne, Dr.	10	0	0
Cowan, John, Esq.	1	0	0
Gordon, R. M. Esq.	5	0	0
Hamilton, Geo. Esq.	5	0	0
Kennedy, J. L. Esq.	1	0	0
Kenworthy, James, Esq.	5	0	0
Kirkcudbright, Burgh of	5	0	0
Martin, Wm. President.	5	0	0
Maxwell, Sir Wm., Bart.	2	2	0
Maxwell, W. H. Esq.	1	0	0
Maxwell, Mr. J. H.	10	0	0
Mackie, J. G. Esq.	2	2	0
McLellan, David, Esq.	5	0	0
McMuldrow, James, Esq.	5	0	0
Murray-Stewart, H. G. Esq.	1	1	0
Nicolson, Sheriff	5	0	0
Oswald, R. A. Esq.	1	0	0
Proprietors of the Dumfries Standard Robinson - Douglas, W. D. Esq.	1	1	0
Skirving, Adam, Esq.	1	0	0
Stewart, Robert, Esq.	1	1	0
Wigram, Loftus J., Berkeley Square, London, Esq.	1	1	0
Williamson, Provost	5	0	0
Sums under 5s.	1	19	2
Total	23	1	2

Donation.
 Gordon, Wm. Esq. 1 0 0
£29 1 2

LANARKSHIRE.

GLASGOW BRANCH.

Treasurer—
 JAMES A. SMALL, Esq.
Honorary Secretary—
 R. HOPE ROBERTSON, Esq.
Annual Subscriptions.

	£.	s.	d.
Addie, Robert, and Sons	2	2	0
Aitkin, Lilburn, and Co. Messrs.	1	1	0
Alexander, Ferguson, and Co. Messrs.	1	1	0
Alexander, A. Lennox	10	6	0
Alexander, Mr. J.	5	0	0
Alexander and Co. Messrs. R. F. & J.	1	1	0
Allan, Messrs. J. & A.	2	2	0
Alston, J. Carfrae	10	0	0
Amicus	10	0	0
Anderson, Messrs. D. and J.	2	2	0
Anderson and Co. Messrs. Geo.	1	1	0
Anderson and Co. Messrs. James	10	0	0
Arnott & Co. Messrs.	1	1	0
Arthur & Co. Messrs.	1	1	0
Arthur and Hinshaw, Messrs.	10	0	0
Auld & Guild, Messrs.	2	2	0
Austin and McAslan, Messrs.	10	6	0
Baird, Frank	10	6	0
Baird & Brown, Messrs.	1	0	0
Baird and Son, Messrs. Hugh	10	6	0
Baird, Frank	10	6	0
Bannatynes, Kirkwood, and McJanet	2	2	0
Barclay & M'Gregor, Messrs.	1	0	0
Barclay, Curle, and Co. Messrs.	4	4	0
Barr, W. B.	1	1	0
Bell & Sons, Messrs. John	1	1	0
Bell, Edmund	10	0	0
Bell, Messrs. J. & M. P.	1	1	0
Bennett, Browne, and Co. Messrs.	1	1	0
Berry, Barclay & Co.	1	1	0
Binnie, Thomas	10	6	0
Black & Co. Messrs. James	1	1	0
Black & Co. Messrs. John	2	2	0
Blackie & Sons, Messrs.	1	1	0
Bost and Co. A.	1	1	0
Boyle, Miss E. C.	1	0	0
British and African Steam Navigation Co.	2	2	0
British India Steam Navigation Company (Limited)	2	2	0
Brown & Co. Messrs. J. and T.	1	1	0
Brown & Co. Messrs. W. and A.	1	1	0
Brown, Downs, and Co. Messrs.	1	1	0
Brown, James, Esq.	2	2	0
Brown, jun., Davies & Tait, Messrs.	5	0	0
Brown, Sons, & Co. Messrs. Wm.	2	2	0
Browne and Watson	1	1	0
Browne, Easton, & Co. Messrs.	2	2	0
Brownlie and Co.	1	1	0
Browns & Co.	1	1	0
Bryce, J. D. Esq.	1	1	0

BRANCHES—LIST OF ANNUAL SUBSCRIPTIONS AND DONATIONS. 147

£.	s.	d.	£.	s.	d.	£.	s.	d.	£.	s.	d.				
Buchanan, Watson, and Co. Messrs.	1	0	0	Finlay & Co. Messrs. James	2	2	0	Johnston, James, Mr.	10	6	Martin, Turner, and Co. Messrs.	1	1	0	
Bulloch, Lade, & Co. Messrs.	2	2	0	Fisher and Watt, Messrs.	1	1	0	Kelly & Co. Messrs.	1	1	0	Mason, G. and R.	10	6	
Burnley and Co. Messrs. W. F.	2	2	0	Fleming, Messrs. P. and R.	1	1	0	Kerr, Anderson, Muir and Main, Messrs.	2	2	6	Middleton and Kirkpatrick, Messrs.	10	6	
Burns, Messrs. G. and J.	2	0	0	Forsyth, Miller, and Co.	1	1	0	Kerr, Newton, & Co. Messrs.	1	1	0	Miller & Son, Messrs. John	1	1	0
Burrell and Son, Messrs.	1	1	0	Fraser, Alex. Esq.	1	1	0	Kettle and Co. Messrs. R.	10	0	Miller and Co. Messrs. G.	2	2	0	
Calton Spinning Co.	1	1	0	Fraser and Sons, Messrs. John	1	1	0	Keydens, Strang and Girvin, Messrs.	10	6	Miller, James, Son, & Co. Messrs.	1	1	0	
Campbell and Co. Messrs. J. and W.	2	2	0	Fyfe and Morton, Messrs.	10	6	Kidston & Co. Messrs. A. G.	1	1	0	Mirreles, Tait, and Watson, Messrs.	2	2	0	
Campbell, Jas. A. Esq.	1	1	0	Gairdner, Chas. Esq.	1	1	0	Kidston and Sons, Messrs. Wm.	1	0	Mitchell, D.	1	1	0	
Campbell, Rivers, and Co. Messrs.	2	2	0	Galbraith, Messrs. A. and A.	2	0	0	Kirkpatrick, A. B.	10	0	Mitchell, Watson, and Wink, Messrs.	4	4	0	
Cargill, David S.	10	6	0	Garroway, Messrs. R. and J.	1	0	0	Laing and Co. Messrs. J.	1	1	0	Mitchells, Cowan, & Johnstone, Messrs.	1	1	0
Caw, David	5	0	0	Gibb, Elias, Esq.	10	6	0	Laird, Alex. A. & Co.	1	1	0	Moncreiff, Paterson, Forbes, & Barr, Messrs.	2	2	0
Chaplin and Co. Messrs. Alexander	1	1	0	Gilbert, Messrs. Cramer	4	0	0	Lamont & Co. Messrs. Henry	1	0	0	Moore and Browne, Messrs.	10	6	
Chrystal, Robert, Esq.	1	1	0	Gibson, Robt. T.	1	1	0	Langlands and Sons, Messrs. M.	1	1	0	Moore, Taggart, and Co. Messrs.	1	1	0
Clark and Co.	2	2	0	Giffillan, J. and T.	10	6	0	Lecky, F. B.	1	1	0	Mossend Iron Co.	1	1	0
Clark, Messrs. J. Jun. and Co.	2	2	0	Glasgow Iron Co.	2	2	0	Leisler, Bock, and Co. Messrs.	2	2	0	Munice & Co. Messrs. Geo.	1	1	0
Clyde Shipping Co.	2	2	0	Glen, Mrs.	2	2	0	Liepmann, Lehmann, and Co. Messrs.	1	1	0	Murdoch and Co. Messrs. Robt.	1	1	0
Clyde Yacht Club	2	2	0	Gourlay, Robt.	1	1	0	Lietkie & Co. Messrs.	1	1	0	Napier and M'Intyre, Messrs.	2	2	0
Coate, Messrs. J. & P.	2	2	0	Gourlie and Son, Messrs. William	1	1	0	Lorimer & Moyes	1	1	0	Neill, Messrs. J. & R.	5	0	
Cochran, A. and R.	1	1	0	Govan and Son, Messrs. Wm.	1	1	0	Lumsden, Geo. Esq.	2	2	0	Neilson & Co. Messrs.	2	2	0
Cochran, J. R.	1	0	0	Gow and Co. Messrs. Allan C.	1	1	0	Lumsden, Sir James	2	2	0	Neuhaus, Chas.	1	1	0
Collins, Sons, and Co., Messrs. William	2	2	0	Graham, John, Esq.	1	1	0	MacArthur and Farie	1	0	0	Nisbet, Messrs. A. & J.	1	1	0
Connal & Co. Messrs. Connal & Co. Messrs. William	1	1	0	Graham & Co. Messrs. J. and A.	2	2	0	MacAulay and Co. Messrs. James	5	0	0	Nitshill and Lesmahagow Coal Co.	2	2	0
Connell and Co. Messrs. Charles	1	1	0	Grant & Son, Messrs. G.	1	1	0	MacBean and Co. Messrs. H.	10	6	0	Owners of barque <i>Jane Ure</i> , per Messrs. Browne & Watson	5	0	
Craig, Messrs. R. and J.	1	1	0	Gray, Dunn, and Co. Messrs.	1	1	0	MacBryne, D.	1	1	0	Owners of barque <i>Annie</i> , per Messrs. Browne & Watson	5	0	
Craik, Messrs. R. and J.	1	1	0	Gray, Mrs. Walter	1	1	0	MacFarlane, Geo. Gray	1	1	0	Do. <i>Bina Campbell</i> , per do.	5	0	
Craik, Messrs. R. and J.	1	1	0	Gray, Mrs. Walter	1	1	0	MacFarlane & Co., Messrs. Walter	2	0	0	Do. <i>Eliza Campbell</i> , per do.	5	0	
Craik, Messrs. R. and J.	1	1	0	Gray, Mrs. Walter	1	1	0	MacFarlane, Geo. Gray	1	1	0	Do. <i>Isabella Ure</i> , per do.	5	0	
Craik, Messrs. R. and J.	1	1	0	Gray, Mrs. Walter	1	1	0	MacFarlane & Co., Messrs. Walter	2	0	0	Do. <i>Jessie</i> , per do.	5	0	
Craik, Messrs. R. and J.	1	1	0	Gray, Mrs. Walter	1	1	0	MacFarlane & Co., Messrs. Walter	2	0	0	Do. <i>Maggie Brown</i> , per do.	5	0	
Craik, Messrs. R. and J.	1	1	0	Gray, Mrs. Walter	1	1	0	MacFarlane & Co., Messrs. Walter	2	0	0	Do. <i>Martha Reid</i> , per do.	5	0	
Craik, Messrs. R. and J.	1	1	0	Gray, Mrs. Walter	1	1	0	MacFarlane & Co., Messrs. Walter	2	0	0	Do. <i>Mary</i> , per do.	5	0	
Craik, Messrs. R. and J.	1	1	0	Gray, Mrs. Walter	1	1	0	MacFarlane & Co., Messrs. Walter	2	0	0	Do. <i>Marg. Mitchell</i> , per do.	5	0	
Craik, Messrs. R. and J.	1	1	0	Gray, Mrs. Walter	1	1	0	MacFarlane & Co., Messrs. Walter	2	0	0	Do. <i>Marg. Craig</i> , per do.	5	0	
Craik, Messrs. R. and J.	1	1	0	Gray, Mrs. Walter	1	1	0	MacFarlane & Co., Messrs. Walter	2	0	0	Do. <i>Ada Browne</i>	5	0	
Craik, Messrs. R. and J.	1	1	0	Gray, Mrs. Walter	1	1	0	MacFarlane & Co., Messrs. Walter	2	0	0	Do. <i>Pasley, Jardine, and Co. Messrs.</i>	1	1	0
Craik, Messrs. R. and J.	1	1	0	Gray, Mrs. Walter	1	1	0	MacFarlane & Co., Messrs. Walter	2	0	0	Do. <i>Paterson and Son, Messrs. Wm.</i>	1	1	0
Craik, Messrs. R. and J.	1	1	0	Gray, Mrs. Walter	1	1	0	MacFarlane & Co., Messrs. Walter	2	0	0	Do. <i>Paterson, A. & W.</i>	1	1	0
Craik, Messrs. R. and J.	1	1	0	Gray, Mrs. Walter	1	1	0	MacFarlane & Co., Messrs. Walter	2	0	0	Do. <i>Paterson, Andrew, Esq.</i>	1	1	0
Craik, Messrs. R. and J.	1	1	0	Gray, Mrs. Walter	1	1	0	MacFarlane & Co., Messrs. Walter	2	0	0	Do. <i>Pearson, Adam, and Co.</i>	1	1	0
Craik, Messrs. R. and J.	1	1	0	Gray, Mrs. Walter	1	1	0	MacFarlane & Co., Messrs. Walter	2	0	0	Do. <i>Pirrie, Foote, and Co. Messrs.</i>	1	1	0
Craik, Messrs. R. and J.	1	1	0	Gray, Mrs. Walter	1	1	0	MacFarlane & Co., Messrs. Walter	2	0	0	Do. <i>Pitkethly, Jas. Esq.</i>	1	1	0
Craik, Messrs. R. and J.	1	1	0	Gray, Mrs. Walter	1	1	0	MacFarlane & Co., Messrs. Walter	2	0	0	Do. <i>Phillips, John, & Co. Messrs.</i>	10	6	
Craik, Messrs. R. and J.	1	1	0	Gray, Mrs. Walter	1	1	0	MacFarlane & Co., Messrs. Walter	2	0	0	Do. <i>Raalte, Jacques van & Co.</i>	1	1	0
Craik, Messrs. R. and J.	1	1	0	Gray, Mrs. Walter	1	1	0	MacFarlane & Co., Messrs. Walter	2	0	0	Do. <i>Raeburn, James, Esq.</i>	1	1	0
Craik, Messrs. R. and J.	1	1	0	Gray, Mrs. Walter	1	1	0	MacFarlane & Co., Messrs. Walter	2	0	0	Do. <i>Ralston, Goodwin & Co. Messrs.</i>	1	1	0
Craik, Messrs. R. and J.	1	1	0	Gray, Mrs. Walter	1	1	0	MacFarlane & Co., Messrs. Walter	2	0	0	Do. <i>Ramsay, John, Esq.</i>	10	0	
Craik, Messrs. R. and J.	1	1	0	Gray, Mrs. Walter	1	1	0	MacFarlane & Co., Messrs. Walter	2	0	0	Do. <i>Rankin and Sons, Messrs. W.</i>	10	6	
Craik, Messrs. R. and J.	1	1	0	Gray, Mrs. Walter	1	1	0	MacFarlane & Co., Messrs. Walter	2	0	0	Do. <i>Rankin and Son, Messrs. James</i>	1	1	0
Craik, Messrs. R. and J.	1	1	0	Gray, Mrs. Walter	1	1	0	MacFarlane & Co., Messrs. Walter	2	0	0	Do. <i>Rattray Brothers, & Smith, Messrs.</i>	1	1	0
Craik, Messrs. R. and J.	1	1	0	Gray, Mrs. Walter	1	1	0	MacFarlane & Co., Messrs. Walter	2	0	0	Do. <i>Reid and Son, Messrs. Alex.</i>	1	1	0
Craik, Messrs. R. and J.	1	1	0	Gray, Mrs. Walter	1	1	0	MacFarlane & Co., Messrs. Walter	2	0	0	Do. <i>Rethwisch, C. Esq.</i>	1	1	0
Craik, Messrs. R. and J.	1	1	0	Gray, Mrs. Walter	1	1	0	MacFarlane & Co., Messrs. Walter	2	0	0				

£.	s.	d.
Rintoul, Son, and Co.		
Messrs. Peter.....	1	1
Ritchie and Co.		
Messrs. Jas.....	1	1
Robb, Moore, & Co.		
Messrs.....	10	6
Robertson, John, Esq.	1	1
Robertson & Baxter,		
Messrs.....	10	6
Robertson, Messrs.		
L. and E. H.....	1	1
Robertson and Smith,		
Messrs. W.....	5	0
Robertson, Heugh, &		
Co. Messrs.....	10	6
Rodger, James, Esq.	1	1
Rodger, Mrs.....	1	1
Rose, Murison, and		
Thomson, Messrs.	1	1
Ross & Co. Messrs.		
W.....	1	1
Ross, Mrs.....	1	0
Rowley and Dick,		
Messrs.....	10	6
Russell, Miss J. G.....	1	0
Sandeman and Co.		
Messrs. D.....	10	6
Sandeman, J. G.....	1	1
Seligmann, H. L. Esq.		
and Son.....	10	6
Semple, McLean, &		
Reid, Messrs.....	1	1
Simpson, Hunter,		
& Young, Messrs.,	1	1
Simons, Jacobs and		
Co. Messrs.....	5	0
Skinner and Co.		
Messrs. Thomas..	1	1
Skinner and Sons,		
Messrs. W.....	1	1
Sloan & Co. Messrs.		
William.....	2	2
Smith, Messrs. A.		
and W.....	10	6
Smith and Sharp,		
Messrs.....	2	2
Smith and Sons,		
Messrs. George...	2	2
Smith and Wellstood,		
Messrs.....	10	6
Smith, George, & Co.		
Messrs.....	2	2
Snodgrass, Messrs. J.		
and R.....	1	1
Steel, Conison, and		
Co. Messrs.....	1	1
Stephen and Son,		
Messrs. Alexander	2	2
Stevenson, J. Esq. .	2	2
Stewart, Messrs. Andrew		
and James.....	1	1
Stewart and Co.		
Messrs. John.....	1	1
Stewart & McDonald,		
Messrs.....	3	3
Stewart, R.....	1	1
Stewart, D. Y. & Co.		
Stonelaw Colliery...	10	6
Summerlee Iron Co.		
Symington, Rogers,		
and Co. Messrs. .	5	0
Tasker, James.....	10	6
Tatlock, Robert R.		
Taylor, Laughland,		
and Co. Messrs.....	1	1
Taylor, Robt.....	1	1
Teacher and Sons,		
Messrs. William..	2	2
Templeton and Co.		
Messrs. James.....	2	2
Tennant and Co.		
Messrs. Charles...	3	3
Thomson, Neale...	1	1
Thomson, Sir Wm. .	1	1
Train & Co. Messrs.		
Thomas.....	1	1
Turnbull and Co.		
Messrs.....	10	6
Turnbull and Co.		
Messrs. Gregor...	2	2
Turnbull, Martin, &		
Co.....	1	1

£.	s.	d.
Ure, John, Esq.	1	1
Walker, A. Esq.....	1	1
Walker & Co. Messrs.		
John.....	10	6
Walker & Hamilton,		
Messrs.....	10	6
Wallace, William...	5	0
Watson, Gow, and		
Co. Messrs.....	1	1
Watson and Smith,		
Messrs. James....	2	2
Watson and Co.		
Messrs. James....	1	1
Watson Bros.....	1	1
Watson, John E....	10	6
Wenley, J. A.....	1	1
Wharrie, Colledge &		
Brand, Messrs.....	10	6
White, Messrs. James		
and John.....	5	0
Wilkie, Wm. Esq. .	1	1
Williamson, T.....	1	1
Wilson and Son,		
Messrs. Jas.....	1	1
Wilson, Mathison, &		
Co. Messrs.....	10	6
Woodrow, Alexander,		
& Sons, Messrs....	10	6
Wotherspoon and Co.		
Messrs. R.....	1	1
Wright, Mr. J. Brooks		
1.....	1	1
Wright, Johnstone,		
and Mackenzie,		
Messrs.....	2	2
Total.....	399	9

Donations.

Association of Underwriters	20	0	0
A Friend, per R. H. Robertson	10	0	0
Total Dons.....	30	0	0
Total Subs.....	399	9	6
£429	9	6	

Linlithgowshire.

KIRKLISTON BRANCH.

President—
Rev. J. C. BURNS.

Honorary Secretary—
MR. JOHN GARDINER.

Annual Subscriptions.

£.	s.	d.
Blair, Miss.....	7	6
Burns, Mrs.....	10	0
Carmichael, Mrs.....	5	0
Duncan, Miss M.....	1	0
Duncan, Miss.....	1	0
Hog, T. A. Esq.....	5	0
Hunter, W. B. Esq. .	5	0
Stewart and Co.,		
Messrs.....	10	0
Sums under 5s.....	1	6
Total.....	£5	8

Nairnshire.

MORAY FIRTH BRANCH.

Treasurer & Hon. Secretary—
H. T. DONALDSON, Esq.,
Solicitor, Nairn.

Annual Subscriptions.

£.	s.	d.
Dunbar, Sir James		
Alexander.....	10	0
Forres, Town of....	2	2

Donations.

Brodie, Hugh, Esq. .	5	0	0
Cameron, Dr.....	1	1	0
Clarke, A. Esq.....	10	0	0
Davidson, Hugh, Esq.	2	0	0
Fraser, Capt.....	1	0	0
Fraser, Robert, Esq.	2	2	0
Howden, John, Esq. .	1	0	0
Leslie, Provost....	10	6	0
Fife, Lord.....	5	5	0
Mackintosh, Bailie			
Hugh.....	2	0	0
Parker, Home, Esq. .	1	0	0
Rose, Rev. H. F.....	5	0	0
Rose, Major James .	1	0	0
Rose, Mr. Hugh....	1	0	0

Total.....£31 0 6

Orkney Islands.

LONGHOPE BRANCH.

Chairman—
J. G. MOODIE HEDDLE, Esq.

Honorary Secretary—
EDWARD E. CORRIGALL, Esq.

Annual Subscriptions.

£.	s.	d.
Heddle, J. G. Moodie,		
Esq.....	3	3
Corrigall, Edward E.		
Esq.....	5	0
Coll. in Small Sums	4	13
Total.....	£	8

STROMNESS BRANCH.

Honorary Secretary—
Capt. G. BILTON.

Annual Subscriptions.

Earl of Zetland....	5	0	0
Mowat, Capt. Jas....	1	0	0
Shearer, James,			
Coxswain.....	5	0	0
Spence, Jas. Esq.,			
Banker, Stromness	7	6	0

Total.....£6 12 6

Peeblesshire.

PEEBLES BRANCH.

President—
T. H. ORPHOTT, Esq.,
Sheriff-Substitute.

Honorary Secretary—
Dr. CONNELL.

Annual Subscriptions.

£.	s.	d.
Bathgate, Mr.....	5	0
Black, Capt., Kailzie	1	1
Blackwood, Mr.....	5	0
Buchan, Mr. W.....	5	0
Burgess, Rev. R. .	5	0
Currie, Rev. D.....	5	0
Hay, Sir Robert, Bart.	1	1
Hunter, Mrs.....	5	0
Melrose, Mr.....	5	0
M'Gildowny, Mr.....	1	1
Murray, Rev. A.....	5	0
Panton, Mr.....	10	6
Romanes, R. S.....	10	6
Scott, Mr. Milkiston	6	0
Stirling, Mr.....	5	0
Stuart, Mr.....	1	1
Tennent, Mr.....	2	2
Thomson, Rev. A.....	5	0
Thorburn, Mr. M.....	10	0
Thorburn, Mr. R.....	10	6
Thorburn, Mr. W.....	10	6
Tod, Mr., St. Mary's		
Mount.....	2	2
Williamson, Mr. R.....	5	0
Sums under 5s.....	1	16
Total.....	£15	17

Renfrewshire.

GREENOCK BRANCH.

Chairman—
JAMES STEWART, Esq.

Honorary Secretary—
E. MAXWELL, Esq., H.M.'s
Customs.

Annual Subscriptions.

£.	s.	d.
Baine & Johnstone,		
Messrs.....	2	2
Blackwood & Gordon,		
Messrs.....	1	1
Brymner, G. Esq....	10	6
Caird, C. S. Esq....	1	0
Caird, J. T. Esq....	2	2
Carmichael and Co.		
Messrs. J. H. & A. .	1	1
Carmichael, T. Esq. .	1	1
Cartsburn Sugar Re-		
fining Co.....	1	0
Clapperton, J. Esq. .	10	6
Crawford, Messrs.		
W. and J.....	1	1
Cuthbert, Robert, Esq.	1	1
Davie, Robert, Esq. .	10	0
Greive, W. Esq.....	2	0
Hogg, Allison, & Co.		
Messrs.....	1	1
Johnstone, D. Esq....	2	0
Kerr & Co. Messrs.		
John.....	2	2
Lamont, Jas. Esq. .	1	0
Lindsay and Co.		
Messrs. W.....	1	1

£. s. d.	Scott, Rev. Hill	£. s. d.
Low, L. & Co.....	1 1 0	
Lyle, Abram, Esq.....		
Lyle, John	5 0	
McArthur, Wm. Esq. 1 0 0	5 0	
McCun, James, Esq. 1 1 0	10 0	
McIver, W. & Co.	10 0	
Morton, James, Esq. 1 1 0	5 0	
Neill, Dempster and	5 0	
Neill.....	5 12 0	
Neill, R. & S. Messrs.		
Orr, Hunter, and Co.	5 12 0	
Messrs.....		
Reid & Co. Messrs. J. 1 1 0		
Richardson and Co.	£16 13 0	
Messrs. James.....		
Robertson and Mc-		
Dougall, Messrs....		
Scott, Alexander, and		
Sons, Messrs.....		
Shankland, Messrs.		
D. and R.....		
Spiers, Lady.....		
Steele and McCaskill.		
Steele & Co. Messrs.		
Robert.....		
Stewart, Messrs. J.		
and W.....		
Swinsburne, Capt. R.N.		
Thorne and Sons,		
Messrs. R.....		
Walker and Co.		
Messrs. John.....		
Total.....	51 3 0	
<i>Donations.</i>		
Gamble, Mrs.....	10 0 0	
Munn, Miss.....	25 0 0	
Pillar Boxes—		
Princess Pier Box. 1 11 0		
Customs Quay.....	1 3 0	
Total Dons.....	37 14 0	
Total Subs.....	51 3 0	
	£88 17 0	

Roxburghshire.**KELSO BRANCH.**

President—
Rev. JAMES SMITH.

Honorary Secretary—
ALEXANDER MUIRHEAD, Esq.

Annual Subscriptions.

£. s. d.
Brown, J. J. E. Esq. 1 0 0
Cunningham, Mrs.
Douglas, Dr. C.
Douglas, Dr. Frank... ..
Douglas, Miss.....
Hogg, John, Esq.....
Hood, Miss.....
Johnston, E. Esq.....
Johnston, Messrs.
J. and J.....
Johnston, W. Esq.....
Lugan, P. Esq.....
Lugan and Porteous ..
Main, A. W. Esq.....
McDougall, Miss Scott 2 0 0
Milne Brothers.....
Muirhead & Purves ..
Purves, Mrs.....
Redpath and Co.....
Robertson, J. Esq.....
Robertson, P. Esq.....
Robertson, Mrs. Shaw ..

MELROSE BRANCH.

President—
Admiral the Hon. T. BAILLIE.

Honorary Secretary—
JOHN BROAD, Esq.

Annual Subscriptions.

£. s. d.
Amos, Miss.....
Baillie, Admiral the
Hon. T.....
Baillie, Hon. Mrs.....
Baillie, Lady Grisell ..
Baillie, Major the
Hon. R.....
Broad, John, Esq.....
Curle, Alex. Esq.....
Curle, James, Esq.....
Curle, Mrs.....
Dunn, Ralph, Esq.....
Erskine, Charles, Esq.,
Chiefswood.....
Erskine, Charles, Esq.,
Waverley Lodge.....
Freer, Allan, Esq.....
Grierson, Dr.....
Henry, General.....
Meikiam, John, Esq.....
Park, W. R. Esq.....
Polwarth, Lord and
Lady.....
Robertson, A. Esq.....
Smith, Mrs. Darulee ..
Smith, Miss E. M.....
Tod, the Misses.....
Sums under 5s.....
Total.....

Total £15 15 0

Stirlingshire.**BANNOCKBURN BRANCH.**

Treasurer—
ED. L. WILSON, Esq.

Annual Subscriptions.

£. s. d.
Coll. by Miss Currie—
Wilson
Mrs. Col.
Wilson
Rev. John .. 5 0
Wilson's
Jas. Academy, pupils for
1878.....
Do, do. 1879.....
Sums under
5s.....
Coll. by Miss Buchan—
Wilson
Mrs. W. 1 1 0
Sums under
5s.....
Total.....

Collected by Miss

£. s. d.
Learmouth—
Wilson
Mrs. Ed.
L.....
Ronald, Mr.....
A Friend .. 5 0
Sums under
5s.....
Galbraith, Mrs. W. R. 1 1 0
Wilson, Alex. Esq..... 1 1 0
Wilson, Ed. L..... 1 1 0
Collected by Miss Mercer—
Sums under 5s.....
Total.....

Total £11 8 6

STIRLING BRANCH.

Chairman—

HENRY DRUMMOND, Esq.

Hon. Treasurer—

Mr. DANIEL FERGUSON.

Honorary Secretary—

Mr. JOHN JENKINS.

Annual Subscriptions.

Gentleman and Ferguson, Misses, collected by—
Gentleman, Eben.
Esq.....
Mitchell, Mr. Thos.....
Ormond, Rev., D.D.....
Richardson, J. B.
Esq.....
Wilson, Mrs.....
Wright, Mrs.....
Sums under 5s.....
Johnston, Miss Jane,
collected by—
Anderson, Mrs.....
Burden, Mr. P.....
Chalmers, Rev. J.....
Colquhoun, Miss.....
Drysdale, Mr. Wm.....
Fraser, Mrs.....
Frew, Miss.....
Gray, Mr. James.....
Hamilton, Misses.....
Monteith, Mrs.....
Munnoch, Mrs.....
McEwen, Mrs.....
McKenzie, Rev. C.....
Owen, Mr. George.....
Paterson, Rob. Esq.....
Paton, Mrs., of
Viewforth.....
Steel, Mrs.....
Reid, Mrs.....
Smith, Mrs., of
Brentham Park.....
Taylor, Mrs. Pitt.....
Todd, Miss.....
Walker, Mrs.....
Wright, Misses, of
Clifford Park.....
Sums under 5s.....
Miller, Miss, collected by—
Aitken, J. G., Esq.....
Anderson, Mrs.
W. A.....
Bell, Mrs. Bellin-
dene.....
Bell, Mrs.....
Bruce, Mrs. James.....
Craigie, Mr. John.....
Cunliff, Mrs.....
Christie, Ex-Baillie
Cuthbertson, Mrs.....
Cuthbertson, Dr.....
Galbraith, Misses.....
Galbraith, Dr.....
Galbraith, T. L.
Esq.....

£. s. d.
Gibson, Mrs.....
Guthrie, Mrs.....
Lander, M. Esq.....
Monteath, Mrs. A.....
Mitchell, Mrs.....
Morrison, Miss.....
McJames, Robt. Esq.....
McMath, Mr.....
Rae, Mrs.....
Reid, Mrs. James.....
Smyth, Mrs.....
Ward, H. Esq.....
Welsh, P. Esq.....
Sums under 5s.....

Hon. Treasurer, collected by—

Ferguson, Mr. D.....
Forrester, Misses.....
Robertson Bros.
Messrs.....

Miller, Miss, collected by—

Anderson, Provost.....
Baird, Ex-Dean of
Guild.....
Carson, Mr. D. R.....
Cowbrough and
Mercer, Messrs.....
Dowdy, Mr. Wm.....
Drummond, Henry,
Esq.....
Duncanson, Mr.
Wm.....
Graham, Wm. Esq.....
Jenkins, A. and J.,
Messrs.....
Lennox, Mr. John.....
Mactarlane, Mr.
John.....
Mathie, Jas. Esq.....
McEwen, John, Esq.....
Menzies, Mr. Thos.....
Millar, Jas. & Sons,
Messrs.....
Morton, Mr. D.....
Morrison, J. M. Esq.....
Muir, A. L. Esq.....
Muirhead & Archibald, Messrs.....
Murie, ex-Provost.....
Philp, J. L. Esq.....
Shearer, Dean of
Guild.....
Smith, Mr. James.....
Taylor, Robt., Esq.....
Walls, Mr. Robert.....
Sums under 5s.....

Drummond, Miss, collected by—

Carson, Mrs.....
Cordis, Miss.....
Fernie, Thos. Esq.....
Hunter, Miss.....
Howat, Mrs.....
Jack, Mrs.....
Kemp & Nicholson,
Messrs.....
Oliphant, Mrs.....
Robertson, Miss.....
Spiers, Miss.....
Sums under 5s.....

Total £57 19 0

Wigtown.

ISLE OF WHITHORN AND BAY OF WIG-TOWN BRANCH.

Patron—
The Right Hon. the EARL OF GALLOWAY.

President—
R. H. JOHNSTON STEWART, Esq.

Chairman—
LT.-COL. JOHN FLETCHER HATHORN, of Castle Wigg.

Honorary Secretary—
ALEXANDER MACFIE, Esq.

Annual Subscriptions. £. s. d.

Galloway, Right Hon. the Earl of	5	0	0
Bute, The Most Noble the Marquis of	1	0	0
Black, E. S. Esq.	10	0	0
Blair, E. Stopford, Esq.	2	2	0
Brown, James	5	0	0
Campbell, Mrs.	5	0	0
Charters, John	5	0	0
Clephane, Jasper, Esq.	5	0	0
Donnan, Alex.	5	0	0
Donnan, E.	5	0	0
Donnan, James	5	0	0
Duff, James	5	0	0
Gifford, Mr.	5	0	0
Gourlay, R.	5	0	0
Gourlay, Wm.	5	0	0
Hathorn, Colonel J. F.	1	0	0
Hawthorn, Charles	5	0	0
Kennedy, Capt. W. R. R.N.	1	0	0
Lawrie, R. C.	7	6	0
Macfie, Alex.	5	0	0
McCandlish, J.	5	0	0
McClure, Wm.	5	0	0
McConnell, J. A.	5	0	0
McCracken, A. E.	5	0	0
McGuffie, Jas. Esq.	5	0	0
McKie, Geo.	5	0	0
McLean, J. Esq.	10	0	0
McMaster, Hugh Junr.	5	0	0
McMaster, P.	5	0	0
Martin, John G.	5	0	0
Maxwell, Sir Herbert E., Bart., M.P.	5	0	0
Maxwell, Lady	2	0	0
Maxwell, D., Newton Stewart	1	1	0
Murray, Thos. Esq.	10	0	0
Nicholson, John, Esq.	5	0	0
Parlane, James, Esq.	2	2	0
Routledge, C. M.	5	0	0
Routledge, Thos.	5	0	0
Scott, Robert	5	0	0
Selby, Dr.	5	0	0
Smith, William	5	0	0
Spedding, Capt.	5	0	0
Stewart, Alex.	5	0	0
Stewart, Hugh, Esq.	10	0	0
Stewart, Hugh	5	0	0
Stewart, R. H. J. Esq.	1	1	0
Sums under 5s.	3	18	6
Total	£35	8	0

PORT LOGAN AND BAY OF LUCE BRANCH.

Patron—
The Right Hon. the EARL OF STAIR, K.T.

President—
JAMES McDONALL, Esq., of Logan.

Chairman—
MARK J. STEWART, Esq.

Honorary Secretary—
QUINTIN COCHRANE.

Annual Subscriptions. £. s. d.

Baird, John, Esq.	10	0	0
Baird, Thomas, Esq.	5	0	0
Charles, Rev. George	10	0	0
Cunningham, Rev. R.	10	0	0
Dodd, Ashley, Esq.	1	0	0
Frederick, David, Esq.	10	0	0
McCarlie, John, Esq.	5	0	0
McDonall, Jas. Esq.	5	0	0
McGreggor, Angus, Esq.	5	0	0
McTaggart, Mrs. O.	1	1	0
Maxwell, Sir Herbert E., Bart., M.P.	1	0	0
Mitchell, Alex. Esq.	1	0	0
Mitchell, Misses	5	0	0
Moore, J. Carrick, Esq.	2	2	0
Stair, The Earl of, K.T.	5	0	0
Stewart, Mark J. Esq.	1	1	0
Taylor, Alex. Esq.	10	0	0
Young, Robert, Esq.	10	0	0
Sums under 5s.	2	3	10
Total	£23	7	10

PORTPATRICK BRANCH.

Patron—
DAVID HUNTER BLAIR, Esq., of Dunskey.

Chairman—
JOHN McCLEW, Esq., J.P.

Honorary Secretary—
DAVID A. McCLEW, Esq.

Annual Subscriptions. £. s. d.

Balmer, Rev. S.	5	0	0
Forbes, A. C. Esq.	2	0	0
Hunter Blair, David, Esq.	10	0	0
McCaig, Alexander	1	0	0
McClew, John	2	2	0
McCracken, John	1	0	0
Paterson, John	1	0	0
Urquhart, Rev. Andrew	1	0	0
From Subscription Boxes on Boathouse door, &c.	3	16	5
Total	£22	3	5

Donation.
Mr. John Wallace .. 1 0 0

£23 3 5

IRELAND.

Co. Antrim.

BELFAST AND GROOMSPORT BRANCH.

Presidents—
The MARQUIS OF DONEGALL, The EARL OF DUFFRIN. Major R. PERCEVAL MAXWELL.

Chairman—
The Mayor of BELFAST.

Hon. Sec. at Groomsport—
Belfast—

ARTHUR HILL COATES, Esq.

Annual Subscriptions. £. s. d.

Adair, Mr. Hugh	5	0	0
Alexander, Messrs. J. & Co.	10	0	0
Andrews, Messrs. H. & Co.	5	0	0
Archer, Samuel, Esq.	5	0	0
Arnott & Co. Messrs.	10	0	0
Barkie, Mr. W. M.	5	0	0
Belfast Harbour Commissioners	10	0	0
Belfast Steamship Co.	2	2	0
Bell, Messrs. E. & Co.	10	0	0
Blackstaff Spinning Company	10	0	0
Boag, Robert, Esq.	5	0	0
Bristow, E. J. Esq.	10	0	0
Brown, David, Esq.	5	0	0
Brown and Sons, Messrs. John S.	5	0	0
Campbell and Co. Messrs. H.	10	0	0
Carlisle, Jas. Esq.	10	0	0
Carter, Wm. Esq.	1	0	0
Clarke and McMullan, Messrs.	5	0	0
Coates, John, Esq.	10	0	0
Coates, A. Hill, Esq.	1	0	0
Coates, Victor, Esq.	1	0	0
Coe, Sir Edward	1	0	0
Combe, Barbour, & Combe, Messrs.	10	0	0
Corry & Co. Messrs. J. P.	10	0	0
Cramer, Wood, & Co. Messrs.	10	0	0
Crawford, J. Sharman, Esq.	1	0	0
Crawford and Lockhart, Messrs.	1	0	0
Currell, & Co. Messrs.	1	0	0
Daniel, Junr.	1	0	0
Dixon, Fergusson, and Co. Messrs.	10	0	0
Donegall, The Marquis of	2	2	0
Duffrin, The Earl of	1	0	0
Duffin, Adam, Esq.	5	0	0
Dunville and Co. Messrs.	10	0	0
Edgar and Lowry, Messrs.	5	0	0
Emerson, Wm. Esq.	5	0	0
Ewart and Son, Messrs. W.	1	0	0
Ewing, Son, and Co. Messrs.	5	0	0
Finlay Brothers and Co. Messrs.	10	0	0
Gordon & Co. Messrs.	5	0	0
Green, Forster, Esq.	1	10	0
Grimshaw Brothers, Messrs.	5	0	0
Hamilton, Megaw, & Thompson, Messrs.	1	0	0
Hanson, J. Esq.	10	0	0
Harkness, Jas. Esq.	5	0	0

Harland and Wolff, Messrs.	2	0	0
Hart and Churchill, Messrs.	10	0	0
Henderson, J. A. Esq.	10	0	0
Henderson and Son, Messrs. R.	10	0	0
Henry, Messrs. A. & S.	5	0	0
Higginson, J. M. Esq. Hind and Sons, Messrs. John	1	0	0
Houston, John B. Esq.	1	0	0
Hughes, Edward, Esq.	5	0	0
Jaffé Brothers, Messrs.	5	0	0
Johnston, and Thompson, Messrs. W. J.	5	0	0
Kyle, Mrs.	10	0	0
Lemon, A. D. Esq.	10	0	0
Lindsay Bros. Messrs.	5	0	0
Lipman & Co. Messrs. Little & Co., Messrs. Jas.	10	0	0
Lytle and Sons, Messrs. John	5	0	0
Mateer & Co. Messrs. H.	10	0	0
Maxwell, R. P. Esq.	1	0	0
Maxwell, Mrs. P.	1	0	0
McCausland and Co. Messrs. S.	10	0	0
McCausland, Rev. A. H.	5	0	0
McClure, Sir Thomas, Bart.	5	0	0
McGee, John G. Esq.	5	0	0
McNeill, H. H. Esq.	5	0	0
McNeill, Wm. Esq.	1	0	0
McNeill, Malcolm, Esq.	10	0	0
Millar, Boyd & Reid, Messrs.	10	0	0
Moore, Brs., Messrs.	5	0	0
Moore and Winberg, Messrs.	10	0	0
Moore, James, Esq.	10	0	0
Mullan, Wm. Esq.	5	0	0
Murphy, Henry, Esq. M.D.	1	0	0
Murphy and Orr, Messrs.	5	0	0
Northern Spinning & Weaving Co.	5	0	0
Orr, Robert H. Esq.	1	0	0
O. C. P.	1	0	0
Patterson, Rich. Esq.	10	0	0
Patterson, R. L. Esq.	10	0	0
Pim, Messrs. E. & W.	5	0	0
Pim, Messrs. J. & Son	10	0	0
Purdon, H. S. Esq. M.D.	10	0	0
Richardson Brothers, Messrs.	1	0	0
Richardson, Sons, and Owden, Messrs.	1	0	0
Riddell, Saml. Esq.	1	0	0
Ritchie, W. B. Esq.	10	0	0
Robb and Co. Messrs.	5	0	0
Robertson, Leddle, and Ferguson	1	0	0
Robinson, John, Esq.	10	0	0
Robinson, W. A. Esq.	5	0	0
Royal Ulster Yacht Club	2	0	0
Seeds, Messrs. H. & W.	5	0	0
Shaw, Charles W. Esq.	5	0	0
Smith, Messrs. J. and T.	10	0	0
Stewart, Chas. Esq.	5	0	0
Tate, Alex. Esq.	10	0	0
Torrans, Jas. Esq.	1	1	0
Trimble, Mr. Saml.	5	0	0
W. C. F. D., Esq.	10	0	0
Wallace, Sir Richard, Bart.	5	5	0
Ward, Marcus, & Co. Messrs.	10	0	0
Ward, Robert E. Esq.	1	0	0
Workman, Messrs. J. and R.	10	0	0
Workman, Mrs. R. Sen.	1	0	0
Workman, Mrs. Robt.	1	0	0

BRANCHES—LIST OF ANNUAL SUBSCRIPTIONS AND DONATIONS. 151

Workman, Wm. Esq.	£	s.	d.
Workman, Messrs.	1	0	0
T. and G. A.	1	0	0
Workman, Rev. Rbt.	1	0	0
Jun.	1	0	0
Young & Mackenzie,			
Messrs.	—	10	0
Sums under 5s.	—	7	6
Total	88	2	6

Donations.
 Pillar Box at Northern
 Counties Railway
 Station 1 13 4
 £89 15 10

PORTRUSH BRANCH.

President—
 Major-General
J. BERESFORD SMYLY.
Vice-President—
 Rev. H. Ffoliott, M.A.
Treasurer—
 THOMAS BELLAS, Esq.
Honorary Secretaries—
 Rev. JONATHAN SIMPSON,
 W. E. CARVER, Esq., J.P.
Assistant Secretary—
 Mr. SAMUEL PATTON.
Annual Subscriptions.

Adams, J. Esq. J.P.	£	s.	d.
Anderson, James S.	—	5	0
Antrim, L. Countess of	—	3	0
Armstrong, Rev. W.	—	5	0
Bellas, H. and T.	—	10	0
Bevington, J. B. Esq.	—	10	6
Bevington, S. B. Esq.	—	10	6
Carr, John, Esq.	—	10	0
Carson, A. T. Esq. M.J.D.	—	5	0
Carver, W. E. Esq. J.P.	—	1	0
Chaine, Major	—	1	0
Cox, Mrs. S. L.	—	1	0
Cramsie, James, Esq.	—	10	0
Cramsie, Mrs.	—	10	0
Crooksbank, R. Esq.	—	10	0
Darcus, Col., J.P.	—	10	0
Denham, Mrs. Dr.	—	5	0
Fall, Daniel	—	10	0
Ffoliott, Rev. H., M.A.	—	10	0
Gordon, Joseph	—	5	0
Grant, P. Drummond	—	5	0
Gunning, Wm. A. Esq., J.P.	—	10	0
Hannay, Lt.-Col. J.P.	—	10	6
Huey, John	—	10	0
Hunter, Stewart	—	10	0
Knox, N. A. Esq.	—	1	0
Leslie, James E. Esq. J.P., D.I.	—	1	0
Lusk, John, Esq.	—	5	0
McElderry, T.	—	5	0
Montgomery, Capt. R. J., J.P.	—	1	0
Moore, J. S. Esq. J.P.	—	1	0
Moore, Miss.	—	5	0
Murray, Major, J.P.	—	1	0
O'Neill, Hon. E.	—	1	0
Orr, Rev. R. Holmes	—	10	6
Patrick, J. Esq. J.P.	—	10	0
Portrush Harbour Commissioners	—	2	2
Smyly, Major-Gen. John Beresford	—	1	0
Simpson, Rev. J.	—	1	0
Stannus, Miss	—	10	0
Taylor, D. Esq., J.P.	—	10	0
Taylor, Robert	—	1	0
Templetown, General. Rt. Hon. Lt. Visc.	—	1	0
Thompson, J.	—	5	0
Throughton, James	—	5	0
Turnly, J. Esq. J.P.	—	10	0
Waveney, Lord, Rt. Hon.	—	1	0

Wilson, Chas. Esq.	£	s.	d.
Wilson, David.	—	5	0
Young, Mrs. Jas.	—	10	0
Young, Miss	—	10	0
Young, J. Esq. J.P., D.L.	—	10	0
Young, Wm. A. Esq.	—	10	0
Total	35	14	0

Donations.
 Antrim Arms Hotel
 Box..... 5 1
 Coleman's Hotel Box .. 4 6
 Finlayson, Rev. John .. 5 0
 "First Fruits," Crum-
 lin Road, Belfast . 1 0 0
 Life-boat House Box .. 13 8
 Patton, Samuel..... 1 0 0
 Porter, Robert, Esq., .. 10 0
 Portrush Harbour
 Commissioners ... 5 0 0
 Per Miss Stannus:
 Stannus, Waiter,
 Esq..... 1 0 0
 Fitzgerald, Hon.
 Miss G. V..... 5 0
 Gidlow, Mrs..... 5 0
 Wayne, Miss..... 5 0
 Wayne, Miss A..... 5 0
Total Dons.10 18 3
Total Subs.35 14 0
£46 12 3

Co. Cork.

BALLYCOTTON BRANCH.

Patron—
 The Right Rev. the LORD
 BISHOP OF CORK, CLOYNE,
 AND ROSS.
President—
 E. F. LITTON, Esq., Q.C.
Honorary Secretary—
 T. W. STRANGMAN, Esq.
Annual Subscriptions.

Beale, Alfred, Esq.	£	s.	d.
Beale, Henry H. Esq.	—	5	0
Bristol General Steam Navigation Co.	—	1	0
Clyde Shipping Comp.	—	3	3
Cork, Lord Bishop of	—	1	0
City of Cork Steam Packet Company	—	5	0
Cunard Company	—	2	2
Evans, Archdeacon	—	10	0
Gaggin, George, Esq.	—	5	0
Goulding, Mrs. H. M.	—	1	0
Harrison, Mrs.	—	5	0
Henderson Brothers, Messrs. "Anchor Line" of Steam Ships	—	2	2
Inman, William, Esq. (of Inman Line)	—	2	2
Litchfield, W. Esq.	—	5	0
Litton, E. F. Esq. Q.C.	—	1	0
Longfield, Montifort, J. C. Esq.	—	2	0
Strangman, T. W. Esq.	—	10	0
Total	27	14	0

Donations.
 Collection Boxes on
 board steamers of
 City of Cork Steam
 Packet Co., per W.
 de Foubert, Esq... 9 2 3
£36 16 3

CORK AND QUEENS-TOWN BRANCH.

President—
 Vice-Admiral
 Wm. M. DOWELL, C.B.
 Commanding the Irish
 Station, Queenstown.
Treasurers—
 Sir THOS. TOWN, D.L., F.S.A.,
 Ballincollig, near Cork ;
 JAMES E. PIM, Esq., J.P., Cork.
Honorary Secretary—
 Capt. N. SUTTON, Queenstown.

Annual Subscriptions.

Barry, Arthur H. Smith, Esq., D.L., Fota	£	s.	d.
Barry, Capt. R. H. Smith, D. L., R.Y.S.	—	2	2
Beamish and Craw- ford	—	2	2
Beamish, Capt. J. Caulfield, J.P.	—	1	0
Bristol General Steam Navigation Co.	—	2	2
Buckle, Capt., R.N., H.M.S. Revenge	—	1	0
Byrne, Edward, Esq., Harbour Master, Cork	—	1	1
City of Cork Steam Packet Co.	—	5	0
Clyde Shipping Co.	—	2	2
Cork Harbour Com- missioners	—	10	0
Currey, P. Esq., Im- perial Hotel, Cork	—	1	0
Deaves Brothers	—	1	1
Guion and Co.	—	1	1
Hardy, Henry, Esq.	—	1	0
Harvey, G. N. & Sons, Queenstown	—	1	1
Hudgkinson, Lieut. W. E., R.N., Flag- Lieut. to Vice-Ad- miral Dowell, C.B.	—	1	0
Liverpool, Philadel- phia, & New York S. S. Co., per W. Inman, Esq.	—	2	2
McIver, D. and C. Queenstown	—	2	2
Murphy, James J. & Co., Lady's Well Brewery, Cork	—	5	0
National Steam Ship Co.	—	1	1
Queenstown Towing Co., per Capt. N. Sutton	—	1	1
Rushbrook, Miss	—	5	0
Scott, James, & Co., Queenstown	—	1	1
Tobin, Sir T., D.L.	—	1	1
White Star Line At- lantic Steamers, per Ismay, Imrie & Co.	—	5	0
Wise, J. P. Esq. J.P., Rostellan Castle	—	2	0
Total	60	2	0

Donations.
 Collected by Mr. Jas.
 Lyons, Mercantile
 Marine, Queenstown 16 0
 Collected by Mr. Wm.
 McDermott, Mercan-
 tile Marine,
 Cork .. 16 2
 Collected in Har-
 bour Office by
 Capt. N. Sutton,
 Deputy Harbour
 Master, Queenstown— 5 5

Harbour Master, Cork	£	s.	d.
Helberg, M.	—	5	7
Latrobe, Dr.	—	9	0
Seymour, Mr. N. G.	—	5	0
Tobin, Sir Thomas	—	13	0
Sums under 5s.	—	1	0
Total Dons.	9	14	4
Total Subs.	60	2	0
£69 16 4			

COURTMACSHERRY BRANCH.

Chairman—
 The Right Hon. the EARL OF
 SHANNON.

Honorary Secretary—
 Captain TOWNSEND.

Annual Subscriptions.

Boyle, Ladies	£	s.	d.
Cork Steam Ship Co.	—	5	0
Cunard Company	—	2	2
Foster, A. Esq.	—	10	0
Garde, Dr.	—	10	0
Leslie, Wm. B. Esq.	—	10	0
Shannon, Rt. Hon. the Earl of	—	5	0
Stawell, Col. St. L.	—	2	0
Alcock, J.P.	—	2	0
Sealy, John, Esq.	—	5	0
Townsend, Captain	—	10	0
Total	£21	7	0

YOUGHAL BRANCH.

Honorary Secretary—
 J. W. PIM, Esq.

Annual Subscriptions.

Allan, Mrs.	£	s.	d.
Duke of Devonshire	—	5	0
Drury & Sons, Messrs.	—	10	0
Farrrell, Mr. Richard	—	5	0
Fitzgerald, Rev. L.	—	5	0
Gorman, Mr. Patrick	—	10	0
Green, Miss C.	—	10	0
Green, Rev. William	—	10	0
Lloyde, G. W. Esq. J.P.	—	3	0
Ponsonby, C. W. T. Esq. J.P.	—	1	1
Sums under 5s.	—	5	0
Total	£12	1	0

Co. Down.

BALLYWALTER BRANCH.

Honorary Secretary—
 Rev. J. O'REILLY BLACKWOOD.

Annual Subscriptions.

Atkinson, Mrs.	£	s.	d.
Belfast Steam Ship- ping Co., per John McAfee, Esq.	—	5	0
McAfee, Esq.	—	2	2
Carmichael, Messrs. D. and W.	—	2	0
	—	10	0

	£.	s.	d.
Cleland, Mrs. (Bally-walter).....	5	0	0
Dunbar, Miss.....	1	0	0
Glover, Jas. B. Jun.	5	0	0
Greer, Rev. Geo. Sen.	5	0	0
Greer, Rev. Geo. Jun.	5	0	0
Honston, J. B. Esq.	1	0	0
Lyle, Rev. Edward.....	5	0	0
Mulholland, J. Esq., M.P.....	2	0	0
Sinclair and Boyd, Messrs.....	1	0	0
Stewart, Captain D. Hamill.....	2	0	0
Walker, Geo. Esq.....	10	0	0
Total.....	£11	12	0

Donations.

Heron, Aidens, Esq.	10	0	0
Lochart, Mr. Hugh	5	0	0
Total.....	£12	7	0

NEWCASTLE (DUN-DRUM) BRANCH.

Chairman—
WILLIAM BEERS, Esq.

Honorary Secretary—
Mr. Wm. HATWARD.

Annual Subscriptions.

Annesley, Earl.....	5	0	0
Annesley, Lady.....	1	0	0
Aston, Mrs.....	5	0	0
Baxter, Rev. J.....	5	0	0
Beers, Wm. Esq.....	1	0	0
Blakely, Miss.....	10	0	0
Blakow, Rev. J.....	5	0	0
Brush, Geo. Esq.....	10	0	0
Brush, Richd. Esq.....	1	0	0
Clarendon, S. Esq.....	10	0	0
Creery, C. Esq.....	5	0	0
Gould, Mr. Rd.....	5	0	0
Gray, Dr.....	5	0	0
Greer, J. W.....	5	0	0
Hamilton, Mrs., Killeshandra (sth don.)	3	0	0
Humphreys, Mrs.....	1	0	0
Humphreys, Capt. & Master	7	0	0
Kingscote, J. B. Esq.....	1	0	0
Knox, Mrs.....	5	0	0
McCraight, A. Esq.....	5	0	0
Murland, J. Esq.....	1	0	0
Murphy, J. Esq.....	5	0	0
Murphy, Mrs.....	5	0	0
Roden, Earl.....	4	0	0
Seymour, Rev. J.....	1	0	0
Shaw, W. Esq.....	5	0	0
Slack, Mrs.....	5	0	0
Smith, Rev. S. J.....	5	0	0
Stewart, Major	1	0	0
Trustees of the late Earl of Kilmorey	5	0	0
Wallace, W. N. Esq.....	1	0	0
Waring, Wm. Esq.....	1	0	0
Collection Boxes.....	1	13	6
Sums under 5s.....	3	7	0
Total.....	£37	7	6

TYRELLA BRANCH.

Honorary Secretary—
Rev. J. BRINGHAM, B.A.

Annual Subscriptions.

The Marquis of Downshire.....	5	0	0
The Dowager Marchioness of Downshire	1	0	0
Viscount Bangor.....	2	0	0

	£.	s.	d.
The Lady Amelia Montgomery.....	1	0	0
The Lady Matilda Montgomery.....	1	1	0
Lord de Ros	2	0	0
Atkinson, J. Brooke, Esq.....	10	0	0
Bingham, Rev. J.....	5	0	0
Bitney, Cpt., Oakley	10	0	0
Deacon, Rev. John J.....	10	0	0
Digney, Mr. P.....	5	0	0
East Downshire S. S. Co. Dundrum, per Mr. E. G. Henesey	2	2	0
Montgomery, Hugh, Esq.....	2	10	0
Nugent, Maj. Andrew	1	0	0
Pos, William T. Esq.....	1	0	0
Reid, J. Esq.....	10	0	0
Russell, C. Esq. J.P.....	10	0	0
Snayth, Rev. G. Gordon.....	10	0	0
Stempson, S. S. Esq. M.D.....	5	0	0
Waulfe, S. R. Esq.....	1	1	0
Total.....	£23	9	0

Co. Dublin.

DUBLIN BRANCH.

Patron—
HIS EXCELLENCY THE DUKE OF MARLBOROUGH, K.G., Lord-Lieutenant of Ireland.

Honorary Secretary—
THOMAS EDMONDSON, Esq.

Secretary and Collector—
Mr. J. PRICE

Annual Subscriptions.

	£.	s.	d.
Marlborough, His Excellency the Duke of.....	10	0	0
Allen, Richard, Esq.....	1	0	0
Arnott & Co. Limited, Messrs.....	5	0	0
Baker & Sons, Messrs. Wm.....	5	0	0
Baker, Wardell & Co.....	1	0	0
Ballantine, Alex.....	5	0	0
Bewley & Anderson.....	1	0	0
Bewley & Co. Messrs.....	1	0	0
Borough, Sir E. R., Bt.....	1	0	0
Boyle, Low, Murray, and Co. Messrs.....	2	0	0
British & Irish Steam-packet Company.....	2	2	0
Brooke & Son, Messrs. G. F.....	1	0	0
Brown, Thomas, and Co., Messrs.....	1	0	0
Cantrill & Cochrane.....	1	0	0
City of Dublin Steam-packet Company.....	2	2	0
Clibborn, Jas.....	5	0	0
Colquhoun, D. Esq.....	1	0	0
Cork Harbour Commissioners.....	10	0	0
Cowan and Co.....	1	0	0
Crowe, Wilson, & Co. Messrs., Limited.....	1	0	0
D'Arcy and Son, Messrs. John.....	2	0	0
De Veszi, Lord.....	2	0	0
Dixon, Jas.....	10	0	0
Doran, J. H. Esq.....	1	0	0
Drummond & Sons, Messrs. Wm.....	1	0	0
Dublin and Glasgow Steam-packet Co.....	2	2	0

	£.	s.	d.
Dublin and Liverpool Screw Steam-ship Company.....	2	0	0
Dublin Steam Printing Co.....	1	0	0
Edmundson and Co. Messrs. J.....	1	0	0
Egan, A. W. Esq.....	1	0	0
Ferrier, Pollock, and Co. Messrs.....	2	0	0
Findlater, J. Esq.....	2	2	0
Fisher, Thomas, Esq.....	10	0	0
Forster & Co. Messrs.....	1	0	0
Garrett, J. Esq.....	1	0	0
Gilbey, Messrs. W. and A.....	1	1	0
Green Bros. Messrs.....	1	0	0
Guinness, Sir A.E. Bt.....	2	0	0
Handcock, W. D.....	10	0	0
Hasteton, O'Donnor and Co. Messrs.....	10	0	0
Heiton & Co. Messrs.....	1	1	0
Hogg & Co. Messrs.....	1	0	0
Howell, P. Esq.....	1	0	0
Jacob, R. S. Esq.....	5	0	0
Jameson and Son, Messrs. John.....	2	0	0
Jameson, Pim, and Co. Messrs.....	2	2	0
Jameson and Co., Messrs. William.....	1	0	0
Kenny and Owens, Messrs.....	10	6	0
Kildare, Lord.....	5	0	0
Kinahan and Sons, Messrs.....	2	0	0
Lambert, Brien, and Co. Messrs.....	10	0	0
Leinster Club, Coll. by O.O'Brien, Esq.....	1	0	0
Allen, A. Esq.....	1	0	0
Blaxham, H. C. Esq.....	1	0	0
Chamberlaine, M. H. Esq.....	1	0	0
Cochrane, H.....	10	0	0
Doherty, W. Izod, Esq.....	1	0	0
Hodgson, E.M. Esq.....	10	0	0
McDermott, John, Esq.....	1	0	0
O'Donnell, Thos.....	10	0	0
Smith, P. A. Esq.....	1	0	0
Box.....	17	6	0
McCullagh, Son, & Co. Messrs. James.....	2	2	0
McDonnell & Co., Messrs. Thomas.....	1	0	0
MacMullen, Shaw, & Co. Messrs.....	1	0	0
McSwiney & Co. (Limited).....	2	0	0
Manders, Robt. & Co.....	2	0	0
Martin and Sons, Messrs. John.....	1	0	0
Martin, Messrs. T. and C.....	1	0	0
Miller, Adam, and Co.....	1	0	0
Moses, M. T.....	10	0	0
Ogilvy, Alex. Esq.....	1	0	0
Palgrave, Murphy, and Co. Messrs.....	2	2	0
Pattison, H. Esq.....	1	0	0
Pease, Mrs.....	2	0	0
Perrin, Rd. and Son.....	1	0	0
Pim, Bros. and Co. (Limited) Messrs.....	3	0	0
Roe, Henry, Jun.....	2	2	0
Ross and Walpole, Messrs.....	1	0	0
Scott, Bell, and Co. Messrs.....	10	0	0
Switzer, Fergusson, and Co. Messrs.....	1	0	0
Taylor, Messrs. W. and M.....	1	0	0
Tedcastle and Co. Messrs. R.....	1	0	0
Todd, Burns, and Co. Messrs.....	3	3	0
Todhunter, Jos. E.....	1	0	0
Turbett, Messrs. Rbt. & Jas.....	1	0	0

	£.	s.	d.
Watkins & Co. Joseph Messrs.....	2	0	0
Webb, J. H. & Co. (Limited).....	10	0	0
Webb, J. Esq.....	1	0	0
Weir, James and Co.....	1	0	0
Westby, Edward Percival, Esq.....	5	0	0
White, Joshua, Esq.....	1	0	0
Wilson, Wm. Esq.....	1	0	0
Woods & Co. Messrs. Adam.....	1	0	0
Wynyard, Maj.-Gen.....	1	0	0
Total.....	139	19	0

Donations.

Allen, A., bequest of late.....	2	0	0
In memoriam (A. M. B.) per Everard Hamilton, Esq.....	1	0	0
per Cane, Miss C.F.....	4	15	0
Edmundson, T.....	13	9	0
Helby, Captain J.....	3	10	0
Collecting Boxes:—			
S.S. Duke of Argyll.....	3	0	0
Duke of Leinster.....	15	9	0
Lord Clyde.....	6	9	0
Lord Gough.....	6	2	0
Collecting box, Inland Rev. Office.....	12	9	0
Gt. Northern Pillar Box, Dublin.....	6	7	0
Prince of Wales Hotel.....	18	11	0
Sums under 5s.....	1	0	10
Total Dons.....	16	14	6
Total Subs.....	139	19	0
Total.....	£156	13	6

KINGSTOWN BRANCH.

President—
The Most Noble the MARQUIS OF ORMONDE.

Honorary Secretary—
Commander the Hon. F. G. CROFTON, R.N.

Annual Subscriptions.

Barton, H. L., D.L.....	5	0	0
Barton, Miss.....	3	0	0
Browne, Mrs. R. F.....	1	0	0
Bruce, Miss.....	5	0	0
Burroughs, Rev. W.E.....	10	0	0
Chatterton, the Vice-Chancellor.....	2	0	0
Close, S. H. Esq.....	1	0	0
Coghill, Sir J. J. Bart.....	1	0	0
Dalton, Rev. G. W.....	10	0	0
Dalton, G. E. R. Esq.....	5	0	0
Daly, Hon. Skellington.....	2	0	0
Dillon, Hon. L. G.....	10	0	0
Dudgeon, J. Hume, Esq.....	2	2	0
Elliott, Mrs.....	10	0	0
Giltmore, Mrs. J. S.....	5	0	0
Hogan, W. O. Esq.....	10	0	0
Hogan, J. F. Esq.....	10	0	0
Houghton, J. T. Esq.....	1	0	0
Hutchison, Com. R.N.....	10	0	0
Lodge, Miss.....	1	0	0
Lyle, J. A. Esq.....	1	0	0
Moorewood, Misses.....	1	0	0
Ormonde, Marquis of, Yacht <i>Mirage</i>	5	0	0
Reid, J. Hamilton, Esq.....	1	0	0
Royal Alfred Yacht Club.....	2	2	0
Royal Irish Yacht Club, per Committee.....	3	0	0

BRANCHES—LIST OF ANNUAL SUBSCRIPTIONS AND DONATIONS. 153

	£.	s.	d.
Somerville, Rear-Admiral.....	10	0	0
Wolf, Mrs.....	5	0	0
Total.....	37	4	0

Donations.

Collecting Boxes on Mail Steamers—			
Leinster.....	1	19	3
Munster.....	12	9	
Ulster.....	3	1	6
Pillar at Bray.....	1	6	6
Pillar Box at Kingstown Terminus.....	4	3	7
Seapoint and Salthill Stations.....	3	11	5
Total Dons.....	14	15	0
Total Subs.....	37	4	0
£61 19 0			

ROGERSTOWN BRANCH.

President—
Maj.-Gen. SIR ROGER PALMER, BART.

Chairman—
CHARLES COBBE, Esq., D.L.

Honorary Secretaries—
WM. C. TOWNSEND, Esq.
R. BUTLER, Esq.

Annual Subscriptions.

Brooke, The Misses.....	1	0	0
Butler, R. Esq.....	1	0	0
Cobbe, Charles, Esq.....	2	0	0
Jameson, John, Esq. (two years).....	2	0	0
Palmer, Colonel Sir Roger, Bart.....	5	0	0
Perrin, M. Esq.....	1	0	0
Total.....	£12	0	0

SKERRIES AND BALBRIGGAN BRANCH.

Chairman—
ION TRANT HAMILTON Esq., M.P.

Honorary Secretaries—
HENRY A. HAMILTON, Esq., J.P., Balbriggan.
HENRY H. FOSTER, Esq., Skerries.

Annual Subscriptions.

B—, Miss, per C. Cobbe, Esq.....	10	0	0
B—, Miss G., per C. Cobbe, Esq.....	10	0	0
Cobbe, Charles, Esq.....	1	1	0
Foster, H. H.....	1	0	0
Gowan, Francis, Esq.....	1	0	0
Grogan, Rev. John.....	1	1	0
Hamilton, H. A. Esq.....	1	1	0
Hamilton, Ion T. Esq., M.P.....	2	0	0
Hamilton, Mrs.....	1	1	0
Hussey, M. S. Esq.....	1	1	0
Hutchinson, Hon. Mrs. C. Hely.....	1	1	0
James, Jameson, Esq.....	1	1	0
Palmer, Sir R. Bart.....	2	0	0
Pepper, T. St. George, Esq.....	1	1	0
Scriven, Dr.....	1	1	0
Talbot de Malahide, Lord.....	1	1	0

	£.	s.	d.
Taylor, Col. Rt. Hon. T. E., M.P.....	2	0	0
Warren, Rev. L. C.....	1	1	0
Woods, Hans H. Esq.....	1	1	0
Total.....	21	12	0

BALBRIGGAN BRANCH.

Chairman—
EDWARD HAMILTON WOODS, Esq., J.P.

Honorary Secretaries—
H. A. HAMILTON, Esq., J.P.
Mr. WM. GEORGE PERCIVAL.

Annual Subscriptions.

Grogan, Rev. John.....	1	0	0
Hamilton, Henry A. J.....	1	0	0
Poppleton, R. J. Esq.....	1	1	0
Total.....	£3	2	0

Co. Kerry.

TRALEE BAY BRANCH.

President—
The Rt. Hon. LORD VENTRY

Vice-President—
Lieut.-Col. CROSBY.

Honorary Secretary—
Mr. ROBERT MCCOWEN, Lloyd's Agent.

Annual Subscriptions.

A Friend, per A. Denny, Esq.....	10	0	0
Crosbie, Col.....	2	0	0
Crosbie, W. T. Esq.....	1	0	0
Day, J. F. Esq.....	1	0	0
Denny, Major A.....	1	0	0
Denny, F. McG. Esq.....	1	0	0
Denny, R. Esq.....	1	0	0
Denny, W. Esq.....	1	0	0
D'Orpen, Rev. Rd.....	1	0	0
Donovan, Sir H.....	1	0	0
Donovan & Sons, John 2	2	0	0
Downing, F. C. Esq.....	1	0	0
Hawkey, Capt.....	1	0	0
Hickson, P. O. H. Esq.....	1	0	0
Huggard, S. Esq.....	1	0	0
Hurley, J. D. Esq.....	1	0	0
Hussey, S. M. Esq.....	1	0	0
Kenmare, Lord.....	2	0	0
Lassett, A. B. Esq.....	1	0	0
Latchford, R. Esq.....	1	0	0
Leahy, J. R. Esq.....	1	0	0
Leigh, Major W.....	1	0	0
Listowel, Lord.....	2	0	0
Lumsden, J. Esq.....	1	0	0
McCowan, R. Esq.....	1	0	0
McGillicuddy, D. De C. Jun. Esq.....	1	0	0
McGillicuddy, D. De C. Sen. Esq.....	10	0	0
Morphy, Charles, Esq.....	5	0	0
Neligan, J. C. Esq.....	2	2	0
O'Connor, James, Esq.....	1	0	0
Palmer, R. E. Esq.....	1	0	0
Stock, P. Esq.....	1	1	0
Wade, Rev. W.....	1	0	0
£36 10 0			

VALENTIA BRANCH.

Honorary Secretary—
The KNIGHT of KERRY.

Assistant Hon. Secretary—
Mr. JOHN O'DRISCOLL.

Annual Subscriptions.

Butler, James, Esq.....	1	0	0
Crosbie, W. T. Esq. 1877-8.....	2	0	0
Day, Rev. J. Fitz-Gerald.....	10	0	0
Dunraven, The Earl of 1	1	0	0
Fitzgerald, J. F. Esq.....	10	0	0
Hartopp, E. B. Esq.....	1	0	0
Kerry, The Knight of 1	0	0	0
Lansdowne, The Marquis of.....	3	0	0
Leahy, John, Esq. (Reps.).....	1	0	0
Mahony, Richd. Esq.....	1	0	0
Dromore.....	1	0	0
O'Connell, Dan, Esq.....	1	0	0
Derrynane.....	1	0	0
Slaughter, T. A. Esq.....	1	0	0
Trench, John T. Esq.....	10	0	0
Trinity Col. Dublin.....	3	3	0
Winn, Hon. Rowland 1	0	0	0
Total.....	£18	14	0

Co. Limerick.

LIMERICK BRANCH.

Secretary and Collector—
Mr. J. PRKE.

Annual Subscriptions.

Alexander, Jas. Esq.....	1	0	0
Bannatyne, J. & Son.....	1	0	0
Beauchamp, W. M. Esq.....	1	0	0
Boyd, J. and G.....	1	0	0
Brown, Robt. L.....	5	0	0
Clarina, Lady.....	1	0	0
Cochrane, William.....	5	0	0
Daly and Co. Limited, Messrs. John.....	1	0	0
Fitt, Edward.....	10	0	0
Harris, Messrs., and Sons.....	1	0	0
Jacob, Joshua.....	10	0	0
Limerick Harbour Commissioners.....	5	0	0
Matterson and Sons, Messrs.....	1	0	0
Russell and Sons, Messrs. Jno. N.....	2	2	0
Shaw & Sons, Messrs. W. J.....	1	0	0
Spaight and Sons, Messrs. F.....	1	0	0
Todd and Co. Messrs.....	1	0	0
Wallace, Richard.....	5	0	0
Total.....	£19	17	0

Co. Londonderry.

LONDONDERRY AND GREENCASTLE BRANCH.

President—
JOHN COOKE, Esq.

Honorary Secretary—
Rev. T. MCCLELLAN.

Annual Subscriptions.

Allen, Captain, R.N.....	5	0	0
Andrews, Mr. W.....	5	0	0
Bigger, Mr.....	5	0	0
Black & Co. Messrs. A.....	10	0	0
Campbell, Mr. R.....	5	0	0
Colbourn, Mr. S.....	5	0	0
Cook & Co. Messrs. J. J.....	10	0	0
Cook, Mr. John.....	10	0	0
Crosbie, Mr.....	5	0	0
Derry, Lord Bishop of 1	0	0	0
Donegall, Lord.....	2	0	0
Ferris, Mr.....	5	0	0
Finlay, Mr.....	5	0	0
Gilleland, Mr. G.....	10	0	0
Gordon, Mr.....	5	0	0
Hustings, Mr. Ross.....	5	0	0
Irish Society, Hon.....	5	0	0
Irvine & Co. Messrs.....	5	0	0
Lecky, Mr. H.....	5	0	0
Londonderry Harbour Com. for 1878.....	10	0	0
Do. for 1879.....	10	0	0
McCandless, Mr. S.....	5	0	0
McCandless, Mr. Jas.....	5	0	0
McClellan, Rev. Thos.....	10	0	0
McCool, Mr.....	5	0	0
McCorkill, Mr. Jas.....	5	0	0
McGowan and Lane, Messrs.....	5	0	0
Miles & Co. Messrs.....	5	0	0
McNiell, Mr. Scotch I. Boat.....	1	0	0
Mulholland & Co. Messrs.....	10	0	0
Quick, Mr. Ch.....	5	0	0
Ritchie & Pinkerton, Messrs.....	5	0	0
Rodgers, Mr.....	5	0	0
Sawers, Mr. R. P.....	5	0	0
Scott, Rev. Canon.....	5	0	0
Steel and McCaskell, Messrs.....	10	0	0
Watson, Mr.....	5	0	0
Williams, Mr. J.....	5	0	0
Sums under 5s.....	2	7	6

£41 3 6

Cos. Louth and Meath.

DROGHEDA BRANCH.

Patron—
THE MARQUIS OF CONYNGHAM.
 Honorary Secretary at
 Baltray—
NICHOLAS HALLIGAN, Esq.
 Honorary Secretary for
 Mornington—
W. H. BRABAZON, Esq.
 Secretary and Collector—
Mr. J. McNAMARA.
 Annual Subscriptions.

£. s. d.	
The Harbour Board	5 0 0
Steam Packet Co.	5 0 0
Armstrong, Mrs.	1 0 0
Balfour, B. T., D.L., J.P.	1 0 0
Bank of Ireland	1 0 0
Belfast Banking Co.	1 0 0
Brodigan, F., Major 28th Regiment	1 0 0
Cairnes, T. P., J.P.	10 0
Casey, Alderman Patrick, J.P.	10 0
Chadwick, Messrs. J. and F.	10 0
Clinton, Robert	5 0
Coddington, H. B., J.P.	10 0
Conyngnam, Marquis (Patron)	1 0 0
Corbally, Hon. Mrs.	2 0 0
Cullen, Michael	5 0
Daly, Alderman Robert B., J.P.	10 0
Darnley, Earl of	2 0 0
Davis & Co. Messrs. A.	10 0
Dean, Joseph	10 0
Donagh, Francis, J.P.	1 0 0
Eccles, Rev. Mr., Rector, St. Peter's	5 0
Greene, John J. F.	5 0
Grendon & Co. Messrs. Thomas	10 0
Halligan, Nicholas	5 0
Hibernian Bank	10 0
Hughes, John	5 0
Jameson, James, J.P.	1 0 0
McDonough, Edward	5 0
Montgomery, Richard T., J.P.	10 0
Moore, John	5 0
Morton, Messrs. J. and R.	10 0
Provincial Bank	10 0
Saw Mills Company	10 0
Smith, R., J.P.	10 0
Smyth, Miss	5 0
Smyth, R., J.P.	10 0
Toker, Capt. Edw., s.s. <i>Norah Creina</i>	5 0
Wetherill and Co. Messrs.	10 0
Whitworth, Nicholas	10 0
Whitworth, William, M.P.	10 0
Wolsey, Jameson, & Co. Messrs.	10 0
Subscription box, Custom House	11 3
Do. South B. House	4 0
Total	£34 15 3

DUNDALK BRANCH

Chairman—
MICHAEL KELLY, Esq. J.P.
 Honorary Secretary—
J. F. FARRELL, Esq.
 Annual Subscription.

£. s. d.	
Brown, R. L. Esq.	1 0 0
Carolan, N. Esq.	1 0 0
Cornick, John Esq.	1 0 0
Murphy, James, Esq.	1 0 0
Patteson, Matthew, Esq.	1 0 0
Tipping, G. Garside, Esq.	1 0 0
Total	6 0 0

Donations.

Dundalk Harbour Commissioners	
£28	9 10
£34	9 10

DUNGARVAN BRANCH.

Patron—
HIS GRACE THE DUKE OF DEVONSHIRE, K.G.
 President—
LORD STUART DE DECIES.
 Treasurers—
NATIONAL BANK.
 Honorary Secretary—
MR. JAMES W. SHAW.
 Annual Subscriptions.

£. s. d.	
Ardagh, W. M.	5 0
Gibbons, Capt. Wm.	10 0
Harbour Commissioners, The	3 0 0
Hudson, R. G. Esq.	10 0
Humble, Sir J. Nugent, Bart.	2 0 0
Hunt, John, Esq.	10 0
McConey, Mrs.	5 0
McGwire, S. E. Esq.	1 0 0
Merry, Robert A. Esq.	5 0
Power, Sir R. Bart.	1 0 0
Ussher, R. J. Esq.	1 0 0
Waterford Ltd.	2 0 0
Sams under 6s.	3 13 0
Total	£15 18 0

£. s. d.	
Strangman, S. Esq.	1 0 0
Strangman, Miss C.M.	2 6
Tottenham, Mrs. W. D.	1 1 0
Ward Brothers	10 0
Wark, John, Esq.	10 0
Waterford Steam Ship Co.	5 0 0
Whit Brothers, Messrs.	1 0 0
White, Edwin, Esq.	5 0
White, George, Esq.	5 0
White, William Esq.	5 0
Wilson, John, Esq.	1 0 0
Total	53 14 6

Donations.

Collection Box at O. Viacava, Italian Consular Agent, Waterford	
1	3 0
Collection Box at Tramore Terminus	5 6
Collection Box at Jacob, Brothers	5 0
£55	8 0

Donations.

Dundalk Harbour Commissioners	
£28	9 10
£34	9 10

Co. Waterford.

ARDMORE BRANCH.

Chairman—
J. H. BAGGE, Esq. J.P.
 Honorary Secretary—
W. C. POOLE, Esq., M.D., J.P.
 Annual Subscriptions.

£. s. d.	
Bagge, John H. Esq. J.P.	1 0 0
Cotton, Captain	10 0
Cotton, C.P. Esq. C.E.	1 0 0
Cotton, Rev. H., D.D.	1 0 0
Cotton, R. W. Esq.	10 0
Cotton, Miss	10 0
Cotton, Miss E.	10 0
Donoughmore, Earl of	1 0 0
Foley, Thomas, Esq. J.P.	10 0
Foley, Edmund, Esq.	10 0
Foley, Richard, Esq.	10 0
Keane, Lieut.-Col. W. A.	10 0
Musgrave, Sir R. J. Bart.	2 0 0
McKenna, Sir J. N., M.P.	1 0 0
Paul, Sir Robert J., Bart.	1 0 0
Poole, Wm. C. Esq. J.P.	10 0
Rothwell, Rev. Thos. R.	10 0
Stuart, H. Villiers, Esq.	5 0 0
Ussher, Mrs.	1 0 0
Total	£19 0 0

TRAMORE BRANCH.

Chairman—
THE HON. D. FORTESCUE.
 Treasurer—
EDMUND POWER, Esq. J.P.
 Honorary Secretary—
EDWARD JACOB, Esq.
 Annual Subscriptions.

£. s. d.	
Ambrose, Charles	10 0
Ardagh, Robert, Esq.	10 0
Beresford, Lord Charles	2 0 0
Beasborough, Earl of	1 0 0
Budd, Alfred, Esq.	5 0
Budd, James, Esq.	10 0
Christy, Wakefield	2 0 0
Clibborn, Edwd. Esq.	10 0
Denny, Messrs. A. & E.	2 0 0
Denny, Charles, Esq.	10 0
Denny, Henry, Esq.	10 0
Donerail, Lord	3 0 0
Dormer, Thos. P. Esq.	10 0
Fisher, Joseph, Esq.	10 0
Fortescue, Earl	2 0 0
Fortescue, Hon. D.	2 0 0
Goff, Strangman D.	2 0 0
Goff, William D.	10 0
Graves, J. P. Esq.	10 0
Grubb, Miss Anne	1 0 0
Grubb, Misses L. & S.	1 0 0
Hanrahan, P. F. Esq.	5 0
Harbour Board of Waterford	10 0
Jacob, Edward	10 0
Jacob, Francis	10 0
Jacob, T.W. Esq. J.P.	10 0
Kavanagh, Lady Harriet	10 0
Kent, David, Esq.	5 0
Kerr, Capt. R.N.	10 0
Locke & Co. Robert	5 0
Norman, Rev. E.	1 0 0
O'Shea, Lady G.	1 0 0
Pet, Edward G. Esq.	10 0
Pim, Mrs.	5 0
Power, E. Esq. J.P.	10 0
Power, P.W. Esq. J.P.	1 0 0
Power, Rev. R. P.P.	10 0
Rogers, C. Esq.	10 0
Ryan, Lawrence, Esq.	10 0
Slattery, Messrs.	10 0

Co. Wexford.

CAHORE BRANCH.

Honorary Secretary—
Capt. RICHARD O'LEARY GEORGE.
 Assistant Hon. Secretary—
MR. JOHN SINNOTT.
 Annual Subscriptions.

£. s. d.	
Bates, Mr. James	10 0
Bolton, Wm. Esq.	1 0 0
Bryan, L. A. Esq.	2 0 0
Burkitt, T. H. Esq.	5 0
Chambers, Rev. J. W., D.D.	7 6
City of Dublin Steam- packet Company	1 1 0
Corcoran, John, Esq.	10 0
Courtown, Earl of	1 0 0
Donovan, Rich. Esq.	5 0
Doyne, C. M. Esq. (for 1876)	1 0 0
Eaton, Messrs. M. & S.	10 0
Foster, W. O. Esq.	1 0 0
Furlong, Rev. J. L., P.P.	1 0 0
George, Mrs. Mary, Sen.	10 0
George, Capt. R. D'O.	2 0 0
Godkin, Mr. J.	10 0
Graves, E. A. Esq.	1 0 0
Hogan, J. A. Esq.	10 0
Hughes, Sir F.	1 0 0
Little, S. Esq.	1 0 0
Murdock, Rev. T. C.	1 0 0
Murphy, J. Esq.	10 0
Murphy, G. Esq.	10 0
Murphy, Michael, Esq.	10 0
Murphy, Rev. P. C.C.	10 0
O'Brien, Rev. J., P.P.	10 0
O'Leary, W. H. Esq., M.D.	10 0
Ponnden, J. C. Esq.	7 6
Power, Sir Jas. Bart.	2 0 0
Richards, Mrs.	1 0 0
Roche, Mrs.	1 0 0
Scott, J. S. Esq.	1 0 0
Sinnot, Mr. John	10 0
Stanley, Rev. A.	15 0
Whitcroft, Jno. Esq.	1 0 0
Total	£28 11 0

BRANCHES—LIST OF ANNUAL SUBSCRIPTIONS AND DONATIONS. 155

CARNSORE BRANCH.

Chairman—
Hon. J. A. KEANE.
Honorary Secretary—
Rev. T. W. MANNING.
Annual Subscriptions.

£. s. d.	
Alexander, (Capt. R. E.)	1 1 0
A. C.	1 1 0
Alexander, Capt. G. (The Buffs)	1 0 0
Alexander, Misses ..	1 0 0
Alexander, Rev. J. . .	3 0 0
Blacker, Mrs. John R.	1 0 0
Garvey, late Capt. R.N.	1 0 0
Gilbert, John, Esq. . .	5 0 0
Going, Mrs.	5 0 0
Hatton, Mrs.	4 0 0
Keane, Hon. Major John A.	1 0 0
Keane, Hon. Mrs.	1 0 0
Lett, B. Esq.	1 0 0
Lett, Mrs.	1 0 0
Little, Miss.	10 0 0
Mahony, W. A. Esq. . .	10 0 0
Morgan-Deane, Hon. Mrs.	1 0 0
McKinnell, Jos. Esq. . .	5 0 0
Palmer, Mrs. Ricardo	1 0 0
Segrave, Mrs.	1 0 0
Steele, R. B. Esq. . . .	5 0 0
Total.	14 8 0

Donation.
Irvine, Tottenham
E. Esq. - 10 0

£14 18 0

COURTOWN BRANCH.

Patron—
Rt. Hon. Earl of COURTOWN.
Treasurer and Hon. Sec.—
JAMES S. SCOTT, Esq., J.P.
Annual Subscriptions.

Allen, John B. M.D.	1 0 0
Arthur, Rev. Canon.	1 0 0
Bates, Mr. James. . . .	5 0 0
Cooke, Mr. Wm.	5 0 0
Courtown, Earl of. . .	2 0 0
Courtown, Countess.	1 0 0
Cox, Lieut.-Col. C. Wolseley	1 0 0
Davis, Messrs. S. & A. G.	1 0 0
Doyle, Mr. John.	5 0 0
Doynes, C. M. Esq. . . .	1 0 0
Doynes, J. W. C. Esq.	1 0 0
Eckersall, Mrs.	1 0 0
Edwards, Thos. Esq. . .	1 0 0
Ellis, T. C. Esq. for 1878	10 0 0
Esmonde, Col. Sir John, Bt., Reps. of	1 0 0
Fitzsimons, Mrs. M. . .	5 0 0
Foster, W. O. Esq.	1 0 0
Furlong, Rev. John, C.C.	10 0 0
George, Capt. R. d'Oliver, for 1878 & 1879 . . .	2 0 0
Gibbon, J. G. Esq. LL.D.	1 0 0
Guisse, Major-General John C., V.C.	1 0 0
Hatton, Colonel.	1 0 0
Little, Simon, Esq. . . .	1 0 0
Montgomery, Mrs. A. Shirley.	1 0 0
Montesor, Henry S. Esq.	10 6 0
Mulligan, Mrs. Anne . .	5 0 0
Mulligan, Mr. Thos. . .	5 0 0
Nixon, Mrs.	10 0 0

£. s. d.	
Pelan, Mrs. Eliza . . .	5 0 0
Power, Sir John Talbot, Bt.	1 0 0
Ralph, Mrs.	5 0 0
Ram, Rev. Canon, for 1878	1 0 0
Richards, Arthur W. M. Esq.	1 0 0
Scott, Jas. S. Esq. . . .	1 0 0
Sinnott, Rev. Robert, P.P.	10 0 0
Stopford, Hon. & Ven. Archdeacon.	1 0 0
Stopford, Hon. E. S. . .	1 0 0
Ward, Mrs. Bernard . .	1 0 0
Ward, Capt. T. Le Hunte, R.N.	1 0 0
Weidon, G. Esq. M.D. . .	5 0 0
Sums under 5s.	1 11 6
Total.	34 7 0

Donations.
De Cerjat, Master
Rob., coll. by. . . . 1 10 0
Collecting Boxes . . . 2 5 8

£38 2 8

DUNCANNON AND WATERFORD HARBOUR BRANCH.

Chairman—
Sir ROBERT PAUL, Bart.
Honorary Secretary—
Capt. BARTLETT.

Annual Subscriptions.

Bartlett, S. D. Esq. . . .	1 1 0
Carew, Dowager Lady.	2 0 0
Chichester, Hon. Capt.	1 0 0
Denny, A. Esq.	1 0 0
Gough, S. D. Esq. . . .	1 0 0
Graves, Rev. James. . .	5 0 0
Leigh, F. Esq.	1 0 0
Little, S. Esq.	1 0 0
Templemore, Lord. . . .	3 3 0
Waterford, Marq. of	2 0 0
Waterford Harbour Commissioners. . . .	10 0 0
Waterford S. S. Co. . . .	5 0 0
White Brothers.	2 0 0
Total.	£30 9 0

WEXFORD AND ROSLARE BRANCH.

Chairman—
R. J. DEVEREUX, Esq.
Honorary Secretary—
WILLIAM COGHLAN, Esq.
Annual Subscriptions.

Armstrong, Mrs.	10 0 0
Armstrong, W. Esq. . . .	5 0 0
Bacon, John, Esq. . . .	1 1 0
Barrington, J. Esq. . . .	5 0 0
Barry & Co. John E. . .	1 0 0
Boxwell, Harvy, Esq., J.P.	1 0 0
Bristol Steam Naviga- tion Company. . . .	1 1 0
Brown, W. Esq.	1 0 0
Bruen, Henry, Esq. . . .	1 0 0
Carew, Right Hon. Lord, K.P.	1 0 0
Connell, Mrs.	1 0 0
Devereux, J. P. Esq. D.L.	1 0 0
Devereux, L. Esq. . . .	1 0 0
Devereux, R. Esq. . . .	1 0 0
Donoughmore, Earl of	1 0 0
Ennis, Michael, Esq. . .	5 0 0

£. s. d.	
Faris, David, Esq. . . .	5 0 0
Gafney, W. J. Esq. . . .	10 0 0
Goff, S. D. Esq., J.P. . .	2 0 0
Granard, Right Hon. the Earl, K.P.	1 0 0
Hatton, Colonel, D.L. . .	1 0 0
Hickey, W. R. Esq. . . .	1 0 0
Hutchinson, Thos., manager for <i>Maylor Annie, J. P. Taylor, British Queen, Sea- flower, &c.</i>	1 0 0
Lambert, P. Esq.	5 0 0
Leigh, Miss.	1 0 0
Leigh, Miss M. A. . . .	1 0 0
Little, S. Esq.	1 0 0
Morgan, Hon. Mrs. D. . .	1 0 0
Peacock, Chas. H. Esq., J.P.	1 0 0
Power, Sir John T. Bart, D.L.	1 0 0
Richards, Mrs.	1 0 0
Templemore, The Right Hon. Lord. . . .	2 2 0
Walker, Capt. D. L. . . .	1 0 0
Walker, Mrs.	1 0 0
Walker, Robt. D. Esq. . .	10 0 0
Wexford Harbour Commissioners. . . .	5 0 0
Contribution Box, Custom House.	2 0 5
Total.	£38 19 5

Co. Wicklow.

ARKLOW BRANCH.

Chairman—
The EARL OF CARMSFORTH.
Treasurer—
PETER J. BLAKE, Esq.
Honorary Secretary—
The EARL OF WICKLOW.
Assistant Hon. Sec.—
Dr. HALPIN.
Annual Subscriptions.

£. s. d.	
Bayly, Col. D. L., J.P. . .	1 0 0
Bryan, Rev. W. B. . . .	5 0 0
The Earl of Carysfort	10 0 0
Doull, Mrs.	5 0 0
Halpin, Dr.	5 0 0
Robinson, Hen. Esq. . . .	10 0 0
Symes, Mrs.	2 6 0
Total.	12 7 6

Collected from Out-Pensioners at the undermentioned Stations on behalf of this Life-boat.

Donations.

Birmingham, per Major Fresson. . . .	11 11 5
Chatham, per Capt. H. G. Rogers. . . .	4 11 5
Exeter District, per Lt.-Col. Brockman	5 0 0
Liverpool, per Major Birch.	5 3 0
Newcastle-on-Tyne, per Capt. Rogers. . . .	1 3 1
Plymouth, No. 1, per Lt.-Col. R. Law	1 16 4
Total Dons.	24 7 6
Total Subs.	12 7 6
£36 15 0	

GREYSTONES BRANCH.

President—
THE EARL OF MEATH.
Chairman—
WM. R. LA TOUCHE, Esq.
Honorary Secretary—
PATRICK REID, Esq.
Annual Subscriptions.

£. s. d.	
Corbet, William J. Esq. M.P.	1 0 0
Brabazon, Lord.	2 0 0
Doyle, Mr. John.	5 0 0
Furlong, Miss Geo. . . .	10 0 0
Hodson, Sir Geo. Bt. . .	1 0 0
La Touche, W.R. Esq. . .	3 0 0
Lunel, Misses.	1 0 0
Macfarlane, Colonel. . .	10 0 0
Maziere, Misses.	5 0 0
McClelland, R. Esq. M.D.	1 1 0
Meade, J. F. Esq. . . .	10 0 0
Meath, The Rt. Hon. the Earl of.	3 0 0
Newton, Misses.	1 0 0
Orpin, Wm. B. Esq. . . .	1 0 0
Pennick, Robt. Esq. . . .	5 0 0
Reid, Patrick, Esq. . . .	2 0 0
Scott, J. W. Esq. . . .	10 0 0
Streane, Ven. Arch- deacon H.	10 0 0
Tombe, G. E. Esq. . . .	1 0 0
Whitshed, Lady.	2 0 0
Sums under 5s.	5 0 0
Total.	22 11 0

Donation.
Collecting Box in
Life-boat House. . . . 1 8 0

£23 19 0

WICKLOW BRANCH.

Patrons—
The Right Hon. the EARL
FITZWILLIAM and W. P.
FITZWILLIAM DICK, Esq. M.P.
Chairman—
Lieut.-Col. J. S. TIGHE, J.P.
D.L.
Treasurer and Hon. Sec.—
S. E. PIM, Esq.
Annual Subscriptions.

Atkinson, Lieut.-Col. . .	1 0 0
Bank, Hibernian, Wicklow.	1 1 0
Bilbrough, B. P. Esq. . .	1 0 0
Casement, J. Esq. J.P. . .	1 1 0
Courtenay, W. Esq., J.P.	10 0 0
Darcy, Mr. Thomas. . . .	5 0 0
Dick, W. W. F. Esq. . . .	1 0 0
Doolittle, Capt. E.	5 0 0
Doolittle, Mr. A.	5 0 0
Drought, Rev. J. W. . . .	1 0 0
Drought, Captain R.R., J.P.	1 0 0
Dublin, Archbishop of.	1 0 0
Edwards and Sons, Messrs. John.	1 0 0
Ellis, R. F. Esq. J.P. . . .	1 0 0
Fitzwilliam, Earl. . . .	2 0 0
Gregg, Mr. W.	10 0 0
Grubb, Capt. A.	1 0 0
Harold, Rev. G.	5 0 0
McCaughy, Rev. G. . . .	5 0 0
Nolan, John, Esq. . . .	10 0 0
Pim, S. E. Esq.	10 0 0
Rooke, Rev. Henry. . . .	5 0 0
Sjunner, Mrs.	10 0 0

	£.	s.	d.
Tighe, Lt.-Col. J. S., J.P., D.L.	1	1	0
Tottenham, Lt.-Col. of Ballycurry	1	1	0
Truell, H. P. Esq.	1	0	0
M.B., J.P.	1	0	0
Watkins, Mrs.	5	0	0
Sums under 5s.	1	7	6
Total	£21	16	6

	£.	s.	d.
Trafford, Rev. W.	5	0	0
Tyson, Miss	10	0	0
Woodhouse, Mrs.	5	0	0
Sums under 5s.	4	7	9
Amount in Life-boat Boxes	18	10	0
Total	£20	11	1

	£.	s.	d.
Torrance and Co.	5	0	0
Messrs. G.	5	0	0
Whiteside, Mr. Hy.	5	0	0
Sums under 5s.	1	14	6
Total	£30	0	0

Donations.		
	£.	s. d.
Evening Readings Committee	1	13 0
Box at Albert Hotel	5	8
Box at Boat House	8	1
Box at Mitre Hotel	6	0
Small Sums in Boxes	10	2
Total Dons	3	2 11
Total Subs.	30	3 0
	£33	5 11

DOUGLAS BRANCH.

Patron—
His Excellency the LIEUT.-GOVERNOR.

President—
THE HIGH BAILIFF OF DOUGLAS.

Treasurer and Hon. Sec.—
THOMAS BAWDEN, Esq.

Annual Subscriptions.
His Excellency the

Lieut.-Governor	3	3	0
Archer, Mr. R.	5	0	0
Bawden, Mr. T.	5	0	0
Bell, R. T.	10	0	0
Bowman, Mrs.	5	0	0
Brown, Jas. and Son	5	0	0
Callow, Mr. T. C.	5	0	0
Clinch, Mr. J. W.	5	0	0
Coole, James	5	0	0
Corlett, Capt. T.	5	0	0
Cowle, Mr. Jas.	10	0	0
Cubbon, Mr. Joseph.	5	0	0
Cubbon, Mr. Thos.	5	0	0
Gelling, Mr. R.	5	0	0
Gill, Capt.	10	0	0
Great Laxey Mining Co.	2	2	0
Greensill, Mr. T. S.	5	0	0
Hales, Mr. James	5	0	0
Hall, Mrs. C.	5	0	0
Hall, Rev. Mr.	5	0	0
Harris, Mr. S., High Bailiff	1	0	0
Harrison, Ridgway	5	0	0
Karran, Mr. J. J.	10	0	0
Kermode and Kellett	10	0	0
Killey, Mr. Philip	10	0	0
Lomas, Mr. Sam.	10	0	0
Moore, W. F. and Son	1	0	0
Okell, Dr.	5	0	0
Quine, Mr. Thos.	10	6	0
Sherwood, G. and Co.	5	0	0
Sodor and Man, Lord Bishop of	1	0	0
Sparrow, Mr. J.	1	0	0
Steam Packet Co.	5	0	0
Todhunter & Elliot, Messrs.	5	0	0

RAMSEY BRANCH.

President—
His Excellency the LIEUT.-GOVERNOR.

Chairman—
J. C. LA MOTHE, Esq., High Bailiff of Ramsey.

Honorary Secretary—
REV. GEORGE PATON.

Annual Subscriptions.
His Excellency the

Lieut.-Governor	2	2	0
Allen, T.	5	0	0
Brown, Mr. R.	5	0	0
Brown, Mr. W.	10	0	0
Christian, Rev. W. B.	2	0	0
Cleator, Mr. R.	5	0	0
Cleucas, Dr.	5	0	0
Corkill, Mr. T.	5	0	0
Crennell, Mr. W.	5	0	0
Cromar, Capt.	5	0	0
Dumbell, Deemster	2	2	0
His Honour the	2	2	0
Farrant, Mr. E. C.	1	0	0
Fletcher, Mrs.	5	0	0
Gibb, Mrs.	1	0	0
Gilmour, Mrs.	5	0	0
Ile of Man Steam Packet Company	2	2	0
Kelly, Mr. R. J.	5	0	0
Kermode, Rev. W.	10	0	0
Kerruish, E. P.	5	0	0
Lamothe, Mr. J. C.	5	0	0
Lucas, Mr. K.	1	1	0
McWhannell, Mr.	5	0	0
Moore, Archdeacon	1	1	0
Paterson, A. C. Mr.	5	0	0
Paton, Rev. George	1	0	0
Roose, Mr. W. D.	5	0	0
Rudd, Mr.	5	0	0
Scott, Mrs., Edinburgh	1	1	0
Stephen, Deemster	5	0	0
His Honour (the late)	5	0	0
Taubman, Mr. E. M.	5	0	0
Teare and Co.	5	0	0
Thellusson, Colonel	1	0	0
Thellusson, Mr. E.	1	0	0
Wood, Dr.	5	0	0
Sums under 5s.	2	19	0
Total	30	3 0	

Total Dons 3 2 11
Total Subs. 30 3 0
£33 5 11

CHANNEL ISLANDS.

ALDERNEY BRANCH.

President—
T. N. BARBENSON, Esq., Judge of Alderney.

Honorary Secretary—
NICOLAS BARBENSON, Esq.

Donations.		
	£.	s. d.
Barbenson, T. N. Esq.	10	0
Barbenson, N. Esq.	5	0
Cottle, Mr. F. J.	5	0
Le Mesurier, Rev. John	1	0
Rosa, Rev. Wm.	5	0
Total	£2	5 0

GUERNSEY BRANCH.

Chairman—
Capt. P. DE SAUMAREZ, R.N.

Honorary Secretary—
Capt. CARRÉ, R.N.

Annual Subscriptions.		
	£.	s. d.
States of Guernsey	25	0 0
Lockett, Mrs. and Misses, in addition to gift of Life-boat	5	0 0
Total	£30	0 0

Ile of Man.

CASTLETOWN BRANCH.

Chairman—
J. M. JEFFCOTT, Esq., High Bailiff.

Honorary Secretary—
GEORGE H. QUAYLE, Esq.

Annual Subscriptions.

	£.	s.	d.
The Lieut.-Governor	2	0	0
Blyth, Mrs.	5	0	0
Cary, Lieut.-Colonel.	10	0	0
Chapple, F. Esq.	10	0	0
Clague, Mrs.	5	0	0
Crellin, R. Q. Esq.	10	0	0
Cudd, W. H. Esq.	10	0	0
Drinkwater, Sir W. L. Deemster	1	0	0
Ferrier, Mrs.	5	0	0
Gawne, Mrs.	1	0	0
Geneste, Captain	5	0	0
Gill, Mrs.	5	0	0
Gill, Sir James, Attorney-General	10	0	0
Hawkins, Major	5	0	0
Ile of Man Steam- packet Company	2	2	0
Jones, Rev. J., D.C.L.	5	0	0
Moore, Thos. Esq.	5	0	0
Moore, W. F. Esq.	10	0	0
Quayle, Capt.	7	6	0
Quayle, Geo. P. Esq.	5	0	0
Quayle, Mrs.	10	0	0
Riach, Mrs.	10	0	0
Taggart, Mr. John	5	0	0
The Archdeacon Moore	10	0	0
The Clerk of the Rolls	10	0	0
The High Bailiff	5	0	0